

# ArtPro+ 21.11

## User Guide

11 - 2021

# Contents

- 1. Introduction..... 9**
  - 1.1. Copyright Notice..... 9
    - 1.1.1. Third party license information.....10
  - 1.2. Installation.....25
  - 1.3. Licensing..... 25
    - 1.3.1. The ArtPro+ License Info panel..... 28
  - 1.4. What's New in ArtPro+ 21.11.....29
  - 1.5. The About palette.....33
  - 1.6. Getting help..... 33
  - 1.7. Languages..... 34
  - 1.8. Dashboard..... 34
- 2. Getting Started..... 35**
  - 2.1. The ArtPro+ Workspace..... 35
    - 2.1.1. Using the Side Drawer..... 36
    - 2.1.2. Using the Side Panel..... 37
    - 2.1.3. The Inspector..... 37
    - 2.1.4. Changing tools..... 38
    - 2.1.5. Shortcuts overview..... 39
    - 2.1.6. Modifier keys..... 43
  - 2.2. Preferences..... 44
  - 2.3. Quitting ArtPro+.....51
- 3. Working with files.....52**
  - 3.1. PDF, PDF+ and Normalized PDF.....52
    - 3.1.1. Convert to PDF+.....54
  - 3.2. New File.....55
  - 3.3. Open Files.....55
    - 3.3.1. Missing and out-of-date files.....56
  - 3.4. Open Recent..... 57
  - 3.5. Close Files.....57
  - 3.6. Save Files.....57
  - 3.7. Export..... 58
    - 3.7.1. Export to PDF..... 58
    - 3.7.2. Export Gravure TIFF..... 60
    - 3.7.3. Export to JDF Layout..... 61
  - 3.8. Automation Engine connection..... 61
    - 3.8.1. Working with an on-premises Automation Engine server.....62
    - 3.8.2. Working with an Automation Engine SaaS server.....64
  - 3.9. Report Template..... 66

3.9.1. Working with a Report Template.....	67
3.9.2. Editing a Report Template.....	68
3.10. Insert Content from PDF.....	70
3.11. Document Setup.....	71
3.12. Print.....	71
<b>4. Changing the View.....</b>	<b>72</b>
4.1. Multiple Document Windows.....	72
4.1.1. Arrange document windows.....	72
4.1.2. Synchronize Views.....	72
4.2. Changing the Zoom factor.....	72
4.2.1. Fit in Window.....	73
4.2.2. Actual Size.....	73
4.2.3. Zoom to Selection.....	73
4.2.4. Zoom In / Zoom Out.....	74
4.2.5. Zoom tool.....	74
4.3. Pan tool.....	74
4.4. The Crosshair.....	75
4.4.1. Move or rotate the Crosshair.....	75
4.4.2. Cut on Crosshair.....	76
4.5. Rotate View.....	76
4.6. Preview or Outline mode.....	76
4.7. Hiding objects.....	77
4.8. Color Management.....	77
<b>5. Checking and Measuring.....</b>	<b>79</b>
5.1. Quality Control.....	79
5.1.1. Total Area Coverage.....	79
5.1.2. Breakout.....	79
5.1.3. Flexo Print Preview.....	80
5.1.4. Moiré Detection.....	81
5.1.5. Object Screening.....	82
5.1.6. Registration Error.....	83
5.1.7. Compare.....	83
5.2. Dimensions.....	86
5.3. Densities.....	87
5.4. The Colors Side Drawer.....	88
5.5. Ink Coverage.....	89
<b>6. Document Settings.....</b>	<b>91</b>
6.1. Working with multi-page documents.....	91
6.1.1. Navigating a multi-page document.....	91
6.2. Page Boxes.....	92
6.2.1. Editing Page Boxes.....	92
6.3. Layers.....	94

- 6.3.1. Visibility, Locking and Printing state..... 95
- 6.3.2. Processing Step Layers..... 97
- 6.3.3. Processing Step Layers Overview mode..... 99
- 6.4. Object Browser..... 99
- 6.5. Separations..... 101
  - 6.5.1. Adding or changing a separation..... 103
  - 6.5.2. Separations Setup..... 104
  - 6.5.3. Convert to CMYK..... 106
  - 6.5.4. Convert to Spot Color..... 107
  - 6.5.5. Automatic Locking based on the visible separations..... 108
- 7. Selecting..... 110**
  - 7.1. Group Select..... 110
  - 7.2. Object Select..... 111
  - 7.3. Path Select..... 112
  - 7.4. Selecting in Preview or in Outline Mode..... 113
  - 7.5. Lasso Select..... 113
  - 7.6. Selection Breadcrumbs..... 114
  - 7.7. Select Same..... 115
  - 7.8. Select Advanced..... 116
  - 7.9. Select Next Object / Select Previous Object..... 117
- 8. Editing..... 118**
  - 8.1. Undo and Redo..... 118
  - 8.2. Cut, Copy and Paste..... 118
  - 8.3. Handling Objects..... 119
    - 8.3.1. Renaming objects, groups and layers..... 119
    - 8.3.2. Delete..... 120
    - 8.3.3. Hiding objects..... 120
    - 8.3.4. Locking objects..... 120
    - 8.3.5. Arrange objects..... 120
    - 8.3.6. Group objects..... 121
    - 8.3.7. Compound..... 121
    - 8.3.8. Placeholder objects..... 122
  - 8.4. Editing objects..... 122
    - 8.4.1. Transforming objects..... 122
    - 8.4.2. Clipping Mask..... 130
    - 8.4.3. Opacity Masks..... 131
    - 8.4.4. Creating and editing paths..... 132
    - 8.4.5. Spread / Choke..... 137
    - 8.4.6. Protected objects..... 138
    - 8.4.7. Rasterize ..... 139
    - 8.4.8. Clean..... 140
  - 8.5. Changing the Fill and Stroke..... 143

8.5.1. Fill Color and Stroke Color Inspector.....	143
8.5.2. Stroke Inspector.....	148
8.5.3. Transparency Inspector.....	149
8.5.4. Recolor.....	150
8.6. Creating objects.....	154
8.6.1. Create Rectangle / Create Ellipse.....	154
8.6.2. Shaper.....	155
8.7. Working with Text.....	156
8.7.1. Text Inspector.....	156
8.7.2. Text Box Transformation Inspector.....	158
8.7.3. Using the Text Tool.....	158
8.7.4. Extensis Universal Type Client.....	160
8.7.5. Contourize Text.....	160
8.7.6. Convert Outlines to Text.....	161
8.7.7. Create Text in Path.....	162
8.7.8. Create Text on Path.....	163
8.8. Working with images.....	164
8.8.1. Place.....	164
8.8.2. Place Image Inside.....	165
8.8.3. Linked and Embedded images.....	165
8.8.4. Image Inspector.....	166
8.8.5. The Channel Mapping Inspector.....	167
8.8.6. Opening images in an external editor.....	169
8.8.7. Replacing an image.....	170
8.8.8. Images Side Drawer.....	170
8.8.9. Trace Image.....	171
8.9. Working with Placed Art.....	173
8.9.1. Place.....	173
8.9.2. Linked versus Embedded Placed Art.....	175
8.9.3. Placed Art Separations Inspector.....	176
8.9.4. Placed Art Inspector.....	176
8.9.5. Layer Types Inspector.....	178
8.9.6. Edit Placed Art.....	178
8.9.7. Replace Placed Art.....	179
8.9.8. Placed Art Side Drawer.....	179
8.10. Working with Structural Design files.....	180
8.10.1. Place Structural Design.....	180
8.10.2. Structural Design File Inspector.....	181
8.10.3. Structural Design Inspector.....	181
<b>9. Prepress functions.....</b>	<b>183</b>
9.1. Barcodes.....	183
9.1.1. Create a barcode.....	184
9.1.2. Edit a barcode.....	184

9.1.3. The Barcode types.....	185
9.1.4. Multicolor barcodes.....	232
9.1.5. Barcode properties from Automation Engine Job Setup.....	233
9.1.6. Convert to Barcode.....	234
9.2. Add Dimensions.....	236
9.3. Add Bleed.....	239
9.4. White Underprint.....	240
9.5. Rich Black.....	241
9.6. Ink Eater Areas.....	242
9.6.1. Create Ink Eater Areas.....	242
9.6.2. Fill Ink Eater Areas.....	243
9.7. Screening.....	245
9.7.1. Setting up Screen Sets in the Screening window.....	245
9.7.2. Applying a Screen Set to an object.....	246
9.7.3. Screening when merging separations.....	247
9.8. Trapping.....	248
9.8.1. Trapping mode: Trapping.....	248
9.8.2. Trapping mode: Reverse Trapping.....	257
9.8.3. Working with Trap Tags.....	259
9.9. Warp.....	261
9.9.1. Create Conical Grid.....	262
9.9.2. Shrink Sleeve Warp.....	264
9.10. Preflight.....	264
9.10.1. Running a Preflight.....	264
9.10.2. Manage Preflight Profiles.....	265
9.10.3. The Preflight Profile Editor.....	267
9.11. Step & Repeat.....	268
9.11.1. Grid Step & Repeat.....	268
9.11.2. Step & Repeat based on an MFG or CF2 file.....	278
9.12. Fix Thin Parts.....	284
9.13. Flexo Tools.....	285
9.13.1. Create Plate Cutting Paths.....	285
9.13.2. Plate ID Objects.....	287
<b>10. Marks.....</b>	<b>291</b>
10.1. Create a Mark from Selection.....	292
10.2. Create a Standard Mark.....	293
10.3. Mark Types and their properties.....	293
10.3.1. Custom Mark.....	293
10.3.2. Point Text Mark and Area Text Mark.....	294
10.3.3. Repeat for Separations Mark.....	299
10.3.4. Repeat by Count Mark.....	304
10.3.5. Repeat for Grid Mark.....	306
10.3.6. Repeat for Placeholder Mark.....	307

10.3.7. Cut Mark.....	308
10.3.8. Bearer Bar Mark.....	308
10.3.9. Clip Mark.....	309
10.3.10. Barcode Mark.....	312
10.3.11. Dimensions Mark.....	312
10.3.12. External File Mark.....	313
10.3.13. Position Mark.....	313
10.3.14. Resize Mark.....	314
10.3.15. Repeat for Stations Mark.....	315
10.4. Colors and Separations in a Mark.....	317
10.5. Mark positioning.....	318
10.6. Formula Editor.....	319
10.7. Working with Mark Sets.....	321
10.8. Editing a Mark.....	322
10.9. Nested Marks.....	323
10.10. Updating Marks.....	324
10.11. Error Messaging for Marks.....	324
<b>11. Action Lists.....</b>	<b>326</b>
11.1. The Action List Side Drawer.....	326
11.2. Stepping through an Action List.....	326
11.3. Run With Options.....	327
11.4. Managing Action Lists.....	328
11.5. The Action List editor.....	330
11.5.1. Actions.....	331
11.5.2. Action Lists and Selections.....	340
11.5.3. Parameters in Action Lists.....	341
<b>12. Studio in ArtPro+.....</b>	<b>343</b>
12.1. 3D View.....	343
12.2. Creating a revolved shape with labels.....	344
12.2.1. Create a profile path.....	344
12.2.2. Revolve in Toolkit.....	345
12.3. Predistortion.....	346
12.4. Export 3D.....	348
<b>13. Variable Data.....</b>	<b>350</b>
13.1. Convert to Variable Data Template.....	350
13.2. The Variable Data Side Drawer.....	351
13.3. The Variable Data database.....	352
13.4. Creating and editing Variable Data Objects.....	353
13.4.1. Positioning a Variable Data Object.....	354
13.4.2. Using the Variable Data Objects Inspector.....	355
13.4.3. Using variable color in Fill or Stroke Inspector.....	360
13.5. Checking your Variable Data Template.....	360

13.5.1. Common errors in Variable Data.....	361
13.5.2. Checking the Database Records and Fields.....	362
13.5.3. The Checks Inspector.....	363
13.6. Export Variable Data.....	365
13.6.1. Expand to Grid Step & Repeat.....	366
13.6.2. Expand to MFG or CF2 Step & Repeat.....	367



# 1. Introduction

---

## 1.1. Copyright Notice

---

© Copyright 2021 Esko Software BV, Gent, Belgium

All rights reserved. This material, information and instructions for use contained herein are the property of Esko Software BV. The material, information and instructions are provided on an AS IS basis without warranty of any kind. There are no warranties granted or extended by this document. Furthermore Esko Software BV does not warrant, guarantee or make any representations regarding the use, or the results of the use of the software or the information contained herein. Esko Software BV shall not be liable for any direct, indirect, consequential or incidental damages arising out of the use or inability to use the software or the information contained herein.

The information contained herein is subject to change without notice. Revisions may be issued from time to time to advise of such changes and/or additions.

No part of this document may be reproduced, stored in a data base or retrieval system, or published, in any form or in any way, electronically, mechanically, by print, photoprint, microfilm or any other means without prior written permission from Esko Software BV.

This document supersedes all previous dated versions.

PANTONE® Colors displayed in the software application or in the user documentation may not match PANTONE-identified standards. Consult current PANTONE Color Publications for accurate color. PANTONE® and other Pantone trademarks are the property of Pantone LLC. © Pantone LLC, 2015

Pantone is the copyright owner of color data and/or software which are licensed to Esko to distribute for use only in combination with Studio Visualizer. PANTONE Color Data and/or Software shall not be copied onto another disk or into memory unless as part of the execution of Studio Visualizer.

This software is based in part on the work of the Independent JPEG Group.

Portions of this software are copyright © 1996-2002 The FreeType Project ([www.freetype.org](http://www.freetype.org)). All rights reserved.

Portions of this software are copyright 2006 Feeling Software, copyright 2005-2006 Autodesk Media Entertainment.

Portions of this software are copyright ©1998-2003 Daniel Veillard. All rights reserved.

Portions of this software are copyright ©1999-2006 The Botan Project. All rights reserved.

Part of the software embedded in this product is gSOAP software. Portions created by gSOAP are Copyright ©2001-2004 Robert A. van Engelen, Genivia inc. All rights reserved.

Portions of this software are copyright ©1998-2008 The OpenSSL Project and ©1995-1998 Eric Young ([eay@cryptsoft.com](mailto:eay@cryptsoft.com)). All rights reserved.

This product includes software developed by the Apache Software Foundation (<http://www.apache.org/>).

Adobe, the Adobe logo, Acrobat, the Acrobat logo, Adobe Creative Suite, Illustrator, InDesign, PDF, Photoshop, PostScript, XMP and the Powered by XMP logo are either registered trademarks or trademarks of Adobe Systems Incorporated in the United States and/or other countries.

Microsoft and the Microsoft logo are registered trademarks of Microsoft Corporation in the United States and other countries.

SolidWorks is a registered trademark of SolidWorks Corporation.

Portions of this software are owned by Spatial Corp. 1986 2003. All Rights Reserved.

JDF and the JDF logo are trademarks of the CIP4 Organisation. Copyright 2001 The International Cooperation for the Integration of Processes in Prepress, Press and Postpress (CIP4). All rights reserved.

The Esko software contains the RSA Data Security, Inc. MD5 Message-Digest Algorithm.

Java and all Java-based trademarks and logos are trademarks or registered trademarks of Sun Microsystems in the U.S. and other countries.

Part of this software uses technology by Best Color Technology (EFI). EFI and Bestcolor are registered trademarks of Electronics For Imaging GmbH in the U.S. Patent and Trademark Office.

Contains PowerNest library Copyrighted and Licensed by Alma, 2005 - 2007.

Part of this software uses technology by GlobalVision. ArtProof and ScanProof are registered trademarks of GlobalVision Inc.

Part of this software uses technology by Qoppa Software. Copyright © 2002-Present. All Rights Reserved.

All other product names are trademarks or registered trademarks of their respective owners.

Correspondence regarding this publication should be forwarded to:

Esko Software BV  
 Kortrijksesteenweg 1095  
 B - 9051 Gent  
 info.eur@esko.com

### 1.1.1. Third party license information

This product includes lzw-ab.

Copyright (c) David Bryant  
 All rights reserved.

Redistribution and use in source and binary forms, with or without modification, are permitted provided that the following conditions are met:

- \* Redistributions of source code must retain the above copyright notice, this list of conditions and the following disclaimer.
- \* Redistributions in binary form must reproduce the above copyright notice, this list of conditions and the following disclaimer in the documentation and/or other materials provided with the distribution.
- \* Neither the name of Conifer Software nor the names of its contributors may be used to endorse or promote products derived from this software without specific prior written permission.

THIS SOFTWARE IS PROVIDED BY THE COPYRIGHT HOLDERS AND CONTRIBUTORS "AS IS" AND ANY EXPRESS OR IMPLIED WARRANTIES, INCLUDING, BUT NOT LIMITED TO, THE IMPLIED WARRANTIES OF MERCHANTABILITY AND FITNESS FOR A PARTICULAR PURPOSE ARE DISCLAIMED. IN NO EVENT SHALL THE REGENTS OR CONTRIBUTORS BE LIABLE FOR ANY DIRECT, INDIRECT, INCIDENTAL, SPECIAL, EXEMPLARY, OR CONSEQUENTIAL DAMAGES (INCLUDING, BUT NOT LIMITED TO, PROCUREMENT OF SUBSTITUTE GOODS OR SERVICES; LOSS OF USE, DATA, OR PROFITS; OR BUSINESS INTERRUPTION) HOWEVER CAUSED AND ON ANY THEORY OF LIABILITY, WHETHER IN CONTRACT, STRICT LIABILITY,

OR TORT (INCLUDING NEGLIGENCE OR OTHERWISE) ARISING IN ANY WAY OUT OF THE USE OF THIS SOFTWARE, EVEN IF ADVISED OF THE POSSIBILITY OF SUCH DAMAGE.

-----

This product includes Bonjour SDK.

Copyright (c) 2003-2004, Apple Computer, Inc. All rights reserved.

Redistribution and use in source and binary forms, with or without modification, are permitted provided that the following conditions are met:

1. Redistributions of source code must retain the above copyright notice, this list of conditions and the following disclaimer.
2. Redistributions in binary form must reproduce the above copyright notice, this list of conditions and the following disclaimer in the documentation and/or other materials provided with the distribution.
3. Neither the name of Apple Computer, Inc. ("Apple") nor the names of its contributors may be used to endorse or promote products derived from this software without specific prior written permission.

THIS SOFTWARE IS PROVIDED BY APPLE AND ITS CONTRIBUTORS "AS IS" AND ANY EXPRESS OR IMPLIED WARRANTIES, INCLUDING, BUT NOT LIMITED TO, THE IMPLIED WARRANTIES OF MERCHANTABILITY AND FITNESS FOR A PARTICULAR PURPOSE ARE DISCLAIMED. IN NO EVENT SHALL APPLE OR ITS CONTRIBUTORS BE LIABLE FOR ANY DIRECT, INDIRECT, INCIDENTAL, SPECIAL, EXEMPLARY, OR CONSEQUENTIAL DAMAGES (INCLUDING, BUT NOT LIMITED TO, PROCUREMENT OF SUBSTITUTE GOODS OR SERVICES; LOSS OF USE, DATA, OR PROFITS; OR BUSINESS INTERRUPTION) HOWEVER CAUSED AND ON ANY THEORY OF LIABILITY, WHETHER IN CONTRACT, STRICT LIABILITY, OR TORT (INCLUDING NEGLIGENCE OR OTHERWISE) ARISING IN ANY WAY OUT OF THE USE OF THIS SOFTWARE, EVEN IF ADVISED OF THE POSSIBILITY OF SUCH DAMAGE.

-----

This product includes cereal.

Copyright (c) 2014, Randolph Voorhies, Shane Grant  
All rights reserved.

Redistribution and use in source and binary forms, with or without modification, are permitted provided that the following conditions are met:

- \* Redistributions of source code must retain the above copyright notice, this list of conditions and the following disclaimer.
- \* Redistributions in binary form must reproduce the above copyright notice, this list of conditions and the following disclaimer in the documentation and/or other materials provided with the distribution.
- \* Neither the name of cereal nor the names of its contributors may be used to endorse or promote products derived from this software without specific prior written permission.

THIS SOFTWARE IS PROVIDED BY THE COPYRIGHT HOLDERS AND CONTRIBUTORS "AS IS" AND ANY EXPRESS OR IMPLIED WARRANTIES, INCLUDING, BUT NOT LIMITED TO, THE IMPLIED WARRANTIES OF MERCHANTABILITY AND FITNESS FOR A PARTICULAR PURPOSE ARE DISCLAIMED. IN NO EVENT SHALL RANDOLPH VOORHIES OR SHANE GRANT BE LIABLE FOR ANY DIRECT, INDIRECT, INCIDENTAL, SPECIAL, EXEMPLARY, OR CONSEQUENTIAL DAMAGES (INCLUDING, BUT NOT LIMITED TO, PROCUREMENT OF SUBSTITUTE GOODS OR SERVICES; LOSS OF USE, DATA, OR PROFITS; OR BUSINESS INTERRUPTION) HOWEVER CAUSED AND ON ANY THEORY OF LIABILITY, WHETHER IN CONTRACT, STRICT LIABILITY, OR TORT (INCLUDING NEGLIGENCE OR OTHERWISE) ARISING IN ANY WAY OUT OF THE USE OF THIS SOFTWARE, EVEN IF ADVISED OF THE POSSIBILITY OF SUCH DAMAGE.

-----

This product includes ICC Profiles.

Some ICC Profiles were created by FFEI Ltd. ([www.ffei.co.uk](http://www.ffei.co.uk)) using Fujifilm ColourKit Profiler Suite ([www.colourprofiling.com](http://www.colourprofiling.com))

-----

This product includes ICC Profiles.

Some ICC profiles are copyright (C) by European Color Initiative, [www.eci.org](http://www.eci.org)

-----

This product includes ICC Profiles.

Some ICC profiles are copyright (C) of WAN-IFRA, www.wan-ifra.org

-----

This product includes ICC Profiles.

Some ICC profiles are copyright (C) IDEAlliance(R). G7(R), GRACol(R) and SWOP(R) are all registered trademarks of IDEAlliance(C).

-----

This product includes PANTONE Color Libraries.

PANTONE® and other Pantone trademarks are the property of Pantone LLC. Pantone is a wholly owned subsidiary of X-Rite, Incorporated.

-----

This product includes LibTIFF.

Copyright (c) 1988-1997 Sam Leffler  
 Copyright (c) 1991-1997 Silicon Graphics, Inc.

Permission to use, copy, modify, distribute, and sell this software and its documentation for any purpose is hereby granted without fee, provided that (i) the above copyright notices and this permission notice appear in all copies of the software and related documentation, and (ii) the names of Sam Leffler and Silicon Graphics may not be used in any advertising or publicity relating to the software without the specific, prior written permission of Sam Leffler and Silicon Graphics.

THE SOFTWARE IS PROVIDED "AS-IS" AND WITHOUT WARRANTY OF ANY KIND, EXPRESS, IMPLIED OR OTHERWISE, INCLUDING WITHOUT LIMITATION, ANY WARRANTY OF MERCHANTABILITY OR FITNESS FOR A PARTICULAR PURPOSE.

IN NO EVENT SHALL SAM LEFFLER OR SILICON GRAPHICS BE LIABLE FOR ANY SPECIAL, INCIDENTAL, INDIRECT OR CONSEQUENTIAL DAMAGES OF ANY KIND, OR ANY DAMAGES WHATSOEVER RESULTING FROM LOSS OF USE, DATA OR PROFITS, WHETHER OR NOT ADVISED OF THE POSSIBILITY OF DAMAGE, AND ON ANY THEORY OF LIABILITY, ARISING OUT OF OR IN CONNECTION WITH THE USE OR PERFORMANCE OF THIS SOFTWARE.

-----

This product includes FCollada.

Copyright 2006 Feeling Software. All rights reserved.

Copyright 2005-2006 Feeling Software and  
 Copyright 2005-2006 Autodesk Media Entertainment.

Copyright (C) 1998-2003 Daniel Veillard. All Rights Reserved.

Permission is hereby granted, free of charge, to any person obtaining a copy of this software and associated documentation files (the "Software"), to deal in the Software without restriction, including without limitation the rights to use, copy, modify, merge, publish, distribute, sublicense, and/or sell copies of the Software, and to permit persons to whom the Software is furnished to do so, subject to the following conditions:

The above copyright notice and this permission notice shall be included in all copies or substantial portions of the Software.

THE SOFTWARE IS PROVIDED "AS IS", WITHOUT WARRANTY OF ANY KIND, EXPRESS OR IMPLIED, INCLUDING BUT NOT LIMITED TO THE WARRANTIES OF MERCHANTABILITY, FITNESS FOR A PARTICULAR PURPOSE AND NONINFRINGEMENT. IN NO EVENT SHALL THE AUTHORS OR COPYRIGHT HOLDERS BE LIABLE FOR ANY CLAIM, DAMAGES OR OTHER LIABILITY, WHETHER IN AN ACTION OF CONTRACT, TORT OR OTHERWISE, ARISING FROM, OUT OF OR IN CONNECTION WITH THE SOFTWARE OR THE USE OR OTHER DEALINGS IN THE SOFTWARE.

-----

This product includes FreeType.

Portions of this software are copyright (C) 2014 The FreeType

Project (www.freetype.org) licensed under the Freetype License.  
All rights reserved.

-----  
This product includes GLEW: The OpenGL Extension Wrangler Library.

The OpenGL Extension Wrangler Library  
Copyright (C) 2002-2007, Milan Ikits <milan ikits[]ieee org>  
Copyright (C) 2002-2007, Marcelo E. Magallon <mmagallo[]debian org>  
Copyright (C) 2002, Lev Povalahev  
All rights reserved.

Redistribution and use in source and binary forms, with or without  
modification, are permitted provided that the following conditions are met:

- \* Redistributions of source code must retain the above copyright notice,  
this list of conditions and the following disclaimer.
- \* Redistributions in binary form must reproduce the above copyright notice,  
this list of conditions and the following disclaimer in the documentation  
and/or other materials provided with the distribution.
- \* The name of the author may be used to endorse or promote products  
derived from this software without specific prior written permission.

THIS SOFTWARE IS PROVIDED BY THE COPYRIGHT HOLDERS AND CONTRIBUTORS "AS IS"  
AND ANY EXPRESS OR IMPLIED WARRANTIES, INCLUDING, BUT NOT LIMITED TO, THE  
IMPLIED WARRANTIES OF MERCHANTABILITY AND FITNESS FOR A PARTICULAR PURPOSE  
ARE DISCLAIMED. IN NO EVENT SHALL THE COPYRIGHT OWNER OR CONTRIBUTORS BE  
LIABLE FOR ANY DIRECT, INDIRECT, INCIDENTAL, SPECIAL, EXEMPLARY, OR  
CONSEQUENTIAL DAMAGES (INCLUDING, BUT NOT LIMITED TO, PROCUREMENT OF  
SUBSTITUTE GOODS OR SERVICES; LOSS OF USE, DATA, OR PROFITS; OR BUSINESS  
INTERRUPTION) HOWEVER CAUSED AND ON ANY THEORY OF LIABILITY, WHETHER IN  
CONTRACT, STRICT LIABILITY, OR TORT (INCLUDING NEGLIGENCE OR OTHERWISE)  
ARISING IN ANY WAY OUT OF THE USE OF THIS SOFTWARE, EVEN IF ADVISED OF  
THE POSSIBILITY OF SUCH DAMAGE.

Mesa 3-D graphics library  
Version: 7.0

Copyright (C) 1999-2007 Brian Paul All Rights Reserved.

Permission is hereby granted, free of charge, to any person obtaining a  
copy of this software and associated documentation files (the "Software"),  
to deal in the Software without restriction, including without limitation  
the rights to use, copy, modify, merge, publish, distribute, sublicense,  
and/or sell copies of the Software, and to permit persons to whom the  
Software is furnished to do so, subject to the following conditions:

The above copyright notice and this permission notice shall be included  
in all copies or substantial portions of the Software.

THE SOFTWARE IS PROVIDED "AS IS", WITHOUT WARRANTY OF ANY KIND, EXPRESS  
OR IMPLIED, INCLUDING BUT NOT LIMITED TO THE WARRANTIES OF MERCHANTABILITY,  
FITNESS FOR A PARTICULAR PURPOSE AND NONINFRINGEMENT. IN NO EVENT SHALL  
BRIAN PAUL BE LIABLE FOR ANY CLAIM, DAMAGES OR OTHER LIABILITY, WHETHER IN  
AN ACTION OF CONTRACT, TORT OR OTHERWISE, ARISING FROM, OUT OF OR IN  
CONNECTION WITH THE SOFTWARE OR THE USE OR OTHER DEALINGS IN THE SOFTWARE.

Copyright (c) 2007 The Khronos Group Inc.

Permission is hereby granted, free of charge, to any person obtaining a  
copy of this software and/or associated documentation files (the  
"Materials"), to deal in the Materials without restriction, including  
without limitation the rights to use, copy, modify, merge, publish,  
distribute, sublicense, and/or sell copies of the Materials, and to  
permit persons to whom the Materials are furnished to do so, subject to  
the following conditions:

The above copyright notice and this permission notice shall be included  
in all copies or substantial portions of the Materials.

THE MATERIALS ARE PROVIDED "AS IS", WITHOUT WARRANTY OF ANY KIND,  
EXPRESS OR IMPLIED, INCLUDING BUT NOT LIMITED TO THE WARRANTIES OF  
MERCHANTABILITY, FITNESS FOR A PARTICULAR PURPOSE AND NONINFRINGEMENT.  
IN NO EVENT SHALL THE AUTHORS OR COPYRIGHT HOLDERS BE LIABLE FOR ANY

CLAIM, DAMAGES OR OTHER LIABILITY, WHETHER IN AN ACTION OF CONTRACT, TORT OR OTHERWISE, ARISING FROM, OUT OF OR IN CONNECTION WITH THE MATERIALS OR THE USE OR OTHER DEALINGS IN THE MATERIALS.

-----

This product includes ICU.

Copyright (c) 1995-2014 International Business Machines Corporation and others  
All rights reserved.

Permission is hereby granted, free of charge, to any person obtaining a copy of this software and associated documentation files (the "Software"), to deal in the Software without restriction, including without limitation the rights to use, copy, modify, merge, publish, distribute, and/or sell copies of the Software, and to permit persons to whom the Software is furnished to do so, provided that the above copyright notice(s) and this permission notice appear in all copies of the Software and that both the above copyright notice(s) and this permission notice appear in supporting documentation.

THE SOFTWARE IS PROVIDED "AS IS", WITHOUT WARRANTY OF ANY KIND, EXPRESS OR IMPLIED, INCLUDING BUT NOT LIMITED TO THE WARRANTIES OF MERCHANTABILITY, FITNESS FOR A PARTICULAR PURPOSE AND NONINFRINGEMENT OF THIRD PARTY RIGHTS. IN NO EVENT SHALL THE COPYRIGHT HOLDER OR HOLDERS INCLUDED IN THIS NOTICE BE LIABLE FOR ANY CLAIM, OR ANY SPECIAL INDIRECT OR CONSEQUENTIAL DAMAGES, OR ANY DAMAGES WHATSOEVER RESULTING FROM LOSS OF USE, DATA OR PROFITS, WHETHER IN AN ACTION OF CONTRACT, NEGLIGENCE OR OTHER TORTIOUS ACTION, ARISING OUT OF OR IN CONNECTION WITH THE USE OR PERFORMANCE OF THIS SOFTWARE.

-----

This product includes iODBC.

Copyright (C) 1995-2006, OpenLink Software Inc and Ke Jin.  
All rights reserved.

Redistribution and use in source and binary forms, with or without modification, are permitted provided that the following conditions are met:

1. Redistributions of source code must retain the above copyright notice, this list of conditions and the following disclaimer.
2. Redistributions in binary form must reproduce the above copyright notice, this list of conditions and the following disclaimer in the documentation and/or other materials provided with the distribution.
3. Neither the name of OpenLink Software Inc. nor the names of its contributors may be used to endorse or promote products derived from this software without specific prior written permission.

THIS SOFTWARE IS PROVIDED BY THE COPYRIGHT HOLDERS AND CONTRIBUTORS "AS IS" AND ANY EXPRESS OR IMPLIED WARRANTIES, INCLUDING, BUT NOT LIMITED TO, THE IMPLIED WARRANTIES OF MERCHANTABILITY AND FITNESS FOR A PARTICULAR PURPOSE ARE DISCLAIMED. IN NO EVENT SHALL OPENLINK OR CONTRIBUTORS BE LIABLE FOR ANY DIRECT, INDIRECT, INCIDENTAL, SPECIAL, EXEMPLARY, OR CONSEQUENTIAL DAMAGES (INCLUDING, BUT NOT LIMITED TO, PROCUREMENT OF SUBSTITUTE GOODS OR SERVICES; LOSS OF USE, DATA, OR PROFITS; OR BUSINESS INTERRUPTION) HOWEVER CAUSED AND ON ANY THEORY OF LIABILITY, WHETHER IN CONTRACT, STRICT LIABILITY, OR TORT (INCLUDING NEGLIGENCE OR OTHERWISE) ARISING IN ANY WAY OUT OF THE USE OF THIS SOFTWARE, EVEN IF ADVISED OF THE POSSIBILITY OF SUCH DAMAGE.

-----

This product includes JBIG2Lib.

Portions of this product copyrights (C) 2002 Glyph & Cog, LLC.

-----

This product includes JPEGLib.

This software is copyright (C) 1991-2016, Thomas G. Lane, Guido Vollbeding.  
All Rights Reserved.

This software is based in part on the work of the Independent JPEG Group.

-----

This product includes JSONspirit.

Copyright (c) 2007 - 2010 John W. Wilkinson

Permission is hereby granted, free of charge, to any person obtaining a copy of this software and associated documentation files (the "Software"), to deal in the Software without restriction, including without limitation the rights to use, copy, modify, merge, publish, distribute, sublicense, and/or sell copies of the Software, and to permit persons to whom the Software is furnished to do so, subject to the following conditions:

The above copyright notice and this permission notice shall be included in all copies or substantial portions of the Software.

THE SOFTWARE IS PROVIDED "AS IS", WITHOUT WARRANTY OF ANY KIND, EXPRESS OR IMPLIED, INCLUDING BUT NOT LIMITED TO THE WARRANTIES OF MERCHANTABILITY, FITNESS FOR A PARTICULAR PURPOSE AND NONINFRINGEMENT. IN NO EVENT SHALL THE AUTHORS OR COPYRIGHT HOLDERS BE LIABLE FOR ANY CLAIM, DAMAGES OR OTHER LIABILITY, WHETHER IN AN ACTION OF CONTRACT, TORT OR OTHERWISE, ARISING FROM, OUT OF OR IN CONNECTION WITH THE SOFTWARE OR THE USE OR OTHER DEALINGS IN THE SOFTWARE.

-----  
 This product includes Little CMS.

Little CMS  
 Copyright (c) 1998-2011 Marti Maria Saguer

Permission is hereby granted, free of charge, to any person obtaining a copy of this software and associated documentation files (the "Software"), to deal in the Software without restriction, including without limitation the rights to use, copy, modify, merge, publish, distribute, sublicense, and/or sell copies of the Software, and to permit persons to whom the Software is furnished to do so, subject to the following conditions:

The above copyright notice and this permission notice shall be included in all copies or substantial portions of the Software.

THE SOFTWARE IS PROVIDED "AS IS", WITHOUT WARRANTY OF ANY KIND, EXPRESS OR IMPLIED, INCLUDING BUT NOT LIMITED TO THE WARRANTIES OF MERCHANTABILITY, FITNESS FOR A PARTICULAR PURPOSE AND NONINFRINGEMENT. IN NO EVENT SHALL THE AUTHORS OR COPYRIGHT HOLDERS BE LIABLE FOR ANY CLAIM, DAMAGES OR OTHER LIABILITY, WHETHER IN AN ACTION OF CONTRACT, TORT OR OTHERWISE, ARISING FROM, OUT OF OR IN CONNECTION WITH THE SOFTWARE OR THE USE OR OTHER DEALINGS IN THE SOFTWARE.

-----  
 This product includes leptonica.

- Copyright (C) 2001-2016 Leptonica. All rights reserved.
- 
- Redistribution and use in source and binary forms, with or without modification, are permitted provided that the following conditions are met:
- 1. Redistributions of source code must retain the above copyright notice, this list of conditions and the following disclaimer.
- 2. Redistributions in binary form must reproduce the above copyright notice, this list of conditions and the following disclaimer in the documentation and/or other materials provided with the distribution.
- 
- THIS SOFTWARE IS PROVIDED BY THE COPYRIGHT HOLDERS AND CONTRIBUTORS ``AS IS'' AND ANY EXPRESS OR IMPLIED WARRANTIES, INCLUDING, BUT NOT LIMITED TO, THE IMPLIED WARRANTIES OF MERCHANTABILITY AND FITNESS FOR A PARTICULAR PURPOSE ARE DISCLAIMED. IN NO EVENT SHALL ANY CONTRIBUTORS BE LIABLE FOR ANY DIRECT, INDIRECT, INCIDENTAL, SPECIAL, EXEMPLARY, OR CONSEQUENTIAL DAMAGES (INCLUDING, BUT NOT LIMITED TO, PROCUREMENT OF SUBSTITUTE GOODS OR SERVICES; LOSS OF USE, DATA, OR PROFITS; OR BUSINESS INTERRUPTION) HOWEVER CAUSED AND ON ANY THEORY OF LIABILITY, WHETHER IN CONTRACT, STRICT LIABILITY, OR TORT (INCLUDING NEGLIGENCE OR OTHERWISE) ARISING IN ANY WAY OUT OF THE USE OF THIS SOFTWARE, EVEN IF ADVISED OF THE POSSIBILITY OF SUCH DAMAGE.

-----  
 This product includes libpng.

Copyright (c) 2000-2002 Glenn Randers-Pehrson

The PNG Reference Library is supplied "AS IS". The Contributing Authors and Group 42, Inc. disclaim all warranties, expressed or implied, including, without limitation, the warranties of merchantability and of fitness for any purpose. The Contributing Authors and Group 42, Inc. assume no liability for direct, indirect, incidental, special, exemplary, or consequential damages, which may result from the use of the PNG Reference Library, even if advised of the possibility of such damage. There is no warranty against interference with your enjoyment of the library or against infringement. There is no warranty that our efforts or the library will fulfill any of your particular purposes or needs. This library is provided with all faults, and the entire risk of satisfactory quality, performance, accuracy, and effort is with the user.

-----  
 This product includes libxml2.

Copyright (C) 1998-2012 Daniel Veillard. All Rights Reserved.

Permission is hereby granted, free of charge, to any person obtaining a copy of this software and associated documentation files (the "Software"), to deal in the Software without restriction, including without limitation the rights to use, copy, modify, merge, publish, distribute, sublicense, and/or sell copies of the Software, and to permit persons to whom the Software is furnished to do so, subject to the following conditions:

The above copyright notice and this permission notice shall be included in all copies or substantial portions of the Software.

THE SOFTWARE IS PROVIDED "AS IS", WITHOUT WARRANTY OF ANY KIND, EXPRESS OR IMPLIED, INCLUDING BUT NOT LIMITED TO THE WARRANTIES OF MERCHANTABILITY, FITNESS FOR A PARTICULAR PURPOSE AND NONINFRINGEMENT. IN NO EVENT SHALL THE AUTHORS OR COPYRIGHT HOLDERS BE LIABLE FOR ANY CLAIM, DAMAGES OR OTHER LIABILITY, WHETHER IN AN ACTION OF CONTRACT, TORT OR OTHERWISE, ARISING FROM, OUT OF OR IN CONNECTION WITH THE SOFTWARE OR THE USE OR OTHER DEALINGS IN THE SOFTWARE.

-----  
 This product includes Open Source Computer Vision Library.

By downloading, copying, installing or using the software you agree to this license. If you do not agree to this license, do not download, install, copy or use the software.

License Agreement  
 For Open Source Computer Vision Library  
 (3-clause BSD License)

Copyright (C) 2000-2018, Intel Corporation, all rights reserved.  
 Copyright (C) 2009-2011, Willow Garage Inc., all rights reserved.  
 Copyright (C) 2009-2016, NVIDIA Corporation, all rights reserved.  
 Copyright (C) 2010-2013, Advanced Micro Devices, Inc., all rights reserved.  
 Copyright (C) 2015-2016, OpenCV Foundation, all rights reserved.  
 Copyright (C) 2015-2016, Itseez Inc., all rights reserved.  
 Third party copyrights are property of their respective owners.

Redistribution and use in source and binary forms, with or without modification, are permitted provided that the following conditions are met:

- \* Redistributions of source code must retain the above copyright notice, this list of conditions and the following disclaimer.
- \* Redistributions in binary form must reproduce the above copyright notice, this list of conditions and the following disclaimer in the documentation and/or other materials provided with the distribution.
- \* Neither the names of the copyright holders nor the names of the contributors may be used to endorse or promote products derived from this software



without specific prior written permission.

This software is provided by the copyright holders and contributors "as is" and any express or implied warranties, including, but not limited to, the implied warranties of merchantability and fitness for a particular purpose are disclaimed. In no event shall copyright holders or contributors be liable for any direct, indirect, incidental, special, exemplary, or consequential damages (including, but not limited to, procurement of substitute goods or services; loss of use, data, or profits; or business interruption) however caused and on any theory of liability, whether in contract, strict liability, or tort (including negligence or otherwise) arising in any way out of the use of this software, even if advised of the possibility of such damage.

-----

This product includes openexr.

Copyright Contributors to the OpenEXR Project. All rights reserved.

Redistribution and use in source and binary forms, with or without modification, are permitted provided that the following conditions are met:

- \* Redistributions of source code must retain the above copyright notice, this list of conditions and the following disclaimer.
- \* Redistributions in binary form must reproduce the above copyright notice, this list of conditions and the following disclaimer in the documentation and/or other materials provided with the distribution.
- \* Neither the name of the copyright holder nor the names of its contributors may be used to endorse or promote products derived from this software without specific prior written permission.

THIS SOFTWARE IS PROVIDED BY THE COPYRIGHT HOLDERS AND CONTRIBUTORS "AS IS" AND ANY EXPRESS OR IMPLIED WARRANTIES, INCLUDING, BUT NOT LIMITED TO, THE IMPLIED WARRANTIES OF MERCHANTABILITY AND FITNESS FOR A PARTICULAR PURPOSE ARE DISCLAIMED. IN NO EVENT SHALL THE COPYRIGHT HOLDER OR CONTRIBUTORS BE LIABLE FOR ANY DIRECT, INDIRECT, INCIDENTAL, SPECIAL, EXEMPLARY, OR CONSEQUENTIAL DAMAGES (INCLUDING, BUT NOT LIMITED TO, PROCUREMENT OF SUBSTITUTE GOODS OR SERVICES; LOSS OF USE, DATA, OR PROFITS; OR BUSINESS INTERRUPTION) HOWEVER CAUSED AND ON ANY THEORY OF LIABILITY, WHETHER IN CONTRACT, STRICT LIABILITY, OR TORT (INCLUDING NEGLIGENCE OR OTHERWISE) ARISING IN ANY WAY OUT OF THE USE OF THIS SOFTWARE, EVEN IF ADVISED OF THE POSSIBILITY OF SUCH DAMAGE.

-----

This product includes OpenImageIO.

BSD 3-Clause License

Copyright (c) 2008-present by Contributors to the OpenImageIO project. All Rights Reserved.

Redistribution and use in source and binary forms, with or without modification, are permitted provided that the following conditions are met:

- Redistributions of source code must retain the above copyright notice, this list of conditions and the following disclaimer.
- Redistributions in binary form must reproduce the above copyright notice, this list of conditions and the following disclaimer in the documentation and/or other materials provided with the distribution.
- Neither the name of the copyright holder nor the names of its contributors may be used to endorse or promote products derived from this software without specific prior written permission.

THIS SOFTWARE IS PROVIDED BY THE COPYRIGHT HOLDERS AND CONTRIBUTORS "AS IS" AND ANY EXPRESS OR IMPLIED WARRANTIES, INCLUDING, BUT NOT LIMITED TO, THE IMPLIED WARRANTIES OF MERCHANTABILITY AND FITNESS FOR A PARTICULAR PURPOSE ARE DISCLAIMED. IN NO EVENT SHALL THE COPYRIGHT HOLDER OR CONTRIBUTORS BE LIABLE FOR ANY DIRECT, INDIRECT, INCIDENTAL, SPECIAL, EXEMPLARY, OR CONSEQUENTIAL DAMAGES (INCLUDING, BUT NOT LIMITED TO, PROCUREMENT OF SUBSTITUTE GOODS OR SERVICES; LOSS OF USE, DATA, OR PROFITS; OR BUSINESS INTERRUPTION) HOWEVER CAUSED AND ON ANY THEORY OF LIABILITY, WHETHER IN CONTRACT, STRICT LIABILITY, OR TORT (INCLUDING NEGLIGENCE OR OTHERWISE) ARISING IN ANY WAY OUT OF THE USE OF THIS SOFTWARE, EVEN IF ADVISED OF THE POSSIBILITY OF SUCH DAMAGE.

-----  
 This product includes OpenJPEG.

The copyright in this software is being made available under the 2-clauses BSD License, included below. This software may be subject to other third party and contributor rights, including patent rights, and no such rights are granted under this license.

Copyright (c) 2002-2014, Universite catholique de Louvain (UCL), Belgium  
 Copyright (c) 2002-2014, Professor Benoit Macq  
 Copyright (c) 2003-2014, Antonin Descampe  
 Copyright (c) 2003-2009, Francois-Olivier Devaux  
 Copyright (c) 2005, Herve Drolon, FreeImage Team  
 Copyright (c) 2002-2003, Yannick Verschuere  
 Copyright (c) 2001-2003, David Janssens  
 Copyright (c) 2011-2012, Centre National d'Etudes Spatiales (CNES), France  
 Copyright (c) 2012, CS Systemes d'Information, France

All rights reserved.

Redistribution and use in source and binary forms, with or without modification, are permitted provided that the following conditions are met:

1. Redistributions of source code must retain the above copyright notice, this list of conditions and the following disclaimer.
2. Redistributions in binary form must reproduce the above copyright notice, this list of conditions and the following disclaimer in the documentation and/or other materials provided with the distribution.

THIS SOFTWARE IS PROVIDED BY THE COPYRIGHT HOLDERS AND CONTRIBUTORS `AS IS' AND ANY EXPRESS OR IMPLIED WARRANTIES, INCLUDING, BUT NOT LIMITED TO, THE IMPLIED WARRANTIES OF MERCHANTABILITY AND FITNESS FOR A PARTICULAR PURPOSE ARE DISCLAIMED. IN NO EVENT SHALL THE COPYRIGHT OWNER OR CONTRIBUTORS BE LIABLE FOR ANY DIRECT, INDIRECT, INCIDENTAL, SPECIAL, EXEMPLARY, OR CONSEQUENTIAL DAMAGES (INCLUDING, BUT NOT LIMITED TO, PROCUREMENT OF SUBSTITUTE GOODS OR SERVICES; LOSS OF USE, DATA, OR PROFITS; OR BUSINESS INTERRUPTION) HOWEVER CAUSED AND ON ANY THEORY OF LIABILITY, WHETHER IN CONTRACT, STRICT LIABILITY, OR TORT (INCLUDING NEGLIGENCE OR OTHERWISE) ARISING IN ANY WAY OUT OF THE USE OF THIS SOFTWARE, EVEN IF ADVISED OF THE POSSIBILITY OF SUCH DAMAGE.

-----  
 This product includes OpenSSL.

Copyright (c) 1998-2017 The OpenSSL Project. All rights reserved.

Redistribution and use in source and binary forms, with or without modification, are permitted provided that the following conditions are met:

1. Redistributions of source code must retain the above copyright notice, this list of conditions and the following disclaimer.
2. Redistributions in binary form must reproduce the above copyright notice, this list of conditions and the following disclaimer in the documentation and/or other materials provided with the distribution.
3. All advertising materials mentioning features or use of this software must display the following acknowledgment:  
 "This product includes software developed by the OpenSSL Project for use in the OpenSSL Toolkit. (<http://www.openssl.org/>)"
4. The names "OpenSSL Toolkit" and "OpenSSL Project" must not be used to endorse or promote products derived from this software without prior written permission. For written permission, please contact [openssl-core@openssl.org](mailto:openssl-core@openssl.org).
5. Products derived from this software may not be called "OpenSSL" nor may "OpenSSL" appear in their names without prior written permission of the OpenSSL Project.
6. Redistributions of any form whatsoever must retain the following acknowledgment:  
 "This product includes software developed by the OpenSSL Project

for use in the OpenSSL Toolkit (<http://www.openssl.org/>)"

THIS SOFTWARE IS PROVIDED BY THE OpenSSL PROJECT ``AS IS'' AND ANY EXPRESSED OR IMPLIED WARRANTIES, INCLUDING, BUT NOT LIMITED TO, THE IMPLIED WARRANTIES OF MERCHANTABILITY AND FITNESS FOR A PARTICULAR PURPOSE ARE DISCLAIMED. IN NO EVENT SHALL THE OpenSSL PROJECT OR ITS CONTRIBUTORS BE LIABLE FOR ANY DIRECT, INDIRECT, INCIDENTAL, SPECIAL, EXEMPLARY, OR CONSEQUENTIAL DAMAGES (INCLUDING, BUT NOT LIMITED TO, PROCUREMENT OF SUBSTITUTE GOODS OR SERVICES; LOSS OF USE, DATA, OR PROFITS; OR BUSINESS INTERRUPTION) HOWEVER CAUSED AND ON ANY THEORY OF LIABILITY, WHETHER IN CONTRACT, STRICT LIABILITY, OR TORT (INCLUDING NEGLIGENCE OR OTHERWISE) ARISING IN ANY WAY OUT OF THE USE OF THIS SOFTWARE, EVEN IF ADVISED OF THE POSSIBILITY OF SUCH DAMAGE.

-----  
 This product includes OpenSSL.

Copyright (C) 1995-1998 Eric Young (eay@cryptsoft.com)  
 All rights reserved.

Redistribution and use in source and binary forms, with or without modification, are permitted provided that the following conditions are met:

1. Redistributions of source code must retain the copyright notice, this list of conditions and the following disclaimer.
2. Redistributions in binary form must reproduce the above copyright notice, this list of conditions and the following disclaimer in the documentation and/or other materials provided with the distribution.
3. All advertising materials mentioning features or use of this software must display the following acknowledgement:  
 "This product includes cryptographic software written by Eric Young (eay@cryptsoft.com)"  
 The word 'cryptographic' can be left out if the routines from the library being used are not cryptographic related :-).
4. If you include any Windows specific code (or a derivative thereof) from the apps directory (application code) you must include an acknowledgement:  
 "This product includes software written by Tim Hudson (tjh@cryptsoft.com)"

THIS SOFTWARE IS PROVIDED BY ERIC YOUNG ``AS IS'' AND ANY EXPRESS OR IMPLIED WARRANTIES, INCLUDING, BUT NOT LIMITED TO, THE IMPLIED WARRANTIES OF MERCHANTABILITY AND FITNESS FOR A PARTICULAR PURPOSE ARE DISCLAIMED. IN NO EVENT SHALL THE AUTHOR OR CONTRIBUTORS BE LIABLE FOR ANY DIRECT, INDIRECT, INCIDENTAL, SPECIAL, EXEMPLARY, OR CONSEQUENTIAL DAMAGES (INCLUDING, BUT NOT LIMITED TO, PROCUREMENT OF SUBSTITUTE GOODS OR SERVICES; LOSS OF USE, DATA, OR PROFITS; OR BUSINESS INTERRUPTION) HOWEVER CAUSED AND ON ANY THEORY OF LIABILITY, WHETHER IN CONTRACT, STRICT LIABILITY, OR TORT (INCLUDING NEGLIGENCE OR OTHERWISE) ARISING IN ANY WAY OUT OF THE USE OF THIS SOFTWARE, EVEN IF ADVISED OF THE POSSIBILITY OF SUCH DAMAGE.

-----  
 This product includes PCRE.

Copyright (c) 1997-2016 University of Cambridge  
 All rights reserved.

Copyright(c) 2010-2016 Zoltan Herczeg  
 All rights reserved.

Copyright(c) 2009-2016 Zoltan Herczeg  
 All rights reserved.

Redistribution and use in source and binary forms, with or without modification, are permitted provided that the following conditions are met:

- \* Redistributions of source code must retain the above copyright notice, this list of conditions and the following disclaimer.
- \* Redistributions in binary form must reproduce the above copyright notice, this list of conditions and the following disclaimer in the documentation and/or other materials provided with the distribution.
- \* Neither the name of the University of Cambridge nor the names of any contributors may be used to endorse or promote products derived from this

software without specific prior written permission.

THIS SOFTWARE IS PROVIDED BY THE COPYRIGHT HOLDERS AND CONTRIBUTORS "AS IS" AND ANY EXPRESS OR IMPLIED WARRANTIES, INCLUDING, BUT NOT LIMITED TO, THE IMPLIED WARRANTIES OF MERCHANTABILITY AND FITNESS FOR A PARTICULAR PURPOSE ARE DISCLAIMED. IN NO EVENT SHALL THE COPYRIGHT OWNER OR CONTRIBUTORS BE LIABLE FOR ANY DIRECT, INDIRECT, INCIDENTAL, SPECIAL, EXEMPLARY, OR CONSEQUENTIAL DAMAGES (INCLUDING, BUT NOT LIMITED TO, PROCUREMENT OF SUBSTITUTE GOODS OR SERVICES; LOSS OF USE, DATA, OR PROFITS; OR BUSINESS INTERRUPTION) HOWEVER CAUSED AND ON ANY THEORY OF LIABILITY, WHETHER IN CONTRACT, STRICT LIABILITY, OR TORT (INCLUDING NEGLIGENCE OR OTHERWISE) ARISING IN ANY WAY OUT OF THE USE OF THIS SOFTWARE, EVEN IF ADVISED OF THE POSSIBILITY OF SUCH DAMAGE.

-----

This product includes patented technology.

This product and use of this product is under license from Markzware under U.S. Patent No. 5,963,641.

-----

This product includes pugixml.

MIT License

Copyright (c) 2006-2019 Arseny Kapoulkine

Permission is hereby granted, free of charge, to any person obtaining a copy of this software and associated documentation files (the "Software"), to deal in the Software without restriction, including without limitation the rights to use, copy, modify, merge, publish, distribute, sublicense, and/or sell copies of the Software, and to permit persons to whom the Software is furnished to do so, subject to the following conditions:

The above copyright notice and this permission notice shall be included in all copies or substantial portions of the Software.

THE SOFTWARE IS PROVIDED "AS IS", WITHOUT WARRANTY OF ANY KIND, EXPRESS OR IMPLIED, INCLUDING BUT NOT LIMITED TO THE WARRANTIES OF MERCHANTABILITY, FITNESS FOR A PARTICULAR PURPOSE AND NONINFRINGEMENT. IN NO EVENT SHALL THE AUTHORS OR COPYRIGHT HOLDERS BE LIABLE FOR ANY CLAIM, DAMAGES OR OTHER LIABILITY, WHETHER IN AN ACTION OF CONTRACT, TORT OR OTHERWISE, ARISING FROM, OUT OF OR IN CONNECTION WITH THE SOFTWARE OR THE USE OR OTHER DEALINGS IN THE SOFTWARE.

-----

This product includes Qt.

The software uses Qt, licensed under LGPL v3. The Qt Toolkit is Copyright (C) 2019 The Qt Company Ltd.

Portions of this software are copyright (C) 2006-2015 The FreeType Project ([www.freetype.org](http://www.freetype.org)). All rights reserved.

Copyright (C) 1991-2011, Thomas G. Lane, Guido Vollbeding.  
This software is based in part on the work of the Independent JPEG Group.

Secure Hash Algorithm SHA-3 - brg\_endian  
Copyright (c) 1998-2013, Brian Gladman, Worcester, UK. All rights reserved.

LICENSE TERMS

The redistribution and use of this software (with or without changes) is allowed without the payment of fees or royalties provided that:

1. source code distributions include the above copyright notice, this list of conditions and the following disclaimer;
2. binary distributions include the above copyright notice, this list of conditions and the following disclaimer in their documentation;

3. the name of the copyright holder is not used to endorse products built using this software without specific written permission.

DISCLAIMER

This software is provided 'as is' with no explicit or implied warranties in respect of its properties, including, but not limited to, correctness and/or fitness for purpose.

-----  
 This product includes QtCopyDialog.

Copyright (c) 2009 Nokia Corporation and/or its subsidiary(-ies).  
 All rights reserved.

BECAUSE THE LIBRARY IS LICENSED FREE OF CHARGE, THERE IS NO WARRANTY FOR THE LIBRARY, TO THE EXTENT PERMITTED BY APPLICABLE LAW. EXCEPT WHEN OTHERWISE STATED IN WRITING THE COPYRIGHT HOLDERS AND/OR OTHER PARTIES PROVIDE THE LIBRARY "AS IS" WITHOUT WARRANTY OF ANY KIND, EITHER EXPRESSED OR IMPLIED, INCLUDING, BUT NOT LIMITED TO, THE IMPLIED WARRANTIES OF MERCHANTABILITY AND FITNESS FOR A PARTICULAR PURPOSE. THE ENTIRE RISK AS TO THE QUALITY AND PERFORMANCE OF THE LIBRARY IS WITH YOU. SHOULD THE LIBRARY PROVE DEFECTIVE, YOU ASSUME THE COST OF ALL NECESSARY SERVICING, REPAIR OR CORRECTION.

-----  
 This product includes QtMigration.

Copyright (C) 2013 Digia Plc and/or its subsidiary(-ies).

Redistribution and use in source and binary forms, with or without modification, are permitted provided that the following conditions are met:

- \* Redistributions of source code must retain the above copyright notice, this list of conditions and the following disclaimer.
- \* Redistributions in binary form must reproduce the above copyright notice, this list of conditions and the following disclaimer in the documentation and/or other materials provided with the distribution.
- \* Neither the name of Digia Plc and its Subsidiary(-ies) nor the names of its contributors may be used to endorse or promote products derived from this software without specific prior written permission.

THIS SOFTWARE IS PROVIDED BY THE COPYRIGHT HOLDERS AND CONTRIBUTORS "AS IS" AND ANY EXPRESS OR IMPLIED WARRANTIES, INCLUDING, BUT NOT LIMITED TO, THE IMPLIED WARRANTIES OF MERCHANTABILITY AND FITNESS FOR A PARTICULAR PURPOSE ARE DISCLAIMED. IN NO EVENT SHALL THE COPYRIGHT OWNER OR CONTRIBUTORS BE LIABLE FOR ANY DIRECT, INDIRECT, INCIDENTAL, SPECIAL, EXEMPLARY, OR CONSEQUENTIAL DAMAGES (INCLUDING, BUT NOT LIMITED TO, PROCUREMENT OF SUBSTITUTE GOODS OR SERVICES; LOSS OF USE, DATA, OR PROFITS; OR BUSINESS INTERRUPTION) HOWEVER CAUSED AND ON ANY THEORY OF LIABILITY, WHETHER IN CONTRACT, STRICT LIABILITY, OR TORT (INCLUDING NEGLIGENCE OR OTHERWISE) ARISING IN ANY WAY OUT OF THE USE OF THIS SOFTWARE, EVEN IF ADVISED OF THE POSSIBILITY OF SUCH DAMAGE."

-----  
 This product includes QtService.

Copyright (C) 2010 Nokia Corporation and/or its subsidiary(-ies).

Redistribution and use in source and binary forms, with or without modification, are permitted provided that the following conditions are met:

- \* Redistributions of source code must retain the above copyright notice, this list of conditions and the following disclaimer.
- \* Redistributions in binary form must reproduce the above copyright notice, this list of conditions and the following disclaimer in the documentation and/or other materials provided with the distribution.
- \* Neither the name of Nokia Corporation and its Subsidiary(-ies) nor the names of its contributors may be used to endorse or promote products derived from this software without specific prior written permission.

THIS SOFTWARE IS PROVIDED BY THE COPYRIGHT HOLDERS AND CONTRIBUTORS "AS IS" AND ANY EXPRESS OR IMPLIED WARRANTIES, INCLUDING, BUT NOT LIMITED TO, THE IMPLIED WARRANTIES OF MERCHANTABILITY AND FITNESS FOR A PARTICULAR PURPOSE ARE DISCLAIMED. IN NO EVENT SHALL THE COPYRIGHT OWNER OR CONTRIBUTORS BE LIABLE FOR ANY DIRECT, INDIRECT, INCIDENTAL, SPECIAL, EXEMPLARY, OR CONSEQUENTIAL DAMAGES (INCLUDING, BUT NOT LIMITED TO, PROCUREMENT OF SUBSTITUTE GOODS OR SERVICES; LOSS OF USE, DATA, OR PROFITS; OR BUSINESS INTERRUPTION) HOWEVER CAUSED AND ON ANY THEORY OF LIABILITY, WHETHER IN CONTRACT, STRICT LIABILITY, OR TORT (INCLUDING NEGLIGENCE OR OTHERWISE) ARISING IN ANY WAY OUT OF THE USE OF THIS SOFTWARE, EVEN IF ADVISED OF THE POSSIBILITY OF SUCH DAMAGE.

-----  
 This product includes QtSingleApplication.

Copyright (C) 2010 Nokia Corporation and/or its subsidiary(-ies). All rights reserved.

Redistribution and use in source and binary forms, with or without modification, are permitted provided that the following conditions are met:

- \* Redistributions of source code must retain the above copyright notice, this list of conditions and the following disclaimer.
- \* Redistributions in binary form must reproduce the above copyright notice, this list of conditions and the following disclaimer in the documentation and/or other materials provided with the distribution.
- \* Neither the name of Nokia Corporation and its Subsidiary(-ies) nor the names of its contributors may be used to endorse or promote products derived from this software without specific prior written permission.

THIS SOFTWARE IS PROVIDED BY THE COPYRIGHT HOLDERS AND CONTRIBUTORS "AS IS" AND ANY EXPRESS OR IMPLIED WARRANTIES, INCLUDING, BUT NOT LIMITED TO, THE IMPLIED WARRANTIES OF MERCHANTABILITY AND FITNESS FOR A PARTICULAR PURPOSE ARE DISCLAIMED. IN NO EVENT SHALL THE COPYRIGHT OWNER OR CONTRIBUTORS BE LIABLE FOR ANY DIRECT, INDIRECT, INCIDENTAL, SPECIAL, EXEMPLARY, OR CONSEQUENTIAL DAMAGES (INCLUDING, BUT NOT LIMITED TO, PROCUREMENT OF SUBSTITUTE GOODS OR SERVICES; LOSS OF USE, DATA, OR PROFITS; OR BUSINESS INTERRUPTION) HOWEVER CAUSED AND ON ANY THEORY OF LIABILITY, WHETHER IN CONTRACT, STRICT LIABILITY, OR TORT (INCLUDING NEGLIGENCE OR OTHERWISE) ARISING IN ANY WAY OUT OF THE USE OF THIS SOFTWARE, EVEN IF ADVISED OF THE POSSIBILITY OF SUCH DAMAGE.

-----  
 This product includes Qt SQL driver plugin (qsqlodbc).

Copyright (C) 1992-2008 Trolltech ASA. All rights reserved.

Warranty Disclaimer: The Licensed Software is licensed to Licensee "as is". To the maximum extent permitted by applicable law, Trolltech on behalf of itself and its suppliers, disclaims all warranties and conditions, either express or implied, including, but not limited to, implied warranties of merchantability, fitness for a particular purpose, title and non-infringement with regard to the Licensed Software.

Limitation of Liability: If, Trolltech's warranty disclaimer notwithstanding, Trolltech is held liable to Licensee, whether in contract, tort or any other legal theory, based on the Licensed Software, Trolltech's entire liability to Licensee and Licensee's exclusive remedy shall be, at Trolltech's option, either (A) return of the price Licensee paid for the Licensed Software, or (B) repair or replacement of the Licensed Software, provided Licensee returns to Trolltech all copies of the Licensed Software as originally delivered to Licensee. Trolltech shall not under any circumstances be liable to Licensee based on failure of the Licensed Software if the failure resulted from accident, abuse or misapplication, nor shall Trolltech under any circumstances be liable for special damages, punitive or exemplary damages, damages for loss of profits or interruption of business or for loss or corruption of data. Any award of damages from Trolltech to Licensee shall not exceed the total amount Licensee has paid to Trolltech in connection with this Agreement.

This product includes QSql.

Copyright (c) 2009 Nokia Corporation and/or its subsidiary(-ies).

BECAUSE THE LIBRARY IS LICENSED FREE OF CHARGE, THERE IS NO WARRANTY FOR THE LIBRARY, TO THE EXTENT PERMITTED BY APPLICABLE LAW. EXCEPT WHEN OTHERWISE STATED IN WRITING THE COPYRIGHT HOLDERS AND/OR OTHER PARTIES PROVIDE THE LIBRARY "AS IS" WITHOUT WARRANTY OF ANY KIND, EITHER EXPRESSED OR IMPLIED, INCLUDING, BUT NOT LIMITED TO, THE IMPLIED WARRANTIES OF MERCHANTABILITY AND FITNESS FOR A PARTICULAR PURPOSE. THE ENTIRE RISK AS TO THE QUALITY AND PERFORMANCE OF THE LIBRARY IS WITH YOU. SHOULD THE LIBRARY PROVE DEFECTIVE, YOU ASSUME THE COST OF ALL NECESSARY SERVICING, REPAIR OR CORRECTION.

-----  
 This product includes robin-map.

MIT License

Copyright (c) 2017 Tessil

Permission is hereby granted, free of charge, to any person obtaining a copy of this software and associated documentation files (the "Software"), to deal in the Software without restriction, including without limitation the rights to use, copy, modify, merge, publish, distribute, sublicense, and/or sell copies of the Software, and to permit persons to whom the Software is furnished to do so, subject to the following conditions:

The above copyright notice and this permission notice shall be included in all copies or substantial portions of the Software.

THE SOFTWARE IS PROVIDED "AS IS", WITHOUT WARRANTY OF ANY KIND, EXPRESS OR IMPLIED, INCLUDING BUT NOT LIMITED TO THE WARRANTIES OF MERCHANTABILITY, FITNESS FOR A PARTICULAR PURPOSE AND NONINFRINGEMENT. IN NO EVENT SHALL THE AUTHORS OR COPYRIGHT HOLDERS BE LIABLE FOR ANY CLAIM, DAMAGES OR OTHER LIABILITY, WHETHER IN AN ACTION OF CONTRACT, TORT OR OTHERWISE, ARISING FROM, OUT OF OR IN CONNECTION WITH THE SOFTWARE OR THE USE OR OTHER DEALINGS IN THE SOFTWARE.

-----  
 This product includes svgio.

Copyright Oleg Maximenko 2014.  
 Distributed under the Boost Software License, Version 1.0.

-----  
 This product includes tessdata.

Inc. Licensed under the Apache License, Version 2.0

-----  
 This product includes tesseract.

Copyright (C) 2016 Google, Inc. Licensed under the Apache License, Version 2.0

-----  
 This product includes LibTIFF.

Copyright (c) 1988-1997 Sam Leffler  
 Copyright (c) 1991-1997 Silicon Graphics, Inc.

Permission to use, copy, modify, distribute, and sell this software and its documentation for any purpose is hereby granted without fee, provided that (i) the above copyright notices and this permission notice appear in all copies of the software and related documentation, and (ii) the names of Sam Leffler and Silicon Graphics may not be used in any advertising or publicity relating to the software without the specific, prior written permission of Sam Leffler and Silicon Graphics.

THE SOFTWARE IS PROVIDED "AS-IS" AND WITHOUT WARRANTY OF ANY KIND, EXPRESS, IMPLIED OR OTHERWISE, INCLUDING WITHOUT LIMITATION, ANY

WARRANTY OF MERCHANTABILITY OR FITNESS FOR A PARTICULAR PURPOSE.

IN NO EVENT SHALL SAM LEFFLER OR SILICON GRAPHICS BE LIABLE FOR ANY SPECIAL, INCIDENTAL, INDIRECT OR CONSEQUENTIAL DAMAGES OF ANY KIND, OR ANY DAMAGES WHATSOEVER RESULTING FROM LOSS OF USE, DATA OR PROFITS, WHETHER OR NOT ADVISED OF THE POSSIBILITY OF DAMAGE, AND ON ANY THEORY OF LIABILITY, ARISING OUT OF OR IN CONNECTION WITH THE USE OR PERFORMANCE OF THIS SOFTWARE.

-----  
 This product includes XercesC.

NOTICE file corresponding to section 4(d) of the Apache License, Version 2.0, in this case for the Apache Xerces distribution.

This product includes software developed by  
 The Apache Software Foundation (<http://www.apache.org/>).

Portions of this software were originally based on the following:  
 - software copyright (c) 1999, IBM Corporation., <http://www.ibm.com>.

-----  
 This product includes XMP Toolkit.

Copyright (c) 1999 - 2010, Adobe Systems Incorporated  
 All rights reserved.

Redistribution and use in source and binary forms, with or without modification, are permitted provided that the following conditions are met:

- \* Redistributions of source code must retain the above copyright notice, this list of conditions and the following disclaimer.
- \* Redistributions in binary form must reproduce the above copyright notice, this list of conditions and the following disclaimer in the documentation and/or other materials provided with the distribution.
- \* Neither the name of Adobe Systems Incorporated, nor the names of its contributors may be used to endorse or promote products derived from this software without specific prior written permission.

THIS SOFTWARE IS PROVIDED BY THE COPYRIGHT HOLDERS AND CONTRIBUTORS "AS IS" AND ANY EXPRESS OR IMPLIED WARRANTIES, INCLUDING, BUT NOT LIMITED TO, THE IMPLIED WARRANTIES OF MERCHANTABILITY AND FITNESS FOR A PARTICULAR PURPOSE ARE DISCLAIMED. IN NO EVENT SHALL THE COPYRIGHT OWNER OR CONTRIBUTORS BE LIABLE FOR ANY DIRECT, INDIRECT, INCIDENTAL, SPECIAL, EXEMPLARY, OR CONSEQUENTIAL DAMAGES (INCLUDING, BUT NOT LIMITED TO, PROCUREMENT OF SUBSTITUTE GOODS OR SERVICES; LOSS OF USE, DATA, OR PROFITS; OR BUSINESS INTERRUPTION) HOWEVER CAUSED AND ON ANY THEORY OF LIABILITY, WHETHER IN CONTRACT, STRICT LIABILITY, OR TORT (INCLUDING NEGLIGENCE OR OTHERWISE) ARISING IN ANY WAY OUT OF THE USE OF THIS SOFTWARE, EVEN IF ADVISED OF THE POSSIBILITY OF SUCH DAMAGE.

-----  
 This product includes xxHash.

xxHash Library  
 Copyright (c) 2012-2014, Yann Collet  
 All rights reserved.

Redistribution and use in source and binary forms, with or without modification, are permitted provided that the following conditions are met:

- \* Redistributions of source code must retain the above copyright notice, this list of conditions and the following disclaimer.
- \* Redistributions in binary form must reproduce the above copyright notice, this list of conditions and the following disclaimer in the documentation and/or other materials provided with the distribution.

THIS SOFTWARE IS PROVIDED BY THE COPYRIGHT HOLDERS AND CONTRIBUTORS "AS IS" AND ANY EXPRESS OR IMPLIED WARRANTIES, INCLUDING, BUT NOT LIMITED TO, THE IMPLIED WARRANTIES OF MERCHANTABILITY AND FITNESS FOR A PARTICULAR PURPOSE ARE DISCLAIMED. IN NO EVENT SHALL THE COPYRIGHT HOLDER OR CONTRIBUTORS BE LIABLE FOR ANY DIRECT, INDIRECT, INCIDENTAL, SPECIAL, EXEMPLARY, OR CONSEQUENTIAL DAMAGES



```
(INCLUDING, BUT NOT LIMITED TO, PROCUREMENT OF SUBSTITUTE GOODS OR SERVICES;
LOSS OF USE, DATA, OR PROFITS; OR BUSINESS INTERRUPTION) HOWEVER CAUSED AND ON
ANY THEORY OF LIABILITY, WHETHER IN CONTRACT, STRICT LIABILITY, OR TORT
(INCLUDING NEGLIGENCE OR OTHERWISE) ARISING IN ANY WAY OUT OF THE USE OF THIS
SOFTWARE, EVEN IF ADVISED OF THE POSSIBILITY OF SUCH DAMAGE.

-----

This product includes zlib.

(C) 1995-2017 Jean-loup Gailly and Mark Adler

This software is provided 'as-is', without any express or implied
warranty. In no event will the authors be held liable for any damages
arising from the use of this software.

Permission is granted to anyone to use this software for any purpose,
including commercial applications, and to alter it and redistribute it
freely, subject to the following restrictions:

1. The origin of this software must not be misrepresented; you must not
claim that you wrote the original software. If you use this software
in a product, an acknowledgment in the product documentation would be
appreciated but is not required.
2. Altered source versions must be plainly marked as such, and must not be
misrepresented as being the original software.
3. This notice may not be removed or altered from any source distribution.

Jean-loup Gailly      Mark Adler
jloup@gzip.org        madler@alumni.caltech.edu

-----

This product includes ZXing C++ Library.

-----
NOTICES FOR C++ Big Integer Library
-----

I, Matt McCutchen, the sole author of the original Big Integer
Library, waive my copyright to it, placing it in the public domain.
The library comes with absolutely no warranty.

-----
```

## 1.2. Installation

---

ArtPro+ is only supported on 64-bit operating systems, both on Mac and on Windows. Currently supported are:

- MacOS 10.14, MacOS 10.15, MacOS 11 (on Intel and on Apple Silicon M1 Rosetta2) and MacOS 12 (Monterey, Intel and M1 Rosetta2).
- Windows 10 and Windows 11.

You can download the installer for ArtPro+ from <http://mysoftware.esko.com>.

Download the ArtPro+.dmg file for Mac, or the .exe file for Windows.

## 1.3. Licensing

---

You can check the **Licenses** info by choosing **Help > License Info ....**

You can run ArtPro+ with a valid local license, by connecting to a license server carrying valid network licenses, or by signing in to a Named User Subscription. More information on licenses and how to activate them can be found here: <https://www.esko.com/en/Support/Product?id=Licensing%20and%20Activation>.

### ArtPro+ Essentials and ArtPro+ Layout

ArtPro+ always needs one of the base licenses: ArtPro+ Essentials or ArtPro+ Layout. Additional licenses (see below) can add extra functionality.

With either base license you can use most of the basic editing and quality control tools. The table below shows the differences between ArtPro+ Essentials and ArtPro+ Layout:

Functionality	ArtPro+ Essentials	ArtPro+ Layout
<i>Action Lists</i>	✓	✗
Specific text functions: <ul style="list-style-type: none"> <li>• <i>Convert Outlines to Text</i></li> <li>• <i>Text in Path</i></li> <li>• <i>Text on Path</i></li> </ul>	✓	✗
Specific Select tools: <ul style="list-style-type: none"> <li>• <i>Select Same</i></li> <li>• <i>Select Advanced</i> on page 116</li> </ul>	✓	✗
<i>Convert to Barcode</i>	✓	✗
<i>Rich Black</i>	✓	✗
<i>Fix Thin Parts</i>	✓	✗
<i>Shaper</i>	✓	✗
<i>Manual Trapping</i>	✓	✗
<i>Clean</i>	✓	✗
<i>Trace Image</i> on page 171	✓	✗
<i>Step &amp; Repeat</i>	✗	✓

**Note:** Functionality not specifically mentioned in this table, and not protected by an ArtPro+ Advanced or other additional license (see below) is available in both ArtPro+ Essentials and ArtPro+ Layout.

### ArtPro+ Advanced

An ArtPro+ Advanced license adds the following functionality (when not yet available in your base license):

- Grid Step & Repeat. See [Grid Step & Repeat](#) on page 268
- Open Layout CF2 Files, MFG files, Replace Structural Design stations & Adjust Bleed tool. See [Step & Repeat based on an MFG or CF2 file](#) on page 278
- Automatic Trapping. See [Automatic Trapping](#)

**Note:** Combining an ArtPro+ Essentials and ArtPro+ Layout base license will result in the same functionality as ArtPro+ Essentials and ArtPro+ Advanced. Keep in mind that this does not make optimal use of your licenses, as certain functionality is licensed twice.

### Additional Licenses

- **ArtPro+ Plate Cut:** You need this license to create Plate Cutting Paths. See [Create Plate Cutting Paths](#) on page 285
- **ArtPro+ Equinox:** You need this license to use the **Equinox** functionality in the **Recolor** function. See [Recolor](#) on page 150. Note that this is different from the Equinox module licenses for ArtPro or PackEdge / Plato.
- **ArtPro+ Variable Data Expansion:** You need this license to export Variable Data. See [Variable Data](#) on page 350
- **Studio Designer:** You need this license to get a 3D view of files with a structural design file. See [Studio in ArtPro+](#) on page 343
- With a **Studio Toolkit for Labels** license you can revolve a path in Studio Toolkit (see [Creating a revolved shape with labels](#) on page 344) and apply predistortion based on the structural design file in the document (see [Predistortion](#) on page 346),
- With a **Studio Toolkit for Shrink Sleeves** you can revolve a path in Studio Toolkit (see [Creating a revolved shape with labels](#) on page 344) and apply shrink sleeve warp (see [Shrink Sleeve Warp](#) on page 264).

### When launching ArtPro+

- To work with ArtPro+, you need an ArtPro+ Essentials or ArtPro+ Layout license. If this base license is missing, you must activate a local license, define a License Server or work with subscriptions before you can continue.
- If local licenses or subscriptions are found for ArtPro+ Advanced or the additional licenses, they will always be used.
- If any of the remaining licenses are enabled in the License Info panel, ArtPro+ will search for these on a defined License Server. If these additional licenses are not found when launching ArtPro+, the License Info panel will pop up, and you can choose:
  - you can disable the license. This means that ArtPro+ will no longer check for that license on the License Server
  - you can continue the ArtPro+ session without the license. Next time you launch ArtPro+, ArtPro+ will search for the license again.
  - you can quit the application, e.g. if you first want to ask another operator to release the license.

You can check the license status or change what licenses to check for at any time by going to **Help > License Info**. See [The ArtPro+ License Info panel](#) on page 28

### 1.3.1. The ArtPro+ License Info panel

You can open the **ArtPro+ License Info** panel by choosing **Help > License Info...**

The License Info panel will show you information on the current license you are using.

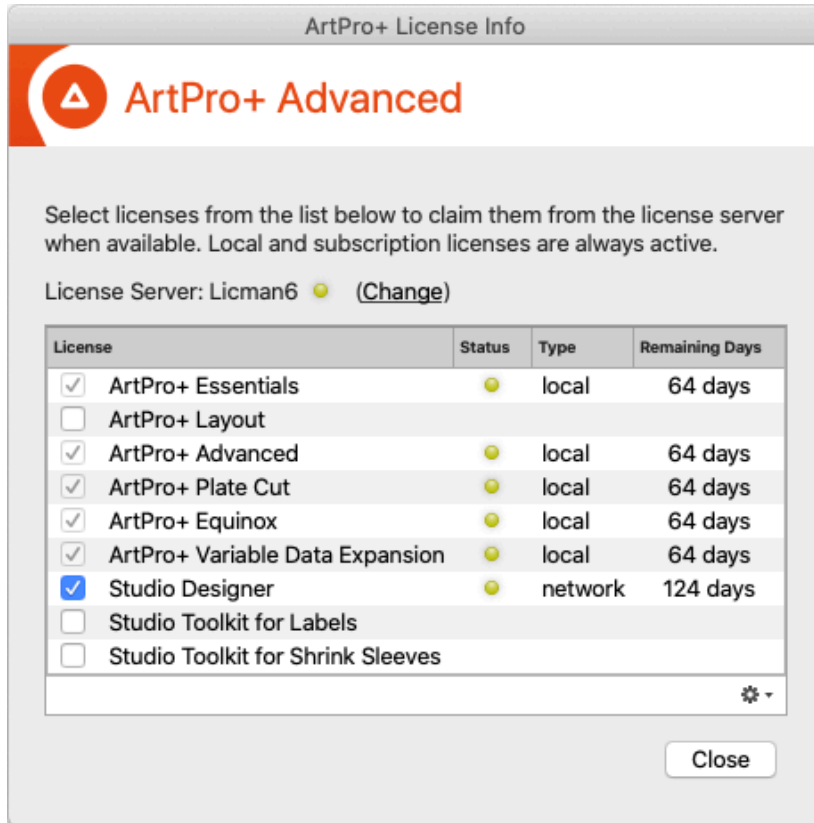

#### License Server

If you don't have a License Server set up already, you can click **Define a License Server**, and enter the name of the License Server you want to connect to.

If you already have a License Server set up, The name of the License Server is shown here. You can click **Change** to connect to a different License Server.

#### Licenses

- For any valid license that is found and used by the application, a green status bullet will be shown. If a license is requested (enabled) but not found, a red status bullet will be displayed.
- You can disable additional License Server licenses. ArtPro+ will then no longer try to use it when starting up. By default, all additional licenses are enabled.
- Local licenses or subscriptions can't be deactivated in the License Info dialog. To manage your local licenses, use the Local License Manager. You can open the Local License Manager by selecting **Open Local License Manager** from the fly-out menu. For more information on activating local licenses, we refer to the Licensing and Activation documentation: <https://www.esko.com/en/Support/Product?id=Licensing%20and%20Activation>

- To sign in on or sign out of your subscriptions, choose **Help > Sign In / Sign Out ...**, or use the corresponding item from the fly-out menu of the License Info dialog.

**Note:** Disabling or enabling a module is effective immediately, so the corresponding menu items and functions will no longer be available.

## 1.4. What's New in ArtPro+ 21.11

---

Below is a list of changes in ArtPro+ 21.07 and a link to the specific page in the documentation. For a full overview of bug fixes, you can check the [Release Notes](#). You can also consult the [What's New presentation](#)

- You can now add static **Plate ID** objects and dynamic **Plate ID Marks**. See [Plate ID Objects](#) on page 287
- **Barcode Marks:** You can now color Barcode Marks using Static Color, Darkest Color or Registration Color. When using Static Color, you can create multicolor barcodes for the barcode types that support it (such as Laetus Pharma). See [Barcode Mark](#) on page 312
- **Trapping:** you can now enable **Allow Overshoot** in Automatic Trapping. See [Starting Automatic Trapping](#) on page 249
- **Ink Coverage:** you can now export the Ink Coverage data to a file. See [Ink Coverage](#) on page 89
- **Action Lists**
  - You can now filter the Action Lists shown in the Action List Side Drawer, by entering (a part of) an Action List name in the search box. See [The Action List Side Drawer](#) on page 326
  - Using **Run With Options** you can now run an Action List on a selection of pages, or redefine the **Action List Parameters** used in the Action List. See [Run With Options](#) on page 327
  - Using **Conditional Action (If... Then...) Action** you can run one or more actions on the condition that certain criteria are met. See [Actions](#) on page 331
  - New **Actions:** Set Stroke Corners, Set Stroke Dashing, Set Stroke End Caps, Create Ink Eater Areas and Fill Ink Eater Areas, Select Objects by Box. See [Actions](#) on page 331
- You can now align **Text** vertically in a text box. See [Text Inspector](#) on page 156

### Improvements:

- **Compare:** if the reference document is a multipage PDF, you can select what page to use. See [Compare](#) on page 83
- In the Custom ink filter used when coloring a Mark, you can now exclude inks by setting the filter to "Separation Name doesn't equal ...". See [Colors and Separations in a Mark](#) on page 317
- **Create Plate Cutting Paths** has been moved to **Prepress > Flexo Tools**. See [Create Plate Cutting Paths](#) on page 285
- The **Document Profile** can now be set in the **Separations** section of the Side Panel. See [Color Management](#) on page 77
- **Export 3D:** When exporting to glTF, you can now **optimize for Microsoft Office**. See [Export 3D](#) on page 348

- **Recolor:** the Recolor dialog has been updated. See [Recolor](#) on page 150
- The **Add Station Numbering Mark** is no longer available. It has been replaced by a Standard Mark Set called "Standard Repeat for Stations Mark - Station Number", available when applying **Load Mark Set**. It attaches the Mark to a "StationNumber" placeholder.

### What's New in ArtPro+ 21.07

Below is a list of changes in ArtPro+ 21.07 and a link to the specific page in the documentation. For a full overview of bug fixes, you can check the [Release Notes](#)

- Using **Insert Content from PDF** you can place the content of a PDF file on your current page. See [Insert Content from PDF](#) on page 70
- **Add Bleed:** if you have a PDF+ file with a Processing Step Layer Cutting, you can use the **Add Bleed** function to add bleed outside of the cutting lines. See [Add Bleed](#) on page 239
- You can now add **Ink Eater Areas**. See [Ink Eater Areas](#) on page 242
- **Barcodes:** ArtPro+ now supports the following barcodes:
  - Code 93. See [Code 93](#) on page 188
  - EAN-13 Swissmedic. See [EAN-13 Swissmedic](#) on page 196
  - HIBC 128. See [HIBC 128](#) on page 210
  - HIBC 39. See [HIBC 39](#) on page 208
  - Klebrand. See [Klebrand](#) on page 216
  - PZN. See [PZN](#) on page 219
  - Bobst. See [Bobst](#) on page 226
  - Kurandt. See [Kurandt](#) on page 228
- **Barcode** improvements:
  - You can now apply multicolor fill on Code 128 barcodes. See [Multicolor barcodes](#) on page 232
  - The last used settings for **Add Box** are now reused per barcode type.
- **Marks:**
  - The **Repeat for Grid Mark** replaces the "Grid Mark" from earlier versions, and offers extra options, such as positioning the marks on the inner stations of a Grid. See [Repeat for Grid Mark](#) on page 306
  - You can now use named objects, as well as text objects in MFG and CFF files as placeholder in a **Repeat for Placeholder Mark**. See [Repeat for Placeholder Mark](#) on page 307
  - A **Repeat by Count Mark** can now contain a **Resize Mark**. See [Repeat by Count Mark](#) on page 304 and [Nested Marks](#) on page 323
  - For Dynamic Color, Darkest Color and Registration Color, you could already indicate what separations to be used in the Mark. Now you can use **Subset of Separations** to only use some separations, based on index number. For Repeat for Separations, this function was already

available, but was named "Use Separation" in earlier versions. See [Colors and Separations in a Mark](#) on page 317

- You can now use a PZN, Code 128 and Laetus barcode in a Barcode Mark. See [Barcode Mark](#) on page 312
- You can now change the **screening** of Marks. See [Marks](#) on page 291 and [Screening](#) on page 245
- The minimum font size for an Area Text Mark is now customizable. See [Point Text Mark and Area Text Mark](#) on page 294
- When using **Plate Cutting Paths**, you can use the **Flexo Print Preview** mode of Quality Control to check the Plate Cutting Paths and the Drum Circumference. See [Flexo Print Preview](#) on page 80 and [Create Plate Cutting Paths](#) on page 285
- You can now create **Plate Cutting Guides**. When creating Plate Cutting Paths, the guides can be used to create the Plate Cutting Paths, as an alternative to the automatically calculated paths. See [Using Plate Cutting Guides](#) on page 287
- The **Color Engine Data** option in the Preferences has an extra option: next to using the Standard Color Engine Data (local) or browsing to your CMS tree, you can now also set it to **From Automation Engine**. This will automatically use the CMS tree from the Automation Engine server you're connected to. See [Preferences](#) on page 44.
- You can now **Export to JDF Layout**. See [Export to JDF Layout](#) on page 61
- **Export to 3D**: you can now export to binary GTIF. See [Export 3D](#) on page 348
- **Compare** now allows you to match separations that don't have the same name, or to exclude separations from the comparison. See [Compare](#) on page 83
- You can now use the **Dashboard** (replacing the Customer Experience Program). See [Dashboard](#) on page 34
- **Improvements:**
  - In the Image Side Drawer, you can now see a list of images used in opacity masks. See [Images Side Drawer](#) on page 170
  - **Select Advanced** can now be used to select images, based on color space, spot channels, ICC profile, resolution, transparency or linked state. See [Select Advanced](#) on page 116
  - If you **Replace an Image**, you can now choose if you want to import its clipping path (replacing an existing clipping path) or not. See [Replacing an image](#) on page 170
  - When calculating the die shape of a **Grid Step & Repeat**, ArtPro+ can now automatically detect cutting lines of the structural design that is placed inside the one-ups. When Placed Art contains cutting lines as part of the Structural Design, you can set the **Die Shape** in the Grid to "Cutting Layer". See [Grid Step & Repeat](#) on page 268
  - When opening a PDF file from Adobe Illustrator using an ICC profile as Page blending colorspace, without a defined document profile, this Page blending colorspace ICC profile will now be used in ArtPro+ as document profile (instead of using the Default Document Profile). See also [Color Management](#) on page 77
  - Normalized PDF files from Plato containing channel mapping or Image Marks could not be opened in ArtPro+. Now, these files can be opened, and externally linked files become

- embedded, to maintain the channel mapping. Ink mapping in which multiple inks are mapped to the same separation for one object is still not supported.
- A number of settings in specific dialogs can be stored by enabling the **Remember My Choice** option. The Preferences now contain a button to **Reset All**, so the next time you will be asked the question again. See [Preferences](#) on page 44
- You can now enter 0.4% as First Printable Dot in the Quality Control modes. See [Quality Control](#) on page 79
- Editing Action Lists, running Action Lists and stepping through Action Lists can now be done from the **Action List Side Drawer**. See [The Action List Side Drawer](#) on page 326
- **New Action List actions** See [Actions](#) on page 331
  - Add Bleed
  - Insert Content from PDF
  - Modify Screen Sets
  - Set Object Screening
  - Add Barcode
  - Set Barcode Value
  - Update Barcode
- **Updated Action List actions** See [Actions](#) on page 331
  - **Select Layer by Processing Step:** you can now select custom Processing Steps
  - **Create Separation:** you can now use the input field as a filter to search and select an ink from the available ink books, as when creating a Separation. See [Adding or changing a separation](#) on page 103
  - **Update Linked Images, Update Linked Placed Art** and **Update Structural Design:** you can now set the warning level (Info, Warning or Error) when the linked file is missing.
  - **Select Object by Attributes:** more filtering options for selecting images have been added.
  - **Place PDF File:** You can now specify what page of the PDF file to place.

### What's new in ArtPro+ 21.03

Below is a list of changes in ArtPro+ 21.03 and a link to the specific page in the documentation.

- You can now work with **Variable Data** in ArtPro+. You can combine a Variable Data Template with a database to create multiple versions of your design. See [Variable Data](#) on page 350
- ArtPro+ can now connect to an Automation Engine SaaS server. See [Automation Engine connection](#) on page 61
- **Export to PDF** offers you the option to select and run an Action List prior to exporting your document to PDF. Your original document remains unchanged. See [Export to PDF](#) on page 58
- Text On Path. See [Create Text on Path](#) on page 163
- Export to **TIFF for HELL Job Ticket**: see [Export Gravure TIFF](#) on page 60
- The menu items for **Export Gravure Tiff** and **Export 3D** are now in **File > Export To** along with the new **Export to PDF** and **Export Variable Data**. See [Export](#) on page 58



- You can now create **Plate Cutting Paths** not only on ArtPro+ Step & Repeat grids, but also on Esko Plato PDFPla and ArtPro Step&Repeat files. For that, you can now also manually set the Plate Circumference. See [Create Plate Cutting Paths](#) on page 285
- By default, in Preview mode you click **in** a path to select it, and in Outline mode you click **on** a path to select it. By disabling **Select > Select by Paths (Outline mode)** you can now also select by clicking **in** the path in Outline mode. See [Selecting in Preview or in Outline Mode](#) on page 113
- ArtPro+ now supports JPEG images. See [Working with images](#) on page 164
- When transforming objects while holding the **Alt** key, the objects will be copied. In earlier versions of ArtPro+ these copied objects were placed in the topmost layer of your document. In ArtPro+ 21.03 and later, the copied objects are placed in the same layer as the original objects, right above the original object. See [Transforming objects](#) on page 122
- New or updated **Action List Actions**:
  - Add Dimensions
  - Crop Images
  - Downsample Images
  - Replace Linked Images
  - Trace Image
  - Reorder Separations
  - Select Darkest Artwork Separation
 See [Actions](#) on page 331

## 1.5. The About palette

---

You can open the **About** window by choosing **ArtPro+ > About** (Mac) or **Help > About** (Windows).

The **About** palette contains build information, copyrights and a Legal Notices button.

Clicking **Legal Notices** will show the legal information. By clicking **Done** you go back to the default view.

## 1.6. Getting help

---

There are several menu items in the **Help** menu:

1. Clicking **Getting Started** will open a window that gives a quick tour on ArtPro+ tools and a link to the ArtPro+ eLearning modules. After a first installation, this window will appear automatically when starting the application.
2. Clicking **What's New** will open a presentation on the new functions in ArtPro+
3. Clicking **Online Help** will open the Online Help page of your current ArtPro+ version in your internet browser. When available, the online help will open in your currently selected language.
4. Clicking **Knowledge Base** will open Esko's Knowledge Base in your internet browser, filtering on articles about ArtPro+.
5. Click **Dashboard** to open the Dashboard or enable it. See [Dashboard](#) on page 34
6. Use **License Info** to check your license settings. For subscription licenses, there is also a Sign In / Sign Out option. See [Licensing](#) on page 25

## 1.7. Languages

---

ArtPro+ is supported in English, French, Italian, German, Spanish, Japanese, Simplified and Traditional Chinese and Korean.

There are no application specific preferences to change the language. To see the user interface of ArtPro+ localized in one of these supported languages:

- On MacOS, go to **System Preferences > Language & Region** and move your preferred language to the top of the languages list.
- On Windows 10, go to **Control Panel > Clock and Region > Region** and change the **Format** to the preferred language.
- On Windows 11, go to **Control Panel > Time & Language > Language & Region > Region** and change the **Regional Format** to the preferred language.

## 1.8. Dashboard

---

In the Esko Dashboard you can see information about your usage of ArtPro+. By enabling Dashboard, you can also help to improve ArtPro+ by allowing us to collect anonymous information about the way you use ArtPro+ and its features.

### 1. Select **Help > Dashboard...**

If you didn't enable **Dashboard** before, by clicking **Yes, I want a dashboard** (either during installation or by opening **Help > Dashboard...**), you will be asked if you want to enable Esko ArtPro+ Dashboard.

If you do not want Esko to collect data about your ArtPro+ usage, you can click **Not Now**. Otherwise, you can click **Yes, I want a dashboard**

### 2. In the Dashboard, you can:

- See which features you use, and how often
- Learn how many files are processed with your ArtPro+.
- Get configurable reports for your company.

## 2. Getting Started

**Note:**

Besides this user guide, you can also find related documentation and a number of introduction videos on the ArtPro+ product page on Esko's help pages: <https://www.esko.com/en/Support/Product?id=ArtProPlus>

You can also find interactive courses about different subjects on Esko's eLearning pages: <https://www.esko.com/en/support/blendedlearning/artproplus>

### 2.1. The ArtPro+ Workspace

When you launch the application, you get a blank application window (on Windows only), and the ArtPro+ menu bar.

Once you've opened a document, this is what you can see in the ArtPro+ Workspace:

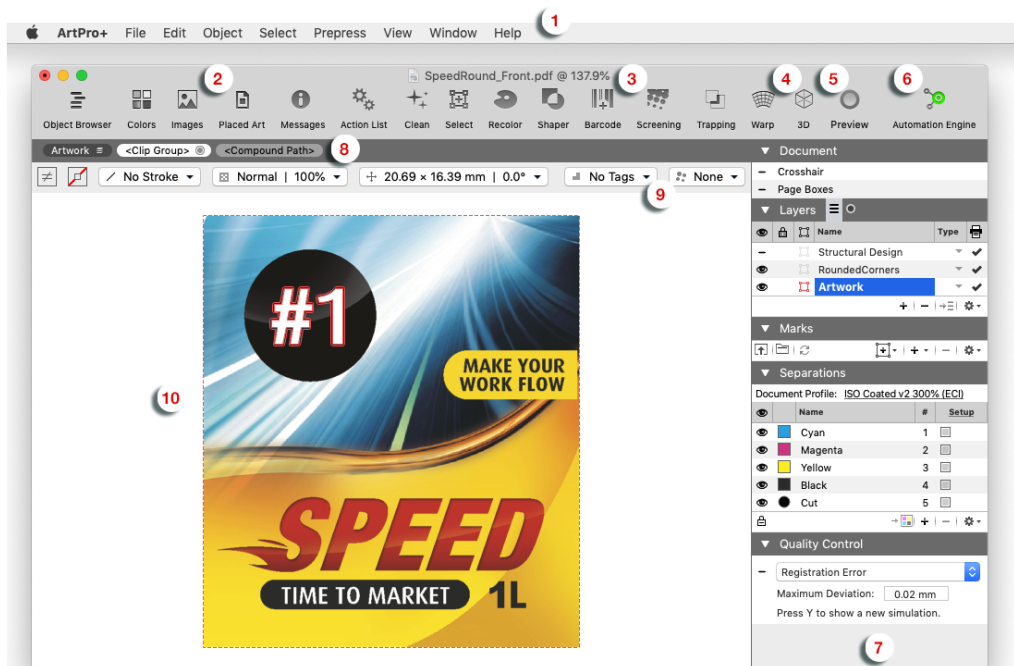

1. The **menu bar**
2. The **Side Drawer** buttons for Object Browser, Colors, Images, Placed Art, Messages and Action Lists. See [Using the Side Drawer](#) on page 36
3. The **Toolbar**, containing
  - **Clean.** See [Clean](#) on page 140,
  - **Select.** See [Select Same](#) on page 115 and [Select Advanced](#) on page 116,

- **Recolor.** See [Recolor](#) on page 150
  - **Shaper.** See [Shaper](#) on page 155,
  - **Barcode.** See [Barcode](#)
  - **Screening.** See [Screening](#) on page 245
  - **Trapping.** See [Trapping](#) on page 248
  - **Warp.** See [Warp](#) on page 261
4. The **3D** button. See [3D View](#) on page 343
  5. The **View Mode selector.** See [Preview or Outline mode](#) on page 76
  6. The **Server Connection** indicator. See [Automation Engine connection](#) on page 61
  7. The **Side Panel**, containing a Document section (page navigator for multi-page documents, crosshair, page boxes, layers), Marks section, Separations section and Quality Control section. See [Using the Side Panel](#) on page 37
  8. The **Selection Breadcrumbs.** See [Selection Breadcrumbs](#) on page 114
  9. The **Inspector.** See [The Inspector](#) on page 37
  10. The **document pane**

### 2.1.1. Using the Side Drawer

The Side Drawer is a panel on the left side, that can show relevant information. You can make it visible by selecting any of the Side Drawer buttons. Click another button to switch the content of the Side Drawer, or click the active button to hide the Side Drawer again.

There are different Side Bar modes: Object Browser, Colors Side Drawer, Images Side Drawer, Placed Art Side Drawer and Messages Side Drawer.

The **Object Browser** lists all layers, groups and objects in the document. The Object Browser has three modes: the normal Object Browser, that lists all layers, groups and objects in the document, each with their thumbnail, the Named Object Browser, that shows all named Objects in the document, and the Trap Tagged Objects, that lists all object with a Trap Tag defined. See [Object Browser](#) on page 99

The **Colors Side Drawer** lists all flat colors and gradients used in the current page of the open document. See [The Colors Side Drawer](#) on page 88

The **Images Side Drawer** gives an overview of all images in the document. See [Images Side Drawer](#) on page 170

The **Placed Art Side Drawer** shows a list of all placed PDFs used in the document. See [Placed Art Side Drawer](#) on page 179

The **Messages Side Drawer** lists all errors, warnings and information (in this order) that require you to take action. It is split up in different sections: Page Boxes, Preflight, Text, Barcodes, Processing Step Layers and Others. The tooltip of the messages will give more information about the message. Clicking on one of the entries will select the corresponding object(s) or layer(s) in the job. If the **Zoom**

**to Selection**  option is enabled, clicking an entry displays the selected objects as big as possible in the active window.

The **Action List Side Drawer** shows all available action lists, and allows you to run or edit the Action Lists. See [The Action List Side Drawer](#) on page 326

The **Variable Data Side Drawer** is only available when you're working on a Variable Data Template. See [Variable Data](#) on page 350

## 2.1.2. Using the Side Panel

The Side Panel contains several sections

- If you have a multi-page document open, you can use the Page Navigator. See [Navigating a multi-page document](#) on page 91
- In the **Document** section you can make the Crosshair visible or invisible and set up the Page Boxes . See [The Crosshair](#) on page 75 and [Page Boxes](#) on page 92.
- In the **Layers** part, you can reorder and rename layers, and view or change their visibility or printing state. See [Layers](#) on page 94.
- In the **Marks** part, you can manage your marks: load and save Mark Sets, create new Marks, etc. See [Marks](#) on page 291. This is not available for Normalized PDF files.
- In the **Separations** section, you can reorder and rename separations, make specific separations visible or invisible, add printing separations, remove separations or merge separations. See [Separations](#) on page 101.
- In the **Quality Control** section you can do some quality control, such as looking for breakouts below a certain percentage, checking if the maximum Total Area Coverage is exceeded, checking the used screen sets, detecting possible screening problems (moiré), simulating a registration error or comparing two files. See [Quality Control](#) on page 79.

## 2.1.3. The Inspector

The **Inspectors**, shown in the bar between the **Selection Breadcrumbs** and the **Document Pane** show information and possible actions for the current selection, such as the current Fill and Stroke. Using the Inspectors, you can change these settings for the current selection.

You can use the shortcut **Cmd+i** / **Cmd+Shift+i** (Mac) or **Ctrl+i** / **Ctrl+Shift+i** (Windows) to cycle through all Inspectors, forwards or backwards. If no inspector is open, the first or last inspector will be opened.

**Note:** The last opened Inspector is remembered. When you make a new selection, the Inspector is reopened when applicable. You can close the automatically opened Inspector by clicking it or using the **Esc** key.

### General inspectors

- [Fill Color and Stroke Color Inspector](#) on page 143
- [Stroke Inspector](#) on page 148
- [Transparency Inspector](#) on page 149
- [Transformation Inspector](#) on page 127
- Screen Set Inspector: see [Screening](#) on page 245

### Inspectors for Images

- [Image Inspector](#) on page 166

- [The Channel Mapping Inspector](#) on page 167

#### Inspectors for Placed Art & Grids

- [Placed Art Separations Inspector](#) on page 176
- [Placed Art Inspector](#) on page 176
- [Layer Types Inspector](#) on page 178
- [The Grid Inspector](#) on page 268

#### Inspectors for Structural Design

- [Structural Design File Inspector](#) on page 181
- [Structural Design Inspector](#) on page 181

#### Inspectors for Text

- [Text Inspector](#) on page 156
- [Text Box Transformation Inspector](#) on page 158

#### Inspectors for Barcodes

- Barcode Type Inspector, Barcode Code Inspector, Barcode Inspector, Barcode Font Inspector: see [Barcodes](#) on page 183

#### Inspectors for Marks

- Mark Inspector. See [Mark Types and their properties](#) on page 293

---

**Note:** If the ArtPro+ window is not big enough to show all **Inspectors** for the current selection, they can be reduced to an abbreviated version or even just the corresponding icon.

---

#### Inspectors for Variable Data

- Variable Data Objects Inspector. See [Variable Data](#) on page 350

## 2.1.4. Changing tools

There are different ways to select a tool

- Use the tool's shortcut. Using the shortcut multiple times will toggle between related functions, such as Zoom and Pan.
  1. **T**: Text tool. See [Using the Text Tool](#) on page 158
  2. **R**: Crosshair. See [Move or rotate the Crosshair](#) on page 75
  3. **R**: Cut on Crosshair. See [Cut on Crosshair](#) on page 76
  4. **V**: Group Select. See [Group Select](#) on page 110
  5. **V** or **A**: Object Select. See [Object Select](#) on page 111
  6. **V**: Path Select. See [Path Select](#) on page 112
  7. **V** or **L**: Lasso Select. See [Lasso Select](#) on page 113
  8. **D**: Densities. See [Densities](#) on page 87
  9. **D**: Dimensions. See [Dimensions](#) on page 86
  10. **P**: Create & Edit Path. See [Create & Edit Path](#) on page 132

- 11. **P**: Split & Retrace. See [Split and Retrace](#) on page 134
  - 12. **P**: Cut Path. See [Cut Path](#) on page 135
  - 13. **S**: Create a Rectangle. See [Create Rectangle / Create Ellipse](#) on page 154
  - 14. **S**: Create an Ellipse. See [Create Rectangle / Create Ellipse](#) on page 154
  - 15. **E**: Transform. See [Transforming manually](#) on page 123
  - 16. **E**: Align & Distribute. See [Align & Distribute](#) on page 128
  - 17. **Z**: Zoom. See [Zoom tool](#) on page 74
  - 18. **Z** or **H**: Pan Tool. See [Pan tool](#) on page 74
- Using the **Tool Switcher**: right-click anywhere in your document, and select the tool you want in the tool switcher wheel, or right-drag in the corresponding direction.

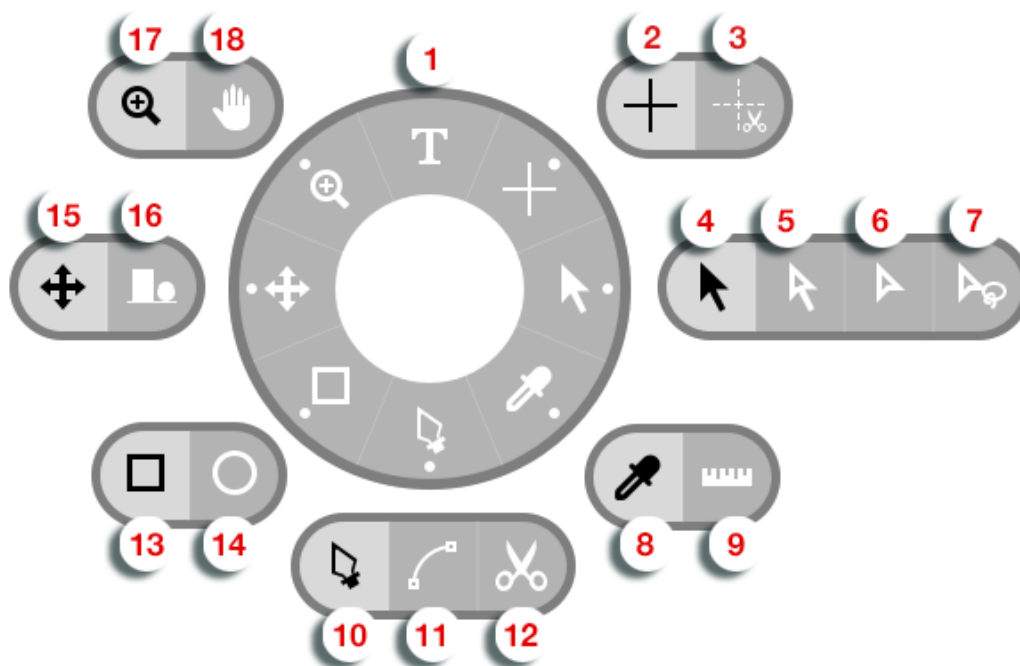

**Note:**

The quickest way to change tools, is to (briefly) right-drag (or drag while holding the control key on Mac) in the direction of the tool you need, e.g. up for Text tool Select, left for Transform, etc. You can save time this way, because you don't have to click exactly on the tool.

For subtools (such as Zoom and Pan), this will select the default (left) option. To select the other subtool, you will have to click it.

## 2.1.5. Shortcuts overview

Below, you see an overview of the default ArtPro+ shortcuts on **Mac** and on **Windows**.

By enabling the **ArtPro Classic Shortcut Set** in the Preferences, you can switch to a set of shortcuts similar to the shortcuts in ArtPro, shown in the right column. All other shortcuts remain unchanged. In the Preferences, you can also set custom keyboard shortcuts. See [Preferences](#) on page 44

The shortcuts mentioned in the rest of the user guide are the default **ArtPro+** shortcuts.

Shortcut	Mac	Windows	ArtPro Classic
Select All	Cmd+A	Ctrl+A	
Deselect All	Cmd+Shift+A	Ctrl+Shift+A	
Select Inverse	Cmd+Alt+A	Ctrl+Alt+A	
Run Action List	Cmd+Alt+Shift+A	Ctrl+Alt+Shift+A	
Page Boxes	Cmd+B	Ctrl+B	
Add Barcode	Cmd+Shift+B	Ctrl+Shift+B	
Convert to Barcode	Cmd+Alt+Shift+B	Ctrl+Alt+Shift+B	
Copy	Cmd+C	Ctrl+C	
Clean dialog	Cmd+Shift+C	Ctrl+Shift+C	
Transform Again	Cmd+D	Ctrl+D	
Warp	Cmd+Shift+D	Ctrl+Shift+D	
Warp Using Last Settings	Cmd+Alt+Shift+D	Ctrl+Alt+Shift+D	
Shaper	Cmd+E	Ctrl+E	
Paste in Front	Cmd+F	Ctrl+F	Cmd+Alt+F
Paste in Back	Cmd+Shift+F	Ctrl+Shift+F	Cmd+Alt+Shift+F
Make Group	Cmd+G	Ctrl+G	Cmd+Shift+G
Release Group	Cmd+Shift+G	Ctrl+Shift+G	Cmd+Shift+U
Make Step & Repeat Grid	Cmd+Alt+G	Ctrl+Alt+G	
Hide ArtPro+	Cmd+H	not available	
Hide Others	Cmd+Alt+H	not available	
Cycle through Inspectors (forwards)	Cmd+I	Ctrl+I	
Cycle through Inspectors (backwards)	Cmd+Shift+I	Ctrl+Shift+I	
Select Same Fill Color	Cmd+Alt+I	Ctrl+Alt+I	
Select Same Stroke Color	Cmd+Alt+Shift+I	Ctrl+Alt+Shift+I	
Join Paths	Cmd+J	Ctrl+J	
Close Path	Cmd+Alt+J	Ctrl+Alt+J	
Preferences	Cmd+, (comma)	Ctrl+K	
Launch Workflow	Cmd+L	Ctrl+L	Cmd+Alt+L
Add Dimensions	Cmd+Shift+L	Ctrl+Shift+L	
Numeric Transform	Cmd+Shift+M	Ctrl+Shift+M	Cmd+L



Shortcut	Mac	Windows	ArtPro Classic
New File	Cmd+N	Ctrl+N	
Open File	Cmd+O	Ctrl+O	
Contourize Text	Cmd+Shift+O	Ctrl+Shift+O	
Print	Cmd+P	Ctrl+P	
Place	Cmd+Shift+P	Ctrl+Shift+P	
Place Image Inside	Cmd+Shift+Alt+P	Ctrl+Shift+Alt+P	
Page Boxes Setup	Cmd+Alt+P	Ctrl+Alt+P	Cmd+Alt+J
Quit	Cmd+Q	Ctrl+Q	
Show / Hide Crosshair	Cmd+R	Ctrl+R	
Save	Cmd+S	Ctrl+S	
Save As	Cmd+Shift+S	Ctrl+Shift+S	
Screening window	Cmd+Alt+S	Ctrl+Alt+S	
Update Trapping Layer	Cmd+T	Ctrl+T	
Trapping dialog	Cmd+Alt+T	Ctrl+Alt+T	
Spread / Choke	Cmd+Shift+T	Ctrl+Shift+T	Cmd+0
Export Gravure Tiff	Cmd+Alt+T	Ctrl+Alt+T	
Convert Outlines to Text	Cmd+Shift+Alt+T	Ctrl+Shift+Alt+T	
Select Same / Advanced	Cmd+U	Ctrl+U	Cmd+Alt+U
Paste	Cmd+V	Ctrl+V	
Paste with Layer Structure	Cmd+Shift+V	Ctrl+Shift+V	
Close File	Cmd+W	Ctrl+W	
Close All Files	Cmd+Alt+W	Ctrl+Alt+W	
White Underprint	Cmd+Shift+W	Ctrl+Shift+W	
Cut	Cmd+X	Ctrl+X	
Switch to Preview / Outline	Cmd+Y	Ctrl+Y	
Color Managed Preview	Cmd+Alt+Y	Ctrl+Alt+Y	
Undo	Cmd+Z	Ctrl+Z	
Redo	Cmd+Shift+Z	Ctrl+Shift+Z	
Fit in Window / Previous	Cmd+0	Ctrl+0	Cmd+F
Zoom to Selection	Cmd+Alt+0	Ctrl+Alt+0	Cmd+Shift+F
Actual Size / Previous	Cmd+1	Ctrl+1	
Synchronize Views	Cmd+Alt+1	Ctrl+Alt+1	

Shortcut	Mac	Windows	ArtPro Classic
Lock	Cmd+2	Ctrl+2	Cmd+7
Unlock All	Cmd+Alt+2	Ctrl+Alt+2	Cmd+8
Hide	Cmd+3	Ctrl+3	
Show All	Cmd+Alt+3	Ctrl+Alt+3	
Bring to Front	Cmd+5	Ctrl+5	
Bring Forward	Cmd+Alt+5	Ctrl+Alt+5	
Send Backward	Cmd+Alt+6	Ctrl+Alt+6	
Send to Back	Cmd+6	Ctrl+6	
Make Clipping Mask	Cmd+7	Ctrl+7	Cmd+2
Release Clipping Mask	Cmd+Alt+7	Ctrl+Alt+7	Cmd+Alt+2
Make Compound	Cmd+9	Ctrl+9	Cmd+G
Release Compound	Cmd+Alt+9	Ctrl+Alt+9	Cmd+U
Zoom in	Cmd++ (plus)	Ctrl++ (plus)	
Zoom out	Cmd+- (minus)	Ctrl+- (minus)	
Rotate View Clockwise	Cmd+Shift++ (plus numeric keypad)	Ctrl+Shift++ (plus)	
Rotate View Counterclockwise	Cmd+Shift+- (minus)	Ctrl+Shift+- (minus)	
Select Next Object	Ctrl+Tab	Ctrl+Tab	
Select Previous Object	Ctrl+Shift+Tab	Ctrl+Shift+Tab	
Cycle through document windows	Cmd+`	Alt+Tab	
Go to First Page	Cmd + Arrow Up	Ctrl + Arrow Up	
Go to Previous Page	Page Up	Page Up	
Go to Next Page	Page Down	Page Down	
Go to Last Page	Cmd + Page Down	Ctrl + Page Down	
Show all separations	0	0	
Show single separation	1 to 9	1 to 9	
Object Select	A	A	
Dimensions / Densities	D	D	
Transform/Align & Distribute	E	E	
Pan	H	H	
Lasso Select	L	L	

Shortcut	Mac	Windows	ArtPro Classic
Create & Edit Path tool/ Split and Retrace tool/ Cut Path Tool	P	P	
Crosshair tool / Cut on Crosshair tool	R	R	
Create Rectangle / Create Ellipse	S	S	
Text tool	T	T	
Group Select tool / Object Select tool / Path Select tool / Lasso Select Tool	V	V	
Zoom tool / Pan tool	Z	Z	
Switch between tabs	Cmd+/ 	Ctrl+/ 	

**Note:** For shortcuts with digits (e.g. Cmd+6) it is advised to use the keys from the numeric keypad.

**Note:** Shortcuts that only apply if a specific function or tool is used are not mentioned in this list.

### 2.1.6. Modifier keys

Modifier Shortcuts only have effect as long as the key (or key combination) is held. Releasing the key will return to the previously selected tool.

These allow to quickly and temporarily switch from one tool to another.

Modifier	Mac	Windows
Zoom In Modifier See <a href="#">Zoom tool</a> on page 74	Space+Cmd	Space+Ctrl
Zoom Out Modifier See <a href="#">Zoom tool</a> on page 74	Space+Alt+Cmd	Space+Alt+Ctrl
Zoom in/out using the scroll wheel of your mouse	Alt	Alt
Select Modifier <ul style="list-style-type: none"> <li>activates <b>Group Select</b> if <b>Object Select</b> is active, and vice versa</li> <li>If another tool is active, the last used Select tool is activated</li> </ul>	Cmd	Ctrl

Modifier	Mac	Windows
Pan Modifier See <a href="#">Pan tool</a> on page 74	Space	Space
Crosshair Modifier	Cmd+Alt	Ctrl+Alt
<p><b>Note:</b> When using the Crosshair Modifier, you can't rotate the Crosshair, nor can you nudge the Crosshair using the arrow keys: the Crosshair will snap to the selection or to the page box.</p>		
See <a href="#">The Crosshair</a> on page 75		
Transform tool:	Shift	Shift
<ul style="list-style-type: none"> <li>• Move: constrain position</li> <li>• Scale: Proportional Scaling</li> <li>• Rotate: constrain rotation angle to multiples of 45 degrees</li> </ul>		
Transform tool:	Alt	Alt
<ul style="list-style-type: none"> <li>• Move: copy</li> <li>• Rotate: rotate around the object's center</li> </ul>		

## 2.2. Preferences

---

You can open the Preferences in two ways:

- By selecting **ArtPro+ > Preferences** (Mac) or **Edit > Options** (Windows).
- By its shortcut **Cmd+,** (Mac) or **Ctrl+K** (Windows).

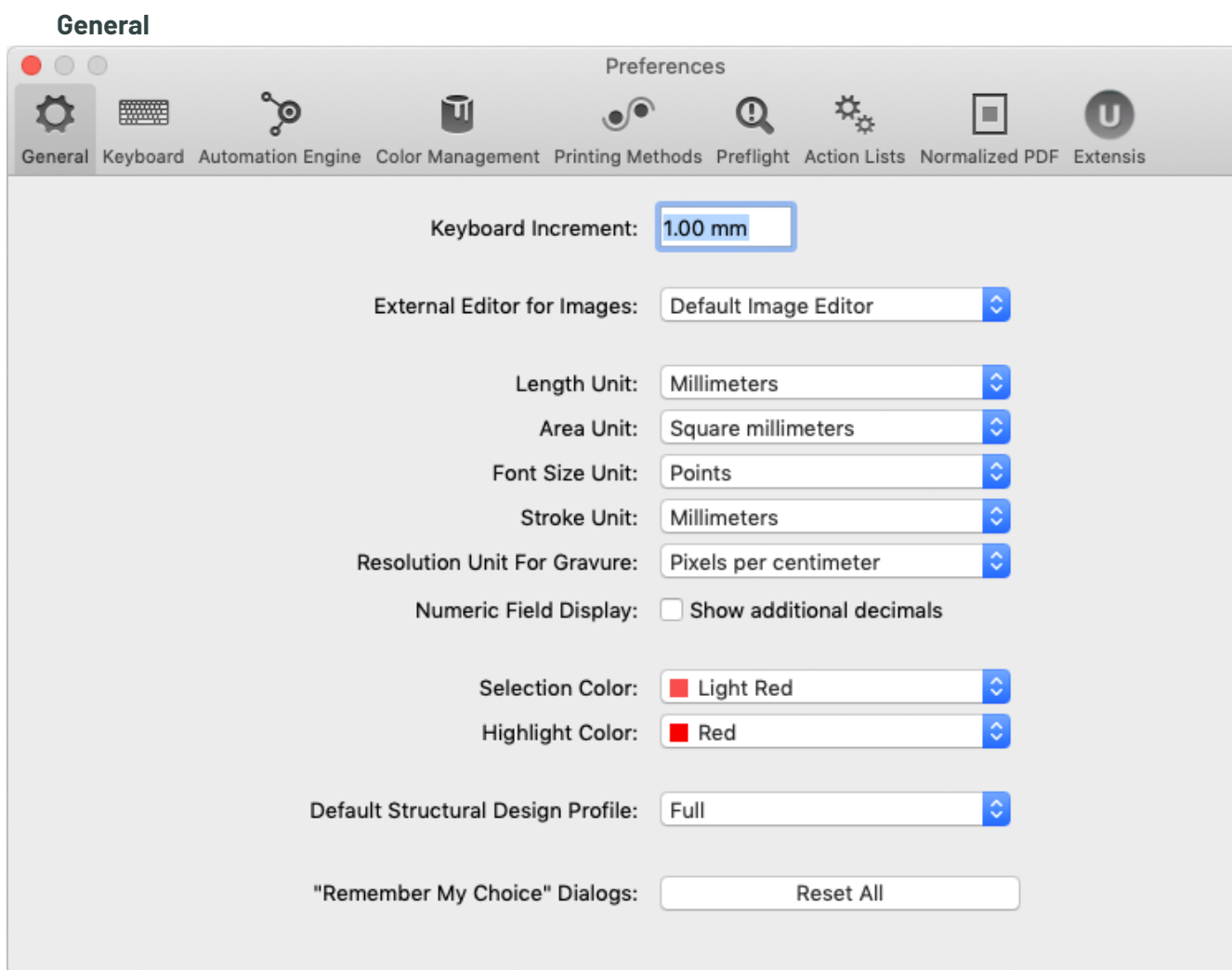

- **Keyboard Increment:** the distance used when moving by using the Arrow keys, e.g. to move the crosshair or selected objects. The value can be entered in any of the supported units. Holding the Shift key while nudging will move the crosshair or selected objects over 10 times the Keyboard Increment distance.
- Define the **External Editor** to be used when opening an image in an external editor. When set to **Default Image Editor**, ArtPro+ will open images for editing in the latest version of Adobe Photoshop that it can find on your computer. If no Photoshop is found, it will use the system's default application for editing images. By selecting **Other...**, you can browse to and select another application. See [Opening images in an external editor](#) on page 169
- **Units:** the default unit to use for **Length, Area, Font, Stroke** and **Resolution for Gravure**. For Length, Font and Stroke the different units you can choose from are millimeter, centimeter, inch or points. For Area, the different units you can choose from are millimeter<sup>2</sup>, centimeter<sup>2</sup>, decimeter<sup>2</sup>, meter<sup>2</sup> or inch<sup>2</sup>. For Resolution for Gravure, you can choose from Pixels per inch, Pixels per cm and Pixels per mm.
- **Numeric Field Display: Show Additional Decimals** increases the amount of decimals shown in Numeric Fields: input fields, dimensions, .... By default ArtPro+ shows a number of decimals depending on the selected unit (e.g. 2 decimals for mm, 3 decimals for inch, ...). Enabling this option increases this number (e.g. 4 decimals for mm, 6 decimals for inch). Note that this does not influence the internal accuracy, it is merely a rounding applied on the values as shown.
- **Selection Color:** the color used to indicate what objects are selected.

- **Highlight Color:** the color used when objects or areas are highlighted, e.g. when using Total Area Coverage, Breakout or when in Trapping mode.
- **Default Structural Design Profile:** the default Profile to use when placing a Structural Design file. See [Structural Design Inspector](#) on page 181
- **"Remember My Choice" Dialogs:** A number of settings in specific dialogs can be stored by enabling the **Remember my Choice** option. See for example the dialog below.

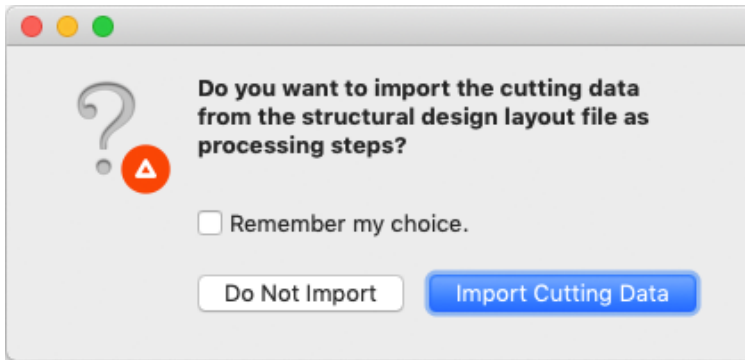

By clicking the **Reset All** button, ArtPro+ will "forget" all these settings, so the next time you will be asked the question again.

### Keyboard

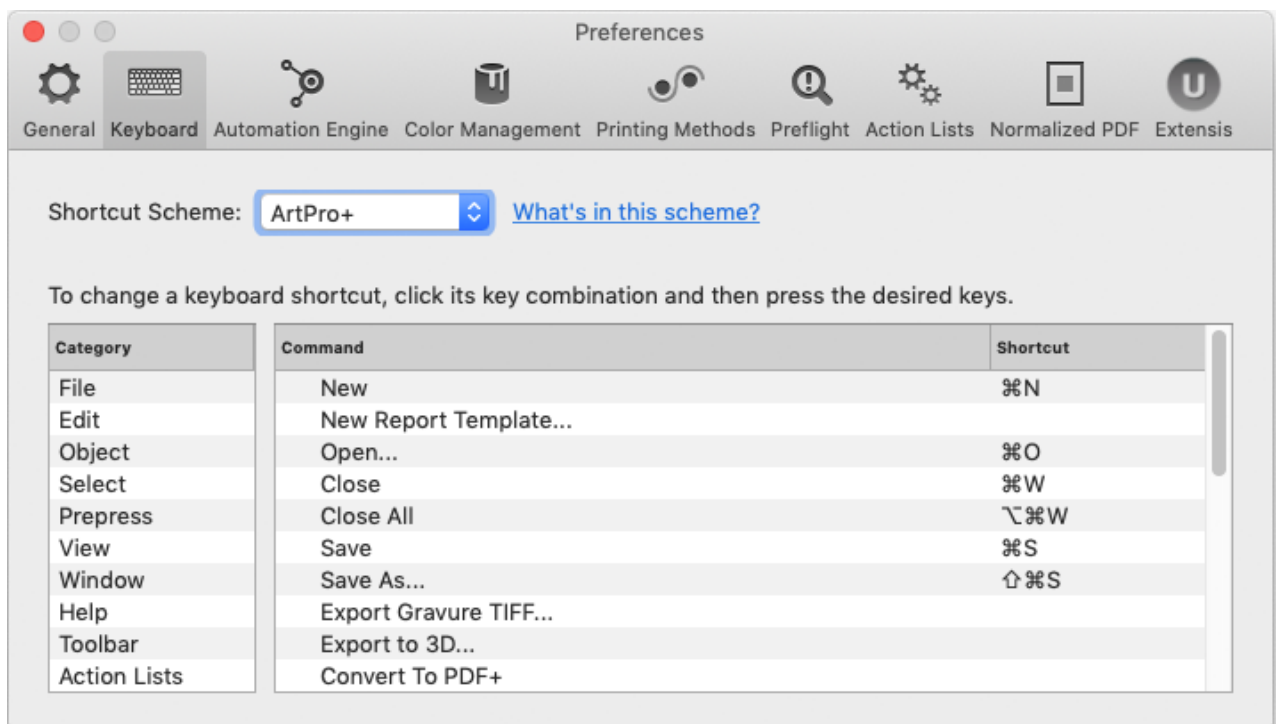

- Select the set of **Shortcut Scheme** you want to use: either the default **ArtPro+** shortcuts, or **ArtPro Classic**, a set of shortcuts similar to the shortcuts in ArtPro. Menu items and shortcuts are changed immediately. Click the **What's in this scheme** link to see an overview of the differences. See [Shortcuts overview](#) on page 39.

- You can change, remove or add a shortcut in the list below.
  - Select the **Category** of function or command you want to change
  - For the function you want to change, double-click the **Shortcut** area.
  - Click the **x** button to remove the shortcut, or press the shortcut you want to use for that function.
  - Custom keyboard shortcuts must include at least one modifier key or function key.
  - If the shortcut you entered is already assigned to another function, both functions will show an exclamation mark. Resolve this conflict as soon as possible.
  - A number of keyboard shortcuts are fixed by the operating system, and can't be changed. For example Cmd+Q on Mac, or Alt+F4 on Windows. In case you try to set such a keyboard shortcut, a warning will be shown. Click the link in the warning message to see all non-editable shortcuts for your operating system.
  - The scheme will become "Customized". If you change the scheme to ArtPro+ or ArtPro Classic, custom keyboard shortcuts will be discarded.

**Note:** When working on Mac OS, make sure you enable the setting **Use F1, F2, etc. keys as standard function keys** in the **Keyboard** section of your **System Preferences** if you want to use the Function keys in custom shortcuts.

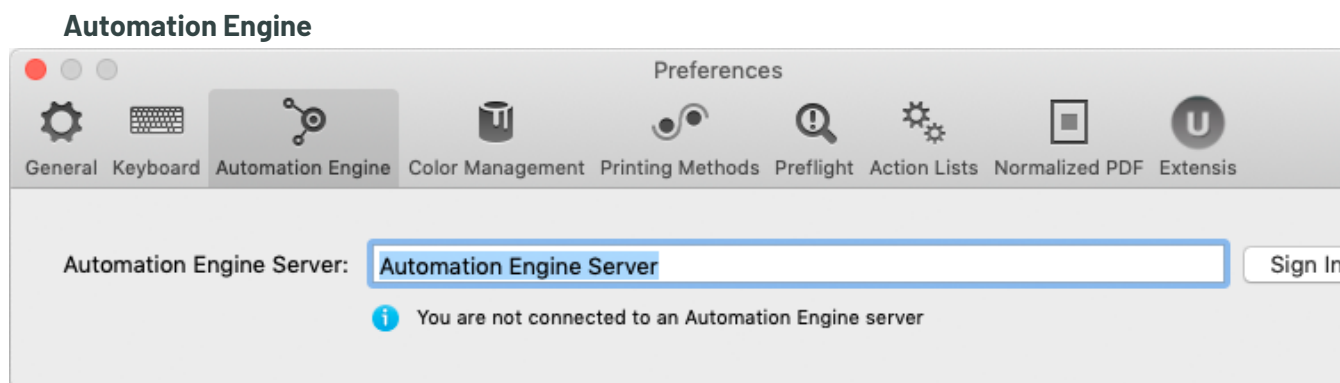

In the **Automation Engine** tab you can set and manage your connection to an Automation Engine server.

For more information on working with an Automation Engine connection, see [Automation Engine connection](#) on page 61

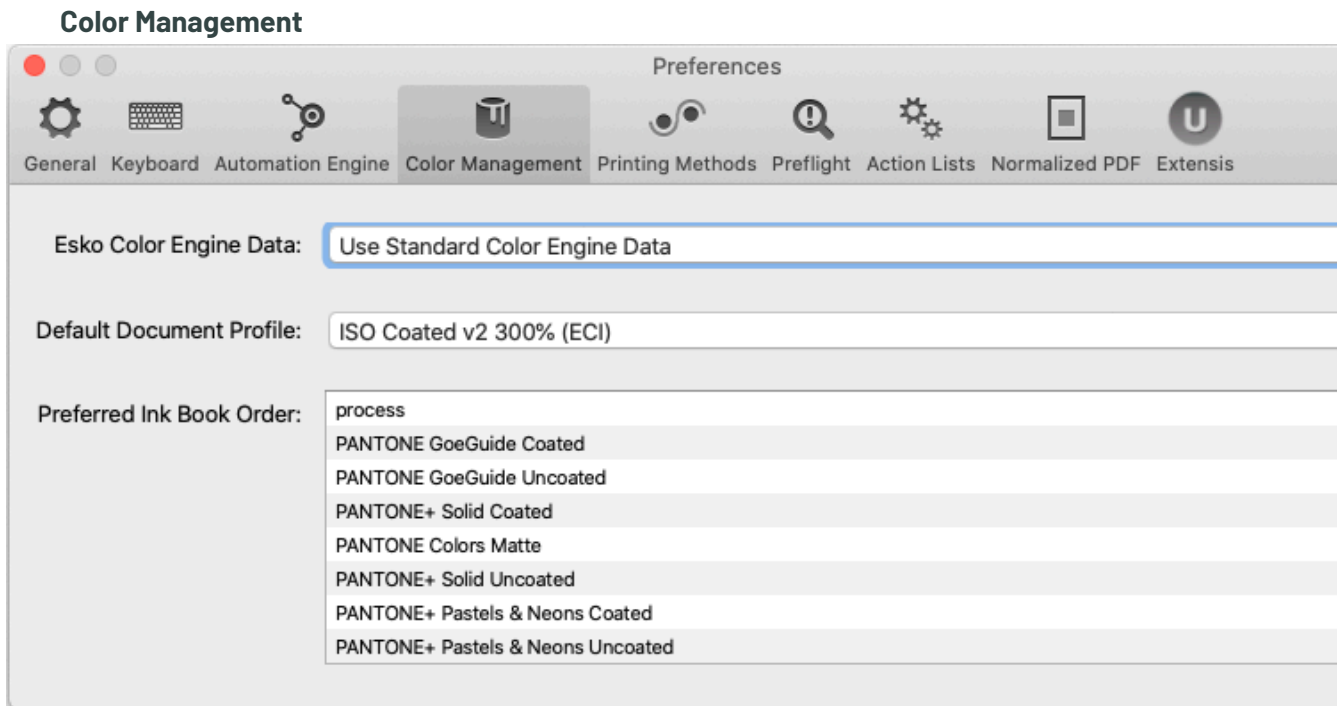

**Color Engine Data:** by default, ink books are read from the Standard Color Engine Data, installed when installing ArtPro+.

By selecting **From Automation Engine**, the CMS from the Automation Engine you're connected to will be used. If this is an Automation Engine SaaS server, the Color Data from the Automation Engine will be synced when ArtPro+ is launched.

By selecting **Other...**, you can browse to a CMS tree on a remote computer (e.g. from PackEdge, Automation Engine or Color Engine) and use those ink books instead. If connection to this remote computer is lost, a warning will be shown, and the local CMS is used again.

**Note:** Although the preview can change, changing the CMS (and ink books) doesn't change the ink information saved in the file for existing inks. The new ink books are only used when creating a new ink or changing an existing ink.

The **Default Document Profile** is used for rendering the document when Color Managed Preview is on and the Document does not have a profile yet. It is also added as output intent to PDF+ files that do not have a Document Profile yet. See [Color Management](#) on page 77

The **Preferred Ink Book Order** section of the Preferences lets you set up the order of the available Ink Books. When creating a new ink, or modifying an existing ink, ArtPro+ will suggest inks based on what you type in the input field. The results will be ordered based on the order of the Ink Books in the Preferences. See also [Adding or changing a separation](#) on page 103

You can change the order of the Ink Books by simply dragging and dropping them.

## Printing Methods



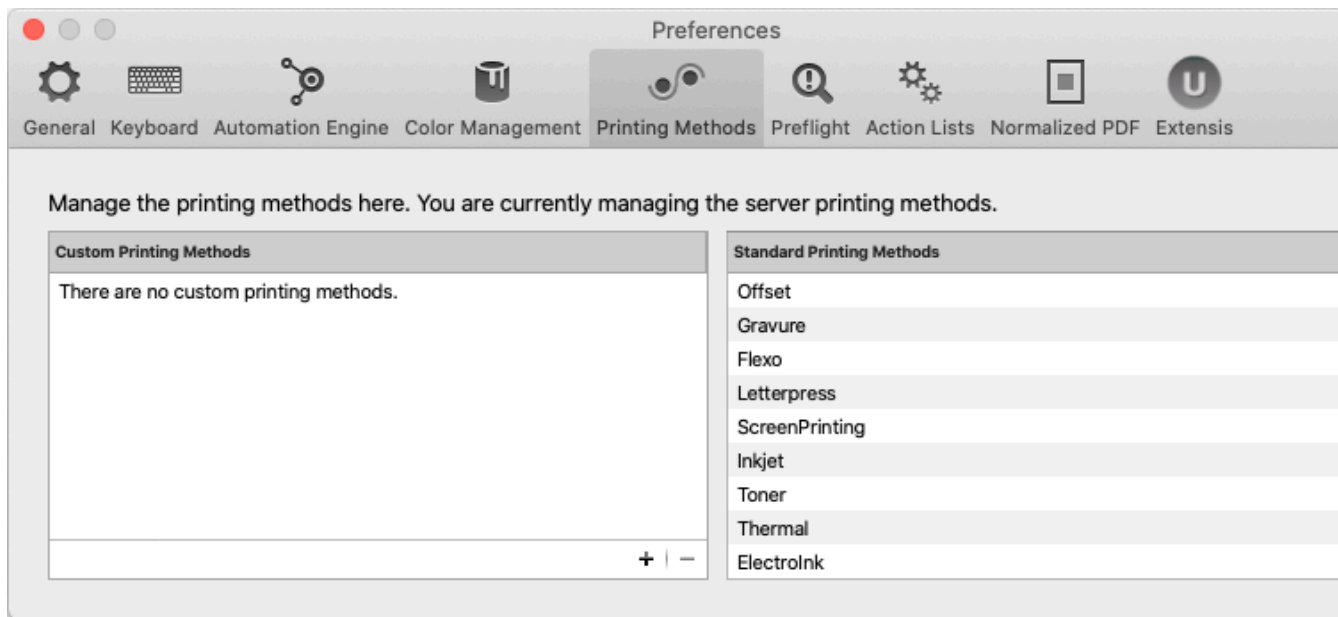

In this tab you can manage the Printing Methods available in the Separations Setup. See [Separations Setup](#) on page 104.

If you are connected to an Automation Engine server, you will see and manage the server printing methods. If you are not connected to an Automation Engine server, you can see and manage the local printing methods, stored on your computer.

You can click the + button to add a custom printing method, or click the - button to remove the selected custom printing method. The Printing Methods defined here are available in the dropdown in the Separations Setup, along with the default Printing Methods as shown in the right column.

**Preflight**

In this tab you can manage your Preflight Profiles. See [Manage Preflight Profiles](#) on page 265

**Action Lists**

In this tab you can manage your Action Lists. See [Action Lists](#) on page 326

**Normalized PDF**

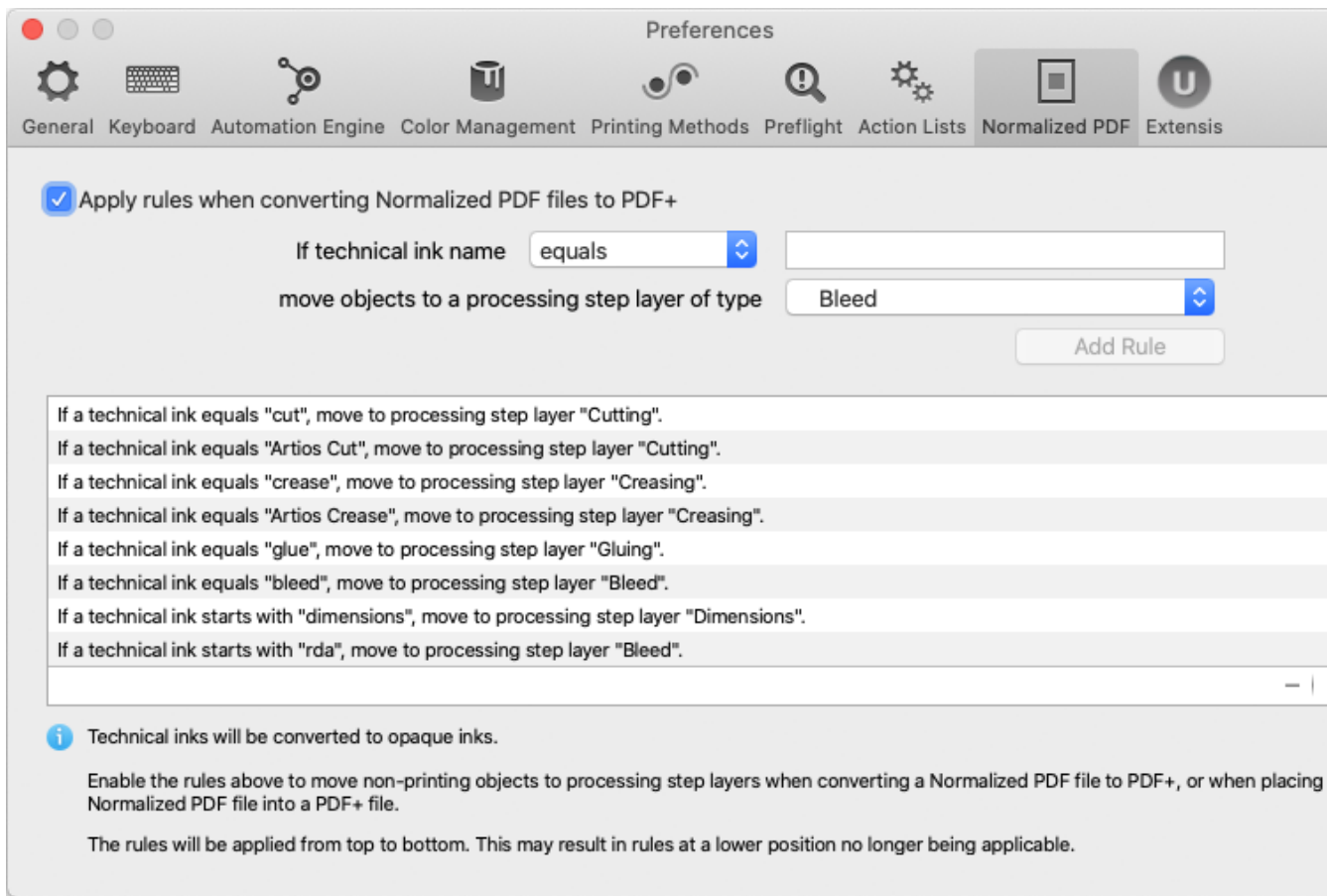

Normalized PDF does not support Processing Step Layers, while PDF+ does not support technical inks. Therefore, when placing a Normalized PDF file in a PDF+ file or when converting a Normalized PDF to PDF+, you can map specific technical inks to specific Processing Step Layers. You can manage rules in the **Normalized PDF** section in the **Preferences**. The defined rules are applied if the **Apply rules when converting Normalized PDF files to PDF+** option is enabled.

**Note:** Placing a PDF is currently only possible in a PDF+, not in a Normalized PDF.

You can add a rule:

- Define the technical ink you want to use, based on the exact name or a part of the ink name (equal, starts with or contains)
- Define to what Processing Step layer the objects should be moved to
- Click **Add Rule**

Select a rule and click the minus button to remove the rule.

From the fly-out menu, you can save the rules to your Automation Engine, or you can load the rules saved on the Automation Engine Server you're connected to. The location of the XML file containing the saved rules is <your server>\bg\_data\_custom\_v010\dat\PDF rules.

**Note:** The rules will be applied from top to bottom. This may result in rules at a lower position no longer being applicable.

For more information on placing Normalized PDF files, see [Placing Normalized PDF files in a PDF+ file](#) on page 174. For more information on converting a Normalized PDF file to PDF+, see [Convert to PDF+](#) on page 54

### Extensis

In this tab you can set the use of Extensis Universal Type Client. See [Extensis Universal Type Client](#) on page 160

## 2.3. Quitting ArtPro+

---

You can quit the application in two ways:

- By selecting **File > Quit** (Mac) or **File > Exit** (Windows).
- By its shortcut **Cmd+Q** (Mac) or **Ctrl+Q** (Windows)
- By using **Alt-F4** or the red cross button to close the last document window on Windows.

### 3. Working with files

#### 3.1. PDF, PDF+ and Normalized PDF

In ArtPro+, your open file can be a PDF+ file or a Normalized PDF file. If your current file is a Normalized PDF file, this will be indicated behind the name of the file in the window title. The file type depends on the file you open.

If you open ...	the document will be...
a Normalized PDF file or PDFPIa file	Normalized PDF
an ArtPro file (exception: see below)	Normalized PDF
an ArtPro file that can't be converted to Normalized PDF, e.g. because of unsupported objects such as placed standard PDF files, placed EPS, PS or RGB images	PDF+
a regular PDF	PDF+
a new document	PDF+
an ARD, MFG or CF2 file	PDF+
an Image file	PDF+

When you save your document in ArtPro+, Normalized PDF will be saved as Normalized PDF, while PDF+ is saved as PDF+. If a PDF file becomes a PDF+ file, this only means additional information can be stored in the file. No conversion is done.

**Note:** Strictly spoken, a regular PDF, ARD file, CF2 file or Image file doesn't become a PDF+ file until you save it. However, since it follows the specifications and behavior of PDF+ files, we consider the open document to be a PDF+ file.

You can convert a Normalized PDF to a PDF+ file using **Convert to PDF+**. This will convert Normalized PDF information, and PDF+ features become available. See [Convert to PDF+](#) on page 54

There is no way to convert a PDF+ file to Normalized PDF.

#### What is the difference between regular PDF, PDF+, and Normalized PDF

Both PDF+ and Normalized PDF are to a large extent regular PDF files that you can open and edit in any other PDF editor or reader. However, PDF+ and Normalized PDF files also contain additional information, available to any Normalized PDF or PDF+ compatible editor. Both file formats also implement specific limitations and specifications.

What	PDF+	Normalized PDF
Ink order stored in file	✓	✓

What	PDF+	Normalized PDF
Non-printing data (Cut, Die, ...) and special processing steps (varnish, ...)	Processing Step Layers	Technical Inks & Varnish
Ink Types	Normal, Opaque	Normal, Opaque, Technical, Varnish
Document Profile as output intent	Obligated. If none is present, the default profile will automatically be added when saving.	
Screening	Optional object based screening	Default screening is applied to all unscreened objects when saving.
Crosshair position	Saved in file	✗
Group and Barcode metadata	✓	✓
Marks	PDF+ Marks can be applied in ArtPro+	✗ ArtPro+ does not support SmartMarks
Images	Images can be <ul style="list-style-type: none"> <li>• <b>Embedded</b></li> <li>• <b>Linked &amp; Embedded.</b> If a PDF + file contains image links, a full resolution embedded version of the image will still be saved in the file.</li> </ul>	Images can be <ul style="list-style-type: none"> <li>• <b>Embedded</b></li> <li>• <b>Linked</b></li> </ul>
Placed Art (PDF)	✓ <ul style="list-style-type: none"> <li>• If the Placed Art is Normalized PDF, it is always embedded.</li> <li>• When placing a Normalized PDF, you can map Technical Inks to specific Processing Step Layers.</li> </ul>	✗ <b>Note:</b> If you open a Normalized PDF containing Placed Art, this will be recognized and kept with limited editability.
Structural Design	✓	✓ Limited to one Structural Design file, and always using the default Profile
Preflight	Checks and Fixes	Only Checks, no Fixes.

### When working with PDF+ files...

- When opening a PDF+ file that contains linked images or linked Placed Art that can't be found, you can choose to browse for them, unlink them or continue to open the file while ignoring the broken link for now.
- When opening a PDF+ file that contains an out-of-date linked image or Placed Art (the embedded version doesn't match the linked version), you can choose to update the embedded version to the linked version, to unlink and keep using the embedded version, or to continue opening the file while ignoring the out-of-date images for now.

### When working with Normalized PDF files...

- You will not be able to save the **Page Boxes** setup as long as any errors have not been resolved.
- Dimensions and position for each page box need to be the same for all pages of a Normalized PDF, so if e.g. a trim box is changed on page 1, it is changed on all other pages; if a bleed box is added to page 2, it is added on all other pages.
- All missing links have to be resolved for the file to be opened
- All objects have to be screened

## 3.1.1. Convert to PDF+

When your current document is a Normalized PDF file (indicated behind the name of the file in the window title) you can use **File > Convert to PDF+** to convert your document into a PDF+ file.

During this conversion, several changes are made to the document:

- Technical Inks become opaque inks.
- Protected objects, such as unsupported barcodes, Dynamic Marks, smart text, are expanded. See also [Protected objects](#) on page 138
- Barcodes are regenerated. When a barcode had live text in a font not available on the system, OCR-B will be used.
- The default Color Profile is added as Document Profile. An existing profile is kept when it is a supported format.
- All Normalized PDF XMP data is removed.
- If a linked Normalized PDF is placed in the file, the linked file will be embedded.
- If a linked non-Normalized PDF file is placed in the file, the linked PDF is kept as linked placed art.
- If a supported Structural Design file is linked in the file (ARD, CF2), the link to the structural design file is kept.
- If a missing or unsupported Structural Design file is linked in the document (ZAE, DAE, BAG, DXF, DDES, VLM, ...), the structural design object will be expanded.
- If the Normalized PDF contains links to unsupported images (EPS, DCS, ...), the conversion to PDF+ will fail.

Saving the document after the conversion will automatically be a "Save As", to avoid overwriting the original Normalized PDF file.

As soon as your document has been successfully converted to PDF+, the Normalized PDF indication behind the file name will disappear, and all PDF+ features will become available. You will e.g. be able to add Dynamic Marks, use Processing Steps, apply Preflight with fixes, etc.

For more information on the difference between Normalized PDF and PDF+, see [PDF, PDF+ and Normalized PDF](#) on page 52

## 3.2. New File

---

**File > New** or its shortcut **Cmd+N** (Mac) or **Ctrl+N** (Windows) will create a new empty document.

The Media box and Trim box will have the same size as the Media box and Trim box of the last opened document.

If you save such a new document, it will be saved in PDF+ format. See [PDF, PDF+ and Normalized PDF](#) on page 52.

If you have multiple documents open, you can choose **File > Close All** or the shortcut **Cmd + Alt + W** (Mac) or **Ctrl + Alt + W** to close all documents.

If you have multiple documents open, you can choose **File > Close All** or the shortcut **Cmd + Alt + W** (Mac) or **Ctrl + Alt + W** to close all documents.

## 3.3. Open Files

---

You can open a file in different ways:

- By selecting **File > Open**, and browsing to the file you want to open.
- By its shortcut **Cmd+O** (Mac) or **Ctrl+O** (Windows), and browsing to the file you want to open.
- By dragging and dropping a supported file onto the already opened document in the application window, or on the dock icon (Mac only).

ArtPro+ can open PDF and PDF+ files, Normalized PDF files (including PDFPlA files) and ArtPro files. If the opened file is a Normalized PDF or an ArtPro file (opened as Normalized PDF, see below), this will be indicated behind the name of the file in the window title. See [PDF, PDF+ and Normalized PDF](#) on page 52.

When opening a file that contains linked images or placed PDF files that can't be found, you will get the possibility to browse for them. For Normalized PDFs and ArtPro files, clicking **Cancel** will cancel the Open action. For PDF+ files, you will also have the option to unlink or continue without relinking.

### Notes on opening files

- By default files are opened in the same window size as the last closed document. All artwork (including artwork outside the media box) and page boxes are fit in the window. By default, page boxes are hidden.
- If a file takes longer than a second to load, a busy indicator is shown (spinning wheel). Other actions can still be performed while the file is loading.

### Opening ArtPro files:

- When opening an ArtPro file in ArtPro+, it is opened (and saved) as a Normalized PDF. However, if conversion to Normalized PDF is not possible, e.g. because of unsupported objects such as placed standard PDF files, placed EPS, PS or RGB images, the file will be converted to and saved as a PDF+ file.
- When opening an ArtPro file as a Normalized PDF, images in PSD, non-bitmap TIFF and Esko CT format that were placed in ArtPro ("Place Picture") will be linked. Also, images that were linked in

the ArtPro file as a result of importing a Normalized PDF file with the Keep Esko Links option will remain linked. All other images will be embedded.

- Colors shown in ArtPro+ match the proofer colors of the separations. Display colors set in ArtPro are disregarded.
- ArtLink values are not updated.

### Opening image files or Structural Design files (ARD, CF2)

If you set the dropdown at the bottom of the File Open dialog to "All supported images" or "All supported Structural Design files", you can also open certain image files or Structural Design files (.ARD or one-up .CF2). This will result in an empty document, with the selected image file or Structural Design file placed. The size of the document will be the size of the image or Structural Design file.

See [Place](#) on page 164 for more information on placing image files, or [Place Structural Design](#) on page 180 for more information on placing Structural Design files.

### Opening an MFG file or a Layout CF2 file

If you set the dropdown at the bottom of the File Open dialog to "All supported Structural Design files", you can open an ArtiosCAD MFG or a Step&Repeat CF2 file. See [Step & Repeat based on an MFG or CF2 file](#) on page 278

**Note:** Opening an MFG file or a Layout CF2 file requires an ArtPro+ Advanced license.

## 3.3.1. Missing and out-of-date files

When opening a file containing linked files (images, placed PDF files or Structural Design files), ArtPro+ will try to find the linked file.

If the file you open is a PDF+ file, the file contains both a link and an embedded version of the placed image, PDF or Structural Design File. ArtPro+ will then also check if the embedded version matches the linked file.

For more information on:

- Images, see [Working with images](#) on page 164
- Placed PDF files, see [Working with Placed Art](#) on page 173
- Structural Design files, see [Working with Structural Design files](#) on page 180

### When working with a PDF+ file

In case placed files are not up to date or can't be found, you will get a warning, indicating which files can't be found, or for which files the embedded version doesn't match the linked version.

You can then choose how to handle these files:

- Click **Unlink** to remove the link to the files on disk, and keep using the embedded version.
- Click **Ignore** to use the embedded version of the files but remember the link. You can use this option e.g. if the linked file is temporarily unavailable.
- Click **Browse** to browse to the missing linked files.
- Click **Update** to update the outdated embedded version.
- If there are both missing links and out-of-date embedded versions, you can click **Browse And Update** to combine both.

This check is only done on the current page. This means that when navigating to a different page ArtPro+ will check for missing or out of sync placed files, and another message might be shown.



### When working with a Normalized PDF file

When opening a Normalized PDF file with links, the file doesn't contain an embedded version, so the external image or PDF file will be opened. In case the file can't be found, the link must be resolved for the Normalized PDF to be opened.

Because of that, the complete document is checked upon opening.

For a Structural Design file, the Normalized PDF contains both a link and embedded outlines, but the Normalized PDF does not contain the information needed to check whether the embedded version is in sync with the linked version. When opening the Normalized PDF, the embedded version is used, without any warning about the Structural Design file being missing or out of date. You can still manually browse and update the structural design file.

## 3.4. Open Recent

---

You can open one of the 10 most recently opened files by choosing it from the list in **File > Open Recent**.

If you try to open a file from this list that is no longer available (because it was removed, renamed, or an external drive is currently not available) you will be warned about this.

Selecting **Clear Menu** clears all items from the Open Recent list.

## 3.5. Close Files

---

You can close a file:

- By selecting **File > Close**
- By using the shortcut **Cmd+W** (Mac) or **Ctrl+W** (Windows)
- By clicking the top left red button (Mac) or top right red cross (Windows)
- By using **Alt+F4** (Windows)

**Note:** On Windows, when using **Alt+F4** or the top right red cross to close the last document window, this will also quit ArtPro+

If you have multiple documents open, you can choose **File > Close All** or the shortcut **Cmd + Alt + W** (Mac) or **Ctrl + Alt + W** to close all documents.

## 3.6. Save Files

---

You can save your document:

- By selecting **File > Save**.
- By its shortcut **Cmd+S** (Mac) or **Ctrl+S** (Windows).

The **Save** function is always available, even when the document hasn't been edited. If a document was edited, this is indicated by a dot in the close button on Mac, or an asterisk next to the document name in the title bar on Windows.

**Note:** If an ArtPro file or PDFPIa file was opened, the **Save** function will save the document as a (Normalized) PDF file, next to the original file, with "(imported)" added to the file name.

Another option to save the document, is the **Save as** function, allowing you to save the document with a new name and/or different location:

- By selecting **File > Save as....**
- By its shortcut **Cmd+Shift+S** (Mac) or **Ctrl+Shift+S** (Windows).

ArtPro+ will save Normalized PDF files (i.e. indicated as Normalized PDF next to the file name) as Normalized PDF, and will save other documents (including new documents) as PDF+ files. See [PDF, PDF+ and Normalized PDF](#) on page 52

If you opened an ArtPro file, saving it will write a Normalized PDF file. However, if conversion to Normalized PDF is not possible, e.g. because of unsupported objects such as placed standard PDF files, placed EPS or PS, the file will be converted to and saved as a PDF+.

## 3.7. Export

---

**File > Export to** combines different Export options:

1. Export to PDF. See [Export to PDF](#) on page 58
2. Export to Gravure TIFF. See [Export Gravure TIFF](#) on page 60
3. Export 3D. See [Export 3D](#) on page 348
4. Export Variable Data. See [Export Variable Data](#) on page 365
5. Export to JDF Layout. See [Export to JDF Layout](#) on page 61

Each of these Export options opens the Export dialog, with the corresponding option selected. You can switch to one of the other Export options by selecting it in the list on the left side of the dialog.

### 3.7.1. Export to PDF

Unlike saving the document, the **Export to PDF** function offers you the option to apply an Action List and some other automatic modifications to the exported PDF, while keeping the original document as it is.

1. Select **File > Export To > PDF...**

The Export dialog will open, with **Export to PDF** selected.

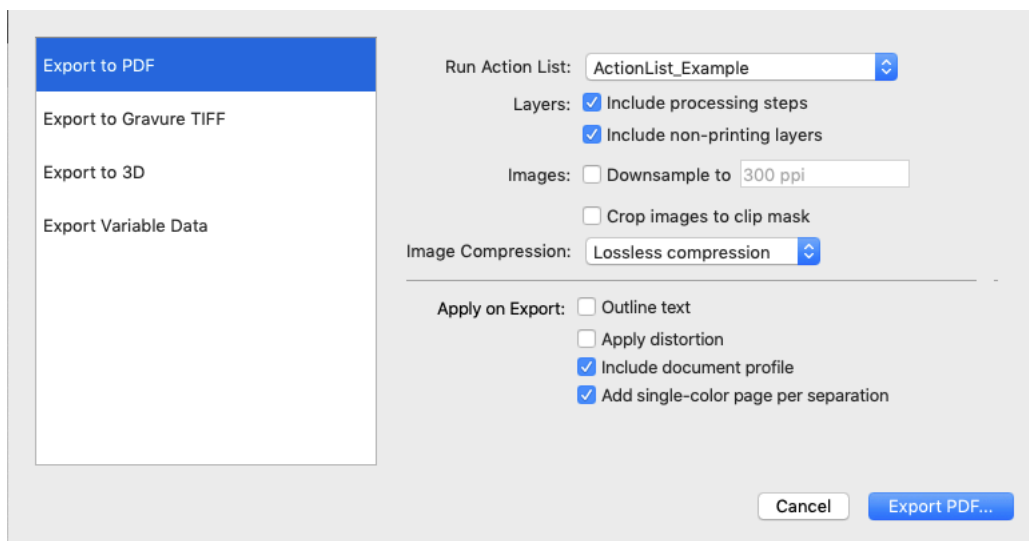

**Note:** You can click one of the other output options on the left to export to another format. See [Export Gravure TIFF](#) on page 60, [Export 3D](#) on page 348 and [Export Variable Data](#) on page 365

- To run an Action List during the export, select it in the **Run Action List** dropdown. The dropdown will show all available Action Lists. See also [Managing Action Lists](#) on page 328

**Note:**

Marks in your document will be expanded in the state they were in before the included Action List was run.

If you want the Marks to take into account the Actions from the Action List, you need to run the Action List before doing the export and not as part of the export.

E.g. if you do a Convert to CMYK as part of the Export, the separations in your Marks will still reflect the original separations. If you only want CMYK separations in the exported PDF, run the Convert to CMYK Action List prior to the export.

- In the **Layers** section you can decide if you want to include Processing Steps and non-printing layers in your exported PDF.
- Images:**
  - Enable **Downsample** to downsample all images to a specified resolution. Bitmap images are excluded and will not be downsampled.
  - If **Crop images to clip mask** is enabled, only the parts of the image within the clip mask are included in the PDF file.
- Set the **Image Compression**: Lossless, Low, Medium or High.
- Outline text** will convert all text to outlines in the exported PDF.
- If **Apply distortion** is enabled, any distortion factor set in the Document Setup of your document will be applied to the exported PDF.
- If **Include Document Profile** is enabled, the used Document Profile will be embedded in the exported PDF. Otherwise, the document profile will no longer be present in the PDF. Note that this can result in a different representation of the colors.

- 9. If **Add single color page per separation** is enabled, the exported PDF will not only contain the document itself, but a single color page is added for every separation.

### 3.7.2. Export Gravure TIFF

Export Gravure Tiff is used to output your document directly as TIFF data for gravure printing. It creates one TIFF file per selected separation, for the current page.

To open Export Gravure TIFF, select **File > Export To > Gravure Tiff...**

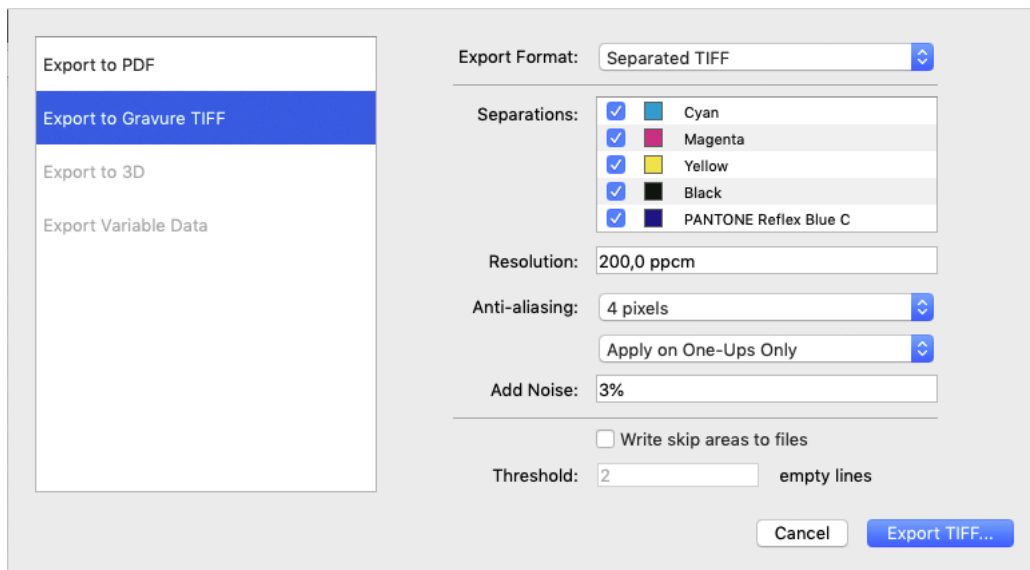

**Note:** You can click one of the other output options on the left to export to another format. See [Export to PDF](#) on page 58, [Export 3D](#) on page 348 and [Export Variable Data](#) on page 365

Select the **Output Format:** TIFF for HELL Job Ticket, HELL Compatible TIFF, or Separated TIFF.

**Separated TIFF** is the generic output. HelioDisk users can use the **HELL Compatible TIFF** output format to ensure the generated TIFF names are compatible with the HELL workflow. If you have a HELL Jobticket, you can use TIFF for HELL Job Ticket, and you can browse for the Job Ticket, so settings (resolution, job size, ...) can be retrieved from the Job Ticket.

**Note:** Since the job size is retrieved from the Job Ticket, an error will be shown if the media box of your document doesn't match the defined job size. You will not be able to export until the media box has been adjusted accordingly.

In the **Separations** list you can define what separations to output. The list shows all separations in the document, and by default unused separations will be enabled. If an empty separation is selected, no output will be generated for that separation.

When using default Separated TIFF output, you can double-click a separation in this list to change the name of the separation as it will be used in the file name for the TIFF, e.g. if you want the file name to be "[filename] C.tiff" instead of "[filename] Cyan.tiff". This doesn't change the actual name of the

separation in the document. When using HELL Compatible TIFF, Separation names can't be renamed, and the TIFF files will be named: [file name]#[separation index], e.g. Job#1.tif, Job#2.tif, etc.

When you are using HELL Job Ticket, only the separations that have a ticket will be selected. You can still deselect separations you don't want to output.

The **Resolution** of the TIFF file is shown in the default unit defined in the Preferences, but can be defined in Pixels per inch (ppi), Pixels per mm (ppmm) or Pixels per cm (ppcm). The entered value will be recalculated to the default unit. See [Preferences](#) on page 44. When using TIFF for HELL Job Ticket, the resolution is defined in the Job Ticket and can't be changed.

**Anti-aliasing** can be set to None, 2, 3 or 4 pixels. The higher the value the smoother the result will be, but it will also increase calculation time and needed disk space.

By default, Anti-aliasing is set to **Apply on One-Ups Only** placed in a Step & Repeat file. To apply anti-aliasing on the other content of the S&R file itself (e.g. station numbers or Marks), you can switch to **Apply on all Contents**.

**Add Noise** allows to add a certain percentage of noise to avoid banding.

If **Write skip areas to files** is enabled, empty areas larger than the **Threshold** will be skipped, and a Skip Areas file (.svs) will be written next to the separation file. Using this information, an engraving machine can skip those areas, increasing the engraving process. When using TIFF for HELL Job Ticket the Skip Areas are saved in the Job Ticket, so this option is not available.

**Note:** Objects in non-printing layers will not be exported, while hidden objects in a printing layer will be.

When using HELL compatible TIFF output, the generated TIFF files will get a fixed rotation of -90°.

When using HELL Job Tickets, the tickets will be updated when writing the TIFF files. Job information, Skip Areas, User History, Histogram and Proof Parameters will be written in the tickets.

### 3.7.3. Export to JDF Layout

Using **Export to JDF Layout** you can export a Step & Repeat file to a JDF file, together with a folder by the same name containing the one-ups and one or more files containing the Marks when present.

If the initial one-ups were Normalized PDFs, they will be converted to PDF+ during **Export to JDF Layout**.

1. Select **File > Export To > JDF Layout...**
2. Set the **JDF JobID** and **JDF JobPartID**
3. Click **Export JDF Layout**

## 3.8. Automation Engine connection

---

To connect your ArtPro+ to an Automation Engine server, you first need to set up the server connection in the **Automation Engine** tab of the **Preferences**.

Open the Preferences, by selecting **ArtPro+ > Preferences** (Mac) or **Edit > Options** (Windows), or by its shortcut **Cmd+,** (Mac) or **Ctrl+K** (Windows), and switch to the **Automation Engine** tab.

You can make a connection to an Automation Engine by entering the **Automation Engine Server** name and clicking the **Sign In** button.

**Note:** If you need to connect to your Automation Engine server over a non-default port, you can specify it here, using the 'servername:portnumber' format, e.g. "AEServer:5183".

The **Sign In** dialog will open. You can use the **Sign In With** dropdown to define how to sign in:

- If you have an internal or Windows user account on Automation Engine, you can sign in with a User Name and Password.
- When available, you can choose to sign in using an identity provider, which will redirect you to the corresponding webpage to enter your credentials

As security is one of the main aspects of using an identity provider, you will be asked to reconfirm the sign-in each time you launch ArtPro+

- If you choose **Yes**, you will be redirected to the web page again.
- If you choose **No**, you will not be signed in and there will not be an active Automation Engine connection until you do sign in.
- If you choose **More Options...** you will be redirected to the Automation Engine Preferences tab.

After signing in, a connection will be made with the server. The **Connect** button will then be replaced by a **Change User** button. If the connection to the Automation Engine Server was lost (e.g. because the server was temporarily unreachable), the button will be replaced by a **Reconnect** button, so you can re-establish the connection.

The toolbar will show a green connection if the connection is up and running . If no connection to the Automation Engine server is available, a red icon is shown. When no Automation Engine is set, the connection icon will be hidden.

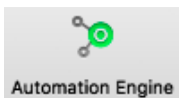

### 3.8.1. Working with an on-premises Automation Engine server

#### Opening and saving files

When you're connected to an on-premises Automation Engine server (so not an Automation Engine SaaS server), you can open and save files directly from and to your Automation Engine Server: the Browse dialog will contain a **Recent Server Places** dropdown, where you can easily select the latest server locations where you opened or saved a file, and a **Search** button, to open the Automation Engine Search window.

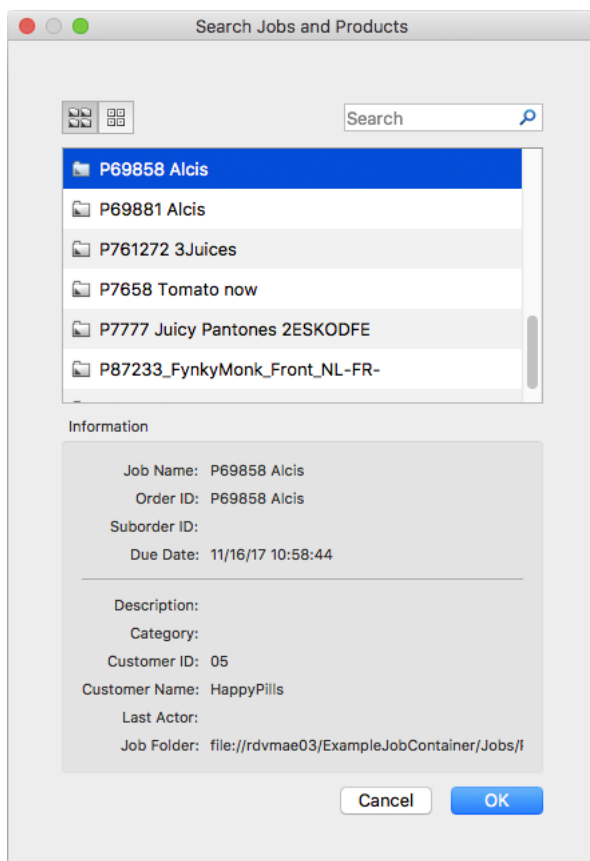

- Use the buttons on top of the window to show Jobs or Products.
- Use the **Search** field to filter Jobs or Products.
- Select a Job or Product to see its details underneath
- Click **OK** to close the Automation Engine Search window, and return to the Browse dialog, which will now automatically show the location of the selected Job or Product.

If an open document resides inside an Automation Engine Job, the job name is displayed next to the name of the document in the title bar of the document.

If you are working on a document from an Automation Engine Job, you can use the barcode parameters defined in the Job Setup. See [Barcode properties from Automation Engine Job Setup](#) on page 233

### Launch Workflow

If you have an active connection to an on-premises Automation Engine server (see [Automation Engine connection](#) on page 61) you can launch your document directly into an Automation Engine workflow.

1. Select **File > Launch Workflow** or use its shortcut **Cmd+L** (Mac) or **Ctrl+L** (Windows).
2. Select the workflow you want to use from the list of public workflows on the Automation Engine you are connected to.
3. Enter any public parameters the workflow requests.
4. Enter a Job ID and Job Part ID. If the file was opened from an Automation Engine job, the Job ID will automatically be entered.
5. Click **Launch**. If the file was modified since the last save, you will be asked to save the file before launching.

6. Check the progress of the launched job using the **Automation Engine Pilot**.

There is currently no Shuttle dialog to show progress of the launched jobs from within ArtPro+.

**Note:** If your Automation Engine is using a non-default port, you will not see any of the workflows listed, unless you've added the port number to the server name in the Preferences. See [Preferences](#) on page 44

### 3.8.2. Working with an Automation Engine SaaS server

#### Opening and saving files

When you're connected to an Automation Engine SaaS server, the Automation Engine Syncer needs to be installed and running. If this is not the case, an error message will be shown in the Automation Engine tab of the Preferences, and as a toast message when ArtPro+ is launched.

The Automation Engine Syncer is part of the Esko Editor Connection Tools installer, which you can find on the Apps & Tools page of your Automation Engine's My Workspace webpage.

#### Browsing for files

When choosing **File > Open**, you will get the Browse window. Using the button at the bottom of the dialog, you can choose:

- **Browse Local Files** (Mac) or **Browse This PC** (Windows) to browse for local files and files on physical shares, the same way as you are used to without an Automation Engine SaaS connection
- **Browse My Workspace** to browse for files on your Automation Engine SaaS server.

The **Browse My Workspace** browser looks very similar to the **My Workspace** webpage. For more information on My Workspace, we refer to the Automation Engine documentation [here](#).

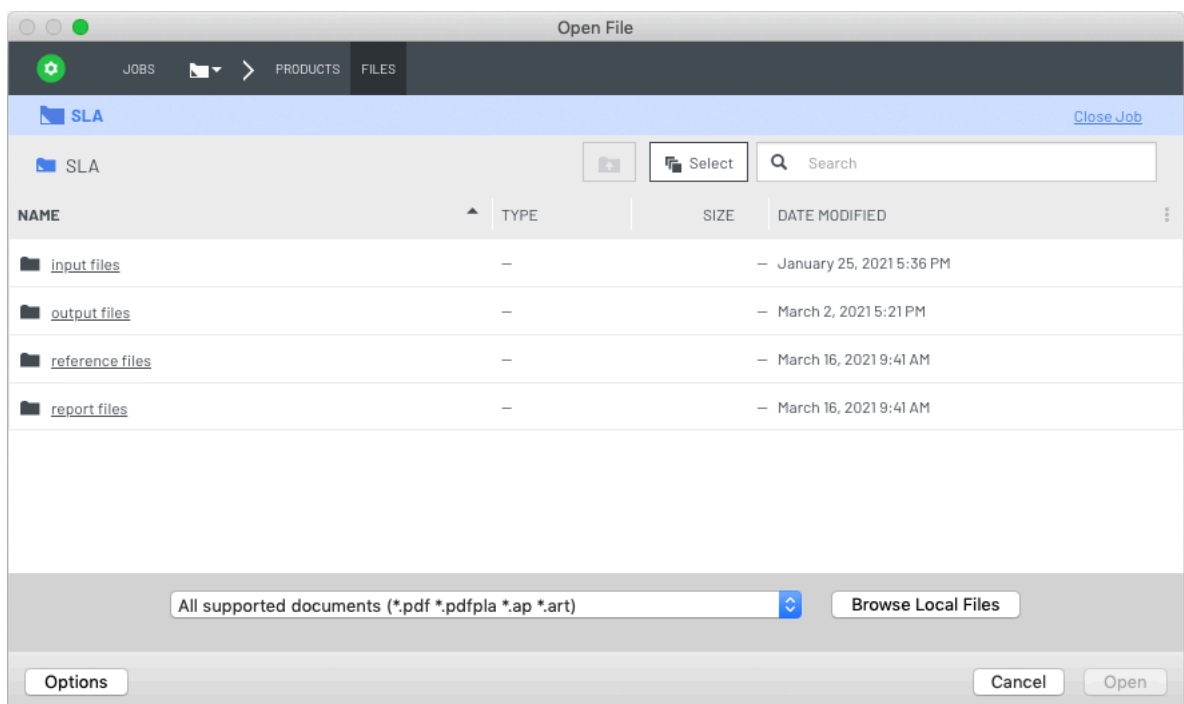

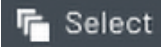

- Open a folder by single clicking the folder name. To select a folder without opening it, click the icon in front of its name or the space behind the folder name
- Open a single file by double-clicking it, selecting it and pressing enter, or clicking the **Open** button.
- To open multiple files, first enable the **Multi-select** button 

**Browse My Workspace** is available for every browse action in ArtPro+ where you have the Jobs and Products Search option in case of a on-premises Automation Engine server connection, such as Open, Place, Replace, Save, Extract, Export, browsing for an Input File or Database, ...

### The Automation Engine Syncer

When opening a file from My Workspace, the **Automation Engine Syncer** will download a copy of the file into the local cache folder.

Related files such as linked images, linked Placed Art, Variable Data External Files, ... will only be downloaded when needed, e.g. when you want to do an **Edit in Editor** of a linked image, or when you are browsing through the records in a **Variable Data Template**.

In case of a folder selection (e.g. Variable Data External File, Set Root Folder, or Export Gravure TIFF, HELL Job ticket or HELL-compatible output), the whole folder is being downloaded.

When saving a file, the Syncer will upload it again to the server.

Resources (PitStop data, Custom data = PDF Action Lists and Marks Data) will be synced whenever the application is launched.

Color data is only synced if a remote CMS tree was set (so when using "from Automation Engine" or having browsed to an "Other" location), not when Standard Color Engine data is being used.

You can force-sync resources during the session by clicking the **Update Server Resources** button in the Automation Engine tab in the Preferences.

For more information on the Automation Engine Syncer, we refer to the Automation Engine documentation [here](#).

### Tips and tricks

- When launching the application, it is advised to keep an eye for two statuses before starting to process files: a toast message that indicates the connection to the Automation Engine SaaS server was established, and the Syncer tray progress icon: as long as it shows a grey icon, resources are still being synced.
- Watch the Syncer tray progress icon when saving files. If you would e.g. save, close and reopen a file too quickly, this could result in trying to download the file while it's being uploaded, and the Syncer may display a synchronisation conflict message.



**Warning:** Do not delete files from the local cache folder. Doing so while the Syncer is running will irreversibly delete the file on the server.

- If an open document resides inside an Automation Engine Job, the job name is displayed next to the name of the document in the title bar of the document.
- If you are working on a document from an Automation Engine Job, you can use the barcode parameters defined in the Job Setup. See [Barcode properties from Automation Engine Job Setup](#) on page 233

### Launch My Workspace

If you have an active connection to an Automation Engine SaaS server, you can select **File > Launch My Workspace....** This will open the My Workspace web page, where you will see the folder in which the current file resides.

You can then choose to **Launch** the file in a workflow there. For more information on My Workspace, we refer to the Automation Engine documentation [here](#).

### My Workspace Activity

If you have an active connection to an Automation Engine SaaS server, you can select **Window > My Workspace Activity ....**

This will open the My Workspace web page, showing the **Activity** view. For more information on My Workspace, we refer to the Automation Engine documentation [here](#).

## 3.9. Report Template

---

Using the **Create PDF Report** task in Automation Engine you can create a Report of a production file.

**Note:** This **Create PDF Report** task is comparable to the older 'Create Report (Reportmaker)' task.

These file reports typically contain a preview of the design and then list all kinds of information related to the job, customer, extensive details of graphics and Structural Design file. It can even be extended to show separations.

A Report is created based on two files:

- a **Report Template**, created in ArtPro+. This file determines what elements (Marks, graphic elements, ...) are included in the Report.
- the production file that is used as **Input file**, the subject of the report.



File name: WarpGetSet  
 Date: 30/11/2018  
 Author: [Wolfgang Pöschl](#)  
 Barcode:

ReportMaker Template  
 by [Wolfgang Pöschl](#)  
 in ArtPro+ 20.0.141 on Mac OS X

<p><b>Separations:</b></p> <p>Cyan 1              Magenta 2              Yellow 3              Black 4              opaque white spot color 5              PANTONE 375 C 6              PANTONE 335 C 7              PANTONE 354 C 8              silver cold foil 9</p> <p><b>Ink Coverage:</b></p> <ul style="list-style-type: none"> <li>● 438.48 mm<sup>2</sup></li> <li>● 130.43 mm<sup>2</sup></li> <li>● 821.95 mm<sup>2</sup></li> <li>● 354.72 mm<sup>2</sup></li> <li>● 1768.73 mm<sup>2</sup></li> <li>● 10664.68 mm<sup>2</sup></li> <li>● 7519.33 mm<sup>2</sup></li> <li>● 362.57 mm<sup>2</sup></li> <li>● 179.22 mm<sup>2</sup></li> </ul>	
--	--

Rules: 120.0,120.0,120.0,120.0,120.0,120.0,120.0,120.0,120.0  
 Angles: 22.5,52.5,7.5,82.5,45.0,45.0,45.0,45.0,45.0

All Marks in the Report Template (including the specific **Input File Mark** - see [Input File Mark](#) on page 68) will resolve to the **Input file**. If for example the Report Template contains a Text Point Mark showing the File Name, this Text Point Mark will show the name of the current **Input File**.

### 3.9.1. Working with a Report Template

1. Create a **Report Template**:
  - start from an empty document by choosing **File > New Report Template**. The empty A4 document will contain one Input File Mark. See [Input File Mark](#) on page 68
  - convert your current document to a Report Template by choosing **File > Convert to Report Template**

**Note:** You can only convert PDF+ files to a Report Template. If you want to convert a Normalized PDF, you should convert it to PDF+ first. See [Convert to PDF+](#) on page 54

2. Select an **Input file**.  
 While creating your Report Template, the selected **Input file** is used to resolve all Marks

**Note:** Since the Input File is embedded in the Report Template file, it is advised to use a small dummy file, containing all separations etc. as needed to set up the Report Template

3. Set up the Report Template. See [Editing a Report Template](#) on page 68
4. Save the Report Template.

- In Automation Engine, use a **Create PDF Report** task to create a Report for a production file (the Input File) based on the Report Template.

### 3.9.2. Editing a Report Template

When editing a Report Template, ArtPro+ will be in "Report Template editing mode"

- The window title will show "(Template)" next to the file name.
- The **Marks** section will be replaced by "Report Marks". See [Report Marks](#) on page 69
- All Marks are resolved to the selected **Input File**. You can change the Input File in the **Report Marks** section.
- In a Report Template you can use the **Input File Mark**, to visualize the Input File. See [Input File Mark](#) on page 68
- You have specific Smart Text variables available. See [Smart Text in a Report Template](#) on page 70
- The Dynamic Marks are in a regular type layer (instead of in a "Legend" layer)

#### Input File Mark

The Input File Mark is a type of Mark that is only available when editing a Report Template. See [Editing a Report Template](#) on page 68

The **Input File Mark** places a representation of the Input File.

You can place different Input File Marks using different settings, e.g. to show a preview of the complete job, a preview of the separations, etc.

**Note:**  
Keep in mind that the Input File is included in the Report Template file. However, placing multiple Input File Marks does not embed the file multiple times.

#### Mark Inspector

Use the **Mark Inspector** to set all parameters.

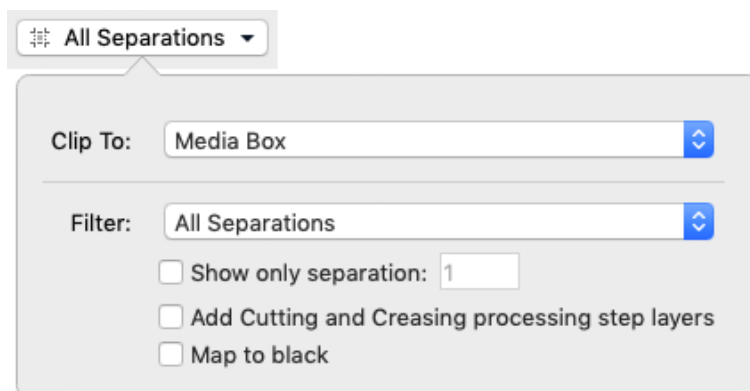

Use the **Clip To** dropdown to define how the Input File should be clipped: to one of the page boxes, or to a named object saved in the Input File.

**Filter:** You can indicate what separations to be included in the Mark:

- All Separations
- Artwork Separations
- Processing Step Separations (See [Processing Step Layers](#) on page 97)
- Artwork Separations and Varnish
- Custom, This allows you to select separations by combining rules on Printing Method, Processing Step, Separation Name, Process Separations or Non-Process Separations.

Enable **Show only separation [#]** to show only one specific separation. You define what separation to show by entering the index number. Note that the defined **Filter** is taken into account. E.g. if set to "Processing Step Separations", entering "1" will show the first used Processing Step Separation.

Enable the option to **Add Cutting and Creasing processing step layers**, even if they're not included in the Filter setting. If the Filter doesn't give any results, the Cutting and Creasing processing step layers will not be added.

Enable **Map to Black** to show all visible separations in black. This is mostly used when only one separation is visible, i.e. in combination with the **Show only separation** option, or when using a **Repeat Option** on the Report Template. See [Report Marks](#) on page 69

### Transformation

Use the **Transformation Inspector** to define the position of the Input File Mark. See [Mark positioning](#) on page 318

**Note:**

You can not use the Scale tool to change the size of the Input File Mark. You can however include the Input File Mark in a **Resize Mark**. See [Resize Mark](#) on page 314

### Dimensions Mark on Input File Mark

If you attach a Dimensions Mark to an Input File Mark, the Transformation Inspector of the Dimensions Mark will contain an extra option: **Dimensions of:**. Using this dropdown, you can choose what dimensions of the Input File Mark the Dimensions Mark should show.

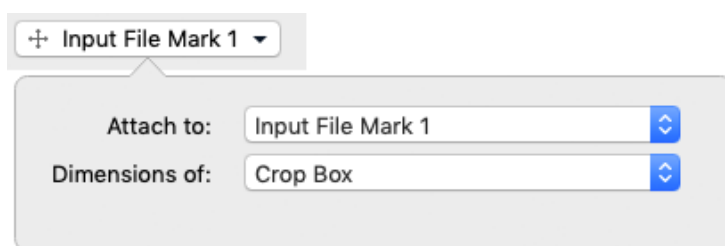

**Note:** The Dimensions Mark will show the original dimensions of the Input File, even if the Input File Mark was scaled.

### Report Marks

When editing a Report Template, the **Marks** section will be replaced by "Report Marks". It will also contain some additional settings.



You can change the **Input File** using the dropdown. You can select any file that was used as Input File earlier in the ArtPro+ session in the dropdown, or you can select **Browse...** to select a different file.

**Note:** The Input File can't be a Normalized PDF file. If you want to use a Normalized PDF as Input File, you should convert it to PDF+ and save it first. See [Convert to PDF+](#) on page 54

Using the **Repeat Page** you can repeat the selected page in the final output in Automation Engine.

- If you choose **Don't repeat this page in output** the Report will contain the selected page just one time
- If you choose **Repeat page for all separations**, the selected page will be repeated in the Report, once for every separation in the Input File.
- If you choose **Repeat page for all artwork separations**, the selected page will be repeated in the Report, once for every artwork separation in the Input File.
- If you choose **Repeat page for custom filter**, the selected page will be repeated in the Report, once for every separation in the Input File that matches the rules you set. This allows you to select separations by combining rules on Printing Method, Processing Step, Separation Name, Process Separations or Non-Process Separations.

These settings will have an effect on the Report in Automation Engine, but will not make the Report Template in ArtPro+ a multipage document.

However, using the **Repetition** option you can preview each separation page.

### Smart Text in a Report Template

When working on a Report Template, by default all Smart Text (except for category "System") will resolve to the Input File. For example the "File Name" will show the name of the Input File. For more information on Smart Text, see [Using Smart Text](#) on page 295

When working on a Report Template, you also have two additional Smart Text variables:

- **Report Modification Date** will show the modification date of the Report, not of the Input File.
- **Marks > Scale Factor** will show the **Scale Factor** applied on the Input File Mark.

**Note:** If the document contains multiple Input File Marks, the Scale Factor will be shown of the Input File Mark that is closest to the Text Mark in the file structure. If you want to ensure the Scale Factor of the correct Input File Mark is shown, you can put the Text Mark and Input File Mark in a group.

## 3.10. Insert Content from PDF

Using **Insert Content from PDF** you can insert the content of a PDF file on your current page.

1. Choose **File > Insert Content from PDF...**
2. Browse to the PDF document of which you want to insert the content in your current document and click **Insert**
3. If the PDF document you selected is a multipage document, you have to select what page you want to insert. Click **Insert**

The content of the PDF is inserted in the current page of your open document. The content is positioned using the Trimbox of the source document: if the Crosshair is enabled, the content is positioned at the bottom right of the crosshair, and if the Crosshair is disabled, the content is positioned centered on the current view.

The layer structure of the inserted (source) content and the open document will be merged, following these principles:

- If a source layer name matches a layer in the current document (case sensitive), the objects will be inserted in that layer, on top of all objects in that layer.

**Note:** Even if they have the same name, a Processing Step layer and a regular artwork layer will never be merged. A new Processing Step layer or Artwork layer will be created.

- When inserting in a Normalized PDF, objects from Processing Step layers are inserted into a regular artwork layer with the same name as the Processing Step layer.
- If a source layer doesn't exist in the current document, it will be created on top of the current layers, and have the same printing state as the source layer.
- You can't insert into a hidden layer. If the target layer is hidden, you will get the option to cancel or to make the target layers visible before inserting.

## 3.11. Document Setup

---

Using **Document Setup**, you can add a **Distortion** value to your file. This will be applied during ripping, to compensate for distortions that happen during printing.

Choose **File > Document Setup**, enter a **Vertical Distortion Factor** and **Horizontal Distortion Factor** and click **OK**.

**Note:** When placing a PDF+ or Normalized PDF in another document, Distortion Factors of the placed PDF will be ignored.

Distortion factors defined in a Plato PDFPLA file or in a Normalized PDF exported from ArtPro will be kept when opening the file in ArtPro+.

## 3.12. Print

---

Using **File > Print** or its shortcut **Cmd+P** (Mac) or **Ctrl+P** (Windows), you can send your PDF document to any of your configured printers.

The document will be clipped by the **Media Box**.

## 4. Changing the View

---

- By default files are opened in the same window size as the last closed document. All artwork (including artwork outside the media box) and page boxes are fit in the window. By default, page boxes are hidden.
- Files are always viewed in overprint preview
- Like in all recent Esko applications, technical inks are rendered as opaque

**Note:** Rotation flags are not taken into account. You can however change the rotation yourself: see [Rotate View](#) on page 76

Changing the view will not change the file itself: all these changes can not be saved in the file.

### 4.1. Multiple Document Windows

---

If you have multiple documents open, every document will have a separate window.

You can switch the document you are working on in different ways.

- Simply click in a window to activate it
- Select the document you want to activate in the **Window** menu. The active document is indicated with a check mark. Unsaved documents are indicated with a \*.
- Use **Cmd + `** (Mac) or **Alt + Tab** (Windows) to cycle through the different windows.

#### 4.1.1. Arrange document windows

If you have multiple document windows open, you can arrange them vertically or horizontally.

- Select **Window > Arrange > Vertical** to place the open document windows next to each other
- Select **Window > Arrange > Horizontal** to place the open document windows above each other

**Note:** If you use multiple monitors, the document windows are always arranged on the primary monitor, as defined in the operating system's settings.

#### 4.1.2. Synchronize Views

If you have two or more document windows, you can apply the same zoom, pan, and orientation zoom on all document windows by enabling **Synchronize Views**, either by choosing **Window > Synchronize Views** or by its shortcut **Cmd + Alt + 1** (Mac) or **Ctrl + Alt + 1** (Windows).

## 4.2. Changing the Zoom factor

---



### 4.2.1. Fit in Window

- Shortcut: **Cmd+0** (Mac) or **Ctrl+0** (Windows)
- Menu: **View > Zoom > Fit in Window / Previous**

Using the **Fit in Window** function a second time will go back to the previous view (position and zoom), allowing you to toggle between the two views.

**Fit in Window** with Page Boxes hidden:

If the Page Boxes are hidden, **Fit in Window** will center the view and adjust the zoom factor so that all graphics (including elements outside of the Media Box) are visible in the document pane.

**Fit in Window** with Page Boxes visible:

In most cases, the Crop Box is completely inside the Media box. In that case, **Fit in Window** will fit on the Crop Box. Contents outside the Crop Box will be grayed out.

However, it is possible that the page boxes were defined differently:

- If no Media Box is available, the full Crop Box is shown. Contents outside the Crop Box is grayed out.
- If no Crop Box is available, the Media Box is shown. Contents outside the Media Box is grayed out.
- If the Crop Box is partially outside the Media Box, **Fit in Window** will center and fit on the part of the Crop Box that is inside the Media Box. Other content is grayed out.
- If the Crop Box is completely outside the Media Box, both Media Box and Crop Box are fitted, but all content will be grayed out.

### 4.2.2. Actual Size

- Shortcut: **Cmd+1** (Mac) or **Ctrl+1** (Windows)
- Menu: **View > Zoom > Actual Size / Previous**

**Actual Size** will set the zoom factor to 100% to get a clear view on the actual size of the document and its elements. Actual Size or 100% means 100% at a fixed resolution of 72ppi – like in Adobe Illustrator.

This action will not recenter the contents of the file but keep the current center point as its center.

Using the **Actual Size** function a second time will go back to the previous view (zoom), allowing you to toggle between the two views.

### 4.2.3. Zoom to Selection

- Shortcut: **Cmd+Alt+0** (Mac) or **Ctrl+Alt+0** (Windows)
- Menu: **View > Zoom > Zoom to Selection / Previous**

**Zoom to Selection** displays the selected objects as big as possible in the active window.

Using the **Zoom to Selection** function a second time will go back to the previous view (zoom), allowing you to toggle between the two views.

#### 4.2.4. Zoom In / Zoom Out

- Shortcut for Zoom In: **Cmd++ (plus)** (Mac) or **Ctrl++ (plus)** (Windows)
- Shortcut for Zoom Out: **Cmd+- (minus)** (Mac) or **Ctrl+- (minus)** (Windows)
- Menu: **View > Zoom > Zoom In** and **View > Zoom > Zoom Out**

Zooming in or out using the shortcuts or by clicking will zoom in fixed steps: zooming in multiplies the current zoom factor by 1,414 ( $\sqrt{2}$ ), zooming out by 0,7071 ( $1/\sqrt{2}$ ). This means you can go to double or half the current zoom percentage in two steps. You can for example go from 100% to 141,4% to 200% or vice versa.

The current Zoom level is shown in the window title, next to the file name.

Maximum zoom factor is 100.000%

Minimum zoom factor is reached if the Media Box is displayed at approx. 2 by 2 centimeter.

If the document no longer fits inside the window, horizontal and vertical scroll bars will appear.

For more zoom controls, see [Zoom tool](#) on page 74

#### 4.2.5. Zoom tool

The **Zoom** tool (shortcut: **Z**) can be used to change the zoom factor.

- Click to zoom in
- Alt-click to zoom out
- Click and drag a rectangle to zoom in on the area. The area will also be centered.

You can temporarily use the Zoom function without leaving the currently selected tool using the modifier keys:

- Space+Cmd (Mac) or Space+Ctrl (Windows) to zoom in
- Space+Alt+Cmd (Mac) or Space+Alt+Ctrl (Windows) to zoom out
- Hold the Alt key in combination with the mouse wheel to zoom in or out.

As soon as you release the modifier keys, the selected tool becomes active again.

### 4.3. Pan tool

---

The **Pan** tool (shortcut **H** for Pan, or shortcut **Z**, toggling between Zoom and Pan) can be used to move the view by clicking and dragging.

You can temporarily use the Pan function without leaving the currently selected tool using the modifier keys: press and hold Space.

As soon as you release the modifier key, the selected tool becomes active again.

## 4.4. The Crosshair

---

The **Crosshair** is a reference point in the ArtPro+ document and can be moved around.

By default, the Crosshair is hidden, but its visibility is remembered when quitting and restarting ArtPro+. When visible, its default location is at the upper left corner of the media box.

The center for the linear transformations (rotation, scale, mirror, shear) is the zero point of the activated **Crosshair**. When you deactivate or hide the **Crosshair** the center of the bounding box of the selected objects is used instead. See [Transforming objects](#) on page 122

If the Transform tool is selected, you can also move and snap the bounding box of the selected objects onto the Crosshair by holding the **Cmd** key (Mac) or **Ctrl** key (Windows) while using the **arrow keys**. See [Move](#) on page 124

The Crosshair can be moved and rotated using the **Crosshair** tool (see [Move or rotate the Crosshair](#) on page 75).

To hide or show the Crosshair, you can:

- Use the shortcut **Cmd+R** (Mac) or **Ctrl+R** (Windows)
- Select **View > Hide Crosshair** or **View > Show Crosshair**
- Click the eye or "-" icon in front of **Crosshair** in the **Prepress Layers** section in the Side Panel.

### 4.4.1. Move or rotate the Crosshair

You can use the **Crosshair Tool** from the Tool Switcher (Shortcut: **R**, toggling with **Cut on Crosshair**, see [Cut on Crosshair](#) on page 76) to move or rotate the Crosshair

- Use the **arrow keys** to move the Crosshair over the fixed **Keyboard increment** distance defined in the preferences, or over 10 times that distance when holding the shift key. See [Preferences](#) on page 44
- Hold the **Cmd+ALT** key (Mac) or **Ctrl+ALT** key (Windows) while using the **arrow keys** to move and snap the Crosshair onto the 9 anchor points on the bounding box of the selected objects. If no objects are selected, the Crosshair will snap to the trim box.

**Note:** **Cmd+ALT** is also the Modifier for the Crosshair: whatever tool is currently selected, you can hold **Ctrl+ALT** to temporarily switch to the **Crosshair** tool.

- Click in your document to position the Crosshair center
- Click and drag the Crosshair to position it, snapping magnetically to all selected paths. The path the Crosshair is snapping to will be highlighted. The Crosshair will snap to lines, curves and anchor points, even if the crosshair is rotated. Hold the **Ctrl** key (both on Mac and on Windows) while dragging to disable the magnetism.
- Click and drag on the horizontal or vertical line of the Crosshair to move only this line of the Crosshair. The same magnetism is applied as when moving the Crosshair (see above). Hold the **Ctrl** key (both on Mac and on Windows) while dragging to disable the magnetism.
- Hold the **ALT** key and click and drag to rotate the crosshair. A blue circle is shown on the center of the Crosshair, containing the Angle Readout. Hold down the **Shift** key to constrain the rotation to multiples of 15 degrees.

- Hold the **ALT** key and click on the center of the Crosshair to enter the desired angle for the Crosshair.

#### 4.4.2. Cut on Crosshair

Using the **Cut on Crosshair** tool, you can cut away parts of the selected objects, based on the position of the Crosshair.

1. Select the objects you want to cut.
2. Select the **Cut on Crosshair** Tool from the Tool Switcher under the Crosshair tool, or use the shortcut: **R**, toggling with the **Crosshair** tool, see [Move or rotate the Crosshair](#) on page 75  
The cursor changes into a pair of scissors.
3. Indicate what quadrant you want to cut away
  - Click the quadrant to cut away the parts of the selected objects in that quadrant.
  - Click and drag multiple quadrants to cut away the parts of the selected objects in those quadrants.
  - Hold the **Alt** and click or drag to **keep** the parts of the selected objects in the selected quadrants, and remove all other quadrants.

### 4.5. Rotate View

---

You can rotate the view in multiples of 90 degrees.

- You can rotate the view clockwise by selecting **View > Rotate View > Clockwise** or by its shortcut **Cmd+Shift++ (plus)** (Mac) or **Ctrl+Shift++ (plus)** (Windows).

**Note:** The shortcut only works using the plus key from the numeric keypad.

- You can rotate the view counterclockwise by selecting **View > Rotate View > Counterclockwise** or by its shortcut **Cmd+Shift+- (minus)** (Mac) or **Ctrl+Shift+- (minus)** (Windows)

If the View is rotated, a compass-like **Rotation indicator** is shown in the bottom right of the document pane, indicating the current rotation



- You can go back to the normal view (no rotation) by selecting **View > Rotate View > No rotation** or by clicking the **Rotation indicator**

### 4.6. Preview or Outline mode

---

ArtPro+ can display the document in two modes: **Preview** mode, where the filled version of the file is displayed, or **Outline** mode where only the technical lines of the paths are visible.

Functions can be executed both in preview mode and in vector mode.

To switch between Preview and Outline:

- Use the shortcut **Cmd+Y** (Mac) or **Ctrl+Y** (Windows)
- Select **View > Switch to Preview** or **View > Switch to Outline**
- Using the **View Mode selector** button in the top right of the Side Panel

By default, in Outline mode, you will still see "hinting": a dimmed version of the colored preview below the outlines. You can switch this on or off using the + button next to the **View Mode selector** button when in Outline mode.

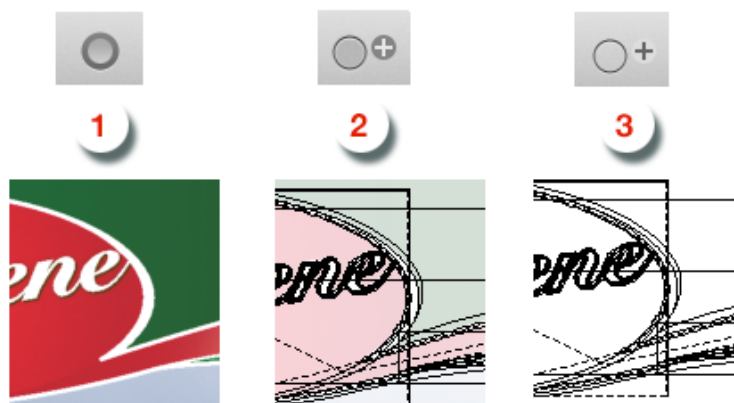

1. Preview mode
2. Outline + mode with "hinting"
3. Outline mode without "hinting"

## 4.7. Hiding objects

---

Using the **Hide** function, you can hide the selected objects.

Hidden paths are no longer visible and cannot be selected nor modified. Still, they are saved with the file, so they will become visible again, when the file is next opened. You can apply this function multiple times, to hide additional objects.

**Show All** makes all hidden paths visible again.

It will deselect all paths in the current job first and then show the hidden paths, which will come back selected. This allows you to check something and then immediately **Hide** them again.

- Select **Object > Hide** or its shortcut **Cmd+3** (Mac) or **Ctrl+3** (Windows)
- Select **Object > Show All** or its shortcut **Cmd+Alt+3** (Mac) or **Ctrl+Alt+3** (Windows)

## 4.8. Color Management

---

In ArtPro+ you can have a color managed preview of your job.

To use Color Management, a number of options and functions are available:

- **Color Managed Preview**
- The **Color Space**
- The **Default Profile** set in the Preferences. See [Preferences](#) on page 44

**Color Managed Preview** can be switched on and off by choosing **View > Color Managed Preview** or by using its shortcut **Cmd+Alt+Y** (Mac) or **Ctrl+Alt+Y** (Windows).

If Color Managed Preview is enabled, the document will be rendered using the **Document Profile**

- If your document contains an embedded profile, this profile will be used.
- If your document contains a link to a profile that is installed on your computer, this profile will be used
- If your document refers to a profile that is not embedded and not installed on your computer, or if no profile is defined, the **Default Profile** set in the Preferences will be used.

You can change the **Document Profile** by clicking the Document Profile in the Separations section of the Side Panel, and selecting a profile to be used.

**Note:** Installing ArtPro+ does not automatically install any color profiles.

Saving a PDF+ file requires an output intent. Therefore, when saving a file in ArtPro+ that is not a Normalized PDF, the Default Profile will be used as Color Space if no profile has been set yet, and a warning will be shown.

## 5. Checking and Measuring

---

### 5.1. Quality Control

---

In the **Quality Control** section you can perform some quality control functions

- Check the **Total Area Coverage**: see [Total Area Coverage](#) on page 79
- Check for highlight **Breakout**: see [Breakout](#) on page 79
- Check your document in **Flexo Print Preview**: see [Flexo Print Preview](#) on page 80
- Check for **Moiré**: see [Moiré Detection](#) on page 81
- Visualize the used **Screen Sets**. See [Object Screening](#) on page 82
- Check your trapping by showing a **Registration Error**: see [Registration Error](#) on page 83
- **Compare** two documents. See [Compare](#) on page 83

#### 5.1.1. Total Area Coverage

The Total Area Coverage (TAC) is the sum of all separation-densities at a certain point in your document.

To enable the **Total Area Coverage** preview, select "Total Area Coverage" from the Quality Control dropdown list and - if no Eye icon is visible yet, click on the "-" icon in front of "Total Area Coverage". Once the Total Area Coverage preview is enabled, the image in the preview pane will be dimmed and all areas where the sum of the densities is higher than the TAC limit specified in the current Press Setting will be highlighted. You can define the highlight color in the Preferences: see [Preferences](#) on page 44

The **Limit** is the maximal Total Area Coverage that your document may contain. This value depends on the press and the substrate your design will be printed on. Your printer should provide you with the TAC Limit value to use.

You can click inside the Limit field and enter the **Limit** value, or you can use the arrow up key to increase the TAC Limit value or the arrow down key to decrease the value. You can set the value up to 500%. You can hold the **Shift** key to increase or decrease the value 10 times faster.

You can use the Densitometer to measure the densities at a specific location. See [Densities](#) on page 87.

**Note:** Invisible layers, invisible separations and Technical Inks are not taken into account.

#### 5.1.2. Breakout

A Breakout is an area where the percentage of a single separation is lower than the **First Printable Dot** value. This can be used to track areas that won't show up on print because the values are too low.

Your printer should provide you with the First Printable Dot value. The First Printable Dot value is the same as used in the Flexo Print Preview. See [Flexo Print Preview](#) on page 80. The value is always

rounded off to the closest system value (n/255 in %). You can increase or decrease the value by one system value using the arrow up or arrow down key while in the **First Printable Dot** field. You can hold the **Shift** key to increase or decrease the value 10 times faster.

To enable the Breakout preview, select **Breakout** from the Quality Control dropdown list and - if no Eye icon is visible yet, click on the "-" icon in front of "Breakout". Once Breakout is selected and enabled, all areas where a single separation has a value lower than the **First Printable Dot** value (but higher than 0%), will be displayed in highlight color. You can define the highlight color in the Preferences: see [Preferences](#) on page 44.

**Note:**

Keep in mind that:

- breakouts are only highlighted if they are **lower** than (and not equal to) the Limit value but higher than 0%,
- values are rounding off to the closest system value (n/255 in %): 0%, 0.4%, 0.8%, etc.

If you enter 0.8% as First Visible Dot, you will only see breakouts for values that are rounded off to 0.4%.

If you enter 0.4% as First Visible Dot, no breakouts can be shown. It is advised to only enter 0.4% if you are sure that your device can print values as low as 0.4%. It is only for such devices that the Breakout Quality Control with first printable dot set to 0.4% will correctly confirm that everything is printable.

You can use the Densitometer to measure the densities at a specific location. See [Densities](#) on page 87.

**Note:** Invisible layers, invisible separations and Technical Inks are not taken into account.

### 5.1.3. Flexo Print Preview

**Flexo Print Preview** shows the effect of highlight dot gain on your document. Going from light to dark, the Preview will display percentages below the first dot percentage as 0%. The first dot percentage will be shown darker (using the **Prints As** value). Towards the midtones this darkening effect will fade out until the **Range** value. Percentage larger than Range, are displayed unchanged

Your printer should provide you with the **First Printable Dot**, **Prints as** and **Range** values. The First Printable Dot value is the same as used in Breakout. See [Breakout](#) on page 79. The values are always rounded off to the closest system value (n/255 in %). You can increase or decrease the value by one system value using the arrow up or arrow down key while in the one of the input fields. You can hold the **Shift** key to increase or decrease the value 10 times faster.

To enable the Flexo Print Preview, select **Flexo Print Preview** from the Quality Control dropdown list and - if no Eye icon is visible yet, click on the "-" icon in front of "Breakout".

You can use the Densitometer to measure the densities at a specific location. See [Densities](#) on page 87.

**Note:** Invisible layers, invisible separations and Technical Inks are not taken into account.

#### Flexo Print Preview and Plate Cutting Paths

If you have defined **Plate Cutting Paths** in your document, the Flexo Print Preview will show a number of extra information and options to inspect the Plate Cutting Paths. See [Create Plate Cutting Paths](#) on page 285



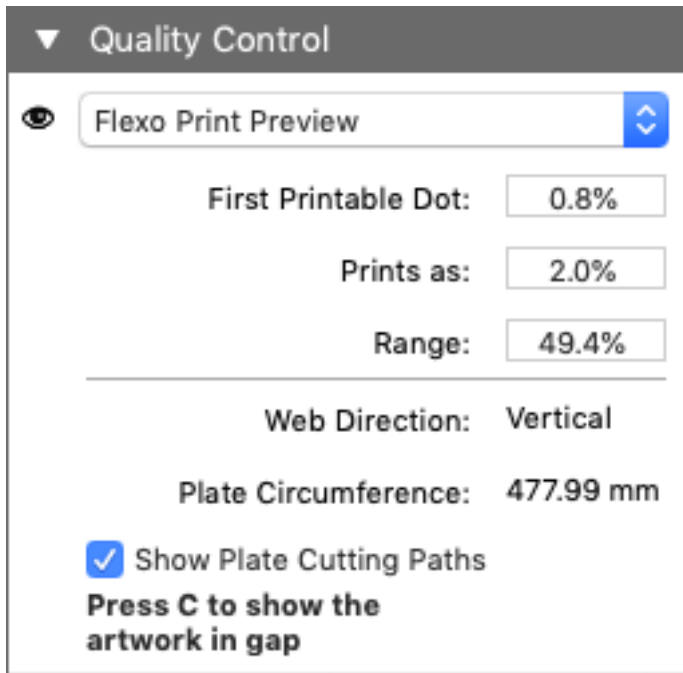

- The **Web Direction** set in the Plate Cutting Path dialog: either vertical or horizontal
- The **Place Circumference**
- The grid repetition will be endlessly repeated for visual inspection. Note that this is a preview, it is not saved in the file. Processing Step separations are disabled as they are not printed and have no Plate Cutting Paths.
- Enable **Show Plate Cutting Paths** to visualize the Plate Cutting Paths for the visual separations.
- You can press the C key to show artwork in the gap, to inspect when a Plate Cutting Path cuts through e.g. bearer bars or cuts away artwork (bleed).

### 5.1.4. Moiré Detection

Using the **Moiré Detection** preview, you can detect possible screening problems in your document.

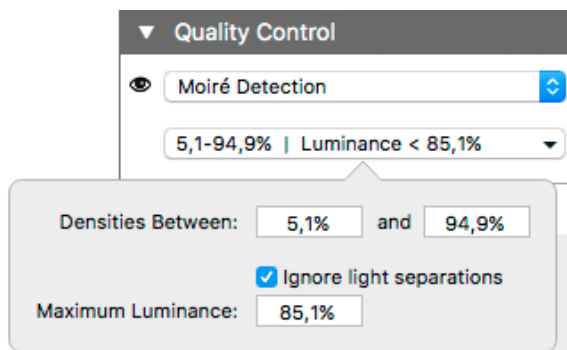

Using the filter, you can choose to only include objects with a density between two values, by default 5,1% and 94,9%. By enabling **Ignore light separations** you can choose to ignore separations with a luminance higher than the **Maximum Luminance**.

If you enable Moiré Detection, the document will be shown dimmed, and areas with possible screening problems are highlighted.

A possible screening problem exists if one of these conditions is met:

- the angles for the separations used in that area are the same
- the angles for the separations used in that area do not differ 30 degrees
- the rulings for the separations used in that area are different
- the dot shapes for the separations used in that area are different

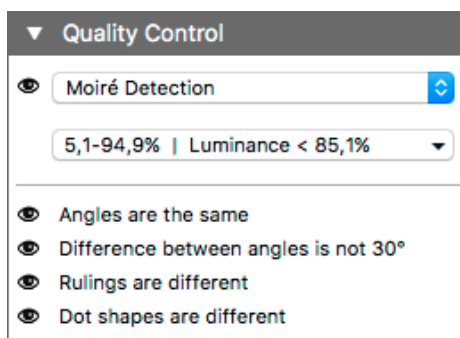

If possible screening problems are found, you can enable or disable the toggles to only highlight screening errors matching the selected conditions. If there are no moiré conflicts for a certain condition within the currently viewed area, that option will be greyed out. Note that zooming or panning can change which screening problems are found in the currently viewed area.

- If an unscreened object is involved, this is considered matching **all** of the conditions.
- Angles are considered the same if they differ a multiple of 90°. E.g. an angle of 7,5° and an angle of 97,5° will highlight as "Angles are the same".
- If the angles are the same, this is **not** highlighted as "Difference between angles is not 30°"
- All visible separations are taken into account. If you want to disregard a separation (e.g. a Technical ink or a Processing Step Separation) you can hide that separation.

### 5.1.5. Object Screening

Using the **Object Screening** Preview, you can get an indication of what Screening Set is used on what objects.

The Quality Control section will show a list of all Screen Sets used in your file, each with a different color. Objects using a specific screen set will show in the corresponding color. Areas where multiple screen sets overlap are shown in red.

Using the eye icons, you can make the objects using the selected Screen sets visible or invisible.

For more information on Screening, see [Screening](#) on page 245

### 5.1.6. Registration Error

The Registration Error Preview is a simulation of a design printed with registration errors. It can be very helpful to see if trapping is applied sufficiently and correctly.

The separations are randomly shifted.

In fact, all separations are moved exactly the distance of the Maximum Deviation, but all under a random angle.

If you want to see another random registration error simulation, press **Y**



In the example above, you can see a small area of a job in regular preview (left) and with registration errors (right). In this case, you can clearly see no trapping was applied, so white lines appear at the registration shifts.

### 5.1.7. Compare

Using the **Compare** function, you can compare the current page of the current document with a **Reference file**

1. To enable Compare, select **Compare** from the Quality Control dropdown list.
2. Set a Reference file. You can select any open file from the dropdown list, or select another file by choosing **Browse**.
3. If the Reference file contains multiple pages, you can set the page to be used.
4. If needed, (re)set the **Alignment**

ArtPro+ will align the two documents, based on the common visual objects. If you make any edits, e.g. change the visibility of specific elements, the documents will not be realigned automatically. You need to click the **Align on All** button to realign the two jobs based on the new visual objects. If you want to align the two jobs based on the selected objects, you can use the **Align on Selection** button. If not enough common elements are found, the two jobs will be aligned using the bottom left corner of their trim box.

5. Set the **Separation Matching**
  - If all separations of the current document match with a separation in the reference document, the button will show "Separations Matched"
  - If there are separations in the current document that don't match a separation in the reference document or vice versa, the button will show "Unmatched Separations"

- By clicking the button, you can open the **Separation matching** dialog

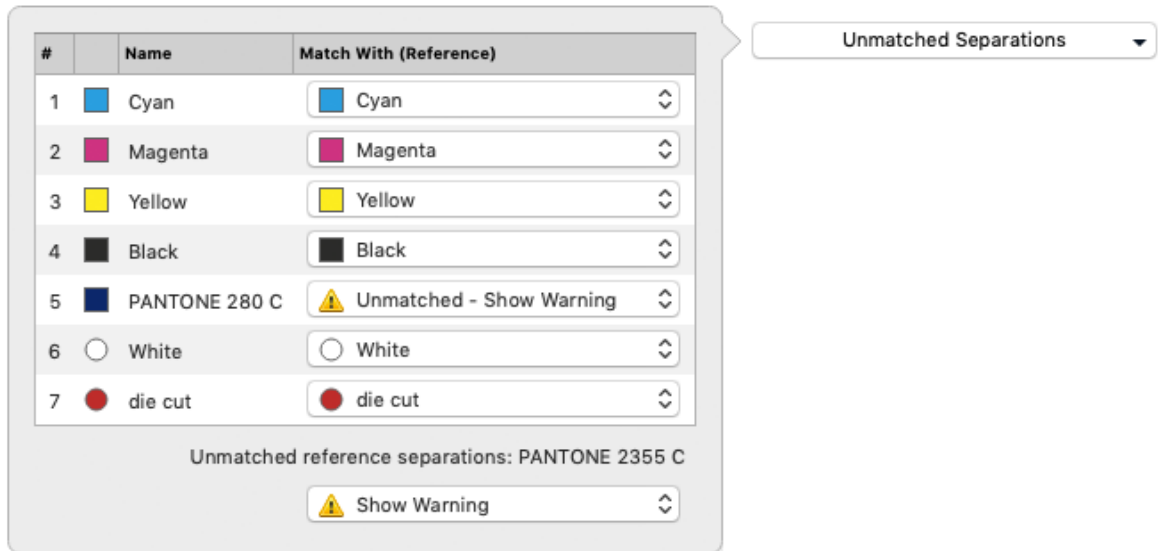

- Every separation in the current document that is not found in the reference document is shown as **Unmatched - Show Warning**. You can match it with a separation from the reference document by selecting it in the dropdown, or you can set it to **Don't Compare**
  - The **Unmatched reference separations** at the bottom indicate what separations in the reference document are not matched to a separation in the current document. You can set these to **Show Warning** or **Don't Compare**
  - As soon as all unmatched separations are matched or set to "Don't Compare", the button will change to **Separations Matched**
6. Compare the documents:

ArtPro+ will calculate the visual differences. The job will be shown dimmed, with rectangles indicating the visual differences. In the Information Side Panel, you get an indication on the number of areas containing visual differences, along with a notification in case the trim box, media box, separation list or separation order of the two documents don't match.



- Click the eye icon in front of **Compare** to toggle between differences view and normal view.

- Hold the **C** key to temporarily show the reference file instead of the current document. By using this toggle, you can easily see the difference between both documents.

**Note:** When toggling between the active file and the reference file, the Page Box information (when visible) will be updated. The Layer list and Separation list is not updated, and thus will always show the information of the active document.

- To get a more specific indication of the differences, you can enable **Highlight different pixels**. Within the rectangular area, this will highlight the difference in pixels using the **Highlight** color set in the Preferences. The image below shows the difference with the option disabled (left) and enabled (right).

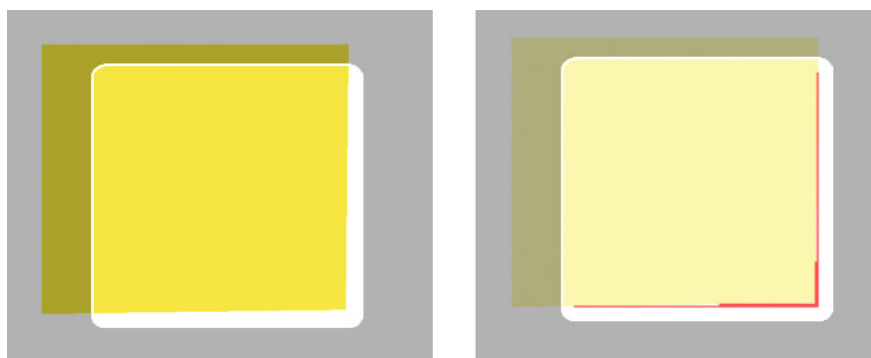

**Note:**

When you navigate to another page of the active document or another page of the Reference document, Compare will automatically realign based on the common visual elements.

### Calculating the differences

When calculating the differences between the current document and the reference document, these rules are followed:

- Visible layers of the current document are compared against all printing layers of the reference document
  - When the visibility state of the layers of the current document is changed, the comparison is recalculated accordingly. This allows you e.g. to disable the trap layer in the current document and check if the artwork of this trapped document still matches that of the untrapped reference document.
- Visible separations of the current document are compared to all separations of the reference document. A difference that is only found in one specific separation will not be reported if that separation is hidden. Technical inks in Normalized PDF and processing step colorants in PDF+ are also compared.
  - When separations are hidden or made visible, the comparison is recalculated accordingly
  - To exclude technical inks or processing step colorants from the comparison, you can hide them or choose **Don't Compare** in the Separation Matching dialog.
- If the current document is rotated, the reference document is rotated in the same way

**Note:**

Even when no visual differences are found, it can happen that the previews look different when toggling between the current document and the reference document. This is typically the effect of a different separation order: When the order of the separations is different, the visual effect on screen may be different as well, e.g. because of opaque inks, or due to color management.

This alone does not affect the output of each individual plate though, so no difference is found. In this case, the following message will be issued: "Separation order is different. Preview on screen may be different."

## 5.2. Dimensions

The **Dimensions** tool (shortcut: **D**, toggling with Densities) can be used to measure dimensions (distance, angle, area, ...).

1. Select the Dimensions tool
2. Click the first point where you want to start measuring
3. Click the second point, or drag to the second point.

**Note:** You can change the zoom and pan without interrupting your measuring, by using the modifier keys. See [Zoom tool](#) on page 74 and [Pan tool](#) on page 74

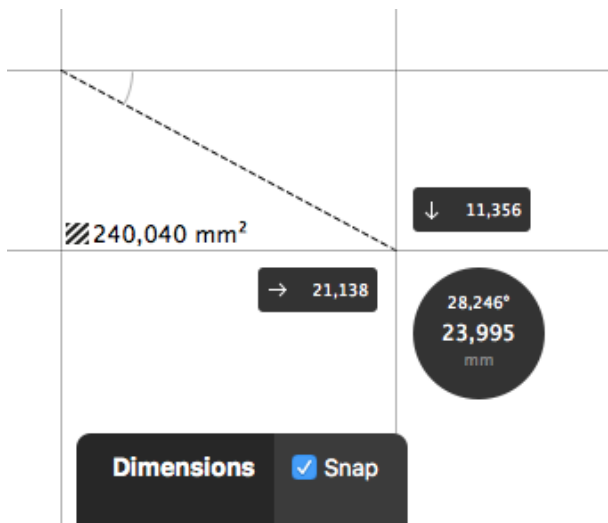

You will see

- the distance, both vertical, horizontal and in total
- the angle
- the total area of the rectangle. If the area is too small to show the value, you can see it as a tooltip when hovering over the area icon

Distances and areas are shown in the units defined in the Preferences (see [Preferences](#) on page 44). However, for distances, you can click in the black circle to toggle between this unit and point (pt). All distances shown will be adjusted accordingly.

4. You can click and drag one of the points to change its location. Click elsewhere to start a new measurement, or use the **esc** key to clear the current measurement.

If the **Snap** option is enabled, the Dimensions tool is **magnetic**: it snaps to the nearest point you may want to measure, both for the start point as for the end point.

It will snap to:

- all visible outlines, when in Outline or Outline with Preview Hint mode
- bounding boxes of all objects, strokes, text, patterns, transparency masks, line work masks and bounding boxes of images when in Preview mode.

You can enable or disable the magnetism of the Dimensions tool using the **Snap** checkbox, or by using the shortcut **N** while the Dimensions tool is active.

## 5.3. Densities

---

The **Densities** tool (shortcut: **D**, toggling with Dimensions) can be used to measure densities at a specific location.

1. Select the Densities tool
2. Click the point you want to measure

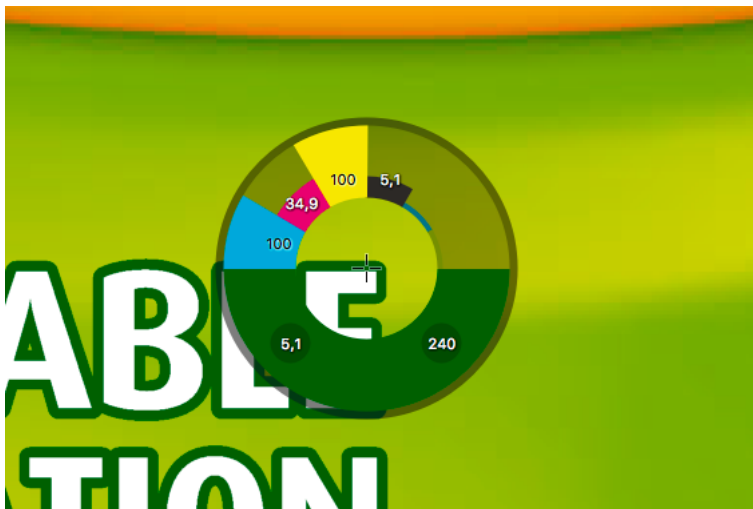

You will see the **Density Wheel** around the measure point (indicated by a crosshair):

- The upper half of this wheel will show color bars and values for each printing separation in the file. Technical inks are ignored. The height of each bar corresponds to the percentage at the measured point.
- The corresponding values for every separation are also shown in the **%** column of the **Separations** section in the Information Side Panel.
- The bottom half of the wheel will show the color visualization of measured pixel.
  - At the left hand side, the lowest (non-zero) measured value of all printing separations is shown. If this value is below the **Breakout Limit**, the value is shown in a circle in the highlight color, and a colored line at the inner circle of the Densitometer wheel is shown indicating the separation in which the value was measured. See [Breakout](#) on page 79

- At the right hand side, the total ink percentage of all printing separations and all visible layers at the measured point is shown. If this value is above the **Total Area Coverage Limit**, the value is shown in a circle in the highlight color. See [Total Area Coverage](#) on page 79



**Note:** Invisible layers are not taken into account. Invisible separations are measured.

3. You can click and drag to get a continuous readout of the measured point.



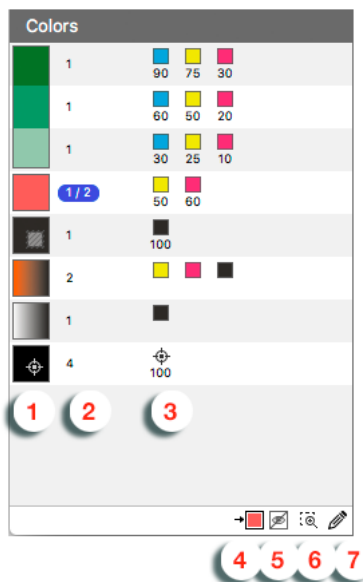



## 5.4. The Colors Side Drawer

The **Colors Side Drawer** lists all flat colors and gradients used in the current page of the active document.



1. Every flat color or gradient found in the current page of the document is represented by a color patch. Dynamic Marks are disregarded.
  - Colors are considered the same if all percentage values and overprint settings are the same.
  - Gradients using the same color stops are considered the same, even if they are using different relative positions between the stops, or using a different rotation or positioning.
  - If a color is set to overprinting for one or more separations, the overprint icon  is shown in the color patch.
  - If a color is a **Registration color**, the registration icon  is shown in the color patch.
  - Colors that are different tints of the same color mix (in the example above the three green colors) are shown as a cluster. This can be used to convert all these tints into tints of a spot color. See [Convert to Spot Color](#) on page 107











2. In the second column, you get an indication of the number of times the color is used in the current page of the document.
  - If some of the occurrences are selected, this is indicated e.g. by "1 / 4".
  - If all occurrences are selected, the complete line in the Colors Side Drawer will be selected.
3. In the third column, a separation color patch is shown for every separation used in a specific color.
  - underneath every separation color patch, the percentage for that separation is shown (except for gradients).
  - Hovering over a line in the Colors Side Drawer will show the complete ink names and percentages.
  - If Registration Color is used, the Registration icon  is used. Registration Colors are always shown at the bottom of the list.
  - If the color is used in one or more locked or hidden objects, a lock or eye icon is shown on the right.  
4. The **Convert to Spot Color**  button can be used to convert a color mix into a spot color. See [Convert to Spot Color](#) on page 107
5. If the option **Exclude Hidden Objects**  is enabled, colors that are only used in hidden objects will not appear in the list.
6. Clicking a Color in the Colors Side Drawer will select all (unlocked) objects in the document. If the **Zoom to Selection**  option is enabled, clicking an entry displays the selected object(s) as big as possible in the active window.
7. If the option **Show Color Inspector**  is enabled, the Color Inspector section is shown at the top of the Color Side Drawer. Using the Color Inspector you can edit flat colors of the selected objects.
  - The editing is the same as in the Fill & Stroke Inspector, so you can use the shortcuts such as x, t, ... See [Fill Color and Stroke Color Inspector](#) on page 143. If the resulting color matches an existing one, their lines in the Color Side Drawer will be merged. You can use this to reduce the number of different color mixes, and hence the number of lines in the Color Side Drawer.
  - The first line of the Color Inspector indicates how many times the color is used as fill and/or stroke color.
  - Only flat colors can be edited. If your selection contains flat colors and gradients, the Color Inspector will show the flat color(s).

## 5.5. Ink Coverage

---

Using **Prepress > Ink Coverage** you can calculate the surface ink coverage for the active job. The total surface of the job and the surface covered by each separation is calculated. The results are displayed in the unit defined in Preferences (see [Preferences](#) on page 44), as well as in percent.

Area: Media Box

#	Separation	Ink Coverage	%
1	 Cyan	1166.38 mm <sup>2</sup>	2.27%
2	 Magenta	11301.15 mm <sup>2</sup>	22.03%
3	 Yellow	959.33 mm <sup>2</sup>	1.87%
4	 Black	2234.34 mm <sup>2</sup>	4.35%
5	 PANTONE 2355 C	19062.61 mm <sup>2</sup>	37.15%
6	 White	1990.53 mm <sup>2</sup>	3.88%
7	 die cut	1482.38 mm <sup>2</sup>	2.89%
8	 Cut	116.82 mm <sup>2</sup>	0.23%

Export... Close

Ink coverage is only calculated inside the border set using the dropdown, so if the border is set for example to trim box, it does not include any bleed or other elements outside that size.

**Note:** Invisible layers are excluded from the calculation. However, invisible Separations or non-printing layers are included.

Click the **Export** button to save the Ink Coverage data as an XML file.

## 6. Document Settings

---

### 6.1. Working with multi-page documents

---

Using **File > Pages** you can manage pages in a multipage document.

- Use **File > Pages > Insert Blank Page...** to insert a blank page in your document. In the **Insert Blank Page** dialog, you can choose where you want to insert the page.

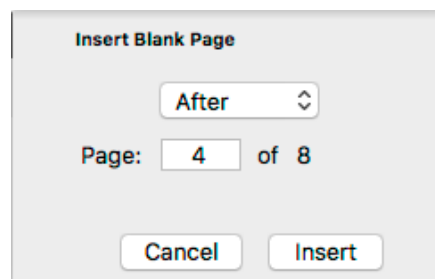

The inserted page inherits the page box and crosshair properties from the current page.

- Use **File > Pages > Delete Pages...** to remove pages from your document. In the **Delete Pages** dialog, you can set the page or range of pages you want to delete.

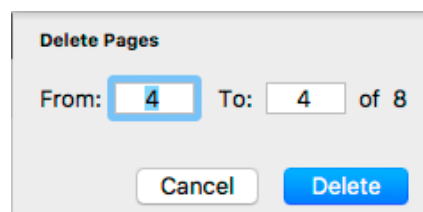

**Note:** You can not delete all pages of your document.

#### 6.1.1. Navigating a multi-page document

If you open a multi-page document, the first page will be shown. You have different options to navigate through the different pages.

- You can use the menu options in **View > Go To** to go to the first, previous, next or last page.
- You can enter a page number in the page navigator in the side panel to go to a specific page, or use the buttons to go to the first, previous, next or last page.

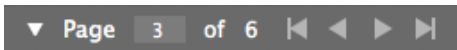

- You can use the shortcuts:
  - Page Up or Page Down to go to the previous / next page
  - Hold Cmd (Mac) or Ctrl (Windows) and press Page Up or Page Down to go to the first / last page

Navigating to a different page does not affect the selection, zoom level, color management, visibility of page boxes, rotated view, etc.

Undo / Redo will navigate to the page where the action is occurring.

**Note:** When working with a PDF+ file, ArtPro+ only checks the linked external files (Images, Placed Art or Structural Design files) for the current page. This means that navigating to a different page can result in a warning for a missing link or out of date image. See [Missing and out-of-date files](#) on page 56

## 6.2. Page Boxes

---

You can toggle the Page Boxes visibility in different ways:

- By selecting **View > Show/Hide Page Boxes**
- Using the shortcut **Cmd+B** (Mac) or **Ctrl+B** (Windows)
- By clicking the Page Boxes eye in the Document section of the side panel.



Page Boxes that are defined in the document are shown in different colors, with a label on the top left corner, indicating the Page Box name and its dimensions. Double-clicking the label will open the **Page Boxes Setup** dialog, with the selected Page Box active. See [Editing Page Boxes](#) on page 92

When Page Boxes are visible, only a section of the canvas is shown, the rest is grayed out. Objects outside the Crop Box are shown dimmed.

The visible section is:

- The part of the Crop Box that is inside the Media Box.
- If no Media Box is available, the full Crop Box is shown
- If no Crop Box is available, the Media Box is shown.
- If the Crop Box is completely outside the Media Box, all content will be grayed out.

The **Fit in Window** function reacts differently if Page Boxes are visible: see [Fit in Window](#) on page 73

### 6.2.1. Editing Page Boxes

Using the **Page Box Setup** dialog, you can define or edit Page Boxes.

You can open the dialog in different ways:

- Choose **File > Page Boxes Setup ...**
- Use the shortcut **Cmd+Alt+P** (Mac) or **Ctrl+Alt+P** (Windows)
- Double-click the label of one of the Page Boxes. The selected Page Box will be active in the Page Boxes Setup dialog.
- Double-click **Page Boxes** in the Side Panel.

You can edit any page box by selecting it, and changing its values. The changes will be shown in the document immediately, but only accepted if you click **OK**

**Note:** Holding the **Alt** key will change the **Cancel** button in a **Reset** button. Clicking it will reset all page boxes to the previous accepted settings.

### Crop Box, Bleed Box, Art Box

Using the checkbox in front of the page box name, you can add or remove the page box.

This is only available for Crop Box, Bleed Box and Art Box: the Trim & Media Box are always defined.

If you add a Page Box (e.g. a Crop Box), the Page Box will use the dimensions of the Media Box.

### Dimensions

You can edit the size of any Page Box by entering the dimensions. The **Transformation Origin** buttons







allow to set in what direction the Page Box should be modified. If you e.g. select the top left corner, the top left corner of the Page Box will remain unmodified.

**Note:** You can use calculations when entering dimensions, e.g. by entering "300 mm + 2 inch", the result will be 350,80 mm.

### Fit to ...

Using the buttons, you can set the size and position of the page box:

-  **Fit to All:** the page box will be modified so it fits all objects in the current document.
-  **Fit to Selection:** the page box will be modified so it fits all objects currently selected.
-  **Fit to Trim Box:** the page box will match the Trim Box. This is only available for Media Box, Bleed Box and Art Box.
-  **Fit to Media Box:** the page box will match the Trim Box. This is only available for Crop Box, Bleed Box and Art Box.

### Margins on Trim Box

The Media Box and Bleed Box can be defined by entering a margin on the Trim Box. You can enter a

different margin for the top, left, right and bottom, or by enabling the **Lock** button  you can set one margin for all 4 sides.

**Errors**

Any errors, such as a Trim Box not fully covered by the Media Box, are indicated by a blue circle with a white "i" next to the Page Box name. At the bottom of the dialog, you can find more info on what's wrong, and a link providing a possible solution (e.g. to fit the Bleed Box to the Media Box).



**Note:** When working on a Normalized PDF, you will not be able to save the page boxes setup as long as the errors have not been resolved.

**Multi-page Normalized PDF**

Dimensions and position for each page box need to be the same for all pages of a Normalized PDF. If e.g. a trim box is changed on page 1, it is automatically changed on all other pages; if a bleed box is added to page 2, it is automatically added on all other pages.

## 6.3. Layers

The **Layers** section has two view modes: the default "Layer Overview" mode explained below, and the "Processing Step Layers Overview" mode described in [Processing Step Layers Overview mode](#) on page

99. You can switch between modes using the buttons  and .



**Note:** For Normalized PDF files only the regular "Layers Overview" mode is available, so the buttons will be hidden.

The **Layers** section in Layers Overview mode lists all of the layers that are present in the current document. Groups and individual elements are not listed.

**Note:** Sublayers are only shown if these sublayers are saved in the PDF file correctly, e.g. sublayers in Adobe Illustrator are not saved in the PDF file.

- Double-click the layer name to change its name.

**Note:** You can also rename layers from the breadcrumbs or the object browser. See [Renaming objects, groups and layers](#) on page 119

- In the **Visibility** and **Print** column, you can change the visibility and printing state of all layers. See [Visibility, Locking and Printing state](#) on page 95
- The Selection column will show an icon  if some objects in that layer are selected. If all objects in the layer are selected, the icon changes to this: . You can also click the icon in the Selection column to select all objects in that layer.
- By clicking the **Move selection to active layer** button  you can move the selected objects to the active layer
- Click the + button to add a new layer. Click the - button to remove the selected layer(s) and their content.
- Select **Delete All Empty Layers** from the fly-out menu to delete any layers that do not contain any objects.

- To reorder layers, click and drag a layer to its new position.
- In case the document you opened contains art that is not in any layer, the Layers list will show "Unlayered Art". You can't select or change this. You can however select from the fly-out menu to put the unlayered art in a Layer. If the document you opened contains both unlayered art and at least 1 layer, you will get a warning recommending to use the **Create Layer from Unlayered Art** option.

### Selected layer(s) and Active layer

Some actions, such as deleting or moving, apply on all **selected** layers. For other actions, such as **Move selection to active layer** and actions from an **Action List**, the **active** layer is used.

Selected layers are indicated by a blue background and white text. You can have none, one or multiple layers selected.

- By default no layer is selected.
- You can **select** a layer by clicking the layer name.
- You can command-click (Mac) or control-click (Windows) to add a layer to the selection or remove a layer from the selection.
- You can use shift-click to select a range.

There is always exactly one **active layer**, indicated by a layer name in bold.

- Selecting a layer makes it the active layer.
- If multiple layers are selected, the topmost selected layer will be the active layer.
- If no layer is selected, the topmost layer is the active layer.
- If you apply a regular **Paste**, the pasted objects will be in the active layer. Other Paste methods are also available. See [Cut, Copy and Paste](#) on page 118

## 6.3.1. Visibility, Locking and Printing state

When opening a file, ArtPro+ will show the visibility and printing states of the layers as they were saved in the file. Non-printing layers will be hidden by default. Locking is never saved in a file, so all layers will be unlocked by default.

**Note:** When opening PDF 1.5 compliant files (e.g. ArtPro files and Normalized PDF files), invisible layers will always open as invisible and non-printing, regardless of their printing state in the original application.

### Automatic Sync

If you change the printing state of a layer, the visibility will be synced to the printing state: printing layers will be visible, non-printing layers will be invisible.

Changing the visibility state will not affect the printing state in any way.

### Column icon

You can use the top icons to change all layers at once

Action	Result
Click the eye icon	Change all layers to "Visible". If this is already the case, this will change all layers to hidden.

Action	Result
Click the lock icon	Change all layers to Locked. If this is already the case, this will change all layers to unlocked.
Click the Printing icon	Change all layers to Printing and Visible. If this is already the case, this will change all layers to hidden and non-printing.
Alt-click the eye icon	Toggle between all layers visible, and the previous state
Alt-click the lock icon	Toggle between all layers locked, and the previous state
Alt-click the Printing icon	Sync visibility to the printing state: printing layers become visible, non-printing layers become invisible.

### Layer icons

The eye icons show if a layer is visible or not, the locked icon shows if a layer is locked, and the printing icon shows if a layer is printing or not.

You can change the state of layers in different ways:

Action	Result
Click an icon	Toggle Visibility / Locking / Printing State on or off
Click and drag over multiple icons	Toggle the visibility, locking or printing state for the first layer you clicked, and apply the same state to all layers you drag.  If e.g. you click and drag starting on the eye icon of a visible layer, this layer and all others you drag will become hidden.
Alt-click an icon	The selected layer becomes visible / locked / printing, while all other layers become hidden / unlocked / non printing  Alt-clicking again will change all layers back to the previous state

**Note:** Making a layer invisible, will deselect all objects in that layer.



**Note:** If you do an action on the active layer (e.g. creating an object) while the active layer is locked, you will be asked if you want to unlock the layer.

## 6.3.2. Processing Step Layers

Ever since PDF became the preferred file format in the graphic industry, PDF files were used not only to store the artwork to be printed, but also as a container for information related to the production process: cutting lines, dimensions, etc.

How the information was stored in the PDF file, depends on the application that was used to generate the PDF, and the preferences of the user. For example the die cut lines can be in a separation called "Die", or in a layer named "Cut". Obviously, this leads to a multiple of ad hoc methods, which leads to interoperability problems, and a complex and error-prone situation.

ISO 19593 defines a new mechanism to store objects and metadata corresponding to such processing steps in a PDF file in a standardized way.

Based on this ISO norm, the use of Processing Steps was introduced in ArtPro+ as **Processing Step Layers**.

**Keep in mind however that these Processing Step Layers are only available when working with PDF+ files. Normalized PDF files use Technical Inks instead.** See [PDF](#), [PDF+](#) and [Normalized PDF](#) on page 52

### Objects in Processing Step Layers

Processing Step Layers contain objects in your PDF file (a path, a text object, ...) that are associated with a specific Processing Step.

The type of Processing Step Layer can influence the properties of the PDF objects. For example, a PDF object in a Structural Processing Step Layer has to be colored in a spot color (to visualize in viewing and proofing applications). Because the objects in these Processing Step Layers should not have any influence on the final printed version (and on the plate making), this spot color should not be used for "normal" PDF objects, nor should the objects knock out other objects, or participate in transparency blending with other "normal" artwork objects.

### Processing Step Layer Types

- **Structural** is a group of Processing Step Types, used for a collection of contours that describe how the printed product will be finished to produce a 3D end product from a flat substrate, such as cutting lines, crease lines, etc.
- **Braille:** braille characters that are applied after printing, e.g. by a die cutter or inkjet device.
- **Legend:** job related data outside the boundaries of the actual printed products.
- **Dimensions:** indications of the physical sizes
- **Positions** is a group of Processing Step Types, used for objects that indicate intended, allowed or forbidden positions for certain types of elements, e.g. allowed positions for content on a flap of a carton.
- **White:** white ink to be printed on a transparent or metallic substrate.
- **Varnish:** indicating the application of varnish after printing.

### Processing Step Restrictions

Every Processing Step Layer needs to follow some requirements:

- The Processing Step objects need to be in a **separate layer**

- The layer needs to have a **Processing Step Definition**
- All objects in the Processing Step need to be **overprinting**
- The Processing Step needs to be on top of the artwork layers.

Based on the specific Processing Step, additional requirements need to be followed, about what objects and object characteristics are allowed and how a processor (e.g. a finishing device) has to evaluate them:

1. **Processing Steps describing paths** can only contain **stroked paths**. For example: Cutting or Folding.
2. **Processing Steps describing surfaces** can only contain PDF path and text objects, no images etc .... A processor takes the objects as defining a surface (so any halftoning is ignored). For example: Embossing and Foil Stamping.
3. **Other Processing Steps**: All objects are allowed, a processor needs to take the rendered result. For example: White and Varnish
4. **Legend** is a special Processing Step and has no restrictions on content

If one of the restrictions is not met, a warning is shown in the Messages Side Drawer. You can hover over the warning symbol to get an indication on what is wrong.

### Processing Step Layers in the Layers list

**Processing Step Layers** appear in the Layers list, grouped per type, and the actual Type is shown in the **Type** column.

Layers		Name	Type
<input type="checkbox"/>	<input type="checkbox"/>	Layer 1	Gluing ✓
<input type="checkbox"/>	<input type="checkbox"/>	Diecut layer	Cutting ✓
<input type="checkbox"/>	<input type="checkbox"/>	Layer 2	✓
<input type="checkbox"/>	<input type="checkbox"/>	New Layer	✓

You can change any layer into a Processing Step Layer, or change the type of a Processing Step Layer by clicking the triangle in the **Type** column, and selecting a Processing Step type from the dropdown.

You can change a Processing Step Layer into a normal layer by clicking the triangle in the **Type** column and selecting **None**.

You can prevent a number of these issues by using the **Move Objects To** function to create Processing Step Layers. See [Move objects to ...](#) on page 99

### Processing Step Separations

Separations that are only used in Processing Step Layers are considered "Processing Step Separations": they can be used to color objects in the Processing Step Layers, but are not considered printing inks, as they should not appear on plates or on the final printed result.

Processing Step Separations are represented in the Separations list using a round color patch.

**Note:** If an ink is used in at least one "normal" artwork object in an artwork layer, the separation is shown as a normal printing separation, with a square color patch. Since the use of a separation both as ink and for objects in Processing Steps usually presents a conflict, it is very likely that a message will appear in the Messages Side Drawer for any Processing Step Layer using such a separation.

### Move objects to ...

Using the **Move Objects to** function, you can move the objects using a specific separation into a Processing Step Layer.

1. Select a spot color separation in the separations list.
2. Select **Move objects to** from the fly-out menu underneath the separations list.
3. Select the **Processing Step Layer** you want to use.
4. ArtPro+ will try to move all objects using the selected separation to the selected Processing Step Layer.
  - Objects in a flat color, only using the selected separation, will be placed in a Processing Step Layer, with the same name as the original artwork layer they were in (when available). These objects will also be put in overprint (all other separations transparent).
  - Other objects (e.g. objects in a mixed color, images, ...) will not be moved nor changed.
  - If the separation is only used in the Processing Step Layers, it will become a Colorant. See [Processing Step Separations](#) on page 98

### 6.3.3. Processing Step Layers Overview mode

You can click the button  to switch the Layers section to **Processing Step Layers Overview** mode.

This view mode will collect and show layers based on the type: it will show a line for every type of Processing Step Layer defined in the document, or within a Placed Art, Step&Repeat Grid, .... For each type, you will only see one entry, even if multiple layers of that type are defined.

The Processing Step Layers Overview allows to view and change the printing state of all layers of the same type. Changing the printing state will change the visibility accordingly.

In case different layers of the same type have different printing states, this will be indicated by an unequal sign ≠.



**Note:** As Processing Step Layers are not supported in Normalized PDF, this functionality is not available for Normalized PDF files.

For Placed PDF and Structural Design files, you can use the **Layer Types Inspector** for the same purpose as the Processing Step Layers Overview mode: an overview of all types of layers defined in the document. See [Layer Types Inspector](#) on page 178

## 6.4. Object Browser



By clicking the **Object Browser** button  you can open the Object Browser.

The Object Browser has 3 modes:

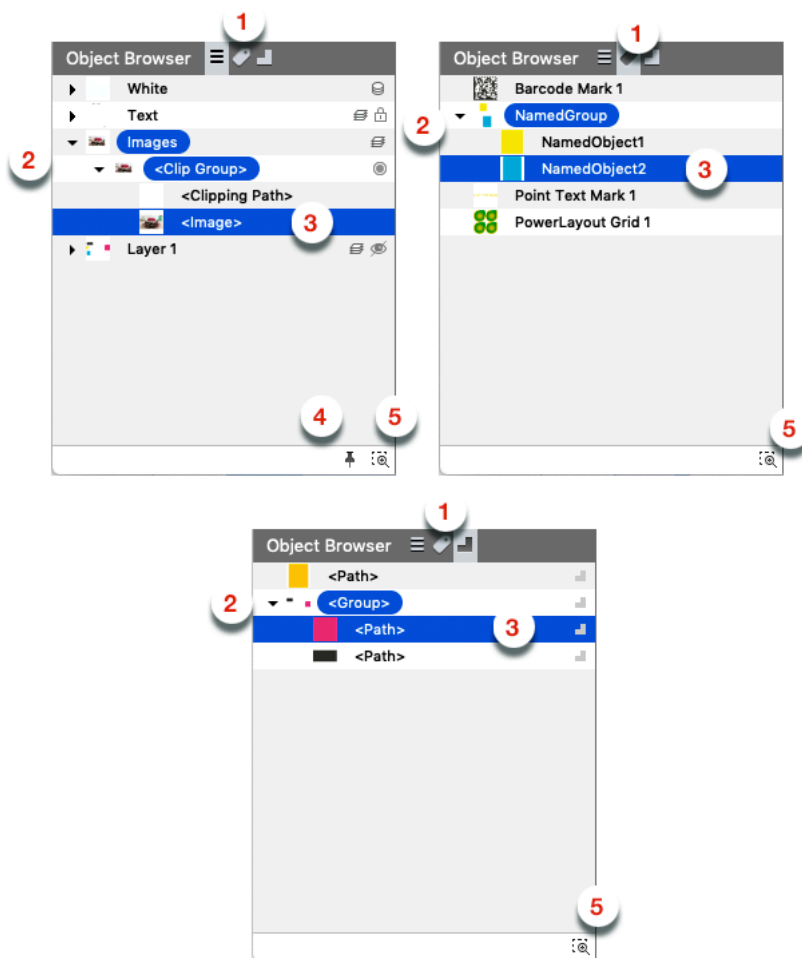
- the normal Object Browser , that lists all layers, groups and objects in the document, each with their thumbnail, ordered as the objects are ordered in the file (from top to bottom).
- the Named Object Browser , that shows all named objects and groups in the document in alphabetical order.
- The Trap Tagged Object Browser , that shows all objects and groups with a defined Trap Tag, ordered as the objects are ordered in the file (from top to bottom). See [Working with Trap Tags](#) on page 259



**Note:** Since Trap Tags are not available in Normalized PDF, this mode will not be available when working on a Normalized PDF.

1. Click the Object Browser button , the Named Object Browser button  or the Trap Tagged Object Browser button  to switch between the different modes.
2. Click the triangle in front of a layer or group to expand / collapse it.
3. Click Layers, groups or objects to select them.
  - a) You can select multiple objects by dragging on the items in the browser

- b) You can add to or remove from the selection by using the Shift or Cmd/ctrl key.
- c) By clicking and dragging, you can change the position of an object, group or layer. Doing so, you can change the order, take objects in or out of a group or layer, etc. This is not possible in Named Object Browser or the Trap Tagged Object Browser.
- 4. Enable the **Keep Expanded** button to keep all layers and groups expanded. When disabled, groups and layers in the object browser automatically expand/collapse to ensure that only the selected objects are selected in the object browser. This is not possible in Named Object Browser or the Trap Tagged Object Browser.
- 5. Enable **Zoom to Selection** to automatically zoom in on the object(s) you select in the object browser
- 6. Double-click an entry to change the name of the object, group or layer. See [Renaming objects, groups and layers](#) on page 119.
- 7. Control-click an entry and choose **Show** or **Hide** to change its visibility. You can also change the visibility of Layers in the Layers list (see [Visibility, Locking and Printing state](#) on page 95), and change the visibility of objects and groups using **Show** and **Hide** (see [Hiding objects](#) on page 77)

## 6.5. Separations

The **Separations** section lists all of the separations that are used in the current document.

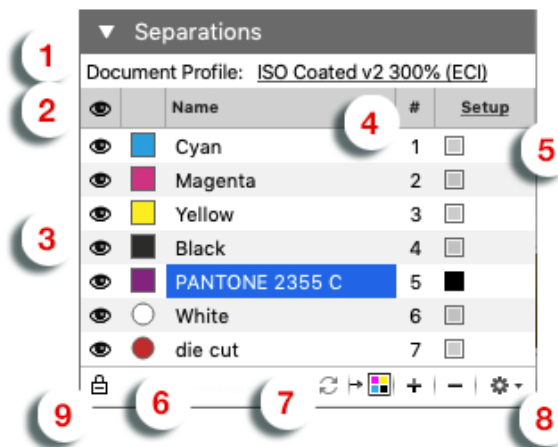

1. The **Document Profile**. See [Color Management](#) on page 77
2. The top icon shows an eye if all Separations are visible, and a "-" if at least one separation is invisible. You can click the icon to make all separations visible, or (in case all separations are already visible) to hide all separations. You can also Alt-click the header eye icon to toggle between all Separations visible, and the previous state.
3. You can change the visibility of the individual separations using the eye icons
  - You can click an eye icon to toggle visibility on or off.
  - You can click and drag over multiple icons to change the visibility of all those separations at once: they all get the same state as the first separation you clicked. For example, if you start clicking and dragging on a visible separation, you make this separation (and all other separations you drag) invisible

- You can Alt-click a separation icon to make that separation visible, and all others invisible. Alt-click and drag makes all of the involved separations visible, and all others invisible. Alt-clicking again changes the visibility of all separations back to the previous situation.
4. The **#** column shows the index number of the separation in the separations order.
  5. The **Type** column indicates the type of the separations. Clicking **Setup** or any of the Ink Type indicators will open the Separations Setup dialog. See [Separations Setup](#) on page 104
  6. The Color patch shows the color of the separation. It can be a square (Process inks and inks from an Ink Book), square with a white triangle (Custom Ink, see [Separations Setup](#) on page 104) or round (Processing Step Separation, see [Processing Step Separations](#) on page 98)
  7. The buttons:
    - Use the **Convert to CMYK** button  to convert the selected separation to CMYK. See [Convert to CMYK](#) on page 106
    - Use the **-** button to remove the selected separation(s). If one of the separation you try to remove is in use, a message will be shown.

**Note:** If your document contains non-white preserving blend modes (Difference, Exclusion, Hue, Saturation, Color or Luminosity) you will not be able to remove the process inks.

    - Use the **+** button to add a new printing separation. See [Adding or changing a separation](#) on page 103.
  8. The fly-out menu, also accessible by right-clicking a separation
    - You can select **Move Objects to** to move all objects using the selected separation into a Processing Step Layer. See [Processing Step Layers](#) on page 97 and [Move objects to ...](#) on page 99
    - You can select **Convert to CMYK** to convert the selected separation to CMYK. See [Convert to CMYK](#) on page 106.
    - You can select **Replace Separation by** to merge the selected separation with another separation in the list. The selected separation will be removed, and merged with the target separation, which keeps its properties. You can also merge a separation by dragging and dropping it on the target separation while holding the **Shift** key. To see what happens to the screening sets when merging separations, see [Screening when merging separations](#) on page 247
    - You can **Remove Unused Separations**
      - You can open the **Separations setup**. See [Separations Setup](#) on page 104
  9. Using the **Automatic Locking**, you can automatically lock all objects that do not use any of the visible separations. Since locked objects are shown in gray in outline mode, this function can be useful to distinguish between the outlines of objects that are using the separations that you are viewing, and objects that aren't using any of the separations. If the option is enabled, the visibility icon for every separation will switch between visible and locked (instead of invisible). See [Automatic Locking based on the visible separations](#) on page 108

### Numeric control

You can press the numbers 1 to 9 on your keyboard, to make the corresponding separation visible, and hide all others. Pressing the same number again will reset all separations to the state they were in before using the numeric keys.

You can press 0 to make all separations visible, and press 0 again to return to the previous state.

### Single separation preview

When only one separation is visible, 3 extra icons show up, allowing to inspect a single separation in different modes:



1. Color: the single separation is shown in its own color
2. Positive film: the single separation is shown in black
3. Negative film: the single separation is shown in black, but negative.

### Separation order

You can change the separation order by simply dragging and dropping one or more separations onto their new location.

### Unused Separations

Separations that are not used in any objects or images are shown as a grayed out separation name in the Separations list, but also in the Screening, Ink Coverage, Fill / Gradient / Stroke Inspector, etc.

When the document is reopened, unused separations are not listed anymore.

### Ink operations on a selection

If you remove separations, replace separations or convert separations to CMYK in the Separations section, the complete document is affected. If you want to remove separations, replace separations or convert separations to CMYK only for the selected objects, you can use the **Recolor** function. See [Recolor](#) on page 150

## 6.5.1. Adding or changing a separation

1. Click the **+** button to add a new separation, or double-click an existing separation to change it.
2. You can use the input field as a filter to search and select an ink from the available ink books, in the order defined in the Preferences. See [Preferences](#) on page 44.

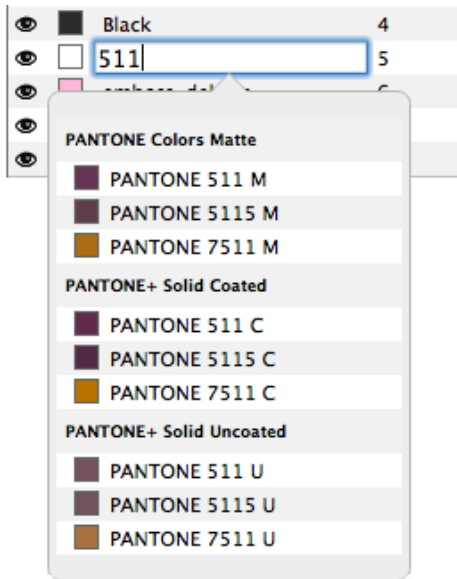

- You can click an ink in the search results to fill in the full name of the ink.
  - Entering the short version of an ink will find the corresponding ink in the available ink books, so it can easily be selected from the list, e.g. "Warm Red" will find the ink "PANTONE Warm Red C" and "reb" will find "PANTONE Reflex Blue C".
  - The search is case insensitive. If you type "green", the list will show both inks containing "green" and "Green" as search result.
- 3.** You can press Tab to create the ink and immediately start creating another separation. You can press Enter or Return or click outside the edit field to create the separation and stop adding separations. Use the **Esc** key to cancel.
- If the ink name doesn't exactly match any ink, hitting Enter will create a custom ink, indicated by a white triangle in the bottom right corner of the color patch.
  - If the ink name exactly matches an ink from the ink book, (e.g. after you clicked an ink in the list), that ink will be used.
  - "c", "m", "y" and "k" are automatically replaced by Cyan, Magenta, Yellow and Black.

**Note:** Unlike the search (see above), separation names in ArtPro+ are case sensitive, so you can e.g. have both a separation "Green" and "green".

- 4.** When creating a new custom ink, the **Colors** dialog allows to select the preview color for the separation. You can set the color definition in RGB, CMYK or LAB. Changing an existing separation to a (new) custom ink will maintain its color. You can double-click the color patch to change the color for any custom ink.

## 6.5.2. Separations Setup

Clicking **Setup** or any of the Ink Type indicators in the **Separations** section will open the Separations Setup dialog



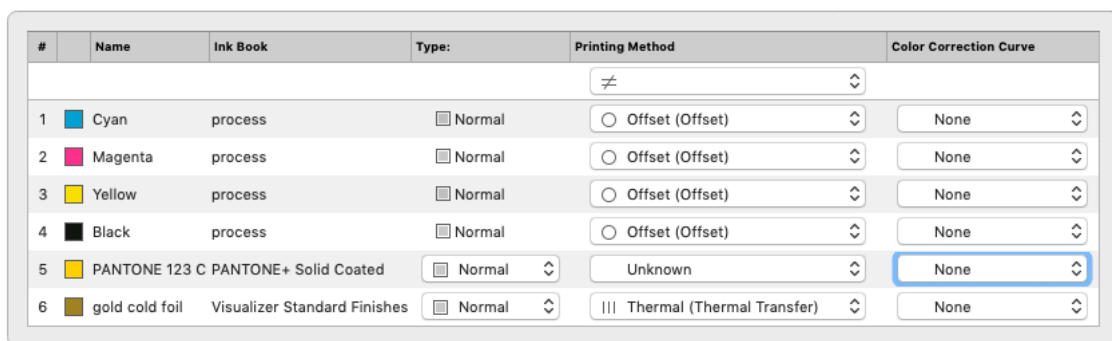

The Separations Setup shows all separations in the document.

Column	
1	The index of the separations (#)
2	The color patch for the ink. It can be a square (Process inks and inks from an Ink Book), square with a white triangle (Custom Ink, see below) or round (Processing Step Separation, see <a href="#">Processing Step Separations</a> on page 98)
3	the ink name
4	the ink book
5	the Separation Type. See below
6	The <b>Printing Method</b> . You can select one of the defined Printing Methods by selecting it in the dropdown, or select <b>Manage Printing Methods</b> to open the Printing Methods preferences. See <a href="#">Preferences</a> on page 44. Select a Printing Method in the topmost dropdown to set the Printing Method for all separations at once.
7	The PDF Correction Curves. See below

### Separation Types

#### Normal

By default, process separations are always "Normal".

#### Opaque inks

Inks that are defined as "Opaque" in the ink book can't be changed to another ink type.

Making an ink opaque will change the rendering of the file. Keep in mind that when using opaque inks, the printing order is very important for a correct preview.

#### Technical & Varnish inks

Technical and Varnish inks can only be used in Normalized PDF.

Technical inks will be treated as opaque printing separations, and will be saved as such. This means that when sent to a RIP, these separations will appear on the output.

When opening a regular PDF (so not a Normalized PDF) containing Technical inks, a message will be shown warning you about this behavior.

**Note:** In ArtPro and PackEdge, it is possible to change an opaque ink into a Varnish, which is not allowed in ArtPro+. When opening a file containing such inks, a warning will be shown.

In a PDF+ file, you can not use Varnish or Technical inks. To achieve a Varnish or the equivalent of a Technical ink, you can use Processing Step Layers. See [Processing Step Layers](#) on page 97.

### PDF Correction Curves

PDF Correction Curves are only available when working on a PDF+ document. See [PDF, PDF+ and Normalized PDF](#) on page 52

You can set a color correction curve for any separation to increase or decrease the highlights, midtones or shadows by 2 or 4%.

These color correction curves can be picked up by Imaging Engine version 20 or higher. In the "Image to Screened/Unscreened Separations" task, make sure you enable the **Use PDF transfer curves** option in the **PDF Objects** tab.

Correction curves are not applied on the Placed Art in the document (linked or embedded). If curves should be applied to the placed art, they have to be set in the one-up itself. If you select the Placed Art, the Placed Art Separations inspector shows if any curves are applied to any separations in the Placed Art.

## 6.5.3. Convert to CMYK

You can convert the selected separation to CMYK. This is not possible for Technical separations in a Normalized PDF.

1. Select the separation you want to convert to CMYK
2. Click the **Convert to CMYK** button  or select **Convert to CMYK** from the fly-out menu.

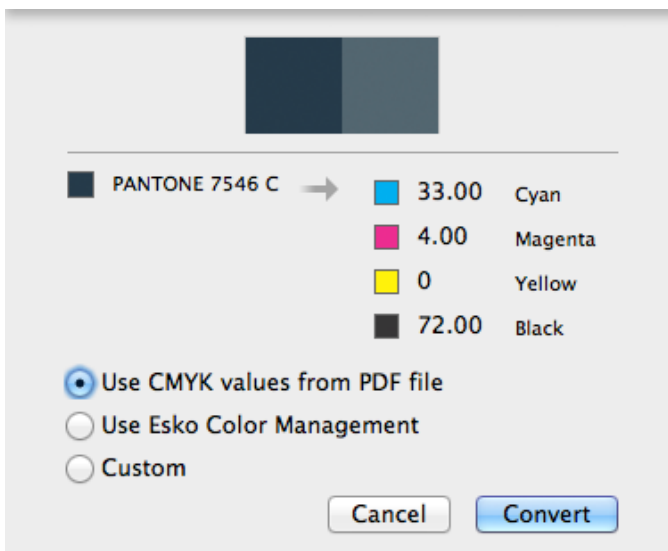

3. Select the CMYK values you want to use:
  - the CMYK values that are saved in the PDF file
  - the CMYK values using the Esko Color Management (not available for custom inks)
  - Custom values you can enter yourself.

4. Click **Convert**

### 6.5.4. Convert to Spot Color

Using the **Convert to Spot Color** function in the Colors Side Drawer, you can convert a CMYK color mix into a spot color.

Colors that are different tints of the same color mix are shown as a cluster, and can be converted to different tints of a single spot color.

1. Open the **Colors Side Drawer**. See also [The Colors Side Drawer](#) on page 88
2. Select the color mix you want to convert into a spot color.
3. Click the **Convert to Spot Color** button  at the bottom of the Colors Side Drawer, or right-click the color patch and select **Convert to Spot Color** for a single color, or **Convert all Tints to Spot Color** when working on a tint in a cluster.

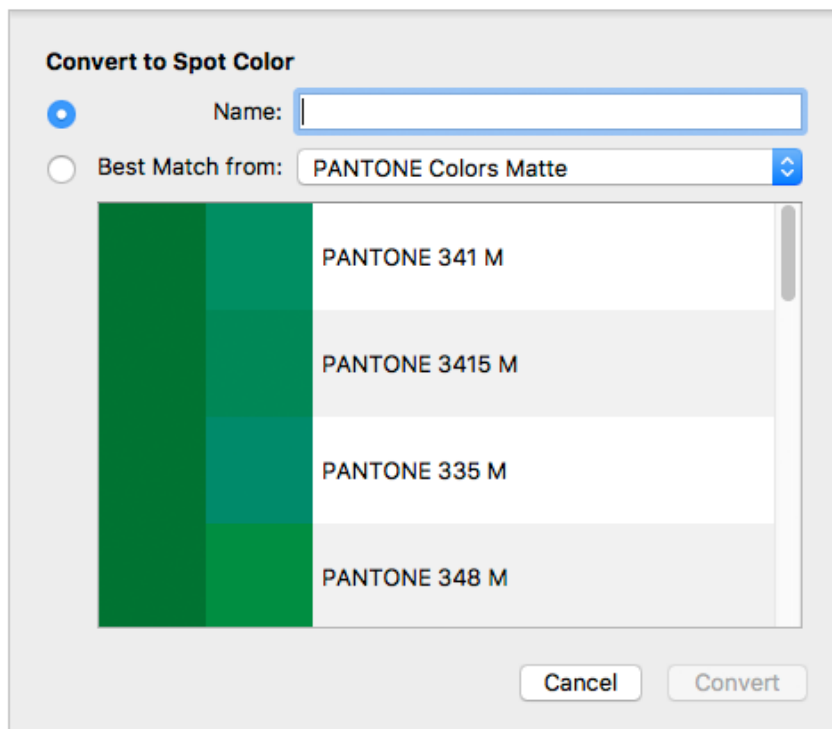

4. In the **Convert to Spot Color** dialog, you can select the target spot color:

- **Name:** Select the target spot color by entering the name or a part of the name. This works the same as adding a new separation. See [Adding or changing a separation](#) on page 103
- **Best Match:** Select the **Ink book** you want to use, and underneath the best matching spot colors from that Ink Book is shown. From left to right, you can see a color patch of the original color mix, a color patch of the spot color, and its name.















**Note:** The ink books in the dropdown are shown in the **Preferred Ink Book Order** as set in the Preferences. See [Preferences](#) on page 44

**5. Click Convert**

All objects that use the selected color mix will be converted. All converted objects will be selected after conversion. Also hidden or locked objects using the color mix will become visible and unlocked, and will be selected after the color conversion.

If you converted all tints of a color mix, all colors of the cluster are converted to a tint of the same spot color. In the example underneath you see

1. Before conversion: a cluster of 3 colors, i.e. 3 tints of the same color mix.
2. After conversion: 3 tints of the same spot color.

1		2	
Colors		Colors	
	1	 100	 80
	1	 50	 40
	1	 25	 20
			 20
			 10
			 5
			 100
			 50
			 25

**Note:**

- Only flat colors can be converted.
- The Overprinting State is not kept after conversion.
- You can only convert all tints in a cluster.

**6.5.5. Automatic Locking based on the visible separations**

By enabling the **Automatic Locking** option at the bottom of the Separations, you can automatically lock all objects that do not use any of the visible separations.

Since locked objects are shown in gray in outline mode, this function can be useful to distinguish between the outlines of objects that are using the separations that you are viewing, and objects that aren't using any of the separations.



- Enabling the option will first reset all locking (i.e. unlock any locked objects), and then lock all objects that do not use any of the visible separations.
- If the option is enabled, the visibility icon for the separations will switch between visible and locked. When the option is disabled, the visibility icon switches between visible and invisible (-), even though objects always stay visible in Outline mode, regardless of the separations they use.
- When the option is enabled, changing the visibility of a separation will reset the locking to match the visible separations, regardless of any manual locking you did in between.
- Editing the document (other than changing the visibility of a separation) will cause the locking to be out of sync. The Automatic Locking will show an open padlock icon. Changing the visibility of a separation, or re-enabling the option will resynchronise all locking.
- If you use the **Unlock All** function (see [Locking objects](#) on page 120), all locked objects become unlocked, and the **Automatic Locking** option is disabled.

Locking objects has the same result as manually locking objects: you can not select locked objects, the Object Browser shows a lock icon, and the outline of the objects are shown in gray in outline mode.

## 7. Selecting

---

Objects in the document can be selected by using one of the Select tools:

- The **Group Select Tool**  to select the highest level groups or objects. See [Group Select](#) on page 110
- The **Object Select Tool**  to select lowest level objects and compounds, even inside groups. See [Object Select](#) on page 111
- The **Path Select Tool**  to select paths within a compound.

**Note:** You can also select using the Transform tool, by clicking anywhere, or dragging outside of the bounding box of the selection. See [Transforming manually](#) on page 123

The selected objects are shown in the selection color. See Display Color for Selections in [Preferences](#) on page 44

### Modifier Key

You can use the **Cmd** (Mac) or **Ctrl** (Windows) Modifier Key

- to temporarily switch to the last used Select Tool if another tool is selected.
- to temporarily switch from Group Select to Object Select tool or vice versa.

### Select / Deselect All, Inverse

You can also use one of the special **Select** functions:

- Use **Select > Select All** or its shortcut **Cmd+A** (Mac) or **Ctrl+A** (Windows) to select all visible and unlocked objects.
- Use **Select > Deselect All** or its shortcut **Cmd+Shift+A** (Mac) or **Ctrl+Shift+A** (Windows) to deselect everything.
- Use **Select > Select Inverse** or its shortcut **Cmd+Alt+A** (Mac) or **Ctrl+Alt+A** (Windows) to invert the selection: selected items become deselected, unselected objects become selected.

**Note:** While editing an object using the **Create & Edit Path** tool, Select All, Deselect All and Select Inverse will work on the anchor points of the object. See [Create & Edit Path](#) on page 132

**Note:** Making a layer invisible, will deselect all objects in that layer.

### 7.1. Group Select

---

**Group Select**  is the default selection tool. You can select it from the Tool Selector, or by its shortcut **V**, toggling with Object Select, Path Select and Lasso Select.

**Note:**

You can use the **Cmd** (Mac) or **Ctrl** (Windows) Modifier Key

- to temporarily switch to the Group Select Tool if another tool is selected, and if the Group Select tool was the last used select tool.
- to temporarily switch to Group Select if the Object Select tool is selected.

- Click in an object or on its path (see [Selecting in Preview or in Outline Mode](#) on page 113) to select the highest group the object belongs to. If the object doesn't belong to a group, this will select the entire object, compound path or image plus clipmask.
- Drag a selection rectangle to select everything entirely within the selection rectangle. Objects inside a group will only be selected if all objects in the group are completely in the selection rectangle.

**Note:**

If the Crosshair is rotated, the selection rectangle you drag will be rotated the same way. See [Move or rotate the Crosshair](#) on page 75

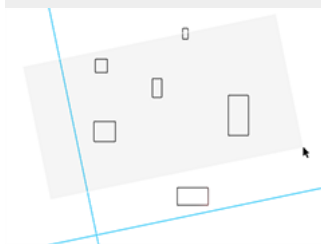

- Click on an empty space in the document to deselect all objects
- Using the Shift key while selecting inverts the selection of the objects. A deselected group or object is selected and vice versa. You can use this to add objects to the selection, or remove them from the selection.

## 7.2. Object Select

You can select the **Object Select** tool  from the Tool Selector, or by its shortcut **A** or the shortcut **V**, toggling with Group Select, Path Select and Lasso Select.

**Note:**

You can use the **Cmd** (Mac) or **Ctrl** (Windows) Modifier Key

- to temporarily switch to the Object Select Tool if another tool is selected, and if the Object Select tool was the last used select tool.
- to temporarily switch to Object Select if the Group Select tool is selected.

- Click in an object or on its path (see [Selecting in Preview or in Outline Mode](#) on page 113) to select the smallest path you click on, i.e. an object inside a group, the clip path of an image or the image in a clipped image group.

- If a selected object or group is part of a group or clipped image group, the Object Select cursor will have a plus sign when hovering over it.  Clicking again while in this Plus mode will select the next level group of the clicked group, without changing other selections. You can do this repeatedly to climb higher in the group structure.

- Drag a selection rectangle to select every object entirely within the selection rectangle.

**Note:** If the Crosshair is rotated, the selection rectangle you drag will be rotated the same way. See [Move or rotate the Crosshair](#) on page 75.

- Click on an empty space in the document to deselect all objects.
- Using the Shift key while selecting inverts the selection of the objects. A deselected group or object is selected and vice versa. You can use this to add objects to the selection, or remove them from the selection.

**Note:** Live text, compound paths and other Protected objects (such as SmartMarks, see [Protected objects](#) on page 138) are considered as 1 single object, even though they may seem to consist of multiple elements. Outlined text can be selected path by path.

## 7.3. Path Select

---

You can select the **Path Select** tool  from the Tool Selector, or by its shortcut **A** or the shortcut **V**, toggling with Group Select, Object Select and Lasso Select. Using this tool, you can select a path that is part of a compound, while the Object Select tool selects the complete compound.

**Note:** You can use the **Cmd** (Mac) or **Ctrl** (Windows) Modifier Key to temporarily switch to the Path Select Tool if another tool is selected, and if the Path Select tool was the last used select tool.

- In Outline mode, click on a path (e.g. a compound path) to select the smallest path in there, e.g. one of the paths that are part of the compound. If you click a path in Preview mode, the complete compound the path belongs to will be selected.
- In Outline or Preview mode, drag a selection rectangle to select every path entirely within the selection rectangle.

**Note:** If the Crosshair is rotated, the selection rectangle you drag will be rotated the same way. See [Move or rotate the Crosshair](#) on page 75.

- If a selected path is part of a compound, group or clipped image group, the Path Select cursor will have a plus sign when hovering over it.  Clicking again while in this Plus mode will select the next level up, e.g. the complete compound or group, without changing other selections. You can do this repeatedly to climb higher in the structure.
- Click on an empty space in the document to deselect all objects.
- Using the Shift key while selecting inverts the selection of the objects. A deselected path or object is selected and vice versa. You can use this to add objects to the selection, or remove them from the selection.

You can delete a path inside a compound, cut / copy it or transform it (move, scale, rotate). All other actions will affect the complete compound. If you paste a path copied this way, it will be part of a new compound.



**Note:** Live text and other Protected objects (such as SmartMarks, see [Protected objects](#) on page 138) are considered as 1 single object, even though they may seem to consist of multiple elements. Outlined text can be selected path by path.

## 7.4. Selecting in Preview or in Outline Mode

---

Selecting can work differently in Preview Mode or in Outline Mode.

### Group Select and Object Select

In Preview mode, you can click anywhere **in** an object to select it (or the group it belongs to). This will select the topmost object. You can use **Select Next / Previous:** see [Select Next Object / Select Previous Object](#) on page 117

In Outline mode, if **Select > Select by Paths (Outline mode)** is enabled, you can click **on** an object or path to select it (or the group it belongs to).

If **Select > Select by Paths (Outline mode)** is disabled, you can click anywhere **in** an object to select it. This will select the topmost object. You can use **Select Next / Previous:** see [Select Next Object / Select Previous Object](#) on page 117

See also [Group Select](#) on page 110 and [Object Select](#) on page 111

### Path Select

In Outline mode, you can click on a path (e.g. a compound path) to select the smallest path in there, e.g. one of the paths that are part of the compound. If you click a path in Preview mode, the complete compound the path belongs to will be selected.

In Outline or Preview mode, drag a selection rectangle to select every path entirely within the selection rectangle.

See also [Path Select](#) on page 112

### Special cases

The following objects can only be selected by clicking **on** the path:

- Clipping Paths
- Structural Design objects
- Open paths and open compounds

Text can only be selected by clicking on a character.

## 7.5. Lasso Select

---



You can select the **Lasso Select** tool from the Tool Selector, or by its shortcut **L** or the shortcut **V**, toggling with Group Select, Path Select and Object Select.

**Note:**

You can use the **Cmd** (Mac) or **Ctrl** (Windows) Modifier Key to temporarily switch to the Lasso Select Tool if another tool is selected, and if the Lasso Select tool was the last used select tool.

- Click and drag an area to select all paths completely within the drawn area. This can be regular paths, but also objects inside a group, the clip path of an image or the image in a clipped image group.  
While dragging, a lightly colored area will indicate what area will be selected.
- Click on an empty space in the document to deselect all objects.
- Using the Shift key while selecting inverts the selection of the objects. A deselected group or object is selected and vice versa. You can use this to add objects to the selection, or remove them from the selection.

**Note:** Live text, compound paths and other Protected objects (such as SmartMarks, see [Protected objects](#) on page 138) are considered as 1 single object, even though they may seem to consist of multiple elements. Outlined text can be selected path by path.

## 7.6. Selection Breadcrumbs

The Selection Breadcrumbs show the selection in the hierarchy of layers and groups. The Selection Breadcrumbs appear on top of the document window if anything is selected.



1. The left-most element shows the highest level: the **Layer** containing the selection.
2. The left-most highlighted crumb indicates the current **selection**. Other highlighted crumbs are part of the selection.
3. The right-most element can indicate the **origin** of the selection (See below)

The Breadcrumbs show the grouping structure: every element is a part of the element on its left side. In this example, the Path (3) is part of a Group, which is part of another Group (the current selection). This selected group is part of a named group "NamedGroup", on a layer "Artwork".

**Note:** Generic objects are shown between brackets, such as "<Group>". Named objects are shown by their name.

### The Origin of the selection

The **Origin** of the selection is the object or path you clicked on using the select tool.

When clicking on an object using the **Object Select** tool, you will select the object you clicked on. The Origin is the same as the Selection.

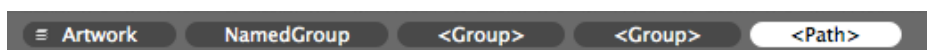

When clicking on that same object using the **Group Select** tool, the Origin will be the object you clicked on, while the selection will be the topmost group that object belongs to.

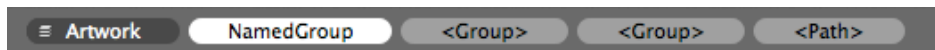

You can click each breadcrumb to broaden the selection to a higher group or refine it to a lower group or to the object you initially clicked.

**Note:**

In some cases, ArtPro+ will not have an origin to show, for example if you add to the selection by clicking while holding the Shift button, or if the origin was lost because of a change in the selection.

In that case, the breadcrumbs can show **Multiple** if multiple objects or groups within the same group are selected, or **All** if all elements within the group are selected.

You can rename objects, groups and layers by double-clicking a breadcrumb. See [Renaming objects, groups and layers](#) on page 119

## 7.7. Select Same

**Note:** The availability of this functionality depends on your license of ArtPro+. See [Licensing](#) on page 25

Using the **Select Same** tool, you can quickly select objects with the same properties as the current selection.

1. Select one or more objects
2. Choose **Select > Select Same...**, click the **Select** button or use its shortcut **Cmd+U** (Mac) or **Ctrl+U** (Windows) to open the Select Same window.

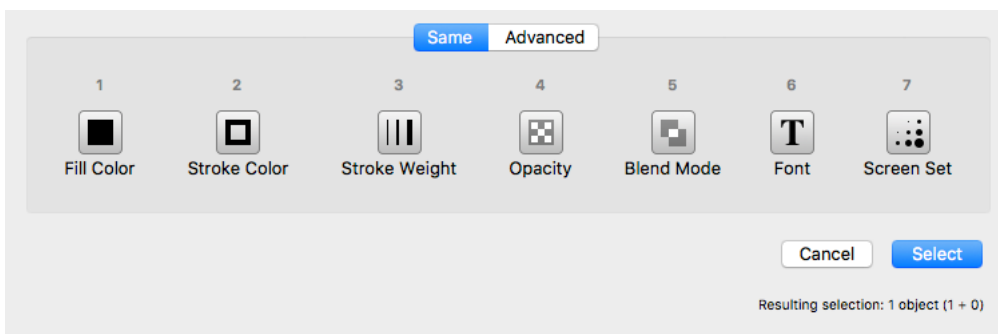

3. Select one or more criteria to take into account, either by clicking the button or by pressing the corresponding number key (1 - 7)

**Note:** If the currently selected objects have different values for a criterion (represented by the ≠ symbol) or if the criterion is not available (e.g. font when no text objects are selected), this selection criterion will not be available

4. Click **Select**

All (visible) objects in the document that have the same properties (e.g. the same Fill Color and Stroke Color) as the current selection will be selected.

There is also a quick way to select objects with the same Fill Color or Stroke Color:

- Choose **Select > Select Same Fill Color** or use the shortcut **Cmd+Alt+i** (Mac) or **Ctrl+Alt+i** (Windows)
- Choose **Select > Select Same Stroke Color** or use the shortcut **Cmd+Alt+Shift+i** (Mac) or **Ctrl+Alt+Shift+i** (Windows)

**Note:**

By switching to the **Advanced** tab, you can select based on specific criteria. See [Select Advanced](#) on page 116.

You can switch between the two tabs using the **/** key.

## 7.8. Select Advanced

**Note:** The availability of this functionality depends on your license of ArtPro+. See [Licensing](#) on page 25

Using the **Select Advanced** tool, you can quickly select objects based on a number of criteria.

1. Choose **Select > Select Same...**, click the **Select** button or use its shortcut **Cmd+U** (Mac) or **Ctrl+U** (Windows) to open the Select Same window, and then select the **Advanced** tab.

**Note:** You can switch between the two tabs using the **/** key.

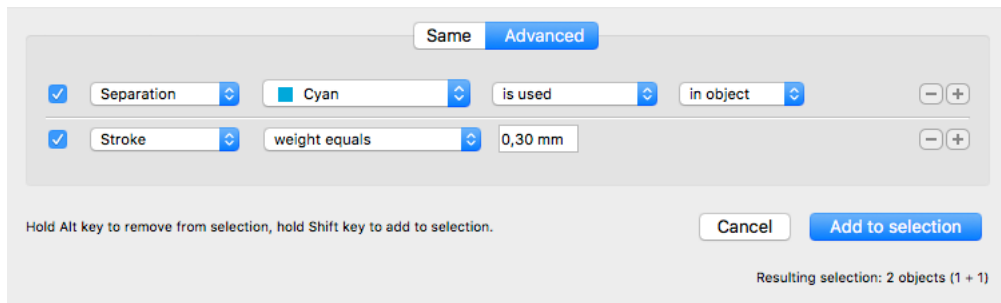

2. Set the criteria using the dropdown menus. Use the plus key to add a line, or the minus key to remove it.

**Note:** At the bottom right of the dialog you can see how many objects will be selected if the selection is done based on the current criteria, taking into account the Alt or Shift modifier (see below).

3. Click **Select** to (only) select the objects matching **all** of the criteria
  - Hold the Alt key and click **Remove from selection** to deselect objects matching **all** of the criteria
  - Hold the Shift key and click **Add to selection** to add objects matching **all** of the criteria to the current selection

## 7.9. Select Next Object / Select Previous Object

---

**Select Next Object** and **Select Previous Object** offer you the possibility to select objects that are covered by other objects for faster access.

1. Click on the spot you want to inspect, using one of the tools that selects by clicking **in** an object:
  - **Group Select, Object Select** and the **Transform** tool in Preview mode
  - **Group Select, Object Select** and the **Transform** tool in Outline mode if **Select > Select by Paths (Outline mode)** is disabled

The topmost object or group will be selected.

2. Choose **Select > Select Next Object** or use the shortcut **Ctrl+Tab** to select the next (not hidden) **object** underneath, regardless of the tool used to make the original object or group.

All Inspectors will show the parameters of the selected object. Every time you press Ctrl+Tab the next object is selected. Briefly, a Point Indicator shows up to indicate on what location the objects are inspected. Once the lowest object is reached, the topmost object of the session is selected again.

3. Choose **Select > Select Previous Object** or use the shortcut **Ctrl+Shift+Tab** to do the same but in the reverse order: every time you click, the **object** on top is selected. When the topmost object is selected, using **Ctrl+Shift+Tab** will select the bottommost object

## 8. Editing

### 8.1. Undo and Redo

The **Undo** and **Redo** function allows to undo your changes step by step. The menu items in **Edit > Undo** and **Edit > Redo** will show the next action that can be undone or redone.

To undo or redo an action:

- Select **Edit > Undo [action]** to undo, and **Edit > Redo [action]** to redo the undone action.
- Use its shortcut **Cmd+Z** (Mac) or **Ctrl+Z** (Windows) to undo
- Use the shortcut **Cmd+Shift+Z** (Mac) or **Ctrl+Shift+Z** (Windows) to redo

**Note:** If the action you Undo or Redo is on a different page in the document, ArtPro+ will automatically navigate to this page. See [Navigating a multi-page document](#) on page 91

### 8.2. Cut, Copy and Paste

**Cut** deletes the selected objects from the document and places them on the clipboard.

**Copy** puts a copy of the selected objects on the clipboard. The original objects are not removed from the file.

All properties of the cut or copied objects are stored in the clipboard. One of the consequences of this, is that if you paste an object, the separations used by that object are added to the document.

**Note:** When selecting elements of a group without selecting the group as such, the group information is not copied. Partially copied content of sublayers will be copied as a group.

**Paste** puts the clipboard objects in the active file.

You can paste the cut or copied objects into the same file or into another file. When pasting in another document, inks from the source document that don't exist in the target document will be created.

Quitting ArtPro+ clears the clipboard.

**Note:** The objects are pasted at the same position relative to the center of the Crosshair, even if the Crosshair is invisible when copying or when pasting.

In the Edit menu	Shortcut (Mac)	Shortcut (Windows)	Result
<b>Cut</b>	<b>Cmd+X</b>	<b>Ctrl+X</b>	places the selected objects on the clipboard
<b>Copy</b>	<b>Cmd+C</b>	<b>Ctrl+C</b>	copies the selected objects on the clipboard

In the Edit menu	Shortcut (Mac)	Shortcut (Windows)	Result
<b>Paste</b>	<b>Cmd+V</b>	<b>Ctrl+V</b>	pastes the objects on the clipboard in the active Layer, on top of any other objects in that layer.
<b>Paste in Front</b>	<b>Cmd+F</b>	<b>Ctrl+F</b>	pastes the objects directly on top of the topmost selected object and in the same layer as this object.
<b>Paste in Back</b>	<b>Cmd+Shift+F</b>	<b>Ctrl+Shift+F</b>	pastes the objects directly below the lowest selected object and in the same layer as this object.
<b>Paste with Layer Structure</b>	<b>Cmd+Shift+V</b>	<b>Ctrl+Shift+V</b>	pastes the objects in the same layers as they were when copying (the "source" layers).

When pasting with the Layer Structure:

- If a source layer name matches a layer in the current document (case sensitive), the objects will be pasted in that layer, on top of all objects in that layer.

**Note:** Even if they have the same name, a Processing Step layer and a regular artwork layer will never be merged. A new Processing Step layer or Artwork layer will be created. For more information on Processing Step layers, see [Processing Step Layers](#) on page 97

- When pasting in a Normalized PDF, objects from Processing Step layers are pasted into a regular artwork layer with the same name as the Processing Step layer. For more information on Processing Step layers, see [Processing Step Layers](#) on page 97
- If a source layer doesn't exist in the current document, it will be created on top of the current layers, and have the same printability state as the source layer.
- You can't paste into a hidden layer. If the target layer is hidden, you will get the option to cancel or to make the target layers visible before pasting.

## 8.3. Handling Objects

---

### 8.3.1. Renaming objects, groups and layers

You can (re)name an object, group or layer by double-clicking an entry in the breadcrumbs, by double-clicking an entry in the object browser, or by right-clicking an entry in the object browser and selecting "Rename".

- You can't rename <all> and <Multiple> breadcrumbs
- Clipping paths can not be renamed
- If you change a Layer name, the Layers list is updated accordingly.
- You can't change the name of hidden objects or hidden layers in the Object Browser
- Changing the name of an Image does not change the names shown in the Images browser.

- Named objects created in ArtPro or PackEdge will keep their name in ArtPro+. Object names given in ArtPro+ are recognized by PackEdge, but not when importing back in ArtPro.

### 8.3.2. Delete

You can delete one or more objects, by selecting them and using the **delete** or **backspace** key.

### 8.3.3. Hiding objects

Using the **Hide** function, you can hide the selected objects.

Hidden paths are no longer visible and cannot be selected nor modified. Still, they are saved with the file, so they will become visible again, when the file is next opened. You can apply this function multiple times, to hide additional objects.

**Show All** makes all hidden paths visible again.

It will deselect all paths in the current job first and then show the hidden paths, which will come back selected. This allows you to check something and then immediately **Hide** them again.

- Select **Object > Hide** or its shortcut **Cmd+3** (Mac) or **Ctrl+3** (Windows)
- Select **Object > Show All** or its shortcut **Cmd+Alt+3** (Mac) or **Ctrl+Alt+3** (Windows)

### 8.3.4. Locking objects

Using the **Lock** function, you can lock the selected objects. Locked objects are still visible but cannot be selected nor modified. In Outline mode, the outlines of locked objects are shown in gray.

**Unlock All** unlocks all locked objects and selects them.

- Select **Object > Lock** or its shortcut **Cmd+2** (Mac) or **Ctrl+2** (Windows)
- Select **Object > Unlock All** or its shortcut **Cmd+Alt+2** (Mac) or **Ctrl+Alt+2** (Windows)

In a number of situations, all locked objects become unlocked automatically:

- when saving and reopening the document, since locking isn't saved.
- when switching to a different page of a multipage document
- when entering Edit Opacity Mode, Edit Placed Art Mode or Edit Marks Mode.
- when preflighting the document.
- when applying an Action List (only the affected objects become unlocked)
- when using the Automatic Locking. See [Automatic Locking based on the visible separations](#) on page 108

### 8.3.5. Arrange objects

Using the **Arrange** function, you can change the order of the objects within their layer or group.

- Select **Object > Arrange > Bring to Front** or its shortcut **Cmd+5** (Mac) or **Ctrl+5** (Windows)
- Select **Object > Arrange > Bring Forward** or its shortcut **Cmd+Alt+5** (Mac) or **Ctrl+Alt+5** (Windows)
- Select **Object > Arrange > Send Backward** or its shortcut **Cmd+Alt+6** (Mac) or **Ctrl+Alt+6** (Windows)



- Select **Object > Arrange > Send to Back** or its shortcut **Cmd+6** (Mac) or **Ctrl+6** (Windows)

**Note:** An object that is inside a group can only be arranged within the group. If you need to arrange it further up or down in the layer, you can use cut and paste to take the object out of the group.

### 8.3.6. Group objects

Using the **Group** function, you can create a group of multiple objects, compounds or groups.

Making a Group keeps the color of the individual objects, and their relative order. The complete group is placed at the location (position and layer) of the topmost selected object.

- Select **Object > Group** or its shortcut **Cmd+G** (Mac) or **Ctrl+G** (Windows) to group the selected objects and/or groups.
- Select an entire group and choose **Object > Ungroup** or its shortcut **Cmd+Shift+G** (Mac) or **Ctrl+Shift+G** (Windows) to release the group. All components return to their previous state as path, compound or group.

**Note:** If you release a group that contains Group Transparency, you will get a warning that the transparency will be lost.

**Note:** The result of ungrouping can still contain groups. You can apply "Ungroup" multiple times until there are only individual objects left.

### 8.3.7. Compound

With **Make Compound** all the selected paths will become one single object.

Where paths are overlapping, a look-through window to the background is created (this is an "even-odd" compound path). As a compound is one object, it can have only one color, so when paths with different colors are compounded, they will be filled with the paint style of the object at the bottom of the selection. The compound is placed at the location (position and layer) of the bottommost selected object. If this bottommost selected object is a user named object made in PackEdge, the compound path will take over this name.

- Select **Object > Compound > Make** or its shortcut **Cmd+9** (Mac) or **Ctrl+9** (Windows) to make a compound of the current selection.
  - At least two objects are needed to make a compound path.
  - Both "even-odd" and "non-zero winding" compounds are supported, but compounds made in ArtPro+ will always be "even-odd".
  - The compound will inherit the fill and stroke color, the halftone information and the location of the bottom-most object in the selection.
  - Protected objects (such as unsupported Barcodes, SmartMarks, ...) and live text can not be compounded. If a selection contains Protected objects or text, you will get a warning, and these objects will not be included in the compound. If there are less than two objects remaining in the selection, no compound will be made. See [Protected objects](#) on page 138

- If the bottom-most object of the compound has a clipping path, this clipping path will stay when compounding and remains a separate object (not part of the compound path). This clipping path will be put in a Clipping Group with the compound path. Clipping paths linked to other objects in the selection are removed.
- Select one or more compounds and choose **Object > Compound > Release** or its shortcut **Cmd+Alt+9** (Mac) or **Ctrl+Alt+9** (Windows) to release all selected compounds.
  - All components will keep the color of the compound after releasing.
  - If a clip was applied to the compound, all released objects will be clipped by this clipping path.

### 8.3.8. Placeholder objects

Placeholder objects are objects that are only used to indicate a specific location.

- A StationNumber placeholder indicates the position of the Station Number in a MFG or CFF2 based repetition. See [Station Numbering in an MFG / CF2 workflow](#) on page 280
  - A TrimmableFlap or BleedingFlap indicates what flaps can be trimmed and what flaps should bleed when used in a S&R Nested workflow, either in ArtPro or in Automation Engine
1. Open the PDF of the one-up document.
  2. Create or select an object (a rectangle, a path, a text box, ...) and position it where you want to place the station number, or on top of the flap you want to set.
  3. Select **Object > Convert to Placeholder**
  4. Select the placeholder **Type** and click **OK**

The object loses its fill, stroke, text, .. and is converted to a placeholder object. You can still change the name, position and orientation of the object.

If needed, you can add more placeholders to the job.

The Placeholder object can now be used in the Step & Repeat workflow:

- **StationNumber**: see [Station Numbering in an MFG / CF2 workflow](#) on page 280
- To use a TrimmableFlap or BleedingFlap placeholder, apply the one-up PDF document in a Step&Repeat Nested workflow in either ArtPro or Automation Engine, and enable the "Get from File" option for Trim & Bleed. For more information we refer to the ArtPro or Automation Engine documentation.

## 8.4. Editing objects

---

### 8.4.1. Transforming objects

You can transform the selected objects in different ways:

- transform manually using the **Transform** tool: see [Transforming manually](#) on page 123
- do a numeric transformation using the **Numeric Transform**: see [Numeric Transform](#) on page 125
- you can do limited transformation by changing values in the **Transformation Inspector**. See [Transformation Inspector](#) on page 127

- You can use **Transform Again** to repeat the last performed transform. See [Transform Again](#) on page 127
- You can use **Align & Distribute**

**Note:** Protected objects (such as unsupported barcodes, SmartMarks, ...) can not be transformed. If a selection contains Protected objects, these objects will not be transformed along with the other (regular) objects, but stay part of the selection. See [Protected objects](#) on page 138

### Transforming manually

Using the **Transform** tool, you can manually transform the selected objects.

1. Select the **Transform** tool, either by selecting it in the Tool Switcher (see [Changing tools](#) on page 38) or by its shortcut **E**, toggling with **Align & Distribute**. See [Align & Distribute](#) on page 128.

When the Transform tool is active, the bounding box of the selected object(s) is shown (1), with 8 handles on it (2).

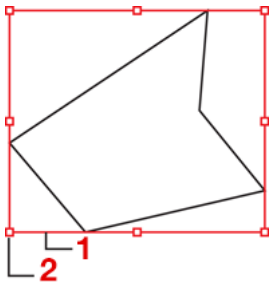



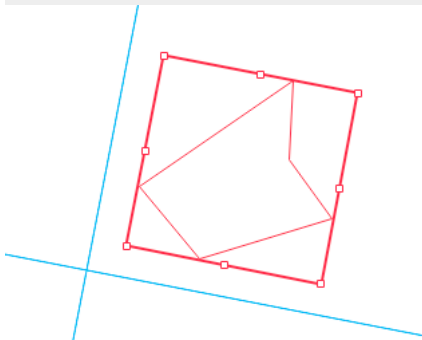

**Note:**

If the crosshair is rotated, the bounding box will follow this rotation.

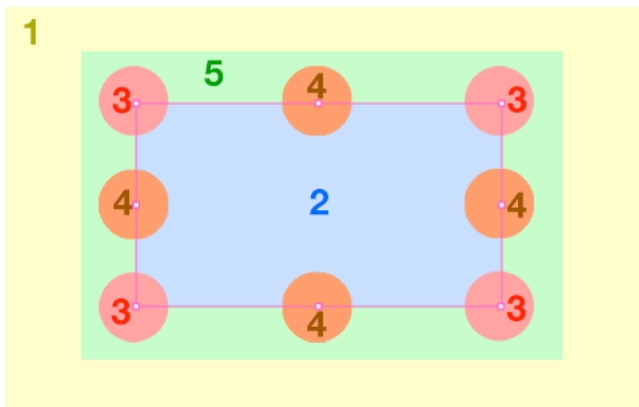

2. The **Interactive Transform Tool** can be used for 4 functions : selecting, moving, scaling and rotating. The function depends on the location you click.





- a)  Click anywhere, or drag outside of the bounding box of the selection (1), to use the tool to **select**. The tool works the same way as the regular Group Select tool. See [Selecting](#) on page 110
- b)  Click and drag inside the bounding box of the selection (2) or use the **arrow keys** to **move** the selection. See [Move](#) on page 124
- c)  Click and drag on one of the corner handles (3) or the center handles (4) to **scale** the selection. See [Scale](#) on page 124
- d)  Click outside but close to the bounding box of the selection (5) to **rotate** the selection. See [Rotate](#) on page 125

**Move**

-  Click and drag inside the bounding box of the selection to **move** the selection.
- Use the **arrow keys** to move the selection over the fixed **Keyboard increment** distance defined in the preferences, or over 10 times that distance when holding the shift key. See [Preferences](#) on page 44
- Hold the **Cmd** key (Mac) or **Ctrl** key (Windows) while using the **arrow keys** to move and snap the bounding box of the selected objects onto the Crosshair.
- Hold the **ALT** key to keep the original objects. This will result in copying the objects.

**Scale**

-  Click and drag on one of the corner handles to **scale** the selection.
-  Click and drag one of the centers of the bounding box borders to **scale** the selection only in vertical or horizontal direction.
- Hold down the **Shift** key to apply proportional scaling.

When visible, the **Crosshair** is used as reference point. For more information on the Crosshair, see [The Crosshair](#) on page 75

If the Crosshair is hidden, the handle on the opposite site of the bounding box is used as reference point when scaling:

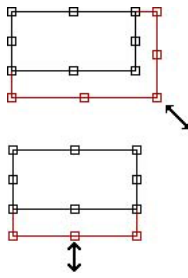

You can use the center of the bounding box as reference point by holding the **ALT** key, regardless of the Crosshair's visibility state.

### Rotate

-  Click outside but close to the bounding box of the selection to **rotate** the selection.
- Hold down the **Shift** key to constrain the rotation angle to multiples of 45 degrees.
- Use the shortcut **Alt + Spacebar** (Mac) or **Shift + Alt + Spacebar** (Windows) to rotate the selection 90 degrees clockwise
- Use the shortcut **Shift + Spacebar** to rotate the selection 90 degrees counterclockwise

When visible, the **Crosshair** is used as reference point. For more information on the Crosshair, see [The Crosshair](#) on page 75

However, if the Crosshair is hidden, or when holding the **ALT** key while rotating manually, the center point of the bounding box is used as center of the rotation.

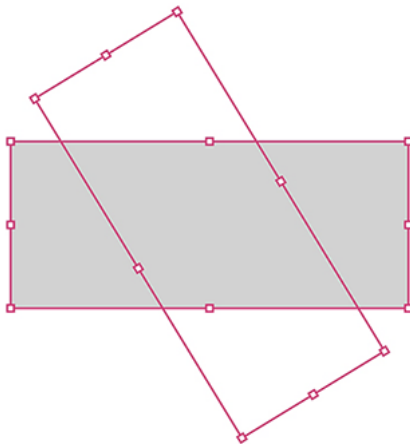

### Numeric Transform

Using the **Numeric Transform** function, you can numerically transform the selected objects.

You can open the **Transform** window, either by choosing **Object > Transform** or by its shortcut **Cmd + Shift + M** (Mac) or **Ctrl + Shift + M** (Windows).

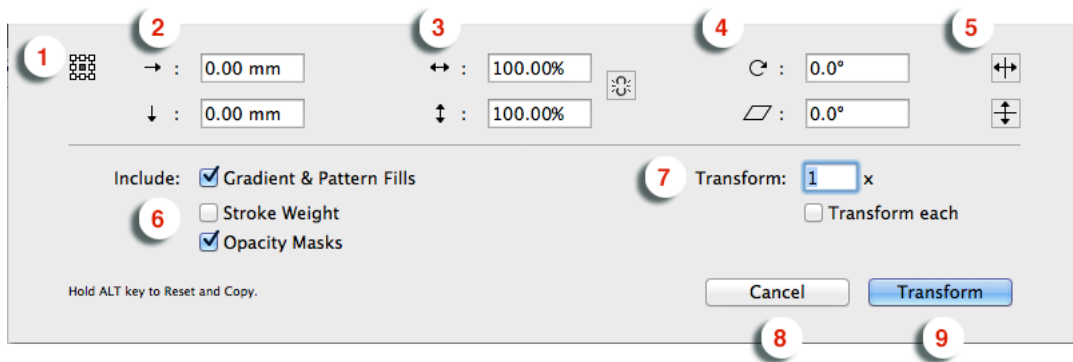

1. Define the **reference point** for the transformation by selecting one of 9 points. The corresponding point on the bounding box of the selection is used as reference point. However, if the Crosshair is visible, the center of the Crosshair is used as reference point. See [The Crosshair](#) on page 75

In the example underneath you see an example of rotating using the center (left) or the top left corner (right) as reference point.

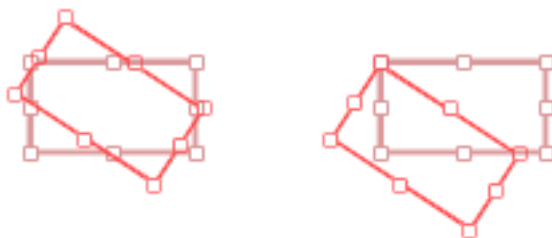

2. Define the **Move Distance**
3. Define the **Scaling**. If the **Link** option next to the scaling fields is enabled, scaling will be proportionally.
4. Define the angle for **Rotation** and for **Shearing**.
5. Enable the **Mirror** buttons to mirror the selection vertically or horizontally
6. Define if you want to **Include** the Gradient & Pattern Fills, Stroke Weight and Opacity Masks in the transformation. When disabled, transforming the selection will leave the Gradation & Pattern Fills, Stroke Weight and/or Opacity Masks unchanged.
7. Define the number of times you want to perform the transformation.
8. By default, the selected objects are transformed as one, with one reference point. If you want to transform each object in the selection individually, each with their own reference point, you can enable **Transform each**. This option can not be combined with using the Crosshair as reference point.

The example underneath shows a scaling by 200%, with "Transform Each" disabled (A) and enabled (B)

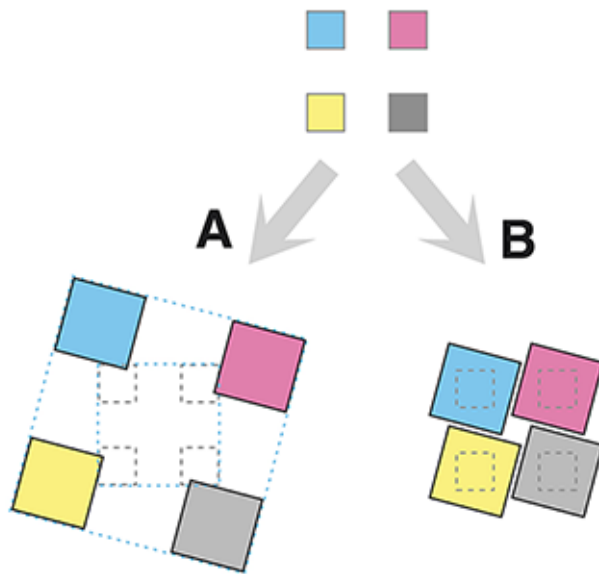

9. Click the **Cancel** button to close the dialog without transforming, or hold the ALT key and click the same button to **Reset** all settings to their default value.
10. Click the **Transform** button to apply the transformation to the selection, or hold the ALT key and click the same button to **Copy** the selection. The selection will be transformed, while the original objects are kept as well.

### Transform Again

Select **Object > Transform Again** or its shortcut **Cmd+D** (Mac) or **Ctrl+D** (Windows) to repeat the previous transform.

### Transformation Inspector

The Transformation Inspector shows information on the size, position and rotation of the selected objects. You can also use it to do basic transformations on the selection. For more elaborate transformations, you can use the numeric transform function. See [Numeric Transform](#) on page 125.

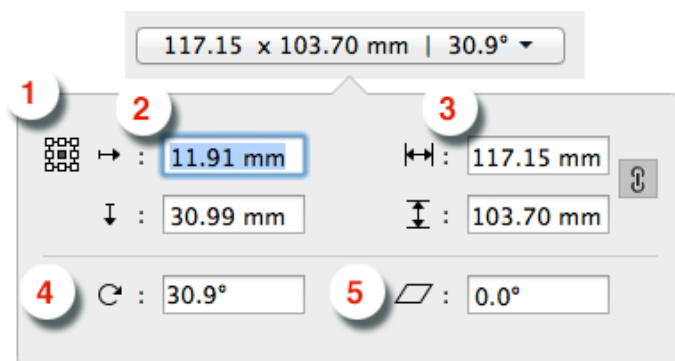

1. The **reference point** on the bounding box of the selection used to determine the position (see below) and when changing the size or rotation while the crosshair is hidden.

In the example underneath you see an example of rotating using the center (left) or the top left corner (right) as reference point.

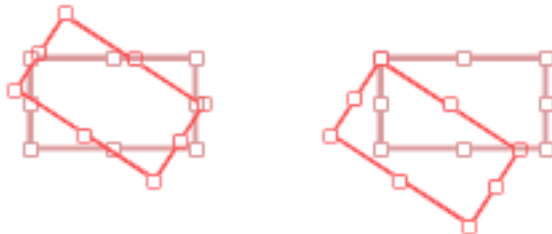

2. The **position**, horizontal and vertical, of the center of the crosshair to the selected reference point. If the crosshair is not visible, the top left corner of the mediabox is used instead. You can move the selected objects by entering a different distance.
3. The **size** of the selection. You can scale the selection by entering a different size. If the two values are linked, changing one value will also change the other.
4. The **angle** of rotation of the selection. You can rotate the selection by entering a different angle.
5. The **shear** angle of the selection. You can shear the selection by entering a different angle.
6. **Attach To** and **Offset**: only available when you're using the Transformation inspector to position a **Grid**. See [Positioning the Grid](#) on page 278
7. If the selected object is a Mark, you can also set the **Attach To** dropdown. See [Mark positioning](#) on page 318

**Note:** When selecting multiple objects with different rotation or shearing angle, these fields will show "±".

## Align & Distribute

The Align & Distribute functionality can be used to horizontally or vertically align or distribute a number of objects.

1. Select the **Align & Distribute** tool, either by selecting it in the Tool Switcher (see [Changing tools](#) on page 38) or by its shortcut **E**, toggling with **Transform**. See [Transforming manually](#) on page 123.  
When the Align & Distribute tool is active, the Align & Distribute buttons are shown at the bottom of the workspace.
2. Select the objects you want to align or distribute.

**Note:** You can use any of the select tools, or the **Align** tool itself. This works the same as the **Group Select** tool.

When the Align & Distribute tool is active, a red box is shown on every top level object (a complete group, a single object, a clipping group, ...) indicating the bounding boxes that will be used for the Align or Distribute.



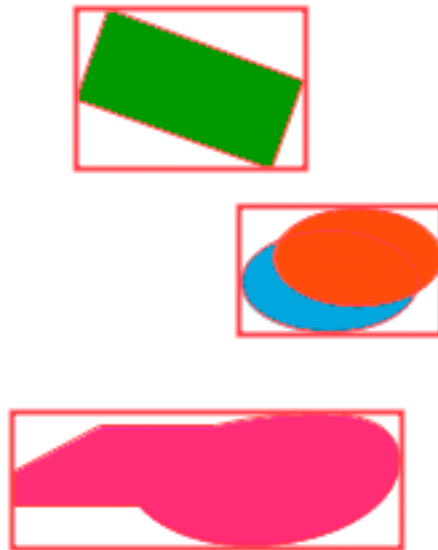

3. Click the button to apply the corresponding Align or Distribute:



- 1. Align vertically on top
- 2. Align vertically centered
- 3. Align vertically on the bottom
- 4. Align horizontally on the left
- 5. Align horizontally centered
- 6. Align horizontally on the bottom
- 7. Vertical Distribute Center
- 8. Vertical Distribute Space
- 9. Horizontally Distribute Center
- 10. Horizontally Distribute Space

The image underneath shows the original objects on the left, and the result of the vertical Align & Distribute tools (1, 2, 3, 7 and 8).

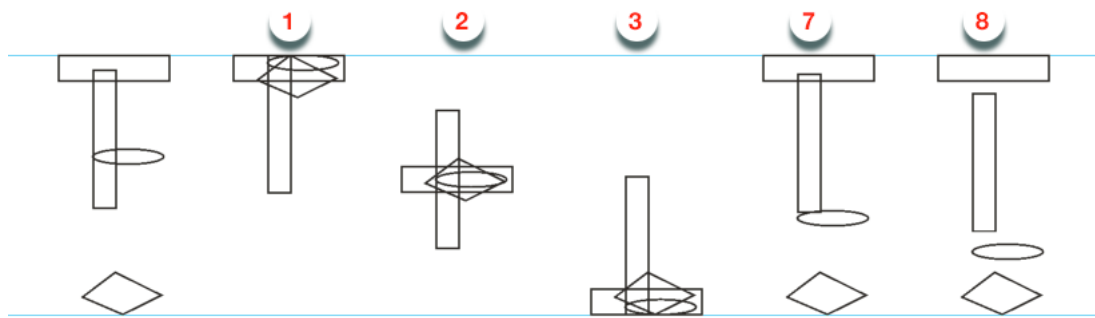

If an Align or Distribute function would give no result with the current selection, the button will be disabled. For example:

- If you have less than 2 objects selected, all **Align** buttons will be disabled
- If you have less than 3 objects selected, all **Distribute** buttons will be disabled
- If the selected objects are already aligned or distributed (e.g. all objects are centered horizontally) the corresponding button is disabled, regardless of whether the align or distribute was done using the Align & Distribute function or not.

**Note:** The **Align & Distribute** function takes the rotation of the crosshair into account. See [Move or rotate the Crosshair](#) on page 75

## 8.4.2. Clipping Mask

With **Clipping Mask** you can set or release Clipping Masks.

- Select **Object > Clipping Mask > Make** or its shortcut **Cmd+7** (Mac) or **Ctrl+7** (Windows) to make the topmost object as Clipping Mask for all objects underneath.
  - At least two objects are needed to make a clipping mask.
  - Protected objects must be expanded first to be included in the clipping mask.
  - All selected objects will be placed in a "Clip Group". The group will be positioned at the place of the second topmost object (the highest object apart from the object or group used as clipping mask).
  - In outline view or when selected, the Clipping Path object will be shown using a dashed line.
- Select one or more Clip Groups and choose **Object > Clipping Mask > Release** or its shortcut **Cmd+Alt+7** (Mac) or **Ctrl+Alt+7** (Windows) to release all selected Clipping Masks.
  - All components will get their original state, and the clipping mask object becomes a regular object but without any fill or stroke.

### Clip on Page Box

Using **Clip on Page Box** you can clip the selected objects using one of the defined page boxes.

1. Select the objects you want to clip
2. Choose **Object > Clip**

3. Select the page box you want to use. Only page boxes defined on the current page in the document are shown.

All selections are placed in a Clipping group, using the selected page box as clipping mask.

### 8.4.3. Opacity Masks

If you select an object with an Opacity Mask, the **Transparency Inspector** (see [Transparency Inspector](#) on page 149) will show a number of extra options.

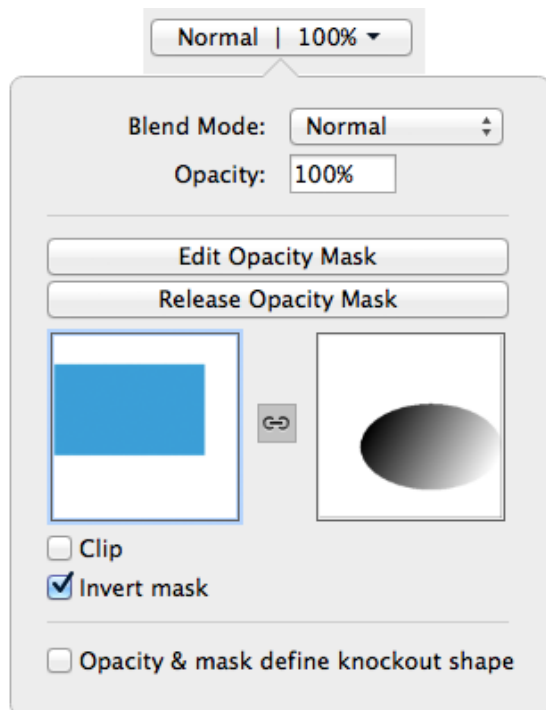

- The **Edit Opacity Mask** button. See [Edit Opacity Masks](#) on page 132
- The **Release Opacity Mask** button. See [Make and Release Opacity Masks](#) on page 131
- A **Preview** of the originals without opacity mask, and of the opacity mask itself.
- The **Link** option in between both previews. If the link is disabled, any transformation (move, scale, ...) applied on the selection will not change the opacity mask. If it is enabled, all transformations (move, scale, ...) will be applied to the opacity mask as well.
- If the **Clip** option is enabled, the masked objects will become completely transparent outside the boundaries of the Masking object.
- The **Invert Mask** option reverses the luminosity values of the masking object, and so also reverses the opacity of the masked objects.

#### Make and Release Opacity Masks

With **Opacity Mask** you can set or release Opacity Masks.

- Select **Object > Opacity Mask > Make** or click the **Make Opacity Mask** button in the Transparency Inspector to set the topmost object (or group) as Opacity Mask for all objects underneath.
  - At least two objects are needed to make an opacity mask.

- All selected objects will be placed in an "Opacity Group". The group will be positioned at the place of the second topmost object (the highest object apart from the object or group used as opacity mask).
- Making an Opacity Mask is not possible if Clipping paths (and not the Clipping Group) are selected.
- Select one or more Opacity Groups and choose **Object > Opacity Mask > Release** or click the **Release Opacity Mask** button in the Group Transparency Inspector to release all selected Opacity Masks.
- All components will get their original color back, and will be assigned the default screening after releasing.

### Edit Opacity Masks

You can edit an opacity mask without the need to release and remake it, using **Edit Opacity Mask**.

- Select an Opacity Mask group
- Select **Object > Opacity Mask > Edit**, click the **Edit Opacity Mask** button in the Transparency Inspector or double-click the mask thumbnail in the Transparency Inspector.

ArtPro+ will switch to Edit Opacity Mask mode. This means that:

- Only the contents of the opacity mask is editable
- In Preview mode, the objects in the opacity mask are shown opaque, while in the background a dimmed version of the document is still visible.
- In Outline mode, only the outlines of the opacity mask objects are shown. In Outline with hinting mode, the document is also visible.
- If you hold the **Y** key, you get a preview of what the document looks like with the edited Opacity Mask. If you release the Y key, you return to Opacity Mask editing.
- Functions not relevant for Object Mask editing will not be available. For example Layers, Quality Control, Separations are hidden, Page boxes can be viewed but not edited, etc.
- The document Separations list is replaced by the opacity mask Colorants list, showing the inks only used in the opacity mask under edit. This can be edited totally independent of the document's Separations list.
- The opacity mask colorants are converted to CMYK for visualization purposes to match the output on the RIP. The Densities tool behaves accordingly.
- While in Edit Opacity Mask mode, you can not undo actions that were done before starting the opacity mask editing.
- If you are done changing the Opacity Mask, you can leave Edit Opacity Mask mode by clicking **Back to Document** in the breadcrumbs or in the Side Panel.

## 8.4.4. Creating and editing paths

### Create & Edit Path









Using the **Create & Edit Path** tool, you can create new paths or change the path of the selected object.

**Note:** The path tools can only be used to edit paths and compound paths. Images, Placed Art, text, barcodes and Protected objects (such as unsupported barcodes, Smartmarks, ...) can't be edited. See [Protected objects](#) on page 138

1. Select the **Create & Edit Path** tool, either by selecting it in the Tool Switcher (see [Changing tools](#) on page 38) or by its shortcut **P**, toggling with **Split and Retrace** and **Cut Path**. See [Split and Retrace](#) on page 134 and [Cut Path](#) on page 135.

When the Create & Edit Path tool is active, the anchor points and handles on the selected path will become visible.

2. The **Create & Edit Path** tool can be used for several functions : create new paths, move or remove anchor points, etc. The function depends on the location you click.

- a)  Click anywhere in the document (except on an existing and selected path) to start creating a new path. Clicking will create a starting point, click and drag will immediately add handles to it.
- b)  ... With an endpoint of an open path selected, click to add a point. Click and drag to immediately add handles to it,
- c)  With one endpoint of an open path selected, click the other endpoint to close the path.,
- d)  + Click on a path segment to add an anchor point.
- e)  □ Click on an anchor point to (de)select it. Hold the Shift key to select multiple anchor points.
- f)  Hold the Alt (Mac) or Option (Windows) key and click and drag to select multiple anchor points.
- g)  Click and drag selected anchor points to move the anchor point(s). Hold down the shift key to constrain the movement to vertical, horizontal or over 45 degrees.
- h) Double-click an anchor point to convert it between an anchor point with handles (smooth point) and an anchor point without handles (corner point).
- i) Hold the **Command** (Mac) or **Control** (Windows) key and use the arrow keys to move the anchor points onto the crosshair, using the bounding box of the selected anchor points
- j)  If a selected anchor points has handles: click and drag one of the handles to move both handles. Hold the shift key to only modify the length of the handle, without changing the direction
- k)  If a selected anchor points has handles: click and drag one of the handles while holding the Alt key to only modify the one handle instead of both.
- l) While editing an object using the **Create & Edit Path** you can use some of the select functions on the anchor points of the object
  - Use **Select > Select All** or its shortcut **Cmd+A** (Mac) or **Ctrl+A** (Windows) to select all anchor points of the object.

- Use **Select > Deselect All** or its shortcut **Cmd+Shift+A** (Mac) or **Ctrl+Shift+A** (Windows) to deselect all anchor points.
- Use **Select > Select Inverse** or its shortcut **Cmd+Alt+A** (Mac) or **Ctrl+Alt+A** (Windows) to invert the selection: selected anchor points become deselected, unselected anchor points become selected.

### Split and Retrace

Using the **Split and Retrace** tool, you can retrace a part of the path of the selected object, or you can split the path.

**Note:** The path tools can only be used to edit paths and compound paths. Images, Placed Art, text, barcodes and Protected objects (such as unsupported barcodes, SmartMarks, ...) can't be edited. See [Protected objects](#) on page 138

1. Select the path you want to edit.
2. Select the **Split and Retrace** tool, either by selecting it in the Tool Switcher (see [Changing tools](#) on page 38) or by its shortcut **P**, toggling with **Edit Path** and **Cut Path**. See [Create & Edit Path](#) on page 132 and [Cut Path](#) on page 135.

3.  Click a starting point on the path.

4. Draw the new part of the path

- a)  Click to add an anchor point. Click and drag to create an anchor point and immediately add handles to it.

**Note:** To add an anchor point close to the original path without closing the retrace, hold down the **Alt** key.

- b) You can edit already created anchor points using the same tools as in Edit Path, e.g. to add or edit handles, move anchor points, etc. See [Create & Edit Path](#) on page 132
- c) Hold down the **Shift** key to constrain the newly drawn line or Bézier curve by an angle of 45 degrees. If the Crosshair is rotated, this rotation is added to the constrain angle.
- d) Undo the last drawn anchor point by using the **Delete** key.

5.  Click on the original path to define the end point of the retrace.

6.  Click the part of the shape you want to keep (Retrace) or drag over both parts to keep them both (Split).

**Note:** Since there aren't two parts to choose from when you are retracing an open path, this step will be skipped. You can solve this by closing the path first: see [Close Path](#) on page 137.

Retrace	Split

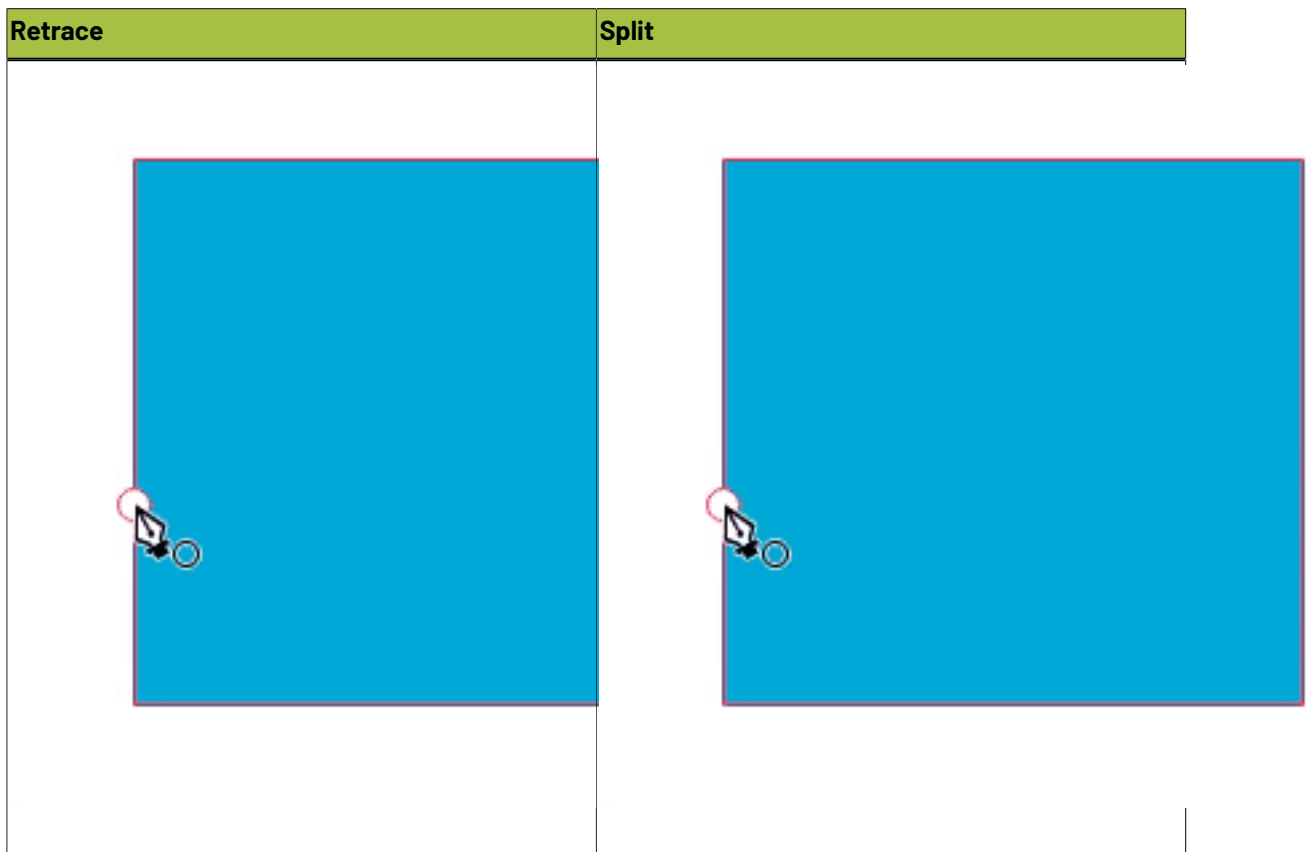

**Note:** If you apply Split & Retrace on an open path, you can't decide the part of the shape you want to keep, nor can you apply a split.

### Cut Path

Using the **Cut Path** tool, you can cut the path of the selected object. This will create two end points at the place where you cut. Cutting a closed path will result in an open path, cutting an open path results in two open paths.

**Note:** The path tools can only be used to edit paths and compound paths. Images, Placed Art, text, barcodes and Protected objects (such as unsupported barcodes, SmartMarks, ...) can't be edited. See [Protected objects](#) on page 138

1. Select the path you want to edit.
2. Select the **Cut Path** tool, either by selecting it in the Tool Switcher (see [Changing tools](#) on page 38) or by its shortcut **P**, toggling with **Edit Path** and **Split and Retrace**. See [Create & Edit Path](#) on page 132.
3.  Click on the selected path where you want to cut it.
  - A Circle will indicate where the path(s) will be cut. When hovering over an object that can't be cut (barcodes, Marks, images, ...) no circle indicator is shown.
  - The Cut Path tool will snap to the selected path, but also to intersections of the path with the Crosshair and to intersections with other paths (even with unselected paths).
  - You can temporarily disable this snapping by holding down the Alt key.

4. When you click, the selected object(s) will be cut

- The path becomes an open path, part of a compound.
- If you click the intersection of two selected paths, both paths will be cut.
- If you cut a path with a dashed stroke, the dashing pattern can be affected, since a new starting point was created.

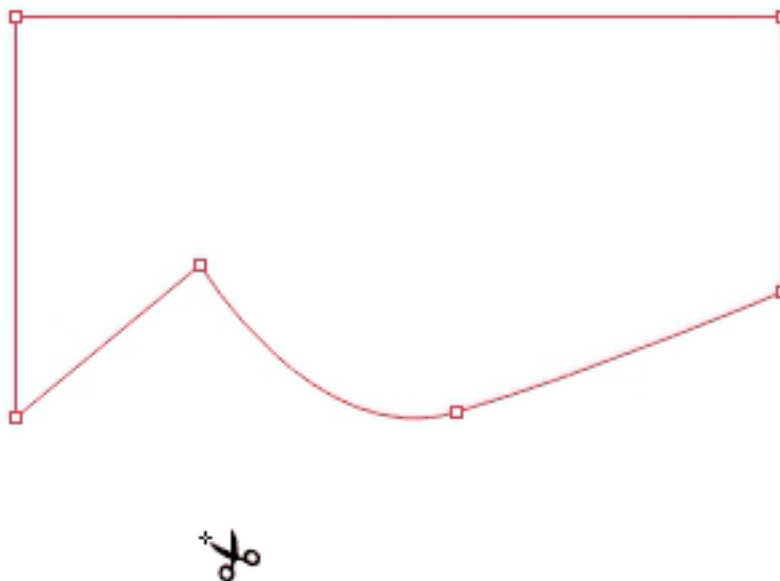

You can close the resulting open path(s) using the **Create & Edit Path** tool, or using **Join Paths** or **Close Paths**. See [Create & Edit Path](#) on page 132, [Join Paths](#) on page 136 or [Close Path](#) on page 137

**Join Paths**

If the selection contains one or more open paths, you can join all selected open paths into one closed path by choosing **Object > Path > Join Paths** or by using its shortcut **Cmd+J** (Mac) or **Ctrl+J** (Windows).

The end points closest to each other will be connected using a straight line.

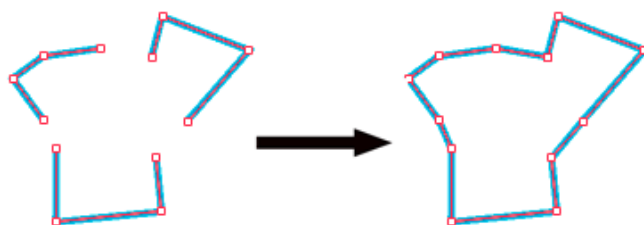

**Note:** If you have only one path selected, using **Close Path** and **Join Path** will give the same result. See [Close Path](#) on page 137



### Close Path

If the selection contains one or more open paths, you can close them by choosing **Object > Path > Close Path** or by using its shortcut **Cmd+Alt+J** (Mac) or **Ctrl+Alt+J** (Windows).

All open paths will be closed individually, by connecting their end points using a straight line.

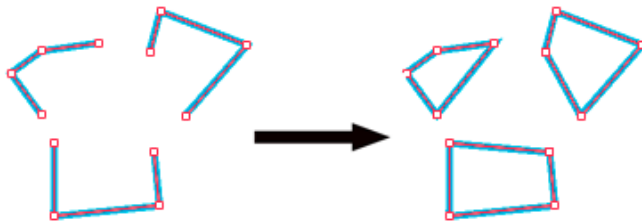

**Note:** If you have only one path selected, using **Close Path** and **Join Path** will give the same result. See [Join Paths](#) on page 136

### 8.4.5. Spread / Choke

Using the **Spread / Choke** function, you can enlarge (Spread) or reduce (Choke) the selected object(s).

1. Select the objects you want to spread or choke

**Note:** Spread / Choke is not supported on images, barcodes, text and Protected objects. If your selection contains unsupported objects, you will get a warning when spreading / choking. If your selection only contains unsupported objects, Spread/Choke will be disabled.

2. Open the **Spread / Choke** window by choosing **Object > Spread/Choke** or by its shortcut **Cmd+Shift+T** (Mac) or **Ctrl+Shift+T** (Windows)

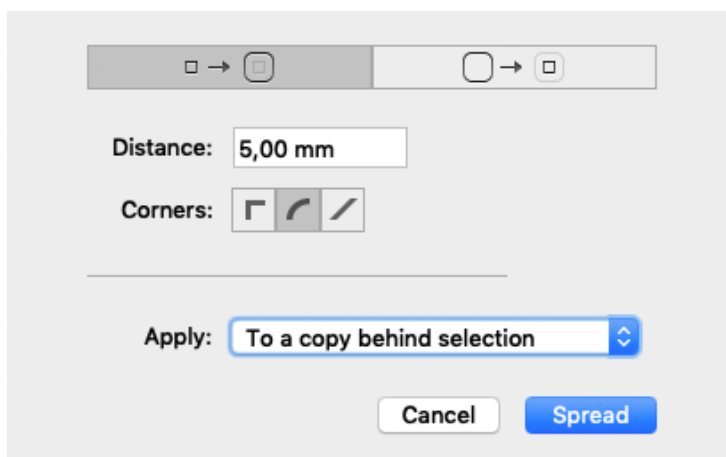

3. Using the buttons on the top, choose between **Spread** and **Choke**
4. Enter the **Distance** to be used
5. Select how the sharp corners should be handled

- **Mitered:** this option works with a miter ratio. The miter ratio serves to limit the length of the sharp corner (the distance from the base of the trap to the corner point). The default miter ratio value is 4. This means that if the length of the sharp corner is more than 4 times the Distance, then the corner will be cut off (beveled). If it is less than 4 times the Distance, the corner will be left as it is.
- **Round:** a round cap will be placed at all corners.
- **Beveled:** this will cut sharp corners off.

6. Select how you want to **Apply** the spread or choke

- Select **to original object** to replace the original object by the spread or choked shape.
- Select **To a copy behind selection** if you want to keep the original object, and place the spread/choke object underneath the original.
- Select **to a copy in front of selection** if you want to keep the original object, and place the spread/choke object on top of the original.
- Select **As a manual trap** to create trapping based on the original object and the spread or choke shape
  - the largest of the two is placed in front: in case of a Spread, the Spread object is in front of the original object, in case of a choke, the original object is in front of the Choke object.
  - the frontmost (largest) shape gets the fill of the original object with a Darken blend mode, while the bottommost shape will be white (all zero).
  - If the original object has transparency, both the original and the Spread/Choke object will be placed in a transparency group. The transparency group will get the transparency setting of the original object.
  - If the original object has a stroke, the stroke will be outlined automatically before applying the Spread/Choke

**Note:** When switching to "as a manual trap", the corners will by default switch to **Round** as this usually gives the best results. You can manually overwrite this.

### 8.4.6. Protected objects

Protected objects (or "High-level objects" as they were called earlier) are objects saved in the PDF file, using "Private Data": specific information about the object, written in the PDF file by the PDF file creator. Common examples are

- Unsupported Barcodes: see [Barcodes](#) on page 183
- Unsupported live text (not in a text box)
- SmartMarks
- Unsupported images.

In ArtPro+, it is not allowed to change these Protected objects: you can not transform them, or include them in a compound. See also [Transforming objects](#) on page 122 and [Compound](#) on page 121

**Note:** Unsupported images are marked as Protected objects, but they can be transformed.

You can however **expand** a Protected object. See [Expand](#) on page 139

**Note:** Expanding is not recommended for unsupported images

## Expand

Protected objects (see [Protected objects](#) on page 138), barcodes (see [Barcodes](#) on page 183), Marks (see [Marks](#) on page 291), Forms, Placed Art (see [Working with Placed Art](#) on page 173) and Structural Design files (see [Working with Structural Design files](#) on page 180) can be expanded.

To expand all expandable objects in the selection:

- Choose **Object > Expand**
- Click the **Expand** button in the Inspector bar.

Expanding these objects will replace them by regular objects (e.g. a Mark can be replaced by a number of rectangles or pieces of text, the placed art in a Form becomes editable) in a group.

**Note:** The result of expanding can still contain expandable objects. You can apply "Expand" multiple times until the object is completely expanded.

By doing so, the objects become fully editable, but lose the information used to create them.

## 8.4.7. Rasterize ...

Using this function, you can replace the selected artwork by an image.

1. Select the objects you want to rasterize, and select **Object > Rasterize ...**

The **Rasterize** window will open.

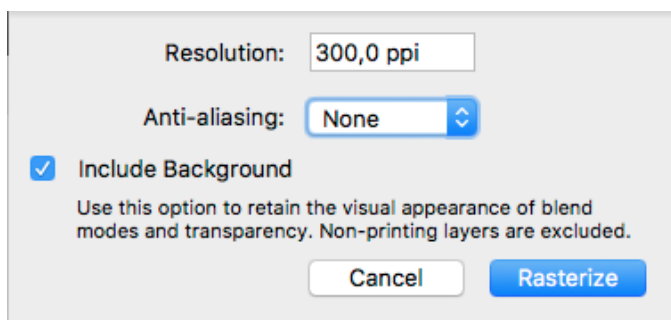

**Note:** The number of created images depends on the locations of the selected objects in the object browser: selecting a non-consecutive set of objects creates multiple images. In that case a warning will be shown in the Rasterize window, showing the number of images that will be generated, and advising to group the selection to avoid this.

2. Set the **Resolution** for the image to be created
3. Set the **Anti-aliasing** you want to apply.

Anti-Aliasing will result in a smoother preview.

4. Select **Include Background** to rasterize the background into the image, so blend modes and overprint are kept. If the option is disabled, only the selected objects will be in the image, and the background of the image will be transparent, and blend modes and overprints will be disregarded.
5. Click **Rasterize** to create the rasterized image, replacing the selected objects.

**Note:** During Rasterizing, 2% noise is applied.

### 8.4.8. Clean

**Note:** The availability of this functionality depends on your license of ArtPro+. See [Licensing](#) on page 25

**Clean** combines a number of functions to clean up, improve or modify your artwork. The different functions are described separately:

- [Merge similar paths and text](#) on page 140
- [Contourize Text](#) on page 160
- [Outline Strokes](#) on page 141
- [Clean up Groups and Clipping Masks](#) on page 141
- [Execute Clipping Masks](#) on page 141
- [Optimize Artwork](#) on page 142
- [Fix Text Box Reflow](#) on page 142

You can use every function individually by selecting it in **Object > Clean**, or you can combine them using the **Clean** dialog.

1. Select the objects you want to clean.
2. Choose **Object > Clean > Show Clean Dialog...**, click the **Clean** button or use its shortcut **Cmd+Shift+C** (Mac) or **Ctrl+Shift+C** (Windows) to open the Clean window.

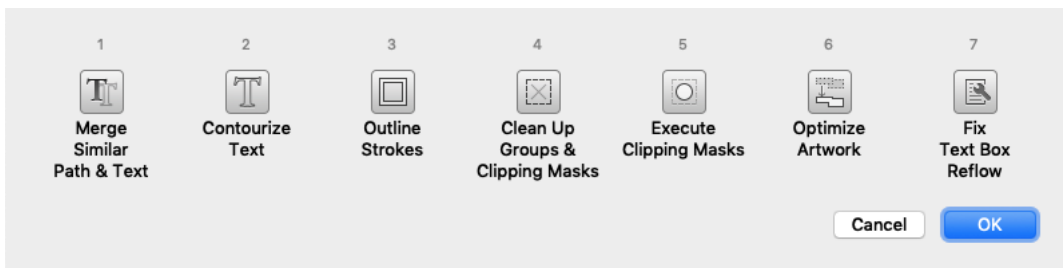

3. Select one or more Clean functions to apply, either by clicking the button or by pressing the corresponding number key (1 - 7)  
Depending on the selection, some functions can be disabled.
4. Click **OK**

#### Merge similar paths and text

In some situations (e.g. to make a combination between CMYK and spot color), a path or text box can be composed of different identical objects (shape, size and position) on top of each other. For example, a rectangle containing a CMYK color, and an identical object on top, containing a spot color percentage in overprint.

The **Merge similar paths and text** function allows to combine such objects into one object, whereas the fill will be merged. In the example described above, that would be one object combining CMYK and the spot color fill.

1. Select the objects & text boxes you want to apply the function on.
2. Select **Object > Merge similar paths and text**

The redundant objects or text objects will be removed, and the remaining object or text box will get the merged fill color. A message will be shown indicating how many objects or text boxes were cleaned up.

**Note:** Merging will only be done if this will make no difference to the final result. For example with different blend modes or screening, merging will not be done.

## Outline Strokes

Using this function, you can replace stroked objects by a group consisting of a path (the fill object) and compound path (the outlined) stroke.

1. Select the stroked object you want to edit
2. Select **Object > Clean > Outline Strokes**

Outline Strokes can also be applied from the **Clean** dialog. See [Clean](#) on page 140

**Note:** Outline Strokes doesn't work on stroked text. You can however combine contourizing the text and outlining the strokes from the **Clean** dialog.

## Clean up Groups and Clipping Masks

To remove redundant groups and clipping masks (e.g. a group as sole component in another group) you can use the **Clean up Groups and Clipping Masks** function.

1. Select the objects & groups you want to apply the function on.
2. Select **Object > Clean > Clean up Groups and Clipping Masks**

The redundant groupings and clipping masks will be removed, and a message will be shown indicating how many groups and/or clipping masks were removed.

**Note:** Named groups will not be removed.

## Execute Clipping Masks

Using this function, you can replace object & clipping mask combinations, and create new simple objects where possible, without causing any visual difference.

Objects are cropped on their clipping mask, while the clipping path itself and anything that was clipped away is removed. During the process, affected strokes and live text will be contourized.

Images, patterns and Dynamic Marks remain untouched

1. Select at least one clip group you want to execute
2. Select **Object > Clean > Execute Clipping Masks**

Execute Clipping Masks can also be applied from the **Clean** dialog. See [Clean](#) on page 140

### Optimize Artwork

To clean up your selection, removing paths or parts of paths without affecting the visual appearance of the job, you can use the **Optimize Artwork** function.

**Important: Optimize Artwork** is a destructive action: objects can be removed, or split into multiple smaller objects. In many cases, editability is limited. It is therefore not recommended to run on all artwork, but to run it on targeted objects only, for a specific goal such as simplifying trapping afterwards.

Optimizing your Artwork will simplify trapping afterwards.

1. Select the objects & groups you want to apply the function on.
2. Select **Object > Optimize Artwork**

The selected objects will be simplified as much as possible. Text and barcodes are outlined, image clips are executed, etc. The layer structure is kept as much of possible. When objects from multiple layers were selected, the result will be placed in the topmost layer involved.

For images with transparency, the Optimize Artwork function can generate a clipping mask, or it can even split up the image in multiple clipping groups.

The example underneath shows both preview and outline before (left) and after (right) using **Optimize Artwork**



### Fix Text Box Reflow

In certain PDF files, improper line endings in the PDF code can result in the combination of multiple overlapping, non-consecutive or rotated lines of text into one single text box. ArtPro+ will honor this text box, but it will be hard to edit.

If you try editing such a text box, you will be given the option to split it into multiple text boxes. You can also fix it using the **Fix Text Box Reflow** option

1. Select at least one text box you want to fix

2. Select **Object > Clean > Fix Text Box Reflow**

A message will inform you how many text boxes were split or fixed, and what the resulting number of text boxes is.

Fix Text Box Reflow can also be applied from the **Clean** dialog. See [Clean](#) on page 140

## 8.5. Changing the Fill and Stroke

### 8.5.1. Fill Color and Stroke Color Inspector

When one or more objects are selected, the Inspector will show 2 color patches: one for the **Fill** 

and one for the **Stroke** . If all selected objects have the same Fill or Stroke, the color patch will give a representation of the Fill or Stroke color. Otherwise, it will show the ≠ symbol.

You can use the shortcut **Cmd+I** (Mac) or **Ctrl+I** (Windows) or click the Fill color patch to open the **Fill Inspector**.

You can also use the shortcut **Cmd+Shift+I** (Mac) or **Ctrl+Shift+I** (Windows) or click the Stroke color patch to open the **Stroke Inspector**.

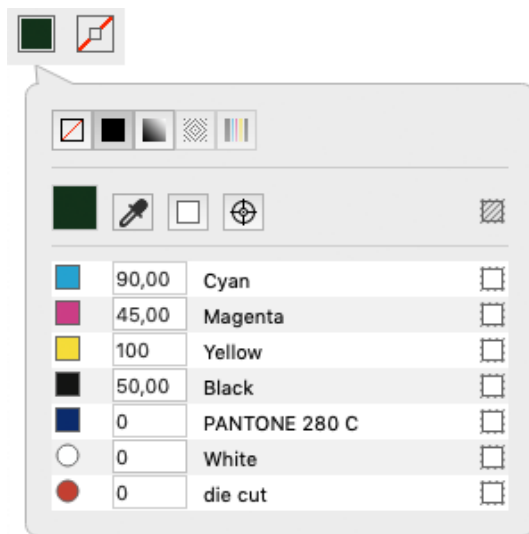

The buttons on top of the dialog are:

- **None** : the object or stroke is empty, and thus completely transparent.
- **Color**: a flat color. See [Flat Color](#) on page 144.
- **Gradient**: a gradation between two colors. See [Gradient](#) on page 145.
- **Pattern**: see [Pattern](#) on page 147
- **Multicolor Barcode**: see [Multicolor Barcode](#) on page 148

**Note:** You can toggle between None, Color and Gradient by using the shortcut **Cmd+I** (Mac) or **Ctrl+I** (Windows).

Flat Color

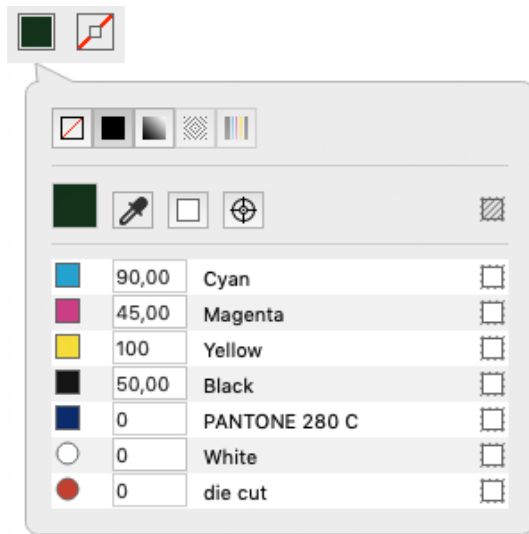

Below the color patch is a list of the current separations, and the percentage for each separation.

- Enter the percentage for every separation to change the color. You can enter a value, or use one of the shortcuts:
  - a) Enter **a** followed by a value, to set all separations to that value.
  - b) Enter **x** to set the value to 100%, or enter **ax** to set all values to 100%
  - c) Click the color patch to set the value for that separation to 100%. Clicking it again will switch it between 0% and 100%.
- Click the **Color Picker** or use the shortcut **i** (while the Inspector is open) to pick a color from your job. If you click and drag, the Color Picker will show the currently selected color the same way as the Densities tool. See [Densities](#) on page 87. As soon as you release, the selected color will be set in the Inspector.
- Click the **All Zero** button to make the object(s) or stroke(s) completely white and knock-out for all separations
- Click the **Registration Color** button to switch to registration color. The dialog will only show one line, and the entered percentage will be used for all separations. The Registration Color button has changed to this: . Click this button to switch back to normal color.
- Click the button on the right of the separation name  to switch the selected object(s) or stroke(s) to overprinting for that specific separation. The separation percentage field will become empty, and the state will change to overprinting . Clicking the button again will switch back to knock-out and 0% You can also enter **t** as value to set the separation overprinting. Enter **at** to set all separations overprinting.
- If all separations that are unused (i.e. set to 0%) are set to knock-out, you can click the **Set unused separations overprinting** button above the separations to change the state of all unused separations to an "overprinting" state. If at least one separation is overprinting, you can click the **Set**



**overprinting separations knockout** button  to switch all overprinting separations to knock-out (0%).

## Gradient

Gradients are defined by a series of stops along the gradient slider. A stop marks the point at which a gradient changes from one color to the next, and is identified by a square below the gradient slider. The squares display the color currently assigned to each gradient stop. With a radial gradient, the leftmost gradient stop defines the center point's color fill, which radiates outward to the color of the rightmost gradient stop.

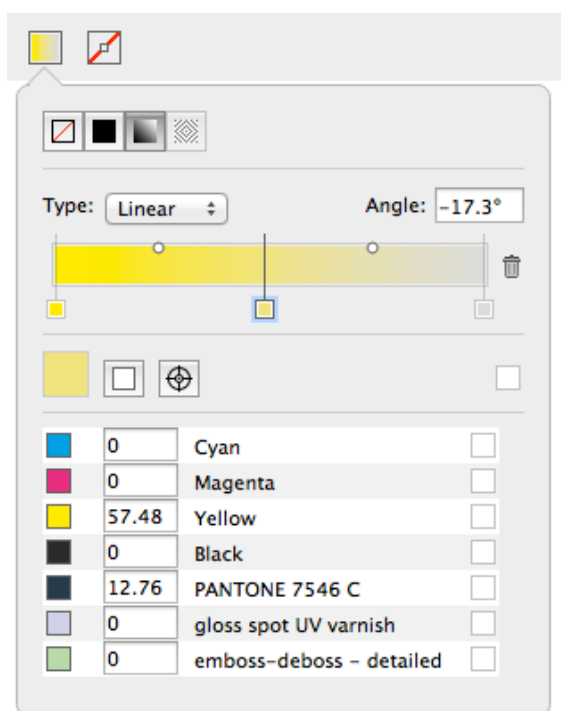



- Select the type of gradient: **Radial** or **Linear**
- Use the **Angle** field to numerically change the rotation.
- Set up the **Color stops**:
  - a) Click a Color Stop to select it and set its color . See [Setting the color of a gradient Color Stop](#) on page 146
  - b) Click on the bottom of the bar to add a Color Stop.
  - c) Click and drag a Color Stop to change its position in between the other Color Stops. This is not possible for the start and end Color Stop.
  - d) Select a Color Stop and drag while holding the ALT key to duplicate the Color Stop
  - e) Select a Color Stop and click the trash icon or drag it downwards to delete it. You can't delete the start and end Color Stop.
- Set up the **Midpoints**
  - a) Click and drag a Midpoint of the gradient to move it manually.
  - b) Click a Midpoint to select it, and enter its **Position** as a percentage. Values between 13% and 87% are allowed.
  - c) Alt-click a Midpoint to reset it to 50%

### Setting the color of a gradient Color Stop

Setting the color of one of the Color Stops of a gradient is the same as setting a flat color. See [Flat Color](#) on page 144

There are however a few restrictions:

- Clicking the **Registration Color** button  will change both the begin and end color to registration color (or back to normal color when clicking again)
- A gradient can not go from transparent to knock-out (0% or a specific value). If you set one point to transparent for a separation that is knock-out in the other point, this will automatically change back to knock-out.
- Because of the limitation mentioned above, clicking the **Set unused separations overprinting** button  will only change the separations that are unused (0%) in both the begin and end point. Both occurrences will change to Transparent.

### Manually editing the handle points of a gradient

If you select an object with a gradient, you have one of the selector tools (Object Select tool, Group Select tool or Transform tool) and the Inspector is open, you can edit the gradient using the handle points in the object itself.

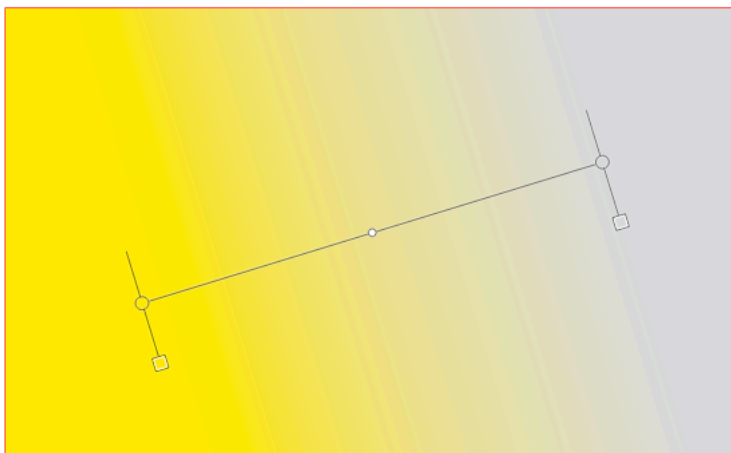

- Click and drag one of the end points of a linear gradient to move the position of the end point.
- Click and drag the center point of a radial gradient to position the center point within the gradient.
- Click and drag the circumference of a radial gradient to change its size.
- Click and drag the handles line to move the gradient while maintaining the angle and distance between end points
- Click and drag a Midpoint to change its position. Alt-Click it to re-center it in between the two Color Stops.
- Double-click a Color Stop or Midpoint to select it. You can then change its properties (color for a Color Stop, Position for a Midpoint)

Pattern

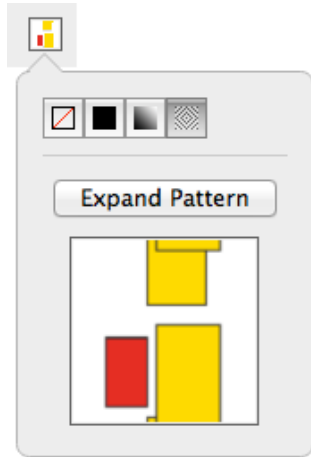

If you have a pattern filled object selected, you can open the **Pattern Inspector**

- You can click the **Expand Pattern** button to replace the fill with a repetition of the actual objects.
- If the pattern is colored, you get a preview of the pattern, but can't change it.
- If the pattern is uncolored, the pattern inspector will show 2 thumbnails, and you can set the color for the pattern yourself.

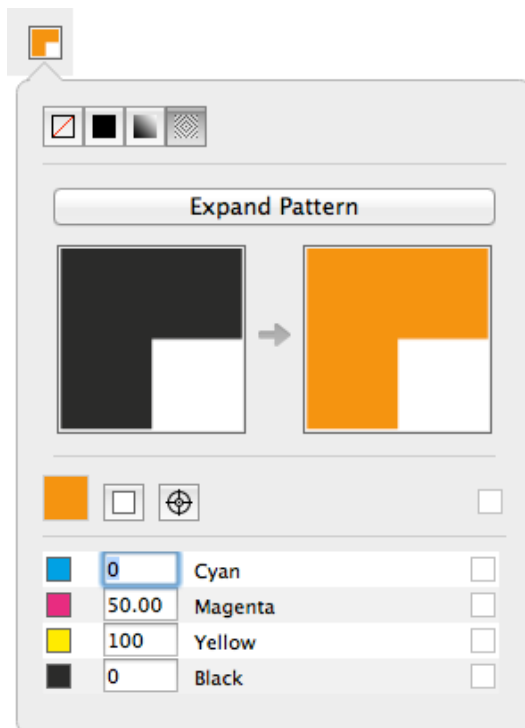

### Multicolor Barcode

This special fill mode can be used to create a multicolor barcode. This is only available for Laetus Pharma barcodes. See [Laetus Pharma](#) on page 230

## 8.5.2. Stroke Inspector

Using the Stroke Inspector, you can change the size and shape of a stroke

1. Open the **Stroke Inspector**

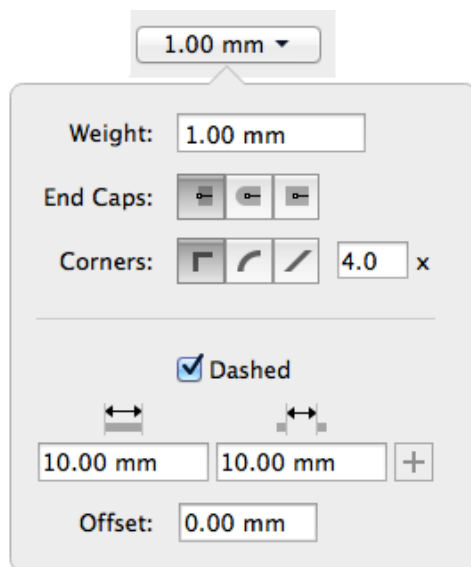

2. Define the **Weight** of the stroke. Enter a number to use the default unit, or add the unit and it will be converted to the default unit. See [Preferences](#) on page 44. You can enter zero or leave the field blank to switch to "no stroke".
3. Select the shape of the **End Caps**
  - With **Butt Caps** the stroke is squared off at the end point of the path.
  - With **Round Caps**, a semicircular arc with diameter equal to the line width is drawn around the end points of the line, thus prolonging it.
  - With **Projecting Caps** the stroke continues beyond the end point of the path and is squared off at a distance equal to half the line width.
4. Select how the sharp corners should be handled
  - **Mitered**: this option works with a miter ratio. The miter ratio serves to limit the length of the sharp corner (the distance from the base of the trap to the corner point). The default miter ratio value is 4. This means that if the length of the sharp corner is more than 4 times the Distance, then the corner will be cut off (beveled). If it is less than 4 times the Distance, the corner will be left as it is.
  - **Round**: a round cap will be placed at all corners.
  - **Beveled**: this will cut sharp corners off.

5. Enable **Dashed** to create a dashed stroke
  - Define the size of the dash and the size of the gap
  - If you want to add another combination of dash and gap, click the + button. To remove a combination, click the - button
  - Enter an **Offset** distance to modify the starting point for the dashes & gaps.

### 8.5.3. Transparency Inspector

The **Transparency Inspector** shows the transparency settings of the currently selected object or group. Keep in mind that although group and object transparency can be combined, the inspector will show either the group or the object transparency, depending on the selection.

**Note:** You can use the **Breadcrumbs** to see or change the current selection.

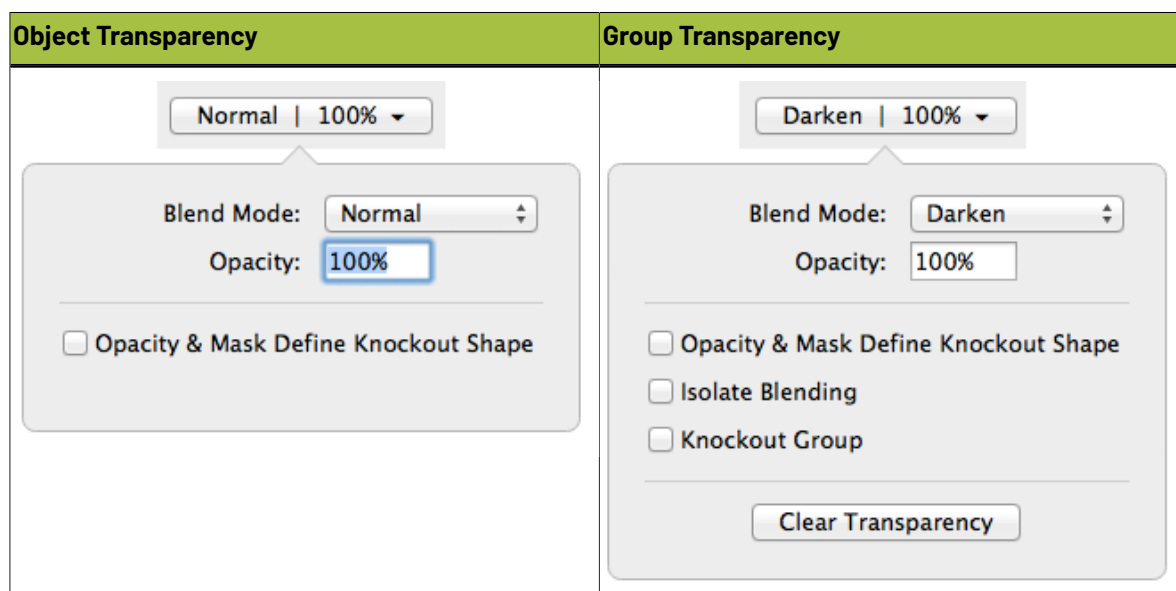

#### Blend Mode

A Blend Mode makes a combination between the blend object (object on which the blend mode is applied) and a base object (underneath the blend object), resulting in a blend color. The final result will depend on the base object, the blend color and the opacity (see below)

**Note:** Non-white preserving blend modes (Difference, Exclusion, Hue, Saturation, Color and Luminosity) require all 4 process separations. If these separations are not present, using a Non-white preserving blend mode will add them.

#### Opacity

The Opacity defines how much of the Blend result will be used. If the Opacity is 100%, the result will be 100% of the Blend result (as described above). If the Opacity is e.g. 60%, the final result will be 60% of the Blend result (not the color of the object to be blended, but the resulting Blend color) and 40% of the original Base color.

#### Opacity & Mask Define Knockout Shape

The Opacity & Mask define knockout shape option only affects the combination of objects with an Opacity mask, inside a group with the Knockout Group option. The result will be that, instead of knocking out completely, the object with the Opacity Mask will be knocked out based on the Opacity Mask and the Opacity value.

### Isolate Blending

When an object inside a group has a blend assigned to it, this will affect all objects underneath. If the **Isolate Blends** option is on, blends assigned to objects inside a group, are only calculated to objects within the same group and not to objects outside the group. The opacity however will also affect the objects underneath.

### Knockout Group

With the **Knockout groups** option on, objects inside the group will only interact with what's behind the group - not with other elements inside the same group. This means that all blending and opacity calculation is done between the object (which is inside the group) and the group's background (which is outside the group).

**Note:** A group without transparency (shown as "Group" in the breadcrumbs, and not as "Transparency Group") will inherit the Knockout Group setting from the Transparency Group it is part of.

### Clear Transparency

Clicking the **Clear Transparency** button will set the Blend Mode to Normal, set the Opacity to 100% and deselect all options. The Transparency Group will become a normal Group again, so the Knockout Group option will again be inherited (see above).

### Opacity Mask

If an Opacity Mask is selected, the Transparency Inspector will contain the **Edit Opacity Mask** button, **Release Opacity Mask** button, a preview of the mask, the **Clip** option and **Invert mask** option will . See [Opacity Masks](#) on page 131

## 8.5.4. Recolor

Using **Recolor** you can remove Separations, replace Separations or Convert Separations to CMYK for the selected objects. Objects outside the selection are not modified.

1. Select the objects you want to modify
2. Select **Object > Recolor...**
3. If you want to remove a separation:
  - a) In the **Recolor** dialog, select **Remove Separations**.

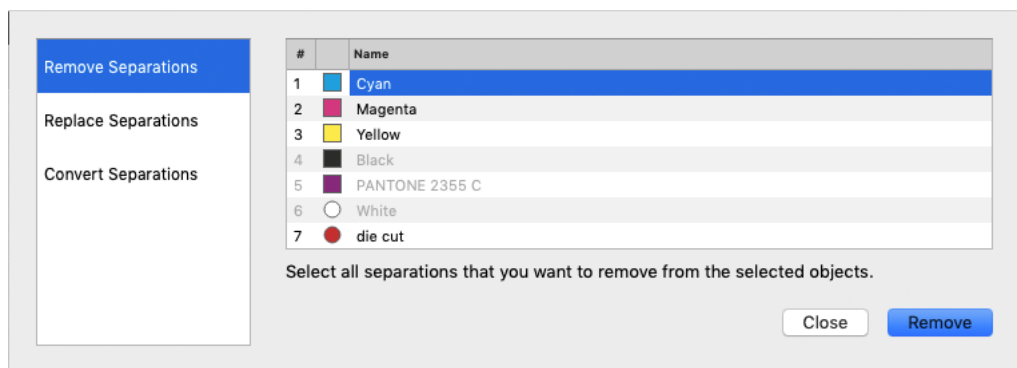

- b) Select the separation(s) you want to remove from the selection. Only separations used in the selection are available.
  - c) Click **Remove** to remove the separation(s) from the selected objects and close the dialog. The selected separation(s) will no longer be used in the selected objects. If a separation is no longer used in the document, it will also be removed from the Separations list.
4. If you want to replace a separation:
- a) In the **Recolor** dialog, select **Replace Separations**.

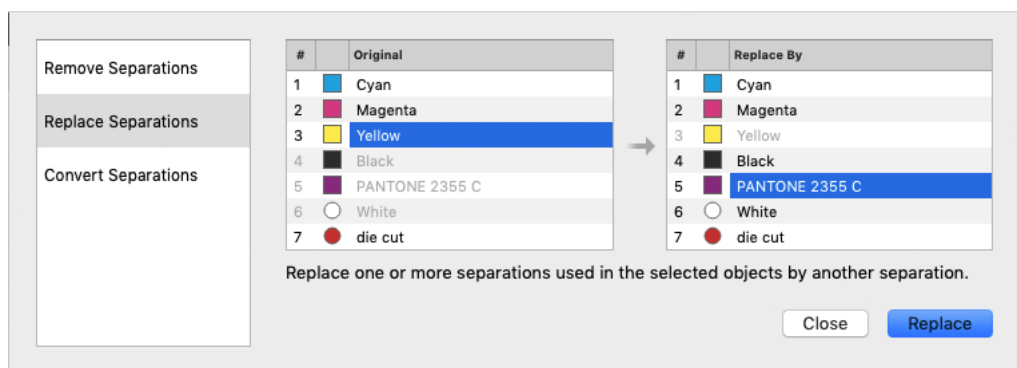

- b) In the left column, select the **source** separation(s) you want to replace in the selection. Only separations used in the selection are available.
  - c) In the right column, select the **target** separation. You can select any separation from the document, except for the source separations.
  - d) Click **Replace** to replace the separation(s) in the selected objects and close the dialog. The selected separation(s) will be merged with the target separation. If a separation is no longer used in the document, it will also be removed from the Separations list
5. If you want to convert a separation to CMYK:
- a) In the **Recolor** dialog, select **Convert Separations**.
  - b) In the **Conversion Method** dropdown, select **Convert to CMYK**.

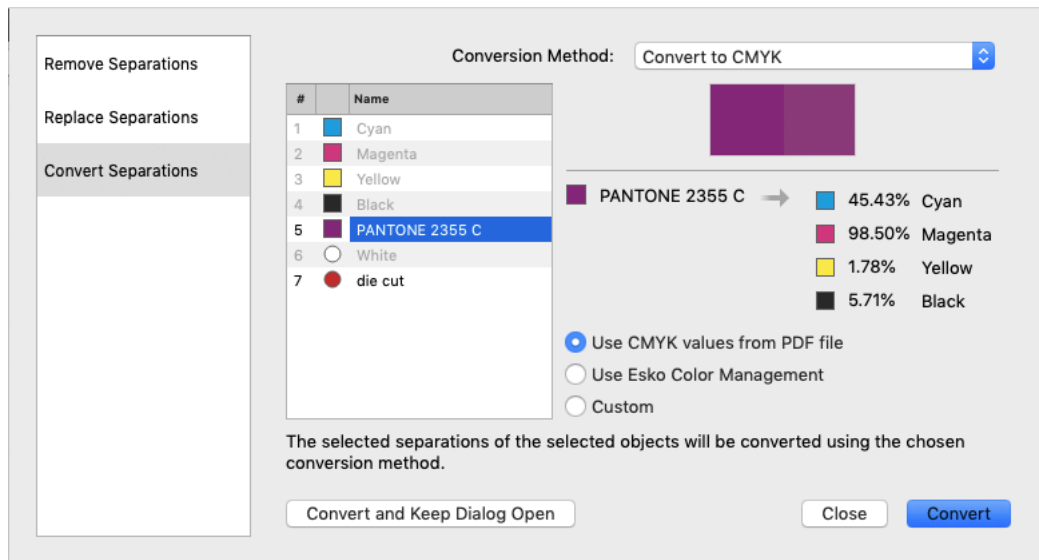

- c) Select the separation you want to convert to CMYK in the selection. Only spot color separations used in the selection are available.
- d) Select the CMYK values you want to use:
  - the CMYK values that are saved in the PDF file
  - the CMYK values using the Esko Color Management (not available for custom inks)
  - Custom values you can enter yourself.
- e) Click **Convert and Keep Dialog Open** to convert the separation in the selected objects and keep the dialog open for another Recolor operation, or click **Convert** to apply the operation and close the dialog.

The selected separation will be converted to CMYK in the selected objects. If a separation is no longer used in the document, it will also be removed from the Separations list

6. If you want to convert a separation using Equinox:
  - a) In the **Recolor** dialog, select **Convert Separations**.
  - b) In the **Conversion Method** dropdown, select **Convert With Equinox**.



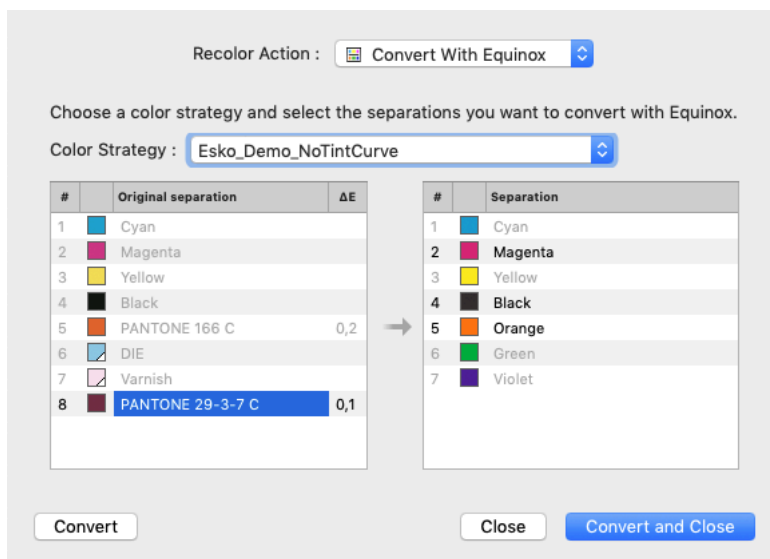

- c) Select the separation you want to convert using Equinox in the selection. Only spot color separations used in the selection are available.
- d) Select the color strategy you want to use

The available Color Strategies depend on your Color Engine settings in the Preferences. See [Preferences](#) on page 44

- e) Click **Convert** to convert the selected separations in the selected objects and close the dialog. Click **Convert All** to convert all selectable separations in the "Original Separation" list in the selected objects and close the dialog.
  - The Delta E value readout is provided by the Color Strategy
  - Separations that remain unchanged after conversion are grayed out in the destination Separations list
  - After converting, the OGB separations used in the conversion will be added to the Separations list. Separations that are no longer used will be removed.

**Note:** You need an Equinox license for this function. See [Licensing](#) on page 25

**Note:** Convert With Equinox is only available for PDF+ files. See [PDF, PDF+ and Normalized PDF](#) on page 52

**Note:** The **Recolor** function only changes separations within the selected objects. To remove separations, replace separations or convert separations to CMYK for the complete document, you can use the **Separations** section. See [Separations](#) on page 101

## 8.6. Creating objects

### 8.6.1. Create Rectangle / Create Ellipse

Using the **Create Rectangle** or **Create Ellipse** tool you can create rectangles, squares, ellipses and circles.



1. Select the **Create Rectangle** or **Create Ellipse** tool
  - By selecting the tool from the **Tool Switcher**. See [Changing tools](#) on page 38
  - By using the shortcut **S**.

**Note:** If another tool is active, the shortcut **S** will select the Create Rectangle tool. If the Create Rectangle or Create Ellipse tool is active, using the shortcut will switch between Create Rectangle and Create Ellipse.

2. Click and drag to create a rectangle or ellipse **manually**
  - By default, a rectangle or ellipse is created from the corner point. In other words, the point you start dragging will be one of the corners of the rectangle or bounding box of the ellipse. Hold the ALT key to create the shape from the center point
  - Hold the Shift key to create a constrained shape, i.e. a square or a circle.
  - Hold both the ALT and the Shift key to create a constrained shape from the center point.
3. Click to create a rectangle or ellipse **numerically**

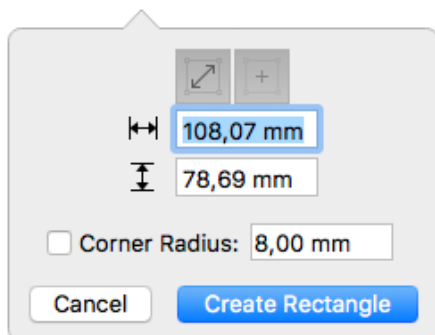
The **Create Rectangle** or **Create Ellipse** dialog will appear



- When one or more objects were selected when you clicked, the **Select Same Size** button  and **Select Same Center** button  will be enabled. This means the newly created rectangle or ellipse will have the same size and position as the bounding box of the selection. If there were no objects selected when clicking, the options will be disabled by default.

- You can enter the horizontal size and vertical size. The arrow on top of the dialog, positioned at the point you clicked, indicates the starting point of the rectangle or ellipse. You can use negative values to create the shape in the opposite direction. Changing the dimensions will automatically disable the **Select Same Size** and **Select Same Center** buttons.
- If you enable **Select Same Center**, the new shape will use the entered dimensions, centered on the center of the selection.
- For rectangles, you can enter a **Corner Radius**. This will result in rounded corners.
- Click **Create Rectangle** or **Create Ellipse** to create the new shape. If you want to close the dialog without creating a new shape, click **Cancel**, use the **Esc** key or simply click outside of the dialog in your document.

The shape you create will follow the angle of the Crosshair. See [The Crosshair](#) on page 75

The created object will take the fill and stroke of the active selection at the time of creation. If nothing is selected, the new shape will have a 100% fill of the darkest color, and no stroke.

The new object will be screened using the default screen set, when available.

The corner radius of a rectangle with rounded corners can't be changed after creation.

**Note:** Enabling the **Select Same Size** button will always enable **Select Same Center** as well.

## 8.6.2. Shaper

**Note:** The availability of this functionality depends on your license of ArtPro+. See [Licensing](#) on page 25

Using the Shaper tool you can make combinations of existing objects

1. Select one or more objects
2. Choose **Object > Shaper**, click the **Shaper** button or use its shortcut **Cmd+E** (Mac) or **Ctrl+E** (Windows) to open the Shaper window.

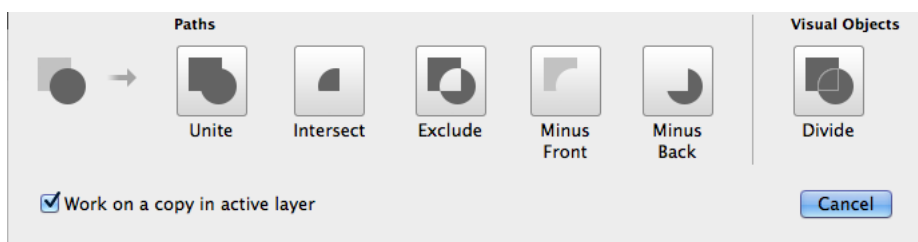

3. If you want to create new objects based on the Shaper operation, select **Work on a copy in active layer**. If you want to modify the selected objects, leave the option disabled.
4. Click the button or apply the shortcut of the operation you want to perform:
  - **Unite** combines your selected objects into a single shape. Shortcut **1**.
  - **Intersect** keeps the areas where objects are stacked on top of each other. Shortcut **2**.
  - **Exclude** keeps the areas where an odd number of objects are stacked on top of each other. Shortcut **3**.
  - **Minus Front** keeps the areas of the bottom shape which are not overlapping with the overlying shapes. Shortcut **4**.

- **Minus Back** keeps the areas of the top shape which are not overlapping with the underlying shapes. Shortcut **5**.
- **Divide** creates a group of individual areas filled with 100% of the darkest document separation. This can be used to prepare your White Underprint shapes. Shortcut **6**. This function does not include open paths or objects without fill and stroke paint.

## 8.7. Working with Text

---

ArtPro+ contains basic text editing functionality.

You can select a text box or text inside a text box and edit its properties in the **Text Inspector**, as well as creating and editing text boxes.

- You can use the Text Inspector to change text properties such as font family, size, etc. See [Text Inspector](#) on page 156
- You can use the Text Box Transformation Inspector to set the position and orientation of the Text Box. See [Text Box Transformation Inspector](#) on page 158
- You can use the Text Tool to create, edit and select text and text boxes. See [Using the Text Tool](#) on page 158
- You can replace text by its outlines using [Contourize Text](#) on page 160
- You can fix reflow issues using [Fix Text Box Reflow](#) on page 142

### 8.7.1. Text Inspector

Using the Text Inspector, you can check and change the parameters for the currently selected text.

1. Select the text you want to check or change
  - Select text boxes using the regular selection tools
  - Use the **Text Tool** and select a portion of the text.
2. Open the **Text Inspector**

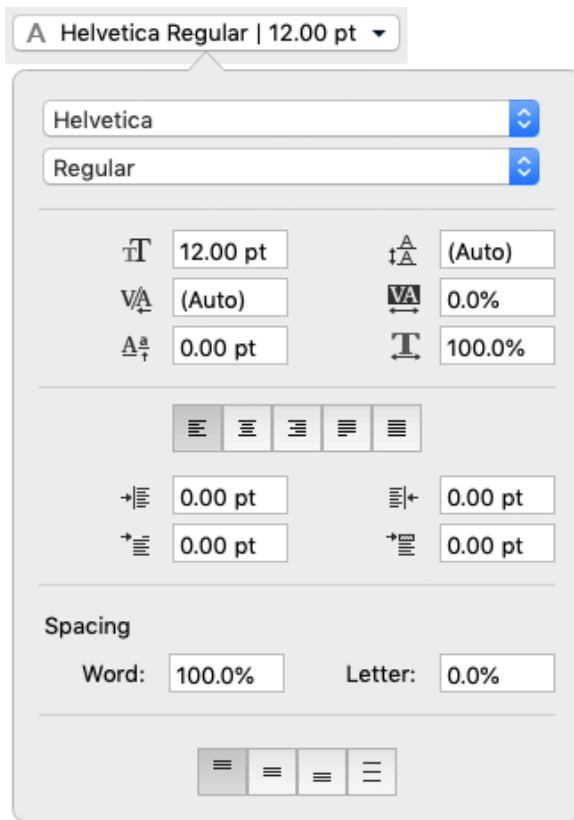

**3. Select the Font Family and Font Style.**

The Font Family dropdown will show all fonts used in the current document on top, and all available system fonts underneath.

**4. Define the Font Size, Leading, Kerning, Tracking and Level.**

For Font Size, Leading and Level, you can enter a number to use the default Font unit, or add the unit and it will be converted to the default unit. See [Preferences](#) on page 44

**5. Set the Horizontal Scaling. A negative value will flip the text.**

If you scale text using the transform tools, the Font Size and Horizontal Scaling values will be adjusted accordingly.

**6. Using one of the buttons, you can set the Alignment: Left, Central, Right, Justify only full lines or Justify all lines.**

**7. Set the Indentations: Left, Right, First Line Indent and First Line Gap (distance above the paragraph).**

**8. Define the Word and Letter Spacing**

**9. Define the Vertical alignment for the text in the text box: Top, Center, Bottom or Justified. This is only available for rectangular text boxes.**

**Note:** Changing the vertical alignment is applied on all the text in the text box, even if only a part of it was selected.

### 8.7.2. Text Box Transformation Inspector

The Transformation Inspector shows information on the size and position of the selected text box. You can also use it to do basic transformations on the text box.

For more elaborate transformations, you can use the numeric transform function. See [Numeric Transform](#) on page 125.

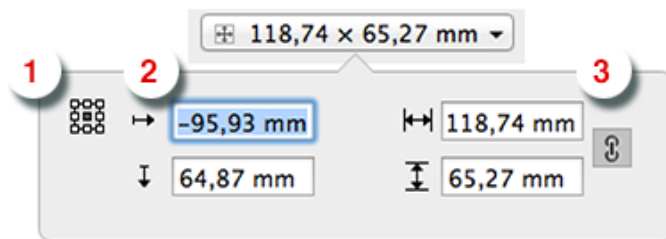

1. The **reference point** on the bounding box of the text box used to determine the position (see below) and when changing the size while the crosshair is hidden.
2. The **position**, horizontal and vertical, of the center of the crosshair to the selected reference point. If the crosshair is not visible, the top left corner of the mediabox is used instead. You can move the text box by entering a different distance.
3. The **size** of the text box. You can change the size by entering a different size. If the two values are linked, changing one value will also change the other. The center of the crosshair is used as reference point. If the crosshair is hidden, the reference point is used instead.

### 8.7.3. Using the Text Tool

Using the **Text Tool** you can create or edit a text box, and edit text in a text box.

1. Select the **Text Tool** from the Tool Selector or by its shortcut **T**.

**Note:** If the Text Tool is active, all text boxes are highlighted, so you can see where live text is located.

2. Click and drag to create a new text box, or click inside a text box to start editing it.

**Note:** If you create a new text box, it will use the system default font (Helvetica on Mac, Arial on Windows) in 100% of the darkest ink in the document. However, if you have a text box selected when creating a new text box, the properties and fill of that text box will be used in the new text box.

3. Edit the text inside the text box (see [Editing text](#) on page 159) or click and drag one of the handles of the text box to change the text box.
4. Select another tool or use the **esc** key to exit the text editing mode.

**Note:** If there are any problems displaying, editing, embedding or saving the font information, a warning will be shown.

## Editing text

When you are in text edit mode, you can change the content of the active text box

1. You can select text by click and dragging, or by one of the specific text selection functions. See [Selecting text inside a text box](#) on page 159
2. You can select text and remove it using the backspace or delete key
3. You can type to add text.
4. You can Cut, Copy and Paste text, even across multiple documents and multiple editors
5. You can use the **Text Inspector** to change the properties of the selected text. See [Text Inspector](#) on page 156

## Selecting text inside a text box

While in text edit mode, there are different ways to select parts of the text box.

- Click and drag to select a specific portion
- Drag while holding the ALT key to select full words when dragging horizontally, or full paragraphs when dragging vertically
- Use Shift + Left or Right arrow to select a single character
- Use Shift + ALT + Left or Right arrow to select a full word at a time
- Use Shift + ALT + Up or Down arrow to select a full paragraph at a time.
- Use Cmd + A (Mac) or Ctrl + A (Windows) to select all text in the text box.
- Use Cmd + Shift + A (Mac) or Ctrl + Shift + A (Windows) to deselect all text in the text box.
- Double-click to select a full word, triple-click to select the full paragraph, or quadruple-click to select all text in the text box.

## Merging text boxes

You can merge different text boxes into one single text box.

1. Use one of the selection tools to select the text boxes you want to merge
2. Choose **Object > Text Box > Merge**

When possible (i.e. the text boxes are close enough, yet not overlapping), the selected text boxes will be replaced by one single text box. If no merging is possible, a warning will be shown.

When trying to merge more than 2 text boxes, all text boxes that can be merged (see above) will be, and other text boxes remain unchanged.

## Splitting a text box

You can use the **Split** function to split a text box

1. Use the Text tool to activate the text box you want to split.
2. Place the cursor in the text where you want to split the text box, or select the text you want to put in a separate text box

3. Choose **Object > Text Box > Split**

The text box will then be split in two or (if you selected text in the middle of the text box) three separate text boxes, each keeping the text properties and visual appearance of the original.

**Note:** In some cases, ArtPro+ can suggest automatic splitting of erratic text boxes. See [Fix Text Box Reflow](#) on page 142

### 8.7.4. Extensis Universal Type Client

If you are using Extensis Universal Type Server and Client, and you have acquired an ArtPro+ Font Connector license from Extensis, you can now use this with ArtPro+.

If you open a file with an embedded subset of fonts not in your system but present on the Universal Type Server, the Extensis Universal Type Client will activate these fonts so they can be used as a system font in ArtPro+.

1. Open the **Preferences** and choose the **Extensis** tab. See [Preferences](#) on page 44

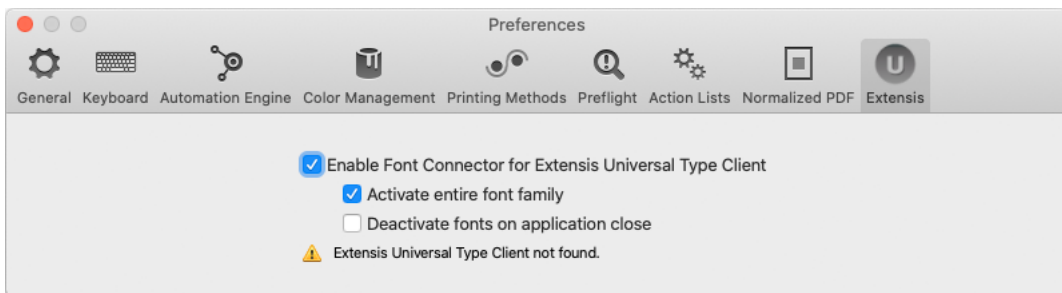

2. Select **Enable Font Connector for Extensis Universal Type Client**.

If you don't have the Universal Type Client installed, if you don't have a valid license, if its version is lower than 6.1.7, or if you are not logged on, you will get a warning and the connection will not work.

3. If you enable **Activate entire font family**, not only the font variety used in the file you open will be activated, but all fonts of the font family.
4. If the **Deactivate fonts on application close** option is enabled, fonts that were activated by ArtPro+ will be deactivated when you close the application. Otherwise, these fonts remain activated.

### 8.7.5. Contourize Text

Using this function, you can replace editable text by a group of paths and compound paths, without causing any visual difference.

1. Select the text you want to edit
2. Select **Object > Text > Contourize Text**

Contourize Text can also be applied from the **Object > Path** and **Object > Clean** menu, and from the **Clean** dialog. See [Clean](#) on page 140



**Note:** Contourize Text doesn't work on Dynamic Marks or Protected Objects.

## 8.7.6. Convert Outlines to Text

**Note:** The availability of this functionality depends on your license of ArtPro+. See [Licensing](#) on page 25

**Convert Outlines to Text** is a function to convert vectorized (contourized) text back into live editable text. This can be used e.g. to do last-minute text corrections on packaging artwork.

1. Select the outlined text that you want to convert

**Note:**

All outlines in the selection will be converted into one single text box. For this reason, it is advised to make the selection not too big: text items not too far apart, not too many different indentations etc.

On the other hand, since the font recognition is only based on the outlines in the selection, it is advised to not make the selection too small either.

2. Choose **Object > Text > Convert Outlines to Text** or use its shortcut **Cmd+Alt+Shift+T** (Mac) or **Ctrl+Alt+Shift+T** (Windows)

Convert Outlines to Text can also be applied from the **Object > Path** menu.

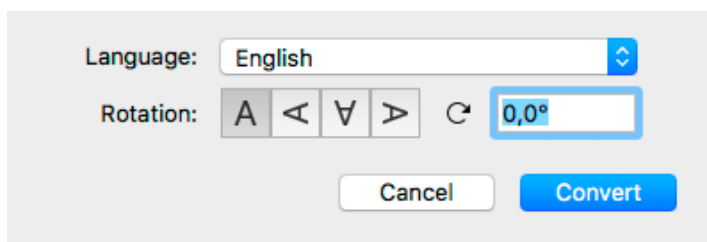

- a) Set the **Language**

You can use a Language from the "Available" list immediately. If you select a language from the "Ready To Download" list, the language will be downloaded and installed first. The Language will then move to the "Available" list. You need an internet connection to do this.

Selecting the language will help the text recognition, especially when language specific accented letters are used. So if the outlined text contains a mix of different languages, it is advised to select the language with the most accented letters.

- b) Set the **Rotation** of the outlines you want to convert, either by entering a value in the input field, or by selecting one of the four buttons. The more accurate the angle is, the more accurate the conversion will be.
- c) Click **Convert**

ArtPro+ will compare the outlines to your locally installed fonts, and will use the top matching font.

3. Once the conversion is done, the object will be shown as a Converted Text Box, and you have different options.

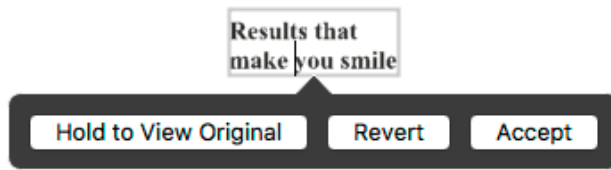

- a) Click and hold **Hold to View Original** to hide the converted text and see the original outlined text. You can toggle between the outlines and the converted text as long as you don't Accept or Revert.  
 You can also use the **Quality Control Compare** function: as long as the converted text hasn't been accepted or rejected, you will see a **Original Text Outline** option. See [Compare](#) on page 83.
- b) If the font doesn't seem like a good enough match to you, you can select a different font in the **Text Inspector**. The font list will show the best matching fonts on top of the list.
- c) If necessary, you can do small corrections to the converted text, e.g. replace a character. It is recommended to resolve this type of issues before accepting the conversion.
- d) When you're happy with the result, you can click the **Accept** button. This will remove the original outline from the document, leaving you with a regular text object that you can edit as needed. You can also use the **Accept Converted Text** in the Text inspector
- e) If you want to revert the converted text box to the original outlined text, you can click **Revert**. You can also use the **Revert Converted Text to Original Outlines** button in the Text inspector.

**Important:**

It is highly recommended to Accept (or Revert) the text conversion before closing the file. Not only to ensure smooth processing of the file further down the workflow, also in order not to lose its editing capabilities. When attempting to alter text in a Converted Text Box after saving, closing and reopening of the document, you will be prompted to restart the conversion.

This means that your outlined text will be converted again according to the same rotation angle as before, but you will need to reconfirm the language and any font or text changes you made before will be lost.

To indicate that there are unaccepted Converted Text Boxes in your document, a "Converted Text Box" message will be shown in the Messages drawer. This will only disappear once all Converted Text Boxes have been either accepted or reverted.

### 8.7.7. Create Text in Path

**Note:** The availability of this functionality depends on your license of ArtPro+. See [Licensing](#) on page 25

Using **Text in Path**, you can create a non-rectangular text area.

1. Select a single path object you want to use. Optionally, you can include one or more text boxes to the selection.
2. Choose **Object > Text > Create Text In Path**

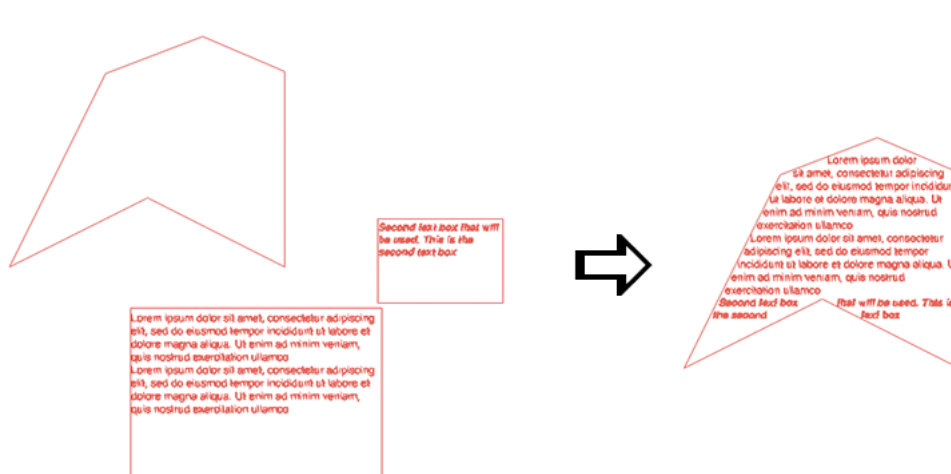

- The path object is converted to a text box object.
- The content of the selected text objects is moved inside the path, maintaining its parameters.
- Any overrun text (text that doesn't fit the text box object) is shown underneath the object.
- If you didn't select a text box along with the object when applying **Create Text In Path**, an empty text box is created, and you can immediately start typing in the text box.

You can use the path editing tools or transform tools to modify the shape of the text box, and text will automatically reflow within the text box. See [Create & Edit Path](#) on page 132 and [Transforming objects](#) on page 122

### 8.7.8. Create Text on Path

**Note:** The availability of this functionality depends on your license of ArtPro+. See [Licensing](#) on page 25

Using **Text on Path**, you can create text running along a path.

1. Select a single path object you want to use. Optionally, you can include one or more text boxes to the selection.
2. Choose **Object > Text > Create Text On Path**

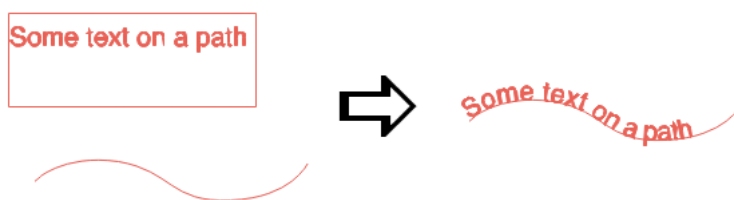

- The path object is converted to a text on path object.
- The content of the selected text objects is placed on the path, maintaining its parameters.
- Any overrun text (text that doesn't fit the text on path object) is added in a straight line at the end of the path.
- If you didn't select a text box along with the object when applying **Create Text On Path**, an empty text on path object is created. You can select it using the Text tool and start typing on the path.

- The text starts at the starting point of the path and follows its (internal) direction. You can change the starting point by cutting the path. See [Cut Path](#) on page 135
- If you want to change the direction of the text on the path, select the text on path object and choose **Object > Text > Flip Text on Path**

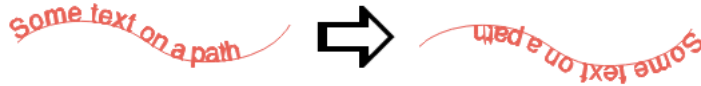

You can use the path editing tools or transform tools to modify the shape of the path, and text will automatically be adjusted. See [Create & Edit Path](#) on page 132 and [Transforming objects](#) on page 122

## 8.8. Working with images

---

### 8.8.1. Place

You can place an image in your current document

- By selecting **File > Place**.
- By its shortcut **Cmd+Shift+P** (Mac) or **Ctrl+Shift+P** (Windows).

**Note:** Using the same **Place** function, you can place Images, PDF files and Structural Design Files. See [Place](#) on page 173 and [Place Structural Design](#) on page 180

You can place images as linked images by enabling the **Link Images** option in the Place dialog. If the option is disabled, the image will be embedded. See [Linked and Embedded images](#) on page 165

ArtPro+ can place TIFF files, PSD files, JPG / JPeg and Barco .ct files.

- CMYK and DeviceN images are fully supported.
- RGB and LAB images have some limitations: Channel mapping is not possible, and linked RGB or LAB images in a Normalized PDF will be saved as embedded, high resolution CMYK images. You will be informed if this conversion takes place.
- If you place an image that contains inks not in the current document, these ink(s) will be added to your document. When doing so in a Normalized PDF, saving the file will warn you that the default screening will be applied to unscreened objects.

You can also place Barco .LP files. These always use the Black separation.

**Important:** When saving a PSD file in Adobe Photoshop, make sure to enable the "Maximize compatibility" option. Files saved without this option might not open correctly. The option can be found when saving, or in **Preferences > File Handling > File Compatibility > Maximize PSD and PSB File Compatibility**

## 8.8.2. Place Image Inside

To place an image inside the selected path or paths, you can choose **File > Place Image Inside...** or use its shortcut **Cmd-Alt-Shift-P** (Mac) or **Ctrl+Alt+Shift+P** (Windows).

The file is placed, and the selected path is used as clip path for the placed image. If your selection contains multiple paths, a compound of the selected paths is used.

The placed image is placed at 100% scaling and is positioned at the center of the bounding box of the selection. For more information about placing, see [Place](#) on page 164

You can use **Place Image Inside** if your selection contains

- 1 or multiple Paths (including contoured text),
- 1 or multiple Compound Paths,
- a mix of both
- 1 single Clipping Path.

For other selections, the Place Images Inside function will not be available.

## 8.8.3. Linked and Embedded images

Images can be linked (i.e. the reference to the external file is saved in the file), embedded (the actual image information is saved in the file) or both.

When saving Normalized PDF, embedded images are saved as embedded images, and linked images are saved as linked images.

When saving a PDF+ (see [PDF, PDF+ and Normalized PDF](#) on page 52) file containing linked images, a full resolution embedded version of the image will also be saved in the file, so when opening a PDF+ file that contains linked images that can't be found, you can choose to browse for them, continue to open the file while ignoring the broken link for now, or unlink the images and keep using the embedded version.

- When placing an image, you can enable **Link Images** to place the image linked, or you can deselect it to embed the image. See [Place](#) on page 164
- You can extract an embedded image and make it linked using the **Extract and Link** function. See [Extract and Link](#) on page 166
- You can unlink a linked image using the **Unlink** function. For Normalized PDF files, this means removing the link and embedding the image. In case of PDF+, the image is already embedded, so this will only remove the link. See [Unlink / Embed and Unlink](#) on page 166

When opening a file, and when navigating to a different page in a PDF+ file, ArtPro+ will check for missing and/or out of date files. See [Missing and out-of-date files](#) on page 56

## Extract and Link

Using **Extract and Link** you can extract the embedded image and replace it by a linked image. to the location where you want to save the linked image. By default, ArtPro+ will suggest to save the file as a TIFF, however PSD can be available as option too, depending on the contents of the image.

1. Select the embedded image you want to extract
2. Select **Object > Image > Extract and Link** or click the **Extract and Link** button in the Image Inspector
3. Set the location and file name to save the image to disk. By default, the job name is used as file name.

The image is saved to disk, and this image is then used as linked image.

If your selection contains multiple embedded images, all embedded images will be extracted and linked when possible. The extracted images will be numbered. The default suggested file name will be `PDF file name_[#].tif`. As long as the placeholder `[#]` is used, files will not be overwritten during extracting.

## Unlink / Embed and Unlink

**Unlink** (for PDF+) and **Embed and Unlink** (for Normalized PDF) will remove the link to the image file on disk and only keep an embedded version of the image in the document

1. Select the linked image you want to embed
2. Select **Object > Image > Unlink** or **Embed and Unlink**, or click the **(Embed and) Unlink** button in the Image Inspector

## Update images

**Update** will check if the image on disk has been changed, and if so, update the preview in the document.

You can either choose **Object > Image > Update**, click the **Update** button in the Image Inspector, or select **Update** in the fly-out menu of the Images Side Drawer.

If the image cannot be found at the moment the image is selected in the document, the **Update** button in the Image Inspector will be replaced by a **Browse** button, allowing to relocate the missing image.

If the updated image contains less or more channels than the original, you will be informed about it. If there are now less channels than in the original, the obsolete channels are removed from the image channels list in the Channel Mapping inspector. If the updated image has extra image channels, they will appear in the image channels list in the Channel Mapping inspector, but won't be used in the channel mapping automatically.

### 8.8.4. Image Inspector

If the selection contains an image, the **Image Inspector** will be available.

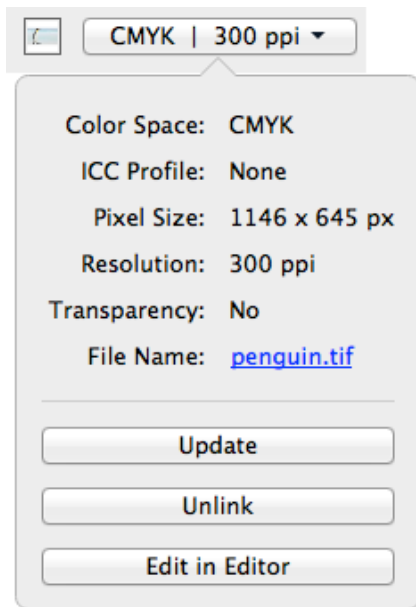

The Image Inspector will show all properties of the selected image

- File Name: the name of the linked image. If the name is underlined and blue, the name works as a link to open the file location in Finder (Mac) or Windows Explorer (Windows) in physical shares, or in the My Workspace web page in case of a location on an Automation Engine SaaS server. If the name is underlined but gray, it means the link can (temporarily) not be found.
- the **Color Space**: Bitmap, Grayscale, CMYK, Multichannel, RGB or Lab
- the **ICC Profile** used in the image
- the Pixel Size
- the Resolution in ppi. If multiple images are selected, the minimum and maximum resolution are shown.
- Transparency: does the image contain a transparency (Alpha) channel, yes or no.

**Note:** The resolution used is the output resolution, after the scaling of the image



You also have the following buttons:

- The **Edit in Editor** button. See [Opening images in an external editor](#) on page 169
- The **Update** or **Browse** button for linked images. See [Update images](#) on page 166
- **(Embed and) Unlink** for linked images. See [Unlink / Embed and Unlink](#) on page 166
- **Extract and Link** for embedded images. See [Extract and Link](#) on page 166

### 8.8.5. The Channel Mapping Inspector

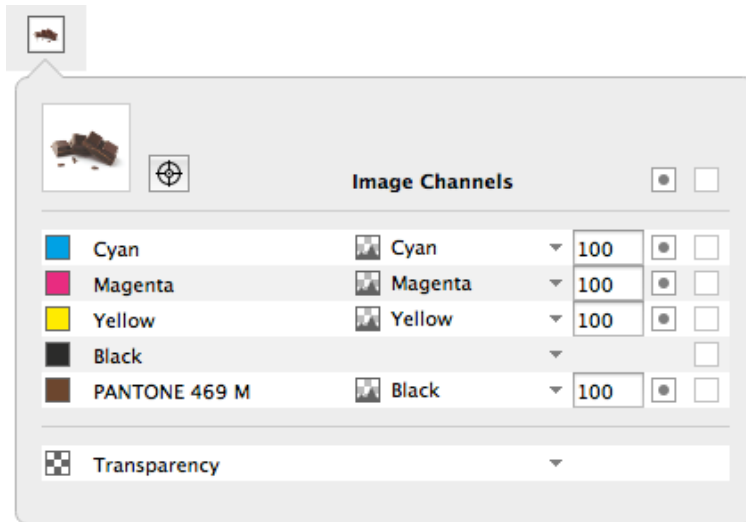
If the selection contains one image (or multiple copies of the same image), the **Channel Mapping Inspector** will be available. This can be used to remap an image channel to another ink, invert a channel or change its Density. Mapping a channel onto a (different) separation means the data of that channel will be used for output on the specified separation. In the example underneath, the data of the Black channel of the image will be output in the brown Pantone separation



- For every separation, you can define what channel of the image you want to use. You can also define the channel you want to use as **Transparency** channel. See [Using a Transparency channel](#).
  - a) Click in the **Image Channel** column and select the channel you want to use from the dropdown. All channels found in the image will be available in the dropdown.
  - b) Enter a percentage between 0% and 100% in the **Density** field to set the maximum Density for the channel.
    - Enter **a** followed by a value, to set all separations to that value.
    - enter **x** to set the value to 100%, or enter **ax** to set all values to 100%
    - Click the color patch to set the value for that separation to 100%. Clicking it again will switch it between 0% and 100%.
  - c) Click the **Invert** button  to invert the channel
- Click the **Registration Color** button  to switch to registration color. The dialog will only show one line, and the selected channel and density percentage will be used for all separations. The Registration Color button has changed to this: . Click this button to switch back to normal color.
- For separations that don't have a channel assigned, you can click the overprinting button  on top of the column, or next to any of the unmapped separations, to switch all unmapped separations to overprinting . Clicking one of the buttons again will switch them all back to knock-out.

For embedded images, the origin of the channels can't be kept, so when you save, close and reopen a file with embedded images, the channel names will match the separation names again - even if these channels were originally taken from another separation. E.g. if you map the Cyan channel onto the Magenta separation, the name of the channel will remain Cyan while you are still working on the file. Once you've saved, closed and reopened it, the channel for the Magenta separation will be called Magenta (but contain the data from the original Cyan channel).

For images that are linked (both in Normalized PDF and PDF+), ArtPro+- remembers the origin of the channels, so even after saving, closing and reopening, you will still see the original name of the





channel. So in the given example, the channel for the Magenta separation will still be called Cyan after a save, close and reopen. This will allow to apply the same channel mapping when replacing the image. See [Replacing an image](#) on page 170

Channel mapping is not possible for RGB or LAB images.

## Using a Transparency Channel

In the Channel Mapping Inspector, you can set any image channel as Transparency channel.

1. Use the **Density** percentage field to reduce the opacity.
2. Click the **Invert** button  to invert the channel. Inverting is done before applying the density.
3. By default, the transparency channel is only applied on the base color space, so typically on the CMYK channels, and not on the spot color channels. You can however change this by opening the channel selection dropdown and choosing **(Do not) Apply transparency on this channel**. The icon in front of the channel will change indicating the transparency is applied  or not 
  - This option is only available if a Transparency channel is set.
  - This setting applies to wherever the channel is used. A channel mapped on multiple separations can only have one setting
  - If you change the setting so it doesn't conform to the Photoshop model (i.e. transparency applied on a spot color, or transparency not applied on a process separation), **Edit in Editor** will not be available.

### 8.8.6. Opening images in an external editor

Images placed in ArtPro+ can be easily edited in an external editor, and the changes can immediately be applied in ArtPro+.

1. If necessary, define the **External Editors for Images** in the **Preferences**. See [Preferences](#) on page 44. If it is already defined or if you want to use the default image editor, you can skip this step.
2. Select the image you want to open in the external editor, and do any of the following:
  - Alt-double-click the image
  - Alt-double-click the "Image" breadcrumb.
  - Select **Object > Image > Edit in Editor**
  - In the Image Inspector, click **Edit in Editor**

For an embedded image, a temporary copy of the image will be opened in your external image editor. For a linked image or if both are available (PDF+), the external file is opened.

3. Apply the desired changes to the image, and save it.
4. Switch back to ArtPro+. A message will inform you that an image was edited, and you can see all changes are applied on the image.

**Note:**

If the number of channel is changed and saved, the behavior will be the same as when updating an image. See [Update images](#) on page 166

### 8.8.7. Replacing an image

You can simply replace an image without having to place (and scale, position,...) the image again.



1. Select the image you want to replace, or multiple instances thereof.
2. Select **Object > Image > Replace...** and navigate to the correct image. You can only select supported image file types. See [Place](#) on page 164
3. If you want the new picture to be linked, enable the **Link** option. If you want the new picture to be embedded, disable it.
4. If the new image contains a clipping path, you will be asked if you want to import this clipping path or not.
  - If you choose to import, the old clipping path (if present) will be replaced by the clipping path from the new image
  - If you choose to not import, only the image will be replaced, and the existing clipping path (if present) will be kept.
5. Click **Open**.

The selected (copies of the) image will be replaced. Position and dimension of the replaced image are kept. If the new image has different proportions than the replaced image, it is scaled non-proportionally to fit the dimensions.

If the image you replace is a linked image, the channel mapping is kept and applied on the replaced image.

### 8.8.8. Images Side Drawer

You can open the Images Side Drawer by clicking the **Images** button in the upper toolbar. The Image Side Drawer has 2 modes:

- the **Show Images on current page** mode , that lists all images on the current page.
- the **Show Images in Opacity Masks** mode , that lists all images used in Opacity Masks on the current page. Note that this is only for inspection, and doesn't allow selection or editing.

#### Show Images on current page

For every image, you get a preview, the name of the image (or "Embedded Image x" for embedded images), resolution, pixel size, dimensions and color space. In case multiple copies of the same image are used, you can expand and collapse the list of all copies, each with their properties, by clicking the triangle.

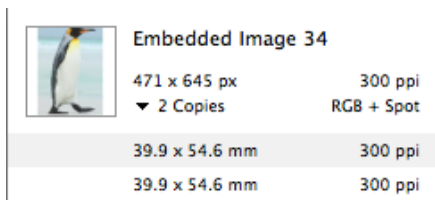

Using the buttons below the list, you can sort the images by name, by resolution or by color space.

You can select one or more images in the list, and the corresponding objects in the document will be selected as well.

If the **Zoom to Selection**  option is enabled, clicking an entry displays the selected image(s) as big as possible in the active window.

From the fly-out menu, you can apply actions on the selected images:

- Extract and Link: see [Extract and Link](#) on page 166
- Update: see [Update images](#) on page 166
- Unlink: see [Unlink / Embed and Unlink](#) on page 166
- Replace: see [Replacing an image](#) on page 170
- Edit in Editor: see [Opening images in an external editor](#) on page 169

Using **Show/Hide Info of All Copies** you can expand or collapse the information on the individual copies of all images.

### 8.8.9. Trace Image

Using **Trace Image** you can create contours based on the selected images.

1. Select the image(s) you want to create contours of.
2. Choose **Object > Image > Trace**

A **Traced Image object** is created, by default filled with 100% of the darkest separation on the page.

You can use the **Traced Image Inspector** to modify the Traced Image Object.

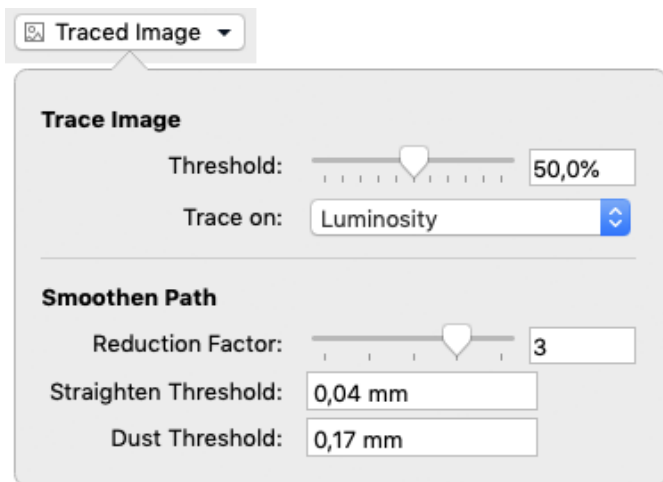

**3. Set the Trace Image options**

- a) You can change the **Threshold**. A higher threshold will include more parts of the image in the contour.
- b) You can decide if you want to trace your image based on the **Luminosity** or the **Transparency**. The latter is only available if your image contains transparency.

**Note:** The **Trace Image** options are not available when tracing a bitmap image.

**4. Set the Smoothen Path options.**

- a) The **Reduction Factor** makes the paths smoother. Higher values filter out more sharp edges and noise resulting in smoother curves. Reduction Factor 0 turns filtering off, only straightening is done. The default value for bitmap images is 0, for other images it is 3.
- b) The **Straighten Threshold** allows to reduce the noise on the paths by replacing them with straighter parts, i.e. by removing anchor points. The Threshold specifies the maximum deviation allowed between the original path and the straightened path. A larger value results in fewer points and therefore speeds up all subsequent operations.
- c) The **Dust Threshold** can be used to eliminate scanned dirt. A **Dust Threshold** of 0,07mm means that all black or white areas on the original smaller than 0,07mm by 0,07mm will be filtered away.

Below you see an example of a Traced image

- 1. With a low Reduction Factor and low Straighten Threshold
- 2. With a high Reduction Factor and low Straighten Threshold
- 3. With a low Reduction Factor and high Straighten Threshold
- 4. With a high Reduction Factor and high Straighten Threshold

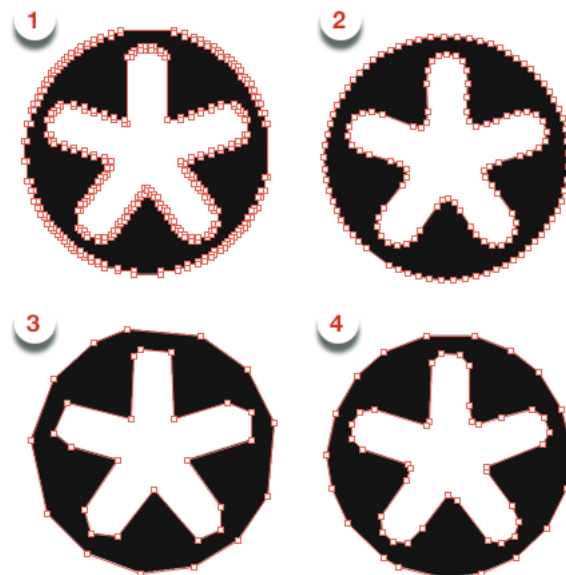

You can change the values in the **Traced Image Inspector** on any **Traced Image Object**.

Saving and reopening your document, or using the path editing tools on a Traced Image Object will convert the Traced Image Object into a regular path, and the Traced Image Inspector will no longer be available.

**Note:** Keep in mind that tracing an image **replaces** the image by a path. If you want to keep the image, e.g. to use the Traced Image Object as a clipping mask on your image, you should copy your image first.

## 8.9. Working with Placed Art

---

### 8.9.1. Place

You can place a PDF in your current document

- By selecting **File > Place**.
- By its shortcut **Cmd+Shift+P** (Mac) or **Ctrl+Shift+P** (Windows).

**Important:** Placing a PDF is only supported in PDF+ files. You can not place a PDF if the current document is a Normalized PDF file.

**Note:** Using the same **Place** function, you can place Images, PDF files and Structural Design Files. See [Place](#) on page 164 and [Place Structural Design](#) on page 180

When placing a Normalized PDF, you can automatically map specific technical inks to specific Processing Step Layers. See [Placing Normalized PDF files in a PDF+ file](#) on page 174

You can place PDF files as linked objects by enabling the **Keep Link to File** option in the Place dialog. If the option is disabled, the PDF file will be embedded. See [Linked versus Embedded Placed Art](#) on page 175

If you select multiple files, they will be placed one by one, on top of each other.

- For every PDF file you place, you can decide what Page Box defined in the file should be used to clip the placed PDF.
- When placing a multipage PDF, you can select what page to place, either by entering the page number, or by selecting it using the arrows.

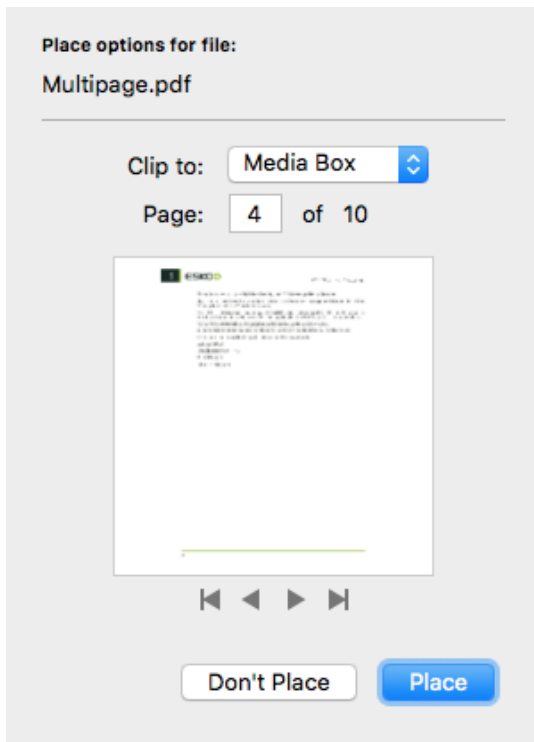

When placing a PDF, all separations used in the placed art but not yet in your document will be added in the separations list. The separation order is not changed, so the separation order in the main document can be different from the order in the placed file.

**Note:** If you select Placed Art, the Fill and Stroke inspector will show a preview of the PDF file, and the separations used in it.

### Placing Normalized PDF files in a PDF+ file

When placing a Normalized PDF in a PDF+ file, you have to take in account some specific behavior. For more information on the PDF+ file format, see [PDF, PDF+ and Normalized PDF](#) on page 52

#### Always embedded

When placing a Normalized PDF in a PDF+ file, the placed PDF will always be embedded. Linking to a placed Normalized PDF is not possible.

**Note:** Any changes done to the placed file, such as mapping technical inks (see below) are done to the embedded version only. The original Normalized PDF file is not modified.

#### Layers

All layers from the Normalized PDF file are kept, and can be seen when editing the placed PDF file.

#### Screen Sets

When placing a Normalized PDF file, the screen sets in this placed file will be merged with the screen sets already present in the current document.

### Technical Inks

Technical inks will always become **Opaque** inks.

### Mapping Technical Inks to Processing Step Layers

Normalized PDF does not support Processing Step Layers, while PDF+ does not support technical inks. Therefore, when placing a Normalized PDF file in a PDF+ file, you can map specific technical inks to specific Processing Step Layers. You can manage rules in the **Normalized PDF** section in the **Preferences**. See [Preferences](#) on page 44

If a rule is set, objects using only the defined ink will be moved to the specified Processing Step layer. These objects will end up in a layer on top of the existing layers. This can change the order of the objects. Also, moving objects to Processing Step layers can change the blend mode to "normal" and overprint can be set, similar to when manually moving objects to a Processing Step layer.

## 8.9.2. Linked versus Embedded Placed Art

If a Placed Art object is **Embedded**, this means the actual Placed Art information is saved in the file.

If a Placed Art object is **Linked**, this means the reference to the external file is saved in the file.

### PDF+ files

A PDF+ file (see [PDF, PDF+ and Normalized PDF](#) on page 52), saved in ArtPro+, can contain

- only the **embedded** version of a Placed Art object.
- both the **link** and the **embedded** version.

This means that if you place a Placed Art object (see [Place](#) on page 173) using the **Keep Link to file** option enabled, both the link AND the embedded version will be saved in the file. The same will happen when you open and save a 3rd party PDF containing (only) links to Placed Art. See below.

**Note:** If you place a Normalized PDF in a PDF+ file, it will always be embedded.

### Normalized PDF

If you open a Normalized PDF containing Placed Art created in another application, this will be recognized as such. However, you will not have the same possibilities as in a PDF+ file (no Die Shape, no Create Grid, no Place).

### Other PDF files

Placed Art in PDF files from other sources can be

- only **embedded**
- both **embedded** and **linked**
- only **linked**

This last option is not possible in PDF+ files. This means that saving it (to PDF+) will add the embedded version to the document. See above.

When opening a file, and when navigating to a different page in a PDF+ file, ArtPro+ will check for missing and/or out of date files. See [Missing and out-of-date files](#) on page 56

### Unlink

**Unlink** will remove the link to the file on disk and only keep an embedded version in the document

1. Select the linked placed art you want to embed
2. Select **Object > Placed Art > Unlink**, or click the **Unlink** button in the Placed Art Inspector

### Update

**Update** will check if the file on disk has been changed, and if so, update the preview in the document.

You can either choose **Object > Placed Art > Update**, or click the **Update** button in the Placed Art Inspector.

Separations used in the updated PDF but not yet in your document will be added in the separations list.

## 8.9.3. Placed Art Separations Inspector

If the selection contains placed art, the **Placed Art Separations Inspector** will be available.

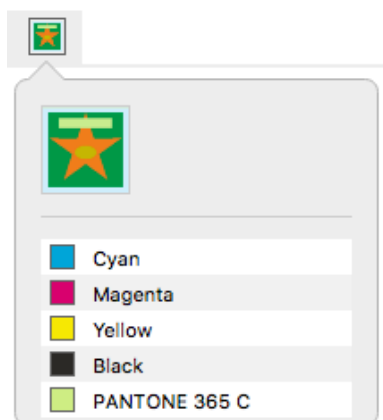

The Placed Art Separations Inspector gives a preview of the Placed Art, and a list of the separations used in it.

## 8.9.4. Placed Art Inspector

If the selection contains placed art, the **Placed Art Inspector** will be available.



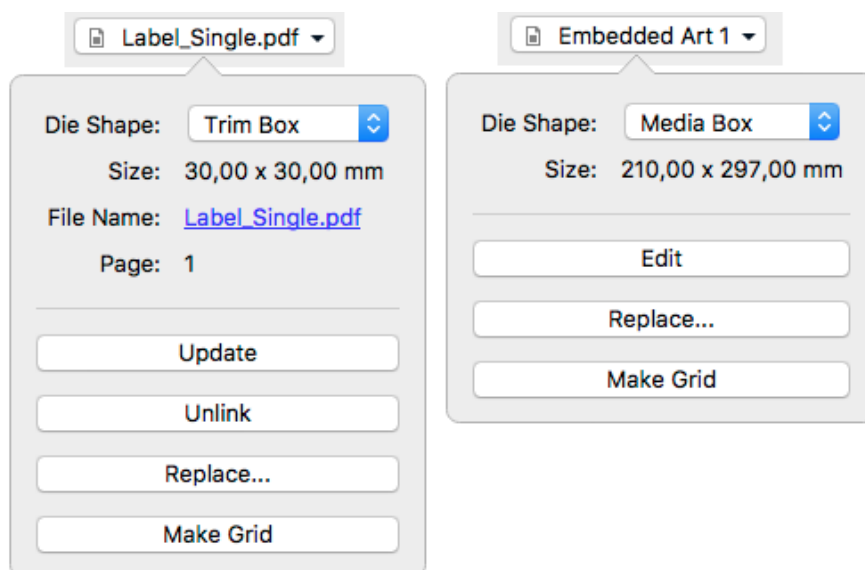

The Placed Art Inspector will show all properties of the selected placed PDF

- the **Die Shape** of the PDF that is used. Use the dropdown to select:
  - a Page Box defined in the Placed Art
  - The Processing Step Cutting layer, when available
  - Any of the separations in the Placed Art. In that case, the die shape is determined by the joint shape of all applicable objects in that separation.

**Note:** If you opened an MFG file, the Placed Art Inspector will show the name of the Layout file (.mfg), the selected Structural Design file (.ard), the Print Item when defined in ArtiosCAD, and the dimensions. See [Step & Repeat based on an MFG or CF2 file](#) on page 278

- the **Size** of the file. Changing the **Die Shape** can also change the **Size**
- The **Edit** button. See [Edit Placed Art](#) on page 178
- The **Replace** button. See [Replace Placed Art](#) on page 179
- The **Make Grid**, to create a Step&Repeat of the selected placed art. See [Step & Repeat](#) on page 268

For Linked PDFs, you will also see:

- **File Name:** the name of the linked PDF file. If the name is underlined and blue, the name works as a link to open the file location in Finder (Mac) or Windows Explorer (Windows). If the name is underlined but gray, it means the link can (temporarily) not be found.
- The **Page** of the multipage PDF that was placed.
- The **Update** button. See [Update](#) on page 176
- The **Unlink** button. See [Unlink](#) on page 176

When selecting a Grid, the Placed Art inspector will also allow to change the initial **Orientation** of the one-ups in this grid. Their orientation within the layout can be changed further by the option **Head Turn**. See [Grid Step & Repeat](#) on page 268

## 8.9.5. Layer Types Inspector

If the selection contains one or more Placed PDF files and/or a placed Structural Design file, the **Layer Types Inspector** will be available.

It will show all Processing Step Layer types that are used in any of the selected Placed Art objects.

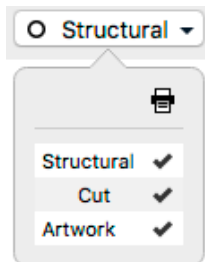

By clicking the checkmarks you can change the printing state for all layers of the selected type.

You can Alt-click a printing state field to turn its printing state on, while disabling printing for all other layers. Alt-clicking it again will revert to the previous situation.

**Note:** For Linked Placed Art, the **Update** function will revert the printing states to their original values.

## 8.9.6. Edit Placed Art

If you want to edit the content of a Placed Art object, you can do so in different ways.

- Embedded Placed Art object can be edited in a separate **Editing mode**.
  - a) Select the embedded Placed Art you want to edit
  - b) Select **Object > Placed Art > Edit** or hold the **Alt** key and double-click the Placed Art.

The Placed Art will be opened in a special Editing mode on top of your document window, where you can edit the embedded Placed Art.
  - c) Click the **Back to Document** button to close the Editing mode, and return to your document window.

The preview of the Placed Art is automatically updated.
- Linked Placed Art objects can be edited in ArtPro+ as any other PDF file
  - a) Locate the linked file in Finder (Mac) or Explorer (Window), e.g. by clicking the file name in the Placed Art Inspector. See [Placed Art Inspector](#) on page 176
  - b) Open the file, either using the **Open** function, or by drag and dropping the file into ArtPro+.

The Placed Art will be opened in a regular ArtPro+ window. Unlike when editing an embedded Placed Art, you can switch back and forth between this window and your document window.
  - c) When you're done editing, you can save and close the external PDF window.

Please note that the preview of the Placed Art is **not** automatically updated. Use [Update](#) on page 176.

- You can **Expand** the placed art, replacing the Placed Art by its actual contents, using **Object > Expand**

After expanding, all the objects from the Placed Art will be placed in a group, which you can further edit as regular objects.

### 8.9.7. Replace Placed Art

Using the **Replace** button in the Placed Art Inspector, you can replace the selected Placed Art by another PDF file.

1. Select the Placed Art you want to replace
2. In the Placed Art Inspector, click the **Replace** button
3. Select the PDF file you want to replace the selected Placed Art.
4. Click **Replace**

The newly placed file will use the same position as the original one, and the same setting (page box, ...) is used as die shape. The size of the new placed file is used.

**Replace** will replace all copies of that Placed Art on every page of the document.

### 8.9.8. Placed Art Side Drawer

The Placed Art Side Drawer shows a list of all placed PDFs used in the document. You can open it by clicking the **Placed Art** button in the upper toolbar.

For every placed art, you get a preview, the name of the linked PDF or "Embedded Image x" for embedded PDFs, the placed page of a multipage document, the dimensions and the used Page Box. In case multiple copies of the same PDF are used, you can expand and collapse the list of all copies, each with their properties, by clicking the triangle.

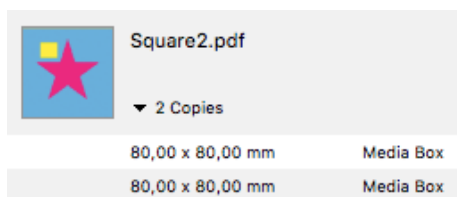

You can select one or more entries in the list, and the corresponding objects in the document will be selected as well.

If the **Zoom to Selection**  option is enabled, clicking an entry displays the selected placed art as big as possible in the active window.

In the bottom right corner there is a fly-out menu containing all available actions for the selected placed art:

- **Edit.** See [Edit Placed Art](#) on page 178
- **Replace.** See [Replace Placed Art](#) on page 179
- **Update.** See [Update](#) on page 176

- **Unlink.** See [Unlink](#) on page 176

## 8.10. Working with Structural Design files

---

### 8.10.1. Place Structural Design

You can place a Structural Design file in your current document.

- By selecting **File > Place**.
- By its shortcut **Cmd+Shift+P** (Mac) or **Ctrl+Shift+P** (Windows).

**Note:** Using the same **Place** function, you can place Images, PDF files and Structural Design Files. See [Place](#) on page 164 and [Place](#) on page 173

Currently only ARD files and one-up CF2 files are supported. You can't place an MFG file or a Layout CF2 file, but you can open it. See [Step & Repeat based on an MFG or CF2 file](#) on page 278

A Structural Design file is always **Linked**. This means that if you place a Structural Design file, both the link AND the embedded version will be saved in the file, even if the **Keep Link to file** option is disabled.

When opening a file, and when navigating to a different page in a PDF+ file, ArtPro+ will check for missing and/or out of date files. See [Missing and out-of-date files](#) on page 56

When placing a Structural Design file, ArtPro+ uses a fixed color scheme for the different line types, comparable to the color scheme used in other Esko applications such as ArtiosCAD or DeskPack. What lines are shown, depends on the Profile, either the default profile defined in the Preferences or (in a PDF+ file) the profile set in the Structural Design Inspector. See [Structural Design Inspector](#) on page 181

You can rotate and move a CF2 structural design, but you can't scale or shear it.

#### PDF+

If the Structural Design is placed in a PDF+ file, every line type is put in a corresponding Processing Step layer. You can see these layers (and change their printability) in the Layer Types Inspector if you have the Structural Design selected. See [Layer Types Inspector](#) on page 178

#### Normalized PDF

If the Structural Design is placed in a Normalized PDF, every line type is put in a corresponding Technical ink.

Normalized PDF files can contain only one placed Structural Design file. If the file already contains a placed Structural Design file, you won't be able to add another one in ArtPro+.

#### Line Types for CF2 files

The line types that are currently supported for CF2 files are:

- 1 (Cut)
- 2 (Crease)

- 3 (Perforation)
- 4 (Half-cut)
- 42 (Cut/crease)
- 43 (Annotation)
- 46 (Dimensions)

All text is treated as line type 46 (Dimensions) as well. All other line types are not imported.

### 8.10.2. Structural Design File Inspector

If the selection contains placed Structural Designs, the **Structural Design File Inspector** will be available.

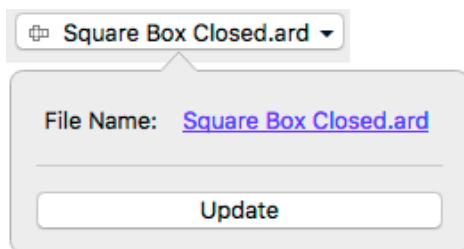

- **File Name:** the name of the linked Structural Design file. If the name is underlined and blue, the name works as a link to open the file location in Finder (Mac) or Windows Explorer (Windows). If the name is underlined but gray, it means the link can (temporarily) not be found. In that case, the Update button will be replaced by a **Browse** button.
- The **Update** button. **Update** will check if the file on disk has been changed, and if so, update the preview in the document.

### 8.10.3. Structural Design Inspector

If the selection contains at least one placed Structural Design, the **Structural Design Inspector** will be available.

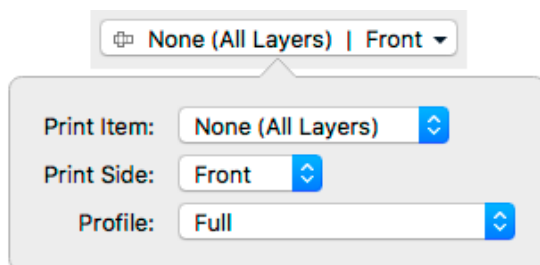

When defined in the file, you can select a **Print Item**. A Print Item is a collection of visible layers defined in ArtiosCAD. Layers not in the Print Item will not be shown. If the Structural Design is a CF2 file, Print Item will always be "none", since this doesn't exist in CF2.

You can also define what **Print Side** you want to use: Back or Front. This implies that, if e.g. an Inside Bleed line type is defined in the ARD file, it will only appear when "Back" is selected. An Outside Bleed line type will only appear when "Front" is selected.

By default the Structural Design file is shown using the default profile defined in the Preferences. See [Preferences](#) on page 44

In PDF+ files, you can however overrule this setting and define the **Profile** to be used

- **Cut and Creases:** Only Cut and Crease lines are shown.
- **Dimensions:** Cut, Creases and Dimensions are shown.
- **Full:** all line types are shown.
- **Full (Single Separation):** All line types are shown, all using a single separation (either a Technical Ink in Normalized PDF, or a Processing Step layer in PDF+ files). To make the different line types visible, every line type will have a different type: full lines for cut lines, dotted for crease lines, etc.

For CF2, there are five line types that ArtPro+ supports: Cut, Crease, Partial Cut, Annotation and Dimensions & Text. Other line types will be mapped to Annotation.

In Normalized PDF files, the default profile is always used.

## 9. Prepress functions

---

Next to the normal editing functions, ArtPro+ contains a number of specific Prepress functionality, such as Barcodes, Screening, etc.

### 9.1. Barcodes

---

You can create a new barcode by using the **Create Barcode** function. See [Create a barcode](#) on page 184

Barcodes created in ArtPro+, or supported barcodes in an opened file can be edited by selecting it and changing its settings in the Barcode Inspector. See [Edit a barcode](#) on page 184

**Note:** You can use **Expand** to convert a barcode in a regular object. See [Expand](#) on page 139

#### Supported barcodes:

The barcodes listed in [The Barcode types](#) on page 185 are supported in the following cases:

- if they were created in ArtPro+
- if they were generated by PackEdge or DeskPack and saved in Normalized PDF files
- if they were generated in ArtPro and saved as ArtPro file (for compatible barcode types that are supported both by ArtPro+ and ArtPro).

#### Currently not supported:

- Barcodes generated by other applications, in a regular PDF (not a Normalized PDF)
- Barcodes created in ArtPro and exported as PDF.
- Other types of barcodes

#### Regenerating barcodes

Barcodes created in other applications are kept unchanged after opening the file. However, if you change one of the parameters, or scale the barcode, the barcode will be regenerated. In some cases this will cause a change in the visual appearance of the barcode:

- Barcodes in ArtPro can have options that are not supported in ArtPro+, such as corner marks. A warning will be shown when opening the file. These unsupported options can disappear when the barcode is regenerated.
- Barcodes generated by ArtPro can also have a slightly different appearance than those generated in other Esko applications like ArtPro+, DeskPack or PackEdge: the Light Margin Indicator has a slightly different shape, small differences in text spacing for Code 39 codes, etc. The appearance will be adjusted when the barcode is regenerated.
- Also for barcodes coming from other applications, there might be a change in the visual appearance after regenerating, for example if the barcode was written incorrectly or inaccurately.

**Note:** Converting to PDF+ also triggers a barcode regeneration.

### 9.1.1. Create a barcode

You can create a new barcode in different ways:

- Click the **Create Barcode** button .
- Select **Prepress > Add Barcode**
- Use the shortcut **Cmd+Shift+B** (Mac) or **Ctrl+Shift+B** (Windows)

If the Crosshair is visible, the barcode will be created at the center of the Crosshair. If the Crosshair is hidden, the barcode will be created on the center of the document pane.

By default, the barcode is an EAN-13 code, uses all zeros as code, and is colored in the darkest printing separation. You can change its settings afterwards in the **Barcode Inspector**. See [Edit a barcode](#) on page 184

### 9.1.2. Edit a barcode

If you select one or more barcodes (and no other objects), you can use the different barcode related Inspectors.

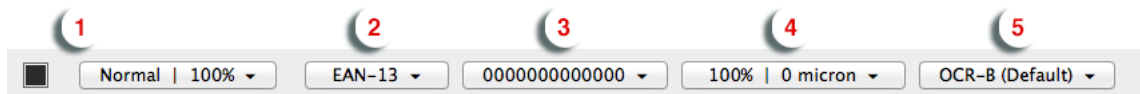

If all selected barcodes have the same value (e.g. code, Magnification, ...), the Barcode Inspector will show this value. Otherwise, it will show the ≠ symbol.

1. Click the color patch to change the color of the barcode, and use the Transparency inspector to change the transparency settings. See [Flat Color](#) on page 144 and [Transparency Inspector](#) on page 149

**Note:** Some specific barcodes (e.g. Laetus Pharma) can use Multicolor fill. See [Multicolor barcodes](#) on page 232

2. Set the **Code Type** in the Barcode Type Inspector.  
Depending on the selected barcode, an additional setting can be made, such as **Supplemental Digits** or **Code Set**. Check [The Barcode types](#) on page 185
3. Set the **Code** for the selected barcodes in the Barcode Code Inspector.  
When possible, ArtPro+ will automatically fix errors in the **Barcode** code. Possible fixes are correcting a wrong check digit, adding a missing check digit, or adding a leading zero for e.g. a UPC-E barcode. You will be warned whenever ArtPro+ adjusts the entered code.
4. Click the button showing a few key settings (such as magnification) to open the **Barcode Inspector**. The properties in this Inspector define the appearance of the bar code (height, bar with, ...). The available options depend on the selected barcode. Check the properties for a specific barcode in [The Barcode types](#) on page 185



- Click the button showing the currently selected font to open the **Barcode Font Inspector**. The properties in this Inspector define the text in barcodes. The available options depend on the selected barcode. Check the properties for a specific barcode in [The Barcode types](#) on page 185

### 9.1.3. The Barcode types

An overview of the parameters and properties per barcode type.

#### 2 of 5

Info	2 of 5 is a numeric self-checking barcode, which can have a variable length. This barcode only encodes data in the bars. It is used for industrial applications, article numbering, photo development and ticketing.
Example	
Input	unlimited amount of digits
Check Digit	None

#### Barcode Parameters

##### Narrow Bar

This parameter determines the width of the narrowest bar of your barcode (and affects the width of your barcode proportionally).

Changing this parameter will adjust the **Character Frequency**.

##### Narrow Bar Ratio

This parameter determines the ratio between the width of the widest bar and the width of the narrowest bar of your barcode. It does not affect the width of your barcode proportionally.

Changing this parameter will adjust the **Narrow Bar** parameter.

##### Character Frequency

This parameter determines the amount of character per millimeter or per inch, depending on the setting in the Preferences (and affects the width of your barcode proportionally).

Changing this parameter will adjust the **Narrow Bar** parameter. It is only available when using the default font.

##### Height

The height you enter is the combined height of the bars and the human readable characters. Your barcode needs to be tall enough to be read easily by barcode scanners.

##### Bar Width Reduction.

Use this to adjust the width of barcode bars, in order to compensate for ink bleeding when printing on your substrate.

**Tip:** You can enter a negative value if you want to print thicker and not thinner bars.

**Device Compensation**

Use this if your printer gave you a separate device bleed value. This parameter adjusts the bar's width to compensate for bleed caused by the plate or film making process.

**Note:** If you use both a Bar Width Reduction and a Device Compensation value, the **Barcode Inspector** will add them to adjust the bar's width.

**Tip:** You can enter a negative value if you want to print thicker and not thinner bars.

**Add Box**

Use this parameter to create an opaque white box under your barcode.

Use the **Top**, **Bottom**, **Left** and **Right** fields to add a white margin around your barcode and make the box bigger. You can enter a different margin for the top, left, right and bottom, or by enabling the **Lock**

button  you can set one margin for all 4 sides.

**Barcode Text Parameters**

**Add human readable text**

This option defines if the barcode's code should be visible as normal text. By default this option is enabled.

**Font Family, Font Style and Size**

By default the digits are vectorized from the standard OCR-B font. You can use real text by selecting a font family. You can also define the style and size.

By entering "0" in the Size input field, you can reset the text size to the default value for the selected barcode type.

**Offset**

Use this parameter to apply a vertical offset to the text of the barcode. A positive value moves the text down, a negative value moves the text up.

**Alignment**

Using the buttons, you can set the alignment of the text to left, centered or right.

**Code 39**

Info	Code 39 is a popular barcode in industrial barcoding systems, mainly in the U.S.A. It is used in the non-retail industry, particularly in the manufacturing, military, and health sectors. It can encode alphanumeric data.
Example	
Input	Maximum 128 characters (digits and capitals)

Check Digit	The automatically added check digit is optional.
-------------	--

**Barcode Parameters**

**Narrow Bar**

This parameter determines the width of the narrowest bar of your barcode (and affects the width of your barcode proportionally).

Changing this parameter will adjust the **Character Frequency**.

**Narrow Bar Ratio**

This parameter determines the ratio between the width of the widest bar and the width of the narrowest bar of your barcode. It does not affect the width of your barcode proportionally.

Changing this parameter will adjust the **Narrow Bar** parameter.

**Character Frequency**

This parameter determines the amount of character per millimeter or per inch, depending on the setting in the Preferences (and affects the width of your barcode proportionally).

Changing this parameter will adjust the **Narrow Bar** parameter. It is only available when using the default font.

**Height**

The height you enter is the combined height of the bars and the human readable characters. Your barcode needs to be tall enough to be read easily by barcode scanners.

**Bar Width Reduction.**

Use this to adjust the width of barcode bars, in order to compensate for ink bleeding when printing on your substrate.

**Tip:** You can enter a negative value if you want to print thicker and not thinner bars.

**Device Compensation**

Use this if your printer gave you a separate device bleed value. This parameter adjusts the bar's width to compensate for bleed caused by the plate or film making process.

**Note:** If you use both a Bar Width Reduction and a Device Compensation value, the **Barcode Inspector** will add them to adjust the bar's width.

**Tip:** You can enter a negative value if you want to print thicker and not thinner bars.

**Snap Bars to Output Resolution and Output resolution**

Use this to adjust specific barcode parameters (**Bar Width Reduction, Device Compensation, Magnification** and **Font Size**) so that the bars' width take up a complete number of pixels or dots.

Enable **Snap Bars to Output Resolution** and enter the resolution you will use to print your barcode in ppi. Everytime a value is adjusted because of this option, a warning will be shown.

By entering "0" in the input field, you can reset the Output Resolution to its default value (2540 ppi).

**Add Box**

Use this parameter to create an opaque white box under your barcode.

Use the **Top**, **Bottom**, **Left** and **Right** fields to add a white margin around your barcode and make the box bigger. You can enter a different margin for the top, left, right and bottom, or by enabling the **Lock**

button  you can set one margin for all 4 sides.

**Barcode Text Parameters**

**Add human readable text**

This option defines if the barcode's code should be visible as normal text. By default this option is enabled.

**Font Family, Font Style and Size**

By default the digits are vectorized from the standard OCR-B font. You can use real text by selecting a font family. You can also define the style and size.

By entering "0" in the Size input field, you can reset the text size to the default value for the selected barcode type.

**Offset**

Use this parameter to apply a vertical offset to the text of the barcode. A positive value moves the text down, a negative value moves the text up.

**Alignment**

Using the buttons, you can set the alignment of the text to left, centered or right.

**Code 93**

Info	Code 93 is a variable length, high density, alphanumeric barcode. It's an enhancement of the Code 93 using spaces as well as bars as a data carrier. It contains two check characters for higher data security. The Code 93 barcode allows encoding the first 128 characters of the ASCII table.
Example	
Input	Maximum 128 characters
Check Digit	none

**Barcode Parameters**

**Narrow Bar**

This parameter determines the width of the narrowest bar of your barcode (and affects the width of your barcode proportionally).

Changing this parameter will adjust the **Character Frequency**.

**Character Frequency**

This parameter determines the amount of character per millimeter or per inch, depending on the setting in the Preferences (and affects the width of your barcode proportionally).

Changing this parameter will adjust the **Narrow Bar** parameter. It is only available when using the default font.

### Height

The height you enter is the combined height of the bars and the human readable characters. Your barcode needs to be tall enough to be read easily by barcode scanners.

### Bar Width Reduction.

Use this to adjust the width of barcode bars, in order to compensate for ink bleeding when printing on your substrate.

**Tip:** You can enter a negative value if you want to print thicker and not thinner bars.

### Device Compensation

Use this if your printer gave you a separate device bleed value. This parameter adjusts the bar's width to compensate for bleed caused by the plate or film making process.

**Note:** If you use both a Bar Width Reduction and a Device Compensation value, the **Barcode Inspector** will add them to adjust the bar's width.

**Tip:** You can enter a negative value if you want to print thicker and not thinner bars.

### Add Box

Use this parameter to create an opaque white box under your barcode.

Use the **Top**, **Bottom**, **Left** and **Right** fields to add a white margin around your barcode and make the box bigger. You can enter a different margin for the top, left, right and bottom, or by enabling the **Lock**

button  you can set one margin for all 4 sides.

## Barcode Text Parameters

### Add human readable text

This option defines if the barcode's code should be visible as normal text. By default this option is enabled.

### Font Family, Font Style and Size

By default the digits are vectorized from the standard OCR-B font. You can use real text by selecting a font family. You can also define the style and size.

By entering "0" in the Size input field, you can reset the text size to the default value for the selected barcode type.

### Offset

Use this parameter to apply a vertical offset to the text of the barcode. A positive value moves the text down, a negative value moves the text up.

### Alignment

Using the buttons, you can set the alignment of the text to left, centered or right.

**Code 128**

Info	Code 128 is a variable length, high density, alphanumeric barcode. It has the second highest density of all the 1D barcodes (after the GS1 Databar Expanded).  After selecting the barcode type, you can set the <b>Code Set</b> . By default this is set to <b>Automatic</b> . In that case, the encoding type is chosen automatically, to optimize the content encoding. To obtain an optimal utilization of the code-sets A and B but prevent the usage of the space saving code-set C, set the Code Set to <b>Long</b> . Select <b>A</b> or <b>B</b> to force the usage of the specific code-set A or B.
Example	
Input	Maximum 128 characters (digits and letters)
Check Digit	none.

**Barcode Parameters**

**Narrow Bar**

This parameter determines the width of the narrowest bar of your barcode (and affects the width of your barcode proportionally).

Changing this parameter will adjust the **Character Frequency**.

**Character Frequency**

This parameter determines the amount of character per millimeter or per inch, depending on the setting in the Preferences (and affects the width of your barcode proportionally).

Changing this parameter will adjust the **Narrow Bar** parameter. It is only available when using the default font.

**Height**

The height you enter is the combined height of the bars and the human readable characters. Your barcode needs to be tall enough to be read easily by barcode scanners.

**Add light margin indicator**

Use this option to add light margin indicators before ("**<**") and/or after ("**>**") the barcode number

**Bar Width Reduction.**

Use this to adjust the width of barcode bars, in order to compensate for ink bleeding when printing on your substrate.

**Tip:** You can enter a negative value if you want to print thicker and not thinner bars.

**Device Compensation**

Use this if your printer gave you a separate device bleed value. This parameter adjusts the bar's width to compensate for bleed caused by the plate or film making process.

**Note:** If you use both a Bar Width Reduction and a Device Compensation value, the **Barcode Inspector** will add them to adjust the bar's width.

**Tip:** You can enter a negative value if you want to print thicker and not thinner bars.

**Snap Bars to Output Resolution and Output resolution**

Use this to adjust specific barcode parameters (**Bar Width Reduction, Device Compensation, Magnification** and **Font Size**) so that the bars' width take up a complete number of pixels or dots.

Enable **Snap Bars to Output Resolution** and enter the resolution you will use to print your barcode in ppi. Everytime a value is adjusted because of this option, a warning will be shown.

By entering "0" in the input field, you can reset the Output Resolution to its default value (2540 ppi).

**Add Box**

Use this parameter to create an opaque white box under your barcode.

Use the **Top, Bottom, Left** and **Right** fields to add a white margin around your barcode and make the box bigger. You can enter a different margin for the top, left, right and bottom, or by enabling the **Lock**

button  you can set one margin for all 4 sides.

**Barcode Text Parameters**

**Add human readable text**

This option defines if the barcode's code should be visible as normal text. By default this option is enabled.

**Font Family, Font Style and Size**

By default the digits are vectorized from the standard OCR-B font. You can use real text by selecting a font family. You can also define the style and size.

By entering "0" in the Size input field, you can reset the text size to the default value for the selected barcode type.

**Offset**

Use this parameter to apply a vertical offset to the text of the barcode. A positive value moves the text down, a negative value moves the text up.

**Alignment**

Using the buttons, you can set the alignment of the text to left, centered or right.

**Multicolor**

This barcode can be colorized using the Multicolor fill option. See [Multicolor barcodes](#) on page 232

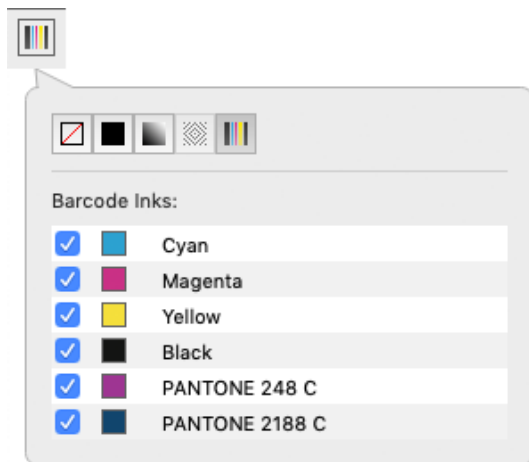

**Data Matrix**

Info	<p>Data Matrix is used for encoding large amounts of alphanumeric data and / or marking small objects. It can encode all the standard ASCII and extended ASCII characters.</p> <p>The Data Matrix symbol size can adjust automatically depending on the amount of data.</p> <p><b>Note:</b> ArtPro+ always generates Data Matrix symbols with the recommended ECC200 error correction scheme.</p>
Example	
Input	unlimited
Check Digit	none

**Barcode Parameters**

**Symbol Size**

The amount of Cells in a barcode. The Symbol Size will automatically increase when entering too much data for the current symbol size.

**Cell Size**

The size of a single black or white square.

**Bar Width Reduction.**

Use this to adjust the width of barcode bars, in order to compensate for ink bleeding when printing on your substrate.



**Tip:** You can enter a negative value if you want to print thicker and not thinner bars.

**Device Compensation**

Use this if your printer gave you a separate device bleed value. This parameter adjusts the bar's width to compensate for bleed caused by the plate or film making process.

**Note:** If you use both a Bar Width Reduction and a Device Compensation value, the **Barcode Inspector** will add them to adjust the bar's width.

**Tip:** You can enter a negative value if you want to print thicker and not thinner bars.

**Add Box**

Use this parameter to create an opaque white box under your barcode.

Use the **Top**, **Bottom**, **Left** and **Right** fields to add a white margin around your barcode and make the box bigger. You can enter a different margin for the top, left, right and bottom, or by enabling the **Lock**

button  you can set one margin for all 4 sides.

**EAN-8**

Info	EAN-8 is an abbreviated version of EAN-13 (see <a href="#">EAN-13</a> on page 195), for use on smaller packages.
Example	
Input	The input for an EAN-8 code is 8 digits, with optionally 2 or 5 supplemental digits, if set in the <b>Code Type</b> dialog.
Check Digit	The 8th digit is a check digit.

**Barcode Parameters**

**Magnification**

Use this parameter to increase or decrease the width of the barcode. Changing the Magnification will also change the Font Size and Vertical Offset.

By entering "0" in the input field, you can reset the Magnification to its default value (100%).



**Attention:** Changing the **Magnification** does not change the **Height** of the barcode. You can however reset the Height by entering "0". The Height will be proportionally scaled to the current Magnification.

**Height**

The height you enter is the combined height of the bars and the human readable characters. Your barcode needs to be tall enough to be read easily by barcode scanners.

**Add light margin indicator**

Use this option to add light margin indicators before (" $<$ ") and/or after (" $>$ ") the barcode number

**Bar Width Reduction.**

Use this to adjust the width of barcode bars, in order to compensate for ink bleeding when printing on your substrate.

**Tip:** You can enter a negative value if you want to print thicker and not thinner bars.

**Device Compensation**

Use this if your printer gave you a separate device bleed value. This parameter adjusts the bar's width to compensate for bleed caused by the plate or film making process.

**Note:** If you use both a Bar Width Reduction and a Device Compensation value, the **Barcode Inspector** will add them to adjust the bar's width.

**Tip:** You can enter a negative value if you want to print thicker and not thinner bars.

**Snap Bars to Output Resolution and Output resolution**

Use this to adjust specific barcode parameters (**Bar Width Reduction, Device Compensation, Magnification** and **Font Size**) so that the bars' width take up a complete number of pixels or dots.

Enable **Snap Bars to Output Resolution** and enter the resolution you will use to print your barcode in ppi. Everytime a value is adjusted because of this option, a warning will be shown.

By entering "0" in the input field, you can reset the Output Resolution to its default value (2540 ppi).

**Add Box**

Use this parameter to create an opaque white box under your barcode.

Use the **Top, Bottom, Left** and **Right** fields to add a white margin around your barcode and make the box bigger. You can enter a different margin for the top, left, right and bottom, or by enabling the **Lock**

button  you can set one margin for all 4 sides.

**Barcode Text Parameters**

**Add human readable text**

This option defines if the barcode's code should be visible as normal text. By default this option is enabled.

**Font Family, Font Style and Size**

By default the digits are vectorized from the standard OCR-B font. You can use real text by selecting a font family. You can also define the style and size.

By entering "0" in the Size input field, you can reset the text size to the default value for the selected barcode type.

**Offset**

Use this parameter to apply a vertical offset to the text of the barcode. A positive value moves the text down, a negative value moves the text up.

**Position supplemental digits above bars**

If the barcode contains supplemental digits, those digits will be placed above the bars if this option is enabled, or below the bars when it is disabled.

**EAN-13**

Info	<p>European Article Numbering system or EAN is the standard for article numbering in Europe. It is also used in Japan where it is called JAN.</p> <p><b>Note:</b> EAN is the European equivalent of the UPC system in the U.S.A. and Canada. Both systems use the same size requirements and a similar encoding scheme. This means that most European and American retail barcode scanners can read both EAN and UPC barcodes. For more information on UPC, see <a href="#">UPC-A</a> on page 223.</p>
Example	
Input	<p>The input for an EAN 13-code is 13 digits, with optionally 2 or 5 supplemental digits, if set in the <b>Code Type</b> dialog.</p>
Check Digit	<p>The 13th digit is a check digit.</p>
Recommendations	<ul style="list-style-type: none"> <li>• Magnification: between 80% and 200%</li> </ul>

**Barcode Parameters**

**Magnification**

Use this parameter to increase or decrease the width of the barcode. Changing the Magnification will also change the Font Size and Vertical Offset.

By entering "0" in the input field, you can reset the Magnification to its default value (100%).



**Attention:** Changing the **Magnification** does not change the **Height** of the barcode. You can however reset the Height by entering "0". The Height will be proportionally scaled to the current Magnification.

**Height**

The height you enter is the combined height of the bars and the human readable characters. Your barcode needs to be tall enough to be read easily by barcode scanners.

**Add light margin indicator**

Use this option to add light margin indicators before (" $<$ ") and/or after (" $>$ ") the barcode number

**Bar Width Reduction.**

Use this to adjust the width of barcode bars, in order to compensate for ink bleeding when printing on your substrate.

**Tip:** You can enter a negative value if you want to print thicker and not thinner bars.

**Device Compensation**

Use this if your printer gave you a separate device bleed value. This parameter adjusts the bar's width to compensate for bleed caused by the plate or film making process.

**Note:** If you use both a Bar Width Reduction and a Device Compensation value, the **Barcode Inspector** will add them to adjust the bar's width.

**Tip:** You can enter a negative value if you want to print thicker and not thinner bars.

**Snap Bars to Output Resolution and Output resolution**

Use this to adjust specific barcode parameters (**Bar Width Reduction, Device Compensation, Magnification and Font Size**) so that the bars' width take up a complete number of pixels or dots.

Enable **Snap Bars to Output Resolution** and enter the resolution you will use to print your barcode in ppi. Everytime a value is adjusted because of this option, a warning will be shown.

By entering "0" in the input field, you can reset the Output Resolution to its default value (2540 ppi).

**Add Box**

Use this parameter to create an opaque white box under your barcode.

Use the **Top, Bottom, Left** and **Right** fields to add a white margin around your barcode and make the box bigger. You can enter a different margin for the top, left, right and bottom, or by enabling the **Lock**

button  you can set one margin for all 4 sides.

**Barcode Text Parameters**

**Add human readable text**

This option defines if the barcode's code should be visible as normal text. By default this option is enabled.

**Font Family, Font Style and Size**

By default the digits are vectorized from the standard OCR-B font. You can use real text by selecting a font family. You can also define the style and size.

By entering "0" in the Size input field, you can reset the text size to the default value for the selected barcode type.

**Offset**

Use this parameter to apply a vertical offset to the text of the barcode. A positive value moves the text down, a negative value moves the text up.

**Position supplemental digits above bars**

If the barcode contains supplemental digits, those digits will be placed above the bars if this option is enabled, or below the bars when it is disabled.

**EAN-13 Swissmedic**

Info	<p>EAN 13 Swissmedic is an EAN 13 barcode used for items licensed by the Swiss Agency for Therapeutic Products</p> <p>It always starts with "7680", uses a specific text positioning and adds the text "swissmedic" below the code.</p>
------	---

	For EAN 13 Swissmedic barcodes, only the default font settings can be used, so there are no Barcode Text Parameters.
Example	
Input	The input for an EAN 13-code is 13 digits, starting with "7680"
Check Digit	The 13th digit is a check digit.

### Barcode Parameters

#### Magnification

Use this parameter to increase or decrease the width of the barcode. Changing the Magnification will also change the Font Size and Vertical Offset.

By entering "0" in the input field, you can reset the Magnification to its default value (100%).



**Attention:** Changing the **Magnification** does not change the **Height** of the barcode. You can however reset the Height by entering "0". The Height will be proportionally scaled to the current Magnification.

#### Height

The height you enter is the combined height of the bars and the human readable characters. Your barcode needs to be tall enough to be read easily by barcode scanners.

#### Bar Width Reduction.

Use this to adjust the width of barcode bars, in order to compensate for ink bleeding when printing on your substrate.

**Tip:** You can enter a negative value if you want to print thicker and not thinner bars.

#### Device Compensation

Use this if your printer gave you a separate device bleed value. This parameter adjusts the bar's width to compensate for bleed caused by the plate or film making process.

**Note:** If you use both a Bar Width Reduction and a Device Compensation value, the **Barcode Inspector** will add them to adjust the bar's width.

**Tip:** You can enter a negative value if you want to print thicker and not thinner bars.

#### Snap Bars to Output Resolution and Output resolution

Use this to adjust specific barcode parameters (**Bar Width Reduction**, **Device Compensation**, **Magnification** and **Font Size**) so that the bars' width take up a complete number of pixels or dots.

Enable **Snap Bars to Output Resolution** and enter the resolution you will use to print your barcode in ppi. Everytime a value is adjusted because of this option, a warning will be shown.

By entering "0" in the input field, you can reset the Output Resolution to its default value (2540 ppi).

**Add Box**

Use this parameter to create an opaque white box under your barcode.

Use the **Top**, **Bottom**, **Left** and **Right** fields to add a white margin around your barcode and make the box bigger. You can enter a different margin for the top, left, right and bottom, or by enabling the **Lock**

button  you can set one margin for all 4 sides.

**GS1 128**

Info	GS1 128 is based on Code 128 but has a double start sequence. See <a href="#">Code 128</a> on page 190
Example	
Input	<p>Maximum 128 characters (digits and letters)</p> <p>GS1 barcodes consist of 1 or multiple codes that start with so-called Application Identifiers (AI) - 2 digit codes that indicate a specific goal. For example: AI 11 indicates a production date, AI 17 an expiration date, AI 10 a batch or lot number, etc. The Application Identifiers require specific input, for example AI 11 and AI 17 are fixed and require 6 digits, AI 10 is variable and can contain up to 20 alphanumeric characters.</p> <p>If multiple AIs are allowed, they can be entered in multiple ways:</p> <ul style="list-style-type: none"> <li>• Just enter the codes one after the other, without any spaces. In this case you should enter fixed size Application Identifiers (AI) first, and AI with a variable length last to allow a correct validation of the barcode.</li> <li>• Put the AI between brackets. In that case it is clear where one code ends and another one begins, so variable AIs can be put at the start if so desired.</li> <li>• At the end of an AI, type "[F1]" before entering the next AI</li> <li>• For an even higher readability: use Shift-Enter to start a new AI at the next line</li> </ul>
Check Digit	depending on Application Identifier

**Barcode Parameters**

**Narrow Bar**

This parameter determines the width of the narrowest bar of your barcode (and affects the width of your barcode proportionally).

Changing this parameter will adjust the **Character Frequency**.

**Height**

The height you enter is the combined height of the bars and the human readable characters. Your barcode needs to be tall enough to be read easily by barcode scanners.

**Bar Width Reduction.**

Use this to adjust the width of barcode bars, in order to compensate for ink bleeding when printing on your substrate.

**Tip:** You can enter a negative value if you want to print thicker and not thinner bars.

**Device Compensation**

Use this if your printer gave you a separate device bleed value. This parameter adjusts the bar's width to compensate for bleed caused by the plate or film making process.

**Note:** If you use both a Bar Width Reduction and a Device Compensation value, the **Barcode Inspector** will add them to adjust the bar's width.

**Tip:** You can enter a negative value if you want to print thicker and not thinner bars.

**Snap Bars to Output Resolution and Output resolution**

Use this to adjust specific barcode parameters (**Bar Width Reduction**, **Device Compensation**, **Magnification** and **Font Size**) so that the bars' width take up a complete number of pixels or dots.

Enable **Snap Bars to Output Resolution** and enter the resolution you will use to print your barcode in ppi. Everytime a value is adjusted because of this option, a warning will be shown.

By entering "0" in the input field, you can reset the Output Resolution to its default value (2540 ppi).

**Add Box**

Use this parameter to create an opaque white box under your barcode.

Use the **Top**, **Bottom**, **Left** and **Right** fields to add a white margin around your barcode and make the box bigger. You can enter a different margin for the top, left, right and bottom, or by enabling the **Lock**

button  you can set one margin for all 4 sides.

**Barcode Text Parameters****Add human readable text**

This option defines if the barcode's code should be visible as normal text. By default this option is enabled.

**Position text above barcode**

This option places the text above the barcode instead of below.

**Wrap text**

This option allows to put the text on multiple lines, one line per AI.

**Font Family, Font Style and Size**

By default the digits are vectorized from the standard OCR-B font. You can use real text by selecting a font family. You can also define the style and size.

By entering "0" in the Size input field, you can reset the text size to the default value for the selected barcode type.

**Offset**

Use this parameter to apply a vertical offset to the text of the barcode. A positive value moves the text down, a negative value moves the text up.

**Alignment**

Using the buttons, you can set the alignment of the text to left, centered or right.

**GS1 Databar Expanded - Expanded Stacked**

<p>Info</p>	<p>GS1 DataBar Expanded (formerly RSS Expanded) encodes regular barcode data ("primary item identification" data) and Application Identifiers. It can encode alphanumeric characters.</p> <p>This barcode can be scanned omnidirectionally by suitably programmed slot scanners.</p> <p>GS1 DataBar Expanded Stacked can encode the same amount of data as GS1 DataBar Expanded, but can also "stack" the barcode into several rows to save space.</p>
<p>Example</p>	
<p>Input</p>	<p>GS1 barcodes consist of 1 or multiple codes that start with so-called Application Identifiers (AI) - 2 digit codes that indicate a specific goal. For example: AI 11 indicates a production date, AI 17 an expiration date, AI 10 a batch or lot number, etc. The Application Identifiers require specific input, for example AI 11 and AI 17 are fixed and require 6 digits, AI 10 is variable and can contain up to 20 alphanumeric characters.</p> <p>If multiple AIs are allowed, they can be entered in multiple ways:</p> <ul style="list-style-type: none"> <li>• Just enter the codes one after the other, without any spaces. In this case you should enter fixed size Application Identifiers (AI) first, and AI with a variable length last to allow a correct validation of the barcode.</li> <li>• Put the AI between brackets. In that case it is clear where one code ends and another one begins, so variable AIs can be put at the start if so desired.</li> <li>• At the end of an AI, type "[F1]" before entering the next AI</li> <li>• For an even higher readability: use Shift-Enter to start a new AI at the next line</li> </ul>
<p>Check Digit</p>	<p>depending on Application Identifier</p>

**Barcode Parameters**

**Maximum Row Segments**

Use this parameter to define how many segments of data (groups of bars encoding several digits) can fit in one row. If the barcode contains more segments, they will be stacked.

**Narrow Bar**



This parameter determines the width of the narrowest bar of your barcode (and affects the width of your barcode proportionally).

Changing this parameter will adjust the **Character Frequency**.

**Bar Width Reduction.**

Use this to adjust the width of barcode bars, in order to compensate for ink bleeding when printing on your substrate.

**Tip:** You can enter a negative value if you want to print thicker and not thinner bars.

**Device Compensation**

Use this if your printer gave you a separate device bleed value. This parameter adjusts the bar's width to compensate for bleed caused by the plate or film making process.

**Note:** If you use both a Bar Width Reduction and a Device Compensation value, the **Barcode Inspector** will add them to adjust the bar's width.

**Tip:** You can enter a negative value if you want to print thicker and not thinner bars.

**Snap Bars to Output Resolution and Output resolution**

Use this to adjust specific barcode parameters (**Bar Width Reduction, Device Compensation, Magnification and Font Size**) so that the bars' width take up a complete number of pixels or dots.

Enable **Snap Bars to Output Resolution** and enter the resolution you will use to print your barcode in ppi. Everytime a value is adjusted because of this option, a warning will be shown.

By entering "0" in the input field, you can reset the Output Resolution to its default value (2540 ppi).

**Barcode Text Parameters**

**Add human readable text**

This option defines if the barcode's code should be visible as normal text. By default this option is enabled.

**Position text above barcode**

This option places the text above the barcode instead of below.

**Wrap text**

This option allows to put the text on multiple lines, one line per AI.

**Font Family, Font Style and Size**

By default the digits are vectorized from the standard OCR-B font. You can use real text by selecting a font family. You can also define the style and size.

By entering "0" in the Size input field, you can reset the text size to the default value for the selected barcode type.

**Offset**

Use this parameter to apply a vertical offset to the text of the barcode. A positive value moves the text down, a negative value moves the text up.

**Alignment**

Using the buttons, you can set the alignment of the text to left, centered or right.

### GS1 Databar Omnidirectional

Info	GS1 DataBar Omnidirectional encodes Global Trade Item Numbers (GTIN) in a linear symbol that can be scanned omnidirectionally by suitably programmed slot scanners
Example	
Input	The GS1 Omnidirectional barcode only allows 1 identifier, of type 01. The input is 14 digits, which means that the Application Identifier itself has to be omitted.
Check Digit	last digit

#### Barcode Parameters

##### Narrow Bar

This parameter determines the width of the narrowest bar of your barcode (and affects the width of your barcode proportionally).

Changing this parameter will adjust the **Character Frequency**.

##### Bar Width Reduction.

Use this to adjust the width of barcode bars, in order to compensate for ink bleeding when printing on your substrate.

**Tip:** You can enter a negative value if you want to print thicker and not thinner bars.

##### Device Compensation

Use this if your printer gave you a separate device bleed value. This parameter adjusts the bar's width to compensate for bleed caused by the plate or film making process.

**Note:** If you use both a Bar Width Reduction and a Device Compensation value, the **Barcode Inspector** will add them to adjust the bar's width.

**Tip:** You can enter a negative value if you want to print thicker and not thinner bars.

##### Snap Bars to Output Resolution and Output resolution

Use this to adjust specific barcode parameters (**Bar Width Reduction, Device Compensation, Magnification** and **Font Size**) so that the bars' width take up a complete number of pixels or dots.

Enable **Snap Bars to Output Resolution** and enter the resolution you will use to print your barcode in ppi. Everytime a value is adjusted because of this option, a warning will be shown.

By entering "0" in the input field, you can reset the Output Resolution to its default value (2540 ppi).

#### Barcode Text Parameters

##### Add human readable text

This option defines if the barcode's code should be visible as normal text. By default this option is enabled.

**Position text above barcode**

This option places the text above the barcode instead of below.

**Wrap text**

This option allows to put the text on multiple lines, one line per AI.

**Font Family, Font Style and Size**

By default the digits are vectorized from the standard OCR-B font. You can use real text by selecting a font family. You can also define the style and size.

By entering "0" in the Size input field, you can reset the text size to the default value for the selected barcode type.

**Offset**

Use this parameter to apply a vertical offset to the text of the barcode. A positive value moves the text down, a negative value moves the text up.

**Alignment**

Using the buttons, you can set the alignment of the text to left, centered or right.

**GS1 Databar Stacked**

Info	GS1 DataBar Stacked is a variation of the GS1 DataBar barcode, that is stacked in two rows and used when the normal barcode would be too wide for the product.
Example	<p>( 1 1 ) 1 2 3 4 5 6 ( 1 7 ) 1 8 9 9 8 6</p>  <p>( 0 1 ) 0 0 0 0 0 0 0 0 0 0 0 0 0 0</p>
Input	<p>GS1 barcodes consist of 1 or multiple codes that start with so-called Application Identifiers (AI) - 2 digit codes that indicate a specific goal. For example: AI 11 indicates a production date, AI 17 an expiration date, AI 10 a batch or lot number, etc. The Application Identifiers require specific input, for example AI 11 and AI 17 are fixed and require 6 digits, AI 10 is variable and can contain up to 20 alphanumeric characters.</p> <p>If multiple AIs are allowed, they can be entered in multiple ways:</p> <ul style="list-style-type: none"> <li>• Just enter the codes one after the other, without any spaces. In this case you should enter fixed size Application Identifiers (AI) first, and AI with a variable length last to allow a correct validation of the barcode.</li> <li>• Put the AI between brackets. In that case it is clear where one code ends and another one begins, so variable AIs can be put at the start if so desired.</li> <li>• At the end of an AI, type "[F1]" before entering the next AI</li> <li>• For an even higher readability: use Shift-Enter to start a new AI at the next line</li> </ul>
Check Digit	depending on Application Identifier

## Barcode Parameters

### Narrow Bar

This parameter determines the width of the narrowest bar of your barcode (and affects the width of your barcode proportionally).

Changing this parameter will adjust the **Character Frequency**.

### Bar Width Reduction.

Use this to adjust the width of barcode bars, in order to compensate for ink bleeding when printing on your substrate.

**Tip:** You can enter a negative value if you want to print thicker and not thinner bars.

### Device Compensation

Use this if your printer gave you a separate device bleed value. This parameter adjusts the bar's width to compensate for bleed caused by the plate or film making process.

**Note:** If you use both a Bar Width Reduction and a Device Compensation value, the **Barcode Inspector** will add them to adjust the bar's width.

**Tip:** You can enter a negative value if you want to print thicker and not thinner bars.

### Snap Bars to Output Resolution and Output resolution

Use this to adjust specific barcode parameters (**Bar Width Reduction, Device Compensation, Magnification and Font Size**) so that the bars' width take up a complete number of pixels or dots.

Enable **Snap Bars to Output Resolution** and enter the resolution you will use to print your barcode in ppi. Everytime a value is adjusted because of this option, a warning will be shown.

By entering "0" in the input field, you can reset the Output Resolution to its default value (2540 ppi).

## Barcode Text Parameters

### Add human readable text

This option defines if the barcode's code should be visible as normal text. By default this option is enabled.

### Position text above barcode

This option places the text above the barcode instead of below.

### Wrap text

This option allows to put the text on multiple lines, one line per AI.

### Font Family, Font Style and Size

By default the digits are vectorized from the standard OCR-B font. You can use real text by selecting a font family. You can also define the style and size.

By entering "0" in the Size input field, you can reset the text size to the default value for the selected barcode type.

### Offset

Use this parameter to apply a vertical offset to the text of the barcode. A positive value moves the text down, a negative value moves the text up.

### Alignment

Using the buttons, you can set the alignment of the text to left, centered or right.

### GS1 Databar Stacked Omnidirectional

Info	GS1 DataBar14 Stacked Omnidirectional is taller version of GS1 DataBar14 Stacked, that can be read by omnidirectional scanners.
Example	<p>( 1 1 ) 1 2 3 4 5 6 ( 1 7 ) 1 8 9 9 8 6</p>  <p>( 0 1 ) 0 0 0 0 0 0 0 0 0 0 0 0 0 0</p>
Input	<p>GS1 barcodes consist of 1 or multiple codes that start with so-called Application Identifiers (AI) - 2 digit codes that indicate a specific goal. For example: AI 11 indicates a production date, AI 17 an expiration date, AI 10 a batch or lot number, etc. The Application Identifiers require specific input, for example AI 11 and AI 17 are fixed and require 6 digits, AI 10 is variable and can contain up to 20 alphanumeric characters.</p> <p>If multiple AIs are allowed, they can be entered in multiple ways:</p> <ul style="list-style-type: none"> <li>• Just enter the codes one after the other, without any spaces. In this case you should enter fixed size Application Identifiers (AI) first, and AI with a variable length last to allow a correct validation of the barcode.</li> <li>• Put the AI between brackets. In that case it is clear where one code ends and another one begins, so variable AIs can be put at the start if so desired.</li> <li>• At the end of an AI, type "[F1]" before entering the next AI</li> <li>• For an even higher readability: use Shift-Enter to start a new AI at the next line</li> </ul>
Check Digit	depending on Application Identifier

### Barcode Parameters

#### Narrow Bar

This parameter determines the width of the narrowest bar of your barcode (and affects the width of your barcode proportionally).

Changing this parameter will adjust the **Character Frequency**.

#### Bar Width Reduction.

Use this to adjust the width of barcode bars, in order to compensate for ink bleeding when printing on your substrate.

**Tip:** You can enter a negative value if you want to print thicker and not thinner bars.

#### Device Compensation

Use this if your printer gave you a separate device bleed value. This parameter adjusts the bar's width to compensate for bleed caused by the plate or film making process.

**Note:** If you use both a Bar Width Reduction and a Device Compensation value, the **Barcode Inspector** will add them to adjust the bar's width.

**Tip:** You can enter a negative value if you want to print thicker and not thinner bars.

**Snap Bars to Output Resolution and Output resolution**

Use this to adjust specific barcode parameters (**Bar Width Reduction, Device Compensation, Magnification and Font Size**) so that the bars' width take up a complete number of pixels or dots.

Enable **Snap Bars to Output Resolution** and enter the resolution you will use to print your barcode in ppi. Everytime a value is adjusted because of this option, a warning will be shown.

By entering "0" in the input field, you can reset the Output Resolution to its default value (2540 ppi).

**Barcode Text Parameters**

**Add human readable text**

This option defines if the barcode's code should be visible as normal text. By default this option is enabled.

**Position text above barcode**

This option places the text above the barcode instead of below.

**Wrap text**

This option allows to put the text on multiple lines, one line per AI.

**Font Family, Font Style and Size**

By default the digits are vectorized from the standard OCR-B font. You can use real text by selecting a font family. You can also define the style and size.

By entering "0" in the Size input field, you can reset the text size to the default value for the selected barcode type.

**Offset**

Use this parameter to apply a vertical offset to the text of the barcode. A positive value moves the text down, a negative value moves the text up.

**Alignment**

Using the buttons, you can set the alignment of the text to left, centered or right.

**GS1 DataMatrix**

Info	The GS1 DataMatrix barcode is a high density, high capacity, scalable 2D barcode. It is used to concentrate a lot of (alphanumeric) information in a very small space.
------	--

Example	 <p>(01)12345678901231          (11)123456          (17)987654</p>
Input	<p>GS1 barcodes consist of 1 or multiple codes that start with so-called Application Identifiers (AI) - 2 digit codes that indicate a specific goal. For example: AI 11 indicates a production date, AI 17 an expiration date, AI 10 a batch or lot number, etc. The Application Identifiers require specific input, for example AI 11 and AI 17 are fixed and require 6 digits, AI 10 is variable and can contain up to 20 alphanumeric characters.</p> <p>If multiple AIs are allowed, they can be entered in multiple ways:</p> <ul style="list-style-type: none"> <li>• Just enter the codes one after the other, without any spaces. In this case you should enter fixed size Application Identifiers (AI) first, and AI with a variable length last to allow a correct validation of the barcode.</li> <li>• Put the AI between brackets. In that case it is clear where one code ends and another one begins, so variable AIs can be put at the start if so desired.</li> <li>• At the end of an AI, type "[F1]" before entering the next AI</li> <li>• For an even higher readability: use Shift-Enter to start a new AI at the next line</li> </ul>
Check Digit	depending on Application Identifier

**Barcode Parameters**

**Symbol Size**

The amount of Cells in a barcode. The Symbol Size will automatically increase when entering too much data for the current symbol size.

**Cell Size**

The size of a single black or white square.

**Bar Width Reduction.**

Use this to adjust the width of barcode bars, in order to compensate for ink bleeding when printing on your substrate.

**Tip:** You can enter a negative value if you want to print thicker and not thinner bars.

**Device Compensation**

Use this if your printer gave you a separate device bleed value. This parameter adjusts the bar's width to compensate for bleed caused by the plate or film making process.

**Note:** If you use both a Bar Width Reduction and a Device Compensation value, the **Barcode Inspector** will add them to adjust the bar's width.

**Tip:** You can enter a negative value if you want to print thicker and not thinner bars.

**Add Box**

Use this parameter to create an opaque white box under your barcode.

Use the **Top**, **Bottom**, **Left** and **Right** fields to add a white margin around your barcode and make the box bigger. You can enter a different margin for the top, left, right and bottom, or by enabling the **Lock**

button  you can set one margin for all 4 sides.

**Barcode Text Parameters**

**Add human readable text**

This option defines if the barcode's code should be visible as normal text. By default this option is enabled.

**Position text above barcode**

This option places the text above the barcode instead of below.

**Wrap text**

This option allows to put the text on multiple lines, one line per AI.

**Font Family, Font Style and Size**

By default the digits are vectorized from the standard OCR-B font. You can use real text by selecting a font family. You can also define the style and size.

By entering "0" in the Size input field, you can reset the text size to the default value for the selected barcode type.

**Offset**

Use this parameter to apply a vertical offset to the text of the barcode. A positive value moves the text down, a negative value moves the text up.

**Alignment**

Using the buttons, you can set the alignment of the text to left, centered or right.

**HIBC 39**

Info	<p>This barcode is based on the Code 39 symbology.</p> <p>It encodes the organization's primary and / or secondary Labeler Identification Code (LIC). This encoding begins with the "+" character. If both primary and secondary Labeler Identification Codes are encoded in one barcode, they are divided by the "/" character.</p>
Example	
Input	Minimum 7 digits, with a leading "+"
Check Digit	Last character is the Check Digit.



## Barcode Parameters

### Narrow Bar

This parameter determines the width of the narrowest bar of your barcode (and affects the width of your barcode proportionally).

Changing this parameter will adjust the **Character Frequency**.

### Narrow Bar Ratio

This parameter determines the ratio between the width of the widest bar and the width of the narrowest bar of your barcode. It does not affect the width of your barcode proportionally.

Changing this parameter will adjust the **Narrow Bar** parameter.

### Character Frequency

This parameter determines the amount of character per millimeter or per inch, depending on the setting in the Preferences (and affects the width of your barcode proportionally).

Changing this parameter will adjust the **Narrow Bar** parameter. It is only available when using the default font.

### Height

The height you enter is the combined height of the bars and the human readable characters. Your barcode needs to be tall enough to be read easily by barcode scanners.

### Bar Width Reduction.

Use this to adjust the width of barcode bars, in order to compensate for ink bleeding when printing on your substrate.

**Tip:** You can enter a negative value if you want to print thicker and not thinner bars.

### Device Compensation

Use this if your printer gave you a separate device bleed value. This parameter adjusts the bar's width to compensate for bleed caused by the plate or film making process.

**Note:** If you use both a Bar Width Reduction and a Device Compensation value, the **Barcode Inspector** will add them to adjust the bar's width.

**Tip:** You can enter a negative value if you want to print thicker and not thinner bars.

### Add Box

Use this parameter to create an opaque white box under your barcode.

Use the **Top**, **Bottom**, **Left** and **Right** fields to add a white margin around your barcode and make the box bigger. You can enter a different margin for the top, left, right and bottom, or by enabling the **Lock**

button  you can set one margin for all 4 sides.

## Barcode Text Parameters

### Add human readable text

This option defines if the barcode's code should be visible as normal text. By default this option is enabled.

### Font Family, Font Style and Size

By default the digits are vectorized from the standard OCR-B font. You can use real text by selecting a font family. You can also define the style and size.

By entering "0" in the Size input field, you can reset the text size to the default value for the selected barcode type.

**Offset**

Use this parameter to apply a vertical offset to the text of the barcode. A positive value moves the text down, a negative value moves the text up.

**Alignment**

Using the buttons, you can set the alignment of the text to left, centered or right.

**HIBC 128**

Info	<p>This barcode is based on the Code 128 symbology.</p> <p>It encodes the organization's primary and / or secondary Labeler Identification Code (LIC). This encoding begins with the "+" character. If both primary and secondary Labeler Identification Codes are encoded in one barcode, they are divided by the "/" character.</p>
Example	 <p>* + 1 2 3 4 5 6 8 9 0 / 1 5 6 2 *</p>
Input	<p>Minimum 7 digits, with a leading "+"</p>
Check Digit	<p>Last character is the Check Digit.</p>

**Barcode Parameters**

**Narrow Bar**

This parameter determines the width of the narrowest bar of your barcode (and affects the width of your barcode proportionally).

Changing this parameter will adjust the **Character Frequency**.

**Character Frequency**

This parameter determines the amount of character per millimeter or per inch, depending on the setting in the Preferences (and affects the width of your barcode proportionally).

Changing this parameter will adjust the **Narrow Bar** parameter. It is only available when using the default font.

**Height**

The height you enter is the combined height of the bars and the human readable characters. Your barcode needs to be tall enough to be read easily by barcode scanners.

**Bar Width Reduction.**

Use this to adjust the width of barcode bars, in order to compensate for ink bleeding when printing on your substrate.

**Tip:** You can enter a negative value if you want to print thicker and not thinner bars.

**Device Compensation**

Use this if your printer gave you a separate device bleed value. This parameter adjusts the bar's width to compensate for bleed caused by the plate or film making process.

**Note:** If you use both a Bar Width Reduction and a Device Compensation value, the **Barcode Inspector** will add them to adjust the bar's width.

**Tip:** You can enter a negative value if you want to print thicker and not thinner bars.

**Add Box**

Use this parameter to create an opaque white box under your barcode.

Use the **Top**, **Bottom**, **Left** and **Right** fields to add a white margin around your barcode and make the box bigger. You can enter a different margin for the top, left, right and bottom, or by enabling the **Lock**

button  you can set one margin for all 4 sides.

**Barcode Text Parameters**

**Add human readable text**

This option defines if the barcode's code should be visible as normal text. By default this option is enabled.

**Font Family, Font Style and Size**

By default the digits are vectorized from the standard OCR-B font. You can use real text by selecting a font family. You can also define the style and size.

By entering "0" in the Size input field, you can reset the text size to the default value for the selected barcode type.

**Offset**

Use this parameter to apply a vertical offset to the text of the barcode. A positive value moves the text down, a negative value moves the text up.

**Alignment**

Using the buttons, you can set the alignment of the text to left, centered or right.

**Interleaved 2 of 5**

Info	Interleaved 2 of 5 (or Int. 2 of 5) is a barcode originally used for transportation packaging, that can have any even number of digits. Since this type of packaging consists mainly of cardboard boxes printed in low quality, the Interleaved 2 of 5 barcode is more tolerant to distortion than other barcodes.
------	--

Example	
Input	unlimited amount of digits
Check Digit	None

### Barcode Parameters

#### Narrow Bar

This parameter determines the width of the narrowest bar of your barcode (and affects the width of your barcode proportionally).

Changing this parameter will adjust the **Character Frequency**.

#### Narrow Bar Ratio

This parameter determines the ratio between the width of the widest bar and the width of the narrowest bar of your barcode. It does not affect the width of your barcode proportionally.

Changing this parameter will adjust the **Narrow Bar** parameter.

#### Character Frequency

This parameter determines the amount of character per millimeter or per inch, depending on the setting in the Preferences (and affects the width of your barcode proportionally).

Changing this parameter will adjust the **Narrow Bar** parameter. It is only available when using the default font.

#### Height

The height you enter is the combined height of the bars and the human readable characters. Your barcode needs to be tall enough to be read easily by barcode scanners.

#### Bar Width Reduction.

Use this to adjust the width of barcode bars, in order to compensate for ink bleeding when printing on your substrate.

**Tip:** You can enter a negative value if you want to print thicker and not thinner bars.

#### Device Compensation

Use this if your printer gave you a separate device bleed value. This parameter adjusts the bar's width to compensate for bleed caused by the plate or film making process.

**Note:** If you use both a Bar Width Reduction and a Device Compensation value, the **Barcode Inspector** will add them to adjust the bar's width.

**Tip:** You can enter a negative value if you want to print thicker and not thinner bars.

#### Add Box

Use this parameter to create an opaque white box under your barcode.

Use the **Top**, **Bottom**, **Left** and **Right** fields to add a white margin around your barcode and make the box bigger. You can enter a different margin for the top, left, right and bottom, or by enabling the **Lock**

button  you can set one margin for all 4 sides.

### Barcode Text Parameters

#### Add human readable text

This option defines if the barcode's code should be visible as normal text. By default this option is enabled.

#### Font Family, Font Style and Size

By default the digits are vectorized from the standard OCR-B font. You can use real text by selecting a font family. You can also define the style and size.

By entering "0" in the Size input field, you can reset the text size to the default value for the selected barcode type.

#### Offset

Use this parameter to apply a vertical offset to the text of the barcode. A positive value moves the text down, a negative value moves the text up.

#### Alignment

Using the buttons, you can set the alignment of the text to left, centered or right.

### ITF-14

Info	ITF-14 is a standardized version of the Interleaved 2 of 5 barcode, containing 14 digits, the last being a check digit.
Example	
Input	The input for an ITF-14 code is 14 digits.
Check Digit	The 14th digit is a check digit.

### Barcode Parameters

#### Magnification

Use this parameter to increase or decrease the width of the barcode. Changing the Magnification will also change the Font Size and Vertical Offset.

By entering "0" in the input field, you can reset the Magnification to its default value (100%).



**Attention:** Changing the **Magnification** does not change the **Height** of the barcode. You can however reset the Height by entering "0". The Height will be proportionally scaled to the current Magnification.

#### Height

The height you enter is the combined height of the bars and the human readable characters. Your barcode needs to be tall enough to be read easily by barcode scanners.

**Bar Width Reduction.**

Use this to adjust the width of barcode bars, in order to compensate for ink bleeding when printing on your substrate.

**Tip:** You can enter a negative value if you want to print thicker and not thinner bars.

**Device Compensation**

Use this if your printer gave you a separate device bleed value. This parameter adjusts the bar's width to compensate for bleed caused by the plate or film making process.

**Note:** If you use both a Bar Width Reduction and a Device Compensation value, the **Barcode Inspector** will add them to adjust the bar's width.

**Tip:** You can enter a negative value if you want to print thicker and not thinner bars.

**Snap Bars to Output Resolution and Output resolution**

Use this to adjust specific barcode parameters (**Bar Width Reduction, Device Compensation, Magnification** and **Font Size**) so that the bars' width take up a complete number of pixels or dots.

Enable **Snap Bars to Output Resolution** and enter the resolution you will use to print your barcode in ppi. Everytime a value is adjusted because of this option, a warning will be shown.

By entering "0" in the input field, you can reset the Output Resolution to its default value (2540 ppi).

**Add Printable Gauges**

Use this option to add the printability gauges ("H" marks) either side of your barcode. Use the Smax and Smin parameters to define the size. Smax defines the width of the left "H", Smin defines the width of the right "H".

**Add Bearer Bars**

Use this option to add bearer bars to your barcode

- Set the **Width** of the bearer bars
- Define the **Placement**: either Top and bottom, or all sides
- Use the **Top, Bottom, Left** and **Right** fields to add a white margin between your barcode and the bearer bars. You can enter a different margin for the top, left, right and bottom, or by enabling the

**Lock** button  you can set one margin for all 4 sides.

**Barcode Text Parameters**

**Add human readable text**

This option defines if the barcode's code should be visible as normal text. By default this option is enabled.

**Font Family, Font Style and Size**

By default the digits are vectorized from the standard OCR-B font. You can use real text by selecting a font family. You can also define the style and size.

By entering "0" in the Size input field, you can reset the text size to the default value for the selected barcode type.

**Offset**

Use this parameter to apply a vertical offset to the text of the barcode. A positive value moves the text down, a negative value moves the text up.

**Alignment**

Using the buttons, you can set the alignment of the text to left, centered or right.

**ITF-16**

Info	ITF-16 is a standardized version of the Interleaved 2 of 5 barcode, containing 16 digits, the last being a check digit.
Example	
Input	The input for an ITF-16 code is 16 digits.
Check Digit	The 16th digit is a check digit.

**Barcode Parameters**

**Magnification**

Use this parameter to increase or decrease the width of the barcode. Changing the Magnification will also change the Font Size and Vertical Offset.

By entering "0" in the input field, you can reset the Magnification to its default value (100%).



**Attention:** Changing the **Magnification** does not change the **Height** of the barcode. You can however reset the Height by entering "0". The Height will be proportionally scaled to the current Magnification.

**Height**

The height you enter is the combined height of the bars and the human readable characters. Your barcode needs to be tall enough to be read easily by barcode scanners.

**Bar Width Reduction.**

Use this to adjust the width of barcode bars, in order to compensate for ink bleeding when printing on your substrate.

**Tip:** You can enter a negative value if you want to print thicker and not thinner bars.

**Device Compensation**

Use this if your printer gave you a separate device bleed value. This parameter adjusts the bar's width to compensate for bleed caused by the plate or film making process.

**Note:** If you use both a Bar Width Reduction and a Device Compensation value, the **Barcode Inspector** will add them to adjust the bar's width.

**Tip:** You can enter a negative value if you want to print thicker and not thinner bars.

**Snap Bars to Output Resolution and Output resolution**

Use this to adjust specific barcode parameters (**Bar Width Reduction, Device Compensation, Magnification** and **Font Size**) so that the bars' width take up a complete number of pixels or dots.

Enable **Snap Bars to Output Resolution** and enter the resolution you will use to print your barcode in ppi. Everytime a value is adjusted because of this option, a warning will be shown.

By entering "0" in the input field, you can reset the Output Resolution to its default value (2540 ppi).

**Add Printable Gauges**

Use this option to add the printability gauges ("H" marks) either side of your barcode. Use the Smax and Smin parameters to define the size. Smax defines the width of the left "H", Smin defines the width of the right "H".

**Add Bearer Bars**

Use this option to add bearer bars to your barcode

- Set the **Width** of the bearer bars
- Define the **Placement**: either Top and bottom, or all sides
- Use the **Top, Bottom, Left** and **Right** fields to add a white margin between your barcode and the bearer bars. You can enter a different margin for the top, left, right and bottom, or by enabling the

**Lock** button  you can set one margin for all 4 sides.

**Barcode Text Parameters**

**Add human readable text**

This option defines if the barcode's code should be visible as normal text. By default this option is enabled.

**Font Family, Font Style and Size**

By default the digits are vectorized from the standard OCR-B font. You can use real text by selecting a font family. You can also define the style and size.

By entering "0" in the Size input field, you can reset the text size to the default value for the selected barcode type.

**Offset**

Use this parameter to apply a vertical offset to the text of the barcode. A positive value moves the text down, a negative value moves the text up.

**Alignment**

Using the buttons, you can set the alignment of the text to left, centered or right.

**Klebrand**

Info	Klebrand is a glue strip code mostly used in the German packaging industry. It can contain bars with 4 different widths
Example	



Input	<p>binary input: quaternary values (digits 0 to 3).</p> <p>Decimal Input: digits (0 to 9) and /. The digits before the slash indicate the number of bars (maximum 15), the digits behind the slash define the binary value of the code. If only the digits behind the slash are entered, the minimum amount of bars required to represent that value will be used.</p>
Check Digit	None

**Barcode Parameters**

**Narrow Bar**

This parameter determines the width of the narrowest bar of your barcode (and affects the width of your barcode proportionally).

Changing this parameter will adjust the **Character Frequency**.

**Height**

The height you enter is the combined height of the bars and the human readable characters. Your barcode needs to be tall enough to be read easily by barcode scanners.

**Bar Width Reduction.**

Use this to adjust the width of barcode bars, in order to compensate for ink bleeding when printing on your substrate.

**Tip:** You can enter a negative value if you want to print thicker and not thinner bars.

**Device Compensation**

Use this if your printer gave you a separate device bleed value. This parameter adjusts the bar's width to compensate for bleed caused by the plate or film making process.

**Note:** If you use both a Bar Width Reduction and a Device Compensation value, the **Barcode Inspector** will add them to adjust the bar's width.

**Tip:** You can enter a negative value if you want to print thicker and not thinner bars.

**Add Box**

Use this parameter to create an opaque white box under your barcode.

Use the **Top**, **Bottom**, **Left** and **Right** fields to add a white margin around your barcode and make the box bigger. You can enter a different margin for the top, left, right and bottom, or by enabling the **Lock**

button  you can set one margin for all 4 sides.

**Barcode Text Parameters**

**Add human readable text**

This option defines if the barcode's code should be visible as normal text. By default this option is disabled.

**Font Family, Font Style and Size**

By default the digits are vectorized from the standard OCR-B font. You can use real text by selecting a font family. You can also define the style and size.

By entering "0" in the Size input field, you can reset the text size to the default value for the selected barcode type.

**Offset**

Use this parameter to apply a vertical offset to the text of the barcode. A positive value moves the text down, a negative value moves the text up.

**Alignment**

Using the buttons, you can set the alignment of the text to left, centered or right.

**Micro QR**

Info	The Micro QR Code is a very small QR Code for use on smaller spaces (for example to encode the ID of printed circuit boards and electronics parts).  It works with smaller amounts of data (maximum 35 numeric characters), and uses only one position pattern.
Example	
Input	35
Check Digit	None

**Barcode Parameters**

**Symbol Size**

The amount of Cells in a barcode. The Symbol Size will automatically increase when entering too much data for the current symbol size.

**Error Correction**

Error correction adds check sums to the barcode to detect and correct incorrect data. You can choose one of the following Error correction levels:

- Level L: 7% of codewords can be restored.
- Level M: 15% of codewords can be restored.
- Level Q: 25% of codewords can be restored.
- Level H: 30% of codewords can be restored. (Not available for Micro QR)

**Note:** Keep in mind that a higher correction level makes the barcode bigger (as more check sums are added to the barcode) and may limit the maximum length of the encoded data.

**Cell Size**

The size of a single black or white square.

**Bar Width Reduction.**

Use this to adjust the width of barcode bars, in order to compensate for ink bleeding when printing on your substrate.

**Tip:** You can enter a negative value if you want to print thicker and not thinner bars.

**Device Compensation**

Use this if your printer gave you a separate device bleed value. This parameter adjusts the bar's width to compensate for bleed caused by the plate or film making process.

**Note:** If you use both a Bar Width Reduction and a Device Compensation value, the **Barcode Inspector** will add them to adjust the bar's width.

**Tip:** You can enter a negative value if you want to print thicker and not thinner bars.

**Add Box**

Use this parameter to create an opaque white box under your barcode.

Use the **Top**, **Bottom**, **Left** and **Right** fields to add a white margin around your barcode and make the box bigger. You can enter a different margin for the top, left, right and bottom, or by enabling the **Lock**

button  you can set one margin for all 4 sides.

**PZN**

Info	The PZN (Pharma-Zentral-Nummer) barcode is used for distribution of pharmaceutical and healthcare products in Germany. The PZN code is written in the format "PZN-nnnnnnn" but only the numeric part including the leading dash is encoded.
Example	 <p style="text-align: center;">PZN-12345678</p>
Input	7 or 8 digits
Check Digit	The 8th digit is a check digit.

**Barcode Parameters**

**Narrow Bar**

This parameter determines the width of the narrowest bar of your barcode (and affects the width of your barcode proportionally).

Changing this parameter will adjust the **Character Frequency**.

**Narrow Bar Ratio**

This parameter determines the ratio between the width of the widest bar and the width of the narrowest bar of your barcode. It does not affect the width of your barcode proportionally.

Changing this parameter will adjust the **Narrow Bar** parameter.

**Character Frequency**

This parameter determines the amount of character per millimeter or per inch, depending on the setting in the Preferences (and affects the width of your barcode proportionally).

Changing this parameter will adjust the **Narrow Bar** parameter. It is only available when using the default font.

**Height**

The height you enter is the combined height of the bars and the human readable characters. Your barcode needs to be tall enough to be read easily by barcode scanners.

**Bar Width Reduction.**

Use this to adjust the width of barcode bars, in order to compensate for ink bleeding when printing on your substrate.

**Tip:** You can enter a negative value if you want to print thicker and not thinner bars.

**Device Compensation**

Use this if your printer gave you a separate device bleed value. This parameter adjusts the bar's width to compensate for bleed caused by the plate or film making process.

**Note:** If you use both a Bar Width Reduction and a Device Compensation value, the **Barcode Inspector** will add them to adjust the bar's width.

**Tip:** You can enter a negative value if you want to print thicker and not thinner bars.

**Add Box**

Use this parameter to create an opaque white box under your barcode.

Use the **Top**, **Bottom**, **Left** and **Right** fields to add a white margin around your barcode and make the box bigger. You can enter a different margin for the top, left, right and bottom, or by enabling the **Lock**

button  you can set one margin for all 4 sides.

**Barcode Text Parameters**

**Add human readable text**

This option defines if the barcode's code should be visible as normal text. By default this option is enabled.

**Font Family, Font Style and Size**

By default the digits are vectorized from the standard OCR-B font. You can use real text by selecting a font family. You can also define the style and size.

By entering "0" in the Size input field, you can reset the text size to the default value for the selected barcode type.

**Offset**

Use this parameter to apply a vertical offset to the text of the barcode. A positive value moves the text down, a negative value moves the text up.

**Alignment**

Using the buttons, you can set the alignment of the text to left, centered or right.

QR

Info	<p>The QR barcode is a 2-dimensional barcode used for commercial tracking and convenience-oriented applications aimed at mobile phone users (known as "mobile tagging").</p> <p>QR codes storing addresses and URLs may appear in magazines, on signs, buses, business cards, or other objects... Users with a camera phone equipped with the correct reader application can scan the QR code to display text, contact information, connect to a wireless network, or open a web page in the phone's browser.</p>
Example	
Input	Unlimited
Check Digit	None

**Barcode Parameters**

**Symbol Size**

The amount of Cells in a barcode. The Symbol Size will automatically increase when entering too much data for the current symbol size.

**Error Correction**

Error correction adds check sums to the barcode to detect and correct incorrect data. You can choose one of the following Error correction levels:

- Level L: 7% of codewords can be restored.
- Level M: 15% of codewords can be restored.
- Level Q: 25% of codewords can be restored.
- Level H: 30% of codewords can be restored. (Not available for Micro QR)

**Note:** Keep in mind that a higher correction level makes the barcode bigger (as more check sums are added to the barcode) and may limit the maximum length of the encoded data.

**Cell Size**

The size of a single black or white square.

**Bar Width Reduction.**

Use this to adjust the width of barcode bars, in order to compensate for ink bleeding when printing on your substrate.

**Tip:** You can enter a negative value if you want to print thicker and not thinner bars.

**Device Compensation**

Use this if your printer gave you a separate device bleed value. This parameter adjusts the bar's width to compensate for bleed caused by the plate or film making process.

**Note:** If you use both a Bar Width Reduction and a Device Compensation value, the **Barcode Inspector** will add them to adjust the bar's width.

**Tip:** You can enter a negative value if you want to print thicker and not thinner bars.

**Add Box**

Use this parameter to create an opaque white box under your barcode.

Use the **Top**, **Bottom**, **Left** and **Right** fields to add a white margin around your barcode and make the box bigger. You can enter a different margin for the top, left, right and bottom, or by enabling the **Lock**

button  you can set one margin for all 4 sides.

**SICK**

Info	SICK is a bar code used in the German packaging industry. It is a binary code consisting of 2 types of bars, a thin one and a thick one. It can contain 3 to 12 bars.
Example	
Input	Binary input: maximum 12 binary values (0 and 1). Decimal Input: Digits (0 to 9) and a slash. Before the slash is the number of bars (maximum 12), behind the slash is the binary value (maximum 4096). If only the digits behind the slash are keyed in, it will create the minimum amount of bars required to represent that value.
Check Digit	None

**Barcode Parameters**

**Narrow Bar, Narrow Bar Ratio, Wide Bar, Gap**

The **Narrow Bar**, **Narrow Bar Ratio**, **Wide Bar** and **Gap** values define the width of the narrow bars, wide bars, gaps in between the bars and the ratio. Changing the width of the narrow or wide bar will affect the Narrow Bar Ratio value.

**Height**

The height you enter is the combined height of the bars and the human readable characters. Your barcode needs to be tall enough to be read easily by barcode scanners.

**Bar Width Reduction.**

Use this to adjust the width of barcode bars, in order to compensate for ink bleeding when printing on your substrate.

**Tip:** You can enter a negative value if you want to print thicker and not thinner bars.

**Device Compensation**

Use this if your printer gave you a separate device bleed value. This parameter adjusts the bar's width to compensate for bleed caused by the plate or film making process.

**Note:** If you use both a Bar Width Reduction and a Device Compensation value, the **Barcode Inspector** will add them to adjust the bar's width.

**Tip:** You can enter a negative value if you want to print thicker and not thinner bars.

**Add Box**

Use this parameter to create an opaque white box under your barcode.

Use the **Top**, **Bottom**, **Left** and **Right** fields to add a white margin around your barcode and make the box bigger. You can enter a different margin for the top, left, right and bottom, or by enabling the **Lock**

button  you can set one margin for all 4 sides.

**Barcode Text Parameters**

**Add human readable text**

This option defines if the barcode's code should be visible as normal text. By default this option is disabled.

**Font Family, Font Style and Size**

By default the digits are vectorized from the standard OCR-B font. You can use real text by selecting a font family. You can also define the style and size.

By entering "0" in the Size input field, you can reset the text size to the default value for the selected barcode type.

**Offset**

Use this parameter to apply a vertical offset to the text of the barcode. A positive value moves the text down, a negative value moves the text up.

**Alignment**

Using the buttons, you can set the alignment of the text to left, centered or right.

**UPC-A**

Info	Universal Product Code or UPC is the standard for article numbering in the U.S.A. and Canada. It is similar to the EAN system and compatible with it. For more information on EAN, see <a href="#">EAN-13</a> on page 195.
Example	
Input	The input for an UPC-A code is 12 digits starting with a zero, with optionally 2 or 5 supplemental digits, if set in the <b>Code Type</b> dialog.
Check Digit	The 12th digit is a check digit.

## Barcode Parameters

### Magnification

Use this parameter to increase or decrease the width of the barcode. Changing the Magnification will also change the Font Size and Vertical Offset.

By entering "0" in the input field, you can reset the Magnification to its default value (100%).



**Attention:** Changing the **Magnification** does not change the **Height** of the barcode. You can however reset the Height by entering "0". The Height will be proportionally scaled to the current Magnification.

### Height

The height you enter is the combined height of the bars and the human readable characters. Your barcode needs to be tall enough to be read easily by barcode scanners.

### Add light margin indicator

Use this option to add light margin indicators before (" $<$ ") and/or after (" $>$ ") the barcode number

**Note:** The light margin indicators are only available when using 5 additional digits.

### Bar Width Reduction.

Use this to adjust the width of barcode bars, in order to compensate for ink bleeding when printing on your substrate.

**Tip:** You can enter a negative value if you want to print thicker and not thinner bars.

### Device Compensation

Use this if your printer gave you a separate device bleed value. This parameter adjusts the bar's width to compensate for bleed caused by the plate or film making process.

**Note:** If you use both a Bar Width Reduction and a Device Compensation value, the **Barcode Inspector** will add them to adjust the bar's width.

**Tip:** You can enter a negative value if you want to print thicker and not thinner bars.

### Snap Bars to Output Resolution and Output resolution

Use this to adjust specific barcode parameters (**Bar Width Reduction**, **Device Compensation**, **Magnification** and **Font Size**) so that the bars' width take up a complete number of pixels or dots.

Enable **Snap Bars to Output Resolution** and enter the resolution you will use to print your barcode in ppi. Everytime a value is adjusted because of this option, a warning will be shown.

By entering "0" in the input field, you can reset the Output Resolution to its default value (2540 ppi).

### Add Box

Use this parameter to create an opaque white box under your barcode.

Use the **Top**, **Bottom**, **Left** and **Right** fields to add a white margin around your barcode and make the box bigger. You can enter a different margin for the top, left, right and bottom, or by enabling the **Lock**

button  you can set one margin for all 4 sides.



### Barcode Text Parameters

#### Add human readable text

This option defines if the barcode's code should be visible as normal text. By default this option is enabled.

#### Font Family, Font Style and Size

By default the digits are vectorized from the standard OCR-B font. You can use real text by selecting a font family. You can also define the style and size.

By entering "0" in the Size input field, you can reset the text size to the default value for the selected barcode type.

#### Offset

Use this parameter to apply a vertical offset to the text of the barcode. A positive value moves the text down, a negative value moves the text up.

### UPC-E

Info	<p>Universal Product Code or UPC is the standard for article numbering in the U.S.A. and Canada. It is similar to the EAN system and compatible with it. For more information on EAN, see <a href="#">EAN-13</a> on page 195.</p> <p>UPC-E is an abbreviated version of UPC-A, for use on smaller packages.</p>
Example	
Input	<p>The input for an UPC-E code is 8 digits, starting with a zero. You can also enter a 12 digit code, if it can be compressed into an 8 digit code. Optionally 2 or 5 supplemental digits, if set in the <b>Code Type</b> dialog.</p>
Check Digit	<p>The 8th digit is a check digit.</p>

### Barcode Parameters

#### Magnification

Use this parameter to increase or decrease the width of the barcode. Changing the Magnification will also change the Font Size and Vertical Offset.

By entering "0" in the input field, you can reset the Magnification to its default value (100%).



**Attention:** Changing the **Magnification** does not change the **Height** of the barcode. You can however reset the Height by entering "0". The Height will be proportionally scaled to the current Magnification.

#### Height

The height you enter is the combined height of the bars and the human readable characters. Your barcode needs to be tall enough to be read easily by barcode scanners.

#### Bar Width Reduction.

Use this to adjust the width of barcode bars, in order to compensate for ink bleeding when printing on your substrate.

**Tip:** You can enter a negative value if you want to print thicker and not thinner bars.

**Device Compensation**

Use this if your printer gave you a separate device bleed value. This parameter adjusts the bar's width to compensate for bleed caused by the plate or film making process.

**Note:** If you use both a Bar Width Reduction and a Device Compensation value, the **Barcode Inspector** will add them to adjust the bar's width.

**Tip:** You can enter a negative value if you want to print thicker and not thinner bars.

**Snap Bars to Output Resolution and Output resolution**

Use this to adjust specific barcode parameters (**Bar Width Reduction, Device Compensation, Magnification and Font Size**) so that the bars' width take up a complete number of pixels or dots.

Enable **Snap Bars to Output Resolution** and enter the resolution you will use to print your barcode in ppi. Everytime a value is adjusted because of this option, a warning will be shown.

By entering "0" in the input field, you can reset the Output Resolution to its default value (2540 ppi).

**Add Box**

Use this parameter to create an opaque white box under your barcode.

Use the **Top, Bottom, Left and Right** fields to add a white margin around your barcode and make the box bigger. You can enter a different margin for the top, left, right and bottom, or by enabling the **Lock**

button  you can set one margin for all 4 sides.

**Barcode Text Parameters**

**Add human readable text**

This option defines if the barcode's code should be visible as normal text. By default this option is enabled.

**Font Family, Font Style and Size**

By default the digits are vectorized from the standard OCR-B font. You can use real text by selecting a font family. You can also define the style and size.

By entering "0" in the Size input field, you can reset the text size to the default value for the selected barcode type.

**Offset**

Use this parameter to apply a vertical offset to the text of the barcode. A positive value moves the text down, a negative value moves the text up.

**Bobst**

Info	The Bobst barcode is part of the same "binary" barcode family as the Laetus Pharma Code, Kurandt and CLF-8. It is used in the pharmaceutical industry.
------	--

Example	
Input	The input for a Bobst code can be maximum 32 digits for binary input (maximum 8589934590 in decimal input). However, an input of maximum 16 binary digits (decimal input of 131072) is preferred.
Check Digit	None

**Important:** Although ArtPro also supports Bobst barcodes, the Bobst barcodes in ArtPro files will not be recognized in ArtPro+ and will show up as (compound) paths, as for other unsupported barcodes, to preserve the visual appearance of these barcodes.

### Barcode Parameters

**Note:** Bobst barcodes have fixed values for Narrow Bar, Narrow Bar Ratio, Wide Bar and Gap.

#### Height

The height you enter is the combined height of the bars and the human readable characters. Your barcode needs to be tall enough to be read easily by barcode scanners.

#### Bar Width Reduction.

Use this to adjust the width of barcode bars, in order to compensate for ink bleeding when printing on your substrate.

**Tip:** You can enter a negative value if you want to print thicker and not thinner bars.

#### Device Compensation

Use this if your printer gave you a separate device bleed value. This parameter adjusts the bar's width to compensate for bleed caused by the plate or film making process.

**Note:** If you use both a Bar Width Reduction and a Device Compensation value, the **Barcode Inspector** will add them to adjust the bar's width.

**Tip:** You can enter a negative value if you want to print thicker and not thinner bars.

#### Add Box

Use this parameter to create an opaque white box under your barcode.

Use the **Top**, **Bottom**, **Left** and **Right** fields to add a white margin around your barcode and make the box bigger. You can enter a different margin for the top, left, right and bottom, or by enabling the **Lock**

button  you can set one margin for all 4 sides.

### Barcode Text Parameters

#### Add human readable text

This option defines if the barcode's code should be visible as normal text. By default this option is disabled.

#### Font Family, Font Style and Size

By default the digits are vectorized from the standard OCR-B font. You can use real text by selecting a font family. You can also define the style and size.

By entering "0" in the Size input field, you can reset the text size to the default value for the selected barcode type.

**Offset**

Use this parameter to apply a vertical offset to the text of the barcode. A positive value moves the text down, a negative value moves the text up.

**Alignment**

Using the buttons, you can set the alignment of the text to left, centered or right.

**Multicolor**

This barcode can be colorized using the Multicolor fill option. See [Multicolor barcodes](#) on page 232

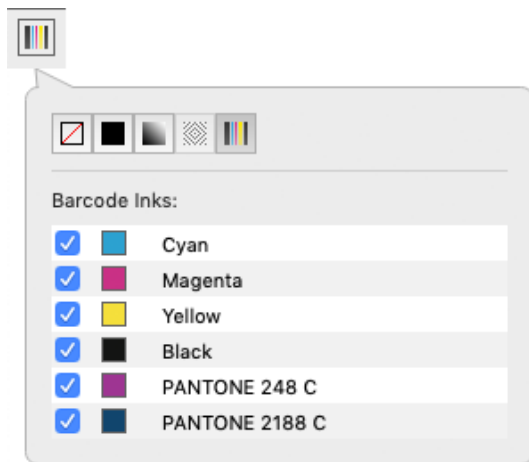

**Kurandt**

Info	The Kurandt barcode is part of the same "binary" barcode family as the Laetus Pharma Code, Bobst and CLF-8. It is used in the pharmaceutical industry.
Example	
Input	The input for a Kurandt code can be maximum 32 digits for binary input (maximum 8589934590 in decimal input). However, an input of maximum 16 binary digits (decimal input of 131072) is preferred.
Check Digit	None

**Barcode Parameters**

**Note:** Kurandt barcodes have fixed values for Narrow Bar, Narrow Bar Ratio, Wide Bar and Gap.

### Height

The height you enter is the combined height of the bars and the human readable characters. Your barcode needs to be tall enough to be read easily by barcode scanners.

### Bar Width Reduction.

Use this to adjust the width of barcode bars, in order to compensate for ink bleeding when printing on your substrate.

**Tip:** You can enter a negative value if you want to print thicker and not thinner bars.

### Device Compensation

Use this if your printer gave you a separate device bleed value. This parameter adjusts the bar's width to compensate for bleed caused by the plate or film making process.

**Note:** If you use both a Bar Width Reduction and a Device Compensation value, the **Barcode Inspector** will add them to adjust the bar's width.

**Tip:** You can enter a negative value if you want to print thicker and not thinner bars.

### Add Box

Use this parameter to create an opaque white box under your barcode.

Use the **Top**, **Bottom**, **Left** and **Right** fields to add a white margin around your barcode and make the box bigger. You can enter a different margin for the top, left, right and bottom, or by enabling the **Lock**

button  you can set one margin for all 4 sides.

## Barcode Text Parameters

### Add human readable text

This option defines if the barcode's code should be visible as normal text. By default this option is disabled.

### Font Family, Font Style and Size

By default the digits are vectorized from the standard OCR-B font. You can use real text by selecting a font family. You can also define the style and size.

By entering "0" in the Size input field, you can reset the text size to the default value for the selected barcode type.

### Offset

Use this parameter to apply a vertical offset to the text of the barcode. A positive value moves the text down, a negative value moves the text up.

### Alignment

Using the buttons, you can set the alignment of the text to left, centered or right.

### Multicolor

This barcode can be colorized using the Multicolor fill option. See [Multicolor barcodes](#) on page 232

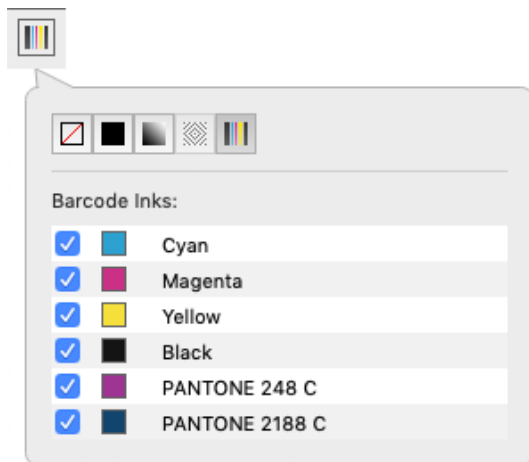

**Laetus Pharma**

Info	<p>The Laetus Pharma Code is part of the same barcode family as the Kurandt, Bobst and CLF-8 barcode. This barcode was developed specifically to meet the requirements of the pharmaceutical packaging process. It has established itself as the worldwide pharmaceutical industry barcode standard. It can encode numeric or binary data.</p> <p>In the <b>Code Type</b> dialog you can choose between the normal or the miniature version of the barcode.</p>
Example	
Input	<p>The input for a Laetus code can be maximum 32 digits for binary input (maximum 8589934590 in decimal input). However, an input of maximum 16 binary digits (decimal input of 131072) is preferred.</p>
Check Digit	<p>None</p>

**Barcode Parameters**

**Narrow Bar, Narrow Bar Ratio, Wide Bar, Gap**

The **Narrow Bar**, **Narrow Bar Ratio**, **Wide Bar** and **Gap** values define the width of the narrow bars, wide bars, gaps in between the bars and the ratio. Changing the width of the narrow or wide bar will affect the Narrow Bar Ratio value.

**Height**

The height you enter is the combined height of the bars and the human readable characters. Your barcode needs to be tall enough to be read easily by barcode scanners.

**Bar Width Reduction.**

Use this to adjust the width of barcode bars, in order to compensate for ink bleeding when printing on your substrate.

**Tip:** You can enter a negative value if you want to print thicker and not thinner bars.

**Device Compensation**

Use this if your printer gave you a separate device bleed value. This parameter adjusts the bar's width to compensate for bleed caused by the plate or film making process.

**Note:** If you use both a Bar Width Reduction and a Device Compensation value, the **Barcode Inspector** will add them to adjust the bar's width.

**Tip:** You can enter a negative value if you want to print thicker and not thinner bars.

**Add Box**

Use this parameter to create an opaque white box under your barcode.

Use the **Top**, **Bottom**, **Left** and **Right** fields to add a white margin around your barcode and make the box bigger. You can enter a different margin for the top, left, right and bottom, or by enabling the **Lock**

button  you can set one margin for all 4 sides.

**Barcode Text Parameters**

**Add human readable text**

This option defines if the barcode's code should be visible as normal text. By default this option is disabled.

**Font Family, Font Style and Size**

By default the digits are vectorized from the standard OCR-B font. You can use real text by selecting a font family. You can also define the style and size.

By entering "0" in the Size input field, you can reset the text size to the default value for the selected barcode type.

**Offset**

Use this parameter to apply a vertical offset to the text of the barcode. A positive value moves the text down, a negative value moves the text up.

**Alignment**

Using the buttons, you can set the alignment of the text to left, centered or right.

**Multicolor**

This barcode can be colorized using the Multicolor fill option. See [Multicolor barcodes](#) on page 232

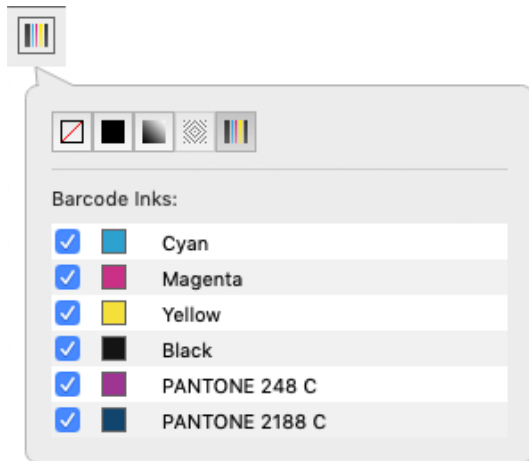

### 9.1.4. Multicolor barcodes

A Code 128, Laetus Pharma, Bobst or Kurandt barcode can be colorized using the Multicolor fill option.

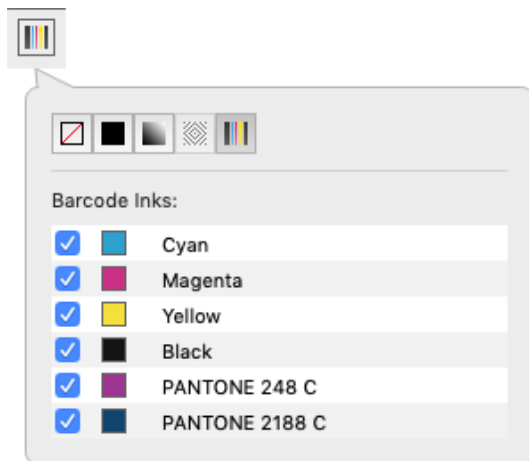

This special Fill mode allows to create a multicolor barcode.





The outer bars will be filled using the darkest separation, all bars in between are filled with the selected separations.

By default, only Artwork separations will be enabled. Unused separations, Processing Step colors (PDF +) and Varnishes and Technical Inks (Normalized PDF) are by default not selected when choosing the Multicolor Barcode.

**Note:** The color of a multicolor barcode is not dynamic, if you e.g. add a separation, it will not be added automatically. You can adjust the multicolor fill by enabling the separation in the Inspector, or you can switch back to flat color and back to multicolor to reset the setting. If you remap or remove a separation the barcode will be updated. The barcode will also be updated when saving the PDF.

Multicolor barcodes are not supported in a Normalized PDF opened in PackEdge or DeskPack. As soon as the barcode is updated, the barcode will become flat colored.

### 9.1.5. Barcode properties from Automation Engine Job Setup

Using the **Get Properties from Job Setup** button, you can link the parameters for the selected barcode type to the parameters as defined in the Automation Engine Job Setup.

This can only work for files that are in an Automation Engine Job.

A type of barcode which has properties specified on the Job Setup will be indicated by a green or red Automation Engine icon in front of the type.

#### A barcode using the Job Setup properties

If all parameters are according to what is specified in the Job Setup, the Barcode Type inspector

will show a green Automation Engine icon  in front of the Type. The indication "Using Job Setup Properties" is shown at the bottom. Also, every barcode parameter that is defined in the Job Setup is indicated by the same green icon, and these parameters can't be changed. Parameters not defined in the Job Setup can be modified freely in the document.

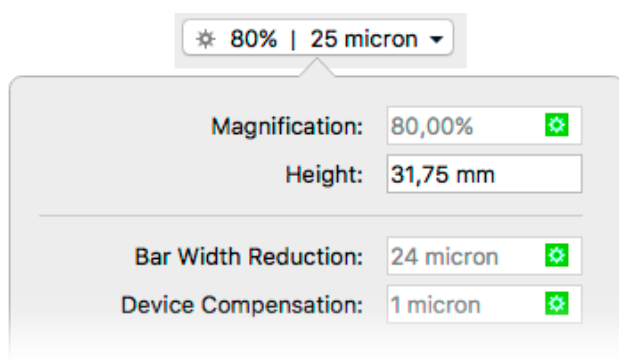

#### Mismatched Barcode

A barcode using one or more parameters not matching the parameters defined in the Job Setup, e.g.

if the parameters have been modified in the AE Job Setup, will show a red icon , and the Messages side drawer will show a "Mismatched Barcode" error.

Click the **Get Properties from Job Setup** button to link the barcode type to the parameters of the Job Setup.

The icon will become green and all parameters will be changed according to the settings in the Job Setup.

### Missing Barcode

If a barcode type is specified on the Job Setup but is not present in the document, a "Missing barcode" error message will appear in the Messages side drawer. If you create a new barcode, ArtPro+ will automatically create a new barcode of the missing type, using the parameters as defined in the Job Setup.

If multiple barcode types are missing, creating new barcodes will create these missing types in the order as they were entered in Automation Engine Pilot.

**Note:** Changing the type of an existing barcode to a barcode type with defined parameters will automatically use the Job Setup parameters and get a green icon.

## 9.1.6. Convert to Barcode

**Note:** The availability of this functionality depends on your license of ArtPro+. See [Licensing](#) on page 25

**Convert to Barcode** is a function to convert vectorized (contourized) barcodes (e.g. from non Esko applications) or images of barcodes to live editable barcodes.

1. Select the outlined barcode or image of the barcode that you want to convert

**Note:**

It is recommended to select only the image or barcode outlines of one single barcode, since all objects in the selection will be removed and replaced by the barcode during conversion.

2. Choose **Prepress > Convert to Barcode** or use its shortcut **Cmd+Alt+Shift+B** (Mac) or **Ctrl+Alt+Shift+B** (Windows)

The resulting Converted Barcode will be positioned in the center of the original selection.

3. Once the conversion is done, the object will be shown as a Converted Barcode, and you have different options.



- a) Click and hold **Hold to View Original** to hide the converted Barcode and see the original objects. You can toggle between the original objects and the converted barcode as long as you don't Accept or Revert.  
You can also use the **Quality Control Compare** function: as long as the converted barcode hasn't been accepted or rejected, you will see a **Original Barcode Outlines** option. See [Compare](#) on page 83.
- b) When needed, you can change the barcode type, code or properties in the corresponding Inspectors. See [Edit a barcode](#) on page 184
- c) When you're happy with the result, you can click the **Accept** button. This will remove the original objects from the document, leaving you with a regular barcode that you can edit as needed. You can also use the **Accept Converted Barcode** in the Barcode Inspector
- d) If you want to revert the converted barcode to the original objects, you can click **Revert**. You can also use the **Revert Converted Barcode to Original Data** button in the Barcode Inspector.

**Important:**

It is highly recommended to Accept (or Revert) the barcode conversion before closing the file to ensure smooth processing of the file further down the workflow.

To indicate that there are unaccepted Converted Barcodes in your document, a "Converted Barcodes" message will be shown in the Messages drawer. This will only disappear once all Converted Barcodes have been either accepted or reverted.

**Supported Barcode Types and known limitations**

The barcodes that are currently supported for Barcode Recognition are these:

- EAN-13 (with or without supplemental digits)
- EAN-8
- DataMatrix
- UPC-A (with or without supplemental digits)
- UPC-E (with or without supplemental digits)
- Int. 2 of 5
- ITF-16
- Code 39
- Code 128
- Code 128 (long)
- GS1 128
- GS1 DataMatrix
- QR

The barcode parameters that are currently recognized (when possible) are these:

- Barcode type
- Code
- Presence of supplemental digits
- Color
- Presence of Human Readable text
- Height (only for line art objects. For images, the default height is used)
- Rotation
- Magnification

- Bar Width Reduction (only when recognizing line art objects)
- Characters per unit
- Ratio

Other limitations:

- White Box, Light margin indicators, H gauges for ITF barcodes and HRI text parameters are not recognized.
- Device Compensation and Bar Width Reduction are both combined in the Bar Width Reduction
- An Int. 2 of 5 needs to have at least 6 digits.
- If the original is an image, rotation is deduced from the rotation of the image. If the barcode inside the image is rotated over an angle other than a multiple of 90°, the recognizing will not work.
- Clear Area box is not recognized. If it is included in the selection, it will be removed during conversion.
- For barcodes using custom text fonts, the font will be reset to the default OCR-B font.

## 9.2. Add Dimensions

---

Using **Add Dimensions** you can add the dimensions of the bounding box of the selected object(s), or of one of the page boxes.

1. Select the object(s) you want to add the dimensions to. If nothing is selected, the dimensions of the Trim Box will be added.
2. Select **Prepress > Add Dimensions** or use its shortcut **Cmd+Shift+L** (Mac) or **Ctrl+Shift+L** (Windows).

The Dimensions are created using the last used settings.

3. Use the **Dimensions Inspector** to change the Dimension lines. All changes are done immediately.

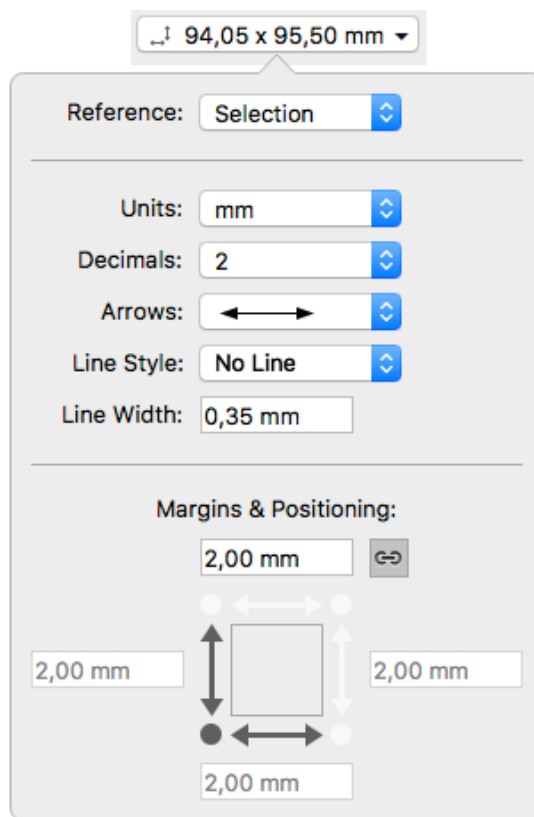

- a) The **Reference** is set to **Selection** if the dimensions were created on selected objects. You can change it to any of the defined Page Boxes.
  - b) Set the **Units** and number of **Decimals** for the dimensions.
  - c) Set the type of **Arrows** you want to use.
  - d) Using **Line Style** you can add a frame on the bounding box of the selection, or the selected Page Box, either dashed or a solid line. If you select "No Line", no frame will be added.
  - e) Set the **Line Width** for all dimension lines.
  - f) Select the corner you want to use as base for **Positioning** the dimensions. In the screenshot above the bottom left corner is selected, so the dimensions are placed on the left side and below the selection or page box.
  - g) Set the **Margins**. If the **Chain** option is selected, the same margin is used in all directions. Deselect it to enter a different margin for top, right, bottom or right.
4. To change the text properties of the dimension objects, you can use the **Text Inspector**, which will show a limited number of options: Font Family, Style and Size.
  5. Use the **Dimensions Grid Inspector** to set up columns and rows

2 x 3 ▾

	1	2			
Columns:	60,00 mm	66,57 mm	- +		
	1	2	3		
Rows:	30,00 mm	50,00 mm	90,55 mm	- +	

- a) Click the **+** button to add a new column or row. If an input field is selected, the new field is added in front of it, otherwise it's added before the last input field.
- b) Set the **Columns** width or **Rows** height by entering a distance in the different fields.

The last input field can't be changed. If the sum of the user input fields is lower than the total dimension, the last input field will contain the difference, so that the total sum equals the total dimension. If the sum of the user input fields is higher than the total dimension, the last input field will be zero, and the user input fields will be reduced to match the total dimension. In that case, a warning is shown.

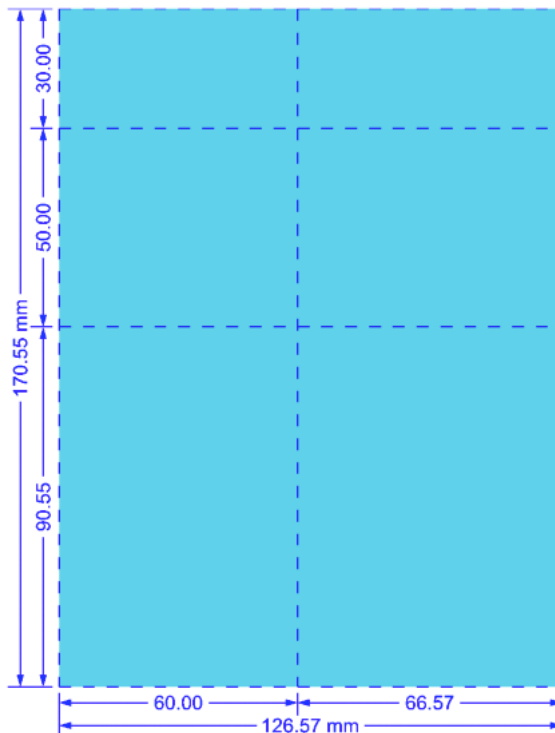

**Note:** The subdivision lines and dimensions use the settings from the **Dimensions Inspector**

Dimension lines are colored in a separation "Dimensions". In a Normalized PDF, the dimension objects are added to a layer "Dimensions". In a PDF+ file, the dimension objects are added to the Processing Step "Dimensions".

When you expand the dimension objects, or if you save and reopen the file, the dimension objects become regular objects in a Group.

## 9.3. Add Bleed

---

The **Add Bleed** function allows you to extend artwork beyond the cutting lines, to avoid white areas when cutting the printed material.

**Add Bleed** requires a Processing Step Layer "Cutting", and is only available for PDF+. See [PDF, PDF+ and Normalized PDF](#) on page 52 and [Processing Step Layers](#) on page 97

1. Select the object(s) you want to add bleed to.
2. Choose **Prepress > Add Bleed**.

The Add Bleed dialog is opened.

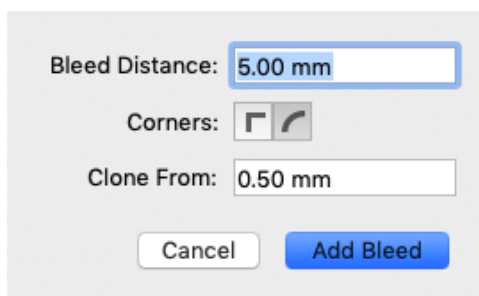

3. Set the **Bleed Distance** and the **Corners** (Round or Square)
4. Set the **Clone From** distance: the color of the newly created Add Bleed object will be based on pixels cloned from this distance inside the Cut line.
5. Click **Add Bleed**

The Add Bleed objects are created in a Layer named "Bleed", filled with an embedded image, filled with pixels cloned from inside the Cut line.



## 9.4. White Underprint

Using the **White Underprint** function you can add white underprinting objects based on the current selection.

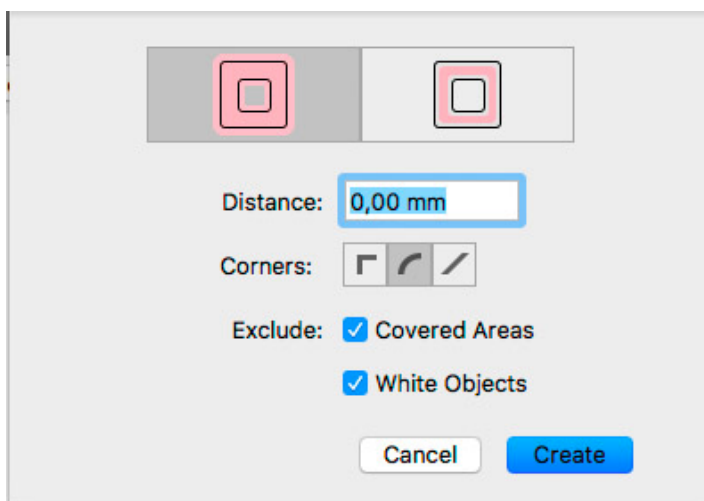

1. Select the objects you want to create white underprint objects for.
2. Choose **Prepress > White Underprint** or use the shortcut **Cmd+Shift+W** (Mac) or **Ctrl+Shift+W** (Windows).
3. Using the buttons, decide if you want the white underprint objects larger (Spread) or smaller (Choke) than the original objects
4. Enter the **Distance** to spread or choke
5. Set the **Corners**: straight, round or beveled



6. Enable **Exclude Covered Areas** to exclude areas in your selection that are covered by unselected objects.
7. Enable **Exclude White Objects** to exclude objects with a 0% fill and/or stroke.
8. Click **Create**. If your file already contains White Underprint objects, the button is changed to **Add**. Hold down the Alt key to **Subtract** from the white underprint, in order to create holes in the white underprint.

White Underprint objects are created in a new layer named "White Underprint". In PDF+, this will be a Processing Step layer 'White'.

White Underprint objects will be colored in a separation named "Opaque White". This (normal type) separation is added on top of the Separations list.

**Note:** Dynamic Marks are ignored when creating White Underprint objects.

## 9.5. Rich Black

**Note:** The availability of this functionality depends on your license of ArtPro+. See [Licensing](#) on page 25

Using **Rich Black** you can obtain a darker black, by adding other inks, for example 100% cyan.

1. Select the objects you want to add Rich Black objects to.
2. Select **Prepress > Rich Black...**

Enrich Separation:	Black	Minimum Density:	70%
With Color:	100	Cyan	
	0	Magenta	
	0	Yellow	
	0	Black	
Choke Distance:		0,00 mm	
Corners:		[Straight] [Rounded] [Beveled]	
<input type="checkbox"/> Only create Rich Black if no other separations are present			
Close		Create	

3. Select the **Enrich Separation**. By default, this will be the black separation or, if there is no black separation, the darkest separation in the job.
4. Define what color should be used to enrich, using the **With Color** section. By default this will be 100% cyan, when possible.
5. Enable **Only create Rich Black if no other separations are present** to exclude objects that contains other separations besides the Enrich Separation.
6. Set the **Minimum Density** to exclude objects that have a density lower than the set value for the Enrich Separation.
7. Enter the **Choke Distance** to make the Rich Black objects slightly smaller than the original objects.
8. Set the **Corners**: straight, round or beveled
9. Click **Create** to create the Rich Black objects.

The Rich Black objects are created in a separate **Rich Black** layer, using the defined color, in a Darken blend mode.

## 9.6. Ink Eater Areas

**Ink Eaters** help to achieve a constant ink consumption over the width of the plate. This makes it easier for press operators to set the **ink keys**, and results in a faster setup time for the press.

Ink Eaters are typically added to non-printed areas outside the printing job. These areas can be left-overs that will be cut off or the white spaces next to or even in between the one-ups.

Ink Eaters help to avoid excess ink build-up by stabilizing "peaks" and "lows" in the ink key **histogram**. This prevents spilling of excess ink onto the printed zones of the actual printing job. You can flatten the ink key histogram by filling non-printed zones with a gradient. A gradient helps to avoid hard edges in the compensation object.

You can use **Create Ink Eater Areas** to automatically create ink eater areas in grid or CAD based Step and Repeat files. See [Create Ink Eater Areas](#) on page 242.

After creating the Ink Eater Areas, you can use **Fill Ink Eater Areas** to fill the shapes as Ink Eater Areas. You can also use **Fill Ink Eater Areas** to fill manually created shapes as Ink Eater Areas. See [Fill Ink Eater Areas](#) on page 243

### 9.6.1. Create Ink Eater Areas

Using **Create Ink Eater Areas** you can automatically create ink eater areas in grid or CAD based Step and Repeat files. Afterwards you can use **Fill Ink Eater Areas** to fill these areas. See [Fill Ink Eater Areas](#) on page 243

1. Open the file you want to add Ink Eater Areas to. The file needs to be a Grid Step & Repeat file or a CAD based Step & Repeat file (MFG or CF2)
2. If you want to create Ink Eater areas based on existing objects, select these objects first.
3. Choose **Prepress > Ink Eater Areas > Create Ink Eater Areas**

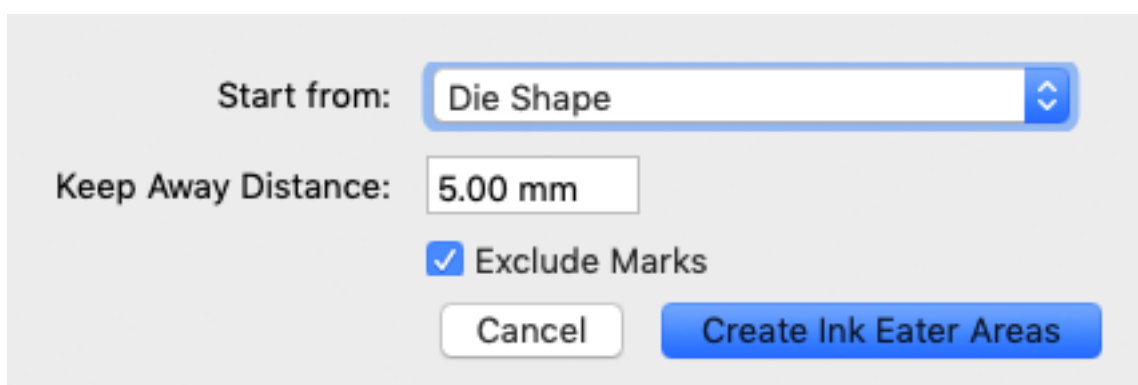

4. Define what you want to **Start from**: either the Die Shape, the Media Box of the station, or the Trim Box of the station.

5. Define the **Keep Away Distance**: the distance the Ink Eater Areas has to stay away from the Die Shape, Media Box or Trim Box of the station.

**Note:** The Keep Away Distance is calculated from the cutting line, not from the bleed line. If you have e.g. a bleed of 5 mm and a Keep Away Distance of 2mm, the Ink Eater Area will have a 3mm overlap on the bleed.

6. Define if you want to **Exclude Marks**. When enabled, the Ink Eater Areas will stay away from Marks using the same **Keep Away Distance**.
7. Click **Create Ink Eater Areas** or - if you had objects selected prior to opening the Create Ink Eater Areas dialog - click **Create Ink Eater Areas from Selection**

The Ink Eater Area shapes are now created, and can be filled using **Fill Ink Eater Areas**.

#### **Create Ink Eater Areas from Selection**

If you have a selection in your document, the menu item will change to **Prepress > Ink Eater Areas > Create Ink Eater Areas from selection**. In that case, the paths in the selection (except for Clipping Paths) will be used to define the ink eater areas. If none of the objects in the selection are suitable to define the ink eater areas, the Trim Box of the page will be used instead.

## **9.6.2. Fill Ink Eater Areas**

You can use **Fill Ink Eater Areas** to fill the shapes created by the **Create Ink Eater Areas** function. You can also use it to fill manually created shapes as Ink Eater Areas.

1. Create one or more shapes where you would like to define Ink Eater Areas.
2. Select the shapes and choose **Prepress > Ink Eater Areas > Fill Ink Eater Areas**



3. Set the **Scan Area** to Trim Box or Media Box. The Ink Eater Area will take everything inside the selected page box into account.
4. Set the **Direction** of the gradation to be created, either vertical or horizontal.
5. Define the number of **Gradation Stops**, ranging from very low (5 stops) to very high (60 steps).
6. Define the **Separations** you want compensated. By default, all artwork separations will be selected.
7. Set the **Density** to define the amount of compensation, either low, medium or high.
8. Set the **Falloff** to define the transition in the compensation, either steep, medium or soft.
9. Set the **Minimum Ink Density** for every separation in the Ink Eater Area.
10. You can enable the option to define a **Maximum Total Area Coverage** for the Ink Eater Area. When enabled, you can set the percentage.
11. Click **Fill Ink Eater Areas** to fill all selected objects with Ink Eater Area gradients.

**Note:** If you selected more than one object, the density of the gradients will be spread out over the selected areas.

## 9.7. Screening

In ArtPro+ you can set up object based screening. The document will contain a number of "Screen Sets" which are saved in the file. Each of the Screen Sets contains specific ruling, angle, dot shape and DGC information for each defined separation.



You can set up the Screen Sets in the **Screening** window. See [Setting up Screen Sets in the Screening window](#) on page 245

When an object is selected, you can see what Screen Set is applied in the **Screening Inspector**. See [Applying a Screen Set to an object](#) on page 246.

### 9.7.1. Setting up Screen Sets in the Screening window

In the **Screening** window, you can define a number of **Screen Sets**. Each Screen Set defines the ruling, angle, dot shape and DGC for each of the separations.

1. Open the **Screening** window.

- Click the **Screening** button 
- Choose **Prepress > Screening**
- Use the shortcut **Cmd+ALT+S** (Mac) or **Ctrl+ALT+S** (Windows)
- From within the **Screening Inspector**, click the **Manage Screen Sets** button 

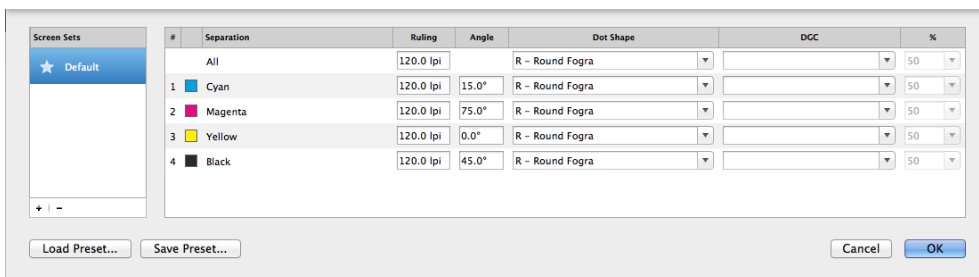

2. In the **Screen Sets** list on the left, click the **+** button to add a new Screen Set, or the **-** button to remove the selected Screen Set.

**Note:** If you create a new screen set, the currently selected screen set will be duplicated. If no screen set is available, a default screen set using a 120lpi ruling and offset angles is created.

3. Double-click the name of a Screen Set to rename it

4. Set the star in front of the Screen Set you want to use as **Default** Screen Set. The default is applied to all unscreened objects when saving Normalized PDF, and to Mask objects when an opacity mask is released.

**Note:** When opening a Normalized PDF, the most used Screen Set will be the default screen set, unless a default was defined already. When opening an ArtPro file, ArtPro+ will determine the default screen set based on the screen name. If that doesn't work, the first screen set will be used.

5. To edit one Screen Set, select it in the Screen Sets list, and change its settings on the right hand side:
  - a) Set the **Ruling** in lines per inch (lpi). You can enter the ruling in lines per centimeter by adding the unit "lpcm" to the value. It will be converted to lpi.
  - b) Set the **Angle** to be used for each separation.
  - c) Set the **Dot Shape**. The dropdown contains the most common Esko supported dot shapes, but you can manually enter the dot shape name as well. You can easily search a specific dot shape by typing the first letters.
  - d) Set a Dot Gain Curve **DGC** by selecting it from the dropdown, or by entering it manually. In case you select a PressSync curve, you can also define a percentage between 20 and 70%.
  - e) You can set the **Ruling, Dot Shape** and **DGC** for all separations at once by using the **All** row.
6. To save all defined Screen Sets in a Screen Preset, for example to be reused in other documents, click the **Save Preset...** button, and define the name for the Screen Preset.
7. To load the Screen Sets saved in a Screen Preset, click the **Load Presets...** button and select the Screen Preset to load. The Screen Sets in the Preset will be merged with the current Screen Presets: if a Screen Set with the exact same name and settings already exists, the Screen Set will not be created.

**Note:** Only Esko supported dot shapes are recognized. Other dot shapes will come in as "Standard PDF". In PDF+, if no dot shape is specified, this will also be shown as "Standard PDF" after saving and reopening the file.

### Screening from Automation Engine Server

If you are connected to an Automation Engine (so you see the green server status icon in the upper toolbar - see [Preferences](#) on page 44), the **Dot Shape** and **DGC** fields in the Screening dialog show the available values from the server.

If the server gets disconnected, the description of the selected dot shape is removed, but the code itself is retained.

For example "HD01 - HD Flexo C\_MCAII MC07P\_H - DuPont DFH - Flexible-HV" turns into "HD01" when disconnected from the server.

Saved server values of Dot Shape and DGC are kept in the document, even when reopening after disconnecting the server.

When there is no Automation Engine connection, or no Imaging Engine is attached to the Automation Engine, the default Dot Shape and DGC lists are offered.

You can still enter any value manually.

## 9.7.2. Applying a Screen Set to an object

You can see what Screen Set is applied in the **Screen Set Inspector**

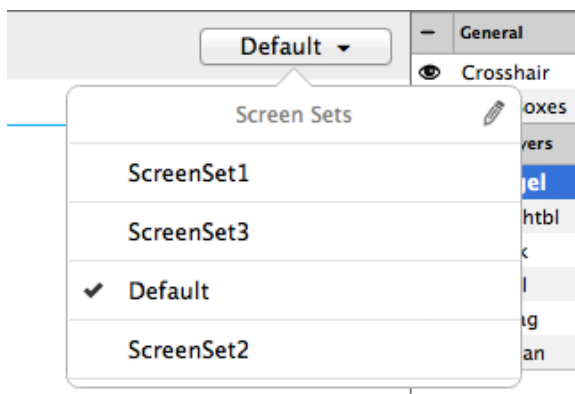

1. Select one or more objects.
2. Click the **Screen Set Inspector** at the right side of the Inspector bar.

The **Screen Set Inspector** will show what Screen Set is currently used, and lists all available Screen Sets.

3. Select a Screen Set to apply it to all selected objects.
- 4.

To edit the Screen Sets, click the **Manage Screen Sets** button . See [Setting up Screen Sets in the Screening window](#) on page 245

**Note:** If the selected objects use different Screen Sets, the Screen Set Inspector button will show "≠", and all Screen Sets used in the selection will have a checkmark.

### 9.7.3. Screening when merging separations

When merging separations in ArtPro+ 18 and earlier, the "source" screen settings (i.e. the screen settings for the separation that was merged) are lost, and the screen settings of the "destination" separation are used..

In ArtPro 18.0.1 and later, when merging a separation that creates a screening conflict, you'll get the choice to keep the source screening, or to use the destination screening (the screen settings of the separation you merge into).

A screening conflict occurs when all the following conditions are met:

- screening is applied on objects using the merged separation.
- the source and destination separation have different settings (ruling, angle, ...) within the same screen set.

If you decide to use the destination screening, the settings of the destination separation are used, and the settings of the source separation are lost.

If you decide to keep the source screening, the objects that used the conflicting screen set will have the settings of the source separation, but applied on the destination separation (the merged separation). If there is already a screen set with these exact settings, this screen set will be used, otherwise a new screen set is created.

Example:

Screen Set 1:

- Separation Ink1, ruling 120lpi, angle 75°
- Separation Ink2, ruling 120lpi, angle 75°

Screen Set 2:

- Separation Ink1, ruling 120lpi, angle 45°
- Separation Ink2, ruling 120lpi, angle 75°

When merging Ink1 onto Ink2, if all objects using the separation Ink1 use screen set 1, there is no conflict, since the settings for Ink1 and Ink2 are the same.

If there are objects using Screen Set 2, there is a conflict, since the settings for Ink1 and Ink2 are different.

If you choose to use the destination screening, these objects will still use Screen Set 2, and the settings of the destination separation Ink2 is used, i.e. an angle of 75°.

If you choose to keep the source screening, these objects will use a new screen set, where Ink2 uses the settings of Ink1, i.e. an angle of 45°.

**Note:** When using the **Recolor** function, you will not get this option. The destination screening is always used. See [Recolor](#) on page 150

## 9.8. Trapping

Using the Trapping tools, you can add traps.

There are two trapping modes: **Trapping** and **Reverse Trapping**.

**Trapping** will extend the lightest color into the darkest, to avoid white lines in case of misregistration. See [Trapping mode: Trapping](#) on page 248

**Reverse trapping** will generate white lines, to avoid colors touching or overlapping in case of misregistration. This is useful to prepare a job for Dry Offset printing (e.g. metal beverage cans) where overprinting of inks is not allowed as the inks would contaminate each other on the blanket. See [Trapping mode: Reverse Trapping](#) on page 257

### 9.8.1. Trapping mode: Trapping

Using **Automatic Trapping**, you can create a special **Automatic Trapping** layer. See [Automatic Trapping](#)

**Note:** Automatic Trapping is only available in ArtPro+ Advanced.

You can also manually create all Traps, using Manual Trapping. See [Manual Trapping](#) on page 251

The most important difference is that Manual Trapping takes into account all **visible** objects, while Automatic Trapping takes into account all objects in **printing layers**, even when hidden or on an invisible layer. Processing Steps are not taken into account.

**Important:** Expanding and manually editing an Automatic Trap layer (see [Edit and Expand Automatic Trap Layer](#) on page 251) is still a step in the Automatic Trapping workflow, and works on all objects in **printable layers**. Processing Steps are not taken into account.



## Automatic Trapping

**Note:** Automatic Trapping is only available in ArtPro+ Advanced.

This is a typical Automatic Trapping workflow when working on a PDF+ document:

1. Set up your document to be trapped.
2. Set the general trapping settings, and generate the dynamic **Automatic Trap Layer**. See [Starting Automatic Trapping](#) on page 249

A checkmark next to the Trapping button will indicate the Automatic Trap Layer is in sync



**Attention:** A file can not contain both an Automatic Trap Layer and a Reverse Trap Layer. Creating an Automatic Trap Layer will remove an earlier created Reverse Trap Layer.

3. Make any changes necessary
  - You can change the general trapping settings
  - You can add a **Trap Tag** to one or more objects, to overwrite the general trapping settings for those objects. See [Working with Trap Tags](#) on page 259

**Note:** You can also add Trap Tags before you start Automatic Trapping.

- You can still modify your document, e.g. remove, move or add objects

Any of these changes will result in the Trapping Layer to be **out of sync**. To continue, update the Trap Layer. See [Updating the Automatic Trap Layer](#) on page 251

4. Using Trap Tags and updating the Automatic Trap Layer you can finetune the trapping to your liking. However, if you prefer to manually tweak certain traps, you can do so by expanding the Automatic Trap Layer and manually edit the traps. See [Edit and Expand Automatic Trap Layer](#) on page 251.



**Warning:** If you expand the Automatic Trap layer, it is no longer a special "Automatic Trap" layer: you will no longer see if the trap layer is in sync, and won't be able to update it anymore.

When working on a Normalized PDF, you won't be able to use Trap Tags, and the Automatic Trapping settings are not saved in the document. This means you can only use Automatic Trapping within one session. After saving and reopening the file, you won't be able to change the Trap Settings or to update the Automatic Trap Layer.

### Starting Automatic Trapping

To start Automatic Trapping:

1. Open the document you want to trap
2. Open the Trapping dialog

•



Click the **Trapping** button, or

- Choose **Prepress > Trapping...**, or
- Use the shortcut **Cmd+Alt+T** (Mac) or **Ctrl+Alt+T** (Windows).

**Note:** If the document doesn't contain a Trap Layer yet, the "Update Trap Layer" shortcut **Cmd+T** (Mac) or **Ctrl+T** (Windows) will also open the Trapping dialog.

Set Trapping Mode to **Trapping** and select the **Automatic** tab.

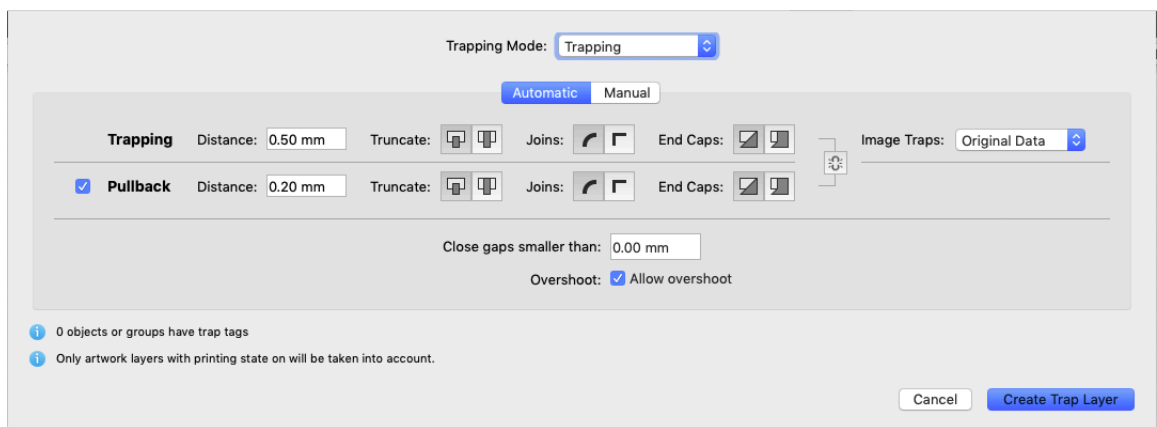

The Trapping dialog will indicate how many objects have a Trap Tag set. See [Working with Trap Tags](#) on page 259

3. Set the Trapping and Pullback Settings to be used. For more information on the Trapping / Pullback settings, see [Trapping / Pullback Settings](#) on page 253
4. Define the size of **Gaps** you want to automatically close.
5. If you want to allow Trap Overshoot, enable **Allow overshoot**. See also [Trap Overshoot](#) on page 256
6. Click **Create Trap Layer**

**Note:** If your document already contains an Automatic Trap Layer, the button will show **Update Trap Layer**. See [Updating the Automatic Trap Layer](#) on page 251

A new layer "Trap Layer 1" is created in the Layers list. Its type will be "Automatic Trap Layer", and it will contain all trapping objects.



**Attention:** A file can not contain both an Automatic Trap Layer and a Reverse Trap Layer. Creating an Automatic Trap Layer will remove an earlier created Reverse Trap Layer.

Automatic Trapping takes into account all objects in **printing layers**, even when hidden or on an invisible layer. As soon as you click the **Create Trap Layer** button, hidden objects will become visible, and hidden but printing layers will become visual.

Non-printing layers and Processing steps will not be taken into account.

## Updating the Automatic Trap Layer

Any change to the document or trap settings will result in the Trapping Layer being **out of sync**. Updating it will recalculate the Automatic Trap Layer.

There are different ways to update the Trap Layer:

- Choose **Prepress > Update Trap Layer**
- Use its shortcut **Cmd+T** (Mac) or **Ctrl+T** (Windows)
- Open the Trapping dialog and click **Update Trap Layer**



The Automatic Trap layer will be in sync again, indicated by a blue checkmark

## Edit and Expand Automatic Trap Layer

If Automatic Trapping in combination with Trap Tags still doesn't get you the result you want, you can expand the Automatic Trap Layer and manually edit the traps.



**Warning:** If you expand the Automatic Trap layer, it is no longer a special "Automatic Trap" layer: you will no longer see if the trap layer is in sync, and won't be able to update it anymore.

1. Open the Trapping dialog
  - Click the **Trapping** button, or
  - Choose **Prepress > Trapping...**, or
  - Use the shortcut **Cmd+Alt+T** (Mac) or **Ctrl+Alt+T** (Windows).
2. Select the **Manual** tab
3. Enable **Edit and Expand Automatic Trap Layer**
4. Click the **Enter Trapping Mode** button.

If the Automatic Trap Layer is out of sync, it will first be updated. See [Updating the Automatic Trap Layer](#) on page 251

The Automatic Trap Layer will become a regular layer, and you will enter **Trapping Mode** as when using Manual Trapping. You can use the Manual Trapping tools to modify or create traps. See [Manual Trapping](#) on page 251

**Important:** Expanding and manually editing an Automatic Trap layer is still a step in the Automatic Trapping workflow, and works on all objects in **printing layers**. Processing Steps are not taken into account.

## Manual Trapping

**Note:** The availability of this functionality depends on your license of ArtPro+. See [Licensing](#) on page 25

Using the Trapping tool, you can add traps. Manual trapping works on all **visible** objects.

1. Open the Trapping dialog:

•



Click the **Trapping** button, or

- Choose **Prepress > Trapping...**, or
- Use the shortcut **Cmd+Alt+T** (Mac) or **Ctrl+Alt+T** (Windows).

**2.** Select the **Manual** tab.

**3.** Select **Add a new layer**

**4.** Define the size of **Gaps** you want to automatically close, and click **Enter Trapping Mode**.

- All layers are grouped in one single layer named "Artwork"
- Functions not relevant for trapping will not be available. For example Page Boxes are hidden, Separations can be viewed but not edited, other tools except Densities and Dimensions are disabled, Compare in Quality Control is disabled, etc.

• The Trapping settings are shown at the bottom of the workspace. See [Trapping / Pullback Settings](#) on page 253

• If Trapping Suggestions is enabled, ArtPro+ will add traps as needed. See [Automatic Trapping](#)

**5.** While in Trapping mode, you have different tools available from the tool selector to create your traps.

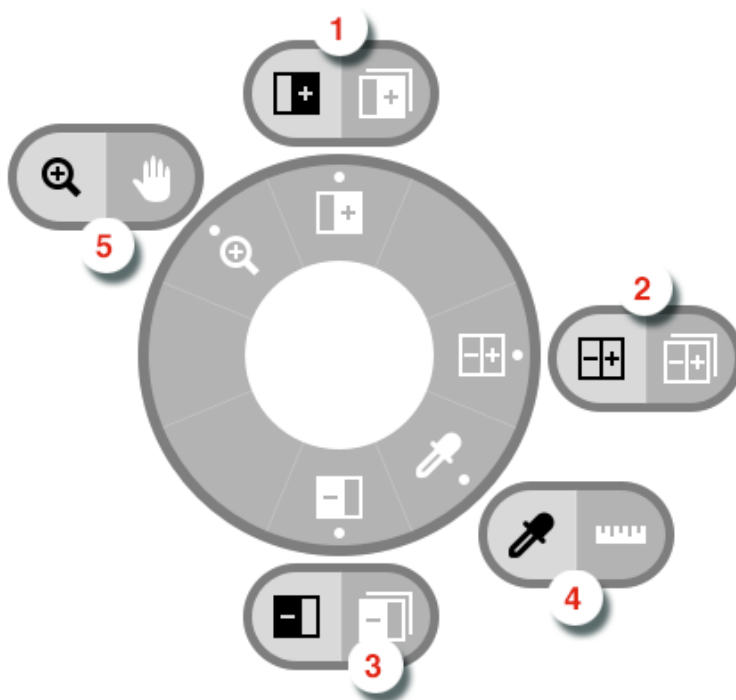

**1.** The **Trap** tool and **Trap Similar** tool, shortcut **T**. When switching to Trapping mode, the Trapping tool will be activated automatically. See [Trapping tool](#) on page 254

2. The **Trap + Pullback** and **Trap + Pullback Similar** tool, shortcut **B**. See [Trap and Pullback tool](#) on page 255
3. The **Pullback** and **Pullback Similar** tool, shortcut **B**. See [Pullback tool](#) on page 254
4. The regular **Densities** and **Dimensions** tool, shortcut **D**. See [Densities](#) on page 87 and [Dimensions](#) on page 86
5. The regular **Zoom** and **Pan** tool, shortcut **Z**. See [Zoom tool](#) on page 74 and [Pan tool](#) on page 74
6. If you are done creating traps, you can exit Trapping mode:

- 



click the **Trapping** button again

- click the **Leave Trapping Mode** button in the side panel
- use the shortcut **Cmd+T** (Mac) or **Ctrl+T** (Windows) to

Trap objects will use a **Darken** blend mode, and are placed in a layer "Trap Layer x"

### Trapping / Pullback Settings

When in Trapping mode, you can set the Trapping and/or Pullback settings at the bottom of the workspace.

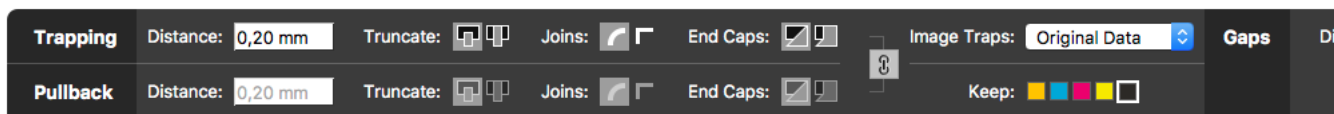

- **Distance:** the size for the trap. Enter a number to use the default unit, or add the unit and it will be converted to the default unit. See [Preferences](#) on page 44.
- **Truncate:** ArtPro+ can truncate the trap so that it doesn't stick out on another color. There are two truncation modes:
  - **On Edge (A):** when a portion of a trap comes too close to the contour of another object, it is truncated on the other object's edge.
  - **On Center (B):** when a portion of a trap comes too close to the contour of another object, ArtPro+ limits it to half the distance between the trapped object and the other object.

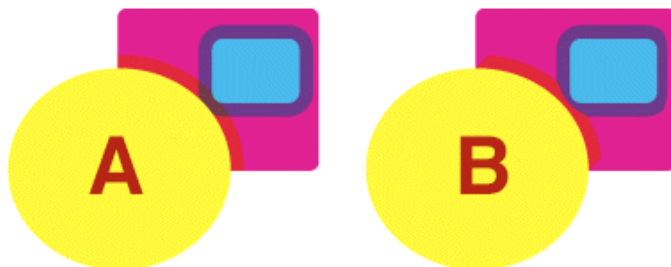

- **Joins:**

- A **Mitered** corner closes in one point. A Miter limit of 4 is used. This means the corner will be cut off at a distance of 4 times the trapping distance.
- A **Rounded** corner joins the corners with a circular arc with the diameter equal to the trapping width.
- **End Caps:** This option specifies how to shape the ends of an open trap.
  - **Square:** this option ends the trap at right angle to the adjoining object.
  - **Round :** this rounds the ends of the trap. This option is typically only used in combination with white knockout (reverse trapping).
- **Image Traps:** This option specifies how images are trapped.
  - **Original Data:** when spreading a (clipped) image, the underlying image data is used to create the trap. When there is no underlying image data, it will create an empty trap.
  - **Extend Data:** The image data along its clipping path is automatically extrapolated to ensure the trap looks as expected, even if there is no clipped image data outside the visible image.
- **Keep:** the color that will be kept (i.e. not pulled back) when applying a pullback. Hold Shift to select multiple colors.
- If the **Link** option is enabled, Trapping and Pullback parameters are kept the same.

### Trapping tool

The **Trap** tool allows to create traps from one object to another.

Using the **Trap Similar** tool applies the trap to the edge you selected, but also to all edges of the same color combination. You can temporarily switch to the Trap Similar tool by holding the Shift key.

The shortcut **T** will toggle between Trap and Trap Similar.

- Click and drag from one object to a neighbouring object to create a trap.
- Click and drag in the opposite direction to change the direction of a trap. You don't need to remove it first.
- After changing the Trapping Settings, you can click and drag over an existing trap again to apply the new settings.
- Hold the ALT key to remove a trap. The cursor will change to a cross. Click and drag over an existing trap to remove it.

### Pullback tool

The **Pullback** tool allows to create pullbacks. An ink pull back keeps away all but the darkest ink of a color area composed of multiple inks that borders to a very light background.

It prevents individual inks from the composed color to become visible on the background due to registration errors during the printing process. Ink pull backs are also known as "Cutbacks" or "Keepaways".

The example below shows an object with 100% dark blue and 50% magenta on an empty background (1). If misregistration occurs, a magenta line might be visible (2). 50% magenta is pulled back and a fine line of 100% dark blue remains (3). In this case, misregistration will not cause any magenta lines (4). The color that remains (dark blue) is the **Keep** ink.

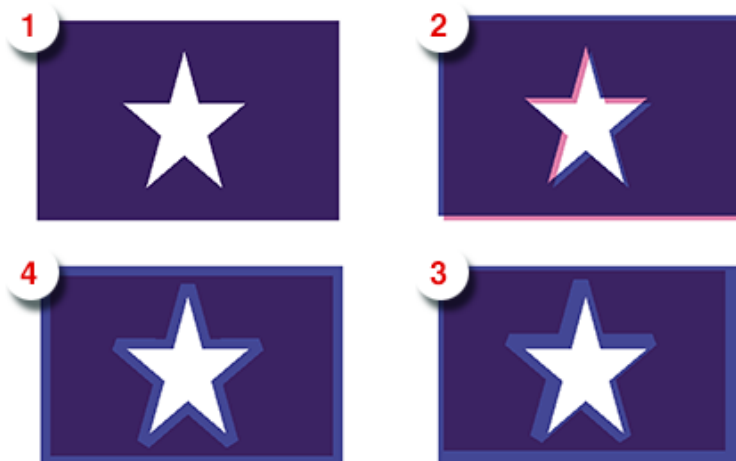

Using the **Pullback Similar** tool applies the pullback to the edge you selected, but also to all edges of the same color combination. You can temporarily switch to the Pullback Similar tool by holding the Shift key.

The shortcut **P** will toggle between Pullback and Pullback Similar.

- Set the **Keep** ink (i.e. the ink that is not pulled back) in the Pullback Settings by clicking the ink you want to keep. Shift-click to select more than one ink. You can also press **K** to open a separate Keep Color selector.
- Click and drag from one are to a neighbouring are to create a pullback. If a pullback is possible, the arrow you drag will have a solid line. Otherwise, it will be dashed.
- After changing the Pullback Settings, you can click and drag over an existing trap again to apply the new settings.
- Hold the ALT key to remove a pullback. The cursor will change to a cross. Click and drag over an existing pullback to remove it.

In case the "rich" color touches a colored background (e.g. yellow), it is advised to use **Trap and Pullback**. See [Trap and Pullback tool](#) on page 255

### Trap and Pullback tool

The **Trap and Pullback** tool allows to create pullbacks and a trap in the same pass.

A normal pullback keeps away all but the darkest ink of a color area composed of multiple inks. However, if this "rich" color borders another (light) color (1), the pullback will pull back the other colors (2). In case of misregistration of the dark blue, a white line might become visible (3). **Trap and Pullback** will pull back all inks except the Keep ink, and trap the light color in the pullback (4), so that no white lines can be seen in case of misregistration. (5)

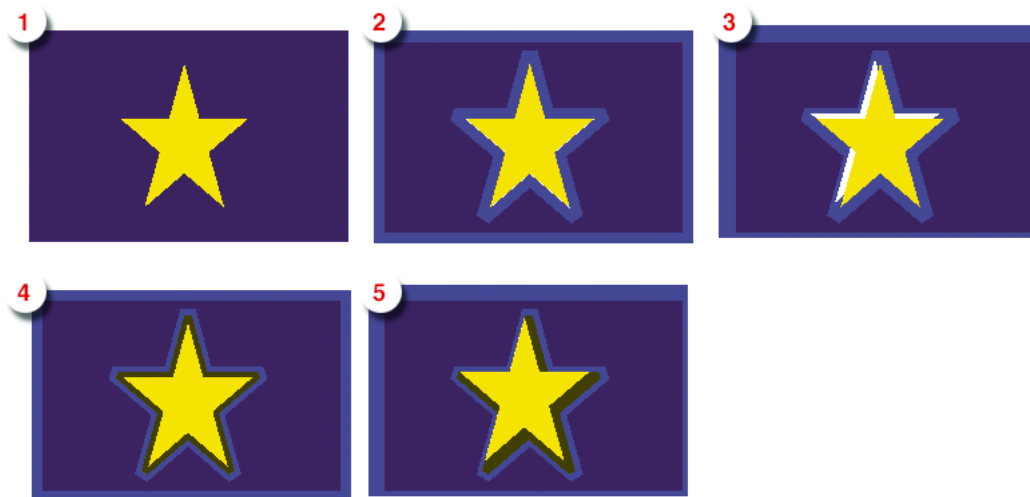

Using the **Trap and Pullback Similar** tool applies the trap and pullback to the edge you selected, but also to all edges of the same color combination. You can temporarily switch to the Trap and Pullback Similar tool by holding the Shift key.

The shortcut **B** will toggle between Pullback and Pullback Similar.

- Click and drag from one are to a neighbouring are to create a trap and pullback. If a trap and pullback is possible, the arrow you drag will have a solid line. Otherwise, it will be dashed.
- After changing the Trapping or Pullback Settings, you can click and drag over an existing trap and pullback again to apply the new settings.
- Hold the ALT key to remove a trap and pullback. The cursor will change to a cross. Click and drag over an existing trap and pullback to remove it.

**Trap Overshoot**

In ArtPro+ you can apply a manual overshoot: a trap that goes over 2 edges, going across a thin area of a different color.

Since it is not possible to drag a trap line across more than one edge (the trap line will be dashed, indicating the trap can not be applied), creating a trap overshoot will be done in different steps.

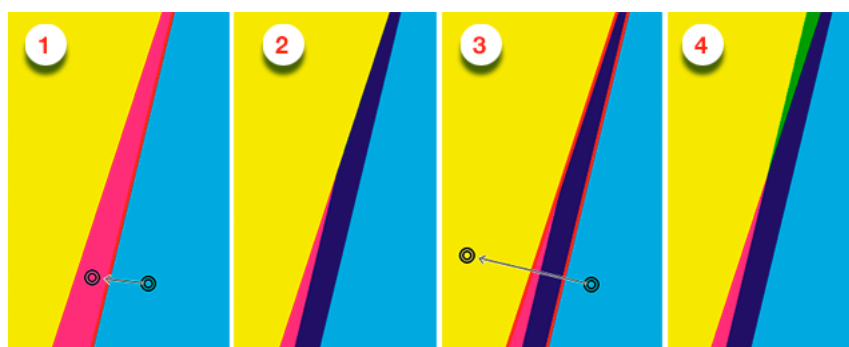

1. First create the trap between the two adjacent objects.
2. This is the resulting trap, set to clip "on edge"



3. Click and drag the trap line from the first to the third object, indicating the overshoot.
4. The overshoot is calculated, resulting in the cyan being trapped into the yellow and the magenta.

**Note:** You can only apply overshoot if the trap was added in the same trapping session.

## 9.8.2. Trapping mode: Reverse Trapping

**Note:** Reverse Trapping is only available in ArtPro+ Advanced.

This is a typical Reverse Trapping workflow when working on a PDF+ document:

1. Set up your document to be trapped.
2. Set the general trapping settings, and generate the dynamic **Reverse Trap Layer**. See [Starting Reverse Trapping](#) on page 257



A checkmark next to the Trapping button will indicate the Reverse Trap Layer is in sync



**Attention:** A file can not contain both an Automatic Trap Layer and a Reverse Trap Layer. Creating a Reverse Trap Layer will remove an earlier created Automatic Trap Layer.

3. Make any changes necessary
  - You can change the general Reverse trapping settings
  - You can add a **Trap Tag** to one or more objects, to overwrite the general trapping settings for those objects. See [Working with Trap Tags](#) on page 259

**Note:** You can also add Trap Tags before you start Reverse Trapping.

- You can still modify your document, e.g. remove, move or add objects

Any of these changes will result in the Trapping Layer to be **out of sync**. To continue, update the Trap Layer. See [Updating the Reverse Trap Layer](#) on page 259

When working on a Normalized PDF, you won't be able to use Trap Tags, and the Reverse Trap settings are not saved in the document. This means you can only use Reverse Trapping within one session. After saving and reopening the file, you won't be able to change the Reverse Trap Settings or to update the Reverse Trap Layer.

### Starting Reverse Trapping

To start Reverse Trapping:

1. Open the document you want to trap
2. Open the Trapping dialog

•

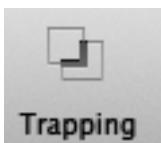

Click the **Trapping** button, or

- Choose **Prepress > Trapping...**, or

- Use the shortcut **Cmd+Alt+T** (Mac) or **Ctrl+Alt+T** (Windows).

**Note:** If the document doesn't contain a Trap Layer yet, the "Update Trap Layer" shortcut **Cmd+T** (Mac) or **Ctrl+T** (Windows) will also open the Trapping dialog.

Set Trapping Mode to **Reverse Trapping**

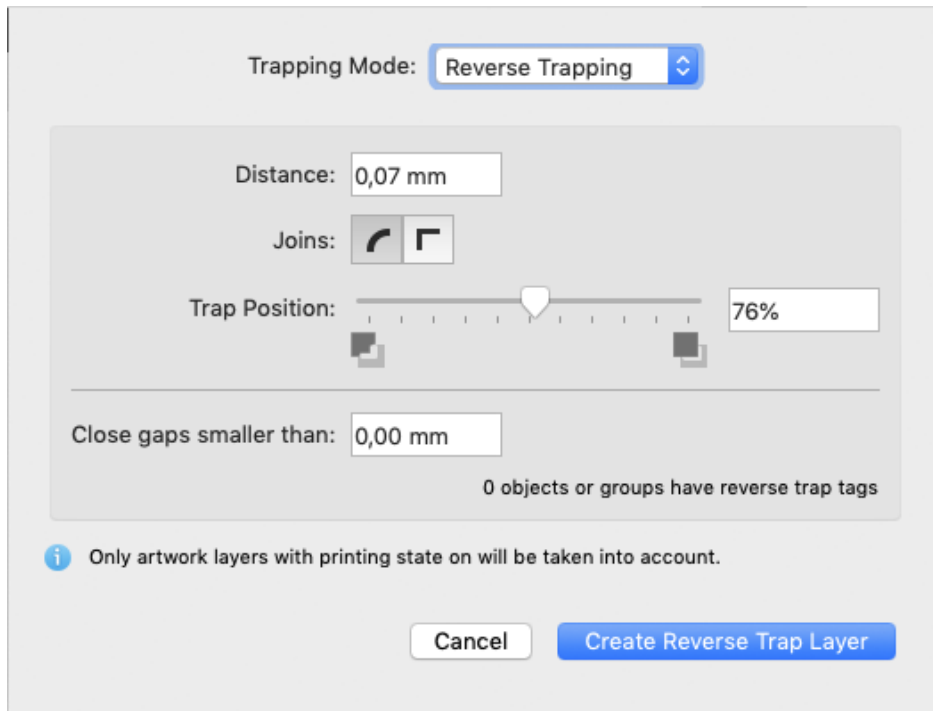

The Trapping dialog will indicate how many objects have a Trap Tag set. See [Working with Trap Tags](#) on page 259

3. Set the Trapping settings to be used.
  - a) **Distance:** the size for the trap. Enter a number to use the default unit, or add the unit and it will be converted to the default unit. See [Preferences](#) on page 44.
  - b) **Joins:** A **Mitered** corner closes in one point. A Miter limit of 4 is used. This means the corner will be cut off at a distance of 4 times the trapping distance. A **Rounded** corner joins the corners with a circular arc with the diameter equal to the trapping width.
  - c) **Trap Position:** You can use the slider or manually enter a value between 50 and 100. 100% will position the Reverse Trap object completely in the selected direction (in most cases into the lightest ink). 50% will place the trapping object 50% in both directions (i.e. centered on the edge)
4. Define the size of **Gaps** you want to automatically close, and click **Create Trap Layer**

**Note:** If your document already contains a Reverse Trap Layer, the button will show **Update Trap Layer**. See [Updating the Reverse Trap Layer](#) on page 259

A new layer "Reverse Trap Layer 1" is created in the Layers list. Its type will be "Automatic Trap Layer", and it will contain all trapping objects.



**Attention:** A file can not contain both an Automatic Trap Layer and a Reverse Trap Layer. Creating a Reverse Trap Layer will remove an earlier created Automatic Trap Layer.

Reverse Trapping takes into account all objects in **printing layers**, even when hidden or on an invisible layer. As soon as you click the **Create Reverse Trap Layer** button, hidden objects will become visible, and hidden but printing layers will become visual.

Non-printing layers and Processing steps will not be taken into account.

### Updating the Reverse Trap Layer

Any change to the document or trap settings will result in the Reverse Trap Layer being **out of sync**. Updating it will recalculate the Reverse Trap Layer.

There are different ways to update the Reverse Trap Layer:

- Choose **Prepress > Update Trap Layer**
- Use its shortcut **Cmd+T** (Mac) or **Ctrl+T** (Windows)
- Open the Trapping dialog and click **Update Reverse Trap Layer**

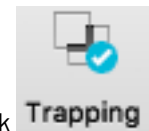

The Reverse Trap layer will be in sync again, indicated by a blue checkmark

### 9.8.3. Working with Trap Tags

A **Trap Tag** is a property attached to a group or object and saved in your document, allowing you to overwrite the general trapping settings during Automatic Trapping or Reverse Trapping.

There are two types of Trap Tags: **Trapping Tags** are taken into account when using Automatic Trapping, while **Reverse Trapping Tags** are taken into account when using Reverse Trapping

Trap Tags can be created before starting Automatic Trapping or Reverse Trapping, or after the Trap Layer was created. In the latter case, you will have to update the Trap Layer to see the result. See [Updating the Automatic Trap Layer](#) on page 251 or [Updating the Reverse Trap Layer](#) on page 259

**Note:** Trap Tags are not available when working on a Normalized PDF.

1. Select the group(s) or object(s) you want to assign a Trap Tag to.
2. Open the **Trap Tag Inspector**

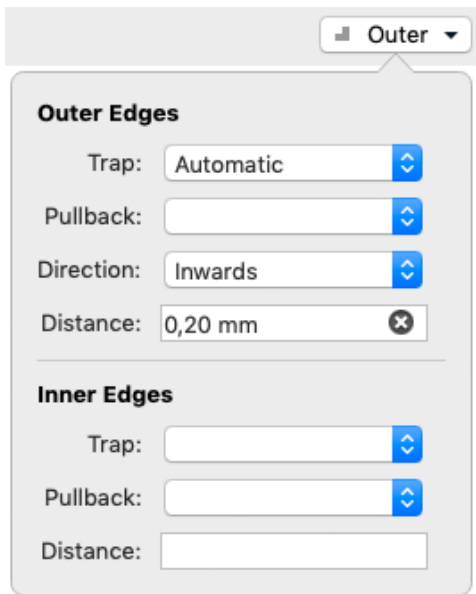

3. Set the **Trap** type: either **Trapping Tag** or **Reverse Trapping Tag**.
4. Define the settings for the **Outer Edges**, i.e. edges between the selected group or object and other objects in your document
  - If the dropdown is empty ("No Tag"), the 'default' action will be used. This can be the default trapping settings, but can also be the Trap Tag of the parent group: if e.g. a group has a Trap Tag to set **Trap** to "Always", an object within that group can have a Trap Tag to set **Trap** to "Automatic", whereas "No Tag" would apply the Trap Tag of the group.
  - Set **Trap** to decide if the edges should **Always** be trapped, **Never** be trapped, or **Automatic** to let ArtPro+ decide.
  - Set **Pullback** (Trapping Tag only) to decide if the edges should **Always** be pulled back, **Never** be pulled back, or **Automatic** to let ArtPro+ decide.
  - Set **Direction** to decide if the edges should always be trapped **Inwards**, **Outwards** or **Automatic**, to let ArtPro+ decide.
  - Enable **Distance** to set a fixed distance for the traps. You can click the **x** to remove the input.
  - Set the **Trap Position** (Reverse Trapping Tag only) to set the position of the Trap by entering a value between 50 and 100. 100% will position the Reverse Trap object completely in the selected direction (mostly into the lightest ink). 50% will place the trapping object 50% in both directions (i.e. centered on the edge)
5. Define the settings for the **Inner Edges**, i.e. edges within the group or object. This can be e.g. two adjacent objects in the same group, or the stroke and fill of a single object)

**Note:** In the Object Browser, you can get an overview of all objects with Trap Tags. See [Object Browser](#) on page 99

Objects or groups with a Trap Tag are marked with the Trap Tag icon  in the Breadcrumbs and in the Object Browser.

Changing a Trap Tag will result in the Trapping Layer being **out of sync**. To continue, update the Trap Layer. See [Updating the Automatic Trap Layer](#) on page 251 or [Updating the Reverse Trap Layer](#) on page 259

## 9.9. Warp

In ArtPro+ you can **Warp** objects based on an ArtPro GRID file or a PackEdge GRD file. You can also create a Conical Grid in ArtPro+. See [Create Conical Grid](#) on page 262

**Note:** If a structural design file is placed, you can use the Warp functionality to **predistort** graphics. See [Predistortion](#) on page 346

1. Create a Conical Grid (see [Create Conical Grid](#) on page 262) or choose **Prepress > Warp > Place Warp Grid...** or **File > Place** and navigate to the .grid or .grd file you want to place

- The grid file is always embedded. No link to the original Grid file is kept.
- The **Source** Grid is shown
- The Warp Grid object is placed in a "Warp Grid" layer
- The Grid contours are colored in a green "Bleed" colorant.
- The Warp Grid object is positioned at the center of the trim box, except in the Shrink Sleeve method. See [Shrink Sleeve Warp](#) on page 264 . You can move it using the Transform tool.

**Note:** A Grid is recognized as a Shrink Sleeve Grid if the source grid is not rectangular, but vertically symmetric and with no deformation on the horizontal grid lines, and the destination grid is rectangular.

2. Select and position the objects you want to warp correctly on the Grid. Do NOT select the Warp Grid object.
3. Open the **Warp** dialog:
  - click the **Warp** button in the upper toolbar, or
  - choose **Prepress > Warp > Warp...**, or
  - use its shortcut **Cmd+Shift+D** (Mac) or **Ctrl+Shift+D** (Windows)
4. Define all settings for the Warp

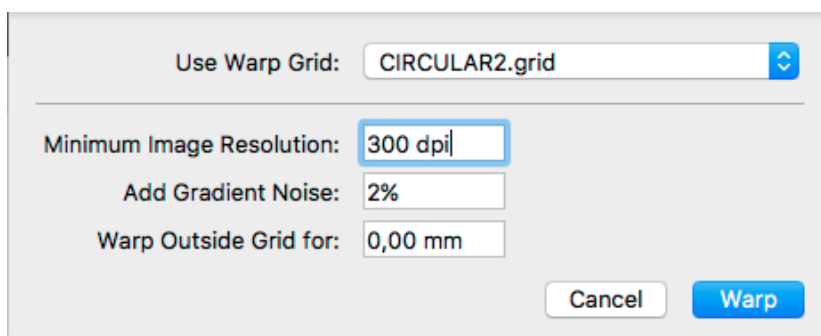

- a) Define the **Warp Grid** you want to use. If there is only one grid placed, this dropdown will be disabled.
- b) Set the **Minimum Image Resolution**. This defines the minimum resolution of images created by the warping. If an image has a resolution above the minimum, it will keep its resolution after

warping. Warping images with a lower resolution as well as gradients will result in an image at the Minimum Image Resolution.

- c) Set the amount of **Noise** to be added for gradients, which are replaced by images during warping.
- d) When warping, any object or part of an object that is outside of the source grid is cut away. Use the **Warp Outside Grid for** distance so that objects outside of the source grid but within this distance are not cut away after warping.

**Note:** If you want to Warp using the same settings as the previous warp, you can skip this step by choosing **Prepress > Warp > Warp using Last Settings** or its shortcut **Cmd+Shift+Alt+D** (Mac) or **Ctrl+Shift+Alt+D** (Windows)

5. Click **Warp**



- The result of the warp action is **Warped Art**
- Objects outside of the Source Grid expanded by the Warp Outside Grid distance are cut away.
- After warping, the **Destination Grid** is shown instead of the Source Grid.
- If you select a warped object, you can click **Unwarp** to return it to its unwarped version.
- If you select a warped object, you can click **Expand** to replace it by regular objects: paths, images, etc.



**Note:** As long as the document contains at least one Warped Object, the Destination Grid is shown, even if you place a new Grid. Unwarp or Expand all Warped Objects to show the Source Grid again.

### 9.9.1. Create Conical Grid

You can create a Conical Grid in ArtPro+. The source grid is a rectangular shape, while the destination grid is a conical shape.

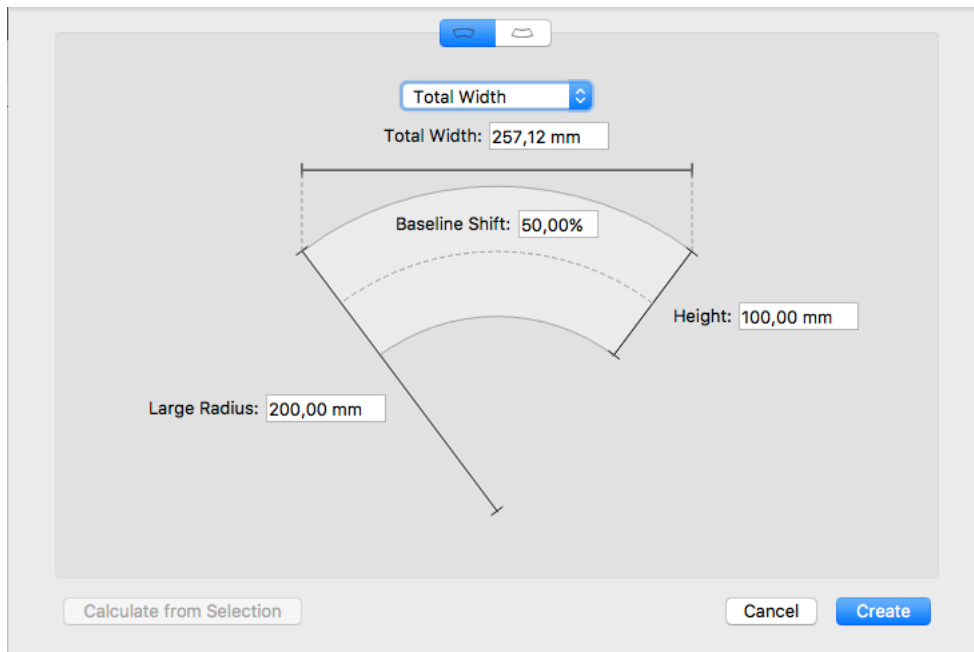
1. Choose **Prepress > Warp > Create Warp Grid...**



2. Select the **orientation**  : upwards or downwards.
3. Define if you want to set the length of the grid by entering the **Total Width**, the **Angle** or the **Top Arch Length**. The technical drawing is changed accordingly. Enter the value, either in mm or in degrees.
4. Enter the **Large Radius** and **Height** to complete the dimensions of the destination grid
5. Set the **Baseline Shift**. The Baseline Shift defines at what position (in % of the height) the Source Grid and Destination Grid have the same length, and thus deformation will be minimal. Changing the Baseline Shift changes the width of the Source Grid.

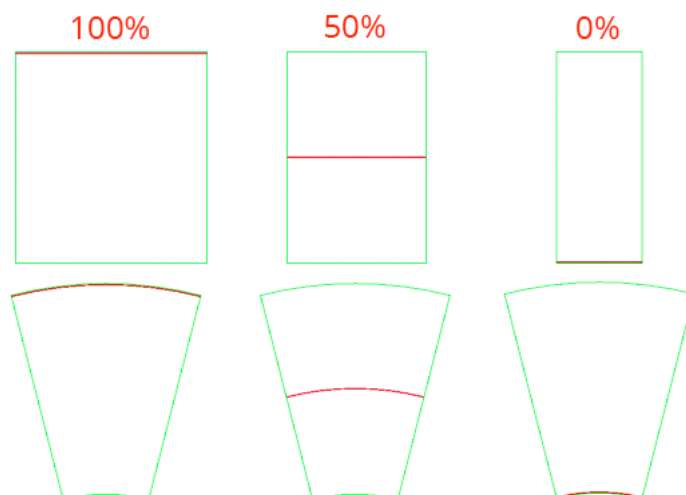

6. Click **Create**  
The Grid is created, and positioned centered on the selection.

If nothing is selected, the grid is placed centered on the Trim Box. The grid can now be used to warp. The Grid is named "Warp Grid". If that grid already exist, a number is added to the name: Warp Grid 2, Warp Grid 3, etc.

If you have a technical drawing of your Destination Grid as an object in your document, you can select it and click the **Calculate from Selection** button. The settings will be calculated to match the technical drawing as closely as possible

## 9.9.2. Shrink Sleeve Warp

ArtPro+ can recognize Shrink Sleeve Grids, and adapt to the shrink sleeve method automatically.

This method is only valid for circular, symmetrical bottles, since it is based on the assumption that shrinking is done equally around the bottle.

To achieve equal distortion on each side of the shape, the Warp Grid is automatically moved horizontally and centered on the 'visual center' of the selection.

A Grid is recognized as a Shrink Sleeve Grid if:

- the source grid is not rectangular.
- the source grid is vertically symmetric
- the horizontal lines of the source grid are straight, not deformed.
- the destination grid is rectangular.

## 9.10. Preflight

---

Preflighting a document is checking if the document is ready for output.

To preflight documents, you use Preflight Profiles. A Preflight Profile is a collection of criteria, which a document should meet to be outputworthy. For each criterion, you can specify:

- If it should be checked or not.
- How it should be listed in the Preflight Report, i.e. as a "warning" or "error" if a deviating property is detected in the document.
- If an error or warning can be signed off.

Moreover, some criteria allow you to specify how detected problems, if any, should be fixed.

An example of a criterion is RGB colors. If you do not want RGB colors in your documents, you can check this and have all RGB colors converted to CMYK.

### 9.10.1. Running a Preflight

You can run a Preflight on any PDF file.

1. Select **Prepress > Preflight**



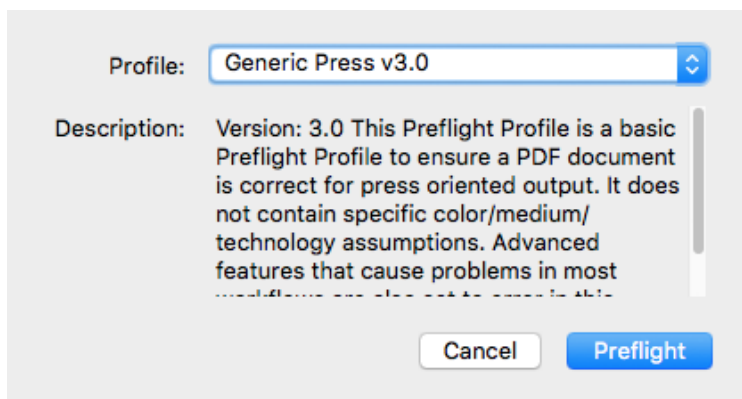

**2.** Select the Preflight **Profile** you want to use.

You can use a Standard Preflight Profile, a Local Preflight Profile or (if you have a Server connected) a Server Preflight Profile. For more info on how to manage your Preflight Profiles, see [Manage Preflight Profiles](#) on page 265

Underneath a description of the selected Preflight Profile is shown.

**3.** Click **Preflight**

When the Preflight is done, the Message drawer opens automatically.

**4.** You can then use the Message drawer to inspect the Preflight results

- a) The Message drawer shows all Errors (red), Warnings (orange) and Messages (green) in this order. If the same error was caused by different objects, you can expand or collapse the error list by clicking the triangle in front of it.
- b) Click an entry in the list to select it. The object(s) that caused the selected error will also be selected in your document. If the Preflight message refers to a part of an object (e.g. text in a barcode) you will see an area select.
- c) If the **Zoom to Selection**  option is enabled, clicking an entry displays the selected object(s) as big as possible in the active window.
- d) You can click the triangle in the top bar to see the Preflight Profile that was used to Preflight, along with its description. Click the **Generate Report** button to generate a PDF report of the Preflight. Click **Check Again** to redo the Preflight with the same Preflight Profile.

Restrictions:

- Preflight only runs on the current page of Multipage PDF files
- You can run a Preflight on Normalized PDF files, but this will only perform the checks on the document, not the automatic fixes.

## 9.10.2. Manage Preflight Profiles

Select **Prepress > Manage Preflight Profiles** to open the Preflight tab of the Preferences. You can also open the Preferences and switch to the Preflight tab then. See [Preferences](#) on page 44

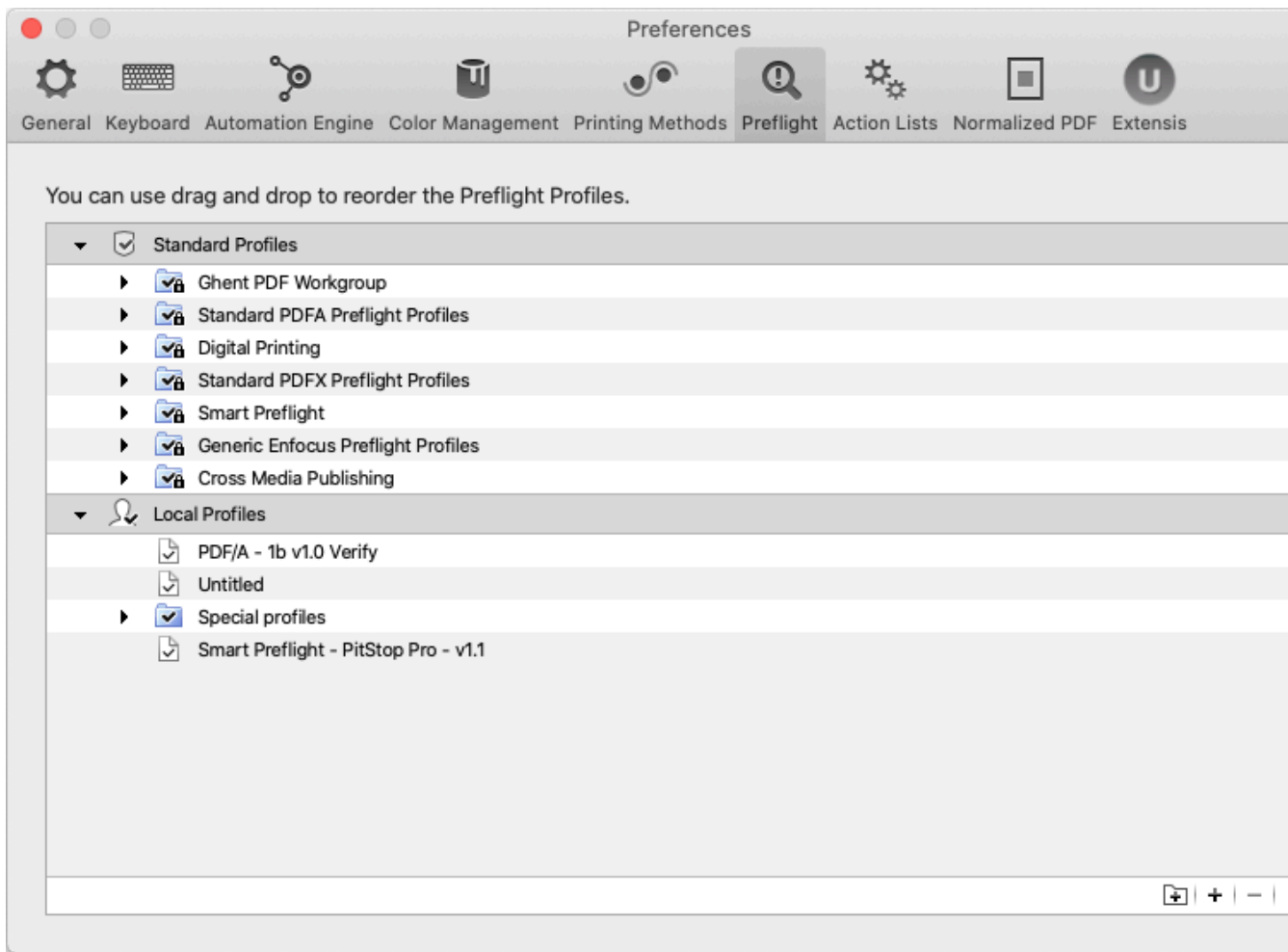

You can have three different sets of Preflight Profiles:

- **Standard Profiles:** a set of default Preflight Profiles that can not be renamed, reordered or removed.
- **Local Profiles.** If you have Enfocus Pitstop Pro installed, then any Preflight Profile saved locally in Enfocus PitStop Pro is also available in the Local Profiles folder in ArtPro+ (and vice versa).
- If you have a Server connection, the Preflight Profiles found on the server and visible in Automation Engine's PitStop Profile Editor, are shown in **Server Profiles**

If you disable a category (using the checkbox on the right hand side), the Preflight Profiles in it will not be available when selecting a Profile to run a Preflight.

- Double-click a Preflight Profile name or folder to change its name.
- Click and drag to change the order of Preflight Profiles and folders, or to put Preflight Profiles in or out a folder.

When dragging, the default action can be to move (e.g. from one subfolder to another) or to copy (e.g. from Server Profiles to Local Profiles). You can use the standard modifier keys to force copying (Alt key) or moving (Cmd on Mac, Shift on Windows).

- Click the  button or choose **Add Group** from the fly-out menu to add a (sub)folder

- Click the **+** button or choose **Create Preflight Profile...** from the fly-out menu to create a new Preflight Profile from scratch. The **Preflight Profile Editor** will open. See [The Preflight Profile Editor](#) on page 267
- Click the **-** button or choose **Remove** from the fly-out menu to remove the selected folder or Preflight Profile
- Double-click the icon of a Preflight Profile or choose **Edit Preflight Profile...** from the fly-out menu to edit the Preflight Profile in the **Preflight Profile Editor**. See [The Preflight Profile Editor](#) on page 267
- Select a Preflight Profile and choose **Duplicate** from the fly-out menu to make a new Preflight Profile based on an existing one. It will immediately be opened in the **Preflight Profile Editor**. See [The Preflight Profile Editor](#) on page 267
- From the fly-out menu, select **Import Preflight Profile** to import a Preflight Profile saved as a .ppp file into the Local Profiles.
- From the fly-out menu, select **Import Group** to import a folder containing .ppp files as a folder in the Local Profiles.
- From the fly-out menu, select **Export** to save the selected Preflight Profile as a .ppp file, or to save the selected folder as a folder containing .ppp files.

**Note:** You can not rename or reorder Standard Profiles. However, you can export a Standard Profile as a .ppp file and then import it into the Local Profiles.

### 9.10.3. The Preflight Profile Editor

Using the Preflight Profile Editor, you can create and modify Preflight Profiles

#### SETUP

In the **General Setup** you can define the Name, Author, Company and Description for the Profile.

In the **Permissions** section you can lock the Preflight Profile with a password.

You can enable or disable **sign-off**.

If you want to use Color Management or Restrictions on your Preflight Profile, you can set this up in the appropriate tabs.

#### CHECK ON

In the **CHECK ON** categories, you can define what checks need to be performed. Clicking any of the categories will show the checks you can use (e.g. "Color RGB" under "Color"). By double-clicking one of the properties you can add it to your Preflight Profile.

For every check, you can define the severity (Warning or Error) and customize the report message.

For a more elaborate documentation on the creation of Preflight Profiles, we refer to the PitStop Pro documentation, available from <https://www.enfocus.com/en/support>

#### Enfocus Action Lists

Enfocus Action Lists (.eal) can not be used directly in ArtPro+.

However, you can create a Preflight Profile, and import the Action List in its Action Lists section. By running that Profile, all checks and fixes of the Action List will be run.

You can also create your own Enfocus Action Lists using the Action Lists section in the Preflight Profile Editor.

## 9.11. Step & Repeat

**Note:** The availability of this functionality depends on your license of ArtPro+. See [Licensing](#) on page 25

There are two Step & Repeat methods available in ArtPro+.

- Creating a **Grid**. See [Grid Step & Repeat](#) on page 268
- By opening an .MFG file or a Layout CF2 file. See [Step & Repeat based on an MFG or CF2 file](#) on page 278

### 9.11.1. Grid Step & Repeat

Using the **Make Grid** function, you can create a Step & Repeat of a placed PDF file.

For more information on working with placed PDF files, see [Working with Placed Art](#) on page 173

1. Select the Placed Art you want to repeat.

**Note:** If more than one placed PDF is selected, multiple Grids will be created on top of each other.

2. Use the **Make Grid** function

- Select **Prepress > Step & Repeat > Make Grid**
- Use the **Make Grid** button in the Placed Art Inspector
- Use the shortcut **Cmd+Alt-G** (Mac) or **Ctrl+Alt+G** (Windows).

A 2 x 2 repetition of the selected Placed Art is created, using the Trim Box (when available) as step distance. You can modify the Grid using the **Grid Inspector**. See [The Grid Inspector](#) on page 268

When creating a grid from a Placed Art object, by default the Processing Step Cutting layer will be used as **Die Shape**. If the Placed Art object contains cutting lines as part of the Structural Design, the **Die Shape** can be set to "cutting layer".

If no Special Type Cut layer is available, the Trim Box is used instead. You can change the Die Shape in the Placed Art Inspector. See [Placed Art Inspector](#) on page 176

When selecting a Grid, the Placed Art inspector will allow to change the initial **Orientation** of the one-ups in this grid. Their orientation within the layout can be changed further by the option **Head Turn**. See [Placed Art Inspector](#) on page 176





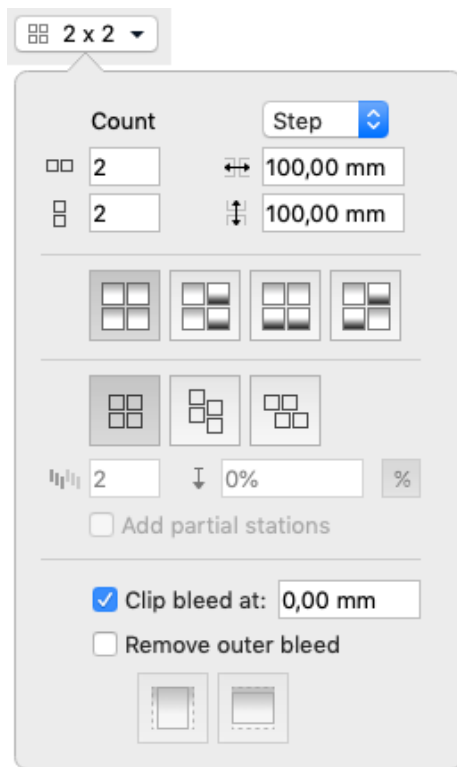

The Grid information is saved in the PDF file, so you can edit all parameters after reopening the file.

**Note:** Since Step & Repeat is using Placed Art, the same restrictions apply: you can not place a PDF if the current document is a Normalized PDF file.

#### The Grid Inspector

In the Grid Inspector you can change the selected S&R Grid.



1. You can define the number of horizontal  and vertical  repeats
2. Using the dropdown menu, you can switch between defining the **step** distance horizontal  or vertical , and defining the **gap** distance horizontal  or vertical .
  - Setting the **gap** means defining the distance between the right (or bottom) side of the previous step, and the left (or top) side of the next step. The step distance will be the (vertical or horizontal) size of the one-up, plus the size of the (vertical or horizontal) gap.
  - Setting the **step** means defining the distance between the left (or top) side of the previous step, and the left (or top) side of the next step. When setting the step distance, the size of the one-up is not taken into account.
3. Define the Head Turn



- You can choose between
  - No Head Turn



- Head Turn on column



- Head Turn on row



- Head Turn on row and column



4. Define the **staggering**. See [Stagger](#) on page 271
5. **Clip Bleed** creates a clipping mask around the one-up, to clip any bleed to the desired distance. Read more about bleed in [Working with bleed](#) on page 273

### Stagger

Staggering allows to shift the 2nd, 3rd, ... row or column down or to the right.

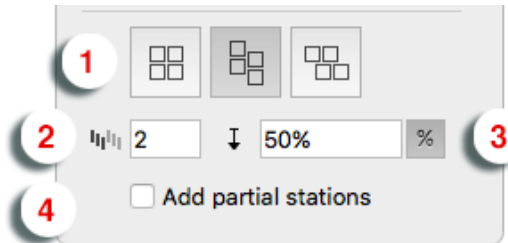

1. Select the **Direction** in which you want to stagger the one-ups. From left to right, the choices are: No Stagger, Stagger Columns, and Stagger Rows.
2. The stagger will be repeated for a number of rows or columns as defined in **Restart after n columns/rows**. After that, the next one-up will be at the begin position again.
3. You can define the distance for staggering. By clicking the button you can switch between entering the distance as a fixed value in the current units, or as a percentage of the one-up size.
4. If **Add partial stations** is enabled, the gaps created by staggering will be filled with partial labels (print items).

#### Examples:

No stagger:



Stagger Vertical, 50% distance, using a negative horizontal gap, Repeat After 2 columns:

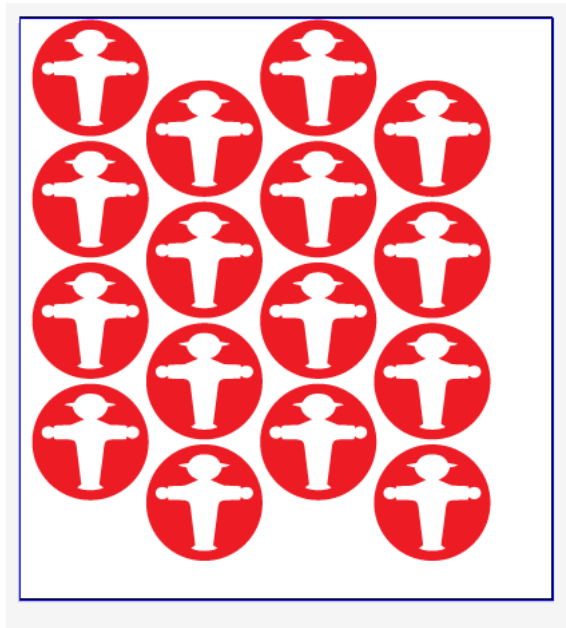

Stagger Horizontal, fixed distance, using a negative vertical gap, Repeat after 3 rows:

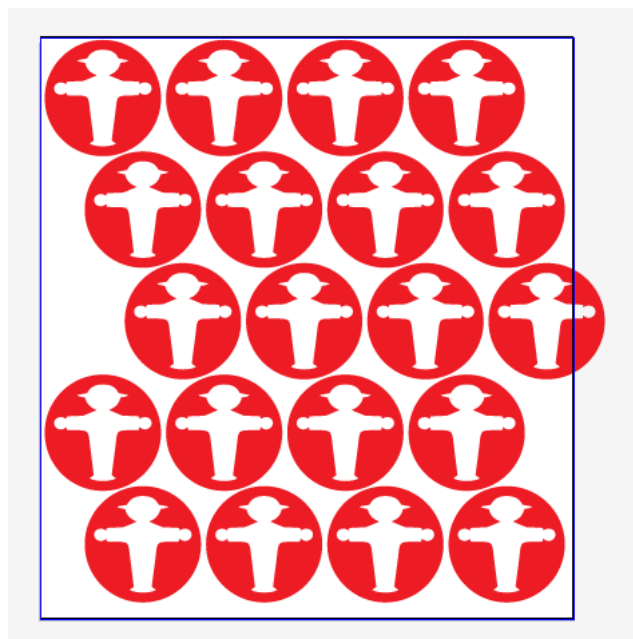

Same as above, with **Add partial stations** enabled:



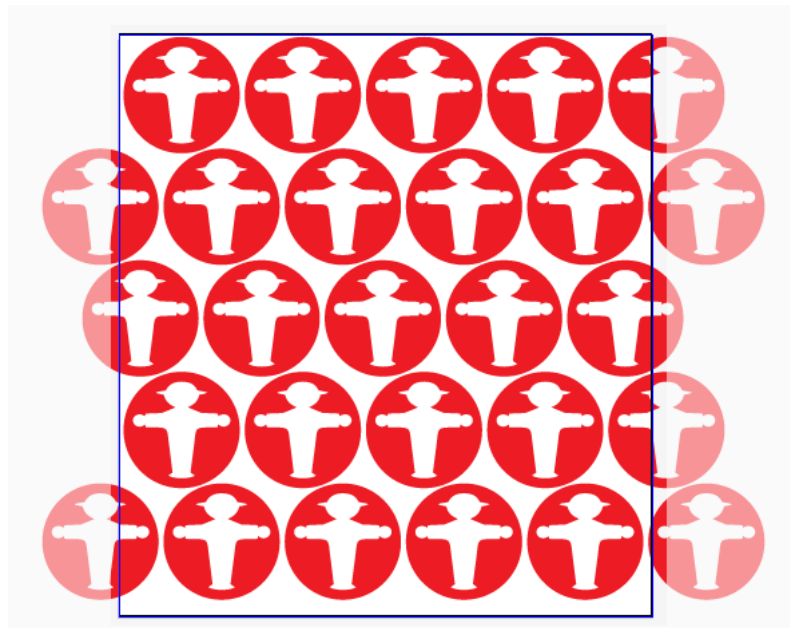

### Working with bleed

When using a placed PDF file as one-up, the available "bleed" is the artwork between the TrimBox and the MediaBox. Information outside the MediaBox is never used.

In this example one-up, the yellow is outside the MediaBox (and will not be used in the Repetition), the blue is between MediaBox and TrimBox (and thus "bleed"), and the green is inside the TrimBox.

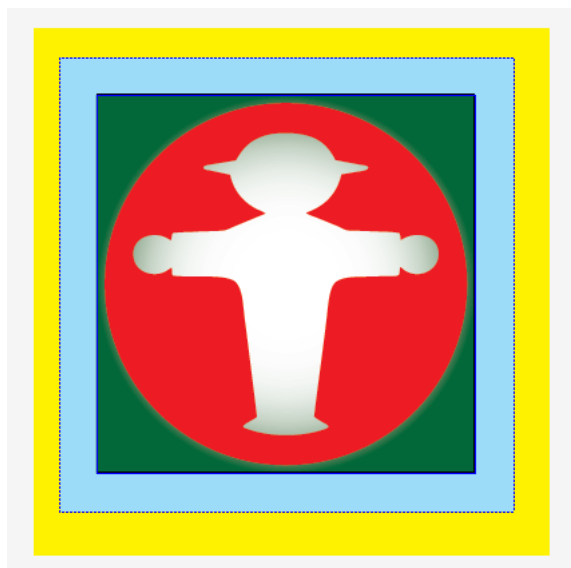

The example underneath shows a Repetition of this file, with a big step distance, and no Clip Bleed. As you can see, the bleed is limited to the MediaBox (no yellow is shown).

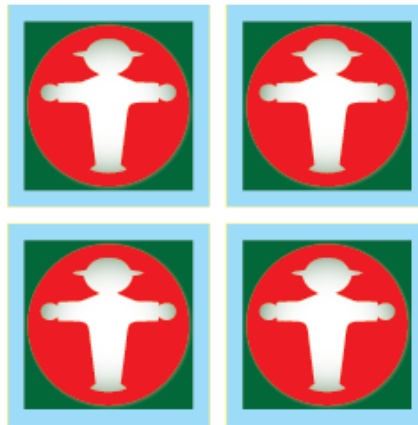

If you would repeat the same file, using the (TrimBox) size of the one-up as step distance (i.e. set the gap distance to zero), the bleed of the topmost one-up would overlap the underlying one-ups, as shown in this example.



To avoid this, the **Clip bleed at** option can be used.

When enabled, a clipping mask is applied around the one-up, based on the defined **Die Shape** (see [Placed Art Inspector](#) on page 176), using a centerline algorithm. A distance can be entered to offset the clipping mask from the Die Shape, either positive (to the outside) or negative (to the inside). If two one-ups (or their bleed) would overlap (i.e. if the size of the Die Shape + the "Clip Bleed at" distance is larger than the step distance), the clipping mask of both will be restricted to half way the overlap, so the clipping masks don't overlap.

Below the same example Repetition as above (no gap), with **Clip Bleed at** enabled and set to 0mm.



If **Clip Bleed at** is set at a positive value, bleed will become visible on the outside of the Repetition.



If the step distance is increased (or a gap distance is entered), bleed is added in between the labels, and divided equally over the two adjacent one-ups.



In some cases, using the **Clip Bleed at** option will give undesired results. In the example underneath you see a Repetition with Staggering, using a negative horizontal gap, using the Trim Box as Die Shape. If the **Clip Bleed at** option is enabled, parts of the labels are clipped off.

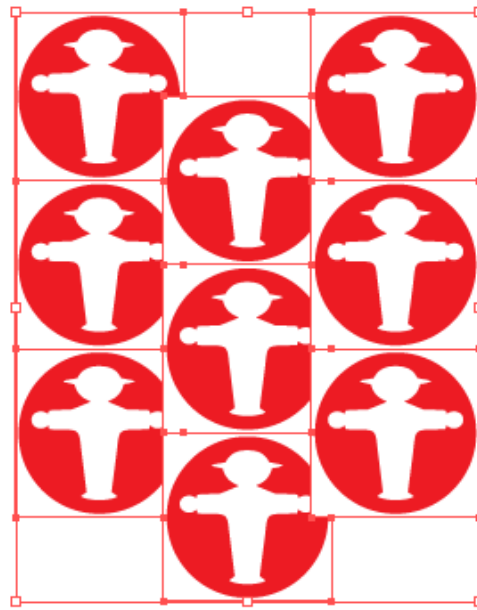

If **Clip Bleed at** is disabled, you get the result shown below:



In the example above, it would obviously make more sense to use a circular Die Shape, e.g. based on the Processing Step Cutting layer or on a specific separation. In that case the **Clip Bleed At** is based on the defined Die Shape. This allows to add bleed in between the labels, using the centerline in case bleed might overlap.

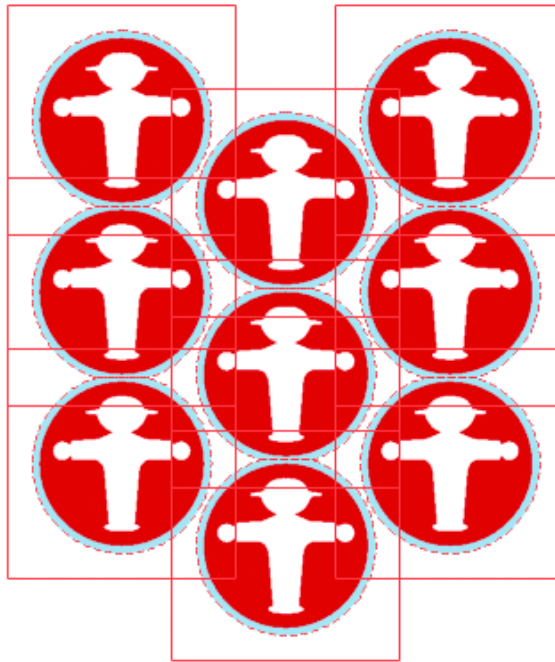

In case of a vertical or horizontal stagger, you can set the **Remove Outer Bleed** option. When enabled, the outer bleed on the top and bottom (for vertical stagger) or left and right (for horizontal stagger) sides will be calculated as if extra grid cells are present outside those sides.

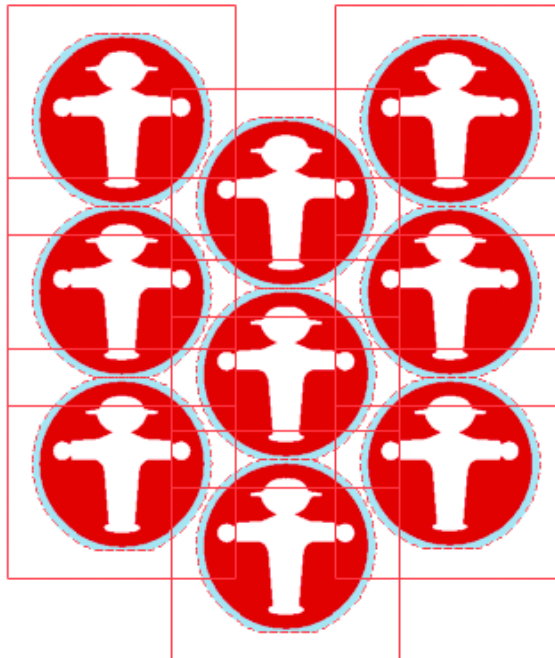

### Positioning the Grid

The Transformation Inspector, which you can use to change the position of the Grid, is slightly different when selecting a Grid. See [Transformation Inspector](#) on page 127

The position of a Grid is based on 3 settings:

#### Attach to

The position of the Grid can be based on

- the Art Box
- the Bleed Box
- the Crop Box
- the Media Box
- the Trim Box
- another S&R Grid

#### Positioning

The way the Grid is attached, can be chosen by clicking and dragging the red square (representing the Repetition) to the desired position on the gray square (representing the **Attach To** reference). Each square has 9 reference points (top left center and right, middle left center and right, and bottom left center and right), so you have 81 different ways of positioning the Grid.

In below example, the top center of the (bounding box of the) Grid will be placed on the left bottom corner of the (bounding box) of the reference defined in the 'Attach to' field.



#### Offset

In the offset fields, you can move the Grid based on the defined position.

## 9.11.2. Step & Repeat based on an MFG or CF2 file

An ArtiosCAD MFG file is a Manufacturing structural design file, containing a repetition of Structural Design files (ARD).

A Layout CF2 file is a CF2 file that contains a repetition, based on subroutines.

If you set the dropdown at the bottom of the File Open dialog to "All supported Structural Design files", you can open an ArtiosCAD MFG (Manufacturing structural design file) or a Layout CF2 file in ArtPro+. You can also simply drag and drop the file onto the application or the dock icon.

**Note:** Unlike ARD files, you can not place an MFG file.

This is the typical workflow with MFG or CF2 files:

1. Open the MFG or CF2 file in ArtPro+, either using **File > Open** or by dragging and dropping the file on the application or doc icon.

**Note:** When using the File Open dialog, you have to set the file selector to **All Supported Structural Design Files** to select an MFG or CF2 file.

If the **Import Cutting Data for Layout Files** option is set to **Ask when opening files**, you will be asked if you want to import the cutting data from the MFG or CF2 file as Processing Steps.

- If you select **Do not import**, only the Structural Design is imported.
- If you select **Import Cutting Data**, the cutting data from the MFG or CF2 will be imported as Processing Steps, and the cutting lines will be visible in the dummy stations. This can be used to visually check the position of one-ups that don't contain cad data.
- If you enable the **Remember my choice** option, your choice will affect the setting of the Preferences, and you will not get the dialog the next time you open an MFG or CF2 file. You can always change the option in the General section of the **Preferences**. See [Preferences](#) on page 44

The MFG or CF2 Layout file is opened:

- The Sheet Size and Margin defined in the MFG file or CF2 file will define the Trim Box and Media Box.
  - A layer using the name of the MFG or CF2 file is created
  - The **Placed Art side drawer** is opened, showing all the placeholders, one for every ARD or CF2 Station included in the MFG or CF2 file.
  - For every Placeholder, its ARD or CF2 filename, Print Item, dimensions and amount of copies used in the repetition is shown in the Placed Art side drawer. You can also see the index (A, B, ...) which is also shown in the Placeholder in the actual document.
  - Every different placeholder also uses a different temporary Placeholder color (Apricot, Pink, ...)
2. Select the Placeholder you want to replace, either in the Placed Art side drawer or in the actual document.

If you want to select e.g. all "A" placeholders, the best way to do so is using the Placed Art side drawer. By selecting in the document, you can combine different placeholders.

3. Open the **Placed Art Inspector**

You can see the name of the selected Structural Design file (.ard or .cf2), the Print Item when defined in ArtiosCAD, and the dimensions.

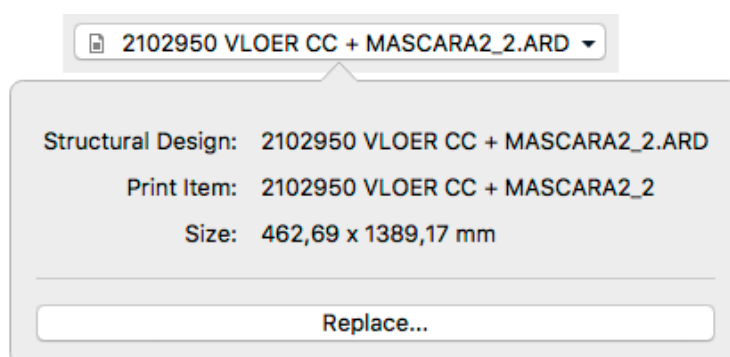

4. Click the **Replace...** button, and browse for the graphics file you want to use for that station.

You can use PDF+ or Normalized PDF files. PDF+ files can be linked or embedded, while Normalized PDF files will always be embedded. See [Linked versus Embedded Placed Art](#) on page 175

If the placed file contains the corresponding Structural Design file (.ard or .cf2), this will be used to position the graphics. Otherwise, the placed file will be centered based on the Trim Box.

The placed file becomes a regular Placed Art, so you can use the **Placed Art Inspector** to update, replace, ... See [Working with Placed Art](#) on page 173. However, on the document, it remains a Structural Design station in an MFG / CF2 workflow. You will e.g. still need an ArtPro+ Advanced license to replace Structural Design Stations.

The separations used in the placed graphic will be added to the Separations list. The Placeholder separations will be removed from the Separations list as soon as they're not used anymore.

### Station Numbering in an MFG / CF2 workflow

When using an MFG file or Layout CF2 file to create a Step & Repeat (See [Step & Repeat based on an MFG or CF2 file](#) on page 278) you can use **Station Numbering**.

You can either generate a dedicated Station Number Placeholder in your one-up, or you can use a text object from the one-up structural design file, when present.

1. Add the Station Number Placeholder to your one-up. If you want to use a text object from the one-up structural design file, you can skip this step.
  - a) Open the graphics file of the one-up.
  - b) Create or select an object (a rectangle, a path, a text box, ...) and position it where you want to place the station number.
  - c) Select **Object > Convert to Placeholder**
  - d) Select **StationNumber** and click **OK**

The object loses its fill, stroke, text, .. and is converted to a placeholder object. You can still change the name, position and orientation of the object.

If needed, you can add more placeholders to the job.

- e) Save the file
2. Open the MFG or CF2 file, and apply the saved graphics file to the corresponding placeholder(s). See [Step & Repeat based on an MFG or CF2 file](#) on page 278
3. In the **Marks** section, click the **Load Mark Set** button .
4. Select the **Standard Repeat for Stations Mark - Station Number** Mark Set, and click **Load**  
A **Repeat for Stations Mark** will be created, containing a Point Text Mark using the Station Number as variable, in Darkest Color, positioned centered on the StationNumber placeholder for every station.
5. Using the **Mark Inspector** and **Transformation Inspector** you can change the **Repeat for Stations Mark** contents, color, and positioning. See [Repeat for Stations Mark](#) on page 315

**Note:** If you add Station Numbers based on the Station Number placeholder in the one-up graphics, the station numbers will only become visible once the placeholders are replaced by graphics.



### Bleed in an MFG / CF2 workflow

When opening an MFG or Layout CF2 file, the bleed mask is automatically generated from the die shape.

Where panels touch, an overlap decision is made, based on a number of criteria.

- the **Allow bleed** flag of a panel, set in the MFG or CF2 file. For more info on this setting, see the ArtiosCAD documentation.
- the size of the touching panels. The largest panel will bleed into the smaller one.

Using the **Layout Inspector**, you can change the bleed for your MFG or CF2 file.

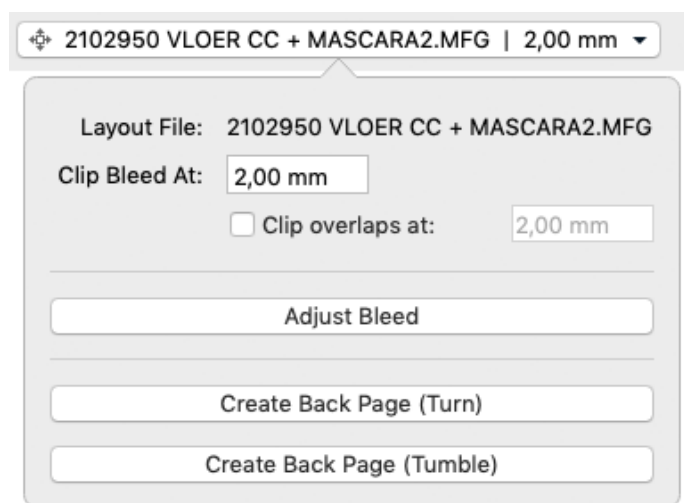

1. The **Layout File** shows the name of the MFG or CF2 file used.
2. Set the **Clip Bleed At** value. This is the amount of bleed added to the outside of the bleed mask that was generated from the die shape.
3. Enable the **Clip overlaps at** option if you want to use a smaller bleed distance when one panel bleeds into another one, e.g. to limit the bleed onto a glue flap. Where there is no neighbouring flap, the **Clip Bleed At** distance will be used.

**Note:** The **Clip overlaps at** can't be higher than the **Clip Bleed At** distance. If necessary, the **Clip Bleed At** value will be adjusted.

4. To check and/or change the overlap decisions, select the Adjust Bleed tool by clicking the **Adjust Bleed** button.

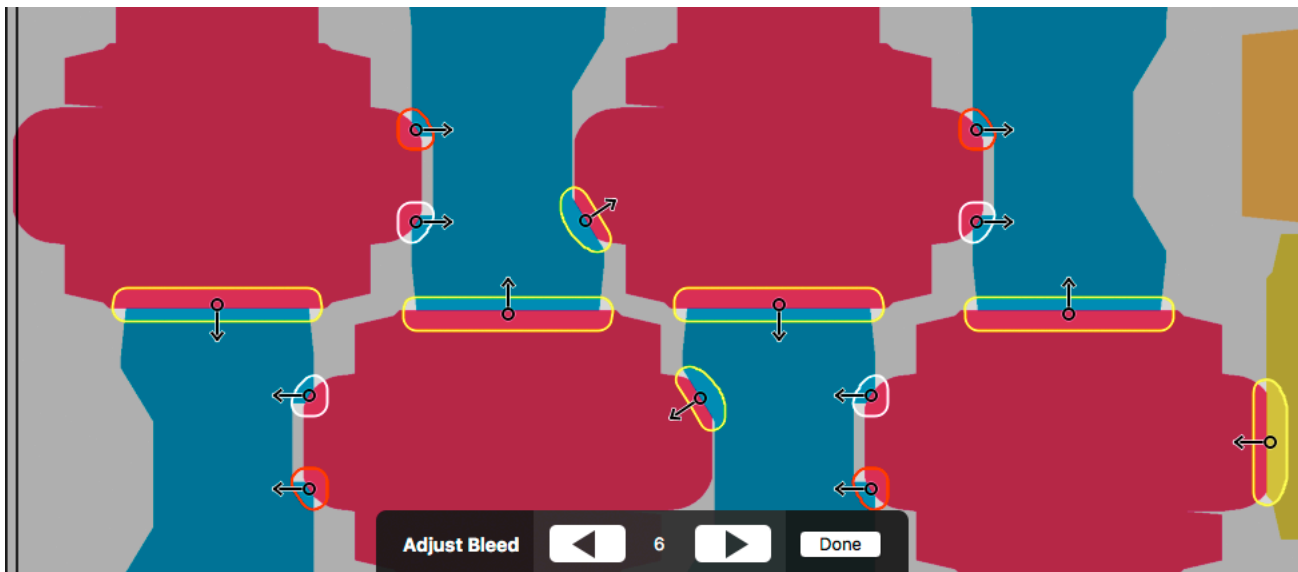

When the tool is active, all areas where flaps overlap using the given bleed distance will be marked on the document, indicated in white, yellow or red.

- **White:** This is a decision that is assumed to be correct, e.g. if the direction comes directly from the MFG Allow Bleed flag, without any conflicts, or the user made the decision, without causing any conflicts.
  - **Yellow:** This is a decision that is likely OK, but there might be doubt, e.g. because the 2 affected panels have similar sizes.
  - **Red:** This is a decision that needs to be checked with care, because there is reason to doubt it is correct, e.g. the criteria used to determine the direction are inconclusive, or cause conflicts in other areas involving any of the affected panels.
5. In the **Tool Options** at the bottom of the screen you can check the total number of unique bleed areas. Navigate through these decisions using the Next and Previous buttons or the left and right Arrow keys. The corresponding bleed area will be highlighted.



6. Hover over a bleed area to highlight all the repetitions of the bleed area. This way you know where your bleed decision is repeated.

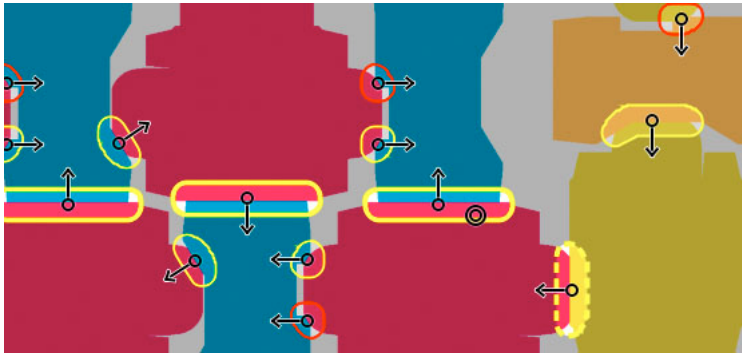

Other affected bleed areas are shown using a dashed line. See below.

7. Change the bleed direction of the highlighted bleed area by **dragging** from within the bleed area towards the panel that needs to receive bleed, or clicking inside the bleed area to apply **centerlining** on both panels.

By dragging from panel A to panel B you are actually making 2 bleed decisions. It means panel B is set to allow bleed, and panel A is set to trim (bleed onto panel B).

That means that any other bleed area where panel A or panel B is involved, may be affected as well: if you change a bleed direction in a way that sets panel B to allow bleed, the bleed decision for other bleed areas where panel B is involved, will also be revised and set panel B to allow bleed. These areas are indicated by a dashed line when hovering.

8. Switch to any other tool or click the **Done** button to exit the **Adjust Bleed** tool.

**Note:** Adjusting the bleed decisions after saving and reopening the file is currently not supported in ArtPro+.

## Back Page

If you have a MFG or a Layout CF2 file open, you can create a Back Page for it.

1. Open the MFG or Layout CF2 file you want to use.
2. It is advised to fill all the one-ups, set the bleed and adjust the bleed masks as needed on the front page first
3. In the **Layout Inspector**, click the **Create Back Pack Page (Turn)** to create a back page by mirroring horizontally, or **Create Back Page (Tumble)** to create a back page by mirroring vertically.  
A second page will be created (see [Working with multi-page documents](#) on page 91) with mirrored page boxes, mirrored stations and placeholder graphics including the bleed mask set on the front page
4. If you use 2 page one-ups, the backside graphics will be applied automatically. See [Working with two-sided one-ups](#) on page 283. If not, you can fill the placeholders with the backside graphics the same way you did on the front page

**Note:** You can't change the Mask distance on the back page, only on the front page. You need to regenerate the back side to update it.

## Working with two-sided one-ups

Using two-sided one-ups, you can fill the stations for the front and back page in one go.

1. Create the first page of the one-up, containing the front graphics, and the ARD or CF2 set to **front**
2. Add a second page, containing the back graphics, and the ARD or CFF set to **back**
3. Save the one-up
4. Open the MFG or Layout CF2 file
5. **Replace** the placeholders with the one-up files.
6. Set the bleed and adjust the bleed masks as needed
7. In the **Layout Inspector**, click the **Create Back Pack Page (Turn)** to create a back page by mirroring horizontally, or **Create Back Page (Tumble)** to create a back page by mirroring vertically.  
A second page will be created, and the back side of the one-up is automatically positioned in the stations on the back page.

## 9.12. Fix Thin Parts

**Note:** The availability of this functionality depends on your license of ArtPro+. See [Licensing](#) on page 25

The **Thin Parts** function allows to search for and fix areas where objects are thinner than a given minimum width.

1. Select the objects you want to check and fix
2. Choose **Prepress > Fix Thin Parts**

The Fix Thin Parts toolbar shows up.

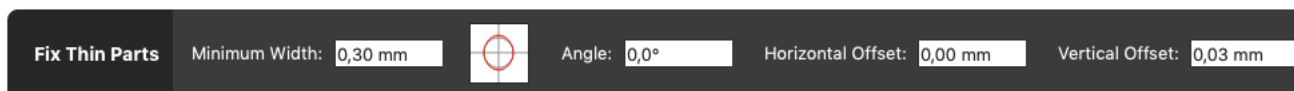

3. Define the **Minimum Width**

The optimal values for Angle, Horizontal Offset and Vertical Offset for the currently selected objects will be calculated.

4. If needed, adjust the **Minimum Width**, **Angle**, **Horizontal Offset** or **Vertical Offset** values.
  - The red circle image gives an indication of how the Thin Parts Fix will be positioned on the original object.
  - The angle can be between  $-45^{\circ}$  and  $+45^{\circ}$  and defines the direction of the Horizontal and Vertical offset.
5. Click **Fix** to create the Thin Part Fix objects.

ArtPro+ will generate Fix Thin Part objects, that will be placed on top of the originally selected objects as a group named "Thin Part Fixes". The original objects remain selected.

Any existing Thin Part Fixes objects for the selected objects will be updated if you apply a new Fix.

## 9.13. Flexo Tools

---

### 9.13.1. Create Plate Cutting Paths

**Note:** Create Plate Cutting Paths is only available if you have a Plate Cut license. See [Licensing](#) on page 25

**Plate Cutting Paths** offer an alternative for Staggered Cutting in ArtPro or Packedge/Plato. It is designed to facilitate seamless printing in non-sleeve workflows. This means that when web fed flexo printing jobs are not using flexo sleeves the flexo material is cut and wrapped around a cylinder. The unavoidable seam will be positioned in between printable objects. **Plate Cutting Paths** is the tool to define the shape of the flexo plates, which will later in the process be sent to a Kongsberg table on which the flexo plates are cut. A cut path can be used for all separations, or a cut path per separation can be defined.

**Note:** Plate Cutting Paths can only be created on PDF+ files, and only objects inside the page boxes are taken into account, so it is advised to set all page boxes correctly before creating the Plate Cutting Paths.

1. Open the document on which you want to apply the Plate Cutting Paths.  
Typically but not necessarily this will be a Step & Repeat file. If this file was created in Plato or ArtPro, keep in mind to convert it to PDF+ before continuing. See [Convert to PDF+](#) on page 54
2. To create fully automatically calculated Plate Cutting Paths, make sure that no objects are selected.  
If you want to create Plate Cutting Paths based on manually drawn objects, see [Using Plate Cutting Guides](#) on page 287
3. Choose **Prepress > Flexo Tools > Create Plate Cutting Paths**

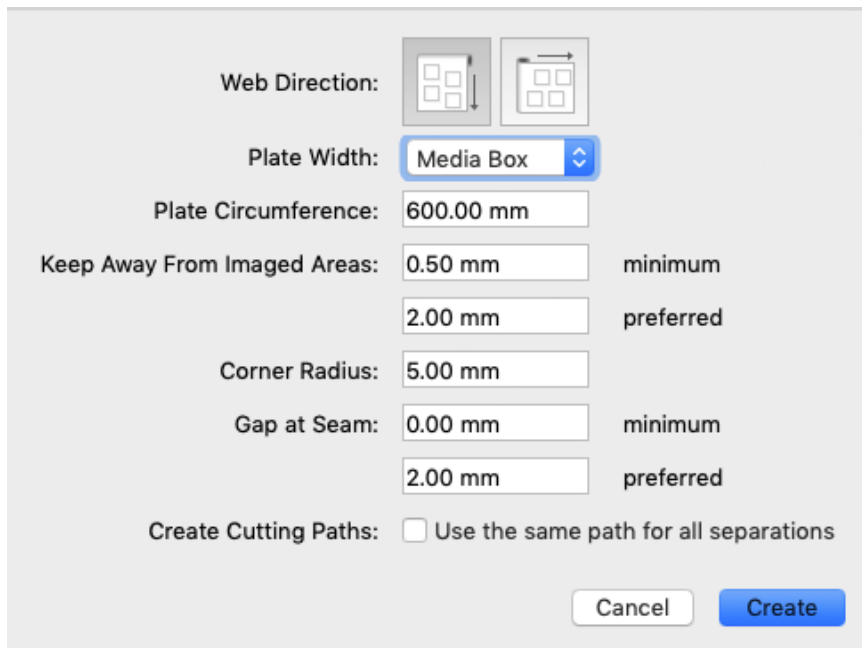

4. Define the **Web Direction**, either vertical or horizontal
5. Set the **Plate Width** by selecting a page box from the dropdown.
6. The **Plate Circumference** value is filled automatically based on the selected Plate Width. You can however override this value.
7. Set the **minimum** and **preferred** distance the Plate Cutting Paths should stay away from the imaged areas
8. Set a **Corner Radius** to round corners in the Plate Cutting Path to the specified radius. Rounded corners facilitate cutting and avoid damaging the plate when taking it off the cylinder.
9. Specify a **Gap at Seam** if you want to make the flexo plate a bit smaller than the repeat length. The distance between the two identical segments will be the Repeat Length minus the Gap. You can specify a **minimum** and **preferred** gap.
10. You can choose to create one single path by enabling the **Use the same path for all separations** option
11. Click **Create** to create the Plate Cutting paths.
  - The Media Box is adapted to the repetition and a Crop Box is set (the same size of the Media Box).
  - The **Remove outer bleed** option in the Grid inspector is enabled in case it was not.
  - A new layer "Plate Cut" will be created, and a new Processing Step ink is added
  - The Cutting Path layer contains sub-layers for each separation. You can view and select these separation sub-layers in the Object Browser. In combination with toggling the visibility of the separations, this allows you to distinguish between the different separations and the corresponding Cutting Paths. When you chose to use the same path for all separations, only one sublayer is created, using all separation names in the path's name.
12. The automatically created Plate Cutting Paths don't need any editing. If you want to adjust the Plate Cutting Paths, you should create a **Plate Cutting Path Guide** before creating the Plate Cutting Paths. See [Using Plate Cutting Guides](#) on page 287

You can always go back to your original artwork simply by removing the Plate Cut Layer.

You can use the **Flexo Print Preview** in **Quality Control** to inspect the Plate Cutting Paths. See [Flexo Print Preview](#) on page 80

**Note:** Plate Cutting Paths are only supported on a single grid of a single one-up.

## Using Plate Cutting Guides

Using a **Plate Cutting Guide** you can manually define the shape of your Plate Cutting Paths.

1. Using the **Edit Path tool**, draw the path you want to use as Plate Cutting Guide, from one side of the grid to the other. See [Create & Edit Path](#) on page 132

Make sure the path is one continuous open path at least as long as the grid is wide.

**Note:** Use **Flexo Print Preview** in the **Quality Control** side panel to get a preview of the repeated grid, so you have more control when drawing the path. See [Flexo Print Preview](#) on page 80

2. Stroke the path, and color it with 100% of the separations you want to use it for.

If you color it for example with 100% Cyan and Yellow, the Plate Cutting Guide will be used for the Plate Cutting Path for Cyan and Yellow, while for the other separations (e.g. magenta, black, ...) the automatic Plate Cutting Path generation will be used.

**Note:** If you want to use the same Plate Cutting Guide for all separation, color the stroked path in 100% of all separations. Alternatively, you can use just one separation in the stroke, and enable **Use the same path for all separations** when creating the Plate Cutting Paths.

3. Select the Plate Cutting Guide(s) you want to use, and create the Plate Cutting Paths. See [Create Plate Cutting Paths](#) on page 285

**Note:** Although objects that are not stroked paths will be ignored, it is recommended to **only** have your Plate Cutting Guides selected.

The Plate Cutting Paths will be created, using the Plate Cutting Guides when defined, otherwise the automatically generated Plate Cutting Paths will be used.

When two Plate Cutting Guides using the same separation are selected, or if you have more than one Plate Cutting Guide selected and the option **Use the same path for all separations** is enabled, a warning message will be shown.

### 9.13.2. Plate ID Objects

If you are using ArtPro+ in combination with Esko's Imaging Engine within the flexographic printing industry, you can use **Plate ID** objects to identify Flexo Plates, e.g. for reprint after being archived, or to be reused in a similar jobs.

**Plate ID** objects will be exposed by the RIP at "half height". This means the objects are permanently visible, yet they do not show up on the printed result.

For more information we refer to the chapter on Working with Plate ID in the Automation Engine documentation [here](#)

**Note:** Plate ID Objects use Processing Steps, and are only available in PDF+. See [PDF, PDF+ and Normalized PDF](#) on page 52

- To create a static Plate ID object, see [Creating a static Plate ID Object](#) on page 288
- If you want to create a dynamic Plate ID object, you can use a Plate ID Mark. See [Creating a Plate ID Mark](#) on page 289

A **Plate ID Object** is static:

- Any Marks in the selection when creating the Plate ID Object will be expanded, and thus no longer be dynamic.
- A Plate ID Object is colored in the Plate ID colorant. However, the **Separation Selector** defines on what plates the Plate ID object should be applied. This Separation Selector is static, meaning that if you change the document separations or copy and paste the Plate ID Object in another document, the Separation Selector will not be updated.

A **Plate ID Mark** is a Mark, and thus dynamic:

- The Plate ID Mark can contain nested marks, e.g. a Text Mark containing the separation name as a variable. See [Nested Marks](#) on page 323
- The separation filter, indicating on what plates the Plate ID Mark should be applied, is adjusted to the separations in the document.
- The positioning of the Plate ID Mark is dynamic. See [Mark positioning](#) on page 318

## Creating a static Plate ID Object

To create a static **Plate ID Object**:

1. Select the objects you want to create a Plate ID object of.

**Note:** Images, Placed Art and clipping paths are not supported. Unsupported objects in the selection will be removed.

2. Select **Prepress > Flexo Tools > Create Plate ID Object**

- All (supported) objects in the selection are converted into one Plate ID Object. Marks in the selection will be expanded and thus no longer be dynamic.
- A Plate ID Object is colored in 0% of the Plate ID Processing Step colorant if the original object was 0% in all separations. In all other cases, the object is colored in 100% of the colorant. Gradients and patterns are changed to 100% flat paint.
- The Plate ID Object is set to overprint, and transparency settings are set to "Normal" at 100% opacity.
- The Plate ID Object is moved to the "Plate ID" layer.

3. Using the **Plate ID Object Inspector** you can define on what plates the Plate ID Object has to be exposed.



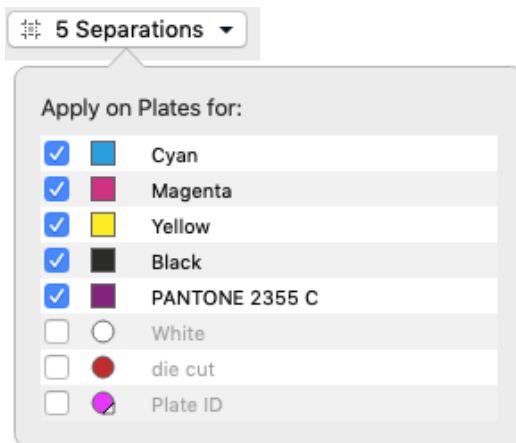

By default all artwork separations will be enabled, while Processing Step colorants and unused separations are disabled. You can however manually add or remove separations.

### Creating a Plate ID Mark

To create a dynamic **Plate ID** object, you should create a **Plate ID Mark**

1. Select the objects you want to create a Plate ID Mark of.

**Note:** Images, Placed Art and clipping paths are not supported. Unsupported objects in the selection will not be used in the resulting Plate ID Mark. These objects are not removed, and remain in the original source content. This also means you will get warnings in the Messages Drawer until you manually remove them from the Mark Content, using **Edit Content**.

2. In the **Marks** section of the Side Panel, click the **Create Mark from Selection** button  and select **Create Plate ID Mark from Selection**
  - All (supported) objects in the selection are converted into one Plate ID Mark.
  - Marks in the selection that can be **Nested** (Text Marks, Custom Marks, Barcode Marks, External File Marks and Position Marks) are preserved. Other Marks in the selection will be expanded. See also [Nested Marks](#) on page 323
  - A Plate ID Mark is colored in 0% of the Plate ID Processing Step colorant if the original object was 0% in all separations. In all other cases, the object is colored in 100% of the colorant. Gradients and patterns are changed to 100% flat paint.
  - The Plate ID Mark is set to overprint, and transparency settings are set to "Normal" at 100% opacity.
  - The Plate ID Mark is moved to the "Plate ID" layer.
3. In the **Mark Inspector** you can define on what plates the Plate ID Object has to be exposed.

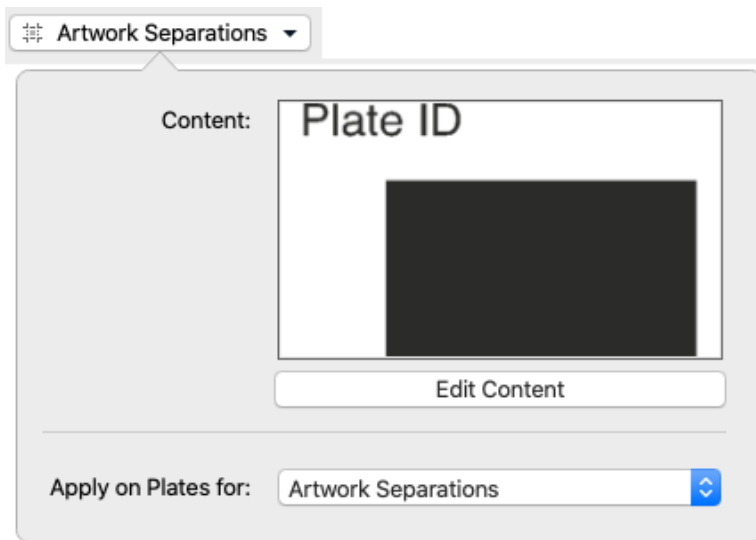

You can choose to place the Plate ID Mark on all Plates for **Artwork Separations**, for **Artwork Separations and Varnish**, or **Custom**: this allows you to select separations by combining rules on Printing Method, Processing Step, Separation Name, Process Separations, Non-Process Separations or Artwork Separations.

- Using the **Edit Content** button in the Mark Inspector, you can edit the shape of the Mark. See [Editing a Mark](#) on page 322. You can also double-click the Mark while holding the Alt key.

**Tip:** If your selection contained unsupported objects, e.g. an image, when creating the Plate ID Mark, you can use the **Edit Content** button to remove the image, so that you will no longer get the warning message that the image is discarded in the Plate ID Mark

- Using the **Transformation Inspector** you can set the dynamic positioning of the Plate ID Mark. See [Mark positioning](#) on page 318

**Note:**

To include the separation name in the Plate ID Mark:

- Create a Point Text Mark or Area Text Mark. See [Point Text Mark and Area Text Mark](#) on page 294
- Besides static text, add the separation name as a variable. See [Using Smart Text](#) on page 295
- Select the text Mark and select **Create Plate ID Mark from Selection**

Note that, since the Plate ID Mark will have different text for different separations, all placed on top of each other, the text will look garbled. This will not be an issue when the Mark is exposed on the plate, since each plate will only get the text showing the separation name for that specific plate.



You could **expand** the Mark to inspect the individual objects.

# 10. Marks

Using the **Marks**, you can create sets of Marks, add them in a document, and have full control over these Marks.



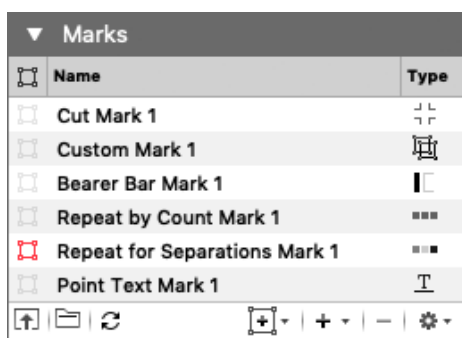

**Important:** You can only create and apply Marks in a PDF+ file. Marks are not supported in Normalized PDF files.

The Marks in your document are shown in the **Marks** section of the Side Panel.



The Marks list shows all Marks in your document. The **Type** icon indicates what type of Mark it is: a Custom Mark, Point Text Mark, Area Text Mark, Repeat for Separations Mark, Repeat by Count Mark, Grid Mark, Cut Mark, Bearer Bar Mark, Clip Mark, Barcode Mark, External File Mark, Position Mark, Resize Mark or a Station Number Mark.

The Marks list will also show **Nested Marks**, i.e. Marks used as content for another Mark. See [Nested Marks](#) on page 323

- Click the Selection icon in front of a Mark name to select the Mark in your document, e.g. to change its color or position. See [Mark Types and their properties](#) on page 293
- Double-click a Mark to change its name
- Click the **Load Mark Set** button  to load a Mark Set, or the **Save/Delete Mark Set** button  to save, delete or overwrite a Mark Set. See [Working with Mark Sets](#) on page 321
- Click the **Update Marks** button  to trigger an immediate update of all Marks.
- Click the **Create Mark from current selection** button  to create a Mark based on the current selection. See [Create a Mark from Selection](#) on page 292
- Click the **+** button to create a **Standard Mark**. See [Create a Standard Mark](#) on page 293
- Select a Mark in the list and click the **-** button to delete the Mark.
- Select **Delete all Marks** from the fly-out menu to remove all Marks in the document.
- Marks can be **expanded** into 'normal' objects. See [Expand](#) on page 139

**Important:** It is strongly advised to only expand ALL Marks at the same time. Expanding one or more Marks separately might give unexpected results.

## 10.1. Create a Mark from Selection

---

You can create a Mark based on the selected object(s)

1. Select the object(s) you want to convert into a Mark
2. Click the **Add Mark** button  and choose the type of Mark you want to create.
  - **Create Custom Mark from Selection:** See [Custom Mark](#) on page 293
  - **Create Point Text Mark from Selection** and **Create Area Text Mark from Selection** is only available if you have one single text object selected. See [Point Text Mark and Area Text Mark](#) on page 294
  - **Create Repeat for Separations Mark from Selection** creates a Repeat for Separations Mark using the selected objects and Marks. See [Repeat for Separations Mark](#) on page 299
  - **Create Repeat by Count Mark from Selection** creates a Repeat by Count Mark using the selected objects. See [Repeat by Count Mark](#) on page 304
  - **Create Repeat for Grid Mark from Selection** to create a Repeat for Grid Mark using the selected objects. See [Repeat for Grid Mark](#) on page 306. This option is only available if the document contains a Grid. See [Grid Step & Repeat](#) on page 268
  - **Create Repeat for Stations Mark from Selection** to create a Repeat for Stations Mark using the selected objects. See [Repeat for Stations Mark](#) on page 315
  - **Create Repeat for Placeholder Mark from Selection** to create a Repeat for Placeholder Mark using the selected objects. See [Repeat for Placeholder Mark](#) on page 307
  - **Create Cut Mark from Selection** creates a Cut Mark using the selected objects. See [Cut Mark](#) on page 308
  - **Create Bearer Bar from Selection** creates a Bearer Bar using the selected objects. See [Bearer Bar Mark](#) on page 308
  - **Create Clip Mark from Selection** creates a Clip Mark using the selected objects. See [Clip Mark](#) on page 309
  - **Create Barcode Mark from Selection** creates a Barcode Mark using the selected barcode. See [Barcode Mark](#) on page 312
  - **Create Dimensions Mark from Selection** creates a Dimensions Mark using the selected objects. See [Dimensions Mark](#) on page 312
  - **Create External File Mark from Selection** creates an External File Mark from the selected placed and linked PDF. See [External File Mark](#) on page 313
  - **Create Position Mark from Selection** creates a Placeholder Mark using the selected objects. See [Position Mark](#) on page 313
  - **Create Resize Mark from Selection** creates a Resize Mark using the selected objects. See [Resize Mark](#) on page 314
  - **Create Plate ID Mark from Selection** creates a Plate ID Mark using the selected objects. See [Creating a Plate ID Mark](#) on page 289

The selected objects will be put in one single group, and become a Dynamic Mark. The properties of the newly created Mark will be based on the objects used to create it.

**Note:** At first, the screening of a Mark will be based on the screening of the Mark content. However, you can change the Screen Set of the Marks using the Screen Set Inspector. See [Applying a Screen Set to an object](#) on page 246

## 10.2. Create a Standard Mark

---

By clicking the **+** button in the Marks section, you can create a **Standard Mark**. A Standard Mark is a Mark using predefined shapes.

Click the **+** button and choose the type of Mark you want to create.

- **Add Repeat for Grid Mark** creates a standard Repeat for Grid Mark. See [Repeat for Grid Mark](#) on page 306. This option is only available if the document contains a Grid. See [Grid Step & Repeat](#) on page 268
- **Add Cut Mark** creates a standard Cut Mark. See [Cut Mark](#) on page 308
- **Add Bearer Bar** creates a standard Bearer Bar. See [Bearer Bar Mark](#) on page 308
- **Add Dimensions Bar** creates a standard Dimensions Mark. See [Dimensions Mark](#) on page 312
- **Add External File Mark** creates an External File Mark. See [External File Mark](#) on page 313
- **Add Position Mark** creates a standard Position Mark. See [Position Mark](#) on page 313
- **Add Input File Mark** is only available when working on a Report Template. See [Input File Mark](#) on page 68

## 10.3. Mark Types and their properties

---

The properties of a selected Mark can be set in different places:

- The **Mark Inspector** will contain specific settings for Marks. You can e.g. define the color(s) of the Mark or set the dynamic text in a Text Mark. The Mark Inspector also shows a preview of the Mark content.
- The **Transformation Inspector** allows to change the positioning and repeat of the Mark. See [Mark positioning](#) on page 318

All of these settings depend on the type of the selected Mark.

**Note:** At first, the screening of a Mark will be based on the screening of the Mark content. However, you can change the Screen Set of the Marks using the Screen Set Inspector. See [Applying a Screen Set to an object](#) on page 246

### 10.3.1. Custom Mark

A **Custom Mark** can be any shape or object you select and convert into a Mark.

- By default the color of a Custom Mark will be **Dynamic** when created, but in the **Mark Inspector** you can select **Dynamic**, **Static**, **Darkest Color** or **Registration Color**, both for the Fill as for the Stroke. See [Colors and Separations in a Mark](#) on page 317.
- Using the **Edit Content** button, you can edit the shape of the Mark. See [Editing a Mark](#) on page 322. You can also double-click the Mark while holding the Alt key.
- In the **Transformation Inspector** you can set the positioning of the Custom Mark. See [Mark positioning](#) on page 318

### 10.3.2. Point Text Mark and Area Text Mark

When creating a Mark from Selection while you only have a text element selected, you can create a **Point Text Mark** or an **Area Text Mark**.

- If you create a **Point Text Mark**, text is positioned on a single point, either left aligned, right aligned or centered. Text is put on one line, unless a hard return is added (using Shift - Enter).
- If you create an **Area Text Mark**, the text box is part of the Mark, and will be used when filling the Mark. Text can reflow inside the text box.

**Note:** If you use the **Transform** tool on a **Point Text Mark**, you can scale the actual text. If you use the **Transform** or the **Text** tool on an **Area Text Mark** you can change the text box, without changing the properties of the text.

- For an **Area Text Mark** you can use the **Fit Text** option to define what to do when the text doesn't fit the text box. When set to "Wrap Lines Then Shrink", the text lines will be wrapped to fit the text box. If the text still doesn't fit in the text box, the text will be scaled down. When set to "Shrink Lines Then Wrap", the text will be scaled down to fit the text box. If the text still doesn't fit in the text box, the text lines will be wrapped.

**Note:** Scaling down the text is done by first reducing the horizontal size to 80%, then by reducing the point size to the **Minimum Font Size**.

- By default the color of a Text Mark will be **Dynamic** when created, but in the **Mark Inspector** you can select **Dynamic**, **Static**, **Darkest Color** or **Registration Color**, both for the Fill as for the Stroke. See [Colors and Separations in a Mark](#) on page 317.
- In the **Transformation Inspector** you can set the positioning of the Text Mark. See [Mark positioning](#) on page 318

The complete Text Mark will have the same formatting, based on the formatting of the first character. Use the **Text Inspector** to change the properties.

The text in a Text Mark can't be changed using the Text Tool. Instead, it can be set in the **Mark Inspector**.

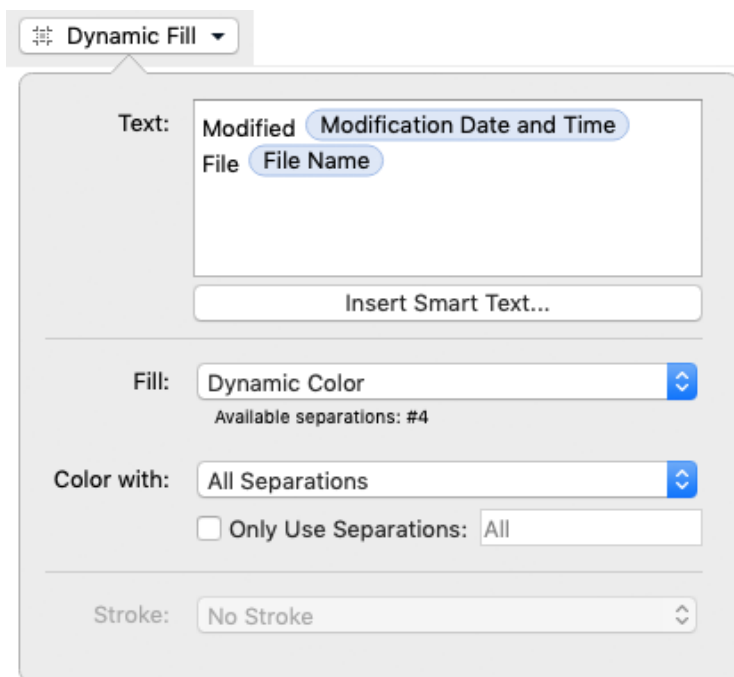

You can modify the (static) text, and you can add dynamic text or **Smart Text**. See [Using Smart Text](#) on page 295

## Using Smart Text

1. Place your cursor where you want the variable to be, or select the text to replace with a variable. Click the **Insert Smart Text...** button.
2. In the **Insert Smart Text** dialog that opens, choose the fields to insert:
  - a) Select **Document** to select variables from the local file, **System** to select variables from your system information, or **Server** to use SmartNames from the Automation Engine server. In that case, all database queries defined on the server will be available, as well as all job and product parameters.  
See also [The Variables](#) on page 296
  - b) Choose a field **Category**, for example **Barcodes, Date & Time...**
  - c) In that **Category**, choose the **Field** you want to use. You can enter a **Search key** to find the Variable you're looking for.
  - d) If applicable, choose the **Format** to use for your chosen **Field** (see [Formatting Dynamic Fields](#) on page 297 for details),

**Note:** The **Preview** line shows how the field will be resolved in the current document.

- e) When your field is completely set up, click **OK**.

The dynamic parts of a text object will appear as a gray block with white text.

3. Most but not all Smart Text Variables are updated live. There is e.g. no live update if you are using the ink coverage variable, if you are using the modification time variable or if a value of a server variable is changed on the server side. To trigger an immediate update, you can use the **Update Marks**  button.

## The Variables

How variables are resolved into actual values depends on the context of the document in which the variables are used.

### Document Variables

The **Document** variables provide information about the document itself, such as the number of separations, the size of the page boxes, the barcodes used in the document, etc.

These variables are independent of where the file is stored or where it is opened.

### System

The **System** variables provide information about the System on which the document is being edited: the ArtPro+ version, the operating system, the user, ...

Opening a document on a different system or by a different user can result in different System information.

### Server

The **Server** variables provide information as returned by the Automation Engine Server you are connected to.

The Preview in the **Insert Smart Text** dialog shows the values as returned by the server. When used in a Mark, the variable will only resolve to that value if the context is correct.

If you for example use a variable from the Job Information category, a preview value can only be returned by the server if your current document is located inside an Automation Engine Job.

### Job Parameters, Product Parameters and Workflow Parameters

To select a Job Parameter, Product Parameter or Workflow Parameter, you have to browse to a specific Job, Product or Workflow.



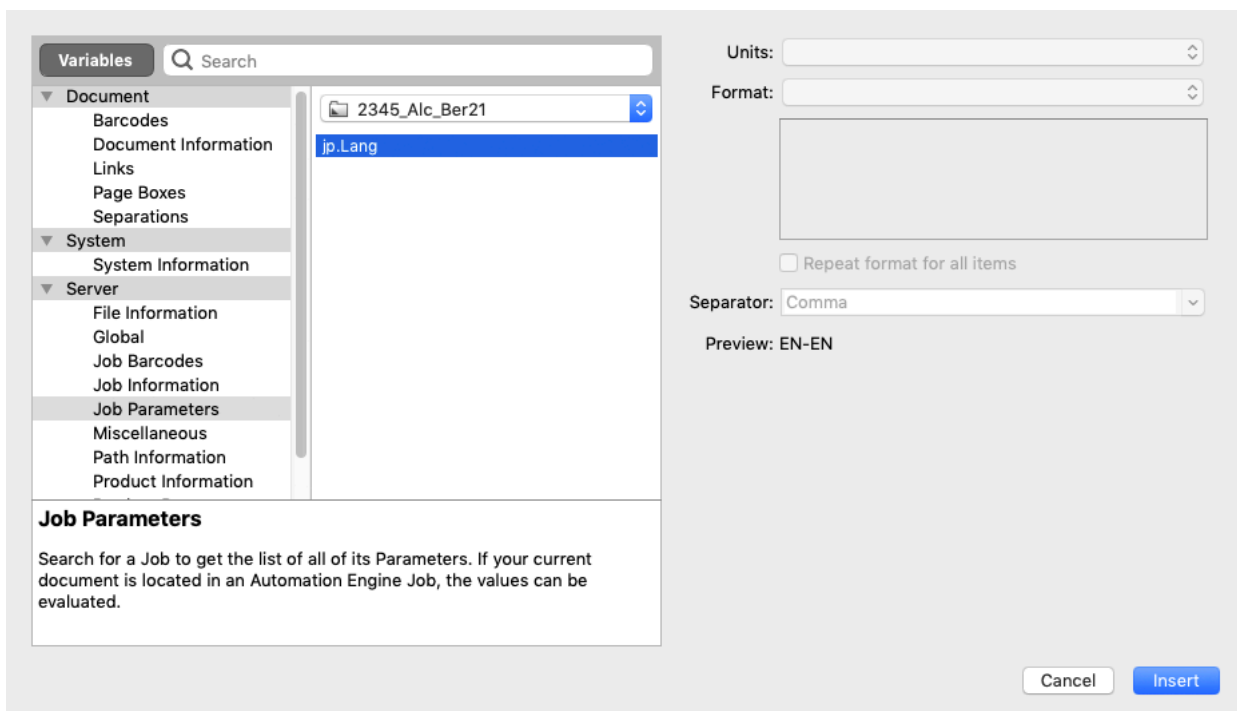

The **Preview** line will show the value for the Job, Product or Workflow you chose when selecting the parameter.

However, these Parameters can only be resolved in your ArtPro+ document itself if the document on which the Mark is applied is located in that particular Job or Product. If your document is in a different Job or Product, the variable might return empty.

Workflow Parameters can only be resolved in an automated workflow, as it requires Automation Engine context.

**Note:** When these Parameter variables are used in a Station Numbering Mark, the Parameters are resolved according to the context of the **stations**, i.e. the Job or Product the one-ups are part of, and not the context of the MFG.

## Formatting Dynamic Fields

You can format certain fields so they look a certain way (for example, have the date in European or American format).

You can use predefined formats or create custom formats. You can also choose to use a different format for each field, or the same format for all fields.

### Using an Existing Format

- You can choose an existing format to apply to your field in the **Format** list.

For example, use **[name][ext]** to display the file name and extension when using the **File Name** field.

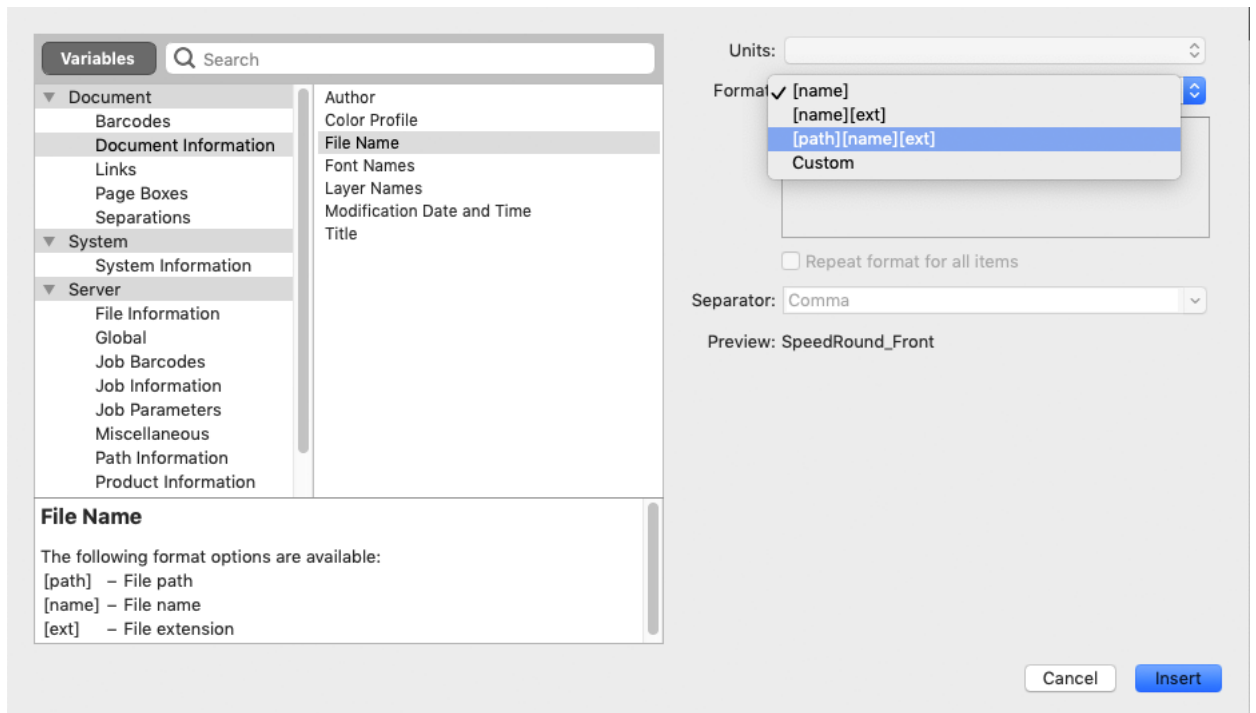

### Repeating the Format for All Items

If the field you want to use can have several values (e.g. **Fonts, Ink Names, Placed Files...**), you can put them all in one dynamic object.

You can also set the same format for all those values at once.

After choosing an existing format or defining a custom one:

1. Select **Repeat format for all items**.
2. Choose the **Separator** you want to use between the values (**Comma, Space...**).

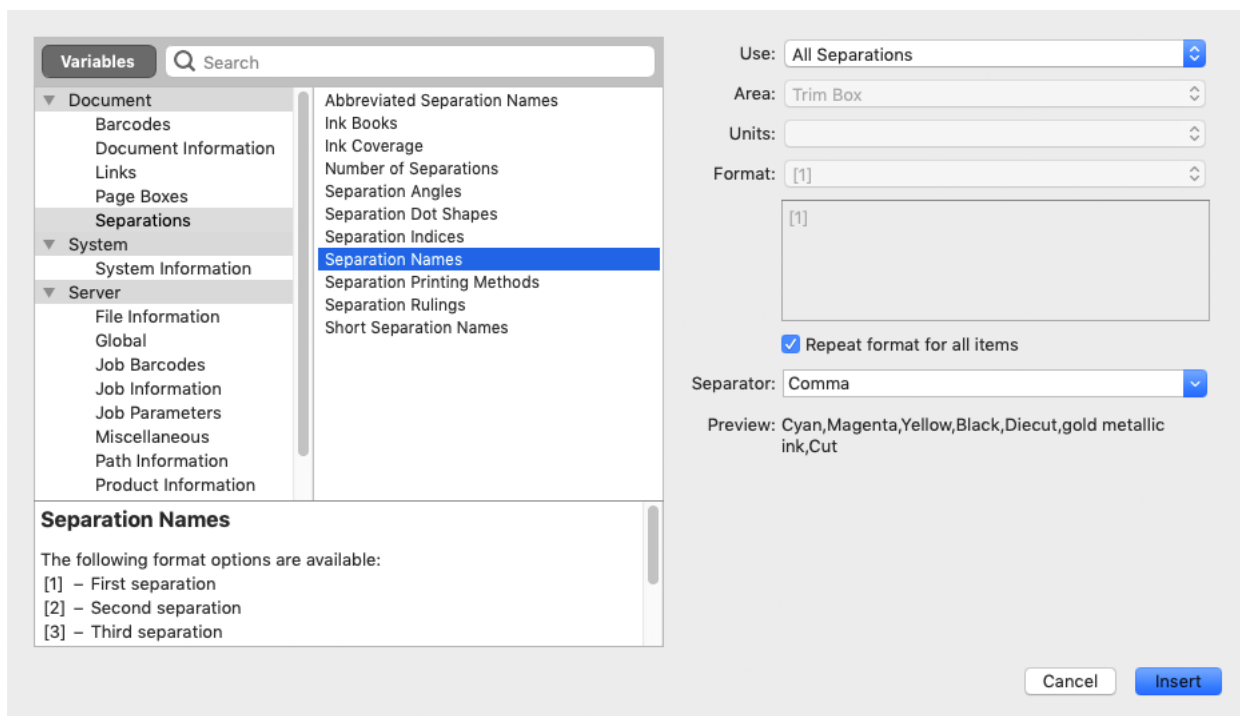

**Note:** You can also specify your own separator by typing it directly in the **Separator** list.

3. When you are satisfied with what you see in the **Preview**, click **Insert**.

### 10.3.3. Repeat for Separations Mark

A Repeat for Separation Mark is a type of Dynamic Mark that is repeated a number of times, based on the inks used in the document. You can load one of the default Repeat for Separations Mark sets (see [Working with Mark Sets](#) on page 321) or you can create a Repeat for Separations Mark by selecting a combination of objects and select **Create Repeat for Separations Mark from selection** (see [Create a Mark from Selection](#) on page 292). The selected objects become the Mark Content, which is repeated for every separation.

The **Repeat for Separations** Mark can contain nested Marks. See [Nested Marks](#) on page 323

**Note:** If you include a Text Mark with Smart Text in a Repeat for Separations Mark, the Barcode and Layer Names variables will be discarded.

You can for example create a Custom Mark of a 100% filled square, and a Text Mark containing the Ink Name of the 1st separation as Smart Text. Combining those two into a **Repeat for Separations** Mark, you can create a color patch for each separation, with the respective separation name next to it.

- Cyan
- Magenta
- Yellow
- Black
- PANTONE Reflex Blue C
- PANTONE Purple C

Use the **Mark Inspector** to set all parameters.

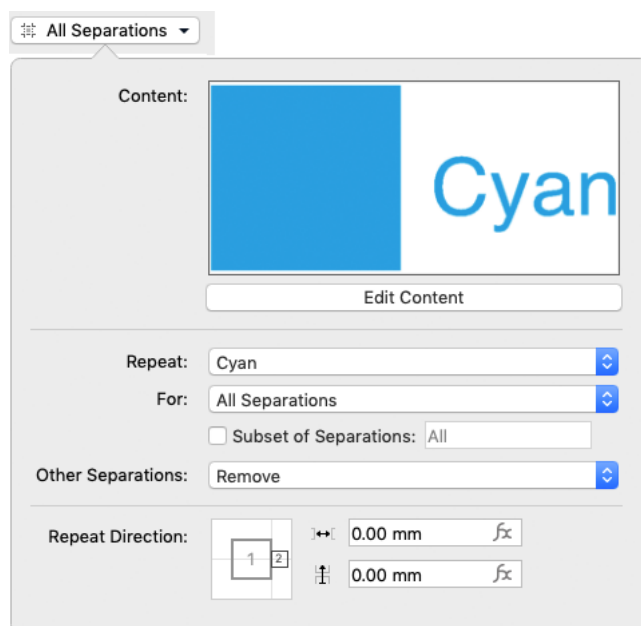

- Underneath a preview of the Mark Content is the **Edit Content** button. If you want e.g. to edit the Text Mark included in the Repeat for Separations Mark, you can click the **Edit Content** button. See [Editing a Mark](#) on page 322. You can also double-click the Mark while holding the Alt key.

**Note:** When editing the content of a Repeat for Separations Mark, you can't change the color of included Text Marks or Custom Marks to Dynamic Color or Darkest Color, these will always use Static color.

- In case your selection contained more than one separations when creating the Mark, you can use the **Repeat** dropdown to select the separation you want to use in your Mark.
- By default the Repeat for Separations Mark will create one Mark for every separation on the page. Use the **For** dropdown to choose what separations to include:
  - All Separations
  - Artwork Separations
  - Artwork Separations and Varnish
  - Processing Step Separations (See [Processing Step Layers](#) on page 97)

- Enable **Subset of Separations** to select specific separations from the result of the **For** setting above, based on the index. You can enter for example "1-6", or "3,4,6", or "1,4-6". If the **Subset of Separations** is disabled, all separations defined using the **For** setting will be included.
- **Other separations** defines what to do with the other separations in your content: either remove, keep as Static color, or map to the darkest separation.

In the example underneath, the original object had a fill in Cyan and a stroke in Magenta. The result for the various settings in a CMYK + Pantone Orange document will look like this:

1. Original
2. Repeat: Cyan, Other Separations: Remove
3. Repeat: Cyan, Other Separations: Static
4. Repeat: Magenta, Other Separations: Map to Darkest

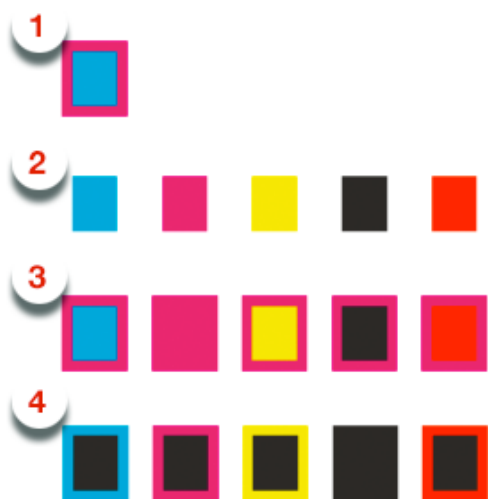

**Tip:** It is advised to keep the Mark content as simple as possible. Using the same separation for all of the included objects is recommended.

### Positioning the Repeat for Separations Marks

The positioning of the Repeat for Separations Marks is set by three different factors:

- **1.** The relative positioning of the objects within the Mark Content. It is recommended to make the positioning of Marks within the content dynamic by attaching them to each other.  
This can be done either before creating the Mark, or by using Edit Content. See [Editing a Mark](#) on page 322  
In the example underneath, the distance between the square and the text is set in the Mark Content
- **2.** The **Repeat Direction**, which defines the direction, positioning and offset / gap of the different instances of the Mark. See [Repeat Direction](#) on page 302  
In the example underneath, the distance between the cyan instance and the magenta instance is defined in the **Mark Inspector** in the **Repeat Direction**.
- **3.** In the **Transformation Inspector** you can set the positioning of the complete Repeat for Separations Mark, i.e. the complete block of all instances. See [Mark positioning](#) on page 318

In the example underneath, the position of the complete Mark (attached to the Trim Box) is defined in the Transformation Inspector.



### Repeat Direction

When using a Repeat for Separations Mark, an instance of the Mark Content is created for every separation.

In the **Repeat Direction**, you can set how the next instance (indicated by "2") is attached to the previous one (1). This defines the direction, order and distance.

**Note:** If you want to change the positioning of the elements within one instance (e.g. to attach one of the enclosed Marks to another one), you need to **Edit** the content of the Mark.

#### 1. Using a GAP distance

If you attach the "2" square on the outside of the "1" square, the different instances are placed next to or above / below each other. The position of the square defines both the order as the direction.



Repeat direction	Positioning of the instances
"2" square on the <b>left</b> side of the "1" square	horizontal, ordered from right to left
"2" square on the <b>right</b> side of the "1" square	horizontal, ordered from left to right
"2" square <b>on top</b> of the "1" square	vertical, ordered from bottom to top
"2" square <b>below</b> the "1" square	vertical, ordered from top to bottom

Within that location, the exact position defines the **alignment** of the instances.

Example: in both examples, the "2" square is placed below the "1" square, so the instances are placed vertically, ordered from top to bottom. You can see the difference in alignment:

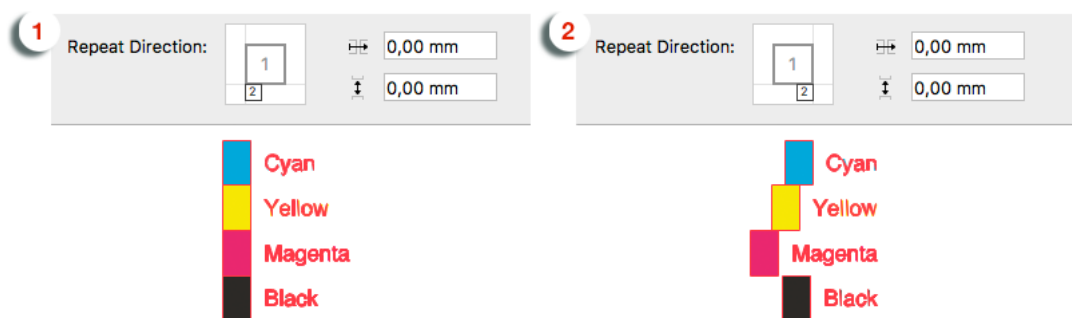
1. aligned on the left side
2. aligned on the right side



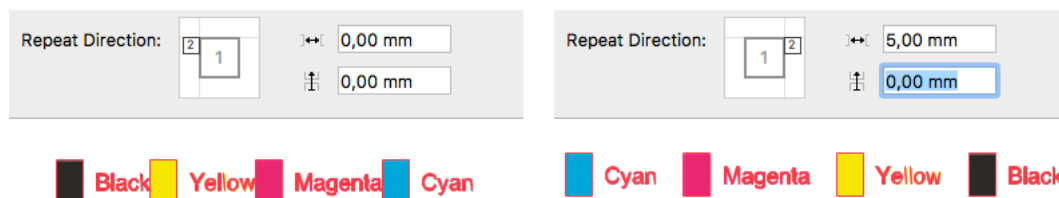

You can add a **Gap** distance, either vertically  or horizontally  that will be added in between the different instances.

Example: in the left example, the "2" square is placed on the left side, with no gap. In the right example, it's placed at the right side, so the order is changed, and a gap was added.



## 2. Using a STEP distance

If you place the "2" square inside the "1" square, the different instances are placed on top of each

other. You can set a **Step Distance** to move the instances horizontally  or vertically . A positive distance will move the next instance to the right or up, a negative distance to the left or down. You can change the order by using a negative step distance.



**Attention:** When using a Step distance, the size of the different instances is not taken into account. This can cause instances to overlap, e.g. for long separation names.

Example 1: the instances are aligned on the left side, with a 100mm distance. Note that if an ink name is longer than that distance, the text might run over another instance.

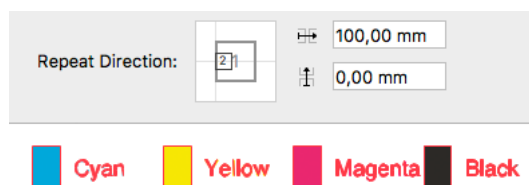

Example 2: the instances are centered, with a 40mm vertical distance. You can see that a positive distance places the next instance above the previous (left), while a negative value places the next instance below the previous.



**Note:** If you use a Repeat for Separation Mark to create a new Mark, the contents will be expanded, and if it contained a Text Mark with variable text, it will become static text.

### 10.3.4. Repeat by Count Mark

A Repeat by Count Mark is a type of Dynamic Mark that is repeated a number of times, based on the setting in the Mark inspector. You can create a Repeat by Count Mark by selecting a combination of objects and select **Create Repeat by Count Mark from selection** (see [Create a Mark from Selection](#) on page 292). The selected objects become the Mark Content, which is repeated.

The **Repeat by Count Mark** can contain nested Marks. See [Nested Marks](#) on page 323

You can for example create a **Repeat for Separations Mark** with a color patch for each separation, and then include this in a Repeat by Count Mark to repeat the Repeat for Separations Mark a number of times.

Use the **Mark Inspector** to set all parameters.



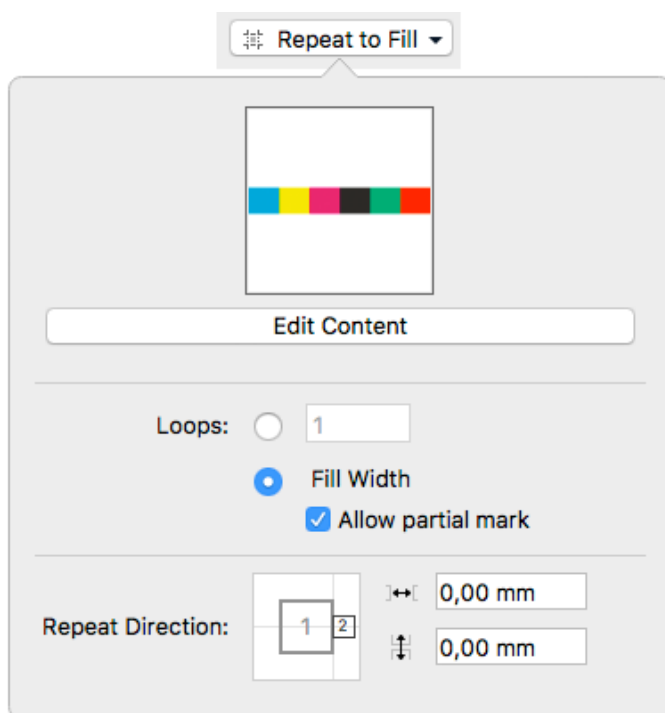

- Underneath a preview of the Mark Content is the **Edit Content** button. If you want e.g. to edit the Point Text Mark included in the Repeat for Count Mark, you can click the **Edit Content** button. See [Editing a Mark](#) on page 322. You can also double-click the Mark while holding the Alt key.
- Define the number of repeats or **Loops**
  - When the first option is enabled, you can enter the specific number of repeats you want. You can use a **Formula**. See [Formula Editor](#) on page 319. Note that you need a number (without unit). You can e.g. achieve this by using "Trim Box Width / 10mm". The result will be rounded down to an integer.
  - When the **Fill Width** (or Fill Height) option is selected, the Mark contents will be repeated as many times as possible. It will use the Width (or Height) of the Page Box, Grid or Mark the Repeat by Count Mark is attached to in the Transformation Inspector. By default, a Repeat by Count Mark will be attached to the Trim Box.
  - If **Fill Width** is selected, the **Allow partial Mark** option defines if only complete repeats of the Mark Content are allowed, or if the complete width (or height) should be filled, including a partial Mark.
- By positioning the "2" square, you can set the repeat direction: left to right (as in the screenshot), right to left, top to bottom or bottom to top.
- You can add a **Horizontal Offset** and a **Vertical Offset**. The offset in the repeating direction (e.g. Horizontal Offset if repetition is from left to right) adds a **gap** in between the repetitions.

In the example underneath, you can see a Repeat by Count Mark. You can see:

1. the 7 mm gap
2. the partial Mark

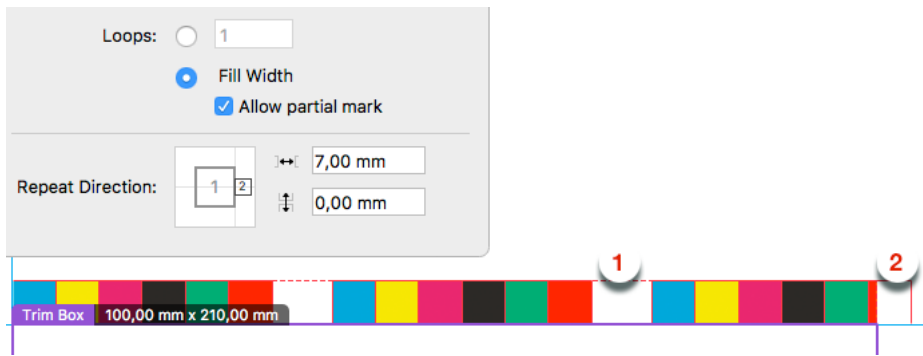

### Positioning the Repeat by Count Marks

The positioning of the Repeat by Count Mark is set by three different factors:

- **1.** The relative positioning of the objects within the Mark Content. You can make the positioning of Marks within the content dynamic by attaching them to each other.  
This can be done either before creating the Mark, or by using Edit Content. See [Editing a Mark](#) on page 322
- **2.** The **Repeat Direction**, which defines the direction, positioning and offset / gap of the different instances of the Mark.
- **3.** In the **Transformation Inspector** you can set the positioning of the complete Repeat by Count Mark, i.e. the complete block of all instances. See [Mark positioning](#) on page 318

### 10.3.5. Repeat for Grid Mark

A Repeat for Grid Mark is a type of Dynamic Mark that positions itself relative to the stations of your step & repeat or Grid.

You can create a Repeat for Grid Mark using your selection (see [Create a Mark from Selection](#) on page 292) or you can create a Standard Repeat for Grid Mark. This will contain a custom mark containing a rectangle of 5 x 5mm, in Darkest Color, and will be positioned on the left side of the grid, repeated for every station.

You can also load the default "Standard 5x5mm Repeat for Grid Mark" Mark Set. See [Working with Mark Sets](#) on page 321. In that case, two Repeat for Grid Marks will be created using a rectangle of 5 x 5mm, in Darkest Color, one positioned on the left and one on the right side of the grid.

The **Repeat for Grid Mark** can contain nested Marks. See [Nested Marks](#) on page 323

You can for example create a **Custom Mark** colored in the **Darkest Color**, and then include this in a Repeat for Grid Mark to repeat the Custom Mark on your grid.

- Using **Repeat for**, you can set on which parts of the grid the Repeat for Grid Marks should be placed; either **Stations**, **Rows** (horizontal only), or **Columns** (vertical only).
- Using the **Horizontally** and/or **Vertically** setting you can define the repetition: all columns/rows, only the first column/row, etc. Using "Custom", you can set it to repeat every x rows or columns.
- Using the **Edit Content** button, you can edit the shape of the Mark. See [Editing a Mark](#) on page 322. You can also double-click the Mark while holding the Alt key.

- In the **Transformation Inspector** you can set the positioning of the Mark. In case the grid is Staggered, an extra dropdown will let you choose to either use each station as reference point, or to use the first or last column/row.

### 10.3.6. Repeat for Placeholder Mark

The **Repeat for Placeholder Mark** is automatically attached to all instances of a Placeholder by the specified name. You can use any Named Object as Placeholder.

This means that if you e.g. attach the **Repeat for Placeholder Mark** to a Named Object named "Position2", the mark will be placed for every named object by that name.

#### MFG and CFF Files

When opening an ArtiosCAD Manufacturing file (.MFG) or a CFF that contains text objects directly in the manufacturing or layout file (so not in the containing one-up (ARD) files), these text objects are imported as Named Objects. When you open such a file, the different text objects will not be visible, as they have no fill or stroke. All imported Placeholders are placed in a new Layer named "Placeholders", and the "Structural Design" layer has been renamed to "Stations".

If you select the objects in the Placeholders layer, you can see where these placeholders are placed. You will also see them by their original name in the **Named Objects Overview** in the **Object Browser**. See [Object Browser](#) on page 99.

These Named Objects can be used to attach a **Repeat for Placeholder Mark**

#### Creating a Repeat for Placeholder Mark

1. Create and select a simple object or a text object
2. Go to **Create a Mark from Selection**
3. Choose **Create Repeat for Placeholder Mark from Selection**

By default, the object is attached to the first **Placeholder** in the list. In the **Transformation** inspector you can attach the object to a different Placeholder, or to a different Named Object.

A **Repeat for Placeholder Mark** is attached to, and so repeated for all instances of a Placeholder or Named Object by the same name. Because of that, the Transformation inspector will only list each name once. If your MFG for example contains 5 instances of a "Text 1" text object and 3 instances of a "Text 2" text object, the Transformation inspector will only list "Text 1" and "Text 2" once. If you attach the Mark to "Text 1", the Mark will be repeated for all 5 instances of the "Text 1" placeholder.

The **Repeat from Placeholder Mark** also supports nesting Custom Marks, Point Text Marks, Area Text Marks and Barcode Marks. See [Nested Marks](#) on page 323

The **Repeat from Placeholder Mark** is also supported as a Mark in Dynamic Tasks on an Automation Engine Server.

**Note:** The Repeat from Placeholder Mark does not replace the Station Numbering Mark. The Station Numbering Mark also relies on placeholders, but those are placeholders set in the one-ups, not directly on the MFG.

### 10.3.7. Cut Mark

A Cut Mark (also known as corner mark or trim mark) is a type of Dynamic Mark, in most cases a line, that is positioned twice (once vertical, once horizontal) on every corner of the selected page box. It is used to align the cutter on printed sheets.

You can create a Cut Mark using your selection (see [Create a Mark from Selection](#) on page 292) or you can create a Standard Cut Mark, which is a line of 10mm, with a stroke of 0.1mm, in Registration Color.

- By default the color of a Cut Mark will be **Registration Color** when created. In the **Mark Inspector** you can select **Static**, **Dynamic** or **Darkest Color**. See [Colors and Separations in a Mark](#) on page 317.
- Using the **Edit Content** button, you can edit the shape of the Mark. In case color is set to Static, you can also edit the color of the Mark. See [Editing a Mark](#) on page 322. You can also double-click the Mark while holding the Alt key.
- In the **Transformation Inspector**, using the **Attach to** dropdown you can define the page box or grid on which you want to apply the Cut Marks, and the **Offset**.

### 10.3.8. Bearer Bar Mark

A Bearer Bar Mark is a type of Dynamic Mark, in most cases a line, that is positioned on the left or right (vertical) or top or bottom (horizontal) of the selected page box, grid or grid column, and stretches over the complete height or width.

Bearer Bars are added in flexography as support, to limit cylinder bouncing during print.

You can create a Bearer Bar Mark using your selection (see [Create a Mark from Selection](#) on page 292) or you can create a Standard Bearer Bar Mark. The Standard Bearer Bar Mark is a rectangle of 5mm wide, on the left side of the Trim Box, stretched over the height of the page box.

- When creating a Bearer Bar Mark using your selection, the Bearer Bar Mark will be horizontal if the width of the selection is bigger than its height. Otherwise, it will be vertical.
- By default the color of a Bearer Bar will be in Registration Color using all Artwork Separations. See [Colors and Separations in a Mark](#) on page 317
- Using the **Edit Content** button, you can also edit the shape of the Mark. See [Editing a Mark](#) on page 322. You can also double-click the Mark while holding the Alt key.
- In the **Transformation Inspector**, you can set the positioning and height settings of the Bearer Bar. See [Bearer Bar Mark Properties](#) on page 308

#### Bearer Bar Mark Properties

If you have a Bearer Bar Mark selected, the Transformation Inspector will contain some specific properties.

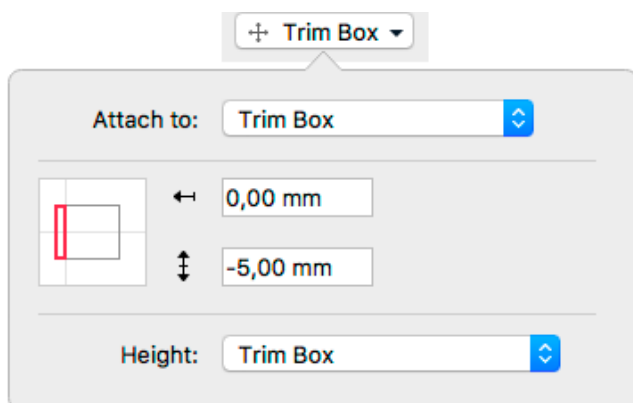

**Attach To:** upon creation, Bearer Bar Marks will be automatically attached to the Trim Box, but you can attach the Bearer Bar to any page box, Grid or Named Object.

You can place the Bearer Bar on the left side, right side, top or bottom.

Using the **Offset** field, you can define the offset between the page box or grid, and the Bearer Bar.

The **Height** for a vertical Bearer Bar can be defined by the height of the Trim Box or the Named Object the Mark is attached to, the leftmost or rightmost Grid, or the leftmost or rightmost Grid Column. Grid Column can be useful in case of Staggered grid, since the columns can have a different height and vertical position. See [Stagger](#) on page 271

The **Width** for a horizontal Bearer Bar can be defined by the width of the Trim Box or the Named Object the Mark is attached to, the topmost or bottommost Grid, or the topmost or bottommost Grid Row. Same as for the Height, Grid Row can be useful in case of Staggered grid, since the Rows can have a different width and horizontal position. See [Stagger](#) on page 271

The height can be adjusted by entering a value in the **Bearer Bar Extend** field . A positive value will be added to the height (top and bottom), a negative value will make the Bearer Bar smaller in the same way.

**Note:** If you are looking for more flexibility in defining the width and height, you could use a Resize Mark instead. See [Resize Mark](#) on page 314

### 10.3.9. Clip Mark

A Clip Mark is a type of Dynamic Mark that clips its content, based on the setting in the Mark inspector. You can create a Clip Mark by selecting a combination of objects and select **Create Clip Mark from selection** (see [Create a Mark from Selection](#) on page 292). The selected objects become the Mark Content, which will be clipped.

**Note:** ArtPro+ contains a number of Standard Clip Marks optimized for 5 by 5 mm patches. See [Clipping a control strip](#) on page 310 and [Working with Mark Sets](#) on page 321

The **Clip Mark** can contain nested Marks. See [Nested Marks](#) on page 323

Use the **Mark Inspector** to set all parameters.

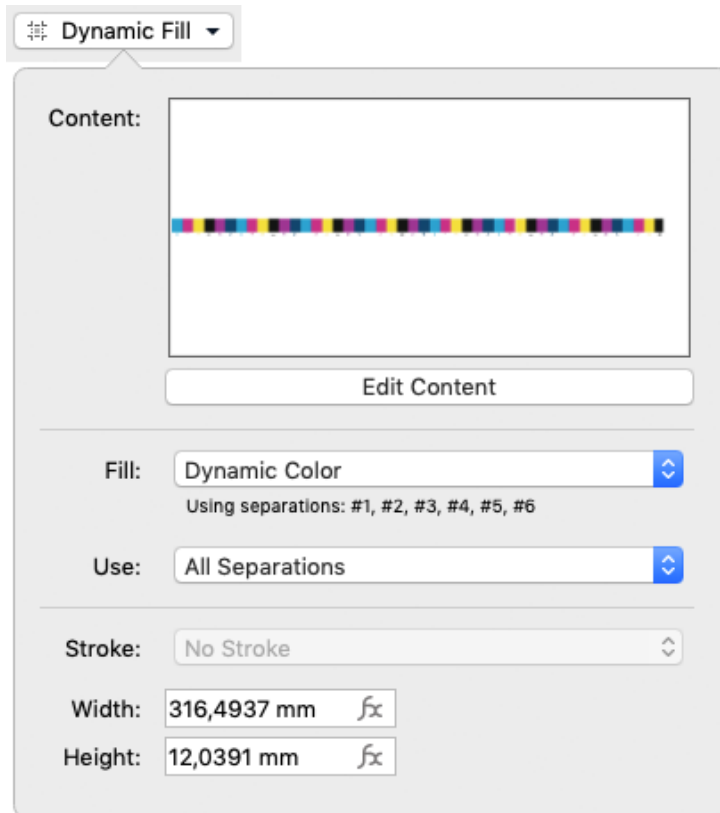

- Underneath a preview of the Mark Content is the **Edit Content** button. If you want e.g. to edit the Point Text Mark included in the Resize Mark, you can click the **Edit Content** button. See [Editing a Mark](#) on page 322. You can also double-click the Mark while holding the Alt key.
- By default the color of a Bearer Bar will be in Dynamic Color using all Separations. See [Colors and Separations in a Mark](#) on page 317
- Define how to **Clip**:
  - **Width**: the content is clipped to the entered width. You can use a **Formula** to define the width. See [Formula Editor](#) on page 319
  - **Height**: the content is clipped to the entered height. You can use a **Formula** to define the height. See [Formula Editor](#) on page 319

**Note:** Clipping is always done from the center of the content.

### Clipping a control strip

A Clip Mark can be used to clip a Marks file or control strip as provided to you by e.g. a Press Manufacturer to allow precise measurements. These Marks files or control strips typically consists of a number of square patches, text and other objects. This band of patches will then be clipped to the size of your document.

Using the correct formulas, you can ensure clipping is only done so that only full square patches are used.

1. Open the supplied file, containing objects, text and squares.
2. Select all these objects, and in the Marks section, choose **Create Clip Mark from selection** (see [Create a Mark from Selection](#) on page 292). The selected objects become the Mark Content.
3. Define these options and values:

**Note:** these options correspond to the settings in the Clip Mark in ArtPro+ 18.1 and earlier. Opening a file containing a Mark created in this version will automatically have the correct formula applied.

- The **Reference Object**: in most cases, you will want to use the page box width.
- The **Step Distance** should match the size of the square patches
- The **Center** is **Even** if the Mark contains an even number of steps, so the center will be located in between the two middle rectangles. If the Mark contains an odd number of steps, the **Center** is **Odd** so the center will be located on the middle of the rectangle in the middle.
- The **End Steps** settings define if partial patches should be removed or added. In the example underneath you see the difference between 1. **Add** and 2. **Remove**, with correct Step Distance and Center settings.

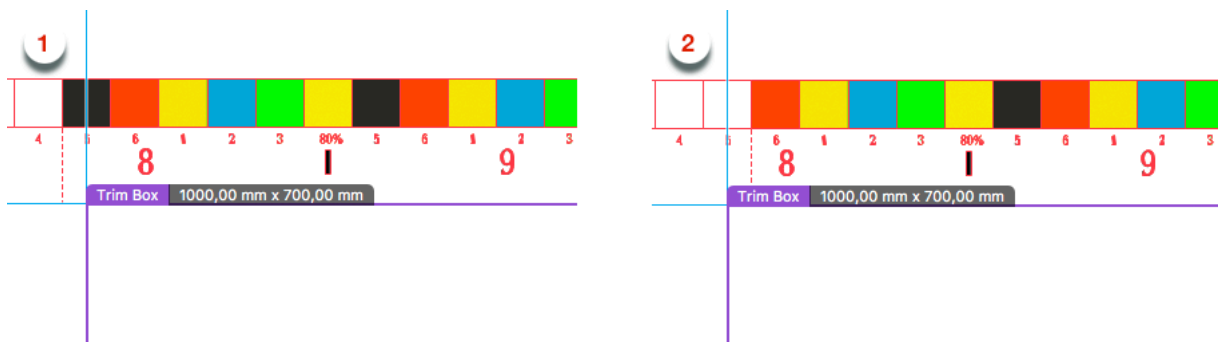

4. Choose the correct formula for the **Width** to clip the Mark content:

Number	End Steps	Formula
Even	Add	$(\text{EVEN}((\text{Reference Object Width} / \text{Step Distance})) * \text{Step Distance})$
Even	Remove	$(\text{FLOOR}((\text{Reference Object Width} / \text{Step Distance}); 2) * \text{Step Distance})$
Odd	Add	$(\text{ODD}((\text{Reference Object Width} / \text{Step Distance})) * \text{Step Distance})$
Odd	Remove	$(\text{FLOOR}((\text{Reference Object Width} / \text{Step Distance}) - 1; 2) + 1) * \text{Step Distance}$

**Note:** Replace **Step Distance** with the actual Step Distance you want to use. Use a Variable to enter the Reference Object Width.

**Note:** In case you have a vertical control strip, use the **Reference Object Height** instead of the width, and use the formula to define the **Clip Height**

**Note:** ArtPro+ contains a number of Standard Clip Marks that provide the same Even/Odd, Add/Remove options for 5 by 5 mm patches. See [Working with Mark Sets](#) on page 321

### 10.3.10. Barcode Mark

A Barcode Mark is a Mark that uses a [Code 128](#), [QR](#), [Micro QR](#), [Data Matrix](#), [Laetus Pharma](#) or [PZN](#) barcode. It can be used to add technical information about the job in an automated workflow.

You can create a Barcode Mark by selecting a barcode of a supported type (see above) and choosing **Create Barcode Mark from Selection** (see [Create a Mark from Selection](#) on page 292)

Use the **Mark Inspector** to set all parameters.

- The **Code** shows the text that will be used in the Barcode Mark.
- You can use **Insert Smart Text...** to use variables in the Code. See [Using Smart Text](#) on page 295. The Preview on the Mark inspector shows the resulting value of the Code with all of its variables.
- A Barcode Mark can use **Darkest Color**, **Registration Color** or **Static Color**. See also [Colors and Separations in a Mark](#) on page 317. When using Static Color, you can change the color using the Fill Color Inspector. See [Fill Color and Stroke Color Inspector](#) on page 143. You can create multicolor barcodes for the barcode types that support it (such as Laetus Pharma). See [Multicolor barcodes](#) on page 232

**Note:** If you want a multicolor Barcode Mark to update dynamically when the document separations are modified, you should set the barcode to multicolor, and then switch the color setting of the Barcode Mark to Registration Color setting. The Multicolor Barcode Mark will then be dynamically filled, based on the **Use** setting and the document separations list.

- For Data Matrix, QR and MicroQR barcodes: If the **Use Smallest Possible Symbol Size** is enabled, the Barcode Mark will be resized to the smallest possible symbol size, depending on the length of the Code. You will not be able to set the Minimum Symbol Size parameter in the Barcode inspector. If the option is disabled, the size of the Barcode Mark can be increased if needed depending on the length of the Code, but it will not decrease below the Minimum Symbol Size set in the Barcode inspector.

**Notes and Restrictions:**

The Code used inside the Barcode Mark has to meet the requirements of a valid barcode of the selected type.

It is possible that a valid Barcode Mark becomes invalid if the value of a variable changes. In this case, the Mark becomes invalid or empty, and a Message is shown in the Messages drawer. See [Error Messaging for Marks](#) on page 324

### 10.3.11. Dimensions Mark

A Dimensions Mark adds dimensions to a page box, Step & Repeat grid or a named object (e.g. another mark). This works the same way as the **Add Dimensions** tool. See [Add Dimensions](#) on page 236 .

If you have Dimension Lines created by the **Add Dimensions** function selected (and nothing else), you can create a Dimensions Mark using your selection (see [Create a Mark from Selection](#) on page 292).

You can also create a Standard Dimensions Mark, which is attached to the Trim Box.



In the **Dimensions inspector** you can set the same parameters as for **Add Dimensions**. See [Add Dimensions](#) on page 236

If the reference object or page box is changed, the Dimensions Mark is updated automatically. If the reference object or page box is deleted, the Dimensions Mark becomes attached to the Trim Box.

### 10.3.12. External File Mark

An External File Mark is a Mark that uses a linked placed PDF.

You can create an External File Mark from a selected linked placed art object by using **Create External File Mark using Selection** (see [Create a Mark from Selection](#) on page 292) or you can use **Add External File Mark** to create an empty External File Mark. You can then open the Mark inspector and either browse to a valid PDF file or enter a valid URL that points to the external file to use.

Use the **Mark Inspector** to set all parameters.

- The **URL** shows the location of the external file to be used. A valid URL is in this format: `file://host/path`, using forward slashes. Relative paths can also be used, e.g. `../..../mark/markfile.pdf`
- Use the **Browse...** button to browse to the external file you want to use. The URL will be entered automatically.
- You can use **Insert Smart Text...** to use variables in the URL. See [Using Smart Text](#) on page 295
- By default, the **Fill** and **Stroke** will be set to **Static Color**, so the exact same colors (and inks) as in the external file are used. You can however switch to e.g. "Darkest" to recolor the content of the external file. Note that gradients, images and patterns will not be recolored. See [Colors and Separations in a Mark](#) on page 317

#### Notes and Restrictions:

- Only PDF files can be used as External File Marks.
- Editing and saving the external file will NOT automatically update the Mark. Use the **Update Marks**  button to synchronize.
- When using a multipage PDF as External File Mark, only the first page is used.
- When using **Create External File Mark from Selection**, the External File Mark will use the bounding box of all printable content in the file, i.e. the bounding box of all elements in printing layers. It is possible that previously invisible objects become visible, and the external file might move since the bounding box can be different.
- You can not shear or scale an External File Mark. Moving and rotating is allowed.

### 10.3.13. Position Mark

A Position Mark is a Mark without any color or contents. You can set its size and position using fixed dimensions or formulas, and attach other Marks to the Position Mark .

You can create a Position Mark using your selection (see [Create a Mark from Selection](#) on page 292) or you can create a Standard Position Mark, which is an empty rectangle of 10 x 10 in the current length unit, positioned at the top left of the Trim Box.

If you create a Position Mark from a selection, the bounding box of the selection is used to define the position and size of the Position Mark. Any color or contents is discarded.

Use the **Mark Inspector** to set the width and height. Use the **Transformation Inspector** to set the vertical and horizontal position. In both inspectors, you can use formulas. See [Formula Editor](#) on page 319

### 10.3.14. Resize Mark

A Resize Mark is a type of Dynamic Mark that is resized either vertically or horizontally, based on the setting in the Mark inspector. You can create a Resize Mark by selecting a combination of objects and select **Create Resize Mark from selection** (see [Create a Mark from Selection](#) on page 292). The selected objects become the Mark Content, which is resized.

The **Resize Mark** can contain nested Marks. See [Nested Marks](#) on page 323

Use the **Mark Inspector** to set all parameters.

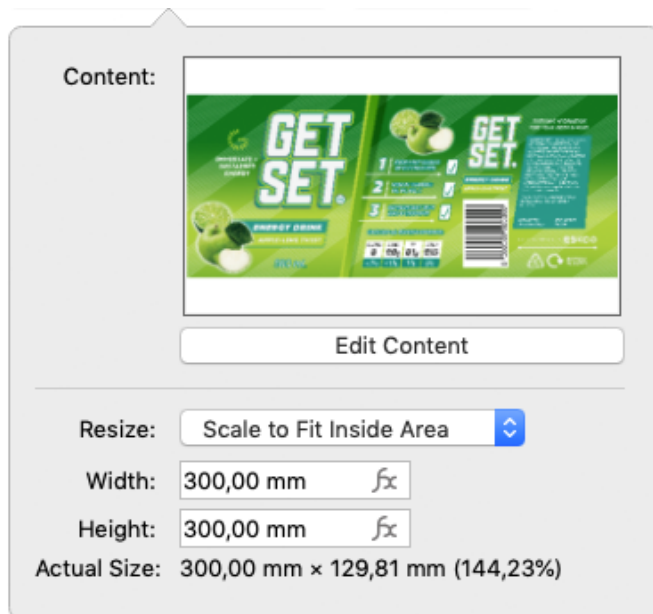

- Underneath a preview of the Mark Content is the **Edit Content** button. If you want e.g. to edit the Point Text Mark included in the Resize Mark, you can click the **Edit Content** button. See [Editing a Mark](#) on page 322. You can also double-click the Mark while holding the Alt key.
- Define how to **Resize**:
  - **Stretch Vertically**: the content is stretched to match the entered height. The width is at 100%.
  - **Stretch Horizontally**: the content is stretched to match the entered width. The height is at 100%.
  - **Stretch to Fill Area**: the content is stretched to match both the entered height and width.
  - **Scale to Fit Inside Area**: the content is scaled (up or down) proportionally to fit inside the defined area (width and height).
  - **Shrink to Fit Inside Area**: the content is scaled down proportionally if necessary to fit inside the defined area (width and height). The content is never scaled up.

- When selecting **Scale Relatively** you can enter the scale factor for both vertical and horizontal scaling (in percentage).

**Note:** The **Stretch** options and **Scale Relatively** are non-proportional: the vertical and horizontal scaling factors can be different. The **Scale** and **Shrink** options are proportional: vertical and horizontal scaling factors are the same.

- Define the **Width** or **Height**. You can use a **Formula** to define the size. See [Formula Editor](#) on page 319
- At the bottom of the inspector you can see the actual size of the Resize Mark, including the applied scaling factor (a single percentage for proportional scaling, a scaling factor for vertical and horizontal scaling for non-proportional scaling).

### 10.3.15. Repeat for Stations Mark

In a Step & Repeat workflow, you can add a **Repeat for Stations Mark** on an MFG or CF2 repetition file. It is a type of Dynamic Mark that positions itself relative to a placeholder (most commonly a **StationNumber** placeholder) for every station of your MFG or CF2 step & repeat.

You can create a Repeat for Stations Mark using your selection (see [Create a Mark from Selection](#) on page 292) or you can load the default "Standard Repeat for Stations Mark - Station Number" Mark Set, see [Working with Mark Sets](#) on page 321. In that case, a Repeat for Stations Mark will be created, containing a Point Text Mark using the Station Number as variable, in Darkest Color, positioned centered on the StationNumber placeholder for every station.

The **Repeat for Stations Mark** can contain nested Marks. See [Nested Marks](#) on page 323

- Using the **Edit Content** button in the **Mark Inspector**, you can edit the shape of the Mark. See [Editing a Mark](#) on page 322. You can also double-click the Mark while holding the Alt key.
- In most cases, the Repeat for Stations Mark contains a Point Text Mark, containing the variable "Station Number". You can use the **Mark Inspector** to adjust the text, e.g. to add other SmartText variables next to the Station Number variable. See [Using Smart Text](#) on page 295

**Note:** When using Job and Product Parameters in your Station Numbering Mark, these parameters are resolved according to the context of the stations (so the Job or Product the one-ups are part of) and not the context of the MFG file.

- Using the Text Inspector, you can change the text style of the Point Text Mark

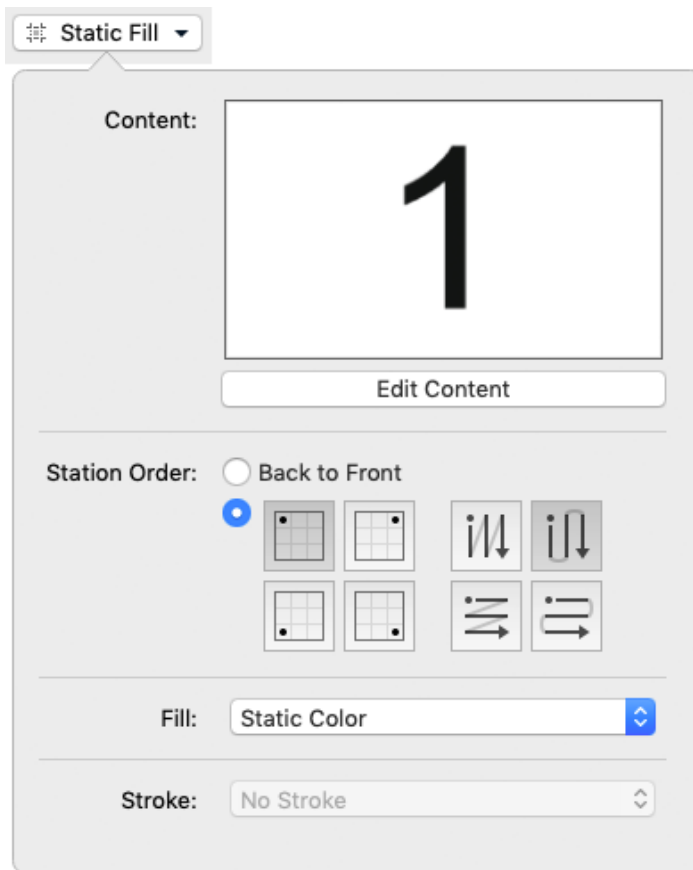

- You can set the **Station Order** in the Mark Inspector:
  - When selecting **Back to Front**, the sequence set in ArtiosCAD and stored in the MFG file will be used
  - If you set the order manually, you can use the buttons on the left to define the starting point, and the buttons on the right to define the direction.
- You can set the **Fill** color and **Stroke**. See also [Colors and Separations in a Mark](#) on page 317
- In the **Transformation Inspector** you can set the positioning of the Mark.
  - If you want to create Station Numbers based on the **StationNumber** placeholder saved in your one-up graphics, select **StationNumber** from the **From Placed Art** section in the dropdown. You can select any placeholder found in the stations. If a placeholder is present in some but not all stations, its name will be shown with an exclamation mark. If you select such a placeholder, the Repeat for Stations Mark will only be visible on the stations that contain the selected placeholder.
  - If you want to create Station Numbers based on a text object in the one-up structural design file, select the text item from the **From Layout** section.

**Note:** If at the time of creating the Mark not all stations have the same placeholder, the Repeat for Stations Mark will be attached to a dummy "Placeholder". The Marks will be selected but not visible until you attach the Mark to a placeholder that exists in a number of stations.

For more information, see [Station Numbering in an MFG / CF2 workflow](#) on page 280

## 10.4. Colors and Separations in a Mark

### Important:

To make sure your Marks are visible when they are being created, it is advised to create Dynamic Marks while there are no unused separations in the document.

Keep in mind that a separation that is only used in the object that you turn into a Mark will also become unused by doing so. It is advised to avoid this by making sure the separations are also used in another 'normal' object besides the object you turn into a Mark.

For predictable results of the colors of a Mark, it is advised to use solid colors, and no gradients, images or patterns.

The color options depend on the type of Mark. For most singular Marks (Point Text Mark, Area Text Mark, Custom Mark, Grid Mark, Cut Mark, Clip Mark, External File Mark) all options below are available. For Barcode Mark, only Static Color is available, and for Station Numbering Mark only Static Color and Darkest Color can be used.

- **Static Color:** If color is set to Static, the original color of the object that is used to create a Mark from is stored, based on the actual separations. The color of the Mark will not change if the order of the separations list is changed.

### Note:

When placed on an existing document, "Static Color" Marks are the only Marks that affect the separation list: the separations used in the Mark will be added if necessary.

- **Dynamic Color:** If color is set to "Dynamic", the current color is stored, but based on the separation positions in the separations list, and not the actual separations. If color is set to Dynamic, the Mark Inspector will show the index numbers of the separations used in the Fill or Stroke.

For example, if the first separation is Cyan, a 100% cyan Mark is stored as "100% of the first separation". If the first separation is different (by changing the separation order, or by placing the Mark on a different file), the Mark will become 100% of the first separation.

- **Darkest Color:** The Mark will be colored with 100% of the darkest separation used in the document. You can't change the percentage for "Darkest" separation, it will always be 100%.

Changing the separations in the document can change the color of the Mark. Only printing separations are considered for Darkest Color.

**Note:** If you manually change the color of a Text Mark that is set to Darkest, the color will change back to the darkest separation at the next Mark update.

- **Registration Color:** the highest percentage value used in the Fill or Stroke in the Mark Content will be applied to all separations.

For Repeat for Separations Mark as well as for Dynamic Color, Darkest Color and Registration Color, you can indicate what separations to be used in the Mark, by setting the **For** (Repeat for Separations) or **Use** (for Color) dropdown:

- All Separations
- Artwork Separations

- Processing Step Separations (See [Processing Step Layers](#) on page 97)
- Artwork Separations and Varnish
- Custom: This allows you to select separations by combining rules on Printing Method, Processing Step, Separation Name, Process Separations, Non-Process Separations or Artwork Separations. When setting up a rule using the Separation Name, you can use Smart Text instead of entering text.

Using the **Subset of Separations**, you can select specific separations from the result of the **For** or **Use** setting above, based on the index. You can enter for example "1-6", or "3,4,6", or "1,4-6". If the **Subset of Separations** is disabled, all separations defined using the **For** or **Use** setting will be included.

Bearer Bar Marks will by default be colored in 100% of all artwork separations. You can change this to **Custom**. This allows you to include inks based on the printing method.

To change the Mark content itself, i.e. the shape and color of the objects used to create the Mark, you can click the **Edit Content** button in the Mark Inspector. See [Editing a Mark](#) on page 322.

## 10.5. Mark positioning

The position of a Custom Mark is set in the Transformation Inspector.

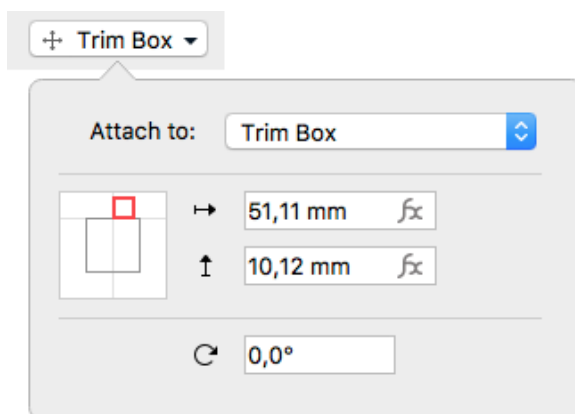

It is based on 3 settings:

### Attach to

The position of the Mark can be based on

- Any page box: Media Box, Crop Box, Bleed Box, Trim Box or Art Box
- another Dynamic Mark
- any named object, i.e. every object that is listed in the Named Objects Browser. See [Object Browser](#) on page 99. Keep in mind that if you load a Mark Set, any Marks attached to a Named Object that doesn't exist in your target document will be ignored. See also [Working with Mark Sets](#) on page 321

### Positioning

The way the Mark is attached, can be chosen by clicking and dragging the colored square (representing the Mark) to the desired position on the gray square (representing the **Attach To** reference). Each square has 9 reference points (top left center and right, middle left center and right, and bottom left center and right), so you have 81 different ways of positioning the Mark.

In the example underneath, the top center of the (bounding box of the) Mark will be placed on the left bottom corner of the (bounding box) of the reference defined in the Attach to field.



**Note:** If you create a Mark from an existing object, the Positioning settings (the colored square) will be automatically set, using the smallest offset possible while keeping the object at the same location.

### Offset & Rotation

In the offset fields, you can move the Mark based on the defined position. A positive value for offset moves the Mark to the right / bottom, as indicated by the arrows.

Using the **Fx** button, you can open the **Formula Editor**. See [Formula Editor](#) on page 319

**Note:** Formulas are currently not available for Grid Marks, Bearer Bar Marks, Cut Marks and Station Number Marks

#### **Note:**

Marks that are not using a formula can also be moved manually. In that case, the offset will automatically adjust to the new location. The other settings (Attach To and Positioning) will NOT change.

When trying to move a Mark with a formula using the interactive Transform tool or the Numeric Transform, the Mark will be reset to its original position. You can move it by changing the offset in the Transform inspector, and the formula will be lost.

Using the **Rotation**, you can rotate the Mark.

### Changing the "Attach To" of a Mark

When changing the "Attach To" of a Mark, by default the Offset values are kept, and the Mark will be repositioned.

However, by holding the **Alt** key, you can keep a Mark at its the position, and the **Offset** values will be recalculated.

This can be used for the following marks: Custom Marks, Point Text Marks, Area Text Marks, Repeat for Separations Marks, Barcode Marks and External File Marks.

Holding the Alt key will have no effect for other types of Marks, or if the Offset value is set using a formula.

## 10.6. Formula Editor

For certain properties when setting up a Mark, indicated by an **fx** symbol, you can use a formula with variables. For example in the Transformation inspector for Marks, you can set the **Offset** using a formula.

1. Select a Mark, and open the Inspector you want to set.
2. For the property you want to edit, click the **fx** button to open the **Formula Editor**.

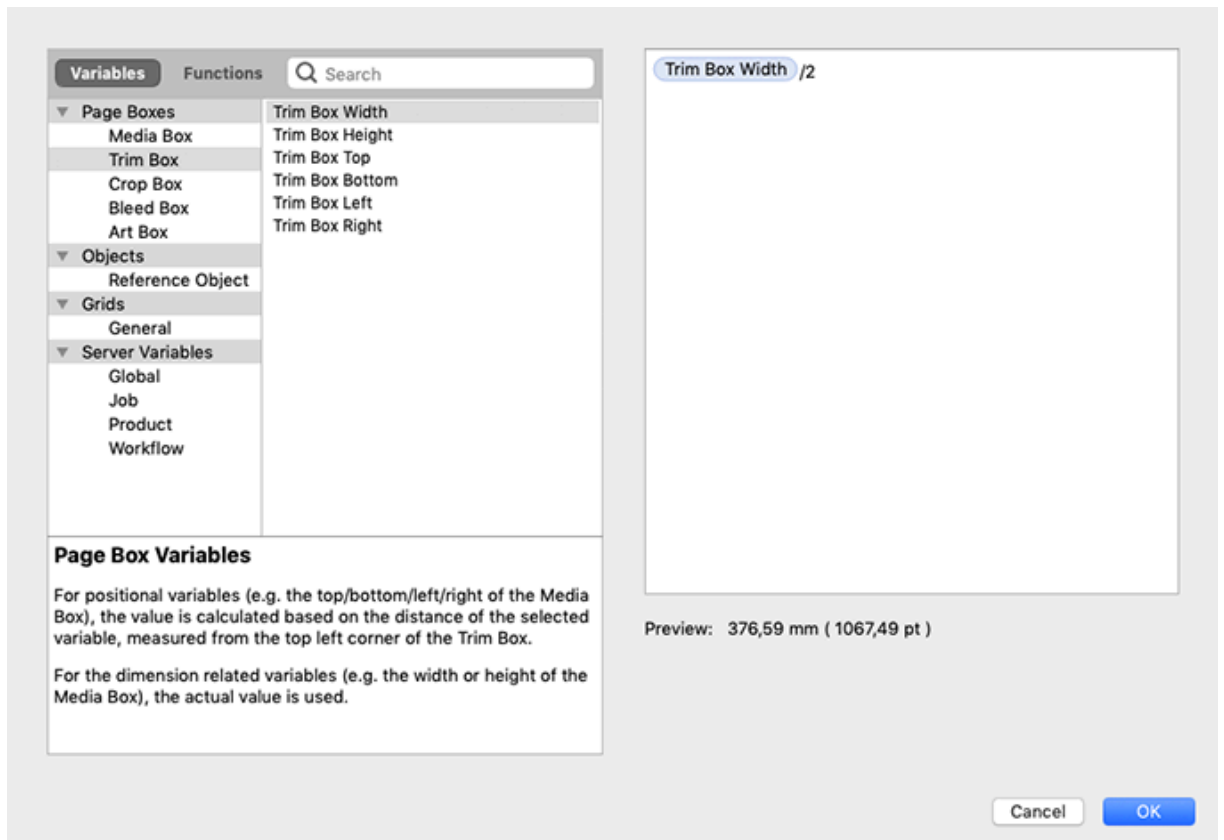

3. In the formula editor, on the left hand side, you see the available Variables and Functions. In the right column, you can compose the formula to be used, for example "Trim Box Width / 2"
4. To add a **Variable**:
  - a) Select **Variables**
  - b) Select a **Category** in the left hand column
  - c) In the middle column, select a variable you want to use in your formula, e.g. Trim Box Width. You can enter a **Search key** to find the Variable you're looking for.
  - d) Double-click the variable to add it on the cursor position, or drag and drop it.

**Note:** All **positional** variables used in a formula use the distance of the selected variable (e.g. the top of the Mediabox) measured from the top left corner of the Trim Box. A positive value is downwards or to the right, a negative value up or to the left.

5. You can combine variables using operators: plus (+), minus (-), multiply (\*), divide (/). You can also use brackets.
6. You can add fixed values by typing them in the formula.  
Note that distance values must have a length unit, e.g. "3mm".
7. To add a **Function**:
  - a) Select **Functions**
  - b) Select a **Category** in the left hand column
  - c) In the middle column, select a Function you want to use in your formula, e.g. ABS (absolute value). You can enter a **Search key** to find the Function you're looking for.
  - d) Double-click the Function to add it on the cursor position, or drag and drop it.



You can also type in the Function manually.

**Important:**

Functions are always typed full caps and arguments are split up using a **semicolon**:

FUNCTION(a;b;c)

A dot (.) or comma (,) are both used to express numbers with decimals.

More information about each function can be found in the Formula Editor itself.

8. Click **OK** to accept the formula

If the entered formula is valid, the **Preview** will show the calculated result. Otherwise it will show an error message.

You can remove a formula by entering a value in the property field.

The **fx** button will be gray if no fomula is set, red if an invalid formula is set, or blue if a valid formula is used. A tooltip will show the content of the formula

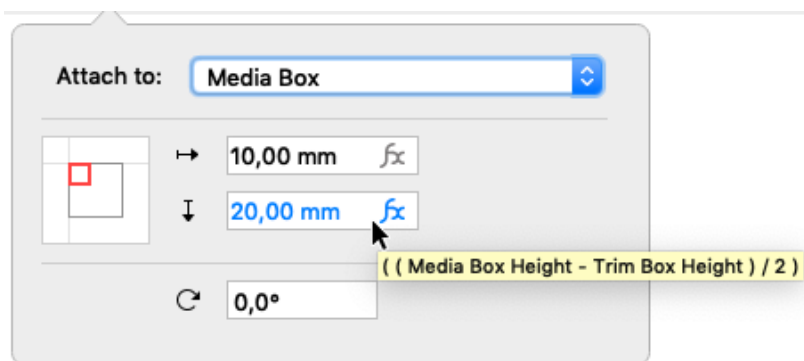

## 10.7. Working with Mark Sets

By saving a Mark Set, you can save all existing Marks in the document in a Set, which can then be loaded and applied in other documents.

By clicking the **Load Mark Set** button , the Load Mark Sets dialog will open.

- If you have an Automation Engine connection set up, the list of Mark Sets will show all compatible Mark Sets saved on the server. If not, it will list the locally saved Mark Sets. See [Automation Engine connection](#) on page 61
- The list will also contain the ArtPro+ default Mark Sets, e.g. Standard 5x5 Grid Mark
- Use the **Search** field to filter the list of Mark Sets.
- Enable **Replace Current Marks** if you want to remove all Marks in your documents, and add the Marks defined in the Mark Set. Disable the option to add the Marks from the Mark Set to your current Marks.
- Select a Mark Set in the list, and click **Load** to load the Marks defined in the Mark Set. You can also double-click the Mark Set in the list.

**Note:** When loading a Mark Set, any Marks that are attached to a Named Object that doesn't exist in your current document will be ignored.

Click the **Save/Delete Mark Set** button  to save, overwrite or delete a Mark Set.

- If you have an Automation Engine connection set up, the list of Mark Sets will show all compatible Mark Sets saved on the server. If not, it will list the locally saved Mark Sets. See [Automation Engine connection](#) on page 61
- Use the **Search** field to filter the list of Mark Sets.
- Enter a new name for the Mark Set and click **Save** to save the current set of Marks as a new Mark Set.
- Select a Mark Set from the list (or enter its exact name) and click **Update** to overwrite it.
- Select a Mark Set in the list, and click the - button to remove it.

To change a Mark Set, it is better to do this on the saved Marks file than on the document where you applied the Mark sets.

Local Mark Sets are saved in `C:\ProgramData\Esko\DynamicMarks (Windows)` or `/Users/Shared/Esko/DynamicMarks (Mac OS)`.

Mark Sets on Automation Engine are saved in `\\servername\Esko\bg_data_marks_v010\DynamicMarks`

**Note:** When applying a Mark Set in an older version of ArtPro+, new Mark types and new features of existing Marks will not be recognized.

**Tip:**

When you save a Mark Set, the entire document is saved. Because of that, we advise to follow these guidelines when creating a Mark Set from a document:

- The document should only contain a minimum of artwork objects (other than the Marks).
- The document should contain enough separations to be representative for your jobs.
- All separations are in use, and not only used by the Marks.

A good example would be a document with 7 separations, with a single rectangle in the Artwork layer colored in all of these separations, and then all applicable Marks added to the document using the correct "attach to" settings, and the applicable color settings defined in the Mark Inspector.

## 10.8. Editing a Mark

Even after creating a Mark, you can edit its appearance, regardless of whether it was a Mark created from Selection or a Standard Mark

1. Select the Mark you want to edit
2. In the **Mark Inspector** you can see a preview of the objects used in the Mark ("Mark Content"). In the Inspector, you can also change its coloring strategy (see [Colors and Separations in a Mark](#) on page 317).
3. Click the **Edit Content** button, or double-click the Mark while holding the Alt key, to open the Mark Content in a special Editing mode, e.g. to add or remove objects, change the shape, or change the colors.

- Click the **Back to Document** button to close the Editing mode, and return to your document window. The Marks on the document are automatically updated.

## 10.9. Nested Marks

There are a number of Marks that can contain nested Marks:

- **Clip Mark.** See [Clip Mark](#) on page 309
- **Repeat for Separations Mark.** See [Repeat for Separations Mark](#) on page 299
- **Repeat by Count Mark.** See [Repeat by Count Mark](#) on page 304
- **Repeat for Grid Mark.** See [Repeat for Grid Mark](#) on page 306
- **Resize Mark.** See [Resize Mark](#) on page 314

These Marks can contain the following nested Marks that are not expanded and remain dynamic:

- Point Text Marks and Area Text Marks
- Custom Marks
- Barcode Marks
- External File Marks
- Position Marks

A **Repeat by Count Mark**, **Repeat for Grid Mark** and **Resize Mark** can also contain a **Repeat for Separations Mark**, which in turn can contain other nested marks.

A **Repeat by Count Mark** can also contain a **Resize Mark**.

A **Resize Mark** can also contain a **Input File Mark** when working on a Report Template. See [Report Template](#) on page 66 and [Input File Mark](#) on page 68

Any other Mark types will be expanded when they are included in a Mark.

Nested Marks are shown in the **Marks** section of the Side Panel. A nested Mark is a Mark that is used as content for another Mark, for example a Custom Mark inside a Repeat for Separations Mark, or an Input File Mark inside a Resize Mark.

▼ Marks	
Name	Type
Repeat for Separations Mark 1	■ ■ ■
Custom Mark 1	📄
Point Text Mark 1	T

Since you can't rename or select a nested Mark on the document level, its name is grayed out.

Double-clicking the name of a nested Mark will allow you to modify the nested Mark, similar to selecting the enclosing Mark and clicking the **Edit Content** button in the Marks Inspector. This also implies that if the enclosing Marks contains more than one nested Mark (as in the example above), double-clicking any of the nested Marks will allow to edit them all.

Click **Back to Document** in the upper toolbar to return to Document level. See also [Editing a Mark](#) on page 322

## 10.10. Updating Marks

---

In some specific situations, it can occur that a Dynamic Mark goes "out of sync".

- When a placed file was altered outside of ArtPro+, e.g. if a separation is removed from a linked image in Photoshop. If the separation isn't used elsewhere in the document, it should no longer appear in the Marks.
- If a Text Mark uses a variable that was changed on the Automation Engine side.

Marks in ArtPro+ are updated automatically in a number of situations

- After opening a document, Dynamic Marks are updated when you start editing the document.

**Note:** Note that in ArtPro+ opening a document never changes the document, only when you start editing it. For the same reason, Marks are only updated when you edit the document.

- If embedded Placed Art is changed in **Edit Placed Art** mode, Marks are updated immediately. See [Edit Placed Art](#) on page 178
- For linked placed Art that was edited outside of ArtPro+, selecting **Update** will also trigger the Marks to update. See [Update](#) on page 176
- Most but not all Smart Text Variables are updated live. There is e.g. no live update if you are using the ink coverage variable, if you are using the modification time variable or if a value of a server variable is changed on the server side. To trigger an immediate update, you can use the **Update Marks** button .
- Marks containing server variables that were changed in Automation Engine side, will be updated when the file is edited after opening the file.

**Note:**

Server variables are only updated once per ArtPro+ session, so if the server variables are once again changed on the Automation Engine server while the file is open in ArtPro+, ArtPro+ will not pick this up. There are three ways to trigger an update of the server variables:

- Quit and relaunch ArtPro+. This is the most effective way.
- Remove and reestablish the Automation Engine connection.
- Use the **Update Marks** button .

## 10.11. Error Messaging for Marks

---

When the generation of a Mark results in an error, the invalid Mark will not be visible, and a Message is shown in the Messages drawer.

To fix the issue, read the Message closely - hovering over the message will show a more descriptive tooltip. Then, select the Mark listed underneath the Message to select the (invisible) Mark and make the relevant inspectors available so you can correct the settings.

Common errors:

- Smart Text that can't be resolved correctly.
- **Code Too Long**: the code for a Barcode Mark contains too many characters, e.g. more than 35 for a MicroQR barcode. Fix this by changing the Code itself.
- **Invalid Character** or **Invalid Character Set** for a Barcode Mark: Not all characters are supported in all barcode types. If those characters are used in the Code field, you can fix it there. If the Smart Text variables "File Name" or "Separation Name" results in invalid characters in the Code, you should remove the unsupported characters from the file name or separation name. Alternatively, you can switch to using the "Abbreviated Separation Name".

### Error Message Levels

A Mark can fail at three different levels:

- **At Document level**: an issue with a Mark directly on the document. You will get a regular error message. You can fix the issue by selecting the Mark and checking the settings in the available inspectors.
- **At Mark Content level**: an issue with a "nested" Mark: a Mark that is used as Content of another Mark. In that case, the error message will end with "(Mark Content)". Select the corresponding Mark, and in the Mark Inspector click the **Edit Content** button. In Edit Content mode, the error message will be shown again, now for the specific nested Mark. Fix the issue by selecting the Mark and checking the settings in the available inspectors.
- **At Mark Repetition level**: an issue with one or more of the repetitions of a "nested" Mark: a Mark that is used as Content of a Repeat for Separations or Repeat by Count Mark. An example of this is a microQR Barcode Mark inside a Repeat for Separations Mark, using the variable "Separation Name" as Code. If the name of one of the separations is too long to fit in the microQR code, you will get an error message, indicating what repetition is causing the error. Fixing this error can be done in Edit Content mode (see above), e.g. by using the Abbreviated Separation Names as Smart Text. It can also be fixed by shortening the separation name in your document.

**Tip:** If you have both "Mark Content" and "Mark Repetition" errors for the same Mark, start by resolving the Mark Content error(s). This might resolve some of the Mark Repetition errors.

For more information on Nested Marks, see [Nested Marks](#) on page 323

# 11. Action Lists

---

**Note:** The availability of this functionality depends on your license of ArtPro+. See [Licensing](#) on page 25



Using **PDF Action Lists** (.pal) you can automate a number of ArtPro+ functions. Action Lists are managed in the **Action List Preferences** and can be run or edited from the **Action List Side Drawer**.

## 11.1. The Action List Side Drawer

---

The Action List Side Drawer shows all Action Lists set up in the **Action Lists** tab of the Preferences.

In the Action List Side Drawer, you can:

- Filter the Action Lists by entering (a part of) an Action List Name in the **Search** box.
- Recently run Action Lists can easily be run again from the **Recent Action Lists** section.
- If you hover over an Action List, you will see what shortcut is assigned to it. See the **Keyboard** section in [Preferences](#) on page 44
- Double-click an Action List, or select an Action List and click the Run button  to run the Action List on your current document and selection. You can also choose **File > Action List > Run Action List** or use its shortcut **Cmd+Alt+Shift+A** (Mac) or **Ctrl+Alt+Shift+A** (Windows).
- Select an Action List and click the **Edit** button  to edit the Action List in the Action List Editor. See [The Action List editor](#) on page 330
- Select an Action List, and select **Step Through...** in the fly-out menu to step through the Action List. See [Stepping through an Action List](#) on page 326
- Select an Action List, and select **Run With Options** in the fly-out menu on a selection of pages, or redefine the **Action List Parameters** used in the Action List. See [Run With Options](#) on page 327
- Choose **Manage Action Lists...** from the fly-out menu to open the Action Lists tab of the Preferences, where you can manage your Action Lists. See [Managing Action Lists](#) on page 328

## 11.2. Stepping through an Action List

---



The **Step Through** function in Action Lists can be used for various reasons:

- To run an Action List step by step, and checking the result of every step individually, e.g. to debug the action list.
- To run only a part of an Action List
- To perform additional actions (e.g. changing the selection) in the middle of an Action List.

In the Action List Side Drawer, select the Action List you want to use, and select **Step Through** in the fly-out menu.

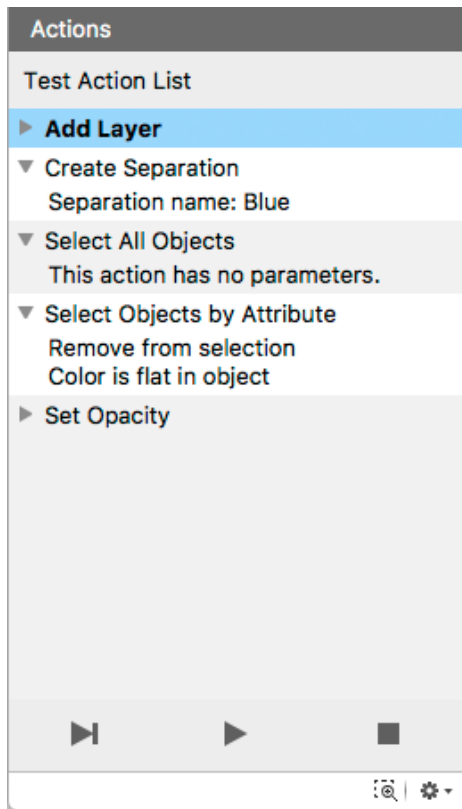
The Action List Side Drawer will change to the **Actions Side Drawer**



- a) Click the triangle in front of an Action to show or hide the settings for it
- b) Click an Action to select it
- c)
  - Select **Perform Selected Action** from the fly-out menu, or click the  button to perform the selected Action
- d)
  - Select **Run Selected Action and all Actions below** from the fly-out menu, or click the  button to perform the selected Action and all following actions.
- e) Enable **Zoom to Selection** to automatically zoom in on the object(s) selected after the performed Action.
- f)
  - Select **Exit Step-Through mode** from the fly-out menu, or click the  button to stop the Step Through and return to the Action List Side Drawer.

### 11.3. Run With Options

---

When you run an Action List, the Action List is executed on the current page, using the parameters as set in the Action List. To run the Action List on a selection of pages, or to redefine the **Action List Parameters** used in the Action List, you can **Run With Options**

1. In the **Action List Side Drawer**, select the Action List you want to use, and select **Run With Options** in the fly-out menu.

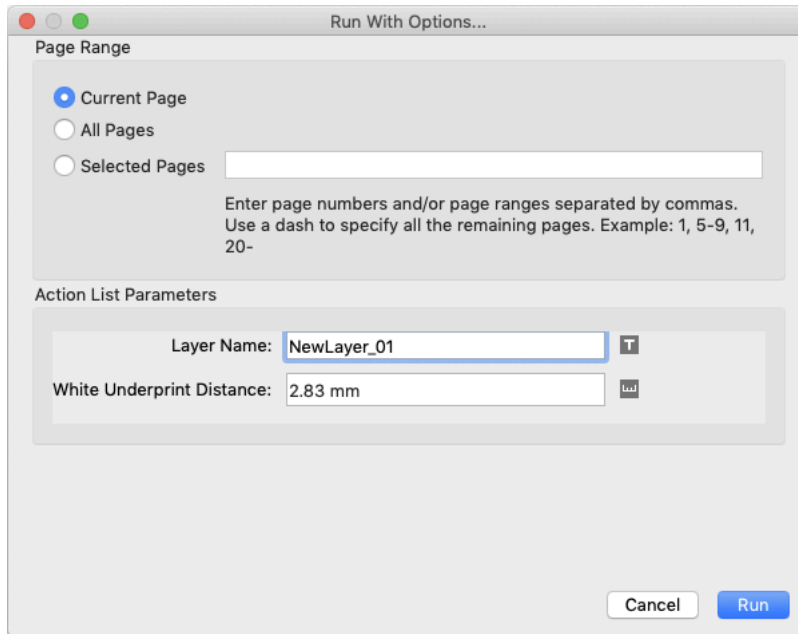

2. In the **Page Range** section you can define on what pages to run the Action List
  - **Current Page** is the default behaviour, and runs the Action List only on the current page.
  - **All Pages** runs the Action List on all pages in your document.
  - Using **Selected Pages** you can specify what pages to run the Action List on.
3. In the **Action List Parameters** section, you can see all Action List Parameters defined in the Action List, and the current value. You can edit the parameters to use different values. For more information on Action List Parameters, see [Parameters in Action Lists](#) on page 341.
4. Click **Run** to run the Action List on the selected pages and using the defined Action List Parameters.

## 11.4. Managing Action Lists

---

In the Action List Side Drawer, choose **Manage Action Lists...** from the fly-out menu, or choose **File > Action Lists > Manage...** to open the Action Lists tab of the Preferences. You can also open the **Preferences** and switch to the **Action Lists** tab then. See [Preferences](#) on page 44



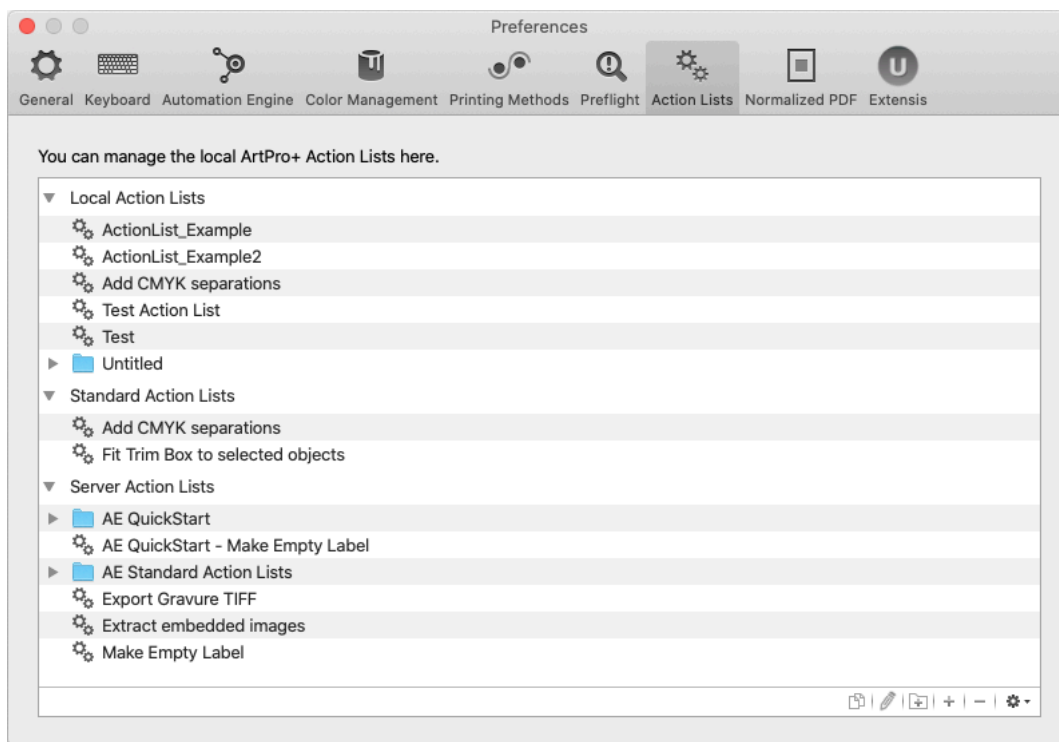

You have three types of Action Lists: **Local Action Lists**, in which you can add, edit and remove Action Lists, **Standard Action Lists**, which contains pre-configured Action Lists provided by Esko, and **Server Action Lists**, only available if you have an Automation Engine Connection.

**Note:**

Local Action Lists are saved in C:\Users\currentuser\AppData\Roaming\Esko\ArtPro+\Action Lists (Windows) or /Users/currentuser/Library/Application Support/ArtPro+/Action Lists (Mac OS).

Action Lists on Automation Engine are saved in \\servername\bg\_data\_custom\_v010\data\PDF Action Lists

- Double-click an Action List name or folder to change its name.
- Click the button to add a (sub)folder
- Click the **+** button or choose **New** from the fly-out menu to create a new Action List from scratch. If you have a folder selected, the Action List is created inside the folder.
- Click the **-** button or choose **Delete** from the fly-out menu to remove the selected folder or Action List
- Double-click the icon in front of the name, click the button or choose **Edit** from the fly-out menu to edit the Action List in the **Action List Editor**. See [The Action List editor](#) on page 330
- Click the button or choose **Duplicate** from the fly-out menu to make a new Action List based on an existing one.
- Click and drag to move Action Lists in or out a folder or section.



When dragging, the default action can be to move (e.g. from one subfolder to another) or to copy (e.g. from Standard Profiles to Local Profiles). You can use the standard modifier keys to force copying (Alt key) or moving (Cmd on Mac, Shift on Widows). You can't remove Standard Action Lists.

- From the fly-out menu, select **Import Action List** to import an Action List saved as a .pal file into the Local or Server Action Lists.
- From the fly-out menu, select **Import Group** to import a folder containing .pal files as a folder in the Local or Server Action Lists.
- From the fly-out menu, select **Export** to save the selected Action List as a .pal file, or to save the selected folder as a folder containing .pal files.

## 11.5. The Action List editor

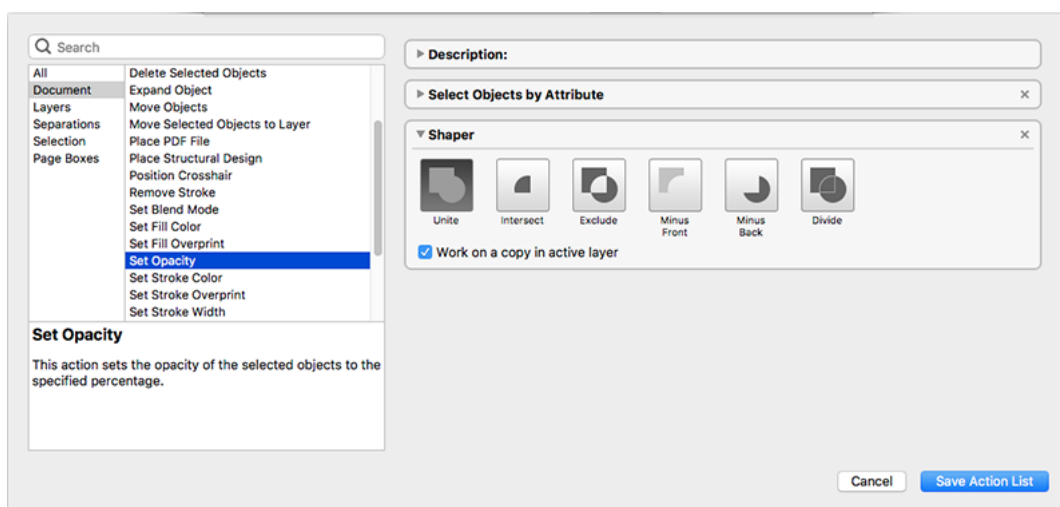
In the Action List editor, you can edit the Actions in an Action List.



1. To open the Action List Editor:
  - In the Action List Side Drawer, select the Action List you want to edit, and click the **Edit** button .
  - In the **Action List** tab of the Preferences, select an Action List and double-click it, click the **Edit** button  or choose **Edit** from the fly-out menu.
2. The left side of the dialog shows the available Actions. For more information on the available actions, see [Actions](#) on page 331
  - If you enter a keyword in the **Search** field, only the actions containing the keyword - within the selected category (see below) - will be shown.
  - Click a category in the left column to only see actions from this category, or select "All" to see all available actions.
  - Select an action in the right column to see some information about it in the bottom part.
  - Double-click an action to add it at the bottom of your Action List in the right side of the dialog. You can also drag it to the desired location.
3. The right side of the dialog shows the actions in your Action List
  - On top, you can set a **Description** for the Action List.
  - For every action, you can make a number of specific settings. E.g. in **Select Objects By Attribute** you can select the attributes used to do the selection. For some actions, you can use

**Parameters**, e.g. the name for a new Layer. See [Parameters in Action Lists](#) on page 341. If an action has a missing parameter, the input field has a red stroke, and the action has "(Invalid Value)" appended to its name.

- Click and drag Actions to change the order. The **Description** always stays on top of the list.
- Click the triangle to collapse the Actions, so you get a better overview of the complete Action List.

4. Click **Save Action List** to save the Action List.

## 11.5.1. Actions

This gives an overview of all the Actions currently available for use in Action Lists, along with some basic information on the setup.

For some actions you can enable **Ignore Case**. When enabled, differences in case (e.g. "Artwork Layer" versus "artwork layer") is ignored, and the two are considered the same.

For some actions, the **Active Layer** is used. See also [Layers](#) on page 94

- Selecting a layer - manually or by using an action - makes it the active layer.
- If multiple layers are selected, the topmost selected layer will be the active layer.
- If no layer is selected, the topmost layer is the active layer.

Some actions allow the use of wildcards: the asterisk sign \* matches zero or more characters, the question mark ? matches a single character.

### Document

#### Add Bleed

This action adds bleed for the selected objects, allowing to extend artwork beyond the cutting lines. Adding bleed requires a Cutting processing step layer that contains cutting lines. See [Add Bleed](#) on page 239

#### Add Dimensions

This action adds dimensions to the selected objects or page box. See [Add Dimensions](#) on page 236

#### Add Rich Black

This action adds Rich Black to the selected objects. It creates Rich Black Objects for the selected objects, in a separate layer, using the specified inks, and in Darken blend mode. See [Rich Black](#) on page 241

#### Add White Underprint

This action adds white underprint to selected objects. See [White Underprint](#) on page 240

#### Arrange

This action will move selected objects. The objects can be moved to the front or to the back, or they can be sent forward or backward. See [Arrange objects](#) on page 120

#### Choke

This action runs a Choke operation on the selected objects. It is either applied to the original object, or to a new copy of the original object. In both cases, the resulting object is selected. See [Spread / Choke](#) on page 137

#### Clean

This action requires a selection of objects, and will run the enabled Clean actions on the selected objects. See [Clean](#) on page 140

**Close Path**

This action closes all the open paths of the selected objects by connecting their end points with straight lines. See [Close Path](#) on page 137

**Convert to PDF+**

This action converts a Normalized PDF document to PDF+. After conversion, the selected Structural Design Profile remains visible in the document. See [Convert to PDF+](#) on page 54

**Create Clipping Mask**

This action requires a selection of objects, in which the topmost selected object is a path. The path will become a clipping mask clipping the other selected contents. If needed, the clipped contents will move down. See [Clipping Mask](#) on page 130

**Create Ink Eater Areas**

This action creates Ink Eater Areas that can be filled later by the **Fill Ink Eater Areas** action. It can only be applied on a (grid or CAD based) Step & Repeat document. If there is an active selection, the action creates Ink Eater Areas for all the paths in the selection (excluding clipping paths). If there is no valid selection, the Ink Eater Areas are created on the Trim Box of the page. See [Ink Eater Areas](#) on page 242

**Create Shape by Parameters**

This action creates the selected shape (ellipse or rectangle) by determining a position relative to the crosshair and setting absolute size parameters. For the rectangle you can define rounded corners. See [Create Rectangle / Create Ellipse](#) on page 154

**Create Shape on Page Box**

This action will create and select a shape (a Rectangle or an Ellipse) based on the specified page box. The resulting shape will be created at the top of the selected layer. If no layer is selected, the shape will be created in the topmost layer, as topmost object. See [Page Boxes](#) on page 92

**Create Shape on Selection**

This action creates the selected shape (ellipse or rectangle) based on the bounding box of the selected objects. For the rectangle you can define rounded corners. The resulting shape will be created on top of the selected layer. If no layer is selected, the shape will be created in the topmost layer, as topmost object. When no object is selected, no shape is created. See [Create Rectangle / Create Ellipse](#) on page 154

**Crop Images**

This action crops the selected images to the bounding box of their clipping paths.

**Delete Object**

This action requires a selection of objects, and will remove the selected objects from the document. See [Delete](#) on page 120

**Downsample Images**

This action downsamples the selected images to the resolution of your choice. Bitmap images are excluded and will not be downsampled.

**Expand Object**

This action expands (degrades) selected objects. The objects will become a group of regular objects. See [Expand](#) on page 139

**Extract Embedded Image**

This action creates one TIFF/PSD file per selected image object. See [Extract and Link](#) on page 166

**Fill Ink Eater Areas**

This action fills the selected ink eater areas with ink eaters. You can specify the area to scan for ink consumption and define a compensation strategy by choosing the number of gradient stops in the ink eaters, as well as their density and falloff, the minimum ink density and maximum total area coverage. See [Fill Ink Eater Areas](#) on page 243

**Group Objects**

This action groups the selected objects. See [Group objects](#) on page 121

**Insert Content from PDF**

This action inserts the content of the selected PDF file onto the current page and merges the layer structure. If the Crosshair is enabled, the content of the PDF will be positioned at the bottom right of the Crosshair. See [Insert Content from PDF](#) on page 70

**Join Paths**

This action joins one or more open paths in the selection. See [Join Paths](#) on page 136

**Make Compound**

This action makes a compound path of the selected objects. See [Compound](#) on page 121

**Modify Screen Sets**

This action allows to modify existing screen sets. Wildcards (\*, ?) can be used to select screen sets and separations. All objects that use the changed screen sets will be affected. See [Screening](#) on page 245

**Move Object to Layer**

This action requires a selection of objects and also a selection of layers. The action moves the selected objects into the active layer. If no layer is selected, or if multiple layers are selected, the topmost layer is considered to be the active layer. See [Layers](#) on page 94

**Place Image**

This action places the specified image file in the selected layer. You can choose to embed the image with or without a link to the external image file. See [Place](#) on page 164

**Place PDF File**

This action will place (the specified page of) the specified external PDF file in the selected layer. When the Crosshair is active, the Crosshair defines the position where the page is placed. You can choose to embed the file or to also keep the link to the external file. Normalized PDF files are always embedded. See [Working with Placed Art](#) on page 173

**Place Structural Design**

This action will place the specified structural design file. The file is placed on the center of the trim box. The link to the placed file is always kept. See [Working with Structural Design files](#) on page 180

**Position Crosshair**

This action changes the position of the crosshair by moving it from its current location over a fixed distance, or by positioning it relative to the bounding box of the current selection or to one of the page boxes.

**Rasterize**

This action rasterizes the selected objects. See [Rasterize ...](#) on page 139

**Release Compound**

This action releases all compound paths that are included in the selection. See [Compound](#) on page 121

**Remove Fill**

This action removes any fills of the selected objects. See [Changing the Fill and Stroke](#) on page 143

**Remove Screening**

This action removes screening from the selected objects. See [Screening](#) on page 245

**Remove Stroke**

This action removes any strokes from the selected objects. See [Stroke Inspector](#) on page 148

**Remove Trap Tags**

This action removes trap tags from the selected objects, with the option to also remove tags from all objects in the hierarchy.

**Rename Object**

This action gives a name to the selected objects. See [Renaming objects, groups and layers](#) on page 119

**Replace Image**

This action replaces all the selected images with the specified image file. You can choose to embed the image with or without a link to the external image file. See [Replacing an image](#) on page 170

**Replace Linked Images**

This action replaces linked images in the current selection with images with the same name from a specified input folder. As an option, you can provide a Prefix and/or Suffix to use when replacing images with matching images from the input folder. See [Replacing an image](#) on page 170

**Set Blend Mode**

This action sets the blend mode of the selected objects. See [Transparency Inspector](#) on page 149

**Set Document Distortion**

This action sets the document distortion. See [Document Setup](#) on page 71

**Set Fill Color**

This action creates a color from the selected separation(s) or makes a Registration Color. The color is used to fill the selected objects at the specified percentage, resetting any overprint settings. If no separation is selected, the color is set to white (all separations zero). See [Fill Color and Stroke Color Inspector](#) on page 143

**Set Fill Knockout**

This action sets the fill of the selected objects to knockout. See [Fill Color and Stroke Color Inspector](#) on page 143

**Set Fill Overprint**

This action sets the fill of the selected objects to overprint. See [Flat Color](#) on page 144

**Set Object Screening**

This action allows you to define a Screen Set and apply it to the selected objects.

**Set Opacity**

This action sets the opacity of the selected objects to the specified percentage. See [Transparency Inspector](#) on page 149

**Set Stroke Color**

This action creates a color from the selected separation(s) or makes a Registration Color. The color is applied to the stroke of the selected objects at the specified percentage. If no separation is selected, the color is set to white (all separations zero). If the selected objects have no stroke, then the default stroke weight is applied. See [Fill Color and Stroke Color Inspector](#) on page 143

**Set Stroke Corners**

This action sets the stroke corners of the selected objects. It will not create any strokes. See [Fill Color and Stroke Color Inspector](#) on page 143

**Set Stroke Dashing**

This action will add or remove dashing of the strokes of the selected objects. Objects without stroke are not changed. When the Dashed strokes option is enabled, the strokes of the selected objects will be dashed with dashes defined by the dash offset and one or more dash and gap lengths. When the Dashed strokes option is disabled, the action will remove any existing dashing from the strokes of the selected objects. See [Fill Color and Stroke Color Inspector](#) on page 143

**Set Stroke End Caps**

This action sets the stroke end caps of the selected objects. See [Fill Color and Stroke Color Inspector](#) on page 143

**Set Stroke Knockout**

This action sets the stroke of the selected objects to knockout. It will not create any strokes. See [Fill Color and Stroke Color Inspector](#) on page 143

**Set Stroke Overprint**

This action sets the stroke of the selected objects to overprint. It will not create any strokes. See [Fill Color and Stroke Color Inspector](#) on page 143

**Set Stroke Weight**

This action sets the stroke weight for the selected objects. If the object doesn't have a stroke yet, it will be created, in the darkest color, with the given weight. See [Stroke Inspector](#) on page 148

**Set Structural Design Print Item**

This action sets the print item for the selected structural design to the specified one. You can also choose to show all layers (no print item). See [Structural Design Inspector](#) on page 181

**Set Structural Design Print Side**

This action sets the print side of the selected Structural Design to front or back. See [Structural Design Inspector](#) on page 181

**Set Trap Tags**

This action sets or removes Trap Tags or Reverse Trap Tags on selected objects. You can choose to keep existing tags, to remove existing tags, or to set new tag values. See [Working with Trap Tags](#) on page 259

**Shaper**

This action runs a Shaper operation on the selected objects. The result of the operation is created in the active layer and gets selected. The Divide operation uses the Darkest color to fill the result. The original paths are kept untouched if 'Work on copy in active layer' is checked. See [Shaper](#) on page 155

**Spread**

This action runs a Spread operation on the selected objects. It is either applied to the original object, or to a new copy of the original object. In both cases, the resulting path is selected. See [Spread / Choke](#) on page 137

**Subtract White Underprint**

This action subtracts white underprint from the selected objects. See [White Underprint](#) on page 240

**Trace Image**

This action vectorizes the selected images or opacity masks.

**Ungroup Objects**

This action ungroups the selected objects. See [Group objects](#) on page 121

**Unlink Image**

This action unlinks the selected images, i.e. it will remove the link to the file on disk and only keep the embedded version in the document. See [Unlink / Embed and Unlink](#) on page 166

**Unlink Placed Art**

This action unlinks the selected Placed Art objects, i.e. it will remove the link to the file on disk and only keep the embedded version in the document. See [Unlink](#) on page 176

#### **Update Fill Color**

This action updates colors' fill percentages from the selected separation(s). The color is used to fill the selected objects at the specified percentage. See [Fill Color and Stroke Color Inspector](#) on page 143

#### **Update Linked Image**

This action will update all linked images. See [Working with images](#) on page 164

#### **Update Linked Placed Art**

This action will update all linked Placed Art objects. See [Working with Placed Art](#) on page 173

#### **Update Marks**

This action will update all Marks. See [Marks](#) on page 291

#### **Update Stroke Color**

This action requires a selection of objects and also a selection of separations. It updates the stroke of the selected objects for the selected separation(s) to the specified color percentage. See [Fill Color and Stroke Color Inspector](#) on page 143

#### **Update Structural Design**

This action will update all structural design objects. See [Working with Structural Design files](#) on page 180

### **Layers**

#### **Add Layer**

This action creates and selects a new layer on top of the existing ones. If such a layer already exists, it is just selected. See [Layers](#) on page 94

#### **Create Layer from Unlayered Art**

This action creates a layer from unlayered art. See [Layers](#) on page 94

#### **Delete Layer**

This action requires a selection of layers, and will remove the selected layers from the document. See [Layers](#) on page 94

#### **Invert Layer Selection**

This action inverts the layer selection in the Layers panel. See [Layers](#) on page 94

#### **Lock/Unlock Layers**

This action locks or unlocks the selected layers.

#### **Rename Layer**

This action requires a selection of one or more layers, and will rename the selected layers. See [Layers](#) on page 94

#### **Rename Layer with Wildcards**

This action replaces the name of all layers that match the Old Layer Name by the New Layer Name. Wildcards (\*, ?) are allowed. See [Layers](#) on page 94

#### **Reorder Layers**

This action changes the order of the layers based on the selected setting. When specifying layer name(s), you can enter multiple names separated by a comma (,) and wildcards (\*, ?) can be used

#### **Select Artwork Layers**



This action selects all Artwork Layers. The selected layers can be added to, subtracted or selected from the existing layer selection, or added to a new selection. See [Layers](#) on page 94

**Select Empty/Non-Empty Layers**

This action selects empty (or non-empty) layers. See [Layers](#) on page 94

**Select Layer by Name**

This action selects layers based on their name. The selected layer can be added to the current selected layers, subtracted from them, united with them, or act as a new selection. You can enter multiple names separated by a comma (.). Wildcards (\*, ?) are allowed. See [Layers](#) on page 94

**Select Layer by Processing Step**

This action selects layers based on their processing step type. The selected layers can be added to, subtracted or selected from the existing layer selection, or added to a new selection. See [Processing Step Layers](#) on page 97

**Select Layers by Printing State**

This action selects layers based on their printing state. The selected layers can be added to, subtracted or selected from the existing layer selection, or added to a new selection. See [Visibility, Locking and Printing state](#) on page 95

**Select Locked/Unlocked Layers**

This action selects either locked or unlocked layers. The locked or unlocked layers can be added to, subtracted or selected from the existing layer selection, or added to a new selection. See [Layers](#) on page 94

**Set Layer Printing State**

This action will set the layer printing state for the selected layer(s) to on or off. See [Visibility, Locking and Printing state](#) on page 95

**Set Processing Step Type**

This action will set a Processing Step Type for the selected layer(s). No consistency check is done. See [Processing Step Layers Overview mode](#) on page 99

**Set Processing Steps Printing State**

This action sets the Processing Steps Printing State.

## Separations

**Convert to CMYK**

This action will convert the selected separations to CMYK using the chosen method. Selected process separations are ignored by the action.

**Create Separation**

This action creates a new separation by the specified name. The created separation gets selected. If the separation already exists, it just gets selected. Separation names are case sensitive. If the separation name is not found in the color database, the new separation will be created using preview color values. See [Separations](#) on page 101

**Delete Separation**

This action requires a selection of separations, and will remove the selected separations from the document. See [Separations](#) on page 101

**Invert Separation Selection**

This action inverts the separation selection in the Separations panel. See [Separations](#) on page 101

**Rename Separations With Wildcards**

This action replaces the name of all separations that match the Old Separation Name by the New Separation Name. Wildcards (\*, ?) are allowed. See [Separations](#) on page 101

**Reorder Separations**

This action allows to make your ordered separation list using wildcards (\*, ?) if needed. The top-most separation in the list will be printed first. You can also specify your separations as one comma-separated line. See [Separations](#) on page 101

**Replace Separations**

This action replaces the selected separations by the target separation. If the target separation does not exist, then no replacement is done. See [Separations](#) on page 101. See also [Screening when merging separations](#) on page 247

**Select Darkest Artwork Separation**

This action selects the darkest artwork separation in the document.

**Select Separation by Name**

This action selects separations based on their name. The selected separation can be added to the current selected separations, subtracted from them, united with them, or act as a new selection. You can enter multiple names separated by a comma (,). Wildcards (\* or ?) are allowed. See [Separations](#) on page 101

**Select Separation by Printing Method**

This action selects separations based on their printing method. See [Separations Setup](#) on page 104

**Select Separations by Processing Step**

This action selects separations used in Processing Step layers only. See [Processing Step Layers](#) on page 97

**Select Separations Used in Printing Layers**

This action selects all printable separations on the page.

**Set Printing Method**

This action requires a selection of one or more separations, and will set the requested printing method (default or custom). See [Separations Setup](#) on page 104

**Set Separation Type**

This action requires a selection of one or more separations, and will set the requested separation type. See [Separations Setup](#) on page 104

**Selection****Invert Object Selection**

This action inverts the object selection.

**Select All Objects**

This action selects all objects.

**Select Objects by Attribute**

This action selects objects based on a number of criteria. It can create a new object selection, add objects to the existing selection or remove objects from the current selection. See [Select Advanced](#) on page 116

**Select Objects by Box**

This action selects all objects inside a box that you define. The Select Objects by Box action can create, add to, subtract or select from an object selection. To define the box, first select a reference Page Box and the define optional Horizontal and Vertical offsets and Width and Height of the box.

**Select Objects in Layer**

This action selects all objects in the selected layers. See [Layers](#) on page 94

## Page Boxes

### Clip On Page Box

This action will clip the selected objects on the selected page box. See [Clip on Page Box](#) on page 130

### Remove Page Box

This action removes the selected page box.

### Set Page Box Size

This action sets the size of the selected page box. See [Page Boxes](#) on page 92

### Set Page Box Size by Content

This action sets the size of the specified page box to the size of the selected content, with the following Fit Type options: "Fit All" sets the page box size to the visible bounds of your selection, taking into account strokes and clipping, while "Fit to Selection" sets the page box size to the combined bounding boxes of the selection. See [Page Boxes](#) on page 92

### Set Relative Page Box Size

This action sets the size of the selected page box relative to the reference page box. See [Page Boxes](#) on page 92

## Transform

### Mirror Objects

This action mirrors the bounding box of the selected objects. This bounding box is never rotated, even if the selected objects themselves have a rotation.

### Move Objects

This action moves the bounding box of the selected objects by a relative distance or relative to the crosshair position. This bounding box is never rotated, even if the selected objects themselves have a rotation. The gradients, patterns and opacity masks of these objects can be moved as well. See [Numeric Transform](#) on page 125

### Rotate Objects

This action rotates the bounding box of the selected objects. This bounding box is never rotated, even if the selected objects themselves have a rotation. See [Numeric Transform](#) on page 125

### Scale Objects

This action scales the bounding box of the selected objects. This bounding box is never rotated, even if the selected objects themselves have a rotation. See [Numeric Transform](#) on page 125

### Set Objects Size

This action sets the size of the bounding box of the selected objects. This bounding box is never rotated, even if the selected objects themselves have a rotation. See [Numeric Transform](#) on page 125

### Shear Objects

This action shears the bounding box of the selected objects. This bounding box is never rotated, even if the selected objects themselves have a rotation. See [Numeric Transform](#) on page 125

## Clipboard

### Copy

This action copies the selected objects to the clipboard. See [Cut, Copy and Paste](#) on page 118

### Cut

This action cuts the selected objects from the document and copies them to the clipboard. See [Cut, Copy and Paste](#) on page 118

#### **Paste**

This action pastes the contents from the clipboard into the document. See [Cut, Copy and Paste](#) on page 118

#### **Paste in Back**

This action pastes the copied objects behind the selected objects. See [Cut, Copy and Paste](#) on page 118

#### **Paste in Front**

This action pastes the copied objects in front of the selected objects. See [Cut, Copy and Paste](#) on page 118

#### **Paste with Layer Structure**

This action pastes the copied objects while maintaining their original layer structure. See [Cut, Copy and Paste](#) on page 118

### **Barcode**

#### **Add Barcode**

This action adds a barcode of the type and with the code of your choice. Decimal input can be optionally used for barcodes that support both binary and decimal input modessuch as Laetus Pharma, SICK, Bobst, Klebrand or Kurandt. For other barcode types this option is not relevant. See [Barcodes](#) on page 183

#### **Set Barcode Value**

This action sets the code of the selected barcode to a value of your choice. Decimal input can be optionally used for barcodes that support both binary and decimal input modessuch as Laetus Pharma, SICK, Bobst, Klebrand or Kurandt. For other barcode types this option is not relevant. See [Barcodes](#) on page 183

#### **Update Barcode**

This action will update barcode properties according to the Automation Engine server job setup. See [Barcodes](#) on page 183

### **Flow Control**

#### **Conditional Action (If... Then...)**

This action allows to run a set of actions only when the set of conditional rules are true. First define the "If" conditional rules, next you can drag and drop actions to the "Then" section. These actions will only be run if all conditional rules are true.

## **11.5.2. Action Lists and Selections**

A lot of the actions that can be defined in an Action List require a **selection**. For example, a "Shaper" action is run on the selected objects.

You can define this selection in the Action List itself, by starting with a **Selection** action. This means the Action List can be run both in the editor and on the server.

In ArtPro+, you can also make a selection prior to running the Action List.

Any selection is maintained throughout the Action List until another selection is made.

In an automated workflow on the server, you obviously can't make a manual selection prior to running the Action List. If no selection action is defined, or if the Selection action doesn't result in any selected objects, the action won't do anything, since it would be run on an empty selection.

When it comes to **layer selections**, if no layer is selected, the active layer is used. In ArtPro+ this is the one marked in bold. In an automated workflow, this means the topmost layer.

### 11.5.3. Parameters in Action Lists

If the settings of an Action in an Action List contain an input field, you can set a static, fixed value, or you can use a **Parameter**.

An icon at the right side of the input field indicates the type of parameter that can be used: text, a percentage, a distance, ...

You can set a static, fixed value, or you can use an **Action List Parameter**. An Action List Parameter has one specific value in ArtPro+. However, when running the Action List on Automation Engine, the value for the Parameter becomes visible and can be changed in the Automation Engine Pilot, either as a fixed value or using SmartNames. For more information on Automation Engine, we refer to the Automation Engine documentation.

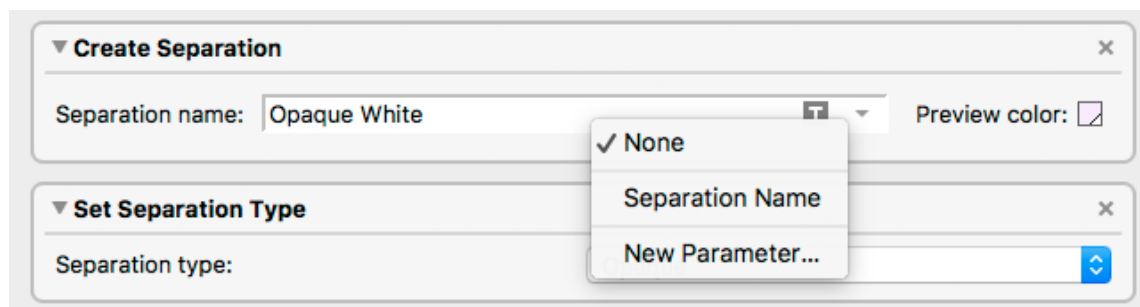

- Enter a value in an input field to use a static value
- Click the Parameter Type icon or the triangle, and select **New Parameter...** to create a new Action List Parameter.

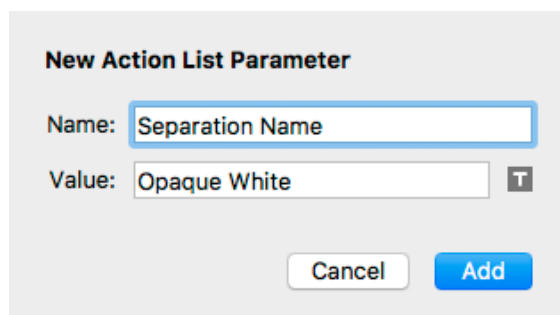

You can then define the name and initial value for the Parameter. If the input field already had a value, this will be used as initial value for the Parameter.

When you click the **Add** button, the newly created Parameter will be used in the input field, shown in blue.



- If you click the Parameter Type icon or the triangle, the dropdown will show all existing Parameters of the same type (text, percentage, ...). Click it to use it.
- Click the Parameter Type icon or the triangle, and select **None** to go back to using a static parameter.

**Note:** When saving the Action List, Action List Parameters that are not used, will be removed.

## 12. Studio in ArtPro+

---

Studio is a unique set of tools for 3D packaging design made specifically for packaging artwork professionals.

For a full overview of the Studio workflow, we refer to the Studio documentation: <https://www.esko.com/en/support/product?id=Studio%20Essentials>

If you have the appropriate licenses, you can now also use some Studio functionality inside ArtPro+. See [Licensing](#) on page 25

- **3D View:** If you have a 3D ARD or Collada file placed, a 3D preview is shown in the bottom left corner. See [3D View](#) on page 343
- Revolve an ArtPro+ path in Toolkit: see [Creating a revolved shape with labels](#) on page 344
- Apply **Predistortion:** see [Predistortion](#) on page 346
- Export a 3D file: see [Export 3D](#) on page 348

### 12.1. 3D View

---

If you have a 3D ARD or Collada file placed, a 3D preview is shown in the bottom left corner. See also artpro [Working with Structural Design files](#) on page 180

•



You can click the 3D button in the toolbar to hide or show the 3D preview.

- You can click and drag the top right corner of the 3D View panel to resize it.
- You can click and drag to rotate the 3D object.
- You can hold the shift key and click and drag to move the 3D object left, right, up or down (Panning).
- You can reset the camera position by double-clicking while holding the shift key.
- You can zoom in and out using the mouse wheel.
- You can also zoom in by holding down the Cmd (Mac) or Ctrl (Windows) key and dragging a rectangle around the area you want to zoom in on. Your ArtPro+ document will zoom in on the corresponding part.

#### Notes and restrictions:

- The 3D object is shown on a white background, using a default floor reflection. The 3D View is shown in "Designer quality". For more information on Designer Quality, we refer to the Studio documentation.
- 3D View shows all artwork separations, regardless of the visibility state of separations, layers or objects. The printing states of layers is respected: non-printing artwork layers will not be shown in the 3D View.
- 3D View doesn't work when using ArtPro+ in a remote desktop environment on Windows.
- In a PDF+ document you can have more than one structural design. If multiple structural design objects are found on the same page, the top one (according to the Object Browser) will be used in the 3D View.

## 12.2. Creating a revolved shape with labels

---

Using the combination of ArtPro+ and Studio Toolkit, you can create a shape (e.g. bottles) based on a profile path, and add labels to it.

1. Create the path in ArtPro+. See [Create a profile path](#) on page 344
2. Send the path to Studio Toolkit to be revolved. See [Revolve in Toolkit](#) on page 345
3. In Studio Toolkit, create the revolved shape, and add labels to it. Save as Collada with printable parts.
4. Place the Collada Structural Design file in ArtPro+, and add graphics to the created labels. See [Working with Structural Design files](#) on page 180

### 12.2.1. Create a profile path

The first step in creating a revolved shape is creating or selecting the ArtPro+ paths to be used as profile paths.

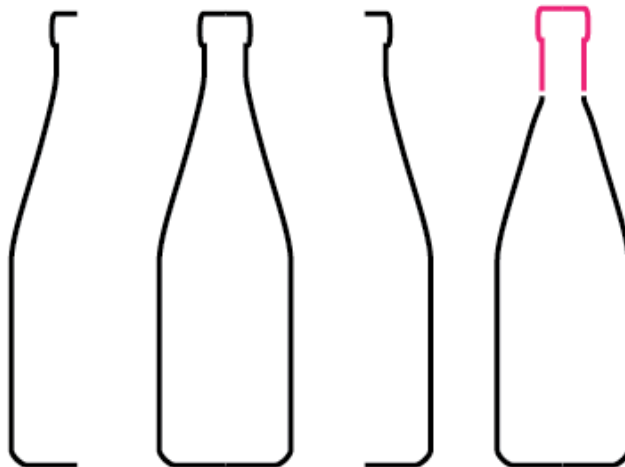

Studio supports half profiles, full profiles and multi-part profiles (based on multiple paths). Multi-part profiles can be used to set different materials for different parts (for example the bottle and the cap).

It is important to connect paths that can share the same material.

In the example below, the shape consists of two parts. The bottle itself which will have glass as material and the cap which will be metal.





## 12.2.2. Revolve in Toolkit

1. Select the paths you want to revolve.

In the example used in [Create a profile path](#) on page 344, the shape consists of a bottle and cap, and consists of two paths.

2. Choose **Object > Path > Revolve in Toolkit**

The selected paths will be opened in Studio Toolkit, where you can revolve the shape:

1. Select the axis to revolve around
2. Set the material to be used
3. Add labels to the shape
4. Save as Collada file

For a full explanation of using Studio Toolkit, we refer to the Studio documentation: <https://www.esko.com/en/support/product?id=Studio%20Essentials>



## 12.3. Predistortion

---

You can use the **Warp** tool to predistort objects or groups of objects to compensate for the distortion of the shrink sleeve on the 3D shape. Together with the 3D preview, you have a perfect 3D visual feedback to make sure the designs look good after shrinking as well.

1. Place the structural design file of the Shrink Sleeve
2. Select and position the objects you want to warp correctly on the Structural Design file.
3. Open the **Warp** dialog:
  - click the **Warp** button in the upper toolbar, or
  - choose **Prepress > Warp > Warp...**, or
  - use its shortcut **Cmd+Shift+D** (Mac) or **Ctrl+Shift+D** (Windows)

The Warp dialog will show a preview of the warped objects. You can use the same tools as in the 3D View to rotate, move, zoom, ... See [3D View](#) on page 343

4. Check that your structural design is selected in the **Grid or Structural Design** dropdown.

**Note:** If your structural design is a Collada file with multiple printable parts, only one printable part can be used for warping.

5. Set the **Predistortion Method**
  - a) **Preserve Vertical Features** will Predistort the selected objects so that after shrinking, vertical elements are still preserved.



- b) **Preserve Width** will Predistort the selected objects so that after shrinking, the width of the different elements are preserved.



6. Select the **Smoothness** of the predistortion
7. Set the **Origin** for the predistortion. You can choose to use the center of the selection, or use the center of the crosshair.
8. Set the **Strength** to define the amount of deformation you want to apply.
9. By default the **Optimize for View Angle** is set to the current view angle in the 3D Preview. If you want to optimize the predistortion for a different viewing angle, you can either enter the rotations in the input fields, or click **From Preview** to take the angles from the current preview.
10. Set the **Minimum Image Resolution**. This defines the minimum resolution of images created by the warping. If an image has a resolution above the minimum, it will keep its resolution after warping. Warping images with a lower resolution as well as gradients will result in an image at the Minimum Image Resolution.
11. Set the amount of **Noise** to be added for gradients, which are replaced by images during warping.
12. Click **Warp**



- The result of the warp action is **Warped Art**
- If you select a warped object, you can click **Unwarp** to return it to its unwarped version.
- If you select a warped object, you can click **Expand** to replace it by regular objects: paths, images, etc.

## 12.4. Export 3D

---

If you have a 3D ARD or Collada file placed, you can use **Export 3D** to export your document in a 3D format:

- A Collada file (\*.dae), that can be used e.g. in Studio application such as Studio Toolkit or Store Visualizer, or in a 3rd party 3D application, or in an Esko Viewer.
- A dynamic 3D PDF file. In Adobe Reader or Acrobat Professional (version 8.0.1 or later) you can view / rotate 3D objects in PDF files.
- A binary glTF file. glTF is a standard file format for 3D scenes and models, and can be used in various applications, e.g. Microsoft Office. You can export .glb files, which are self-contained, binary glTF files, that don't need any specific software to view a package in 3D.

1. Select **File > Export to > 3D...**

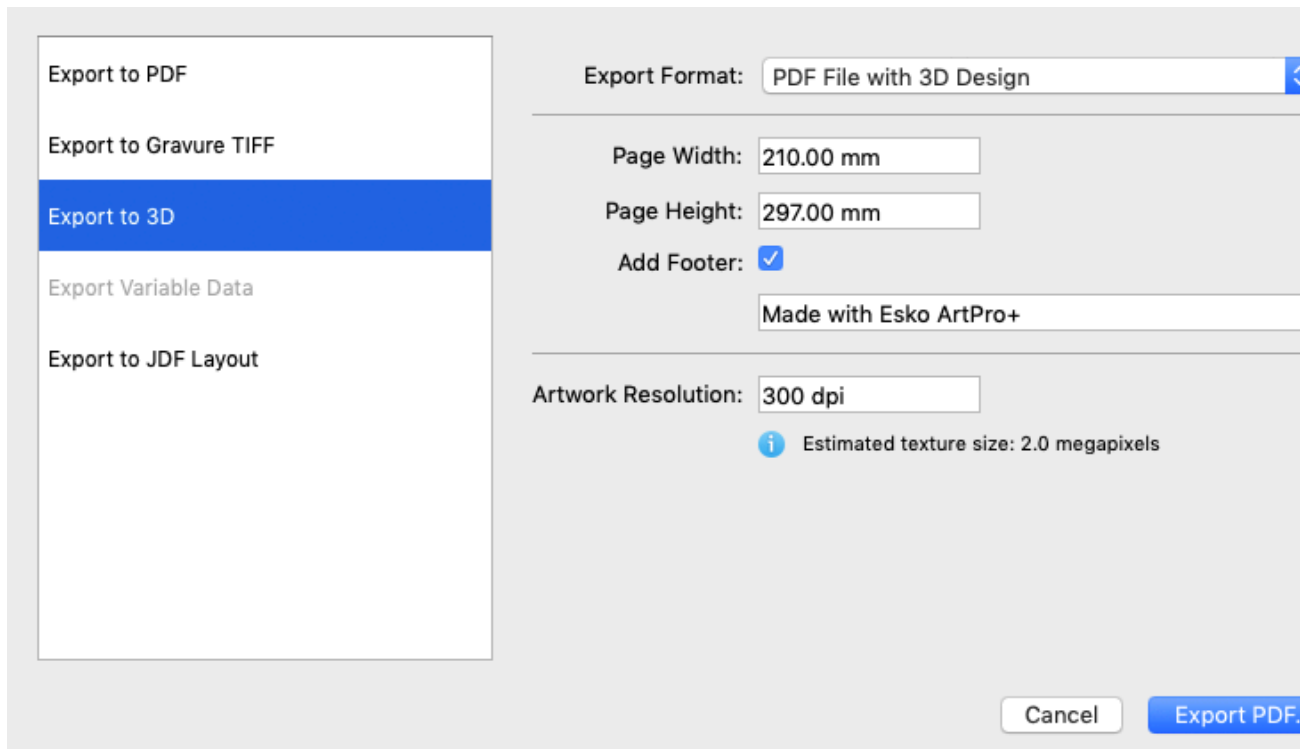

2. Select the **Export Format**: Collada, PDF File with 3D Design or Binary glTF File/
3. When exporting a PDF file, you can define the **Size** of the PDF file. Since the PDF file is only meant for on-screen viewing, this size is of little importance. The **Add Footer** option allows you to switch on or off the footer text. Instead of the default Esko text you can also personalize the footer text and include your own message.
4. Specify the **Resolution** for the graphics.
5. When exporting to glTF, you can enable **Optimize for Microsoft Office** to avoid incorrect 3D previews caused by limitations in the Microsoft Office viewer.
6. Click **Export Collada**, **Export PDF** or **Export binary glTF**

## 13. Variable Data

---

Variable Data provides you the ability to generate jobs with variable elements, retrieved from a database.

This is the typical workflow when working with Variable Data:

1. Create or open the design.
2. Convert it to a **Variable Data Template**. See [Convert to Variable Data Template](#) on page 350
3. Connect it to a **database**. See [The Variable Data database](#) on page 352
4. Create **Variable Data Objects**. This can be a text box containing variable text, a barcode with its code retrieved from the database, or an image. See [Creating and editing Variable Data Objects](#) on page 353.
5. You can **Check** the document and database to search for errors. You can define what checks should be done, and check your document manually, or **Preflight** for all records in the database before expanding. See [Checking your Variable Data Template](#) on page 360
6. **Export** the Variable Data Template. This will expand the variable data and generate multiple variations of the document, one for every record. These can be combined into a multipage PDF file, one page for each record in the database, or placed next to each other in a Step&Repeat. See [Export Variable Data](#) on page 365

**Note:** To Export a Variable Data Template you need a Variable Data Expansion license.

### 13.1. Convert to Variable Data Template

---

The first step in working with Variable Data, is converting a PDF+ file to a Variable Data Template.

1. Create or open the PDF+ document you want to use.

**Note:** You can only convert PDF+ files to a Variable Data Template. If you want to convert a Normalized PDF, you should convert it to PDF+ first. See [Convert to PDF+](#) on page 54

2. Choose **File > Convert to Variable Data Template...** or **Prepress > Variable Data > Convert to Variable Data Template...**
3. Select the **Database** you want to use. For more information on the database, see [The Variable Data database](#) on page 352

If the conversion is successful:

- the document title will show "(Variable Data Template)"
- the Variable Data side drawer will be available, along with the Variable Data button in the toolbar. See [The Variable Data Side Drawer](#) on page 351
- All Dynamic Marks will be expanded. The **Marks** section in the Side Panel is no longer shown.
- The **Message Side Drawer** now has a Variable Data section

## 13.2. The Variable Data Side Drawer

When you are working in a Variable Data Template, an extra Side Drawer is available: the **Variable Data Side Drawer**.

Just like all other side drawers, this side drawer can be shown by clicking the Variable Data button



Variable Data

. You can hide it by clicking the button again, or by selecting another side drawer.



1. In **Database** you can see the name of the currently selected database. You can select another database by choosing **Browse** in the dropdown. See also [The Variable Data database](#) on page 352

2. **Record** indicates what record from the database is currently used in your document. You can select a specific record by entering the number in the field, or you can browse through the records using the arrow buttons.
3. Use the **Preflight** button to check all records in the database. See [Checking your Variable Data Template](#) on page 360
4. Using the **Expand** button you can expand your Variable Data Template. See [Export Variable Data](#) on page 365
5. This is an overview of all **Database fields** and the values for the currently selected record.
6. You can set checks on the database or on specific database fields. See [Checking the Database Records and Fields](#) on page 362
7. In the **fly-out menu** you can select **Reload Database**, or you can set the **Database Options**. See [The Variable Data database](#) on page 352
8. The **Variable Data Objects** are listed here.
  - Clicking a Variable Data Object in the list will select the corresponding object in your document.
  - You can double-click a Variable Data Object in the list to rename it.
  - Using the contextual menu (right-click) you can also lock, hide or rename objects.
9. If you have a text object, barcode or external file selected in your document, you can click the **Convert to Variable Data Object** button to make it a Variable Data Object. See [Creating and editing Variable Data Objects](#) on page 353
10. The **Variable Data Messages** shows Variable Data errors and warnings for the **current record**. See also [Checking your Variable Data Template](#) on page 360
11. Enable **Zoom to Selection** to automatically zoom in on the object(s) you select in the Variable Data Side drawer.

### 13.3. The Variable Data database

---

The Variable Data database is a CSV file: a list of values, separated by a comma or another delimiter. The database contains:

- a title row. These entries will be used as **label**
- multiple rows, each representing a **record**. Every record will result in a different variation
- every row contains **fields**. The values of the fields will define the content for that record.

	A	B	C	D
1	Variation	Text Box 1	Barcode	
2	1	This is text for record 1	0000001	
3	2	This is text for record 2	0000002	
4	3	This is text for record 3	0000003	
5	4	This is text for record 4	0000004	
6				

The database you use for Variable Data should be in CSV format, using UTF-8 encoding.

When using an invalid database, the conversion will not happen. A database can be invalid for different reasons:

- if it is not a valid CSV file



- if the first record contains invalid (UTF-16) characters, or if it has unsupported features (e.g. new lines inside a field).

The Variable Data Side Drawer shows the currently selected database file. If the currently used database file can't be found, a triangular warning icon will be shown.

You can select **Browse...** to select a different file.

If changes are made to the database, you need to reload the database in the Variable Data Template, by opening the fly-out menu in the Variable Data Side Drawer and selecting **Reload Database**.

In the fly-out menu of the Variable Data Side Drawer, you can choose **Database Options....**

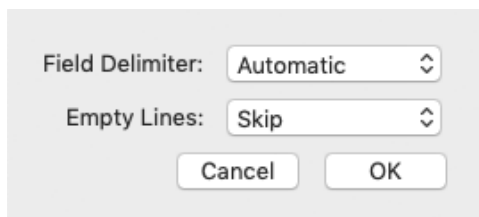

If **Field Delimiter** is set to Automatic (default), ArtPro+ detects which delimiter is used in the database. You can also set it fixed to space, tab, comma or semicolon. Note that setting a different delimiter than what is used in the database will result in errors.

You can also decide how to handle **Empty Lines**: either Skip (default) or Load. When loading the empty lines, these will be visible, and will be shown as error during Preflight or while browsing the records.

## 13.4. Creating and editing Variable Data Objects

Variable Data Objects are objects whose content changes based on the selected record of the database. Variable Data Objects can be created from a text object, a barcode or a linked placed image.

- In a Variable Data Text Object, the content of the text object can be a combination of static (fixed) text, and text retrieved from the database.
- In a Variable Data Barcode, the barcode code can be a combination of static (fixed) text, and text retrieved from the database.
- In a Variable Data External File, the URL of the external file can be a combination of static (fixed) text, and text retrieved from the database.

**Note:** Variable Data External File only supports images. It is not possible to create a Variable Data External File from a placed PDF.

To convert an object to a Variable Data Object:

1. Select a single text object, a single barcode or a single external file (image) in your Variable Data Template.

**Note:** Only these barcodes can be converted to Variable Data Barcodes: QR, Micro QR, Data Matrix, Code 39, Code 128, EAN-8, EAN-13, UPC-A and UPC-E.

2. Convert the object to a Variable Data Object. There are two ways:

- In the Variable Data Side Drawer, click the Create Variable Data Object button  and select **Convert to Variable Data Text Object**, **Convert to Variable Data Barcode Object**, or **Convert to Variable Data External File Object**
- Select **Prepress > Variable Data > Convert to Variable Data [...] Object**

The created Variable Data Objects will be listed in the Variable Data Side Drawer.

3. Set the **Position** of the Variable Data Object. See [Positioning a Variable Data Object](#) on page 354
4. Use the **Variable Data Objects Inspector** to set up the Variable Data Object, such as defining what database entries to use in the content. See [Using the Variable Data Objects Inspector](#) on page 355
5. You can use the **Fill Color Inspector** or **Stroke Color Inspector** to define a variable color for the fill or stroke of a Variable Data Object. See [Using variable color in Fill or Stroke Inspector](#) on page 360
6. Use the regular Inspectors to set the properties of the Variable Data Objects. You can e.g. use the **Barcode Inspector** to set the Cell Size of your Variable Data Barcode, or you can use the **Text Inspector** to set the font and size of a Variable Data Text Object.

**Note:** You can only edit the style (font, size, ...) of the complete Variable Data Text Box.

**Note:** You can **Expand** the currently selected Variable Data Object to a normal object using the **Expand** button in the Inspector bar. See also [Expand](#) on page 139

### 13.4.1. Positioning a Variable Data Object

You can set the position of a Variable Data Object using the Transformation Inspector.

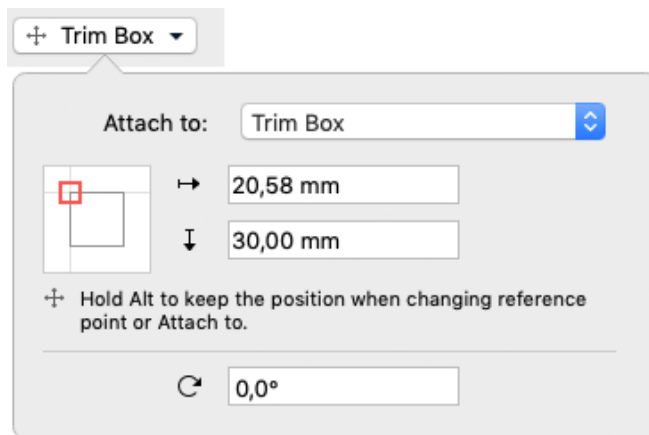

It is based on 3 settings:

#### Attach to

The position of the Variable Data Object can be based on

- Any page box: Media Box, Crop Box, Bleed Box, Trim Box or Art Box
- another Variable Data Object
- any named object, i.e. every object that is listed in the Named Objects Browser. See [Object Browser](#) on page 99.

### Positioning

The way the Variable Data Object is attached, can be chosen by clicking and dragging the colored square (representing the Variable Data Object) to the desired position on the gray square (representing the **Attach To** reference). Each square has 9 reference points (top left center and right, middle left center and right, and bottom left center and right), so you have 81 different ways of positioning the Mark.

In the example underneath, the top center of the (bounding box of the) Variable Data Object will be placed on the left bottom corner of the (bounding box) of the reference defined in the Attach to field.



### Offset & Rotation

In the offset fields, you can move the Variable Data Object based on the defined position. A positive value for offset moves the Variable Data Object in the direction indicated by the arrows.

Using the **Rotation**, you can rotate the Variable Data Object.

### Changing the "Attach To" of a Variable Data Object

When changing the "Attach To" of a Variable Data Object, by default the Offset values are kept, and the Variable Data Object will be repositioned.

However, by holding the **Alt** key, you can keep a Variable Data Object at its the position, and the **Offset** values will be recalculated.

## 13.4.2. Using the Variable Data Objects Inspector

Using the Variable Data Objects Inspector you can make all settings for the selected Variable Data Object.

The settings in the Variable Data Objects inspector depend on the type of Variable Data Object that is selected:

- [Settings for Variable Data Text Objects](#) on page 356
- [Settings for Variable Data Barcodes](#) on page 357
- [Settings for Variable Data External Files](#) on page 358

## Settings for Variable Data Text Objects

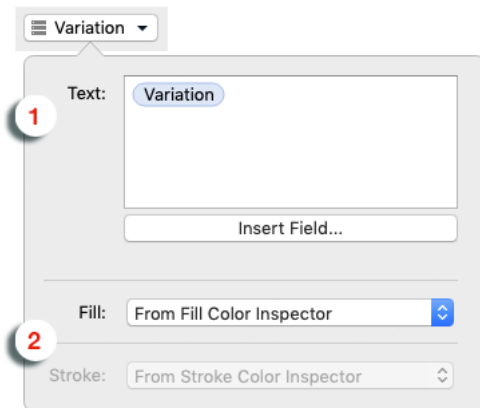

**1. The **Text** field.**

The text in a Variable Data Text object can't be changed using the normal Text tools. Instead, it can be set in the **Variable Data Objects Inspector**.

You can modify the (static) text and you can add **Variable Data Fields**. These fields will be replaced by the content of the corresponding database record. See [Using Variable Data fields](#) on page 359. To do so, position the cursor where you want to enter the field, and click **Insert Field**

The **Preview** will show the result of the selected static text and Variable Data Field(s) for the currently selected record.

**2. Fill / Stroke:** you can choose to set the Fill or Stroke color of a text object to use the color from the Fill Color Inspector or the Stroke Color Inspector, or you can set it to **From Separation:**

- a) Enter the separation you want to use manually, or click the Insert Variable button  to select a variable from the database. You can't combine both.
- b) Enter the **Density** you want to use.

**Note:** If you are using the color from the Fill Color Inspector or the Stroke Color Inspector, you can use database fields to define a variable color. See [Using variable color in Fill or Stroke Inspector](#) on page 360

## Settings for Variable Data Barcodes

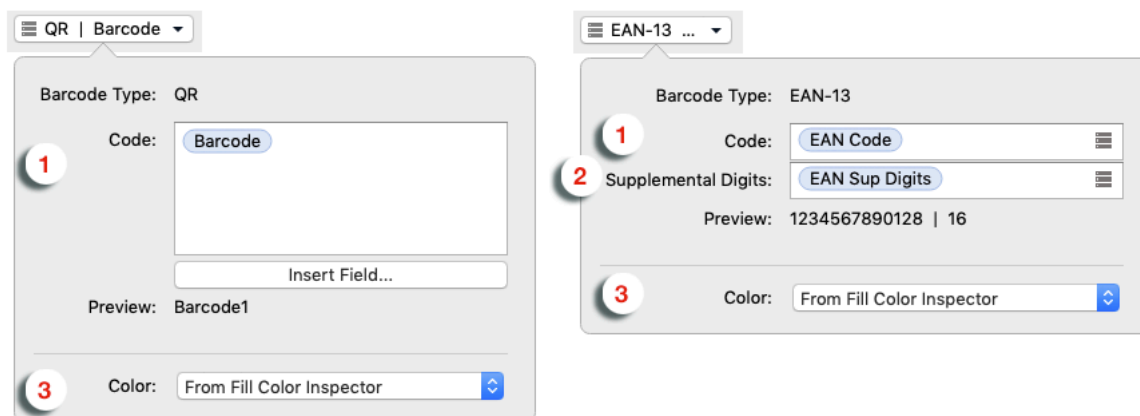

### 1. The **Code** field.

The code of a Variable Data Barcode can't be changed using the normal Inspectors. Instead, it can be set in the **Variable Data Objects Inspector**.

You can modify the code, and you can add **Variable Data Fields**. These field(s) will be replaced by the content of the corresponding database record. See [Using Variable Data fields](#) on page 359. To do so, position the cursor where you want to enter the field, and click **Insert Field** or the **Insert Field button** .

The **Preview** will show the result of the selected static text and Variable Data Field(s) for the currently selected record.

### 2. If the selected Variable Data barcode is an EAN-8, EAN-13, UPC-A or UPC-E code, you can add **Supplemental Digits**.

### 3. **Color**: you can choose to set the color of a barcode object to use the color from the Fill Color Inspector, or you can set it to **From Separation**:

- a) Enter the separation you want to use manually, or click the Insert Variable button  to select a variable from the database. You can't combine both.
- b) Enter the **Density** you want to use.

**Note:** If you are using the color from the Fill Color Inspector, you can use database fields to define a variable color. See [Using variable color in Fill or Stroke Inspector](#) on page 360

## Settings for Variable Data External Files

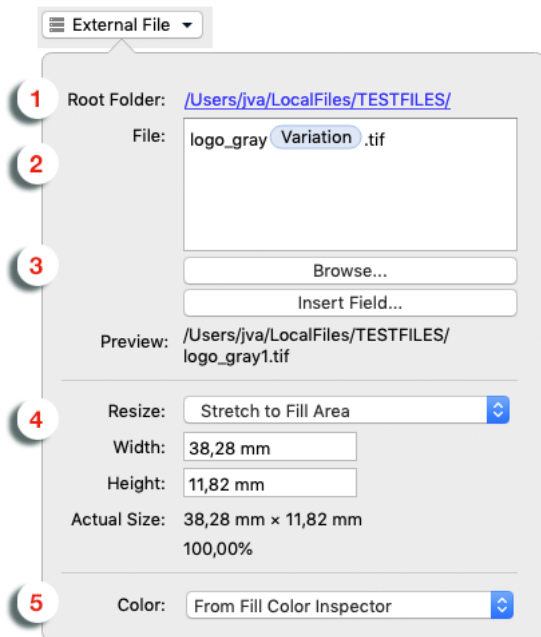

1. The **Root Folder** is the location where the external files are to be found. You can click the link to browse to a different location. Note that you can use (variable) relative paths in the **File** input field (see below)
2. The **File** field.

The file name of the Variable Data External File can be set in the **Variable Data Objects Inspector**.

You can modify the static parts of the file name, and you can add **Variable Data Fields**. These fields will be replaced by the content of the corresponding database record. See [Using Variable Data fields](#) on page 359. To do so, position the cursor where you want to enter the field, and click **Insert Field**

You can use **relative paths** in the File field, and you can use Variable Data Fields in those relative paths. For example: [job id]/images/[filename]

The **Preview** will show the result of the Root path, the selected static text and Variable Data Field(s) for the currently selected record.

3. You can use the **Browse** button to select an external file. Root folder, File and Preview will be updated automatically.

4. Define how to apply the external file:

a) Define how to resize:

- **Stretch Vertically**: the content is stretched to match the entered height. The width is at 100%.
- **Stretch Horizontally**: the content is stretched to match the entered width. The height is at 100%.
- **Stretch to Fill Area**: the content is stretched to match both the entered height and width.

- **Scale to Fit Inside Area:** the content is scaled (up or down) proportionally to fit inside the defined area (width and height).
- **Shrink to Fit Inside Area:** the content is scaled down proportionally if necessary to fit inside the defined area (width and height). The content is never scaled up.
- When selecting **Scale Relatively** you can enter the scale factor for both vertical and horizontal scaling (in percentage).

**Note:** The **Stretch** options and **Scale Relatively** are non-proportional: the vertical and horizontal scaling factors can be different. The **Scale** and **Shrink** options are proportional: vertical and horizontal scaling factors are the same.

b) Define the **Width** or **Height**.

At the bottom of the inspector you can see the actual size of the image based on the current record, including the applied scaling factor (a single percentage for proportional scaling, a scaling factor for vertical and horizontal scaling for non-proportional scaling).

5. If the Variable Data External File is based on an image using one single separation (a grayscale, bitmap image or a Multichannel image using only one separation), you can set the **Color**: you can choose to use the color from the Fill Color Inspector or the Stroke Color Inspector, or you can set it to **From Separation**:

- Enter the separation you want to use manually, or click the Insert Variable button  to select a variable from the database. You can't combine both.
- Enter the **Density** you want to use.

While browsing through the records of the database, an error message will be shown in case recoloring is not possible. Make sure to only use variable coloring when you know all records in the database are referring to monochrome images.

**Note:** If you are using the color from the Fill Color Inspector or the Stroke Color Inspector, you can use database fields to define a variable color. See [Using variable color in Fill or Stroke Inspector](#) on page 360

## Using Variable Data fields

When setting up the text, barcode code or URL of a Variable Data Object, you can add Variable Data Fields, to retrieve information from the database.

1. Place your cursor where you want the variable to be, or select the text to replace with a variable. Click the **Insert Field...** button.
2. In the **Insert Field** dialog that opens, choose the fields to insert:
  - a) Select **Standard** to select variables from the database: either the number of the **current record** or the total **number of records** in the database
  - b) Select **Database** to select a field from the database, and choose the **Field** you want to use. The fields are shown using their header names in the CSV database file. You can enter a **Search key** to find the field you're looking for.

**Note:** The **Preview** line shows how the field will be resolved using the current record.

- c) When your field is completely set up, click **Insert**.

The variable parts in the **Text**, **Code** or **File** field will appear as a blue block with black text.

### 13.4.3. Using variable color in Fill or Stroke Inspector

If you are using a flat color fill or stroke on a Variable Data Object, you can use a database field to set the percentage for one or more separations.

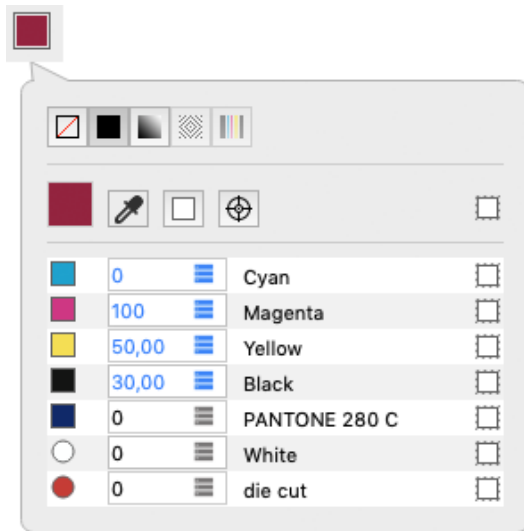

1. For the separation you want to use a variable percentage, click the **Insert Variable** button 
2. Select the Variable Data field you want to use, and double-click it or click **Insert**. See also [Using Variable Data fields](#) on page 359

**Note:** Unlike in Variable Data Text or the code of a Variable Data Barcode, you can only select one field. You can't combine it with other fields or with static text.

3. If needed, repeat these steps for other separations.

The values that are taken from the database are shown in blue. The Inspector will show the values for the currently selected record.

**Note:** If you use a database field to define the Fill or Stroke color of a Variable Data Object, these fields should contain numeric values between 0 and 100. If not, an error will be generated, and the value for that separation will be set to 0%. The value will be shown in red in the Fill or Stroke Color Inspector.

## 13.5. Checking your Variable Data Template

One of the pitfalls of working with Variable Data, is that the data retrieved from the database might not match up with the Variable Data Objects you use it in. Fields might be missing or containing unusable data, the database could contain invalid delimiters, text could end up outside of the trim box, etc. For more information, see [Common errors in Variable Data](#) on page 361

1. You can check the database and the database fields. See [Checking the Database Records and Fields](#) on page 362



2. For every Variable Data Object, you can set the **checks** ArtPro+ should perform in the **Checks Inspector**. See [The Checks Inspector](#) on page 363
3. You can manually go through some (or all) of the records using the navigation buttons in the Variable Data Side Drawer. See [The Variable Data Side Drawer](#) on page 351

For every record you navigate to, ArtPro+ will show all errors and warnings it encounters in the **Message Side Drawer**

**Note:** The Variable Data Messages in the **Variable Data Side Drawer** only shows the errors and warnings for the current record, while the **Messages Side Drawer** shows the error messages for all records you've navigated to or did a preflight on.

4. When clicking the **Preflight** button in the Variable Data Side Drawer ArtPro+ will go through all records in the database, and show all errors and warnings it encounters in the **Messages Side Drawer**.

**Note:** The messages are cleared when reloading the database, selecting another database or reopening the Variable Data Template.

### 13.5.1. Common errors in Variable Data

#### Generic errors

##### Database records that can't be read

Some errors prevent the database record from being read at all. In that case, you will not be able to navigate to that specific record and it will be skipped in the preflight.

Typical problems are the use of invalid delimiters, a new line in a record, wrong record size, a utf-8 error and other encoding errors.

**Fix:** fix the errors in the database and reload it.

##### Static Objects Above Variable Data Objects

It is recommended to position Variable Data Objects at the top, above any regular objects. If this is not the case, a warning is shown in the Messages.

**Fix:** move all Variable Data Objects on top of the regular objects.

##### Potential Transparency Conflict

If a transparency group contains a mix of regular objects and Variable Data Objects, this will have to be split in two separate transparency groups during export. Since this can lead to a visual difference compared to the original Variable Data Template, a warning will be shown.

#### Errors for Variable Data Text Objects

##### Missing Font Data

Certain characters are not available in the font that is used by the Variable Data Text Object.

**Fix:** you can select the Variable Data Text Object and use a different font, or change the value in the database and reload it.

##### Protected Font Replaced

The font used in the Variable Data Text Object is a protected font. Because text editing is not allowed in that case, the font is being replaced by the system default font.

### **Errors for Variable Data Barcodes**

#### **Empty Code**

No code at all was entered for the Variable Data Barcode.

**Fix:** add a code in the Variable Data Objects inspector

#### **Empty Resolved Code**

The code consists of one or more database variables which are all empty in the current record of the database, or that don't exist in the current database.

**Fix:** you can change the code in the Variable Data Objects inspector, or add a value in the database and reload it, or load a different database.

#### **Unresolved Code**

The database is not found or invalid.

**Fix:** correct and reload the database, or relink to the database.

#### **Code Too Long**

The resolved code is too long according to the barcode specification.

**Fix:** you can change the code in the Variable Data Objects inspector, or change the value in the database and reload it, or load a different database.

### **Errors for Variable Fill or Stroke color**

#### **Invalid Separation Density Value**

If you use a database field to define the Fill or Stroke color of a Variable Data Object, these fields should contain numeric values between 0 and 100. If not, an error will be generated, and the value for that separation will be set to 0%.

## **13.5.2. Checking the Database Records and Fields**

The checkboxes next to the database name or the database fields in the Variable Data Side Drawer indicate if a check is defined: if the checkbox is disabled no check is defined, if the checkbox is enabled a check is set on the specific field or on the database.

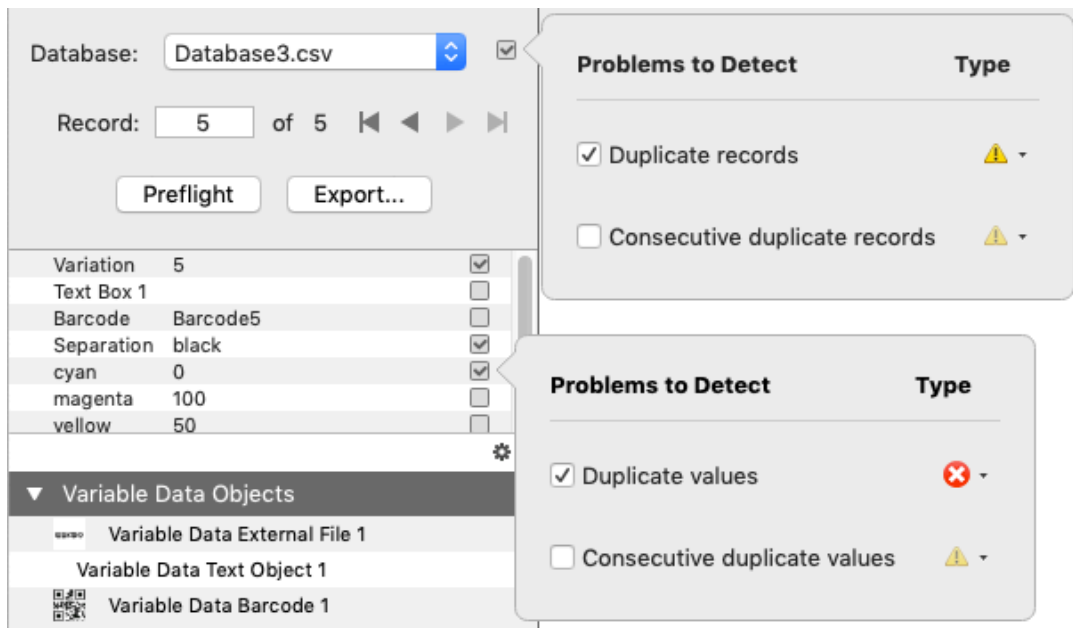

1. Click the checkbox next to the database name or next to a database field in the list
2. In the dialog that opens, define what problems you want to detect
  - For the database, you can check for **Duplicate Records** (e.g. record 3 and 5 have the exact same values for all fields) or **Consecutive duplicate records** (e.g. record 5 and 6 have the exact same values for all fields).
  - For a database field, you can check for **Duplicate values** (e.g. record 3 and 5 have the same value for the selected field) or **Consecutive duplicate values** (e.g. record 5 and 6 have the same values for the selected field).
3. Set the severity: either **Error** or **Warning**

The difference between a warning and an error is that an error will stop further processing the database record(s), while a warning is shown in the Messages Side Drawer, but processing continues.
4. Click outside of the dialog to close it.

### 13.5.3. The Checks Inspector

For every Variable Data Object, you can set what possible problems should be checked, and how those should be handled in the **Checks Inspector**.

**Note:** The difference between a warning and an error is that an error will stop further processing the database record(s), while a warning is shown in the Messages Side Drawer, but processing continues.

#### Checks for Variable Data Text Objects

##### Object is outside Trim Box

- Checks if the resolved Variable Data Object is (partially or completely) outside of the Trim Box.
- If a **Safe Margin** is defined, the object will also generate a warning or error if it is within that distance of the Trim Box.

- Can be a **warning** or an **error**.

**Text is empty**

- Checks if the resolved text is empty.

**Note:** An empty field in the database will not result in an error if it is combined with static text or with another (non empty) variable.

- If **Whitespace characters count as empty** is enabled, a text element containing only whitespace characters will generate the same warning or error as a completely empty text element.
- Can be set to **warning**, **error** or **don't report**.
- You can apply an automatic fix: either **clear object** or **Replace with** where you can set a static text to fill the text object. Automatically fixing is not available if the check is set to **Error**.

**Checks for Variable Data Barcodes**

**Object is outside Trim Box**

- Checks if the resolved Variable Data Object is (partially or completely) outside of the Trim Box.
- If a **Safe Margin** is defined, the object will also generate a warning or error if it is within that distance of the Trim Box.
- Can be a **warning** or an **error**.

**Code is empty**

- Checks if the resolved barcode code is empty.

**Note:** An empty field in the database will not result in an error if it is combined with static text or with another (non empty) variable.

- If **Whitespace characters count as empty** is enabled, a barcode element containing only whitespace characters will generate the same warning or error as a completely empty element.
- Can be set to **warning**, **error** or **don't report**.
- You can apply an automatic fix: either **clear object** or **Replace with** where you can set a static text to fill the barcode. Automatically fixing is not available if the check is set to **Error**.

**Check digit is missing**

Only available for Variable Data Barcodes of type EAN-8, EAN-13, UPC-A and UPC-E.

- Checks if the Check Digit of the barcode is in the resolved code.
- Can be set to **warning** or **error**.
- When set to **warning**, the **Fix Automatically** option is enabled, and the check digit will be added to the code.

**Note:** An incorrect Check Digit will always result in an error, and is not handled by this check.

**Checks for Variable Data External Files**

**Object is outside Trim Box**

- Checks if the resolved Variable Data Object is (partially or completely) outside of the Trim Box.
- If a **Safe Margin** is defined, the object will also generate a warning or error if it is within that distance of the Trim Box.
- Can be a **warning** or an **error**.

**External file is not available**

- Checks if an external file is found at the resolved URL (i.e. the combination of the Root folder and File input).
- Can be set to **warning**, **error** or **don't report**.
- You can apply an automatic fix: either **clear object** or **Replace with** where you can set a fixed file name. The Root folder is used as defined in the Variable Data Object Inspector. Automatically fixing is not available if the check is set to **Error**.

#### External file cannot be placed

- Checks if the external file can be placed. You will get an error if the file type is not supported, or if the external file is invalid.
- Can be set to **warning**, **error** or **don't report**.
- You can apply an automatic fix: either **clear object** or **Replace with** where you can set a fixed file name. The Root folder is used as defined in the Variable Data Object Inspector. Automatically fixing is not available if the check is set to **Error**.

## 13.6. Export Variable Data

---

The final step in the proces of Variable Data, is expanding the Variable Data Template. Expanding means that for every record in the database file, a version of the document is generated. The different versions can be combined in a multipage PDF file (one page for every version), or the different versions can be combined in a Step & Repeat Grid.

In that expanded document, all variable data objects are expanded to regular text objects, barcodes and placed files.

In the **Export**

1. To expand a Variable Data Template, click the **Export** button in the Variable Data Side Drawer, or select **File > Export To > Variable Data...**

The Export dialog will open, with **Export Variable Data** selected.

**Note:** You can click one of the other output options on the left to export to another format. See [Export to PDF](#) on page 58, [Export Gravure TIFF](#) on page 60 and [Export 3D](#) on page 348

2. Set the **Export Format**

- If you select **Expand Variable Data**, the result will be a multipage PDF, one page for every record in the database.

**Note:** In an expanded Variable Data Template, the "regular artwork" is put in a "Form" which is reused on every page. This avoids include the artwork again on every page, and reduces the file size.

- If you select **Expand Variable Data and Step & Repeat** you can use the **Browse** button to select a Step & Repeat Template. The Step & Repeat Template is a PDF containing a Step & Repeat created in ArtPro+. Based on the type of Step & Repeat Template you use, different options will become available. See [Expand to Grid Step & Repeat](#) on page 366 and [Expand to MFG or CF2 Step & Repeat](#) on page 367
3. Click **Export PDF...** to run the export.
  4. Set the name and location for the new file, and click **Export**

### 13.6.1. Expand to Grid Step & Repeat

When Expanding to Grid Step & Repeat, a version (or 'variation') of the document is generated for every record in the database file. The different versions will be combined in a Step & Repeat Grid.

1. Set up a document containing one single Step & Repeat Grid, to be used as template to expand your Variable Data Template on. See [Grid Step & Repeat](#) on page 268
2. Save this file.
3. In your Variable Data Template, click the **Export** button in the Variable Data Side Drawer, or select **File > Export To > Export Variable Data...**

The Export dialog will open, with **Export Variable Data** selected.

4. Set the **Export Format** to **Expand Variable Data and Step & Repeat**
5. Click the **Browse** button to select your Step & Repeat Template.

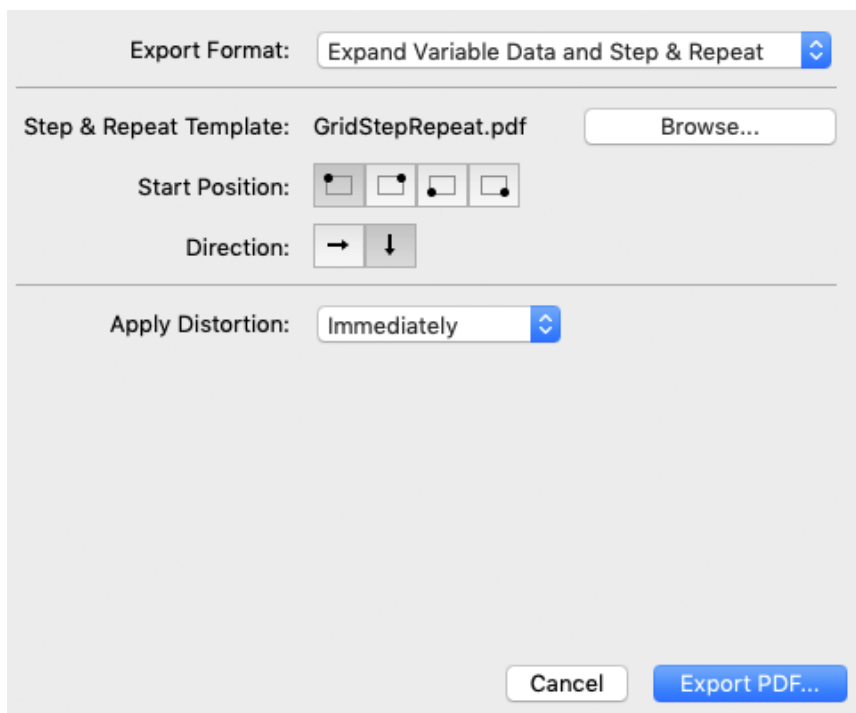

6. Set the **Start Position** to define where the first variation should be placed in the grid: top left, top right, bottom left or bottom right.
7. Set the **Direction** to define where to place the following variations in the grid: horizontal or vertical.

The different variations are placed on the different stations in the Grid file. If there are more variations than stations, the result will be a multipage PDF, containing as many pages as needed to fit all variations. If you place e.g. 40 variations on a 4 by 4 grid, the resulting PDF will contain 2 pages with 16 variations each, and one page containing the remaining 8.

8. If **Apply Distortion** is set to **Immediately**, any distortion factor set in the Document Setup of your Variable Data Template will be applied on the grid after generating it. If set to **Later** no distortion will be done, so you can apply distortion in the Document Setup of the resulting Grid file. See also [Document Setup](#) on page 71

9. Click **Export PDF...** to run the export.
10. Set the name and location for the new file, and click **Export**

### 13.6.2. Expand to MFG or CF2 Step & Repeat

When Expanding to MFG or CF2 Step & Repeat, a version (or 'variation') of the document is generated for every record in the database file. The different versions will be combined in the MFG or CF2 based Step & Repeat.

**Note:** To expand to MFG or CF2 Step & Repeat you need to create a PDF containing the MFG or CF2 based Step & Repeat to be used as Step & Repeat Template. You can not use an MFG or CF2 file as Step & Repeat Template.

1. Set up a MFG or CF2 based Step & Repeat document, to be used as template to expand your Variable Data Template on. See [Step & Repeat based on an MFG or CF2 file](#) on page 278
2. Save this file.
3. In your Variable Data Template, click the **Export** button in the Variable Data Side Drawer, or select **File > Export To > Variable Data...**

The Export dialog will open, with **Export Variable Data** selected.

4. Set the **Export Format** to **Expand Variable Data and Step & Repeat**
5. Click the **Browse** button to select your Step & Repeat Template.

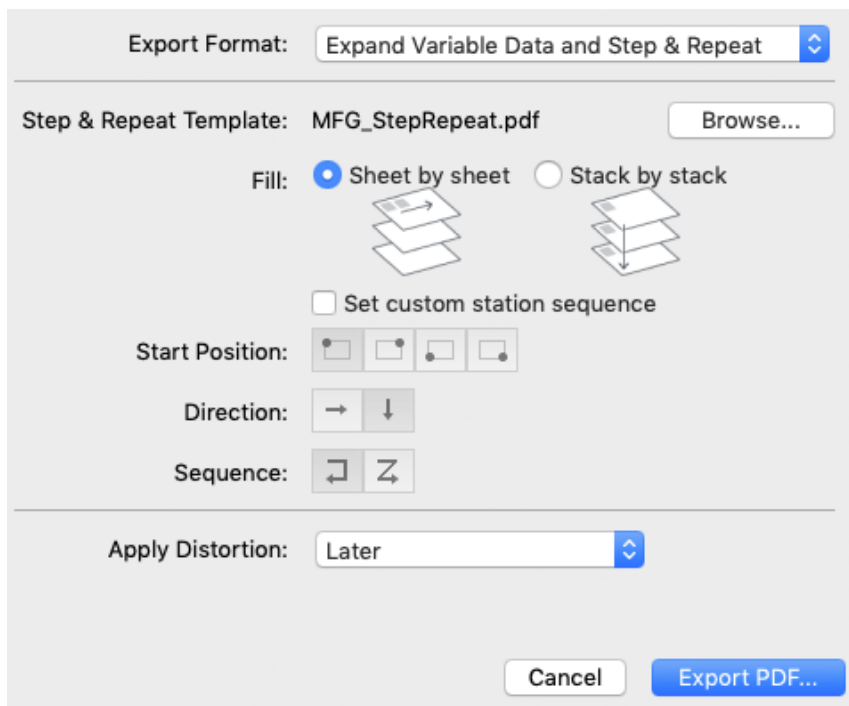

6. Set the **Fill**: either **Sheet by sheet** or **Stack by stack**

The different variations are placed on the different stations in the S&R file. If there are more variations than stations, the result will be a multipage PDF, containing as many pages as needed to fit all variations.

If you have e.g. 40 variations to be placed on a Step & Repeat Template containing 4 stations, the result will be a 10 page PDF.

When set to **Sheet by sheet**, the first sheet will contain variations 1 to 4, the second variations 5 to 8, etc.

When set to **Stack by stack**, the first station will contain variation 1 on sheet 1, variation 2 on sheet 2, variation 3 on sheet 3, etc. That way, after printing, the first station will contain variations 1 to 10, stacked on top of each other.

7. By default the station order as set in the Step & Repeat Template is used. However, you can enable **Set custom station sequence** to overrule that order.
  - a) Set the **Start Position** to define where the first variation should be placed in the grid: top left, top right, bottom left or bottom right.
  - b) Set the **Direction** to define where to place the following variations in the grid: horizontal or vertical.
  - c) Set the **Sequence: Snake (1) or Zigzag (2)**

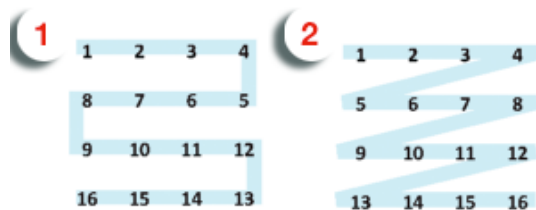

8. If **Apply Distortion** is set to **Immediately**, any distortion factor set in the Document Setup of your Variable Data Template will be applied on the Step & Repeat after generating it. If set to **Later** no distortion will be done, so you can apply distortion in the Document Setup of the resulting Grid file. See also [Document Setup](#) on page 71
9. Click **Export PDF...** to run the export.
10. Set the name and location for the new file, and click **Export**