

ArtiosCAD 18.0.1

Complete Documentation

11 - 2018

Contents

- 1. Location and Copyright.....39**
- 2. In This Manual..... 41**
- 3. Welcome..... 42**
 - Introduction.....42
 - Before you begin.....42
 - If you need help.....42
 - Package contents..... 43
 - Important folders, libraries, and files of ArtiosCAD.....43
 - Folders underneath the version of ArtiosCAD.....43
 - Operating system notes.....45
 - Support for VMware® Fusion.....46
- 4. ArtiosCAD Standard Edition Installation..... 48**
 - Introduction.....48
 - Performing a Typical installation..... 49
 - Performing a Client Installation..... 51
 - Performing a Server/Custom Installation.....52
 - Installing a New Version of ArtiosCAD..... 56
 - Installing a New Build of the Current Version..... 57
 - Installing Microsoft SQL Server 2012 Express Edition Only.....57
 - Using other databases with ArtiosCAD..... 59
 - Other database notes.....59
 - Upgrading other databases with ArtiosCAD..... 59
 - Other database notes.....59
 - Changing to SQL Server Express Edition on the database server..... 60
 - Exporting database information from the old database.....60
 - Loading the upgrade..... 61
 - Automatic migration..... 62
 - Manual migration..... 63
 - Exporting the data..... 63
 - Checking the log file for export errors..... 65
 - Importing the data.....66
 - Checking the log file for import errors.....68
 - ArtiosCAD Database Migration utility command-line options.....69
 - Changing to SQL Server Express Edition on client systems..... 70
 - Network Ports List.....70
- 5. ArtiosCAD Enterprise Installation and Configuration..... 72**
 - Installing ArtiosCAD Enterprise..... 72

Step 1 - Installing WebCenter.....	73
Installing IIS7 on the Web Server.....	74
Install IIS on the Web Server Machine.....	74
Enable 32 Bit Applications.....	77
Extend the Upload Limitation.....	78
Step 2 - Optionally Uploading Boards.....	78
Step 3 - Creating Shared Defaults for the First Time.....	79
Upgrading from Pre-16 Shared Defaults.....	79
Adding New Defaults to an Existing Shared Defaults Project.....	80
Migrating User or Location Defaults.....	80
Step 4 - Creating a New Company and Location.....	81
Step 5 - Creating a New Group.....	81
Step 6 - Creating New Users.....	82
Step 7 - Setting a New User's Group Membership.....	84
Step 8 - Inviting New Users to the Shared Defaults Project.....	84
Step 9 - Installing ArtiosCAD Enterprise on a User's Computer.....	85
Post-Installation Configuration Tasks.....	86
Assigning Default Boards to a Location.....	87
Characteristics.....	87
Create a Characteristic.....	87
Edit or Delete a Characteristic.....	88
Project and Document Attributes.....	88
Create an Attribute Category.....	88
Edit or Delete an Attribute Category.....	89
Create a Restricted Set.....	89
Edit a Restricted Set.....	89
Delete a Restricted Set.....	90
Create an Attribute.....	90
Edit or Delete an Attribute.....	90
Assigning Default Attribute Categories to Document Types.....	91
Configuring ArtiosCAD Enterprise.....	92
Using the Flute Browser.....	92
Opening the Flute Browser.....	92
The Flute Browser Toolbar.....	93
Working with Flutes.....	94
Viewing Flute Details.....	94
Editing a Flute.....	94
Adding a Flute.....	95
Deleting a Flute.....	95
Using the Board Browser.....	95
Opening the Board Browser.....	95
The Board Browser Toolbar.....	96
Working with Boards.....	97

- Viewing Board Details..... 97
- Editing a Board..... 98
- Creating a paper.....98
- Adding a Board.....102
- Renaming, Deleting, Moving, and Copying Board Entries..... 107
- Defaults..... 108
 - Browser Options..... 108
 - Bill of Materials Dialog Box Options.....109
 - Customized Database Information dialog boxes.....110
 - General Database Options.....111
 - Save Options..... 113
 - Setting the Default Folder for Saving Parts in Canvases.....114
 - Export Document Naming Format Options..... 115
 - Sending an Output to a Project..... 116
 - Destination Tab in an Output Definition..... 116
 - Setting the Title Bar Display Options.....117
 - Location Defaults Overview.....118
 - Location Defaults Setup.....118
 - Creating a Location Defaults Project Template..... 121
 - Migrating Defaults from ArtiosCAD Standard Edition to ArtiosCAD Enterprise.....122
 - Migrating User Defaults from ArtiosCAD Standard Edition to ArtiosCAD Enterprise..... 124
- Always Showing All Boards..... 125
- Defaults Availability overview..... 126
 - Setting Defaults Availability for Location Defaults.....126
 - Setting Defaults Availability for User Defaults..... 127
- Configuring the Automatic Naming Templates..... 129
- Using Spot Colors in PDF files..... 131
- Exporting Defaults.....132
- Migrating from ArtiosCAD Standard Edition to ArtiosCAD Enterprise.....133
 - Before You Begin..... 133
 - Customizing the Migration Tuning File..... 134
 - Starting the Migration Utility.....136
 - Migrating Entities..... 137
 - Migrating Flutes..... 139
 - Migrating Boards.....141
 - Migrating Companies.....144
 - Migrating Persons.....146
 - Configuring Design Data Migration..... 150
 - Migrating Characteristics and Userfields..... 151
 - Migrating Characteristics.....152
 - Migrating Restricted Sets..... 154
 - Migrating Userfields.....156
 - Saving Mapping to the Server..... 159

Setting General Options for Project and Document Migration.....	160
Migrating Projects.....	163
Searching for Projects to Migrate.....	163
Performing the Projects Migration.....	165
Recovering from Project Migration Errors.....	167
Migrating Documents.....	168
Searching for Documents to Migrate.....	168
Setting Document Migration Options.....	172
Using an External DLL to Generate The Project Name.....	173
Performing the Documents Migration.....	175
Recovering from Document Migration Errors.....	177
After You Are Done.....	177
Maintenance Tasks.....	178
Pre-10.2 Conversion.....	178
Pre-12.1 Document Maintenance.....	180
Legacy CAD Data Migration.....	182
6. Peripherals.....	185
Installing a Windows printer.....	185
Output Destinations.....	186
Starting the ArtiosIO program.....	187
Creating an Output Destination.....	188
Installing CAM Devices.....	189
Getting started.....	189
Preliminaries.....	189
Windows driver or CAM driver?.....	189
Is there a pre-built output and style?.....	190
Example 1 - Setting up a Kongsberg XL44 samplemaker.....	190
Example 2 - Setting up an Alphameric RS-232 samplemaker.....	192
Example 3 - Adding a Calcomp DrawingBoard III digitizer.....	193
Example 4 - Setting up an i-cut Production Console Output.....	198
iPC Output - Copying the Example Output.....	198
iPC Output - Modifying the ArtiosCAD File Output.....	198
iPC Output - Modifying the JDF-V2 Output.....	198
iPC Output - Modifying the Submit Job-V2 or -V3 Output.....	199
Advanced digitizer setup.....	201
Adding a non-Calcomp digitizer.....	201
Adjusting the step size of the digitizer.....	205
Configuring the Command Map.....	205
Configuring the menu.....	207
Configuring Feedback and Snap.....	208
7. Other tasks.....	211
Uninstalling ArtiosCAD.....	211

Removing individual ArtiosCAD Programs.....	211
Uninstalling SolidWorks separately from ArtiosCAD.....	211
Removing MSDE.....	211
Removing the ArtiosCAD ODBC entry.....	212
Uninstalling a patch.....	212
Modifying and Repairing ArtiosCAD.....	212
Loading an ArtiosCAD patch.....	212
Working with the ArtiosIO Status program.....	213
Using Floating Licenses.....	213
Configuring floating licenses.....	214
Troubleshooting.....	216
Upgrading ArtiosCAD Licenses.....	217
License Manager: keyless.....	217
DataCenter database administration when using MSDE or SQL Server Express Edition.....	218
Backing up the database.....	218
Restoring the database.....	219
Database space management for MSDE.....	219
MSDE-related Application Log entries in Event Viewer.....	220
Using Microsoft SQL Server 2005.....	220
Installing Microsoft SQL Server 2005.....	221
Configuring Microsoft SQL Server 2005.....	233
Creating the ArtiosCADdb database.....	234
Configuring the ODBC driver.....	236
Running the ArtiosCAD database configuration batch file.....	240
Notes and troubleshooting.....	241
Using Microsoft SQL Server 2012.....	242
Installing Microsoft SQL Server 2012.....	242
Configuring Microsoft SQL Server 2012.....	256
Creating the ArtiosCADdb database.....	256
Configuring the 32-bit ODBC driver.....	260
Running the ArtiosCAD database configuration batch file.....	266
Notes and troubleshooting.....	267
Using Oracle.....	268
Replacing an ArtiosCAD server.....	269
8. Defaults.....	271
Introduction to Defaults.....	271
Creating defaults.....	272
Changing defaults.....	272
Saving defaults.....	273
Searching for Defaults.....	273
Performing a Defaults Search.....	274
Defaults performance.....	277
Parameter sets.....	278

Designer parameter sets.....	278
Manufacturing parameter sets.....	278
Counter parameter sets.....	282
Tool Angles, Widths tab.....	283
Periphery tab.....	286
Crease End tab.....	287
Partial cut tab.....	287
Cut and Crease tab.....	288
Chamfer tab.....	290
Reverse Creases tab.....	290
Reverse Cuts tab.....	292
Crease Channel Ends tab.....	293
Embossing tab.....	294
Position Holes tab.....	294
Tack Bridges tab.....	295
Name tab.....	295
Blanking Parameter Sets.....	296
Defining a BSI Blanking Frame Kit.....	296
Rubber types.....	301
Rubber parameter sets.....	303
Bolt holes.....	303
Breaker knives.....	304
Crease Mask.....	305
Cut/Crease.....	306
General.....	306
Layout.....	308
Plastic cover.....	308
Rubber types.....	309
Rebuild options.....	313
3D Hardware Options.....	315
3D Import Options.....	316
3D Rendering method.....	317
Database defaults.....	318
File Operations group.....	320
Performance options group.....	320
Caching.....	321
Pattern searching.....	322
Mixing database performance modes.....	323
Database Information Dialog Customization groups.....	323
Designing a custom Database Information dialog box.....	324
Defining the Tab Key Order.....	327
Working with Tabs.....	328
Using a custom external application.....	331

Default selections group.....	334
Company selection display group.....	334
Spell checking.....	335
Nudge Options and Defaults.....	335
Hatch Defaults.....	336
Hatch Catalog defaults.....	336
Hatch Property defaults.....	337
Hatch Startup defaults.....	338
Adding Purchased Standards to Style Catalogs.....	339
Adding LASERPOINT IQ standards to Style Catalogs.....	342
Preparation.....	342
Adding the standard to a Style Catalog.....	343
Troubleshooting newly-added INTERACT/LASERPOINT/ LASERPOINT IQ standards.....	344
Missing files.....	344
Changing the framework.....	344
Adding Designer WorkBench designs to Style Catalogs.....	344
Preparation.....	345
Adding a Designer WorkBench standard to a Style Catalog.....	345
Default new design template.....	346
Default layers in Manufacturing.....	347
Toolbars.....	350
Customized toolbars.....	350
Icons for customized toolbars.....	351
Making a customized toolbar.....	351
Colored toolbars.....	353
Colors on standard toolbars.....	354
Colors on customized toolbars.....	355
Toolbar Hover Color.....	356
Shortcuts.....	357
Assigning a shortcut to a menu command.....	358
Assigning a shortcut to an Output.....	361
Assigning a shortcut to a geometry macro.....	361
Shortcut uniqueness and priority.....	362
Notes and warnings for Shortcuts.....	363
Tack Bridging.....	364
Bridging Formulae.....	365
Evenly spaced bridging formula.....	366
Bridges on lines and Bridges on arcs groups.....	366
Width of Bridges group.....	367
Inset distance from line end bridging formula.....	367
Working with tuning catalog entries in Defaults.....	368
Creating a PDF vector import tuning catalog entry.....	368
Opening a PDF vector import tuning catalog entry.....	369

Editing a PDF vector import tuning catalog entry using a template.....	370
Editing a PDF vector import tuning catalog entry manually.....	373
Line types.....	374
Subtypes.....	376
Plotting Styles.....	377
Working with simple plotting styles.....	378
Creating a new simple plotting style.....	379
Changing the line attributes in a simple plotting style.....	381
Creating a new plotting style by copying from another plotting style.....	381
Working with Advanced plotting styles.....	382
Creating a new Advanced plotting style.....	382
Converting a simple plotting style to an Advanced plotting style.....	389
Special Rule Types.....	390
Manufacturing tab for special rules.....	391
Special rule tab for special rules.....	395
Multi-Perf Overview.....	397
Designing a multi-perf pattern.....	397
Adding a Multi-Perf Definition to the Special Rule Types Catalog.....	399
Edge band and Tear Tape Overview.....	401
Defining an Edge Band.....	403
Defining a Tear Tape.....	405
Default line type set.....	407
CAM Tooling Setup Catalog.....	408
Tool List tab.....	408
Tool Processing and Offsets when Outputting.....	410
Tool Selection tab.....	411
Optimization tab.....	414
CAM Output of Rubber Sheets.....	415
CAM Output of Steel Counters.....	416
Specifying a rotary die in a press definition.....	418
Changes to Rotary Die Press Defaults.....	419
Hole Catalog.....	421
Adding a hole to the Hole Catalog.....	421
Nicks.....	422
Nick formulas.....	422
Nick styles.....	423
Standard Sheet Layout.....	426
Sheet Layout Parameters.....	426
Standard Sheet Sizes.....	428
Configuring Intelligent Layout defaults and Costing/Estimating.....	429
Configuring cost centers.....	429
Changing Cost Center expressions.....	431
Creating a table to set the value.....	432

- Modifiers for cost center expressions..... 433
- Notes on Intelligent Layout Defaults..... 435
- Overview: Setting up a multi-color printing press cost center using a table.....436
- Useful Functions for Cost Center Expressions..... 438
 - STEP(variable, value1, limit1, value2, limit2,..., limitn, valuen)..... 438
 - STEPUP(variable, value1, limit1, value2, limit2, ... , limitn, valuen).....438
 - LINESTEP(variable, value1, limit1, value2, limit2, ..., limitn, valuen).....439
 - SPEEDSTEP(#RUN,speed1,run1,speed2,run2, ..., runn, speedn)..... 439
- List of functions for configuring cost centers..... 439
- Example Folder-Gluer Formula.....442
- Run Length Calculation..... 443
- Print Items and Folder-Gluer Make Ready..... 444
- Configuring Outputs.....445
 - Output Type tab..... 446
 - Output Type group..... 446
 - Show In group.....446
 - Scale group.....447
 - Preview control group..... 448
 - Device tab..... 448
 - Windows driver..... 450
 - CAM driver.....450
 - Bitmap outputs..... 451
 - Output to layer..... 452
 - Outputs using high graphics mode.....452
 - Position tab.....453
 - Device Size and Margin groups..... 454
 - Orientation and Position groups.....454
 - Reports tab..... 454
 - Directories tab.....455
 - File groups.....456
 - View tab..... 457
 - Style Selection group.....457
 - Dimension Position group..... 458
 - Override Dimension Format group.....458
 - View Selection group.....458
 - Processing tab..... 459
 - Optimization options group.....460
 - Line processing options group.....461
 - Layout Sequencing group.....462
 - Nicks group.....462
 - Rubber group.....464
 - Dieboard group.....465
 - Text options group.....465

Identify Zero Length Lines.....	466
Crease Cutback Dimensions.....	466
Diesaw tab.....	469
Kongsberg DieSaw group.....	469
Tiling tab.....	471
Tile registration group.....	472
Output filename generation group.....	472
Sample line types tab.....	473
Text options group.....	474
Make nicks in sample group.....	474
Sample Sequencing tab.....	475
Round slot method group.....	476
Overcut method group.....	476
Automatically round corners group.....	477
Over-crease group.....	477
Sample creases tab.....	478
Double pass crease offset group.....	478
Sample Counter tab.....	479
Print Sample Position tab.....	480
Send to tab.....	480
Advanced tab.....	480
Prompt for Kongsberg Material group.....	482
Record Variable Definition.....	483
Information Filter tab.....	488
Counter Tool Widths tab.....	489
Counter Cutting Order tab.....	490
Grouped Outputs tab.....	491
E-mail options group.....	493
Select which sample output group.....	493
PDF Security tab.....	494
Configuring a PDF Output using Adobe® Acrobat® 5.....	495
Configuring 3D Outputs.....	496
Creating a new 3D Output.....	496
Changing Collada defaults.....	498
Rule labels.....	499
Configuring the Output Scale Table.....	502
Notes on using the Output Scale Table.....	502
AutoSave / Local Temp Directory.....	502
Recovering AutoSave files.....	503
Revision Disk File Format in Revision History.....	504
Database Browser Reports.....	505
Publishing ArtiosCAD documents to WebCenter.....	507
WebCenter Project Name group.....	508

- Publish Options group.....509
- WebCenter Folder Name group..... 509
- WebCenter Login group..... 509
- WebCenter Connection group..... 510
- Graphic PDF file rotation import option..... 510
- Using Spot Colors in PDF files..... 510
- Layered PDFs..... 512
- Setting Cape/TOPS Defaults..... 513
- Setting DWG/DXF Options..... 515
- Color Palettes.....516
 - Adding a New Color Palette.....516
 - Color Palette by Feature.....518
 - Choosing Default Color Palettes.....520
- Canvas/Parts Options.....521
- Canvas Layout Options..... 524
- Tool Layer Options..... 527
- Default Side for Geometry Macros.....528
- Rectangle from Line Options..... 529
- 9. Getting started with ArtiosCAD..... 530**
 - Welcome to ArtiosCAD.....530
 - Changing the ArtiosCAD language.....530
 - Starting ArtiosCAD..... 531
 - Entering Licensing Information.....533
 - Changing the License Location..... 535
 - Signing Out of Your Subscription..... 536
 - Using a Subscription License in Addition to Another License.....537
 - Concepts and Ideas in ArtiosCAD..... 537
 - A typical workflow..... 537
 - Tools..... 537
 - Changing the view.....537
 - Zooming in and out.....538
 - Scale to fit tools..... 538
 - Pan/Zoom tool..... 538
 - View mode..... 540
 - Plotting styles..... 541
 - Construction lines..... 542
 - Layers..... 542
 - Properties..... 542
 - Transformations..... 543
 - Current position..... 543
 - Entering information in ArtiosCAD.....543
 - Using drag..... 543
 - Dynamic Drafting overview.....546

Turning dynamic drafting on and off.....	548
Keyboard Shortcuts in ArtiosCAD.....	550
Snap.....	551
Overrun/Underrun.....	554
Design window elements.....	554
The menu bar.....	555
The View bar.....	555
Changing the line type and pointage.....	557
The Toolbar Master Controls and toolbars.....	560
Designer toolbars.....	561
Manufacturing toolbars.....	562
Customized toolbars.....	564
Toolbar positions.....	564
Flyout toolbars.....	565
Changing the Toolbar Appearance.....	565
The drawing area.....	567
The Status bar.....	567
Keypads.....	568
Parameter sets.....	570
Rule Length Dialog Box.....	570
Working with design files.....	572
How to view revision history.....	572
How to view the design origin.....	573
File views.....	573
Creating, opening, and importing designs.....	575
How to create a new blank design.....	576
How to assign a parameter set and board code.....	576
How to open an existing design.....	577
Opening a design that is already open.....	580
How to open a design on a Web server.....	580
How to open an existing manufacturing file.....	581
How to import an existing ArtiosCAD design into another.....	582
How to import a design in a different format.....	583
Importing a DDES file.....	583
Importing a DWG file.....	584
Importing a DXF file.....	585
Importing a CFF2 file.....	586
Importing an EPSF/AI file.....	586
Data Exchange Plug-In.....	587
Importing Elcede .N files.....	587
Working with other NC files.....	588
Opening a PDF file as lines.....	589
Opening the PDF file.....	589

Choosing Import Options.....	589
Choosing Single Design Settings.....	590
PDF vector import notes and warnings.....	590
How to open a Score! file.....	590
More information about opening a Score! file.....	591
Score! file import restrictions.....	591
Score! file model structure.....	592
Score! line type mapping.....	592
Score! bridging.....	593
Score! text.....	593
Score! dimensions.....	593
Score! fold angles.....	594
Saving and exporting designs.....	594
How to save a design.....	594
How to save a design with a different name.....	595
How to save a copy of a design.....	595
How to save a design using automatic numbering.....	595
How to save a revision of a design.....	595
How to save a self-contained parametric design.....	596
How to export a design to a different format.....	597
Font notes and warnings when exporting as PDF.....	600
Data Exchange Plug-In.....	600
How to export files to the ArtiosCAD Viewer.....	600
How to export files to previous versions of ArtiosCAD.....	601
Exporting Splines to a DXF/DWG File.....	601
Right mouse button functionality.....	602
Single Design.....	602
Canvases.....	603
Manufacturing.....	606
3D.....	606
Using the spell checker.....	607
Spell checking in fields.....	607
Spell checking through the whole workspace.....	610
Notes about spell checking.....	611
Publishing ArtiosCAD documents to WebCenter.....	612
Portable Workstation mode.....	615
Using Portable Workstation mode for the first time.....	616
Detaching from the network.....	616
Attaching to the network.....	621
Subsequent uses of Portable Workstation mode.....	622
Limits in ArtiosCAD.....	623
10. Introduction to ArtiosCAD Enterprise.....	625
Concepts.....	625

Logging In For The First Time.....	625
Entering Licensing Information.....	631
Changing the License Location.....	634
Signing Out of Your Subscription.....	634
Adding and Removing Server Locations.....	635
Mode and Status Indicators.....	636
Changing the Logged-In User or Server.....	636
Changing Location.....	637
An Example of Using Change Location.....	638
Introduction to Offline Mode.....	638
Using the Browser.....	638
Browser Window Elements.....	638
The Browser Toolbar.....	640
Search Controls.....	641
Document Display Control.....	642
Paging Controls.....	643
Tree Control.....	643
Projects Node.....	645
BOM Node.....	647
Tasks Node.....	649
My Tasks Node.....	650
Search Node.....	651
Documents Node.....	651
Explorer Node.....	652
Customizing the Document List.....	653
Edit Controls.....	654
Projects.....	655
Creating a Project.....	655
Opening a Project.....	656
Opening a Project in WebCenter.....	656
Renaming a Project.....	657
Deleting a Project.....	658
Copying a Project.....	658
Copying a Project to My Computer.....	659
Inviting Members to a Project.....	660
Removing Members from a Project.....	660
Viewing and Setting Project Properties.....	660
Folders.....	661
Creating a Folder.....	661
Renaming a Folder.....	661
Deleting a Folder.....	662
Templates.....	662
Creating a Template.....	662

- Deleting a Template..... 663
- Changing a Template..... 663
- Tasks..... 663
 - Linking a Managed Document to a Task..... 663
 - Linking an Unmanaged Document to a Task..... 664
 - Starting a Task..... 664
 - Changing the Status of a Task..... 665
 - Changing the Assignee of a Task to Someone Else..... 667
 - Changing the Assignee of a Task to Yourself..... 669
 - Removing a Document from a Task..... 670
 - Changing the Checklist of a Task..... 671
 - Opening a Task in WebCenter..... 673
 - Completing a Task..... 674
- Documents..... 675
 - Saving a Managed Document..... 675
 - Additional commands on the Save button..... 678
 - Saving an Unmanaged Document..... 680
 - Publishing a New Version of a Managed Document..... 680
 - Publishing a New Revision of a Managed Document..... 683
 - Opening a Document..... 686
 - Additional Methods for Opening Documents..... 686
 - Opening a Document with a Foreign Board Definition..... 688
 - Opening All Documents in the Document List..... 690
 - How to Distinguish a Linked Document..... 690
 - Renaming a Document..... 691
 - Deleting a Document..... 692
 - Moving and Copying Documents..... 692
 - Moving Documents..... 692
 - Copying Documents..... 692
 - Copying a Document as a Link..... 693
 - Adding Other Types of Documents to Projects..... 694
 - Embedded designs..... 694
 - Canvases..... 695
- Searching..... 696
 - Keyword Searching..... 696
 - Advanced Searching..... 697
 - Searching Syntax..... 703
 - Saving Searches..... 705
 - Using a Saved Search..... 706
 - Modifying a Saved Search..... 706
 - Deleting a Saved Search..... 707
- Outputting Documents from the Browser..... 707
- Project Bill of Materials (BOM)..... 708

Offline Mode.....	711
Copying a Project to My Computer.....	711
Entering Offline Mode.....	712
Limitations of Offline Mode.....	712
Returning to Online Mode and Synchronizing.....	713
Purging the local database cache.....	714
Other Features.....	715
Locking and Unlocking Documents.....	715
Forcibly Unlocking Documents.....	716
Reassigning a Document to Another Designer.....	717
Revision History.....	717
Enhancements to Customized Database Information Dialog Boxes.....	718
Using the Cache Manager.....	719
Permissions Required for Common Activities.....	721
Setting the Title Bar Display Options.....	723
Pre-seeding comments when saving a document.....	723
11. Builder.....	725
What is Builder?.....	725
Running a standard.....	725
An example of using the Standards Catalog.....	726
Running a new standard.....	727
Running non-ArtiosCAD standards.....	728
Designer WorkBench and LASERPOINT IQ 2-4 Standards.....	728
INTERACT, LASERPOINT, and LASERPOINT IQ 1 standards.....	729
Rebuilding designs.....	730
Annotations and Dimensions.....	733
Paragraph Text tool.....	735
Spell checking in the Paragraph Text tool.....	737
Align Text tools.....	738
Arrow tool.....	739
Detail tool.....	740
Adjust Detail tool.....	741
Outline text tools.....	742
Line text tool.....	742
Line type label tool.....	743
Hatch tool.....	747
Hatch Status bar.....	747
Hatch Properties dialog box.....	748
Hatch placement options.....	751
Using a hatch pattern file.....	752
Dimensions.....	753
Notes and warnings about automatic dimensioning tools.....	763
Dimension properties.....	763

- Rounded dimensions.....765
- Easily resetting and applying Property Defaults..... 767
- Palletization in Builder..... 768
 - Mapping styles..... 768
 - Mapping boards..... 771
 - Creating a pallet group.....775
 - Arranging/Designing a group..... 783
- 12. Designer..... 789**
 - Introduction to Designer..... 789
 - Overview of Designer..... 789
 - Creating geometry.....789
 - What is geometry?..... 789
 - Endpoint Offset Mode..... 790
 - Using Endpoint Offset Mode..... 791
 - Lines..... 796
 - Lines at an angle..... 796
 - Lines with a known X, Y offset of the end-point.....797
 - Lines of a specific length..... 797
 - Line to a known point..... 797
 - Arcs and circles..... 797
 - Arcs using a start angle, radius, end-point offset.....798
 - Arcs using an X, Y offset, radius.....800
 - Arc Center.....800
 - Arc Through a Point..... 800
 - Circle.....800
 - Circle Diameter..... 801
 - Ellipse..... 801
 - Rectangles..... 802
 - Rectangle Horiz/Vert..... 803
 - Rectangle from Center..... 804
 - Panel from Line.....804
 - Using a Geometry Macro.....806
 - Tips for Creating Your Own Panel from Line Geometry Macros..... 809
 - Using Panel from Line Geometry Macros to Make a Design..... 809
 - Offset Line..... 813
 - Straight-curve and Curve-straight.....813
 - Line Join tools.....815
 - Line at Angle to a Line tool..... 816
 - Beziers.....816
 - Changing Beziers to Arcs..... 817
 - Drafting aids.....818
 - Construction lines..... 818
 - How and when to use construction lines.....818

Conline Offset/Angle tool.....	819
Conline At Angle From Line tool.....	819
Conline Division tool.....	820
Conline Radius tool.....	821
Conline Angle Divide tool.....	821
Conline Join tools.....	822
Changing construction lines.....	824
Extend/Measure tools.....	825
Changing geometry.....	828
Select tools.....	829
Select Conlines tool.....	831
Select by Example tool.....	832
Select All tool.....	832
Nudge mode in the Select tool.....	833
Default nudge distances.....	834
Nudge with Stretch.....	834
Nudge by a Fixed Value.....	837
Nudge in Direction Specified by a Line.....	837
Nudge Options and Defaults.....	838
Changing linear properties.....	839
Changing line type and pointage.....	839
Foldable line type properties in Single Design.....	840
Notes about special rules.....	843
Changing Bridging properties.....	844
Number and position of bridges.....	846
Changing the number of bridges.....	847
Changing the width of bridges.....	847
Changing the bridging for arc corners.....	848
Changing the current bridging formula.....	849
Blend tool.....	849
Chamfer tool.....	849
Blend 3 Lines tool.....	851
Split line at point.....	852
Trim/Extend tools.....	853
Stretch point.....	861
Stretch by Polygon.....	864
Follow.....	866
Example of using the Follow tool.....	867
Cloning Changes Using Auto-Repeat.....	869
Example of Using Auto-Repeat.....	870
Preparing for Manufacturing.....	875
Bleed tool.....	875
Coating Free Area tool.....	878

Notes on the Bleed and Coating tools.....	880
Add Bridge tool.....	880
Add Tack Bridge tool.....	881
Add Nick tool.....	882
Filling a Path with Nicks.....	884
Delete Bridge tool.....	886
Move Bridge tool.....	886
Conline Through Bridge tool.....	886
Delete Nick tool.....	887
Move Nick tool.....	887
Conline Through Nick tool.....	887
Changing nick properties.....	888
Shorten Creases tool.....	888
Changing physical properties.....	889
Delete tool.....	890
Move To Layer tool.....	890
Move tools.....	891
Rotate tools.....	891
Mirror tools.....	892
Scale tools.....	893
Copy tools.....	893
Distribute to Layers.....	893
Repeated Copy tool.....	895
Copy Rotate tools.....	896
Copy Mirror tools.....	897
Complete design from half/quarter tool.....	898
Copy Times tools.....	902
Example of using the Copy Times Offset tool.....	902
Example of using the Copy Times Rotate tool.....	905
Group tools.....	907
Offset Lines tool.....	908
Horizontal/Vertical tools.....	908
Merge Lines tools.....	908
Adjust Arc tools.....	910
Direction tools.....	911
Using the Sequence tool with Outputs.....	914
Working with non-geometric elements.....	915
Layers.....	915
Locked layers.....	916
Appropriate layers.....	918
Automatic layer switching.....	919
Setting autoswitch options.....	920
Adding layers.....	921

Manipulating layers.....	922
Deleting layers.....	923
Reusing a deleted layer.....	923
Moving items between layers.....	924
Annotations and Dimensions.....	924
Graphics.....	924
Adding graphics.....	925
Register bitmap.....	926
Clip graphics.....	928
Replace graphics.....	928
Move Graphics.....	929
AutoTrace bitmap.....	929
Adding a stock color.....	930
Deleting a stock color.....	930
Fill.....	931
Stroke.....	931
Fill panel.....	932
Send to front and Send to back.....	932
Adding a PDF file.....	933
Working with Adobe Acrobat PDF files.....	934
Changing the reference to the PDF file.....	937
Troubleshooting.....	938
Automatic registration of Esko normalized PDF files in a single design.....	938
Registering a normalized PDF file.....	939
Other auto-registration formats.....	941
Print items.....	941
Artwork Panels.....	942
Using the Artwork Panels Tool.....	944
Creating Artwork Panels from 3D Information.....	949
Creating Artwork Panels Manually.....	953
Creating Artwork Panels from Custom Outlines.....	955
Changing Artwork Panel Properties.....	957
Dynamic Art.....	958
Using the Dynamic Art Tool.....	959
Adding a Copy Placeholder.....	961
Adding a Barcode Placeholder.....	964
Adding a Symbol Placeholder.....	967
Adding a Table Placeholder.....	969
Changing Placeholder Properties.....	972
Other functions in Designer.....	972
Setting the Grain/Corrugation direction.....	972
Setting the current side of the design.....	973
Units and formatting.....	973

CloseUp windows..... 974

StyleMaker.....974

 Manipulating variables..... 975

 Rebuilding a design..... 976

 Rebuilding a design with Rebuild Playback..... 976

 Editing the command history..... 977

 Rebuild Playback notes and warnings..... 978

Using Advanced StyleMaker techniques to construct a standard.....978

 Step 1 – Planning the design..... 979

 Step 2 – Creating the design..... 980

 Making menus and creating variables.....981

 Adding the Inside Dimensions menu..... 981

 Adding the Slot style choices menu.....983

 Adding the Number of slots menu..... 984

 Adding the Slot dimensions menu.....987

 Constructing the design..... 988

 Step 3 – Testing the design.....991

 Step 4 – Adding the design to a Style Catalog..... 992

Designing for Re-board®.....993

 Extending V-notch Cuts..... 1002

 Compression Bends..... 1004

Designing Retail-Ready Containers.....1006

 Defining Tear-Away Parts..... 1006

Intelligent Counters.....1009

 Configuring Intelligent Counters.....1011

 Intelligent Counters workflow for plastic counters.....1011

 Creating and modifying a plastic counter..... 1012

 Crease channel widths tab..... 1014

 Periphery tab.....1016

 Crease End tab.....1017

 Partial cut tab.....1018

 Cut and Crease tab.....1018

 Chamfer tab..... 1019

 Reverse Creases tab..... 1020

 Reverse Cuts tab..... 1020

 Embossing tab.....1020

 Position Holes tab..... 1021

 Tack Bridges tab.....1021

 Name tab..... 1022

 Viewing the counter.....1024

 Counter Position Holes.....1024

 Switching counter parameter sets..... 1025

 Outputting imported INTERACT and LASERPOINT IQ counters..... 1025

Intelligent Counters workflow for steel counters.....	1025
Steel counter workflow notes.....	1028
Steel counter creation warnings.....	1030
Digitizing.....	1031
Starting to digitize.....	1032
Issuing digitizing commands.....	1032
Example - Digitizing a simple shape.....	1035
Example - Blending a digitized corner.....	1037
Aligning the image on the digitizer.....	1037
Using the digitizing menu.....	1039
Projects.....	1039
Getting started with Projects.....	1039
Creating a new Project.....	1039
Adding documents to a Project.....	1041
Adding open documents to a Project.....	1042
Opening a Project.....	1043
Opening documents in a Project.....	1046
Working with the Project Bar.....	1047
The Project Bar Toolbar.....	1050
Manipulating the Project Bar.....	1051
Setting Project information.....	1056
Closing a Project.....	1056
Notes and warnings for Projects.....	1057
Revisions.....	1057
Opening files from another database.....	1057
Design Checks.....	1059
Canvases.....	1059
The canvas interface.....	1060
Feature availability in canvases and parts.....	1062
Using Isolation Mode.....	1063
Manipulating the Parts List.....	1064
File operations.....	1068
Creating a new canvas.....	1068
Converting an existing design to a canvas.....	1068
Creating a new empty part.....	1070
Importing a file from a standard as a new rebuildable part.....	1071
Importing a file as a new rebuildable part.....	1074
Importing a file as a new static part.....	1074
Importing a file as a new part reference.....	1075
Importing a file as a new rebuildable part reference.....	1076
Deleting a part.....	1078
Saving a canvas.....	1078
Saving parts.....	1079

Saving revisions.....	1081
Opening a canvas in ArtiosCAD Standard Edition.....	1083
Opening a canvas in ArtiosCAD Enterprise.....	1085
Synchronizing parts.....	1087
Converting a part to Manufacturing.....	1090
Parts management.....	1090
Making a part active.....	1090
Changing a part's type.....	1091
Splitting a part.....	1091
Moving objects to a part.....	1091
Moving a part.....	1092
Changing properties.....	1092
Parts Options.....	1092
Parts database information.....	1093
Working with read-only parts.....	1095
Making a read-only part writable.....	1096
Making a writable part read-only.....	1096
Breaking the link to a formerly read-only part.....	1097
Rebuild in canvases.....	1097
Undo and Redo in canvases.....	1098
Layers in canvases and parts.....	1098
Copying and pasting in canvases.....	1099
Changing the boards.....	1100
Drafting in canvases.....	1102
Drafting rules.....	1103
Construction lines in canvases.....	1103
Geometry toolbar tools.....	1105
Dimension tools.....	1105
Adjust tools.....	1105
Adjust Outline tools.....	1105
Annotation tools.....	1105
Edit tools.....	1106
Graphics tools.....	1106
Prepare Manufacturing tools.....	1106
Information menu.....	1107
Using geometry macros in canvases.....	1107
Dimensioning the sheet of a layout part.....	1107
Creating your own canvas geometry macro.....	1108
Useful variables for sheet dimensions.....	1109
Library functions for canvases.....	1110
Layouts in canvases.....	1111
Creating a layout automatically.....	1111
Recalculating a job.....	1116

Creating a layout manually.....	1118
Adding parts to a layout.....	1120
Editing a layout.....	1123
Moving a part on a layout.....	1124
Copying a part on a layout.....	1124
Rotating a part on a layout.....	1124
Deleting a part from a layout.....	1125
Deleting a part from a job.....	1125
Renaming a job or layout.....	1125
Deleting a layout.....	1125
Deleting a job.....	1126
Part Labels.....	1126
Viewing information about a job or layout.....	1126
Converting a canvas layout to manufacturing.....	1130
Canvas layouts notes and warnings.....	1132
13. Manufacturing.....	1134
Introduction to Manufacturing.....	1134
Manufacturing prerequisites.....	1135
Standard Sheet Layout.....	1135
Notes and warnings.....	1139
Further examples.....	1140
Intelligent Layout and Costing/Estimating.....	1144
Overview: How to design a layout using Intelligent Layout.....	1145
Overview: How to use Costing/Estimating when creating a layout.....	1145
Example - How to use Intelligent Layout with Costing/Estimating to produce a layout with multiple items.....	1145
Create three designs.....	1146
Create a new layout and add the three designs.....	1146
Check the board weight and cost.....	1147
Enter the ordered quantities and Rebuild.....	1148
Set the ink coverage.....	1149
Set the prompted variables.....	1150
Examine the total cost.....	1150
Setting the overrun percentage.....	1152
Effect of minimum and maximum overrun.....	1153
Scrapped overrun.....	1154
How to use print items with Intelligent Layout and Costing/Estimating.....	1156
Example: Using print items with Intelligent Layout and Costing/Estimating.....	1156
Creating Print Items.....	1156
Return to Manufacturing.....	1157
Check the Print Items in the Layout.....	1157
Ghosting constraints.....	1158
Multiple Sheets.....	1159

- Using the On Checkboxes and Save/Remainder..... 1160
- How to adjust layouts made using Intelligent Layout..... 1162
 - Specify Nest tool..... 1162
 - Delete Nest tool..... 1162
 - Move Design or Column tool..... 1163
 - Manual Adjustments..... 1163
- Multiple Quantities in Costing/Estimating..... 1163
 - Adding to the list of quantities..... 1164
 - Different Layout for Each Quantity..... 1165
 - Cost/1000 for Different Quantities..... 1165
- How to use manual layout tools to design a layout..... 1166
 - Overview: How to design a layout manually..... 1166
 - Creating the workspace and defining machines..... 1166
 - Converting a canvas to Manufacturing..... 1167
 - Adding designs to the sheet and arranging them..... 1167
 - Arranging designs using the Nest tools..... 1168
 - Changing the gutter between designs..... 1171
 - Arranging designs manually..... 1173
 - Making a combination layout..... 1174
 - Changing the sheet size and justification of the designs..... 1175
 - How to modify a single design embedded in a manufacturing file..... 1176
 - How to replace designs in a layout..... 1177
 - How to perform manual sequencing of designs..... 1178
- How to create tooling..... 1183
 - A note on Auto-repeat..... 1183
 - How to manipulate elements and designs..... 1185
 - Creating the dieboard edge..... 1185
 - How to create scrap knives..... 1187
 - Scrap Knives dialog box..... 1187
 - Adding scrap knives to a layout..... 1190
 - How to create evenly-spaced scrap knives..... 1192
 - Properties of evenly spaced scrap knives..... 1193
 - How to move scrap knives..... 1194
 - How to add balance knives..... 1194
 - How to create stripping rules..... 1196
 - How to create carrier rules..... 1197
 - How to add hooks to stripping rules..... 1200
 - How to create a lower board mounting bar..... 1200
 - How to add and work with mounting holes..... 1201
 - Add MHP tool..... 1201
 - Select MHP tool..... 1202
 - Delete All MHP tool..... 1202
 - Adjust MHP Horizontally tool..... 1202

Adjust MHP Vertically tool.....	1203
How to remove double knives.....	1204
How to show gripper fingers.....	1205
How to work with bridges, tack bridges, and nicks.....	1206
How to create internal and external stripping.....	1206
Stripping Inside a Hole.....	1211
How to repeat changes in stripping to other areas.....	1214
Color-coded stripping areas.....	1214
Changing stripping boards.....	1216
How to change the edge of the lower stripping board.....	1216
How to add an upper push pin.....	1217
How to add an upper rule.....	1220
How to add an upper block.....	1226
How to add an upper block pin.....	1228
How to add interference.....	1230
How to remove stripping.....	1233
How to add an air hole.....	1234
How to make an alignment hole.....	1235
How to add a support bar.....	1235
How to add registration holes.....	1236
How to add a Front Waste Separator.....	1237
How to modify a Front Waste Separator.....	1238
Using stripping components.....	1239
Adding a stripping component.....	1240
Modifying stripping components.....	1242
Outputting boards containing stripping components.....	1244
Creating your own stripping components.....	1245
Clearances.....	1247
Alignment lines.....	1248
Listing stripping components on a Report.....	1248
Notes and warnings about stripping components.....	1249
Notes and warnings on manual stripping board modification.....	1249
Using a Geometry Macro to add a burn name.....	1250
Plastic counter layouts.....	1251
Creating a plastic counter layout.....	1251
Modifying a plastic counter layout.....	1253
Steel counter layouts.....	1254
Frame tab of Create or Rebuild Counter tool.....	1255
Coating blankets.....	1256
Making a coating blanket.....	1256
Modifying a coating blanket.....	1259
Configuring alternate coating blankets.....	1260
Rotary Diemaking.....	1260

Tools for rotary dies / DieSaw output.....	1260
Rotary Die Board tool.....	1260
Making a Pattern Workspace.....	1261
Adjust Elements state.....	1262
Adjust Die Edge state.....	1265
Adjust Die Split state.....	1266
Add Bolt Holes state.....	1268
Delete Bolt Holes state.....	1270
Rule Path tools.....	1270
Build Rule Path tool.....	1271
Notes on building rule paths.....	1273
Delete Rule Path tool.....	1275
Add Rule Path tool.....	1275
Select Rule Path tool.....	1275
Changing rule path properties.....	1276
Split Rule Path tool.....	1278
Join Rule Path tool.....	1279
Move Bridge Start Point tool.....	1280
Reverse Rule Path tool.....	1280
Move Bridge Start Point to Center tool.....	1280
Change Wrap Point tool.....	1280
Add Bridge on Rule Path tool.....	1281
Re-bridge Rule Path Layer tool.....	1282
Add Mark to Rule Path tool.....	1282
Delete Bridge on Rule Path tool.....	1283
Move Bridge on Rule Path tool.....	1284
Align Bridge on Rule Path tool.....	1285
DieSaw / Leader Hole Tools toolbar.....	1285
Generate Leader Holes tool.....	1286
Leader Hole error checking.....	1287
Add Leader Hole tool.....	1288
Delete Leader Hole tool.....	1288
Reverse Cut tool.....	1288
Delete DieSaw Layer tool.....	1288
Notes on Leader Holes.....	1289
Dieboard Split tools.....	1289
Horizontal Split tool.....	1289
Vertical Split tool.....	1290
Delete Split tool.....	1290
Registration Hole Tools toolbar.....	1290
Add Hole tool.....	1291
Add Countersunk Hole tool.....	1291
Add Oblong Hole tool.....	1292

Add Countersunk Oblong Hole tool.....	1293
Add Drill Hole tool.....	1293
Add Countersunk Drill Hole tool.....	1294
Rotary Diemaking Workflow.....	1294
Prerequisites.....	1296
Using Layers.....	1296
Default layers in Manufacturing.....	1296
Move to Layer tool.....	1296
Designer's Fix-It.....	1298
Tool descriptions and uses.....	1299
Split Lines tool.....	1299
Merge Points tool.....	1299
Overruns - Underruns tool.....	1301
Nearly Horizontal or Vertical tool.....	1302
Double Knives tool.....	1303
Short Lines tool.....	1304
Line - Gap Sequence tool.....	1305
Arc from Lines tool.....	1308
Smooth Lines tool.....	1310
Designer's Fix-It defaults.....	1312
Dieboard Dropout Check.....	1313
Rubbering.....	1316
Introduction to rubbering.....	1316
Rubber workflow overview.....	1316
Rubber tools.....	1318
Rubber Area tool.....	1321
Repeat Rubber Element tool.....	1322
Split Rubber tool.....	1323
Add Open-out tool.....	1323
Subtract Bolt Holes tool.....	1324
Layout Rubber tool.....	1325
List Rubber Elements tool.....	1326
Making manual changes to a rubber layout.....	1328
Changing rubber properties.....	1332
Blanking.....	1333
Blanking tools list.....	1333
Blanking Elements.....	1334
Blanking Congruency.....	1338
Frame Creation.....	1339
Blanking Example Workflow: Lower Grid.....	1342
Blanking Example Workflow: Lower Board.....	1348
Blanking Tools Reference.....	1353
Add Grid Bar tool.....	1353

Include Strip Rules tool.....	1357
Generate Blanking Tools tool.....	1360
Adjust Blank Hole tool.....	1371
Adjust Pushers tool.....	1372
Add Non-stop Swords tool.....	1373
Add Photocells tool.....	1374
Add Jogger Guides tool.....	1376
Add Support Bars tool.....	1377
Add Air Holes tool.....	1379
Add Blanker Pusher Pins tool.....	1380
Add Hardware tool.....	1381
Placing BSI hardware.....	1382
Add Tie-bolts tool.....	1383
Add Pressers tool.....	1386
Delete Blanking tool.....	1388
Smooth/Blend Contour tool.....	1390
Edit Contour tool.....	1392
14. 3D.....	1393
Introduction to 3D.....	1393
Concepts and Ideas in 3D.....	1393
Workflow in 3D.....	1394
Snap.....	1394
Tools in 3D.....	1395
Notes and warnings in 3D.....	1396
3D Rendering Options.....	1398
Understanding the Basics of 3D.....	1398
Creating a new 3D workspace.....	1398
Opening an existing 3D workspace.....	1404
Remembered fold angles and base face.....	1404
Pre-defined fold angles in designs created from standards.....	1405
Folding all creases in a design at 90 degrees.....	1408
Folding individual angles.....	1408
Adding another design to a 3D workspace.....	1409
Add to Open 3D tool.....	1409
Converting a multi-part design to a 3D workspace.....	1409
Converting a canvas to 3D.....	1410
Changing the view of a workspace in 3D.....	1414
Changing the base face.....	1415
Printing a folded workspace.....	1415
Saving a workspace in 3D.....	1415
Saving fold angles changes.....	1416
Saving part count changes.....	1416
Copying a 3D workspace to the Windows Clipboard.....	1417

Notes and warnings.....	1418
Exiting 3D.....	1418
Moving, duplicating, and rotating objects in 3D.....	1418
Working with different simultaneous view angles.....	1418
3D Extend tools.....	1419
Select Designs tool.....	1421
Move Point to Point tool.....	1421
Move Designs tool.....	1422
Fit tolerance.....	1427
Move Designs X, Y, Z tool.....	1429
Duplicate Designs tool.....	1430
Duplicate Designs X, Y, Z tool.....	1432
Group tools.....	1433
Rotate Designs tool.....	1433
Drag on Plane tool.....	1436
Array Copy Tool for Filling.....	1439
Array Copy Tool for Filling Partitions.....	1442
Array Copy Tool for Stacking.....	1445
Folding designs.....	1447
Fold Angle tool.....	1447
Fold All tool.....	1448
Fold 1 to Meet tool.....	1450
Fold 2 to Meet tool.....	1452
Flap Priority tool.....	1453
Folding designs with curved creases.....	1454
Linked folds.....	1455
Curved perf behavior in 3D.....	1457
Unsupported 3D designs and workarounds.....	1457
Examples of supported curved crease designs.....	1458
Folding designs with V-notch lines for Re-board®.....	1462
Partial cuts for Re-board®.....	1464
Folding Re-board® designs using the Snap Tab/Slot tool.....	1465
Using Mates with the Snap Tab/Slot Tool.....	1473
Snap Tab/Slot tool notes.....	1474
Snapping a Stack of Tabbed Pieces into a Slot.....	1482
Folding Retail-Ready Containers.....	1483
Select Tear Away Part tool.....	1483
Rejoining the Parts.....	1485
Bend tool concepts.....	1486
Types of bend panels.....	1486
Using the Bend tool in 3D.....	1488
Glue/mate area concepts.....	1491
Defining Mate and Target areas.....	1492

Folding a design with a mate and target area.....	1495
Attaching two designs in 3D using Mate and Target areas.....	1496
Attaching a solid to a carton in 3D.....	1499
Deleting Mates.....	1502
Panel Mate concepts.....	1502
Creating a Panel Mate.....	1502
Notes on using Panel Mates.....	1505
Undo and Redo.....	1506
Changing how you view the workspace.....	1506
Zoom Rectangle tool.....	1507
Center-Point Zoom tool.....	1508
Zoom Out tool.....	1508
Zoom In/Out tool.....	1508
Scale to Fit tools.....	1508
Pan/Zoom tool.....	1509
View Angle tool.....	1509
Next and Previous View tools.....	1511
Rotate View tools.....	1512
Orthogonal View tool.....	1512
Perspective tool.....	1513
Lighting.....	1516
Light Source tool.....	1516
Light Source Tool Defaults.....	1519
Ambient light.....	1521
Status bar.....	1522
Setting the View mode.....	1522
Advanced mode.....	1531
Graphics resolution.....	1532
Image filter.....	1532
Smooth edges.....	1533
Reduce gaps in edges.....	1533
Using a freehand background image.....	1535
Using an aligned background image.....	1537
Outputs using background images.....	1543
Level Designs tool.....	1544
Changing visible properties of objects in 3D.....	1546
How to change the board information in 3D.....	1551
Notes on board textures.....	1556
Making an extrusion.....	1556
Refreshing the screen.....	1558
Working with dimensions in 3D.....	1558
Dimension tool.....	1558
Select Dimensions tool.....	1559

Change Dimension Alignment tool.....	1560
Change Text Position tool.....	1561
Deleting dimensions.....	1562
Working with Edge Band and Tear Tape.....	1562
Animation in 3D.....	1565
The Status bar.....	1566
Animation tools.....	1567
Animation notes and restrictions.....	1568
Tear-away Animations.....	1569
Making a Tear-away Animation.....	1569
Example of Tearing from Two Sides.....	1572
Example of an Attached Tear-Away Animation.....	1574
Making a Pull-Away Animation.....	1578
Substrate Tears.....	1581
Example of Two Tear-away Animations.....	1582
Example of a Tear Strip with an Attached Part.....	1585
Adding a Tear-away Animation to an Existing Animation.....	1587
Deleting a Tear-away Animation.....	1588
3D Designer.....	1588
Solids of revolution.....	1589
Working with the single design.....	1589
Vertical cross section.....	1590
Horizontal cross section.....	1590
Graphics for labels.....	1591
Shrink-wrap graphics.....	1591
Converting the single design to a solid of revolution.....	1592
Examples.....	1595
Solids of revolution notes and warnings.....	1598
Importing Other Solids.....	1598
Importing VRML files.....	1599
Importing non-VRML files.....	1600
Importing a Solid.....	1600
Collada file format support.....	1601
Collada notes and warnings.....	1602
Scale Designs tool.....	1603
Cross Sections.....	1606
Intersect Design tool.....	1607
Cross Section tool.....	1611
Bounding Box tool.....	1615
Rotating solids using the bounding box.....	1616
Run a Standard tool.....	1618
Convert to 2D tool.....	1619
Add Hardware Tool.....	1620

- Before You Begin..... 1623
- Supported Product Shapes.....1624
- Starting the Tool and Selecting the Hardware..... 1628
- Using Single Placement Mode.....1630
- Using Array Placement Mode.....1635
- Using the Select Hardware Tool to Delete Hardware.....1643
- Updating the 2D Workspace After Adding Hardware in 3D.....1645
- Add Hardware Tool Notes..... 1646
- Creating a Hardware Component from a Solid Model.....1647
- Creating a Hardware Component from Scratch..... 1654
- Modifying a Hardware Component..... 1654
- Rebuild Tool Overview.....1655
- Rebuild Tool..... 1655
- Notes on Using the Rebuild Tool in 3D.....1658
- Notes on Splitting Designs..... 1659
- Synchronizing changes between 3D and 2D.....1662
- Splitting an imported design into multiple parts..... 1662
- Palletization in 3D..... 1663
- Palletizing a 3D workspace..... 1663
- Arranging a Group in CAPE around a 3D workspace..... 1667
- Creating a Folding Carton Arrange case using Cape..... 1673
- Creating the FCA case and calculating the pallet load..... 1673
- Folding the FCA case solution from Cape..... 1677
- Filling a Case with Cape in 3D.....1681
- Starting in ArtiosCAD and Choosing the Case in Cape Pack..... 1681
- Returning to ArtiosCAD and Folding the Case.....1684
- 15. Outputs..... 1686**
- Introduction to Outputs.....1686
- Concepts and Ideas in Outputs..... 1688
- Sending data to output devices.....1688
- Notes and warnings when printing bitmaps.....1688
- Printing..... 1689
- Creating a PDF file..... 1691
- Setting PDF security options.....1693
- Samplemaking..... 1695
- Note for DieSaw users..... 1697
- Making an Output to i-cut Production Console.....1697
- Reports..... 1699
- What is a report?..... 1699
- Making a custom report..... 1700
- Deciding the contents of the report..... 1701
- Defining the size of the report..... 1701
- Drawing lines to separate areas.....1702

Creating a File Window.....	1702
Using a Symbol file window.....	1706
Using a Cape Palletization file window.....	1709
Adding text to the report.....	1709
Adding fixed text.....	1710
Adding prompted text.....	1710
Adding calculated text.....	1711
Adding graphics to the report.....	1712
Modifying items on the report.....	1712
Changing the size of a File Window.....	1712
Modifying fixed or prompted text.....	1712
Modifying calculated text.....	1713
Rubber on Reports.....	1715
Saving the report.....	1716
Making a title block report.....	1716
Notes and warnings about Reports.....	1717
Using the ITEMORD function on Reports.....	1718
Adding a report to the Reports Catalog.....	1718
Defining an Output that uses the report.....	1718
Using a Report.....	1721
Single Design and Manufacturing.....	1721
3D.....	1724
Cape.....	1726
Cape Arrange/Design Group Report workflow.....	1726
Cape Pallet Group Report workflow.....	1731
FCA Pallet Group Report workflow.....	1737
Example - Using multiple instances of the grain/corrugation direction indicator on a report.....	1740
Bill of Materials Reports for Projects.....	1742
Using an example BOM Report.....	1743
Configuring Project documents before using a BOM Report.....	1744
Outputting a BOM Report.....	1745
Creating a BOM Report.....	1745
Adding a BOM Report to the Bill of Materials menu.....	1748
Line type legends.....	1750
Line type legend expression properties.....	1751
Line Name expression.....	1751
Line Representation expression.....	1751
Total Rule Length expression.....	1752
Line type legend results.....	1752
Line and Hatch Legend Output.....	1752
Making a multiple workspace output.....	1753
Outputting Multiple Closed Workspaces.....	1753

Outputting Multiple Open Workspaces.....	1755
Palletization integration.....	1756
Creating a new CAPE/TOPS palletization solution.....	1756
Converting a layout to a CAPE/TOPS palletization solution.....	1759
Changing the pallet in a CAPE/TOPS palletization solution.....	1760
Palletization FAQ.....	1761
3D Outputs.....	1763
Outputting a 3D animation as a Microsoft Word document.....	1764
Animation tab.....	1764
Bitmap tab.....	1765
General tab.....	1766
Finishing the Output.....	1766
Outputting a 3D animation as a PDF document.....	1767
Outputting a 3D animation as a Microsoft PowerPoint document.....	1769
Outputting a 3D workspace as a JPEG or PNG bitmap.....	1771
Outputting a 3D workspace to an EPSF file, PDF file, or printer.....	1773
Outputting a 3D workspace to a PDF file with U3D.....	1775
Outputting a 3D workspace to U3D.....	1777
Notes and warnings when using U3D.....	1778
U3D Animation Notes.....	1779
Outputting a 3D workspace to a VRML file.....	1779
JPEG Images group.....	1781
Creases group.....	1781
Background color group.....	1781
Output Units group.....	1781
Animation group.....	1782
Outputting a 3D workspace to a SolidWorks file.....	1784
Notes and warnings.....	1785
Outputting a 3D Workspace as a STEP, IGES, ACIS, or XCGM File.....	1786
Spatial Export Notes.....	1787
3D Movie Outputs.....	1787
Creating a 3D Movie Output in Defaults.....	1788
Outputting a Movie from 3D.....	1791
Canvas Outputs.....	1794
Running a BOM-like Output for a canvas.....	1795
Running a part-by-part Output for a canvas.....	1796
Reports around canvas layouts.....	1798
Deleting a Report Around a Layout Part.....	1799
Notes about Reports Around Canvas Parts.....	1799
Creating your own Report Around a Canvas Part.....	1800
16. DataCenter for Standard Edition.....	1803
Introduction to DataCenter.....	1803
Concepts and Ideas in DataCenter.....	1803

Browsers.....	1803
Viewing database information.....	1804
Sorting the list of information.....	1804
Selecting an item from the list and viewing its information.....	1805
The toolbars.....	1809
Toolbars in ArtiosCAD Browsers.....	1809
Toolbar in DataCenter Admin.....	1811
Searching for information.....	1812
Servers and resources.....	1817
Configuring DataCenter.....	1818
Working with servers and resources.....	1818
Creating a server.....	1818
Creating a resource.....	1819
Deleting a server.....	1820
Deleting a resource.....	1820
Userfields.....	1821
Adding userfields to DataCenter.....	1821
Setting up a restricted userfield.....	1822
Deleting userfields from DataCenter.....	1823
Configuring companies.....	1824
Adding a company.....	1824
Deleting a company.....	1825
Changing how company identifiers are shown.....	1825
Configuring company types.....	1825
Adding a company type.....	1825
Deleting a company type.....	1826
Configuring people.....	1826
Adding a person.....	1826
Deleting a person's information.....	1826
Configuring board information.....	1827
Creating a paper.....	1829
Creating a flute.....	1833
Creating a board.....	1834
Renaming, deleting, moving, and copying board entries.....	1840
Configuring characteristics.....	1841
Adding a characteristic.....	1841
Deleting a characteristic.....	1842
Configuring Design Auto Numbering.....	1842
Configuring a filename counter.....	1842
Configuring Auto Numbering.....	1843
Using the Project browser.....	1844
Project browser - General pane.....	1846
Project browser - Userfields pane.....	1847

Project browser - Documents pane.....	1847
Project browser - Characteristics pane.....	1848
Searching for Projects.....	1848
Modifying information in browsers.....	1850
Refreshing fields in browsers.....	1851
Customizing columns in DataCenter Admin.....	1851
Using DataCenter.....	1852
Entering database information when saving in ArtiosCAD.....	1852
Setting values for userfields in designs or manufacturing files.....	1853
Characteristics.....	1854
Changing existing database information in DataCenter.....	1856
Synchronizing information in DataCenter.....	1858
Exporting information from DataCenter.....	1859
Other tasks.....	1860
AutoLoad.....	1860
Before using AutoLoad.....	1860
Simple AutoLoad.....	1860
Advanced AutoLoad.....	1862
Input tab Advanced pane.....	1862
Synchronization tab.....	1863
AutoLoad notes and warnings.....	1865
Recommended AutoLoad procedure for foreign file types.....	1866
AutoLoad and Projects.....	1866
Resuming a previous AutoLoad.....	1866
Database network performance.....	1869
Connecting to the database.....	1870
Pattern searching.....	1870
Installing additional characteristics.....	1871
Changing the database password.....	1873
17. Appendix.....	1874
Changed Icons and Toolbars as of Version 14.....	1874
Single Design Tool Icons.....	1874
Manufacturing Tool Icons.....	1883
3D Tool Icons.....	1890
Arithmetic functions.....	1894
Reserved words.....	1896
List of line types.....	1897
Glossary.....	1906

1. Location and Copyright

Esko

Kortrijksesteenweg 1095

BE-9051 Gent

Belgium

Tel.: (32) (9) 216-92-11

Fax: (32) (9) 216-94-64

Other offices worldwide.

Written and revised by Adam Hartfield, November 2018.

For use with ArtiosCAD and ArtiosCAD Enterprise version 18.0.1 or greater.

© Copyright 2018 Esko Software BVBA, Gent, Belgium.

All rights reserved. This material, information and instructions for use contained herein are the property of Esko Software BVBA. The material, information and instructions are provided on an AS IS basis without warranty of any kind. There are no warranties granted or extended by this document. Furthermore Esko Software BVBA does not warrant, guarantee or make any representations regarding the use, or the results of the use of the software or the information contained herein. Esko Software BVBA shall not be liable for any direct, indirect, consequential or incidental damages arising out of the use or inability to use the software or the information contained herein.

The information contained herein is subject to change without notice. Revisions may be issued from time to time to advise of such changes and/or additions.

No part of this document may be reproduced, stored in a data base or retrieval system, or published, in any form or in any way, electronically, mechanically, by print, photoprint, microfilm or any other means without prior written permission from Esko Software BVBA.

This document supersedes all previous dated versions.

This software is based in part on the work of the Independent JPEG Group.

Adobe, Acrobat, Illustrator, and PostScript are either registered trademarks or trademarks of Adobe Systems Incorporated in the United States and/or other countries.

Apple and QuickTime are registered trademarks of Apple, Inc.

Microsoft and the Microsoft logo are registered trademarks of Microsoft Corporation in the United States and other countries.

The Esko software may contain an implementation of the LZW algorithm licensed under U. S. Patent 4,558,302 and foreign counterparts.

The Esko software may contain the "RSA Data Security, Inc. MD5 Message-Digest Algorithm."

Java and all Java-based trademarks and logos are trademarks or registered trademarks of Sun Microsystems in the U.S. and other countries.

Strip Clip, Strip Fork and Strip Clip[®] System are products, registered trademarks and patents of Vossen Profitec[®] GmbH Germany.

OpenGL is a registered trademark of Silicon Graphics, Inc.

Contains PowerNest library Copyrighted and Licensed by Alma, 2005 – 2007.

The geometry macros contained with this release of ArtiosCAD to facilitate the use of Vossen Profitec components are approved by Vossen Profitec GmbH and are used with their permission. The Vossen Prax[®] documentation should be consulted and used to ensure correct use and placement of these geometry macros. The shapes and offsets used are in accordance with Vossen Profitec GmbH specifications. Usage and placement of these geometry macros to ensure effective stripping performance however, remains the responsibility of the user. Vossen Profitec GmbH may be contacted for details of worldwide representation at (49) (7771) 920-136 or by e-mail at info@vossen-profitec.de.

This software may use libxml2 - Copyright © 1998-2003 Daniel Veillard - All rights reserved.

All other product names are trademarks or registered trademarks of their respective owners.

Correspondence regarding this publication should be forwarded to:

Esko

Kortrijksesteenweg 1095

BE-9051 Gent

Belgium

info.eur@esko.com

2. In This Manual

Welcome to ArtiosCAD!

In this manual are instructions for:

- Installing and configuring ArtiosCAD Standard Edition
- Installing and configuring ArtiosCAD Enterprise (the ArtiosCAD side of it, not the WebCenter side except for things essential to using ArtiosCAD)
- Using ArtiosCAD
- Using ArtiosCAD Enterprise

Some of the information is specific for one edition of ArtiosCAD. For example, there are Defaults described in *Installing and Configuring ArtiosCAD Enterprise* that only exist in ArtiosCAD Enterprise. Likewise, the program DataCenter Admin described in *DataCenter* is only for use by people using ArtiosCAD Standard Edition.

3. Welcome

Introduction

The first six chapters of this book describe how to load ArtiosCAD (both editions) and its related components, both as a new installation and as an upgrade to a previous version, as well as how to add input and output devices and perform other configuration tasks.

For the latest information on system requirements, please go to the Esko website and search for system requirements.

The remaining chapters describe how to use ArtiosCAD (both editions) once you have installed and configured it.

Before you begin

Before trying to install ArtiosCAD, you should make sure that you know how to:

- view file and directory information with Windows Explorer
- make network connections and create network shares
- use a text editor such as Notepad

If you are going to use the included database product, find out from your IT department what the password policy is, as you will need to know it to set the database user passwords.

Make sure the network is up and running correctly so that you can see network resources from all machines. To install ArtiosCAD, you must be able to log in using an account that is a member of the local Administrators group.

ArtiosCAD will work immediately after being installed, but you will most likely want to set up some output devices as described in the *Peripherals* chapter.

If you have any questions, please do not hesitate to contact your local Support office for help.

If you will be using ArtiosCAD in a language other than American English, make sure your operating system's regional settings are set to match those of the United States. Specifically, for numbers, the decimal symbol needs to be a period, the decimal grouping symbol a comma, the list separator a comma. For currency, the decimal symbol needs to be a period and the digit grouping symbol a comma. Unpredictable results might occur if these settings are not made.

If you need help

If you need help while installing ArtiosCAD, click the **Answers to Common Questions** link on the main page of the installer. It will bring you to a Web page of frequently asked questions

and their answers. There are separate versions of the page for ArtiosCAD and ArtiosCAD Enterprise.

Package contents

The ArtiosCAD package includes the ArtiosCAD media which contains:

- The installation program
- Release notes - an overview of changes and enhancements and a list by number of bug fixes
- ArtiosCAD Viewer - a program you can give your vendors and customers. It is a stripped down version of ArtiosCAD which allows the user to view and print any ArtiosCAD design or 3D file. Viewer users can directly measure the structure, preview a 3D file with or without graphics from different angles, and fold and unfold it. Viewer is also available for downloading for free from the ArtiosCAD website (<http://www.esko.com>) and can be loaded on any system which supports ArtiosCAD.

Important folders, libraries, and files of ArtiosCAD

There are several folders that are set up under the `\Esko\Artios` folder on the drive chosen for the installation. One is the folder that contains the ArtiosCAD version that was installed. Others hold database, license, or other related information.

Folders underneath the version of ArtiosCAD

Three library folders have unique and important functions in the configuration and running of ArtiosCAD. They are: `InstLib`, `ServerLib` and `ClientLib`. `ServerLib` and `ClientLib` are in `..\Esko\Artios`, but `InstLib` is in the installation directory for ArtiosCAD as it is version-specific.

`InstLib`:

- `InstLib` contains default files shipped with the software. It is important to not change these files for a number of reasons. NEVER save modified files in `InstLib`.
- Reloading (upgrade mode) the current revision from media will overwrite any changes made to files in `InstLib`.
- Some of the files in `InstLib` (`sysdflt.zip` and its associated files) are used as reference files when doing an ArtiosCAD version upgrade. These files are checked against the user-modified versions in `ServerLib` to determine what and how to move modified information to the new version.
- It is useful to have a clean set of files to work from. If a file in `ServerLib` gets corrupted for some reason, you can recover a clean copy without having to reload ArtiosCAD. (The better solution is to make regular system backups!)
- There is a searchlist set up for ArtiosCAD which looks at these directories in the order `ClientLib`, `ServerLib`, `InstLib`. Files that are duplicated in `ServerLib`, for example, will be used in preference to those in `InstLib`. Duplicate files in `ClientLib` will be found in preference to files in both `ServerLib` and `InstLib`.

- The Symbol sub-folder contains samples of common corrugated symbols such as fragile.ard, recycle.ard, thiswayup.ard.

ServerLib:

- ServerLib contains configurations that have been modified from their initial defaults, standards, logos and other files (other than user data files) that need to be shared by all of the ArtiosCAD seats on the site network.
- When Shared Defaults are modified, the changes are saved to ServerLib in a file called sysdfflt.zip (and files that this references).
- New (additional) files that are to be shared by all of the ArtiosCAD seats on the site network should be placed in ServerLib. For example, reports that need to be used by all of the ArtiosCAD seats on the site network should be placed here. A copy of the report should be placed in ServerLib and added to the Reports Catalog in Shared Defaults.

ClientLib:

- This directory stores the defaults created in **Options > Defaults > User Defaults** in a file called clientdfflt.zip. The defaults and files saved to the ClientLib directory are only available to the particular workstation on which they were created. It is not intended that they be shared on the network. These defaults are merged with the Shared Defaults. Client defaults take precedence over Shared Defaults.
- ClientLib is used for local machine defaults only. It is used only if you wish to limit the function or change to ONE computer. For example, the most common usage is to provide Outputs to equipment like a Laser or a Counter Cutter to the computer system that is located in the room where this equipment resides. If the whole design and estimating departments work on the outside of the box, but the die room wishes to view the layouts Die-side, they might set up a User Default so that layouts are opened Die-side.
- If you are working on a live system and are trying to build new defaults, create them as User Defaults. Once happy with the results, copy the results into Shared Defaults and delete the User Defaults.

LpLib and DwbLib:

- Contain files that are needed for the support of Standards written using LASERPOINT IQ or The Designer WorkBench. The standards shipped with these systems are also included. These are loaded during the installation of ArtiosCAD.

Program:

- This is where the executable programs are stored.

Common:

- On License Server machines, contains and shares the license files for all seats. The license file is stored in this \Esko\Artios\Common folder. If License Manager is not being used, this directory contains the file that controls what features are available in ArtiosCAD. This file is called TUNEOPT.TXT or TUNEOPT7.TXT
- This directory also contains some additional programs in the Program folder that are not ArtiosCAD version-dependent.
- In addition, this directory contains the default board texture pictures.

DataCenter:

- This is the database folder.
- The English (or language folder) is a sub-folder of the DataCenter program folder. It contains several important files such as database export and import programs and databaseID.exe.

User Data Files:

- These can be shared, distributed or stored locally at each workstation.
- A DataCenter resource is automatically created for the User Data File destination chosen during installation. So, for example, if each client chooses a local destination folder during installation, a resource will be created for each directory in the Resource Browser of DataCenter Admin.
- In new installations, the \Esko\Artios\Designs folder is created as the default folder for user files. The destination folder selected here is a master resource in DataCenter Admin. If users add sub-folders underneath this folder after the installation, they automatically become DataCenter Admin resources the first time files are saved in them.
- If directories are added to other locations, they need to be manually added to DataCenter as resources. Files saved to these directories will not be recorded in the database unless the directories are resources.

Operating system notes

Windows Vista Business

If you are using Microsoft Windows Vista Business as the operating system on your computer, file and utility locations may differ from those referenced later in this book.

Table: Changed items or locations

Referenced item or location	Changed item or location
Start > Programs	Start > All Programs
Start > Settings > Control Panel	Start > Control Panel
Start > Settings > Control Panel > Administrative Tools > Data Sources (ODBC)	Start > Control Panel > Classic View > Administrative Tools > Data Sources
Start > Settings > Control Panel > Add/Remove Programs	Start > Control Panel > Programs > Programs and Features
C:\users\prod (legacy user files location)	Any other folder. Windows Vista Business uses this folder to store operating system files.
SolidWorks 2007	SolidWorks 2007 is not supported in Windows Vista (any version).

Windows 8

- Installing ArtiosCAD

During the installation, a pop up from Windows will inform you that you require .NET 3.5 in order to continue. This must be downloaded and installed. After installation of .NET, the computer will need to reboot as the install cannot continue.

When installing Microsoft SQL Server 2005 Express Edition, Windows will prompt you stating that there are known compatibility issues. Clicking to continue without checking online allows it to install just fine.

Be vigilant about the installation location as it may not default to where you would expect.

- Using ArtiosCAD

Within the Save As dialog box, the resize icon on the bottom right of the dialog box overlaps into the bottom right of the page.

Windows 8 does not show toolbar button selection or depression the same as previous versions of Windows. During installation or during new user creation, Windows will ask for a color theme to use. When a toolbar button is depressed or highlighted, it will highlight as a color from the chosen color theme instead of looking like the button was physically pushed in.

Windows 8 makes use of hot corners to perform certain tasks. It is easy to accidentally activate these hot corners when working at the edge of the window. (using the File menu, editing fields of a tool on the Status bar when in full-screen mode, selecting a Status bar button) This problem is exasperated when moving the cursor along the screens edge as it will either show a menu of currently running apps (left) or the charms menu (right). This will obscure the ArtiosCAD window further, forcing you to move the mouse to the middle of the screen and then bring it back to continue your task.

If after performing an Output the resulting file is automatically opened, there is a chance the file format will be associated with a Windows 8 application which will automatically open in full screen. To get back to ArtiosCAD, press ALT-TAB to change applications, or press the Windows key and click the desktop tile, or press WIN-D and maximize ArtiosCAD from the taskbar.

As of this writing, ArtiosCAD does not support touch input. Some preliminary testing has revealed that selecting and drag select work as expected. However, panning and scrolling do not work correctly.

Support for VMware[®] Fusion

ArtiosCAD is now supported for use on Apple Macintosh computers using the VMware Fusion virtualization software to simulate IBM-compatible personal computers. There are some restrictions to what is supported, however:

1. Parallel security keys are not supported as Apple Macintoshes no longer have parallel ports.
2. VMWare Fusion supports DirectX 8 while ArtiosCAD requires DirectX 9c. As a result, some features may show unexpected behavior.
3. 3D rendering in Direct3D mode is not supported. Use OpenGL rendering instead. To use OpenGL, do the following:
 - In ArtiosCAD, click **Options > Defaults > Shared defaults > Startup defaults > 3D Rendering Options.**

- Select **OpenGL** in the **3D Rendering** group.
- Select **Use OpenGL for bitmaps**.
- Click **OK**.
- Click **File > Exit**.
- Click **Yes** if asked to save changes to Shared defaults.
- Click **Yes** if asked to overwrite Shared defaults.

4. ArtiosCAD Standard Edition Installation

Introduction

There are four types of installations: **Typical**, **Client**, **Server/Custom**, and **Silent**. Each can be used as a new installation or as an upgrade from a previous version of ArtiosCAD.

A **Typical** installation:

- Installs ArtiosCAD as a standalone installation, meaning it is self-contained
- Installs Microsoft SQL Server 2012 Express as the database. YOU MUST HAVE AN INTERNET CONNECTION FOR THIS.
- Allows you to set the program installation folder
- If an upgrade, prompts you to copy a previous configuration or use the default configuration.

A **Client** installation:

- Installs as a client of another system, meaning it uses another system for the database, licensing, and Defaults.
- If a new installation, asks what the database type will be
- Asks for the names of the Defaults and database servers
- Tests the connection to the Defaults server.

A **Server/Custom** installation:

- Installs as a client, server, or as a distributed server, meaning it uses different machines for different functions
- If a new installation, asks if the system will host the database, and if yes, asks if you want to install Microsoft SQL Server 2012 Express 64-bit as the database. YOU MUST HAVE AN INTERNET CONNECTION FOR THIS.
- Shares the Artios folder for use by other systems.
- Is the only way to set the features to be installed, the database type, the SQL authentication method, and the user files folder.

A **Silent** installation presents no dialog boxes, and all options must be specified on the command line. This is meant for use only in large corporate WAN environments where one central administrator installs ArtiosCAD on other computers to which the administrator has remote command access. The silent installation program must be run on the computer on which ArtiosCAD will be used. The silent installation program may not be run on one machine resulting in ArtiosCAD being installed on another machine. Contact Support for more information on performing a Silent installation.

Note: Keep the original ArtiosCAD media in a safe, easily-accessible place in case you need to modify or repair the installation. You must use the same media or network location to repair or modify ArtiosCAD as when you first installed the software.

Performing a Typical installation

Note: If you receive a message about overwriting read-only files, answer yes to overwrite them. Also, if you receive a message about a control failing to register, proceed normally and reboot when the installation finishes.

Note: If you downloaded ArtiosCAD from mysoftware.esko.com, burn the disc image to a DVD and use the DVD to load the software. Store the DVD in a safe place.

If you are going to use the included database product, find out from your IT department what the password policy is, as you will need to know it to set the database user passwords.

To perform a typical ArtiosCAD installation, do the following:

1. Log on as **Administrator**, or as a user with administrative privileges.
2. Ensure that this system meets the minimum system requirements as published on Esko's website (search for system requirements).
3. Put the ArtiosCAD media into the computer's media drive. It should automatically launch the Setup program. If your drive is set to not AutoPlay, start Windows Explorer and double-click **setup.exe** in the root directory of the media.
4. If you have User Account Control enabled, allow setup.exe to run.
5. The ArtiosCAD Setup dialog box appears.
6. Choose the language in which to run the setup program and install ArtiosCAD in using the **Change Language** drop-down. It should automatically match the language of your system but you may change it if desired. The setup program language will change to the language you selected.
7. Click **Typical Installation**.
8. Depending on your system configuration prior to loading ArtiosCAD, the setup program may install required operating system updates. If the system prompts you to reboot, do so; the installation program will resume automatically when you log in after the system comes up again. Do not postpone rebooting if the system requests it.
9. The setup program prompts you to enter passwords for the sa and programmer database users. Choose passwords that comply with your IT security policy. The setup program cannot validate the passwords beforehand so make sure you know what the policy is. The setup program will inform you if the passwords you chose did not work and prompt you to choose new ones. Enter compliant passwords in the Password and Confirm Password fields, record them in a secure place, and click **OK**.
10. The installer starts installing Microsoft SQL Server 2012 Express. This will take a few minutes. If you chose a non-English version of the program, the setup program asks if you'd like to download and install a language-specific version of the database engine; click **Yes**.

Note: This installs Microsoft SQL Server 2012 Express Edition, 64-bit with an instance named ESKO and programmer and sa account passwords of your own choosing. **Make sure to record these passwords in a secure location as you will need them in the future.** The database installer will also install any needed updates, and it may prompt you to reboot. If you do have to reboot, the installation process should continue automatically when you log in again. Several dialog boxes will appear on the screen during the installation but they will disappear automatically. Once the database is installed, proceed with the steps of the installation as outlined below. The setup process will automatically configure the database connection.

- **YOU MUST HAVE AN INTERNET CONNECTION TO INSTALL THIS AND BE USING A 64-BIT OPERATING SYSTEM**
- **YOU MAY ONLY USE THE LANGUAGE OF YOUR OPERATING SYSTEM OR ENGLISH.**
- **YOU MUST HAVE .NET FRAMEWORK 3.5 OR 3.5.1 INSTALLED IN ADDITION TO .NET FRAMEWORK 4.** For Windows 7 and later, this is normally installed by Windows Update, but for Windows Server operating systems, it is a feature that must be installed.

11. The ArtiosCAD installer begins. Click **Next** in the Welcome dialog box.
12. Read the End User License Agreement in its entirety and choose **I accept the terms in the license agreement** if you accept all the terms of the License Agreement. Click **Next**.
13. In the Destination Folder dialog box, choose the folder where ArtiosCAD will be installed. Click **Change** to change the folder, but be mindful that ArtiosCAD should always be installed to the **\Esko\Artios** folder on a local drive. Click **Next**.
14. Review the summary of installation settings. If they are correct, click **Install** to start installing files. If not, click **Back** to go back and change settings.
15. A progress indicator shows the status of the copying process.
16. The Esko Station Information Service will be installed automatically. This service collects information about your hardware, software, and Esko licenses. If the ArtiosCAD Configuration Manager service is installed on a machine on your network, it will forward the information collected to ArtiosCAD for use by Support personnel if you configure it to do so. Several dialog boxes will appear displaying information; you do not need to click anything as they will automatically continue.
17. In the InstallShield Wizard Completed dialog box, click **Finish**.
18. The ArtiosCAD Setup program might prompt for a system reboot. Click **Yes** to reboot the system.

Once the system comes back up, ArtiosCAD and DataCenter Admin will be fully functional.
19. If you installed a non-English version of ArtiosCAD, run `..\Esko\Artios\DataCenter\program \<language>\dbtranslate.exe` to translate phrases in the database.
20. If you are using a network license, click **Install License Server Components** in the main ArtiosCAD Setup dialog box, which will install the license server and activate the license file you supply. For more information on license management, refer to the licensing documents available at <http://www.esko.com/support>.
21. You are now ready to configure ArtiosCAD. You will enter the licensing information for ArtiosCAD the first time you start it.

Performing a Client Installation

Note: If you downloaded ArtiosCAD from mysoftware.esko.com, burn the disc image to a DVD and use the DVD to load the software. Store the DVD in a safe place.

To perform a client installation, do the following:

1. Log on as **Administrator**, or as a user with administrative privileges.
2. Ensure that this system meets the minimum system requirements as published on Esko's website (search for system requirements).
3. Put the ArtiosCAD media into the computer's media drive. It should automatically launch the Setup program. If your drive is set to not AutoPlay, start Windows Explorer and double-click **setup.exe** in the root directory of the media.
4. If you have User Account Control enabled, allow setup.exe to run.
5. The ArtiosCAD Setup dialog box appears.
6. Choose the language in which to run the setup program and install ArtiosCAD in using the **Change Language** drop-down. It should automatically match the language of your system but you may change it if desired. The setup program language will change to the language you selected.
7. Click **Client Installation**.
8. Depending on your system configuration prior to loading ArtiosCAD, the setup program may install required operating system updates. If the system prompts you to reboot, do so; the installation program will resume automatically when you log in after the system comes up again. Do not postpone rebooting if the system requests it.
9. The ArtiosCAD installer begins. Click **Next** in the Welcome dialog box.
10. Read the End User License Agreement in its entirety and choose **I accept the terms in the license agreement** if you accept all the terms of the License Agreement. Click **Next**.
11. In the Destination Folder dialog box, choose the folder where ArtiosCAD will be installed. Click **Change** to change the folder, but be mindful that ArtiosCAD should always be installed to the **\Esko\Artios** folder on a local drive. Click **Next**.
12. In the Database Program Selection dialog box, choose the database program for ArtiosCAD to use. This sets the type of connection to the database server. If client software is required to connect to the database (such as an Oracle client), you must install and configure it separately. Click **Next**.
13. In the Server Information dialog box, enter the names of the systems acting as the Defaults server and Database Server. If the Database Server field is unavailable, the database server must be configured manually via the ArtiosCAD entry in the 32-bit ODBC control panel. You can enter the same system name in all the fields, or you can specify a different system in each field. If you enter remote system names, and those remote systems do not have ArtiosCAD loaded on them, you will have to manually enter the exact path to the applicable resources. **ArtiosCAD must be loaded on the server you indicated on these remote systems for ArtiosCAD to work on the current system!** It does not have to be loaded at the time of the current system installation, but should be loaded soon afterward. Click **Next**.

14. Review the summary of installation settings. If they are correct, click **Install** to start installing files. If not, click **Back** to go back and change settings.
15. A progress indicator shows the status of the copying process.
16. If there is no other Esko software on this system, the Esko Station Information Service will be installed automatically. This service collects information about your hardware, software, and Esko licenses. If the Esko Configuration Manager service is installed on a machine on your network, it will forward the information collected to Esko for use by Support personnel if you configure it to do so. Several dialog boxes will appear displaying information; you do not need to click anything as they will automatically continue.
17. In the InstallShield Wizard Completed dialog box, if you are using a local license, click **Activate Local Licenses** to begin activating your license so that you can start using ArtiosCAD. For more information on license management, refer to the licensing documents available at <http://www.esko.com/support>. When your local license activation is complete, or if you are using a network license, click **Finish**.

You are now ready to start using ArtiosCAD. You will enter the licensing information for ArtiosCAD the first time you start it.

Performing a Server/Custom Installation

Note:

If you downloaded ArtiosCAD from mysoftware.esko.com, burn the disc image to a DVD and use the DVD to load the software. Store the DVD in a safe place.

If you are going to use the included database product, find out from your IT department what the password policy is, as you will need to know it to set the database user passwords.

To perform a Server/Custom installation, do the following:

1. Log on as **Administrator**, or as a user with administrative privileges.
2. Ensure that this system meets the minimum system requirements as published on Esko's website (search for system requirements).
3. Put the ArtiosCAD media into the computer's media drive. It should automatically launch the Setup program. If your drive is set to not AutoPlay, start Windows Explorer and double-click **setup.exe** in the root directory of the media.
4. If you have User Account Control enabled, allow setup.exe to run.
5. The ArtiosCAD Setup dialog box appears.
6. Choose the language in which to run the setup program and install ArtiosCAD in using the **Change Language** drop-down. It should automatically match the language of your system but you may change it if desired. The setup program language will change to the language you selected.
7. Click **Server/Custom Installation**.
8. The setup program asks if this system will host the ArtiosCAD database. Click **Yes** if it will or **No** if you have a dedicated database server.

9. If you clicked Yes in the previous step, the setup program asks if you would like to install the free bundled database, Microsoft SQL Server 2012 Express Edition, 64-bit. If you want to use this database:
 - a) **YOU MUST HAVE AN INTERNET CONNECTION TO INSTALL THIS AND BE USING A 64-BIT OPERATING SYSTEM**
 - b) **YOU MAY ONLY USE THE LANGUAGE OF YOUR OPERATING SYSTEM OR ENGLISH**
 - c) **YOU MUST HAVE .NET FRAMEWORK 3.5 OR 3.5.1 INSTALLED IN ADDITION TO .NET FRAMEWORK 4.** For Windows 7 and later, this is normally installed by Windows Update, but for Windows Server operating systems, it is a feature that must be installed.

Clicking **Yes** will install Microsoft SQL Server 2012 Express Edition, 64-bit with an instance named ESKO and sa account password of your own choosing. If you chose a non-English version of the program, the setup program asks if you'd like to download and install a language-specific version of the database engine; click **Yes**. The setup program prompts you to enter passwords for the sa and programmer database users. Choose passwords that comply with your IT security policy. The setup program cannot validate the passwords beforehand so make sure you know what the policy is. The setup program will inform you if the passwords you chose did not work and prompt you to choose new ones. Enter compliant passwords in the Password and Confirm Password fields, record them in a secure place, and click **OK**. The database installer will also install any needed updates, and it may prompt you to reboot. If you do have to reboot, the installation process should continue automatically when you log in again. Several dialog boxes will appear on the screen during the installation but they will disappear automatically. Once the database is installed, proceed with the steps of the installation as outlined below. The setup process will automatically configure the database connection. If you will be using a full version of Microsoft SQL Server or Oracle, click **No** and proceed with the steps of the installation as outlined below. You will configure the database connection after installation.

10. Depending on your system configuration prior to loading ArtiosCAD, the setup program may install required operating system updates. If the system prompts you to reboot, do so; the installation program will resume automatically when you log in after the system comes up again. Do not postpone rebooting if the system requests it.
11. The ArtiosCAD installer begins. Click **Next** in the Welcome dialog box.
12. Read the End User License Agreement in its entirety and choose **I accept the terms in the license agreement** if you accept all the terms of the License Agreement. Click **Next**.
13. In the Setup Type dialog box, choose the type of system this will be according to the choice descriptions.
 - a) **Client** performs a client installation just as if you had clicked Client Installation in the main installer.
 - b) **Server** performs an installation as if you had clicked Typical Installation in the main installer, except that it also shares the Artios folder for use by other systems.
 - c) **Advanced** performs an installation with all configuration options available. It is the only way to set the features to be installed, the database type, the SQL authentication method, and the user files folder.

Going forward, these instructions will assume you chose **Advanced**. If you made another choice, follow the instructions in those sections.

14. In the Feature Selection dialog box, choose the features to install on the current machine. For each feature, click the icon in the drop-down list box next to it and choose the appropriate choice. Do not click **Next** when done, but rather proceed to the next numbered step.

- a) *ArtiosCAD Configuration*. Click the plus sign (+) next to this entry to open it. **ArtiosCAD Licensing**, **ArtiosCAD Defaults**, and **ArtiosCAD Database** can each be installed in any combination on a machine. For Typical and all Standalone installations, leave them all selected.
 - b) *ArtiosCAD Programs*. **ArtiosCAD Programs** are the program files needed to run ArtiosCAD. You must install these if you want to run ArtiosCAD on the current machine. Not installing these would create a server-only installation provided the servers were selected for installation. You must leave this choice selected to install ArtiosCAD itself.
 - c) The *ArtiosCAD Programs* group controls whether or not ArtiosCAD itself is installed. Optional components of ArtiosCAD that require purchasing a license for the corresponding modules are contained as subfeatures in the group. At this time, only **ArtiosCAD 3D Data Exchange** is a selection. Refer to the license report from Esko to determine which components to select. Installing software components without having the corresponding licenses wastes disc space. Not installing the software components but having the licenses for them results in features that do not function within ArtiosCAD.
 - d) **Esko Configuration Manager** collects data from systems running the Esko Station Information Service and sends the collected data to Esko automatically for use by Support personnel. **It sends information only if you configure it to do so and leave it enabled.** It is a great aid to Support personnel as they will have required information about your hardware and licenses available should you need to call for assistance. Only one system per site should have the Esko Configuration Manager installed.
15. While still in the Feature Selection dialog box, with one of the components to be installed selected, review the folder in which ArtiosCAD will be installed, and click **Change** if desired. In the resulting Change Current Destination Folder dialog box, change the drive if desired, and click **OK** to return to the Feature Selection dialog box. ArtiosCAD should always be installed to the **\Esko\Artios** folder on a local drive. Click **Next**.
 16. Choose the database program for ArtiosCAD to use. The default and recommended choice is SQL Server Express Edition, a free desktop database from Microsoft that requires a 64-bit operating system. If this is a new installation, you must have already installed it to use this choice. **MSDE** is an older free desktop database from Microsoft that does not require a 64-bit operating system but that offers less robust performance. Choosing **Microsoft SQL Server or Oracle** is appropriate for workgroup or enterprise use where those databases are already in use. Click **Next**.
 17. In the Server Information dialog box, enter the names of the systems acting as the Defaults server and Database Server. If the Database Server field is unavailable, the database server must be configured manually via the ArtiosCAD entry in the 32-bit ODBC control panel. You can enter the same system name in all the fields, or you can specify a different system in each field. If you enter remote system names, and those remote systems do not have ArtiosCAD loaded on them, you will have to manually enter the exact path to the applicable resources. **ArtiosCAD must be loaded on the server you indicated on these remote systems for ArtiosCAD to work on the current system!** It does not have to be loaded at the time of the current system installation, but should be loaded soon afterward. Click **Next**.
 If you choose **Microsoft SQL Server or Oracle**, configuration scripts and a batch file for those databases will be placed in the **\Esko\Artios\DataCenter** directory. The database administrator **MUST** run the appropriate batch file before using ArtiosCAD or ArtiosCAD Enterprise. Other post-installation tasks must be performed as well.

18. The default location for the storage of user files is shown in the User Files Folder dialog box. To change it, click **Change**; to accept it, click **Next**. If you change the location to another system, use a UNC locator (e. g. `\\system2\designs`) instead of a mapped drive letter.
19. In the Advanced Options dialog box:
- Keep Previous Versions** is the default for previous version handling. It means that ArtiosCAD is installed using a version-specific folder and icon which match the version of the installation, and all previous versions of ArtiosCAD are kept. All previous installations of language-specific versions will have their Defaults merged into the multilingual version being installed. To change this setting, click **Change**. In the Previous Version Handling dialog box, **Overwrite previous versions** simply uses ArtiosCAD as the icon name and ArtiosCAD as the directory with no version number. Once you have chosen the option to use, click **OK** to return to the Advanced Options dialog box.
 - If you are using SQL Server Express Edition or Microsoft SQL Server as the database, you have the choice of database authentication methods. **SQL Server Authentication** requires each user to have a login created within the database; by default, ArtiosCAD uses one database user (programmer) for all ArtiosCAD users. However, your company may have different requirements. **Windows Authentication** passes operating system login credentials to the database. You should use Windows Authentication only if you have a dedicated database administrator who can perform user maintenance tasks.
 - Enter the SA user password you specified earlier in the SA Password field.
 - Click **Next**.
20. Review the summary of installation settings. If they are correct, click **Install** to start installing files. If not, click **Back** to go back and change settings.
21. A progress indicator shows the status of the copying process. Click **OK** if told that the Artios directory has been shared. Everyone has read-only access to this share; members of the local Administrators group have read/write access.
22. If there is no other Esko software on this system, the Esko Station Information Service will be installed automatically. This service collects information about your hardware, software, and Esko licenses. If the Esko Configuration Manager service is installed on a machine on your network, it will forward the information collected to Esko for use by Support personnel if you configure it to do so. Several dialog boxes will appear displaying information; you do not need to click anything as they will automatically continue.
23. In the InstallShield Wizard Completed dialog box, click **Finish**.
24. The ArtiosCAD Setup program might prompt for a system reboot. Click **Yes** to reboot the system. Once the system comes back up, ArtiosCAD and ArtiosCAD will be fully functional
25. If you installed a non-English version of ArtiosCAD, run `\\Esko\Artios\DataCenter\program \<language>\dbtranslate.exe` to translate phrases in the database.
26. If you are using a network license, click **Install License Server Components** in the main ArtiosCAD Setup dialog box, which will install the license server and activate the license file you supply. For more information on license management, refer to the licensing documents available at <http://help.esko.com>.
27. You are now ready to configure ArtiosCAD. You will enter the licensing information for ArtiosCAD the first time you start it.

Installing a New Version of ArtiosCAD

This procedure is to install a newer major version of ArtiosCAD, not to update your current version with a new build.

Note: If you are going from a pre-16 version to 16 or greater, note that the new version of ArtiosCAD will have language- and version-agnostic Defaults. This means that there will only be one set of Defaults for all languages and versions of ArtiosCAD version 16 and newer. Older versions of ArtiosCAD on this computer will continue to use their own Defaults.

To install a newer version of ArtiosCAD, do the following:

1. Log on as **Administrator**, or as a user with administrative privileges.
2. Ensure that this system meets the minimum system requirements as published on Esko's website (search for system requirements).
3. Put the ArtiosCAD media into the computer's media drive. It should automatically launch the Setup program. If your drive is set to not AutoPlay, start Windows Explorer and double-click **setup.exe** in the root directory of the media.
4. If you have User Account Control enabled, allow setup.exe to run.
5. The ArtiosCAD Setup dialog box appears.
6. Based on your current installation, choose the type of installation to perform, **Typical**, **Client**, or **Server/Custom**.
7. Click **Next** in the Welcome to the InstallShield Wizard for ArtiosCADX.xx dialog box.
8. Read the End User License Agreement in its entirety and choose **I accept the terms in the license agreement** if you accept all the terms of the License Agreement. Click **Next**.
9. In the Configuration Source dialog box, choose to copy the Defaults from a previous version and then click the previous version whose Defaults you want to use, or choose to use the default configuration which will install a completely unmodified set of Defaults. You should copy the previous configuration if you customized ArtiosCAD in any way, such as adding Output devices and making your own Reports. If the previous version had different languages available, choose from which language to copy Defaults in the **Copy configuration from this language** drop-down list box; you may only upgrade from one language. Click **Next**.
10. Review the settings listed in the Ready to Install the Program dialog box. If they are correct, click **Install** to start copying files. If not, click **Back** to go back and change settings.
11. A progress indicator will show the status of the copying process. Click **OK** if told that the Artios directory has been shared.
12. In the InstallShield Wizard Completed dialog box, click **Finish**. You will enter the licensing information for ArtiosCAD the first time you start it.

If you installed a non-English version of ArtiosCAD, run **\Esko\Artios\DataCenter\program \<language>\dbtranslate.exe** to translate phrases in the database.

To switch from using MSDE to using SQL Server Express Edition, refer to the instructions at the end of the chapter.

If you are using a network license and received a new license, activate it by using the Activate Licenses application in the System Controller subfolder of the Esko folder of the Start menu.

For more information on license management, refer to the licensing documents available at <http://www.esko.com/support>.

Installing a New Build of the Current Version

This procedure is to install a new build of your current version of ArtiosCAD.

To install a new build of ArtiosCAD, do the following:

1. If this is a server installation, make sure nobody is using ArtiosCAD.
2. Log on as **Administrator**, or as a user with administrative privileges.
3. Ensure that this system meets the minimum system requirements as published on Esko's website (search for system requirements).
4. Put the ArtiosCAD media into the computer's media drive. It should automatically launch the Setup program. If your drive is set to not AutoPlay, start Windows Explorer and double-click **setup.exe** in the root directory of the media.
5. If you have User Account Control enabled, allow setup.exe to run.
6. The ArtiosCAD Setup dialog box appears.
7. Click **Update ArtiosCAD Installation**.
8. Click **Yes** when told this will upgrade ArtiosCAD and to continue.
9. Click **Next** in the Resuming the InstallShield Wizard dialog box.
10. A progress indicator shows the status of the copying process.
11. In the InstallShield Wizard Completed dialog box, click **Finish**.
12. ArtiosCAD is now updated and ready for use.

Installing Microsoft SQL Server 2012 Express Edition Only

To create a database server for ArtiosCAD based on Microsoft SQL Server Express Edition without having to install ArtiosCAD, do the following on a machine that has never had ArtiosCAD on it:

1. Log on as **Administrator**, or as a user with administrative privileges. Keep these prerequisites in mind:
 - a) **YOU MUST HAVE AN INTERNET CONNECTION TO INSTALL THIS AND BE USING A 64-BIT OPERATING SYSTEM**
 - b) **YOU MAY ONLY USE THE LANGUAGE OF YOUR OPERATING SYSTEM OR ENGLISH**
 - c) **YOU MUST HAVE .NET FRAMEWORK 3.5 OR 3.5.1 INSTALLED IN ADDITION TO .NET FRAMEWORK 4.** For Windows 7 and later, this is normally installed by Windows Update, but for Windows Server operating systems, it is a feature that must be installed.
2. Ensure that this system meets the minimum system requirements as published on Esko's website (search for system requirements).

3. Put the ArtiosCAD media into the computer's media drive. It should automatically launch the Setup program. If your drive is set to not AutoPlay, start Windows Explorer and double-click **setup.exe** in the root directory of the media.
4. If you have User Account Control enabled, allow setup.exe to run.
5. The ArtiosCAD Setup dialog box appears.
6. Click **Install Microsoft SQL Server 2012 Express**. The installer will start.
7. The setup program prompts you to enter passwords for the sa and programmer database users. Choose passwords that comply with your IT security policy. The setup program cannot validate the passwords beforehand so make sure you know what the policy is. The setup program will inform you if the passwords you chose did not work and prompt you to choose new ones. Enter compliant passwords in the Password and Confirm Password fields, record them in a secure place, and click **OK**.
This installs Microsoft SQL Server 2012 Express Edition, 64-bit with an instance named ESKO and programmer and sa account passwords of your own choosing. **Make sure to record these passwords in a secure location as you will need them in the future.** The database installer will also install any needed updates, and it may prompt you to reboot. If you do have to reboot, the installation process should continue automatically when you log in again. Several dialog boxes will appear on the screen during the installation but they will disappear automatically.
8. Run `\\Windows\SysWOW64\odbcad32.exe`.
9. In the ODBC Data Source Administrator, click **System DSN** and click **Add**.
10. Select **SQL Server** from the list of available drivers and click **Finish**.
11. In the Create a New Data Source to SQL Server dialog box, enter ArtiosCAD in the Name and Description fields and select the server and instance name in the Server drop-down list box. It should be **Name of this machine\ESKO**. Click **Next**.
12. When asked about authenticity, select the **With SQL Server authentication...** choice. For the **Connect to SQL Server...** checkbox, enter sa as the Login ID and the password you specified earlier for the sa user. Do not click **Next**.
13. Click **Client Configuration**. The Add Network Library Configuration dialog box appears.
 - a) Make sure **TCP/IP** is selected in the Network libraries group and ensure the server name is correct. If (**local**) was selected in the Which SQL Server do you want to connect to? field in Step 11, only a period (.) appears in the Server alias field and Server name field.
 - b) Ensure that **Dynamically determine port** is checked and that the **Port number** is set to 1433. Click **OK**.
 - c) Click **Next** in the Create a New Data Source to SQL Server dialog box.
14. In the next dialog box, leave the **Create temporary stored procedures...** and **Use ANSI...** choices selected and click **Next**.
15. In the next dialog box, leave **Perform translation for character data** selected. If the system is using non-U.S. locale settings, check the **Change the language of SQL Server system messages to:** checkbox and set the value to **English**. Click **Finish**.
16. The ODBC Microsoft SQL Server Setup dialog box will appear showing a summary of the configuration. Click **Test Data Source**; it should succeed. Click **OK**, and then click **OK** again.
17. Click **OK** in the ODBC Data Source Administrator dialog box.

This database server is now ready for use.

Using other databases with ArtiosCAD

If you chose **Microsoft SQL Server or Oracle** in the Database Program Selection dialog box, your database administrator must configure the database to work with ArtiosCAD. See *Running the Esko ArtiosCAD database configuration batch file* for Microsoft SQL Server 2005 or 2000 or *Using Oracle* for Oracle.

Other database notes

To change the database engine used with ArtiosCAD, delete the **ArtiosCAD** data source from the System DSN tab of the 32-bit ODBC Data Sources control panel and reinstall ArtiosCAD.

Oracle databases should either have autoexpand set for the tablespace or should have a very large maximum extent set.

Do not change the database passwords in a vendor-supplied utility. Rather, change them in DataCenter Admin by using the **File > Change Database Connection (programmer) Password** or **Change Database System Administrator (sa) Password** commands.

Upgrading other databases with ArtiosCAD

If you use Oracle or Microsoft SQL Server as the database engine, you must run the database scripts batch file after ArtiosCAD finishes loading and the system has rebooted (if applicable). See the Other Tasks chapter's sections about using Oracle or Microsoft SQL Server for more information.

Other database notes

To change the database engine used with ArtiosCAD, delete the **ArtiosCAD** data source on the System DSN tab from the ODBC control panel and reinstall ArtiosCAD.

Oracle databases should either have autoexpand set for the tablespace or should have a very large maximum extent set.

Do not change the database passwords in a vendor-supplied utility. Rather, change them in DataCenter Admin by using the **File > Change Database Connection (programmer) Password** or **Change Database System Administrator (sa) Password** commands.

Changing to SQL Server Express Edition on the database server

SQL Server Express Edition is a replacement for Microsoft Access and MSDE which Esko believes offers greater stability and better performance for ArtiosCAD.

If your system currently uses Microsoft Access as the database engine, you must upgrade it to SQL Server Express Edition. If your system currently uses MSDE, you may continue to use it, but SQL Server Express Edition offers better performance than MSDE.

If you choose to change to SQL Server Express Edition, you should export non-design-based database information from the old database before starting to load ArtiosCAD. The migration to SQL Server Express Edition should be error-free, but if there are problems, you can import this data into a blank database and then do an AutoLoad to create a new database.

Note: This migration workflow is not supported for SQL Server Express Edition version X to SQL Server Express Edition Y. You must use SQL Server's native detach/attach functionality. The shortcuts to these programs are not installed with versions of ArtiosCAD newer than 14.1.1.

Exporting database information from the old database

To export non-design-based data from the existing database, do the following:

1. Ensure that any programs using the database are not running.
2. Log on to the database server as Administrator or as a member of the **Administrators** group.
3. Click **Start > Programs > ArtiosCAD > Migration Tools > ArtiosCAD Database Export**.
4. Enter **admin** as the username with no password, and click **OK**.
5. The utility will appear similar to the picture shown below.

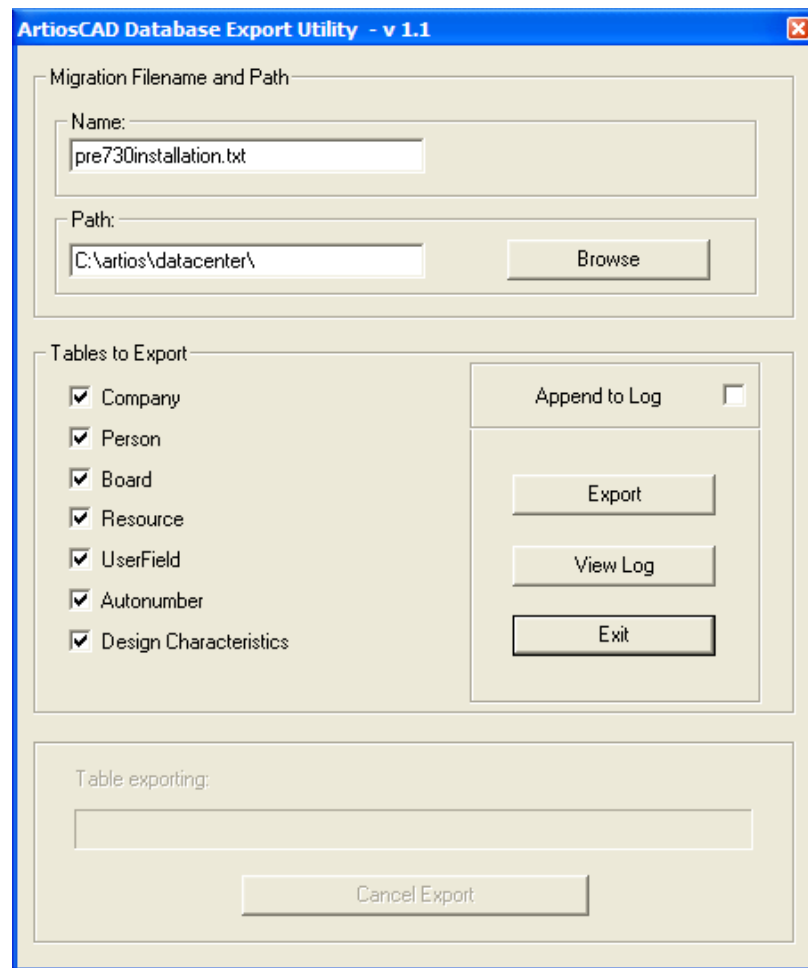

6. Enter a sensible file name and location in the **Migration Filename and Path:** group.
7. Select all the available tables.
8. Click **Export**. The progress bar indicates the progress of the export.
9. When the export is done, click **Exit**. If the migration to SQL Server Express Edition is error-free, you can delete the exported file after the migration if desired.

Loading the upgrade

When you install ArtiosCAD as an upgrade and have been using Microsoft Access or MSDE as the database engine, choose SQL Server Express Edition as the database type, a checkbox appears asking if you want to migrate prior database data to SQL Server Express Edition if this system is the database server.

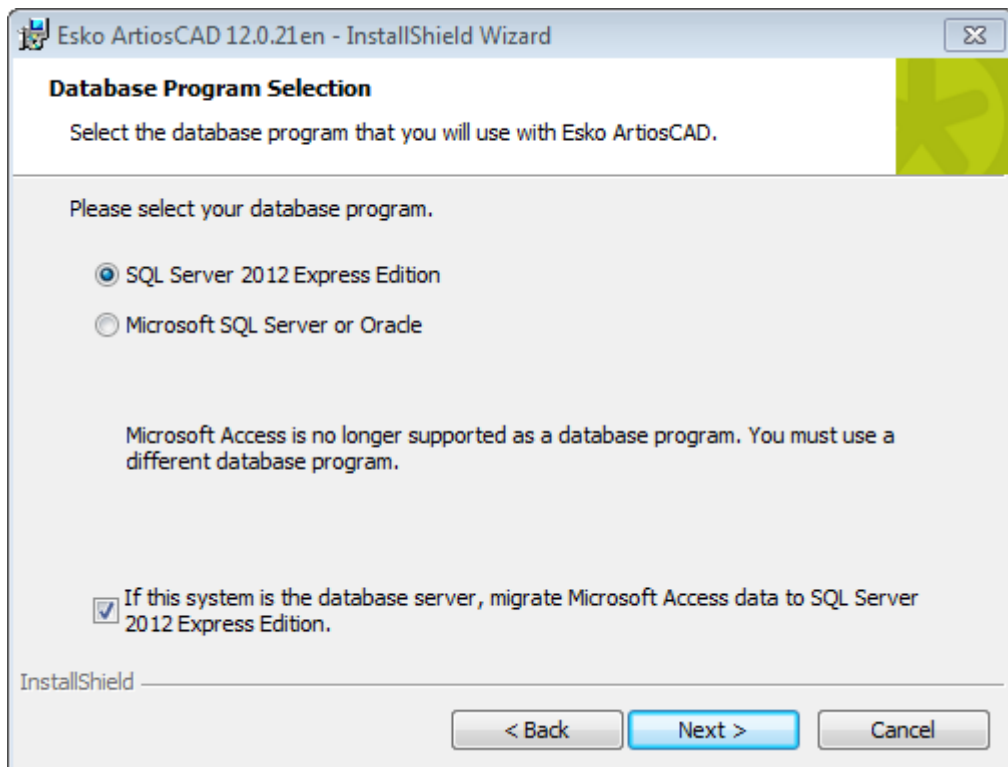

If you choose SQL Server Express Edition as the database program and this system is the database server, the following actions happen:

- A database schema is built or updated as appropriate.
- The existing ArtiosCAD ODBC datasource is renamed to ArtiosCAD_Access or ArtiosCAD_MSDE as appropriate.
- Empty command prompt windows appear.
- The ArtiosCAD ODBC data source changes to reference the new SQL Server Express Edition database.
- A service called **SQL Server (ARTIOSCADEXP2005)** is created and started.

If this system is not the database server, the ArtiosCAD ODBC datasource changes to reference the SQL Server Express Edition database.

If you choose to migrate the data, the setup program tries to export the data from the old database. If the export is successful, the data is migrated to the SQL Server Express Edition database.

If you do not choose to migrate the data, a blank SQL Server Express Edition database is created and you have to manually export the data from the old database and manually import the data into SQL Server Express Edition.

Automatic migration

If you choose to have the setup program migrate the data, a series of empty command prompt windows appears during the installation while the migration tasks are executing. Their duration is directly proportional to the size of the old database.

If there are errors during the migration process, you must manually migrate the data as instructed in the next section.

Signs of a successful migration are:

- Data appearing in the design browsers in ArtiosCAD, and also in DataCenter Admin, provided that the ArtiosCAD System DSN uses a Microsoft SQL Server driver.

If the automatic migration fails, you must perform a manual migration.

Manual migration

If you do not choose automatic migration, you must perform the data migration manually on the database server for the old database after the ArtiosCAD installation finishes.

The steps to performing the migration manually are as follows:

1. Export the data.
2. Check the log file for errors.
3. Import the data.
4. Check the log file for errors and try ArtiosCAD.

Exporting the data

To export the data from the old database, do the following.

1. Log on as Administrator or as a member of the **Administrators** group.
2. Click **Start > Programs > Esko > ArtiosCAD > Migration Tools > ArtiosCAD Database Migration Export**. The export utility will appear along with a blank command prompt window.

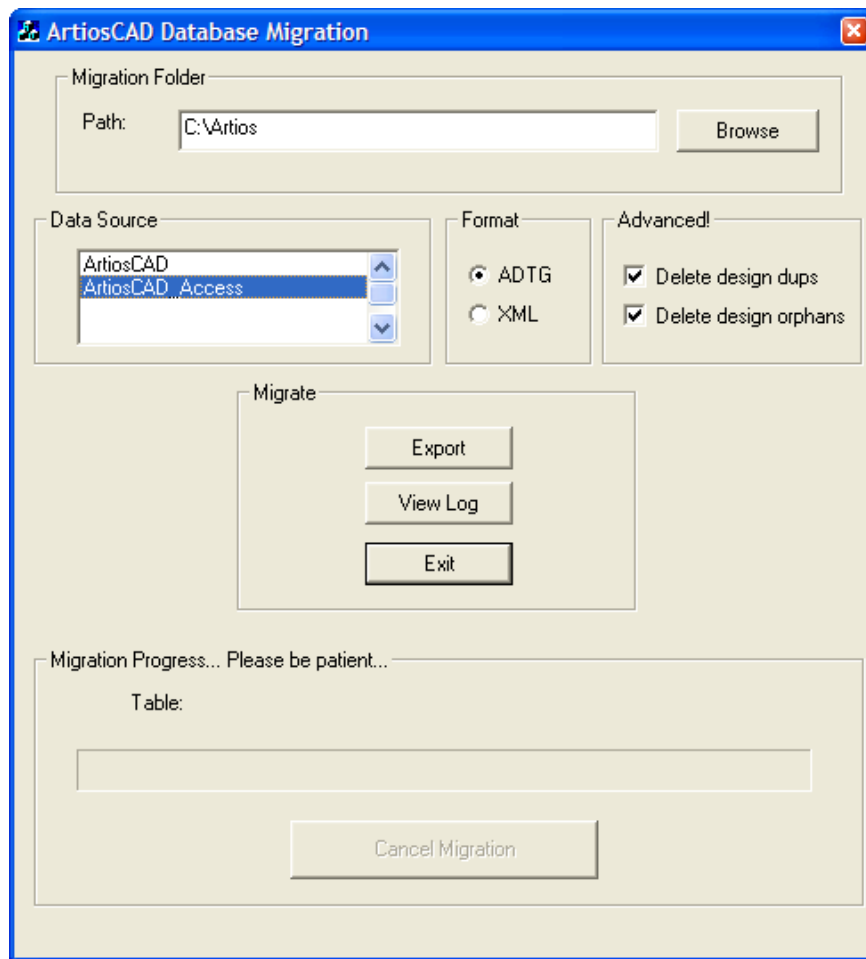

The **Migration Folder** group shows the folder that stores the files created by the export utility. The export files require the same amount of hard drive space as the Microsoft Access database file, so make sure to choose a location with enough free space. Click **Browse** to select a new location.

The **Data Source** group lists the available data sources. **Make sure to select the ArtiosCAD_Access or ArtiosCAD_MSDE as the data source for this migration.**

The **Format** group selects the format of the migration files. **ADTG** is the default; if it errors, try **XML**.

In the **Advanced** group, **Delete design dups** deletes duplicate design records in the database; preserving the newest record and discarding older duplicates. **Delete orphans** deletes table entries that no longer have corresponding design records on the hard drive. Both options are enabled by default.

The **Migrate** group contains the actual commands. **Export** exports the data from the selected data source in the format selected to the migration folder. **View Log** opens the log file of the export. It is stored in the system temporary directory as **ACadFullDbMigrationExportLog.txt**. **Exit** exits the program.

The **Migration Process** group contains the progress bar showing the table being exported. The length of time required to export the data is directly proportional to the size of the database.

Cancel Migration cancels the migration. Do not use the migration files created by a cancelled migration.

1. Set the migration folder and format as desired, select the **ArtiosCAD_Access** or **ArtiosCAD_MSDE** data source, and click **Export**. During the export, all controls in the dialog box are unavailable except for **Cancel Migration**.

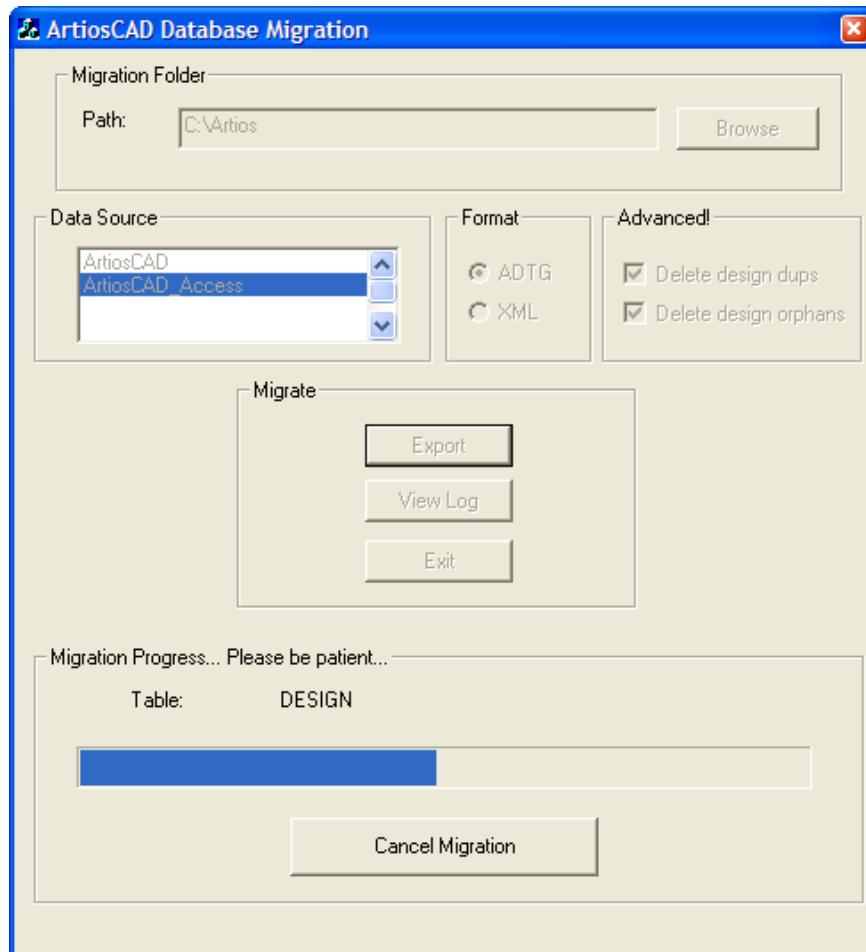

2. There should be no errors. If an error appears, delete all the ADTG files created by this migration and try using XML for the migration format. If there are no errors, the next step is to check the log file.

Checking the log file for export errors

1. Even if no errors appeared during export, click **View Log** to view the log file. Information, warnings, and errors are logged. Check the log file for warnings and errors. Warnings related to tables not existing are usually caused by database schema differences among ArtiosCAD versions; these can be safely ignored. Only errors warrant concern. A sample log file is shown below; yours might vary.

Table: Sample ACadDBFullMigrationExportLog.txt

```
Information: [Exporting table] CODE_TYPE
```

```

Information: [Exporting table] IQ_DEFAULTS
Information: [Exporting table] CODE
Information: [Exporting table] HIERARCHICAL_STYLES
Information: [Exporting table] COMPANY
Information: [Exporting table] PERSON
Information: [Exporting table] FLUTE
Information: [Exporting table] BOARD_FOLDER
Information: [Exporting table] BOARD
Information: [Exporting table] HIERARCHICAL_BOARDS
Information: [Exporting table] MEDIUM
Information: [Exporting table] SERVER
Information: [Exporting table] RESOURCE_TABLE
Information: [Exporting table] COUNTER
Information: [Exporting table] COST_CENTER
Information: [Exporting table] AUTONUMBER
Information: [Exporting table] UNITS
Information: [Exporting table] USER_FIELD_TYPE
Information: [Exporting table] PREDEFINED_USERFIELDS
Information: [Exporting table] PREDEFINED_USERFIELD_VALUES
Information: [Exporting table] USER_FIELD
Information: [Exporting table] DESIGN
Information: [Exporting table] DESIGN_IMAGE
Information: [Exporting table] DESIGN_STYLE
Information: [Exporting table] DESIGN_USER_FIELDS
Information: [Exporting table] PRINT_ITEM
Information: [Exporting table] LAYOUT
Information: [Exporting table] LAYOUT_USER_FIELDS
Information: [Exporting table] LAYOUT_DESIGN
Information: [Exporting table] PRINT_ITEM_LAYOUT
Information: [Exporting table] LAYOUT_DESIGN_IMAGE
Information: [Exporting table] LAYOUT_DESIGN_STYLE
Information: [Exporting table] LAYOUT_DESIGN_USER_FIELDS
Information: [Exporting table] Projects
Information: [Exporting table] Project_printitem
Information: [Exporting table] User_Group_List
Information: [Exporting table] User_In_Group
Information: [Exporting table] Group_Parent
Information: [Exporting table] Security_Element
Information: [Exporting table] CAD_Permission
Information: [Exporting table] Global_Permission
Information: [Exporting table] Profile_Defaults
Information: [Exporting table] User_Profile
***** The ArtiosCAD full database migration ended at: 10/09/07, 14:44:07
    
```

2. Once you have reviewed the log file, close it. If there were errors, delete the XML or ADTG files and AutoLoad in database recovery mode.
3. Click **Exit** to exit the ArtiosCAD Database Migration Export utility. The next step is to import the data.

Importing the data

1. Click **Start > Programs > Esko > ArtiosCAD > Migration Tools > ArtiosCAD Database Migration Import**. The import utility will appear along with a blank command prompt window.

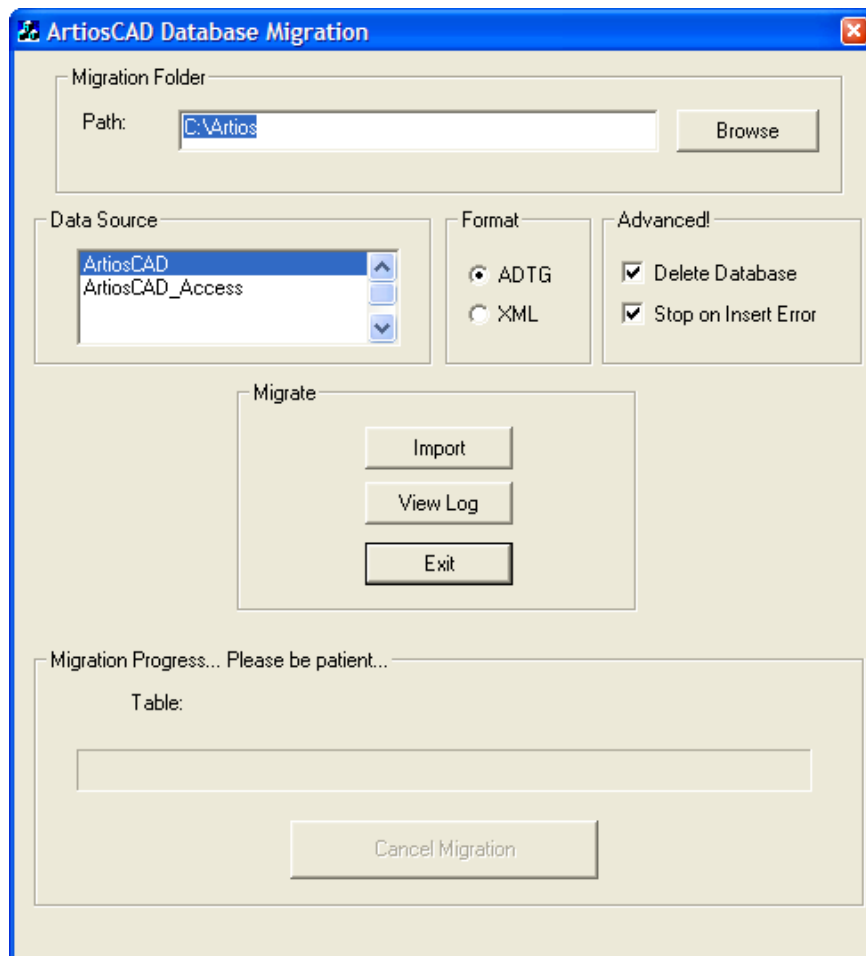

2. The **Migration Folder Path** folder is automatically set to the same folder as the one used previously by the ArtiosCAD Database Migration Export utility.

Make sure to set the option button in the **Format** group to the same format as that used in the export.

Select the **ArtiosCAD** data source if it is not already selected.

In the **Advanced** group, **Delete Database** deletes the contents of the database before importing the data stored in the migration file. For example, to make an exact copy of the database from which you are migrating, select this option, but if you are importing only one table, deselect this option. **Stop on Insert error** completely stops the migration when there is a problem adding information. When deselected, the process continues regardless of errors, and you should read the log file to see if there are errors.

3. Click **Import** when you have set the options as desired. During the import, all dialog box controls are unavailable except for **Cancel Migration**. The progress bar moves to the right as the import progresses. There should be no errors.

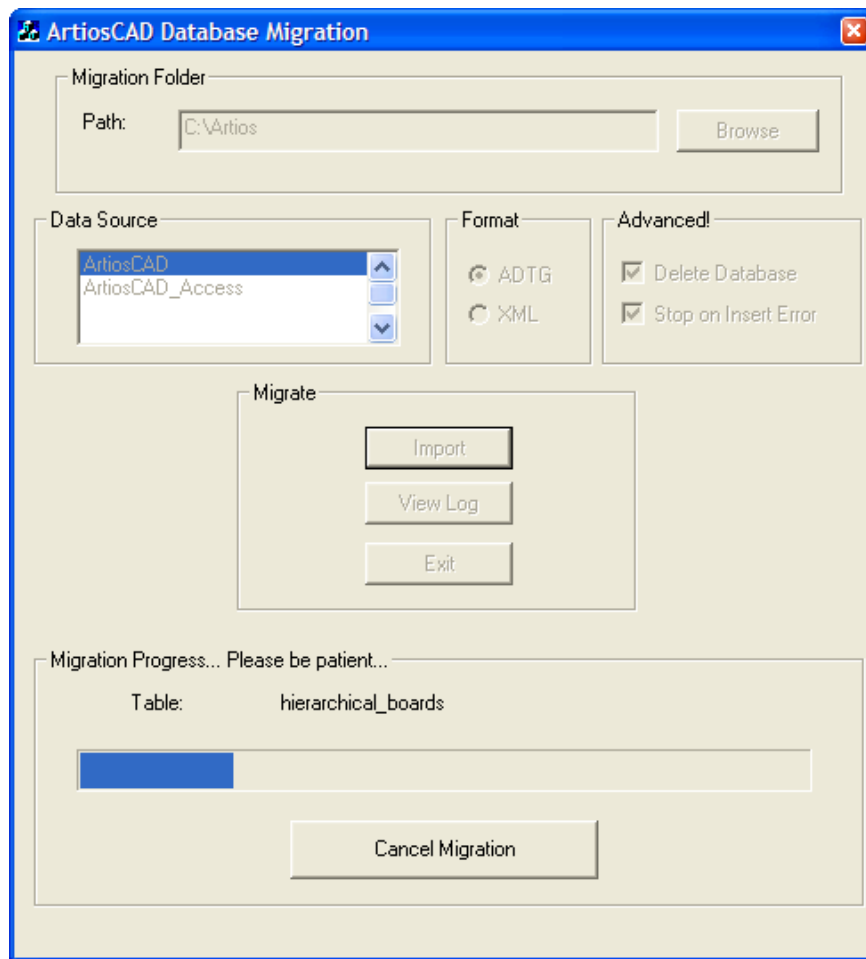

Checking the log file for import errors

1. Even if there are no errors, click **View Log** when the import is done to review the log file for errors. Information, warnings, and errors are logged. Check the log file for warnings and errors. A sample log file is shown below; yours might vary.

Table: Sample ACadDBFullMigrationImportLog.txt

```

***** The ArtiosCAD full database migration began at: 10/09/07, 14:52:17
Information: Deleting data from all tables
Information: [Importing data] code_type [C:\Artios\code_type.adtg]
Information: [Importing data] iq_defaults [C:\Artios\iq_defaults.adtg]
Information: [Importing data] code [C:\Artios\code.adtg]
Information: [Importing data] hierarchical_styles [C:\Artios
\hierarchical_styles.adtg]
Information: [Importing data] company [C:\Artios\company.adtg]
Information: [Importing data] person [C:\Artios\person.adtg]
Information: [Importing data] flute [C:\Artios\flute.adtg]
Information: [Importing data] board_folder [C:\Artios\board_folder.adtg]
Information: [Importing data] board [C:\Artios\board.adtg]
.
.
Information: [Importing data] cad_permission [C:\Artios\cad_permission.adtg]
    
```

```
Information: [Importing data] global_permission [C:\Artios
\global_permission.adtg]
Information: [Importing data] profile_defaults [C:\Artios\profile_defaults.adtg]
Information: [Importing data] user_profile [C:\Artios\user_profile.adtg]
***** The ArtiosCAD full database migration ended at: 10/09/07, 14:52:19
```

2. Once you have verified there are no errors, close the log file. If there were errors, delete the XML or ADTG files and try the complete process again, using the other format for the data files. If that fails as well, delete the data files and use AutoLoad in database recovery mode.
3. Start ArtiosCAD.
4. Click **Database > Browsers > Design browser**. The Design Browser should appear normally.
5. If you are upgrading from a version of ArtiosCAD earlier than version 4, run \Esko\Artios\DataCenter\Program\Buildkeys.exe to convert design styles to hierarchical characteristics.
6. The migration to the new database is complete.

Once you have verified that all the data is in the database, delete the XML or ADTG files from the migration folder.

ArtiosCAD Database Migration utility command-line options

You can run the ArtiosCAD Database Migration utility from the command line if desired. This ability is meant for use by system administrators in large corporations who manage remote computers.

Use a command prompt to go to the \Esko\Artios\Datacenter\program\language folder.

Next, run ACADDbMigration.exe with the desired switches.

Switch	Meaning
-c	Use the command line versus a dialog box.
-e	Export data (the default.)
-i	Import data.
-f folder	Specifies the folder in which the migration files are located. The default is whatever is specified in the registry from a previous export else it is unknown. The registry key is HKLM\Software\Artios\Migration. The registry value is Migration_FullDB_Folder. If -c is used, -f should be used if you are unsure the registry value exists.
-l logfile	Log file folder and name. The default location is the temp directory specified by the TMP variable if it exists, else the TEMP variable if it exists, else the current directory. The file name is ACADFullDbMigrationExportLog.txt (or ...ImportLog.txt)
-d datasource name	The default is ArtiosCAD. Note that the Microsoft Access datasource name was changed to ArtiosCAD_Access when you changed to MSDE.

Switch	Meaning
--------	---------

-t xml or **adtg** Format for the migration files. ADTG is the default.

Changing to SQL Server Express Edition on client systems

If you change your database server to SQL Server Express Edition, you must also load the upgrade on all client systems to configure them to use the new server software. No database software is loaded on clients.

Network Ports List

ArtiosCAD uses network ports to communicate with its license server (if you use a network license), with the database server (if it is not the local machine), and to perform Outputs. Your computer and the various servers may be running a firewall that blocks ports and thus ArtiosCAD may not work correctly.

Program	Ports needed
FlexNet network licensing	25000-27000 (uses random port in this range)
ELAN network licensing	7841
Single instance of Microsoft SQL Server, including Express Edition	1433, but could be dynamic; see note below
Oracle SQL*Net Listener	1521
i-cut Production Console Output	80, 10003

Oracle notes

If you need to change the port number for the Oracle SQL*Net Listener, use the Net Configuration Assistant.

Microsoft SQL Server notes

Every time Microsoft SQL Server starts, including SQL Server Express Edition, it dynamically allocates an available network port for communication. This means that the port number could be different each time you restart the database server or your machine. To circumvent this problem of not knowing which port to open, if your system is using the built-in Windows Firewall with Advanced Security, you can create a program rule that will open whatever port the software uses. If your system uses a different firewall, contact your system administrator for assistance.

1. Log in as Administrator or as a user with administrative privileges.
2. Click **Start > Run**.
3. Type WF.msc and click **OK**.

4. In the left pane of the Windows Firewall with Advanced Security dialog box, select **Inbound Rules** and then click **New Rule** in the Actions pane.
5. In the Rule Type dialog box, select **Program** and click **Next**.
6. In the Program dialog box, select **This program path**, and then click **Browse**.
7. Navigate to the folder containing the Microsoft SQL Server executable. It will vary depending on your operating system and version of Microsoft SQL Server you are using. On a 64-bit Windows 2008 R2 server using the default Esko-supplied instance, for example, the path is C:\Program Files\Microsoft SQL Server\MSSQL11.ESKO\MSSQL\Binn.
8. Select sqlservr.exe and click **Open**. The complete path should appear in the field. Click **Next**.
9. In the Action dialog box, select **Allow the connection** and click **Next**.
10. In the Profile dialog box, leave everything selected and click **Next**.
11. In the Name dialog box, enter a name for this firewall rule (like SQL Server) and click **Finish**.
12. Click **File > Exit** to close the Windows Firewall with Advanced Security dialog box.

5. ArtiosCAD Enterprise Installation and Configuration

ArtiosCAD Enterprise installs and operates differently than ArtiosCAD Standard Edition because of its improved Project and document management framework. Those changes are contained in this chapter, and also in the *Using ArtiosCAD Enterprise* chapter later in this book.

If you are using ArtiosCAD Standard Edition, please skip this chapter.

Installing ArtiosCAD Enterprise

The list below is a general guide to the steps required to install ArtiosCAD Enterprise. They will be explained in greater detail in the following sections.

1. Install and configure WebCenter on its dedicated servers. Make sure to have access to theWebCenter and licensing documentation at <http://help.esko.com>, where you can also download the PDF versions for printing and offline use. **WebCenter** and **Licensing and Activation** are listed in the Products section.
2. Run the board importer batch file.
3. Create, migrate, or add to the ArtiosCAD Enterprise Defaults.
4. In WebCenter, do the following:
 - Configure companies and locations for the initial ArtiosCAD Enterprise users.
 - Create custom groups, if desired, for the initial ArtiosCAD Enterprise users.
 - Create the initial ArtiosCAD Enterprise users as Project Managers.
 - Invite new users to the Shared Defaults Project.
5. Install ArtiosCAD Enterprise on users' computers.
6. Start using ArtiosCAD Enterprise.

There are additional configuration tasks to do in WebCenter that will make ArtiosCAD Enterprise easier to use. They include:

- Assigning default boards to a location.
- Creating characteristics, attribute categories, attributes, and restricted sets.

Finally, once everything is configured and working, you can set up a third tier of Defaults called Location Defaults. They sit between Shared Defaults and User Defaults. Location Defaults are configured independently for each location, although you can create a Template on which to

base them. For more information about using Location Defaults, see the information starting in the Location Defaults Overview section later in this chapter.

Step 1 - Installing WebCenter

The first step of installing ArtiosCAD Enterprise is to install WebCenter.

Note: Have the *WebCenter Complete Documentation* manual handy for easy reference. It is available at <http://help.esko.com>.

Installing WebCenter for use with ArtiosCAD Enterprise varies from the procedure in the WebCenter manual in that there are a few more steps required.

Note:

We do not recommend using an Express version of Microsoft SQL Server if you will have more than a few users. If you plan on this, we recommend using a full version of Microsoft SQL Server or Oracle.

The list below is a general overview to installing WebCenter. Refer to the *WebCenter Complete Documentation* manual for specific instructions. In case of a conflict, the information in the steps below takes precedence over the steps in that manual.

1. Load the database server software (Microsoft SQL Server or Oracle) on the database server if it is not already present. If you will be using a centralized corporate database server instead of a dedicated WebCenter database server, you will either need to load database access and management tools on the Application server, or map a drive to the Application server from the database server, in order to run the database scripts batch file that builds the database schema.
2. If any users will be using the WebCenter Viewer to look at files, load the On-Board Graphics Engine. Note that this will require a separate Automation Engine OBGE Server network license to be loaded on the Application server. For more information, see the *WebCenter Complete Documentation* manual.
3. On the Application server, do the following steps as a member of the local Administrators group:
 - a) Load ArtiosCAD Enterprise that is on the same media as WebCenter as an Advanced installation. Do not load a different version.
 - b) Load the WebCenter Application server components. It is important to answer all questions correctly to avoid having to edit files later. You may receive a message about two installation programs running at the same time. Click **OK** if you see this message.
 - c) Run the database scripts batch file appropriate for the type of database software you installed. You need to have the database access and management tools for your database program loaded on the Application server, or you need to do this from the database server with a network drive mapped to the Application server.

If you are using Oracle, you **must** have write access to the folder containing the database schema batch file as the batch file creates XML files used to create the database schema. You may want to copy the entire DatabaseSchema folder to the database server and run it locally to ensure proper schema creation.

- d) Start the WebCenter services (WebCenter App-X Application Container, WebCenter JBOSS Application Server, WebCenter CAD-X Server, and WebCenter Search Crawler). You may want to set them to start automatically.
4. On the Web server, do the following steps as a member of the local Administrators group:
 - a) Make sure that Internet Information Services (IIS) is installed and working correctly. See the next section for more information.
 - b) Load the WebCenter Web server components. It is important to answer all questions correctly to avoid having to edit files later.
 - c) Start the WebCenter Tomcat service.
 - d) Log in to WebCenter and change the admin password.
5. On the Application server, start the WebCenter CAD-X Server service.

Installing IIS7 on the Web Server

Installing IIS7 on the Web server for use with WebCenter and ArtiosCAD Enterprise has three steps:

1. Installing the software.
2. Enabling 32-bit applications (only if the Web server is using a 64-bit operating system).
3. Extending the size limit for uploaded files.

Install IIS on the Web Server Machine

If IIS is not installed on your web server, you need to install it. The procedure below explains how to install IIS7 on Windows Server 2008 R2.

1. Start the server manager.
2. Click **Roles** in the left panel, then click **Add Roles** at right.

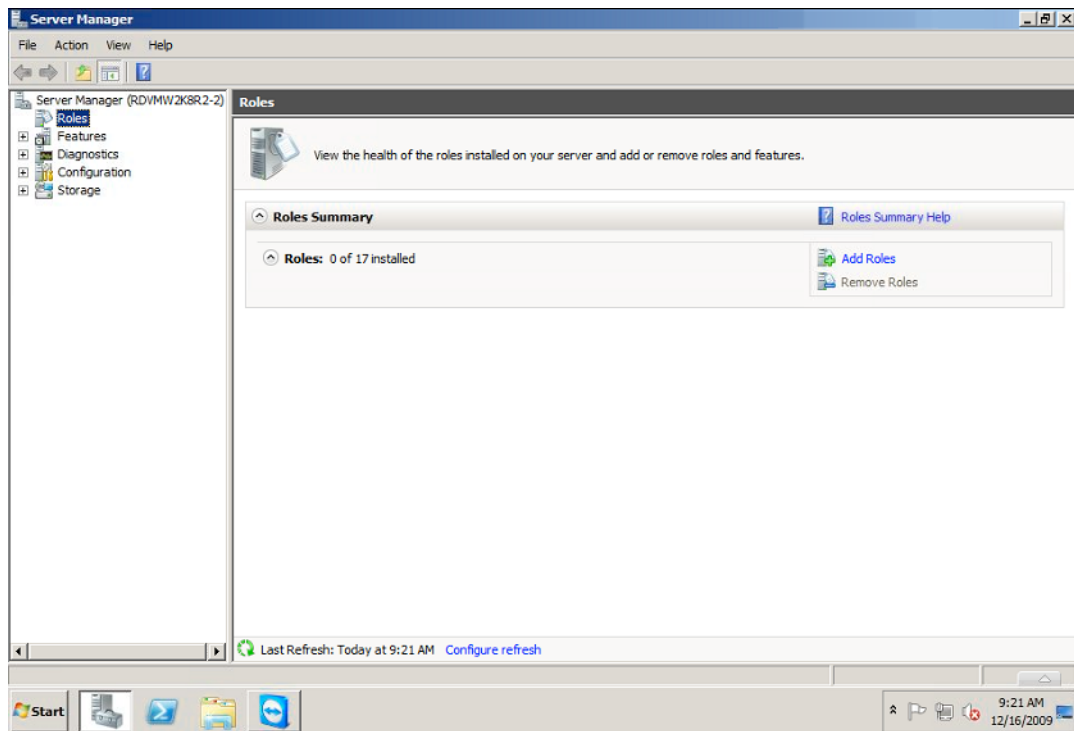

This opens the **Add Roles Wizard**.

3. In the **Select Server Roles** screen, select **Web Server (IIS)**.

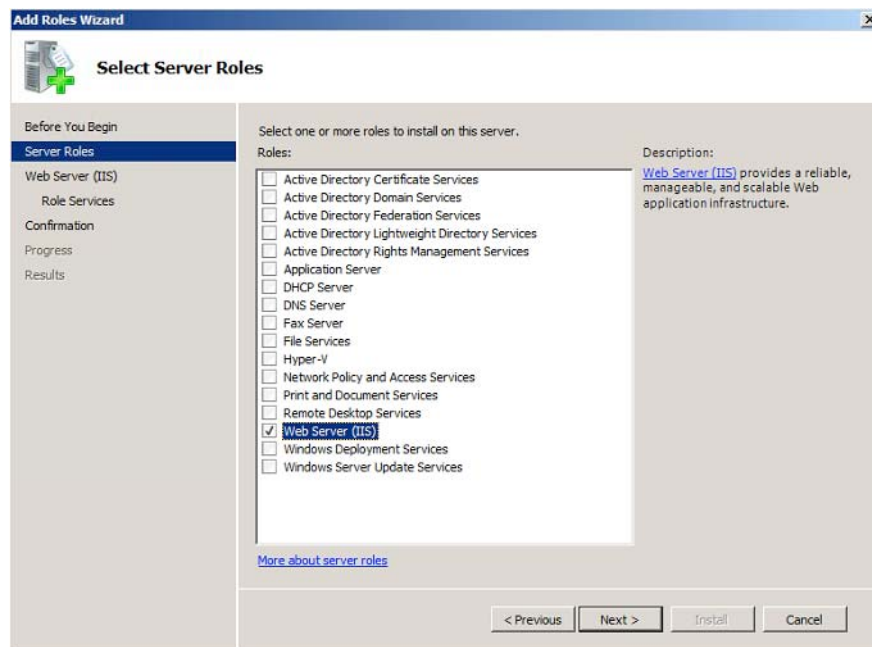

If the wizard prompts you to add features required for the web server, do so.



4. In the **Select Role Services** screen:

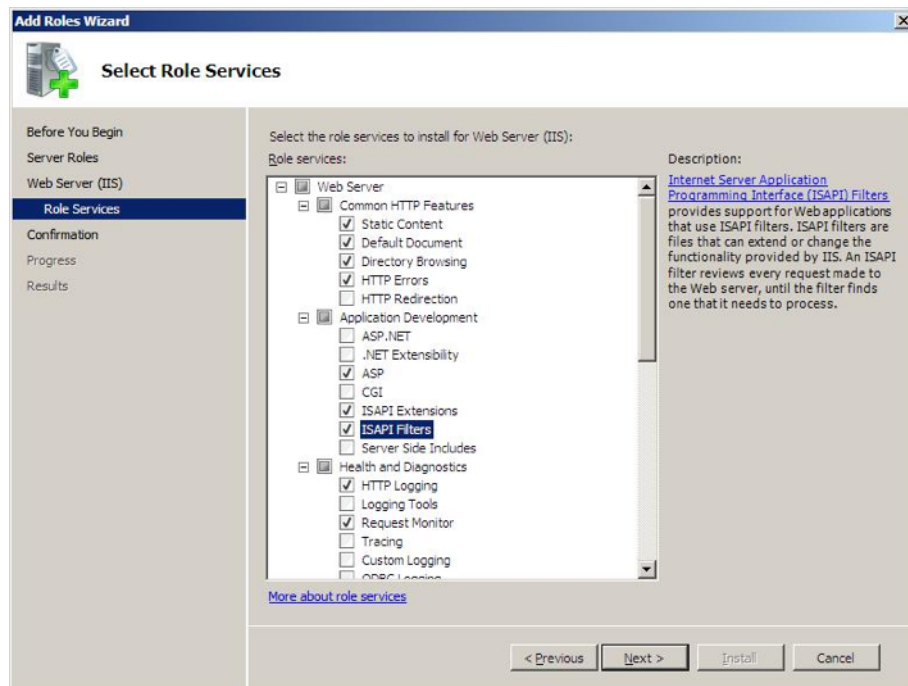

a) Select **ASP, ISAPI Extensions** and **ISAPI Filters**.

If the wizard prompts you to add role services required for ASP, do so.

b) Select **Logging Tools** and **Tracing**.

c) Select **IIS 6 Management Compatibility**.

5. In the **Confirm Installation Selections** screen, check the settings and click **Install**.

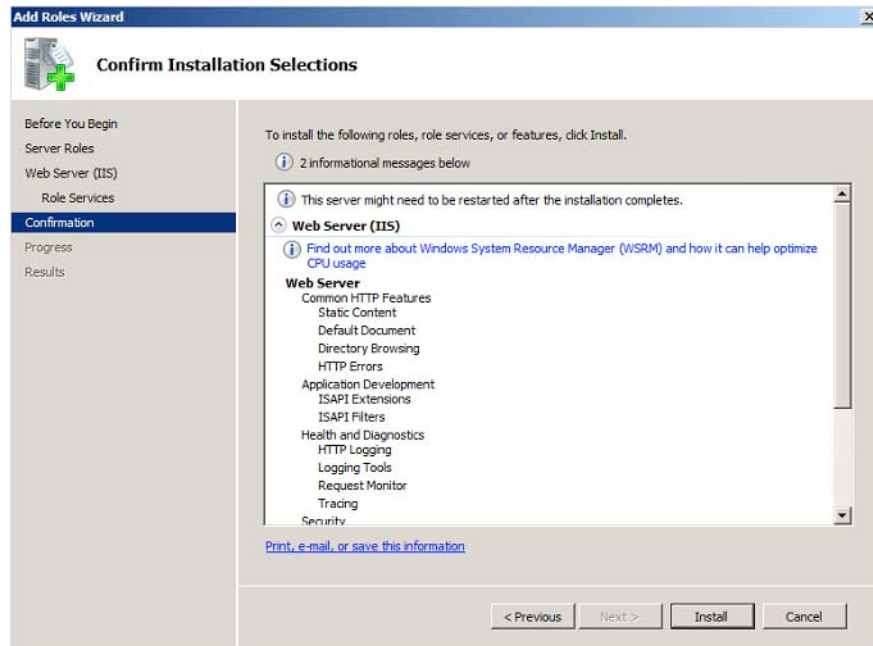

This installs the IIS 7 Role with the settings you have selected and the default settings. The **Installation Results** screen should show `Installation succeeded`.

Enable 32 Bit Applications

Note: Only do this if you have a 64 bit system!

1. In IIS, go to **Application Pools** and select the **DefaultAppPool**.
2. Click **Advanced Settings...**, then set the **Enable 32 Bit Applications** option to **True** and click **OK**.

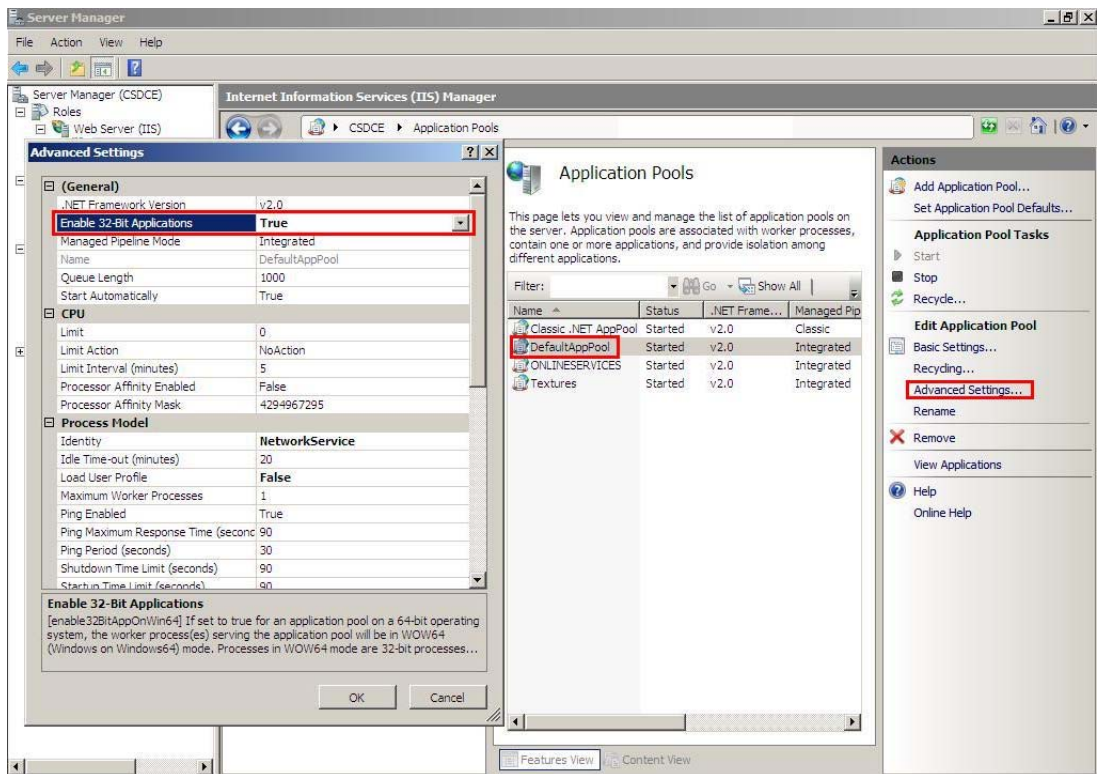

3. Click **Recycle...** at right.

Extend the Upload Limitation

IIS7 has a limitation on how much you can upload at once (30 MB). You can change it to 2GB by following these steps:

1. Open **IIS 7 SnapIn**.
 2. Select the website for which you want enable large file uploads.
 3. In the main window, double-click **Request filtering**.
 4. Once the window is opened you may see a list of tabs (file name extensions, rules, hidden segments...).
- Regardless of the tab you select, right-click in the main window and select **Edit Feature Settings**.
5. Modify the **Maximum allowed content length (bytes)**: change the value to 2000000000 (a 2 and 9 zeros) to be able to upload files close to 2GB.

Step 2 - Optionally Uploading Boards

In case the boards were not installed yet, follow this procedure after logging in to WebCenter for the first time:

1. Log in on the Web server as a member of the local Administrators group.
2. Run the setup program on the ArtiosCAD media.
3. Click **Upload Boards**.

4. In the Log In To Web Browser dialog box, enter the address of the WebCenter server, an admin user's username, and that user's password. Click **OK**.
5. An Upload Boards progress bar will appear.
6. Click **Close** when the upload finishes.

Step 3 - Creating Shared Defaults for the First Time

The next step is to run the ArtiosCAD Defaults Manager installed when you installed ArtiosCAD Enterprise on the Application server. The first time you install ArtiosCAD Enterprise 16 or later, you have to create the Shared Defaults. You can choose to either create completely new Shared Defaults, or you can choose to migrate older Defaults that are merged with the defaults for the version you are installing. In the future, you will add a new version's Defaults to the existing Shared Defaults Project.

You may also use this utility to migrate location and user defaults from older versions of ArtiosCAD to newer versions of ArtiosCAD.

Note:

Even if you do not plan to use WebCenter in combination with ArtiosCAD Enterprise, it is still necessary to install the Defaults in order for WebCenter to be able to process CAD files properly. Therefore, it is highly recommended to install the Defaults, even if you do not plan to use CAD files initially.

Note:

The system you use for loading the Defaults must be able to keep the Defaults on it. You will have to follow the same process to load future Defaults and the new installation will reference the older version's Defaults as part of its installation. We recommend using the Application Server for this process.

Note:

This procedure takes a significant amount of time. We recommend starting it and doing other things until it completes.

1. Log in to the Application Server as a member of the local Administrators group.
2. Click **Start > All Programs > Esko > ArtiosCAD > Defaults Management** to start the Defaults Manager.
3. In the Login to Web Browser dialog box, enter your WebCenter server URL, admin username, admin password, and click **OK**.
4. Click **Create new shared defaults**.
5. A progress bar appears. This step will take a few minutes.
6. Click **Close** when the installation process is done.

Upgrading from Pre-16 Shared Defaults

If you have a pre-ArtiosCAD16 version of ArtiosCAD on the server, either Standard Edition or Enterprise, in any language, you may migrate those defaults to create one new Shared Defaults Project for version 16 and later. You may choose only one language as the source

of the migrated Defaults. All future installations of ArtiosCAD Enterprise will share the same Shared Defaults Project regardless of language or version.

1. Log in to the Application Server as a member of the local Administrators group.
2. Click **Start > All Programs > Esko > ArtiosCAD > Defaults Management** to start the Defaults Manager.
3. In the Login to Web Browser dialog box, enter your WebCenter server URL, admin username, admin password, and click **OK**.
4. Click **Migrate pre-ArtiosCAD 16.0 shared defaults to new shared defaults**
5. In the Migrate Shared Defaults dialog box, choose the edition, version, and language from the drop-down list boxes to use as the source of the migrated defaults.
6. Click **Migrate Defaults**.
7. A progress bar appears. This step will take a few minutes.
8. Click **OK** in the Copy Projects Result dialog box.
9. Click **Close** to close the Defaults Manager dialog box, or choose another maintenance action.

Adding New Defaults to an Existing Shared Defaults Project

If you have previously created a Shared Defaults Project for version 16 or later, when you load a newer version of ArtiosCAD Enterprise, you need to add its Defaults to the existing Shared Defaults Project.

1. Log in to the Application Server as a member of the local Administrators group.
2. Click **Start > All Programs > Esko > ArtiosCAD > Defaults Management** to start the Defaults Manager.
3. In the Login to Web Browser dialog box, enter your WebCenter server URL, admin username, admin password, and click **OK**.
4. Click **Add new defaults to the shared defaults project**.
5. A progress bar appears. This step will take a few minutes.
6. Click **Close** when the installation process is done.

Migrating User or Location Defaults

Use the Defaults Manager tool to migrate multiple sets of location and/or user defaults between versions of ArtiosCAD Enterprise at once.

The tool works with one WebCenter server. It does not migrate Defaults between different ArtiosCAD Enterprise installations. To move Defaults between different ArtiosCAD Enterprise servers, you can export them as a ZIP archive on the source server, copy the archive to the destination server, and extract and upload them into a new correctly named Defaults Project.

To use the Defaults Manager tool, do the following:

1. Log in to the Application Server as a member of the local Administrators group.
2. Click **Start > All Programs > Esko > ArtiosCAD > Defaults Management** to start the Defaults Manager.
3. In the Login to Web Browser dialog box, enter your WebCenter server URL, admin username, admin password, and click **OK**.
4. In the Defaults Manager, click **Migrate user/location defaults**.

5. Choose the source version to migrate from in the Version drop-down list box.
 6. Choose the language for the source version from the Language drop-down list box.
 7. Check **Overwrite If Exists** if a Defaults Project by the same name already exists in the destination version.
 8. In the Location Defaults Found group, check the location Defaults to migrate.
 9. In the User Defaults Found group, check the user Defaults to migrate.
 10. Click **Migrate Defaults**. ArtiosCAD Enterprise migrates the Defaults preserving the membership and security information and displays a progress bar.
 11. ArtiosCAD Enterprise displays a results dialog box showing the number of copied Projects, skipped Projects, failed Projects, and total Projects. Click **OK**.
 12. Repeat the process for other versions if desired. If you are done, click **Close** to end the tool.
- The migrated Defaults are now available for use.

Step 4 - Creating a New Company and Location

The next step is to create an entry for your company and location that will contain the users.

1. Log in to WebCenter as admin or as a member of the ADMINS group.
2. Click **Admin > Companies > New Company**.
3. Enter the information about the new company. Fields with asterisks next to them are required to have information in them.
4. Click **Create**.

A status message saying the company was created successfully appears at the bottom of the page.

To add more locations to this company, click the successful status message to edit the company, and then click **Locations > New Location** and enter the pertinent information for the new location. Click **Add Location** and repeat as desired.

Step 5 - Creating a New Group

This step is optional.

Group membership is an important administration and security consideration. Only two groups, ADMINS and USERS, are created by default when you install WebCenter. For efficient classification of users, you may want to create different groups so that different users can easily have different Project permissions. On the other hand, you might find it easier for all users to belong to one group and to invite that one group to your Project templates. It all depends on if you want different groups of multiple users to have different abilities. To create a new group, do the following:

1. Click **Admin > Groups > New Group**.
2. Enter the name of the group.
3. Choose who will be able to see this group: **All Project Managers, Administrators Only, or Selected Project Managers**.
4. Click **Continue**.

5. In **Step 2: Select Group Members**, since you have not created any users yet, click **Continue**.
6. Is this new group visible to every Project Manager or only to Administrators:
 - If yes, click **Finish**. The group is created.
 - If no, click **Continue**. Then, in **Step 3: Assign group visibility to project manager(s)**, select the Project Managers who can see this group and click **Finish**.

Project Managers with Full Visibility is unavailable, as they can see all groups. By default, group members can see the group but you can still de-select the group members so that they don't know this group exists.

Step 6 - Creating New Users

The next step is to create users who will use ArtiosCAD Enterprise. Refer to the WebCenter documentation for more information.

1. Click **Admin > Users > New User**.

Step 1: User Info in the **Create New User** wizard appears.

2. Type the basic user information into the appropriate fields (**Username, First Name, Last Name, ...**).

Note: Required fields are indicated with an asterisk *.

3. Do you want to use LDAP authentication (single sign-on) for this user?
 - If yes, enable the **Use LDAP to Authenticate User** option. This will allow the user to use his regular Windows network user name and password to log on to WebCenter. Using LDAP requires additional configuration in WebCenter. Please see the WebCenter documentation for more information.
 - If no, provide the user's initial **Password** and confirm it.

For ArtiosCAD Enterprise users, do not enable **Require user to change the password at first login**.

4. Does the user need guaranteed access by means of a reserved license?
 - If yes, enable the option **User Has Guaranteed Access**.
 - If no, leave the option disabled and proceed to the next step.

For more information on guaranteed access and its licensing implications, refer to the WebCenter documentation.

5. Does the user need special permissions in WebCenter? All ArtiosCAD Enterprise users should be at least **Project Managers with Limited Visibility of Companies and Groups**. If they are not, the administrator will need to do additional configuration work described at the end of this procedure.

If the user needs...	Select the option...
no special permissions and will not create Projects	Normal User

If the user needs...	Select the option...
Project Manager permissions, but only for Projects and users belonging to his or her own company	Project Manager with Limited Visibility of Companies and Groups.
Project Manager permissions on the complete system	Project Manager with Full Visibility

6. Does the user need the ability to create new task types in WebCenter? ArtiosCAD Enterprise users do not need to create task types.
 - If yes, enable the option **User Can Create Task Type**.
 - If no, proceed to the next step.
7. To grant this user the ability to create other users without being a member of the ADMINS group, enable the option **User Can Create User** checkbox.
8. In **Step 2: Assign to a Company**, select a company and location to which you want to assign the user. Note that this can be very important to filter the content, users, and Location Defaults the new user will be able to see.
9. If you:
 - are creating a **Normal User** or a **Project Manager with Full Visibility**, the wizard is complete. Click **Finish** to create the user.
 - are creating a **Project Manager with Limited Visibility**, click **Continue** and proceed to the next step.

10. In **Step 3: Assign Visible Companies**, select the companies that this user should be able to see, then click **Continue**.

The selection you make here filters the list of users in the next step so that this Project Manager can never see users from the companies you did not select in this step. By default, only the company of the Project Manager himself (the one you selected in the previous step) will be selected.

11. In **Step 4: Assign Visible Groups**, select the groups the user should be able to see, then click **Finish**.

Only groups containing members that belong to one of the companies you assigned in the previous step will show up in the list. In addition, some groups may be set to be visible to all users (such as the ADMINS group).

A status message saying the user was created will appear. Stay on this page for the next step.

If a new user is not made a Project Manager, the user will not be able to use User Defaults unless the administrator does the following:

- Creates a Project for this user named ACadDefaults_username (where username is the user's WebCenter username).
- Invites the user to the Project.
- Uploads clientdflt.zip to the Project.
- Grants the user View and Download permissions at the Project level. The user will not be able to change the User Defaults with this level of permissions.
- If the user needs to change the User Defaults, he or she must have Full permission at the Project level.

- Adds the user to the appropriate Location Defaults Project with at least View and Download permissions. If the user needs to change the Location Defaults, he or she must have Full permission at the Project level.

Step 7 - Setting a New User's Group Membership

Once you have created a new user, the next step is to assign that user to one or more groups. Even if you did not create any custom groups, you should assign a new user to the USERS group.

1. While still on the **Create New User** page with the successful creation status message, Click **Add user to group(s)**.
2. In the **Available Groups** column, click each group to which you will add this new user. To select more than one group, hold down CTRL while clicking groups.
3. Click >> to assign the selected available groups to the user.

The user is added to the group(s) immediately.

Step 8 - Inviting New Users to the Shared Defaults Project

The next step is to invite new users to the Shared Defaults Project, which is Shared Defaults in ArtiosCAD Enterprise. You can do this either individually for every user or once through Group membership if you added all users to the same group (such as USERS). Inviting them to the Project means that they will be able to use the Defaults. In order for users to change Shared Defaults, they must have Full permissions on the Project and be members of the ADMINIS group.

Note:

All ArtiosCAD Enterprise users **must** be invited to the Shared Defaults Project. Users who are not invited to the project will receive a UFANEX error when they launch ArtiosCAD Enterprise.

1. Click **Admin > Project Management > Projects**.
2. Click the name of the **ACadDefaults_Shared** Project to which you are inviting the user.
3. Click **Members** on the Project menu.
4. Click **Add members**.
5. In **Add Project Members Step 1 of 2**, check the checkboxes next to those users and groups to add to the Project.
6. Click **Continue**.
7. In **Add Project Members Step 2 of 2**, assign at least Download permission for the Project and each folder in it. Invitees to Projects get View permission assigned automatically.
8. Click **Finish**.

The new invitees should now be able to log into ArtiosCAD Enterprise and start using it.

Step 9 - Installing ArtiosCAD Enterprise on a User's Computer

To install ArtiosCAD Enterprise on a user's computer, do the following:

1. Log in as Administrator or as a user with administrative privileges.
2. Ensure that this system meets the minimum system requirements as published on Esko's website (search for system requirements).
3. Put the ArtiosCAD Enterprise media into the computer's media drive. It should automatically launch the Setup program. If your drive is set to not AutoPlay, start Windows Explorer and double-click **setup.exe** in the root directory of the media.
4. If you have User Account Control enabled, allow setup.exe to run.
5. Choose the language in which to run the setup program and install ArtiosCAD in using the **Change Language** drop-down. It should automatically match the language of your system but you may change it if desired. The setup program language will change to the language you selected.
6. In the ArtiosCAD Setup dialog box, click **Install ArtiosCAD Enterprise N.nn**, where *N.nn* is the version number.

The installer will launch and a few messages may display.

7. In the Welcome to the InstallShield Wizard for ArtiosCAD Enterprise N.nn dialog box, click **Next**.
8. Read the Software License Agreement in its entirety and choose **I accept the terms of the license agreement** if you accept all the terms of the License Agreement. Click **Next**.
9. Choose a **Typical** installation and click **Next** to use the most common configuration; skip to step 14.
10. If you want to keep previous versions of the software or choose features to install, choose **Advanced** and click **Next**.
11. In the Feature Selection dialog box, choose the features to install on the current machine. For each feature, click the icon in the drop-down list box next to it and choose the appropriate choice. Do not click **Next** when done, but rather proceed to the next numbered step.
 - a) **Esko ArtiosCAD Licensing** controls whether this machine is a license server or not. For ArtiosCAD Enterprise, the WebCenter Application server should be the licensing server, so this choice should be set to **This feature will not be available**.
 - b) **Esko ArtiosCAD Programs** are the program files needed to run ArtiosCAD Enterprise. You must install these if you want to run ArtiosCAD Enterprise on the current machine. You must leave this choice selected to install ArtiosCAD itself.
 - c) Contained within this group are optional components of ArtiosCAD Enterprise that require purchasing licenses for the corresponding module: **ArtiosCAD 3D Data Exchange**. Refer to the printed license report that came with the media to determine which component(s) to select. Installing software components without having the corresponding licenses wastes disc space, but hinders operation if you purchase a license in the future. Not installing the software components but having the licenses for them results in features that do not function within ArtiosCAD.

- d) **Esko Configuration Manager** collects data from systems running the Esko Station Information Service and sends the collected data to Esko automatically for use by Support personnel. **It sends information only if you configure it to do so and leave it enabled.** It is a great aid to Support personnel as they will have required information about your hardware and licenses available should you need to call for assistance. Only one system per site should have the Esko Configuration Manager installed.
- 12.** While still in the Feature Selection dialog box, with one of the components to be installed selected, review the folder in which ArtiosCAD Enterprise will be installed, and click **Change** if desired. In the resulting Change Current Destination Folder dialog box, change the drive if desired, and click **OK** to return to the Feature Selection dialog box. ArtiosCAD should always be installed to the **\Esko\Artios** folder on a local drive. Click **Next**.
- 13.** If you selected an Advanced installation:
- In the Advanced Options dialog box, **Keep Previous Versions** is the default for previous version handling. It means that ArtiosCAD is installed using a version-specific folder and icon which match the version and language of the installation, and all previous versions of ArtiosCAD are kept. To change this setting, click **Change**. In the Previous Version Handling dialog box, **Overwrite previous versions** simply uses ArtiosCAD as the icon name and ArtiosCAD as the directory with no version number. It overwrites the prior version of ArtiosCAD if this is an upgrade and the previous version was installed to a non-version-specific directory. Once you have chosen the option to use, click **OK** to return to the Advanced Options dialog box.
 - In the User Files Folder dialog box, click **Change** to change the location for unmanaged user files from the location shown. Enter the new location and click **OK**.
 - Click **Next** to continue.
- 14.** If you selected a Typical installation, in the Destination Folder dialog box, choose the folder where you will install ArtiosCAD Enterprise on this user's computer. Click **Change** to change the folder and click **OK** when you have selected the new location. Click **Next**.
- 15.** In the Ready to Install the Program dialog box, review the settings for correctness. If the settings are incorrect, click **Back** and fix them. If they are correct, click **Install**.
- 16.** If this system has other Esko products on it, you may be prompted to stop their license services. Click **Yes** to proceed with the installation.
- 17.** In the InstallShield Wizard Completed dialog box, click **Finish**. If for some reason you are using only a local license, click **Activate Local Licenses** instead and follow the instructions on the screen.
- If you are prompted to reboot the system, click **Yes**. **It is very important that you reboot the system if prompted.**

For this user to use ArtiosCAD Enterprise, you should have already followed the major installation steps of creating new users, assigning them to groups, and inviting them to the Shared Defaults Project. If not, perform them now. Once done, the user should be ready to use ArtiosCAD Enterprise. Repeat for other users as needed.

You will enter the licensing information for ArtiosCAD the first time you start it.

Post-Installation Configuration Tasks

There are two post-installation configuration tasks you should do in WebCenter that make ArtiosCAD Enterprise more useful in terms of proper categorization of Project information:

- Assign default boards to a location.
- Create characteristics, attribute categories, attributes, and restricted sets.

Assigning Default Boards to a Location

When users create a design, they have to assign a board to it. Boards that are assigned to their location are shown by default. If no boards are assigned to their location, every time they create a design, they have to click **Show All Boards** to view the actual boards in their folders; otherwise, ArtiosCAD Enterprise shows a list of empty folders.

To assign default boards to a location, do the following:

1. Log in to WebCenter as a member of the ADMINS group.
2. Click **Admin > CAD > Boards**.
3. Expand the board tree by clicking the plus signs (+) in front of the categories.
4. To assign a particular board to a location, do the following:
 - a) Click its name.
 - b) Check the checkbox to the left of the location to which you are assigning the board. You may check more than one checkbox to assign the board to multiple locations.
 - c) Click **Finish**.
 - d) Click **Boards** to return to the Board tree.

Characteristics

Characteristics are descriptive tags that can be assigned to Projects and documents to make them easier to find.

Characteristics are hierarchical. This means there can be different levels of characteristics for various product lines so that you can drill down through the information to find the exact characteristic desired when searching the database.

For example, you could create a master characteristic for Electronics, and then various sub-characteristics for types of appliances, entertainment equipment, or computers, and so forth. They are presented in a tree format - main categories with expandable branches. The characteristics tree configures the available characteristic names as well as how they are organized.

Create a Characteristic

1. Click **Admin > Characteristics**.
2. Do you want to add a primary characteristic (a main category) or a secondary characteristic?
 - To add a primary characteristic, select the option button next to **Root** at the top of the tree and then click **New Characteristic**.
 - To add a secondary characteristic, select the option button for the characteristic under which to add the new one, and then click **New Characteristic**.

There can be up to 17 levels of characteristics or at most 256 characters for the entire characteristics path from the root characteristic to the deepest-level characteristic.

3. Enter the name of the characteristic in the **Name** field.
4. Click **Create**. The new characteristic appears in the list.

Edit or Delete a Characteristic

When deleting a characteristic, WebCenter checks if the characteristic or any of its child characteristics are assigned to any Projects or documents. If such a dependency is found, you are prompted to remove the dependency and delete anyway, or cancel the deletion.

1. Click **Admin > Characteristics**.
2. Do one of the following:
 - To edit a characteristic, click its name in the tree structure. Type a new name in the **Edit Characteristic** page and click **Save** to confirm.
 - To delete a characteristic, select it in the tree and click the **Delete Characteristic** link.

If there are no dependencies, it is deleted immediately. Note that any sub-characteristics of the selected characteristic will also be deleted.

Project and Document Attributes

Basic concepts

Attributes are a way to assign user-configurable fields and their values to documents and Projects. They can be restricted to a group of preset values (as **Restricted Sets**), or can be prompted so that the user has to set a value each time they are used. The Restricted Sets must exist before you can use them when creating an Attribute.

Attribute Categories group Attributes together for convenience. An Attribute must be put into an Attribute Category before it can be used; however, the same Attribute can be in multiple categories. You must create an Attribute Category before adding Attributes to it. In ArtiosCAD Enterprise, you can define default Attribute Categories for each type of native design document that are applied to documents as you create them.

Suggested workflow

A suggested workflow is to:

Step	Action
1	Create Attribute Categories.
2	Create Restricted Sets (if required).
3	Create the Attributes.
4	Assign Restricted Sets to Attributes (if required).
5	Add the Attributes to the Attribute Categories.
6	Assign default Attribute Categories to design document types in Defaults in ArtiosCAD Enterprise.

Create an Attribute Category

1. Click **Admin > Attributes > Attribute Categories > New Category**.

2. Enter the name of the Attribute Category to create, such as Shipping Instructions.
3. Click **Create**.

Edit or Delete an Attribute Category

WebCenter checks if an Attribute Category is being used before deleting it. If it is in use, you will be prompted to either clear the category from the Projects or documents using it and delete the category, or to cancel the deletion.

1. Click **Admin > Attributes > Attribute Categories**.
2. Do one of the following:
 - To edit an attribute category, click its name. Type a new name in the **Edit Category** page and click **Save** to confirm.
 - To add attributes to a category or remove them from it, click its name. Then use the chevron (<< or >>) buttons to move them between the **Available Attributes** and **Current Attributes** columns.

Note: Moving Attributes between columns takes effect immediately.

- To delete an attribute category, select it, move the mouse over the menu symbol and click **Delete Category** on the hover menu.

If there are no dependencies, it is deleted immediately. Note that any sub-attributes of the selected attribute will also be deleted.

Create a Restricted Set

1. Click **Admin > Attributes > Restricted Sets**.
2. Enter information in the fields as appropriate:
 - **Name.** The name of the Restricted Set, up to 35 characters.
 - **Type.** The data type of the Restricted Set. There are six allowed types: Area, Distance, Float, Integer, Text, Volume, and Weight. A float is a number containing a decimal point and an integer is a whole number. The labels in parentheses after the name of the type indicate the units of measurement used in Imperial and metric systems.
 - **Value.** An entry for the restricted set. Text values can be up to 255 characters long. Click **Add** to add the value to the set and clear the Value field. Enter as many values as desired, clicking **Add** after each one.
3. Click **Create** to create the Restricted Set.

Edit a Restricted Set

1. Click **Admin > Attributes > Restricted Sets**.
2. Either filter or click **Go** to show the Restricted Sets.
3. Click the name of the Restricted Set to edit.
4. Change the name, or add and remove values as desired. You cannot change the type. If you remove a value, the next time you access a Project using the deleted value, you will be prompted to change it.
5. Click **Change** to make the changes.

Delete a Restricted Set

WebCenter checks if a Restricted Set is being used before deleting it. If it is in use, you will be prompted to either clear the Restricted Set from the Attribute using it, or to cancel the deletion.

1. Click **Admin > Attributes > Restricted Sets**.
2. Either filter or click **Go** to show the Restricted Sets.
3. Select the checkbox of the Restricted Set to delete.
4. Hover over the menu symbol and click **Delete Restricted Set(s)** from the hover menu.
5. Click **OK** when asked to confirm the deletion.
6. If there are no dependencies, it is deleted immediately. If there are any dependencies, choose the desired option and click **OK**.

Create an Attribute

1. Click **Admin > Attributes > New Attribute**.
2. Enter information in the fields as appropriate:

In the field...	Fill in the...
Name	name of the attribute (for example, Billable)
Description	description of the attribute contents (for example, Indicates whether work on this project should be billed by finance)
Type	data type of the attribute. Floats are numbers containing a decimal point (3.1415) and integers are whole numbers (42).
Values	choose Prompted if you want to allow the user to enter any value, Calculated to enter an ArtiosCAD formula for calculating the value of the Attribute when ArtiosCAD opens the document containing the Attribute (the values are read-only in WebCenter), or select a Restricted Set to limit the possible values. To choose a Restricted Set, it must be created before defining the Attribute. Make sure that the type of the Restricted Set is the same as the Attribute type.

3. Click **Create**.

Edit or Delete an Attribute

When deleting an attribute, WebCenter checks if the attribute or any of its child attributes are assigned to any Projects. If such a dependency is found, you are prompted to remove the dependency and delete anyway, or cancel the deletion.

1. Click **Admin > Attributes**.
2. Do one of the following:
 - To edit an attribute, click its name. Type a new name in the **Edit Attribute** page and click **Save** to confirm.

You cannot change the attribute type.

- To delete one or more attributes, select the corresponding checkboxes, hover over the menu symbol and click **Delete Attribute(s)** on the hover menu.
If there are no dependencies, it is deleted immediately.

Assigning Default Attribute Categories to Document Types

ArtiosCAD Enterprise comes with five empty Attribute Categories: **DEFAULT A3D CATEGORY**, **DEFAULT DESIGN CATEGORY**, **DEFAULT MANUFACTURING CATEGORY**, **DEFAULT CANVAS CATEGORY**, and **CANVAS PARTS**. Create and add Attributes to these categories as described previously, or create your own Attribute Categories as desired. Once you have the Attributes Categories populated as desired, do the following to assign default Attribute Categories to document types:

1. Launch ArtiosCAD Enterprise and log in as a member of the ADMINS group.
2. Click **Options > Defaults**.
3. Expand the **Database Defaults** catalog by clicking the plus sign (+) next to it.
4. Double-click **Default Attribute Categories**.

The Default Attributes Categories dialog box appears.

5. Select the desired categories from the drop-down list boxes and click **OK**.

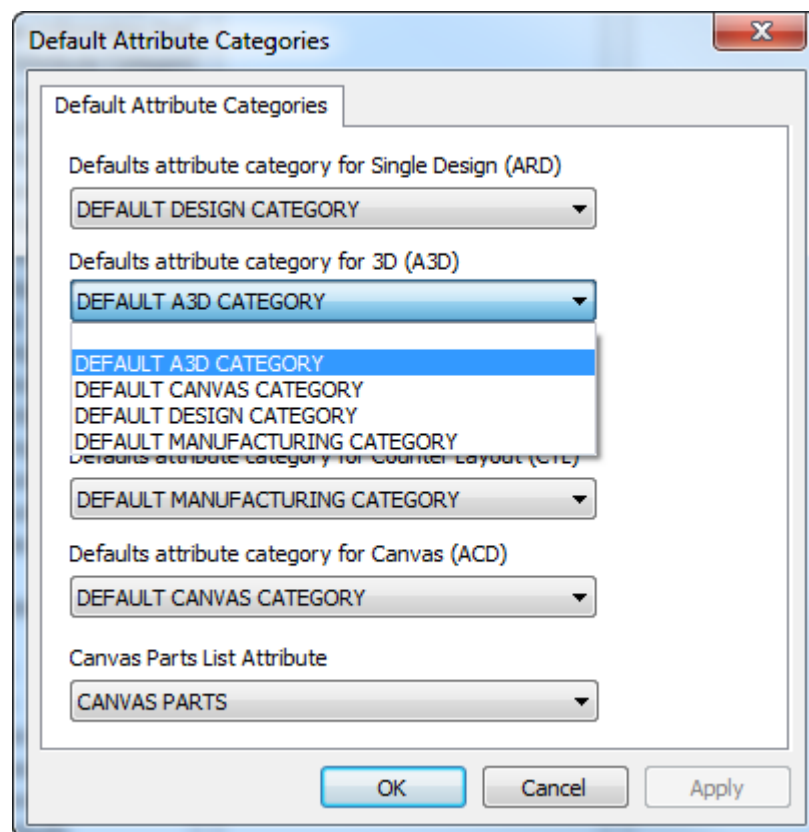

6. Save and exit Defaults.

If you have added Attributes to the default categories but the drop-down list boxes are empty, or if you do not see the Attribute Categories you recently created, exit Defaults and use the Cache Manager to update the Attributes table.

Configuring ArtiosCAD Enterprise

ArtiosCAD Enterprise gets its board information from the database. The Board and Flute browsers let you manage paper boards, plastic boards, and foams.

Outputs in ArtiosCAD Enterprise may have their output directed to a Project in addition to a device or a file.

Using the Flute Browser

Use the Flute browser to create and edit flutes, which are the wavy papers glued between liners to form corrugated board. ArtiosCAD Enterprise comes with several predefined flutes.

Opening the Flute Browser

To open the Flute browser, do the following:

1. Launch ArtiosCAD Enterprise and log in as a member of the ADMINS group.
2. Click **Database > Manage Boards > Flute browser**.



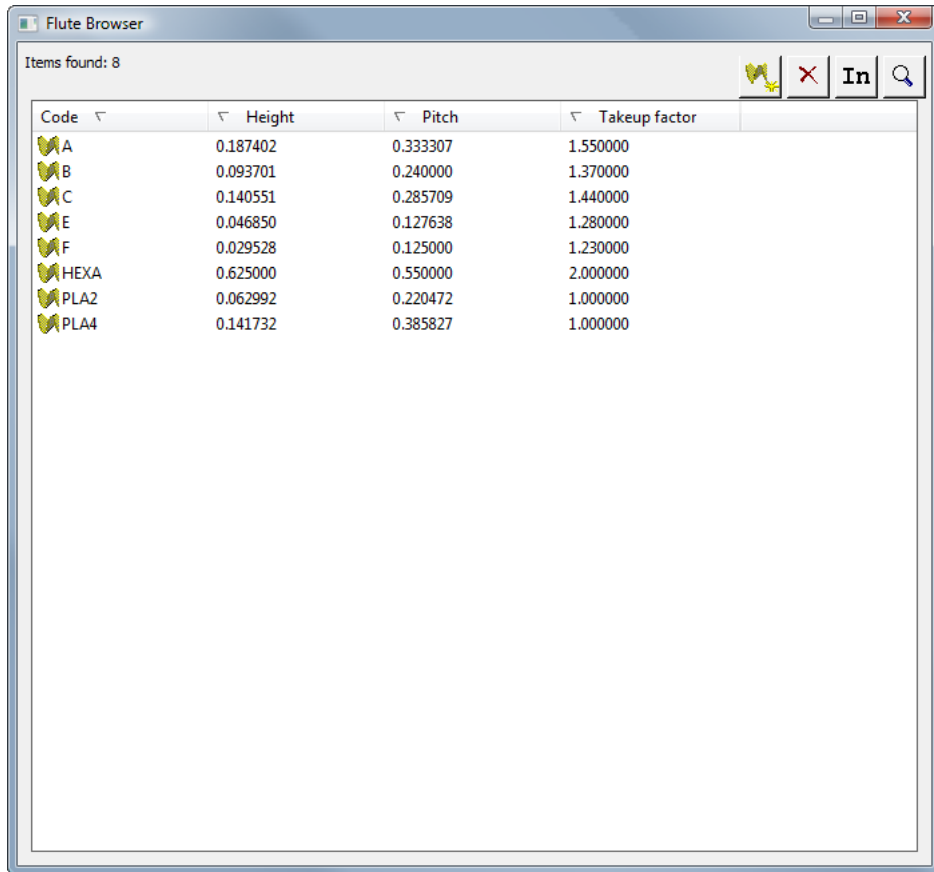

The Flute browser opens.



The Flute Browser Toolbar

Shown below is the Flute browser toolbar.

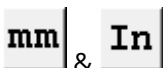

Button	Action
	Inserts a new flute.
	Deletes the selected flute.
	Toggles units between metric and Imperial.
	Toggles display of the Details pane.

Working with Flutes

Viewing Flute Details

To view details about a flute:

You can... Double-click the flute to select it and open the Details pane.

You can...



Click the **Details** pane toggle on the toolbar and then select the flute.

The Flute browser will then look like this:

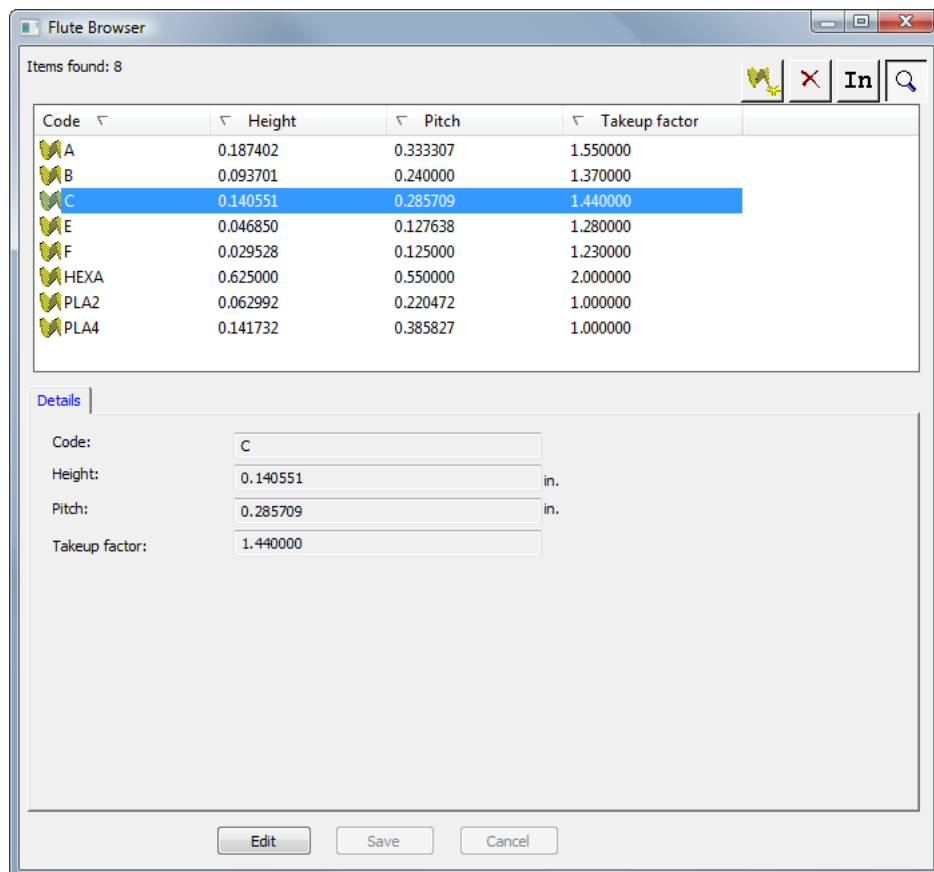

If the Details pane is already open, simply select a flute to see its details.

Editing a Flute

To edit a flute, do the following:

1. Launch ArtiosCAD Enterprise and log in as a member of the ADMINS group.
2. Click **Database > Manage Boards > Flute browser** to open the flute browser.

3. Select a flute and view its details.
4. Click **Edit**.
5. Change the values as desired.
6. Click **Save**.

Adding a Flute

A flute is defined by four pieces of information:

- A unique code to identify the flute. This code must be four characters or shorter.
- The flute pitch, which is the horizontal distance between the lowest parts of the wave. The pitch must be greater than 0.
- The flute height. The height must be greater than 0.
- The take-up factor, which is the ratio between the length of the fluted paper and the length of the board. If the flute were stretched out, it would always be longer than the paper encasing it. The take-up factor must be greater than 1.

To add a flute, do the following:

1. Launch ArtiosCAD Enterprise and log in as a member of the ADMINS group.
2. Click **Database > Manage Boards > Flute browser** to open the flute browser.
3. Click **Insert** on the toolbar.
4. In the **Details** pane, enter the code, the height, the pitch, and the take-up factor in the appropriate fields.
5. Click **Insert**.

The new flute will appear in the list.

Deleting a Flute

To delete a flute, do the following:

1. Launch ArtiosCAD Enterprise and log in as a member of the ADMINS group.
2. Click **Database > Manage Boards > Flute browser** to open the flute browser.
3. Select the desired flute.
4. Click **Delete** on the toolbar.
5. Click **Yes** to confirm the deletion.

The deleted flute is removed from the list.

Using the Board Browser

Use the Board browser to maintain the corrugated boards, folding carton boards, papers, and foams used in ArtiosCAD Enterprise.

Opening the Board Browser

To open the Board browser, do the following:

1. Launch ArtiosCAD Enterprise and log in as a member of the ADMINS group.
2. Click **Database > Manage Boards > Board browser**.

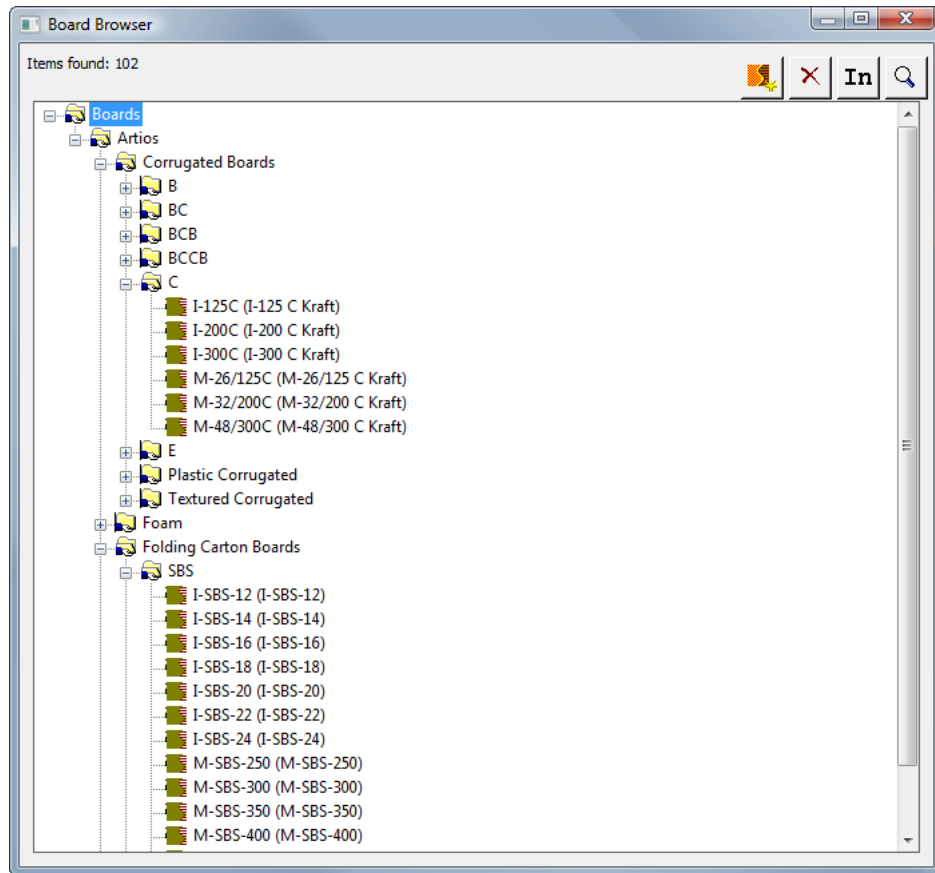

The Board browser opens with all the catalogs closed. Click the plus sign next to each folder to open it. Some folders are opened in the following example.



The Board Browser Toolbar

Shown below is the Board browser toolbar.

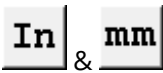

Button	Action
	Inserts a new board.
	Deletes the selected board.
	Toggles units between metric and imperial.

Button	Action
	Toggles display of the Details pane.

Working with Boards

Viewing Board Details

To view details about a board:

You can... Double-click the board to select it and open the Details pane.

You can...  Click the **Details** pane toggle on the toolbar and then select the board.

The Board browser will then look like this:

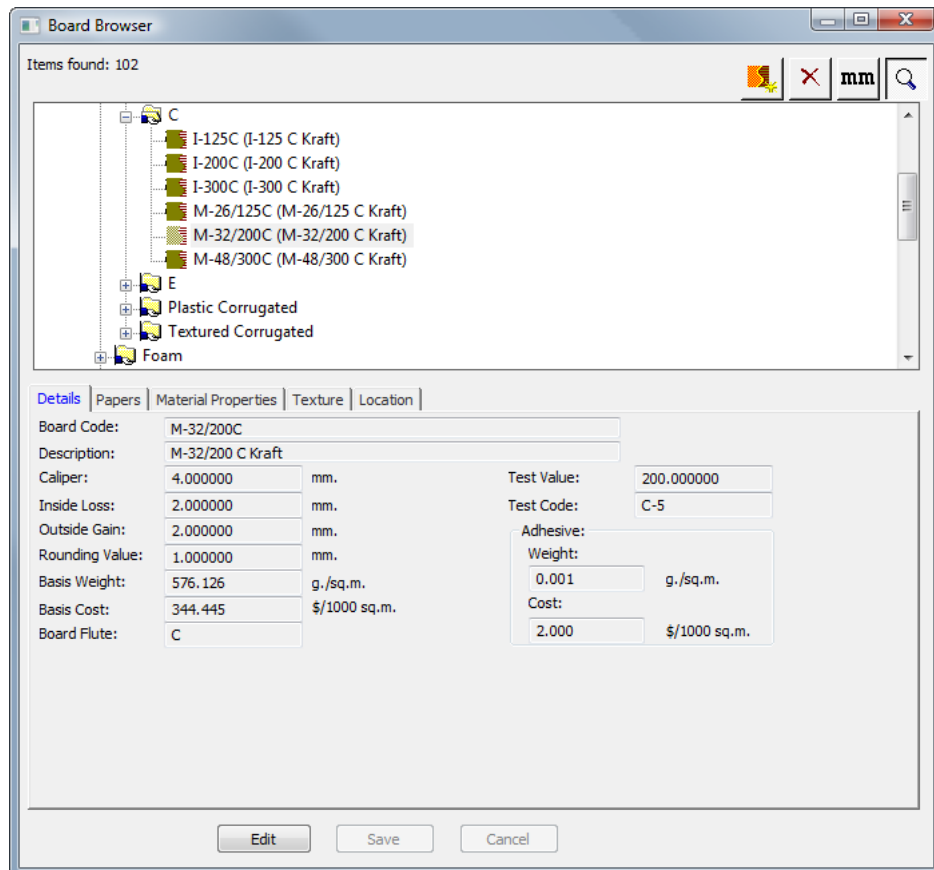

If the Details pane is already open, simply select a board to view its Details.

Editing a Board

To edit a board, do the following:

1. Launch ArtiosCAD Enterprise and log in as a member of the ADMINS group.
2. Click **Database > Manage Boards > Board browser** to open the board browser.
3. Select a board and view its details.
4. Click **Edit**.
5. Change the values as desired.
6. Click **Save**.

Creating a paper

Papers are the building blocks of boards so you must create them before you can create boards.

To create a new paper, first examine an existing paper to determine what information you will need to define the new paper. Papers are in their own folder in the Board browser. Usually the caliper, inside loss, outside gain, rounding value, basis weight, and basis cost are needed. You may also set inside and outside colors and other appearance attributes to the paper that appear in the optional 3D module.

To create a new paper, do the following:

1. Launch ArtiosCAD Enterprise and log in as a member of the ADMINS group.
2. Click **Database > Manage Boards > Board browser** to open the board browser.
3. Open the **Artios** folder by clicking the plus sign next to it.
4. Click the word **Papers** to select it.
5. Click **Insert** on the toolbar.

The Details pane will automatically appear with the fields enabled for editing.

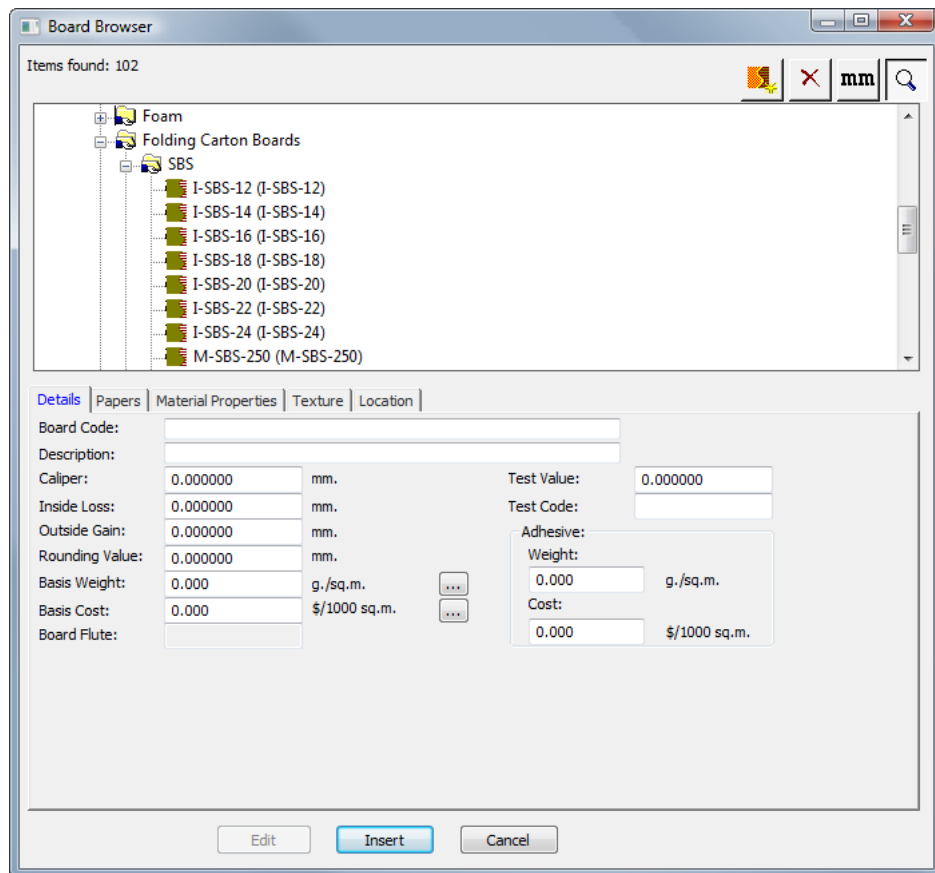

6. Enter values in the fields on the Details tab as appropriate.
 - a) **Board Code** is the identifier used by the database to identify this new paper; each paper must have a unique code.
 - b) **Description** is the description of the paper.
 - c) **Caliper** is the thickness of the paper.
 - d) **Inside Loss** and **Outside Gain** are the allowances used when folding the paper or when gluing it together (such as in a glue flap). They are generally half the caliper.
 - e) **Rounding Value** sets a value to which dimensions may be set to round to when constructing a corrugated design. It is more relevant for boards as a whole rather than individual papers.
 - f) **Basis Weight** is the weight of the paper in local currency and units of measurement.
 - g) **Basis Cost** is the cost of the paper in local currency and units of measurement.
 - h) **Test Value** is the amount of weight needed to break the material when performing very specific standardized tests. It is more relevant for corrugated boards as a whole than individual papers.
 - i) **Test Code** is the identifier used in correlation with the Test Value to show the strength of the paper. It is more relevant for corrugated boards than individual papers.
 - j) **Weight** and **Cost** in the **Adhesive** group should be set for the complete board definition, not individual paper and flute definitions.
7. Leave the fields on the Papers tab blank, as they are not relevant.
8. On the Material Properties tab are fields to set the shininess, transparency, and inside and outside colors of the paper. These properties are only visible in the optional 3D module.

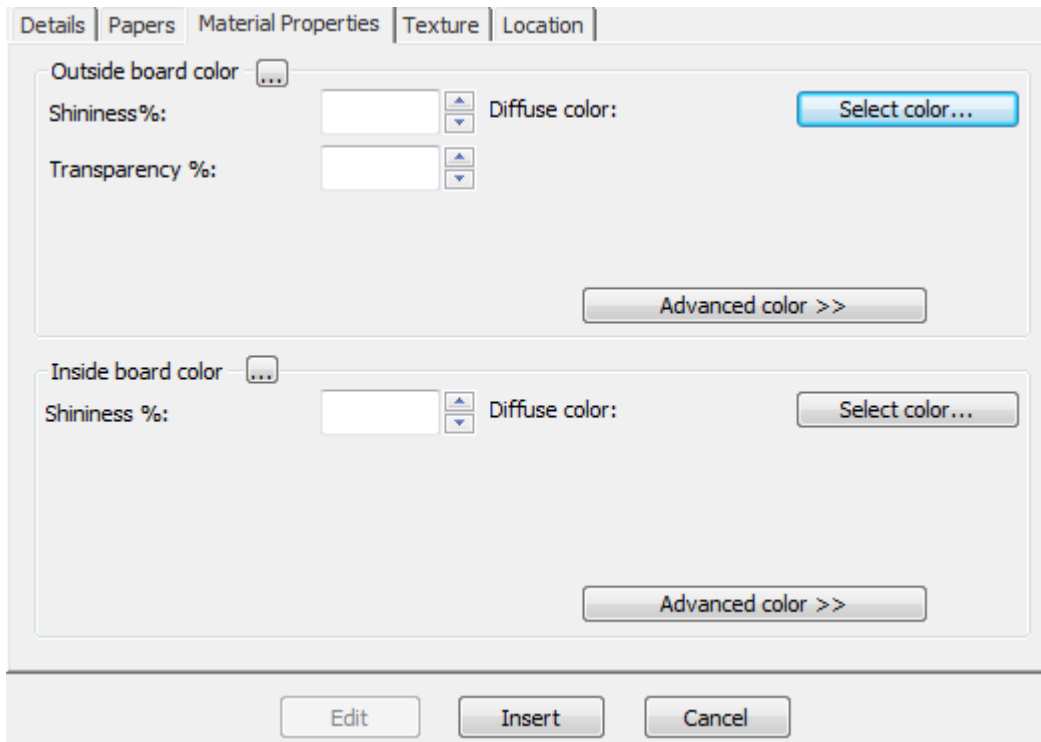

- a) Set the **Shininess%** and **Transparency%** fields as desired. The **Transparency%** field is a separate setting from transparency mode in 3D and is not affected by that setting.
 - b) Surface colors for papers are split into three components: **ambient** color, which reflects the ambient light; **diffuse** color, which reflects the movable lights in an airy, non-shiny way; and **specular** color, which reflects movable lights for a shiny surface, with a shiny surface having a white specular color and a dull surface a black specular color.
 - c) By default, the Material Properties tab only displays Diffuse color in Simple color mode. In Simple color mode, choose a color by clicking **Select color**. To set the other two colors, click **Advanced color**, and then click **Select color** as desired.
 - d) The outermost Outside paper color is used to set the Outside board color if no other color has been manually chosen for the outside of the board. Likewise, the innermost Inside paper color is used to set the Inside board color if no other color has been manually chosen for the inside of the board.
 - e) The ... button (Browse) is used in board definitions to calculate the color based on the materials comprising the board. It is not relevant for papers.
9. On the Texture tab are fields to specify the graphics that may be used to represent the inside, outside, and edge textures of the paper. These properties are only visible in the optional 3D module. Outside and inside textures are more relevant for boards, but may also be defined for papers, while board edge textures do not apply to papers.

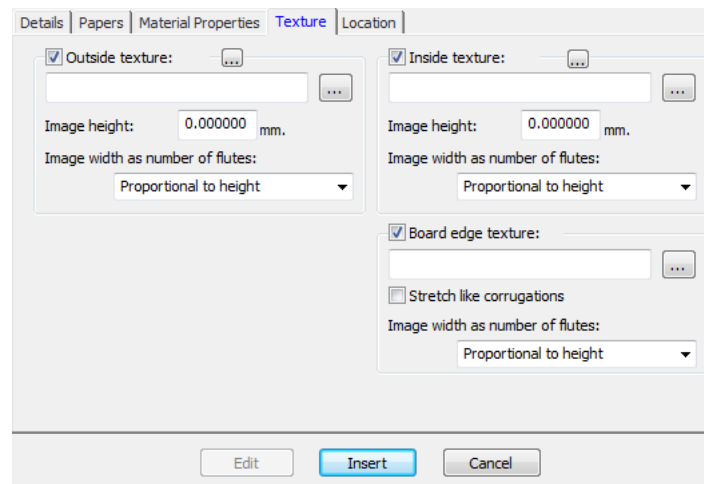

- a) To add an inside or outside texture to the paper, click the checkbox for it, and then specify the location of the graphic file for the texture, or click ... (Browse) to the right of the filename field and select it. Some common textures are stored in the **Boards** folder of the Shared Defaults Project. The image should be of the board surface with vertical grain or corrugation direction. If you use a custom image, measure the sample when you take its picture so that you know its size; you may need to touch up the image in a graphic editing program so that the edges blend together when the image is tiled.
- b) In the **Image height** field, enter the height of the image. The size needs to be set in order for ArtiosCAD to scale the picture appropriately. If the height is set to 0, the image will be scaled proportional to the width.
- c) Set the value in the **Image width as number of flutes** drop-down list box to the number of flutes the image represents. The image should be of a whole number of flutes. It may also be set to **Proportional to height**, in which case the height cannot be set to 0.
- d) Shown below is **boardbrown.jpg** from the **Boards** folder of the Shared Defaults Project, an example board texture three flutes wide:

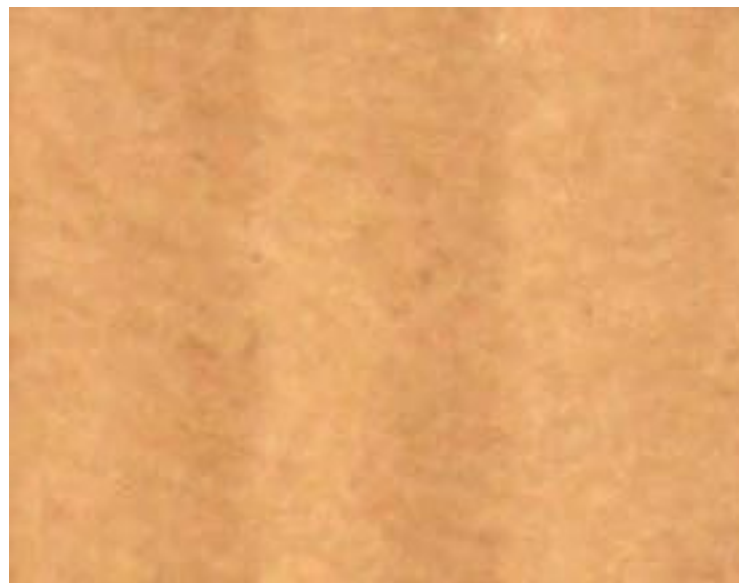

10. When you have finished defining the paper, click **Insert** to add the new paper definition.

Note:

Foams are defined in the same way as papers, just with larger dimensions.

Adding a Board

To add a board, do the following:

1. Launch ArtiosCAD Enterprise and log in as a member of the ADMINS group.
2. Click **Database > Manage Boards > Board browser**.
3. Click the plus signs next to folders to open them.
4. Boards are hierarchical. Right-click an item a level above the desired level for the new board (such as **Boards** to add the new board at the top level or **Artios > Corrugated Boards > C** to add a new C flute board) and click **New > Board**. (You may also create a new folder in this manner.)
 - You may also select the parent item and then click **Insert** on the toolbar to create a new board. To create a new folder, you must use the right-click method described above.

The Details pane will automatically appear with the fields enabled for editing.

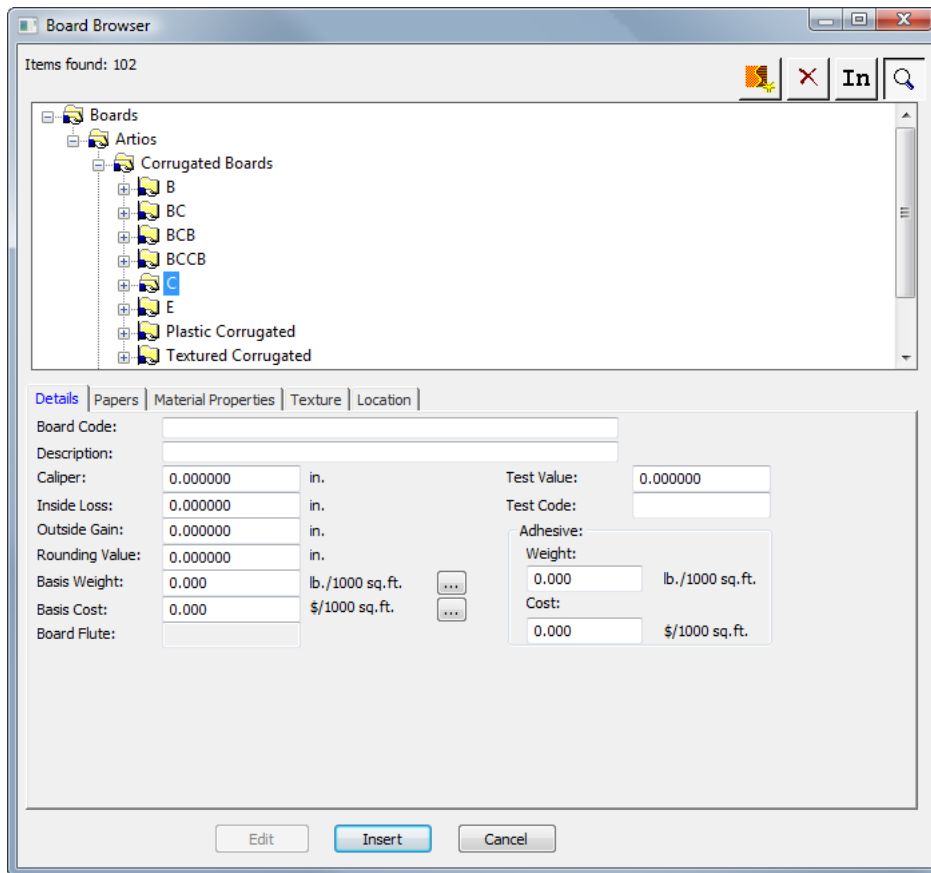

5. Enter values in the fields on the Details tab as appropriate.

- a) **Board Code** is the identifier used by the database to identify this new board; each board must have a unique code.
 - b) **Description** is the description of the paper.
 - c) **Caliper** is the thickness of the paper.
 - d) **Inside Loss** and **Outside Gain** are the allowances used when folding the paper or when gluing it together (such as in a glue flap). They are generally half the caliper.
 - e) **Rounding Value** sets a value to which dimensions may be set to round to when constructing a corrugated design. It is more relevant for boards as a whole rather than individual papers.
 - f) **Basis Weight** is the weight of the board in the selected system of units of measurement. Clicking the ... (Browse) button at the end of the field displays the Calculated Basis Weight dialog box. In this dialog box is an analysis of the calculated weight of the board based on the papers used to make it. To replace a manually-entered weight with the calculated weight, click **Accept**.
 - g) **Basis Cost** is the cost of the board in local currency and units of measurement. As with the **Basis Weight** field, the ... (Browse) button at the end of the field displays an analysis of the calculated cost of the board based on the papers used to make it. To replace a manually-entered cost with the calculated cost, click **Accept**.
 - h) **Test Value** is the amount of weight needed to break the material when performing very specific standardized tests.
 - i) **Test Code** is the identifier used in correlation with the Test Value to show the strength of the paper.
 - j) The **Weight** and **Cost** fields in the **Adhesive** group are the respective weight and cost of the adhesive for the board as a whole.
6. The Papers tab contains drop-down list boxes to select the liners and mediums that comprise the board.

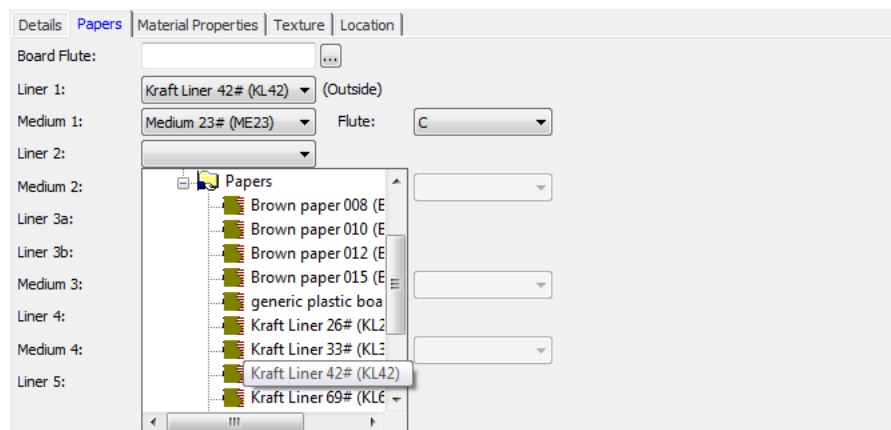

- a) If you know it already, type the flute code of the new board in the **Board Flute** field. At the end of the field is a ... (Browse) button that opens the Calculated Flute dialog box. Use this to calculate the flute code after defining the liners and mediums for the board. If it is a single board, expect a flute code like C. Double wall could be BC, while triple- and quadruple-wall would comprise four letters.
- b) Boards are defined sequentially from the outside inward. For example, you must select Liner 2 before you may select Medium 2. You may not select Liner 2 and then jump directly to selecting Liner 4.

- c) Select liners and mediums in their respective drop-down list boxes. As you select a liner and then a flute, the **Flute** drop-down list box for that pair becomes available. You must select a flute before the next liner becomes available for selection.
 - d) Complete the paper selection process with a liner.
7. On the Material Properties tab are fields to set the shininess, transparency, and inside and outside colors of the board. These properties are only visible in the optional 3D module.

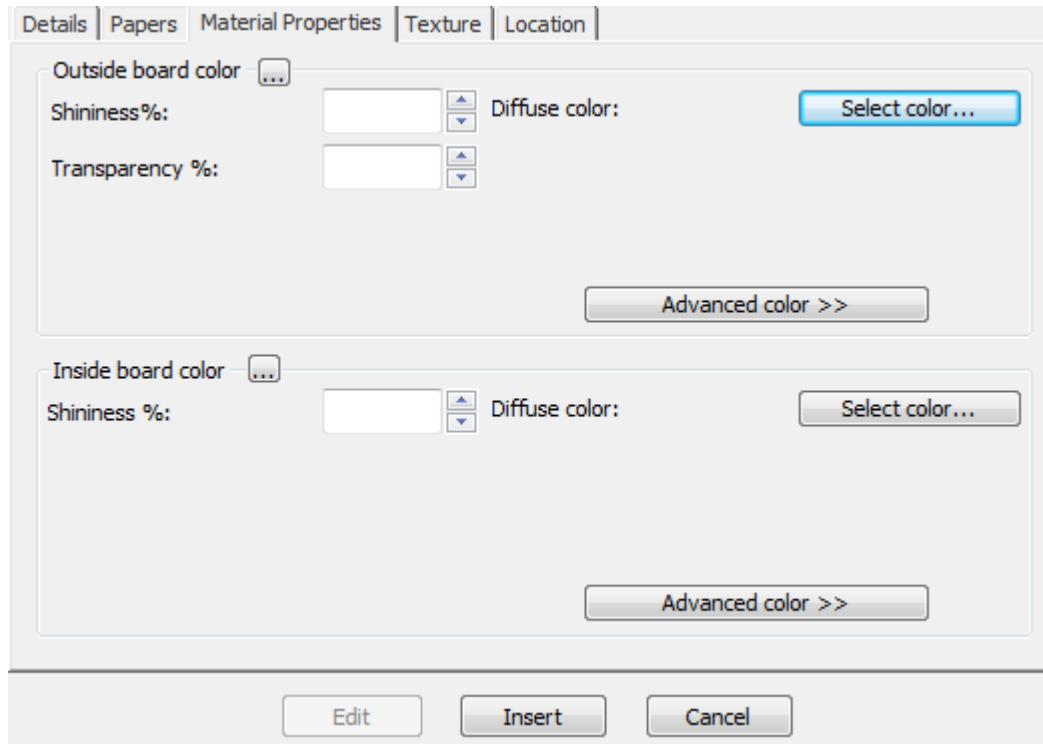

- a) Set the **Shininess%** and **Transparency%** fields as desired. The **Transparency%** field is a separate setting from transparency mode in 3D and is not affected by that setting.
 - b) Surface colors for papers are split into three components: **ambient** color, which reflects the ambient light; **diffuse** color, which reflects the movable lights in an airy, non-shiny way; and **specular** color, which reflects movable lights for a shiny surface, with a shiny surface having a white specular color and a dull surface a black specular color.
 - c) By default, the Material Properties tab only displays Diffuse color in Simple color mode. In Simple color mode, choose a color by clicking **Select color**. To set the other two colors, click **Advanced color**, and then click **Select color** as desired.
 - d) The outermost Outside paper color is used to set the Outside board color if no other color has been manually chosen for the outside of the board. Likewise, the innermost Inside paper color is used to set the Inside board color if no other color has been manually chosen for the inside of the board.
 - e) The ... button (Browse) calculates the color based on the materials comprising the board. Click **Yes** to use the color of the paper; click **No** to use the color of the current board definition.
8. On the Texture tab are fields to specify the graphics that may be used to represent the inside, outside, and edge textures of the board. These properties are visible only in the optional 3D module.

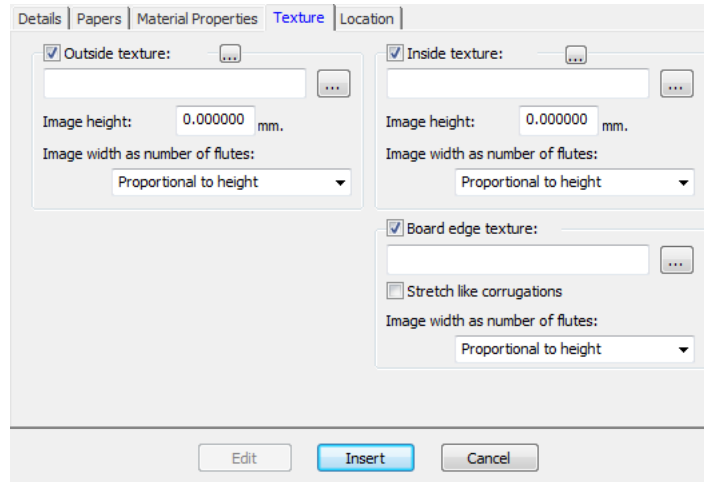

- a) To add an inside or outside texture to the board, click the checkbox for it, and then specify the location of the graphic file for the texture, or click ... (Browse) to the right of the filename field and select it. Some common textures are stored in the **Boards** folder of the Shared Defaults Project. The image should be of the board surface with vertical grain or corrugation direction. If you use a custom image, measure the sample when you take its picture so that you know its size; you may need to touch up the image in a graphic editing program so that the edges blend together when the image is tiled.
- b) In the **Image height** field, enter the height of the image. The size needs to be set in order for ArtiosCAD to scale the picture appropriately. If the height is set to 0, the image will be scaled proportional to the width.
- c) Set the value in the **Image width as number of flutes** drop-down list box to the number of flutes the image represents. The image should be of a whole number of flutes. It may also be set to **Proportional to height**, in which case the height cannot be set to 0.
- d) If using a custom board edge texture on a double, triple, or quadruple wall board, the board edge texture has to be a whole number of all the flutes. The largest flute is used initially, then the smaller flutes are adjusted by a few percent to align a whole number of the smallest flutes with a whole number of the largest flute. Knowing how many flutes the image represents is critical. To determine this, start with the board defined but with no custom edge texture. Export the 3D workspace to VRML and then view the associated PNG files created. One of those will be of the board edge texture. Count the number of flutes for the largest board and set the **Image width as number of flutes** field to the same number.
- e) Shown below is **boardbrown.jpg** from the **Boards** folder of the Shared Defaults Project, an example board texture three flutes wide:



- f) To specify a graphic for the board edge texture, check the **Board edge texture** checkbox, then specify the filename of the graphic file for the texture, or click ... (Browse) to the right of the filename field and select it. Some common textures, for example paper corrugated edges, plastic corrugated edges, and paper hexacomb flutes, are stored in the **Boards** folder of the Shared Defaults Project. The height of the image for a corrugated board should be the board caliper, and the width should be a whole number of flute pitches. Folding carton boards use an image width proportional to the height.
- g) If no texture is specified for a corrugated board edge, a default picture based on the height and pitch of the flutes is used.
- h) **Stretch like corrugations** stretches the picture of the board edge texture depending on its angle to the grain/corrugation direction. If this option is not selected, the board edge texture is repeated evenly.
- i) Shown below is a picture of the default board edge texture with **Stretch Like Corrugations** turned on in a design in 3D:

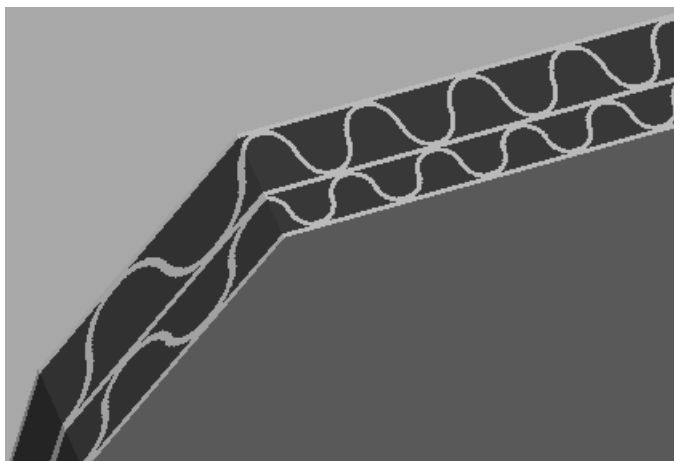

- j) Shown below is a picture of the BrownB board in the Textured Corrugated folder with **Stretch Like Corrugations** turned off in a design in 3D:

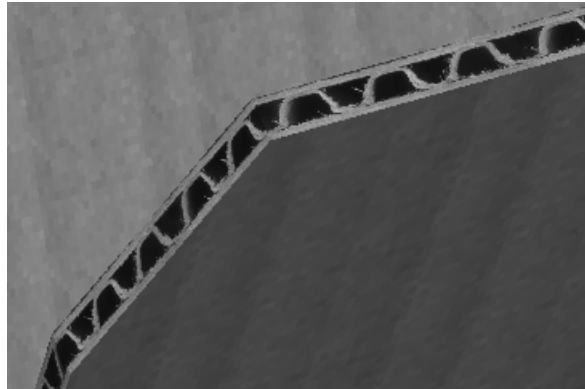

9. On the Locations tab, set those locations for which this will be a default board. Users at locations that are not checked in this step will have to click **Show All Boards** every time they create a design in order to see this board.

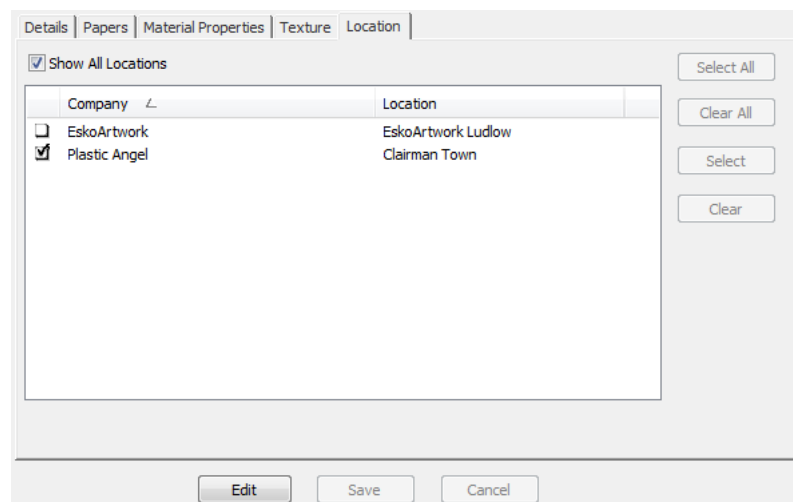

- a) Check **Show All Locations** to see all the locations defined.
 - b) Click **Edit**.
 - c) Select the checkboxes next to the locations for which this will be a default board. Use the buttons on the right side of the dialog box to select or clear all locations.
 - d) Click **Save** to set the locations in which this board will be visible.
10. When you have finished defining the board, click **Insert** to add the new board definition.

Renaming, Deleting, Moving, and Copying Board Entries

The Board browser supports multiple item selection, dragging and dropping of entries, cutting and pasting of entries, and right-clicking entries to perform functions on the context menu.

To create a folder, select its parent item (the one a level above its desired position), right-click it, and click **New > Folder** on the context menu. The folder name must be unique among same-level folders in the same parent folder.

To rename a folder, select it, right-click it, click **Rename** on the context menu, enter the new name, and press Enter.

To delete a folder, first make sure it is empty, and then select it, right-click it, and click **Delete** on the context menu. You may not delete a non-empty folder.

To rename a board, edit it and change its description. This change will not be communicated back into unmanaged documents using this board.

To move a folder or a board, drag it from one location to another.

To copy a board definition, select it, right-click it, and click **Copy** on the context menu. Right-click the folder into which it will be pasted and click **Paste** on the context menu. When the board is pasted into the new folder, the current system time will be appended to the board code to maintain board code uniqueness.

Defaults

Defaults for ArtiosCAD Enterprise have only a few operational differences from other versions of ArtiosCAD.

- All users must be invited to the Shared Defaults Project for each version and language of ArtiosCAD Enterprise they will be using. See the major Step 8 section of the installation instructions for more information.
- For users other than admin to edit Shared Defaults, they must have Full permissions on the Shared Defaults Project and be members of the ADMINS group. To create or change Location Defaults or User Defaults, they do not have to be members of ADMINS, but they must have View, Add, Update, and Lock permissions on the entire Project.
- As a best practice, we strongly recommend that you place new Defaults reference documents into the ServerLib folder (or a new unique user-defined folder) of the Shared Defaults Project for documents which need to be shared by all users. Please note that document names must be unique within a Project. For new Defaults reference documents which will only be used by you, place these in a new user-defined folder of your User Defaults Project. If you must change an existing ArtiosCAD-installed Defaults reference document, we recommended that you copy it as a new document to the ServerLib folder and then update the Defaults to reflect the new document name. Following these recommendations gives ArtiosCAD Enterprise the best chance of properly managing upgrades.
- If you change the username of a user, you must change the name of that user's associated Defaults project to match.

Browser Options

You can set browser options by clicking **Options > Defaults > Browser Settings > General Information**. As admin you can change the Shared Defaults, and you may be able to change your Location Defaults, but in most cases as any user you can change your own User Defaults.

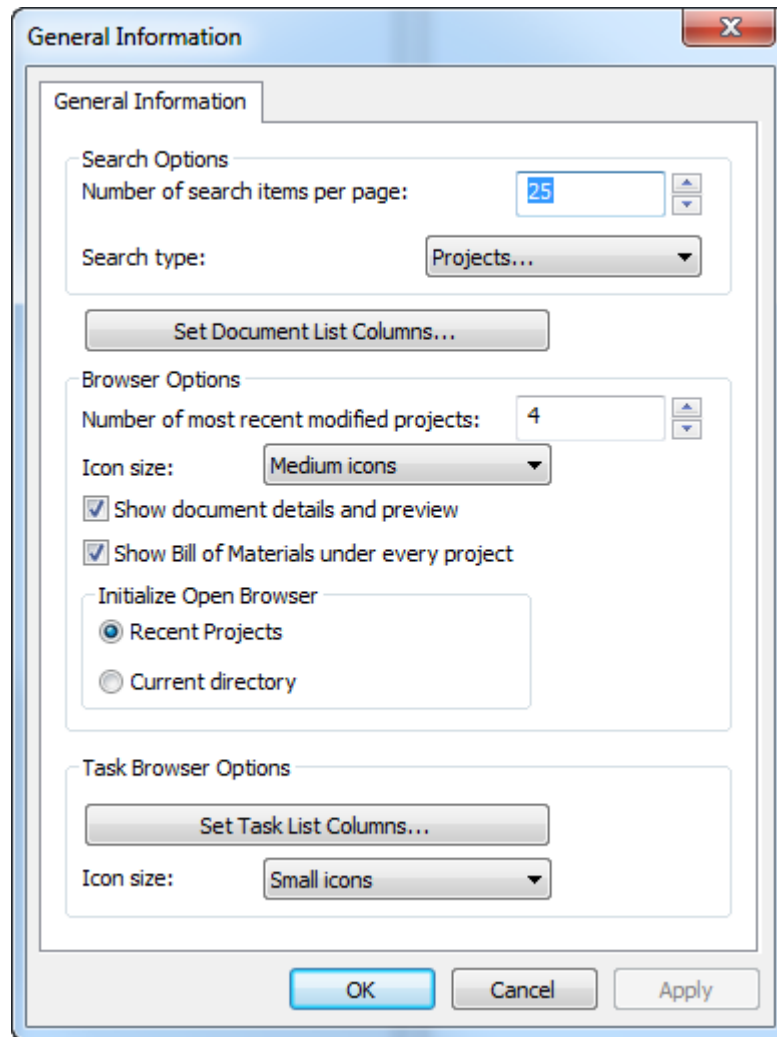

Note that you will only see the Defaults for the Task Browser if your WebCenter system has Task Management.

Click **OK** to return to Defaults once you have set the options as desired.

Bill of Materials Dialog Box Options

You can set BOM dialog box options by clicking **Options > Defaults > Database Defaults > Bill of Materials Dialog**.

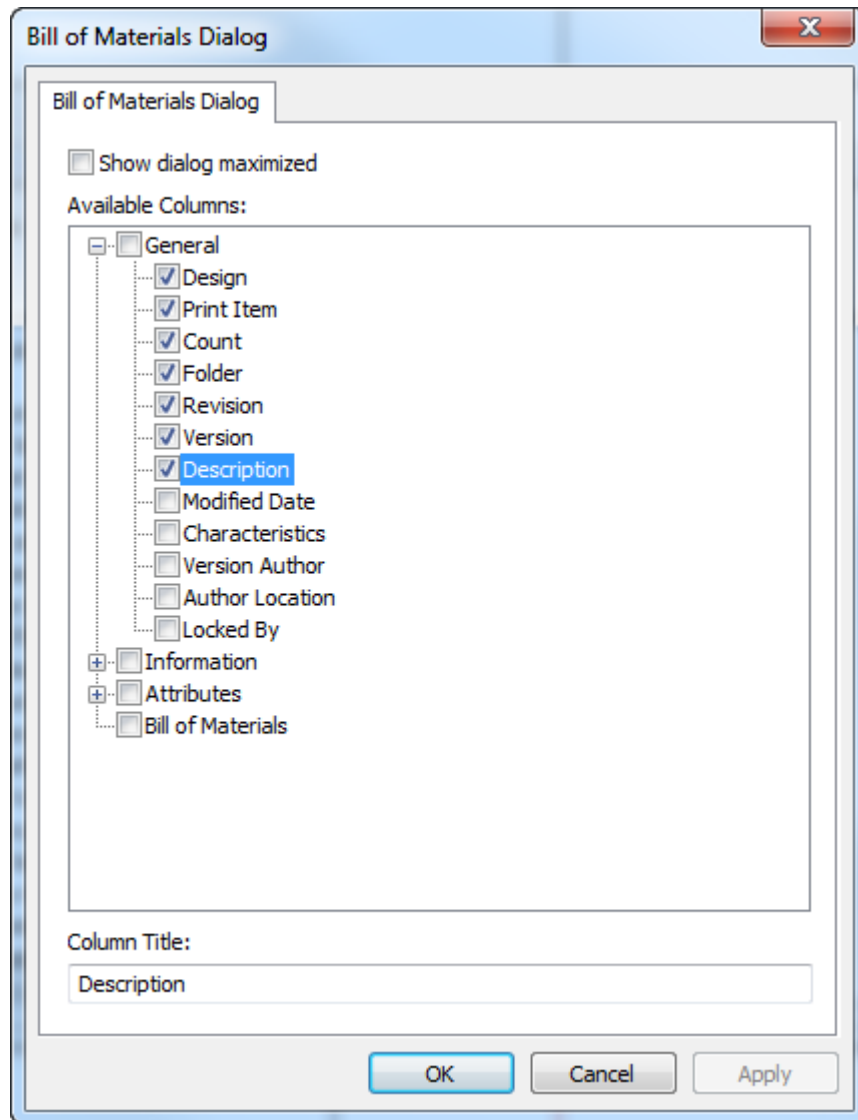

Show dialog maximized forces the BOM dialog to always be full size.

Choose the columns the BOM dialog box will show in the Available Columns pane. To rename a column, select it and enter its new name in the Column Title field.

In the BOM dialog box itself, use **Save Dialog Configuration** and **Load Dialog Configuration** on the View menu to save aspects of the dialog box such as size, position, and customized columns and then restore them as the same user on another computer.

Customized Database Information dialog boxes

To define custom Database Information dialog boxes for different types of documents, click **Database Defaults > Database Information Dialogs**.

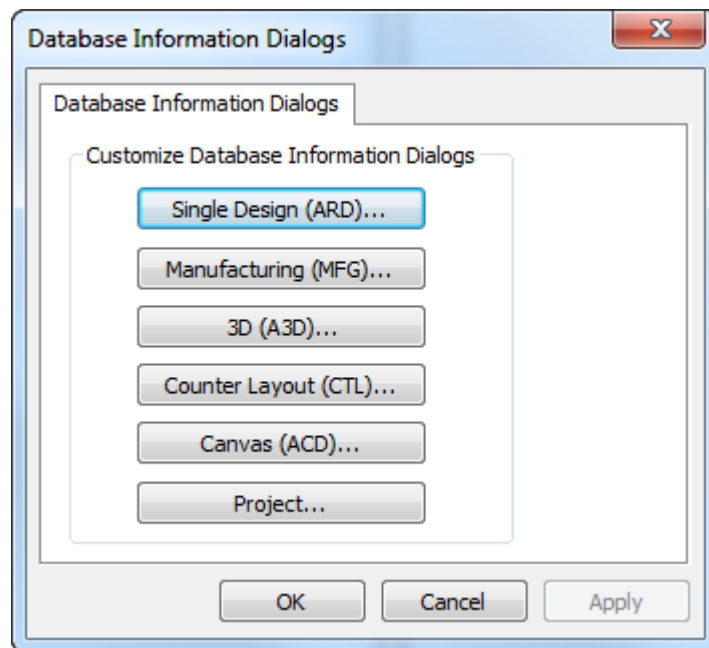

Click the button corresponding to the type of document you want to have a customized database information dialog box. For more information, see *Designing a custom Database Information dialog box* in the Defaults chapter.

If you design a custom database information dialog box, make sure to set the default attribute category for that type of document in **Database Defaults > Default Attribute Categories** so that the dialog box design utility knows the proper Attributes to use with the document.

General Database Options

You can set database options by clicking **Options > Defaults > Database Defaults > General Options**. As admin you can change the Shared Defaults and Location Defaults, but in most cases as any user you can change your own User Defaults.

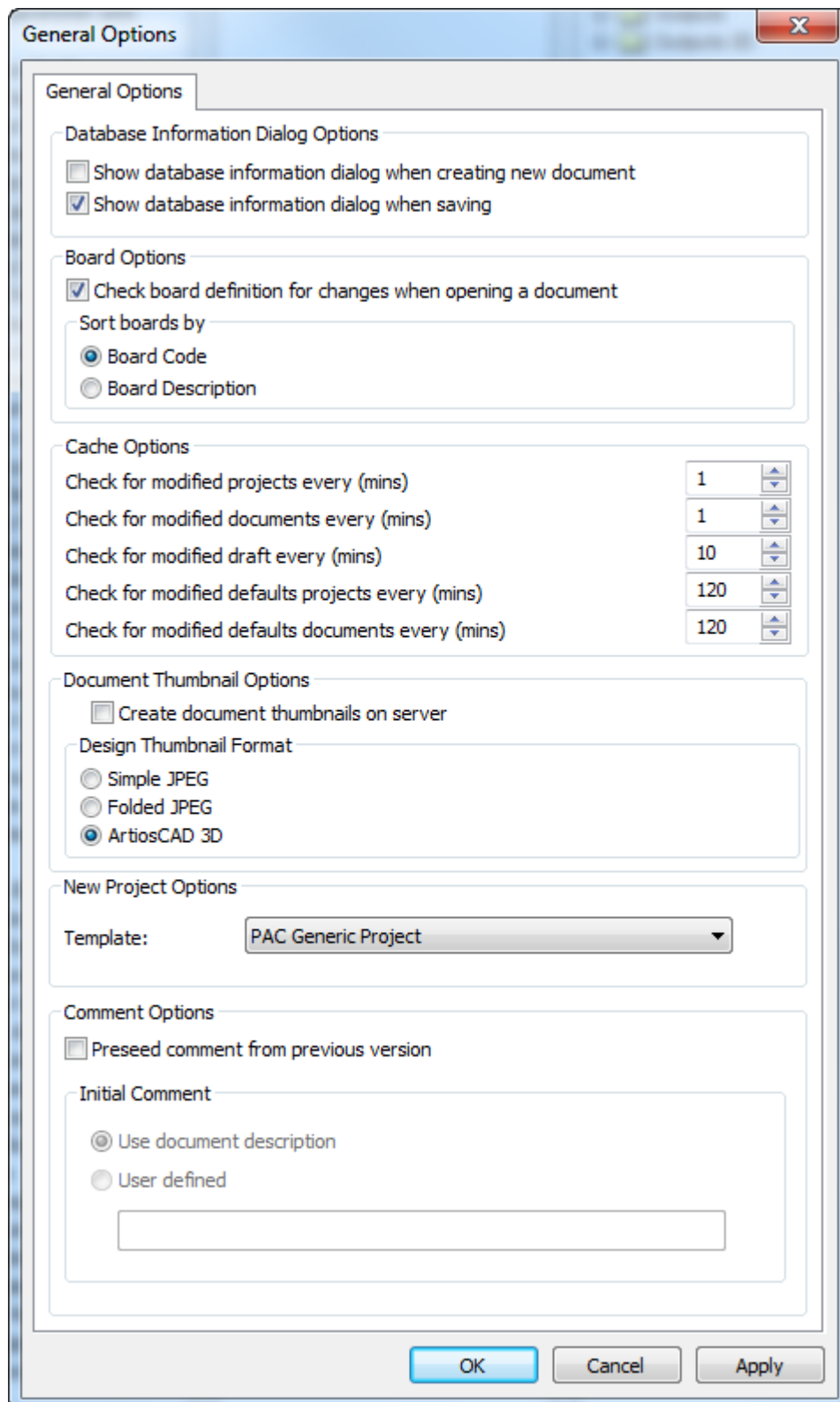

The options in the **Database Information Dialog Options** group control when you are prompted to enter database information about a document: when you create it, when you

save it, both, or neither. If you do not select either option, users must click **Database > Information** while working on a document to set its database information.

In the **Board Options** group, you can choose to check to see if a board code has changed when users open documents, and you can choose how they are sorted in the Board Catalog.

The options in the **Cache Options** group control how often ArtiosCAD Enterprise updates the cache. ArtiosCAD has different timers for Projects, documents, drafts, Defaults Projects, and Defaults documents. See the discussion on using the cache manager in *Using ArtiosCAD Enterprise* for more information about the cache.

In the **Document Thumbnail Options** group, **Create document thumbnails on server controls** whether ArtiosCAD Enterprise creates document thumbnails (deselected, the default choice) or if WebCenter creates the thumbnails (selected).

Choose the thumbnail format in the **Design Thumbnail Format** group.

The **New Project Options** group has a **Template** drop-down list box. Use this to set the default Template ArtiosCAD will use for new Projects you create through the browser. However, this does not apply to Projects used for Defaults.

The settings in the **Comment Options** group control how ArtiosCAD manages comments when saving a managed document.

To turn on the automatic commenting, check **Preseed comment from previous version**. This also enables the options in the Initial Comment group.

Use document description copies the document description to the comment field. If there is no document description, ArtiosCAD will prompt you for a comment. This will also cause the Project description to seed the document description when you save a managed document for the first time so that on the next save, the comment will be able to be seeded from the description.

User defined lets you enter a custom string that ArtiosCAD will use for the first comment.

Save Options

To set options for saving documents, click **Options > Defaults > Startup Options > Save Options..**

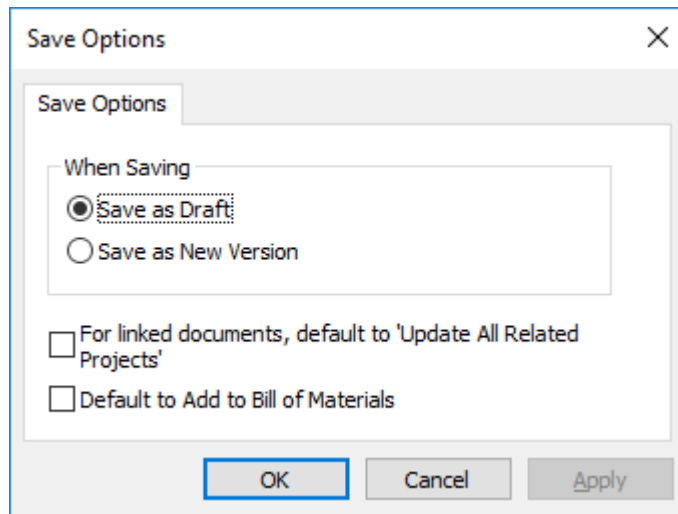

To choose what happens when you click Save, choose either **Save as Draft** or **Save as New Version**.

When you save a linked document, ArtiosCAD Enterprise only updates the home Project of that document. To default to always updating all related Projects, check **For linked documents...**

Default to Add to Bill of Materials controls the state of the **Add to Bill of Materials** checkbox when doing a **Save As, Publish Version, or Publish Revision**. Note that **Publish Version** allows you to add the document to the BOM but not to update the BOM if the document is already in it.

Click **OK** to save your changes and return to Defaults.

Setting the Default Folder for Saving Parts in Canvases

In the Canvas/Parts Options dialog box under Startup defaults, an option specific to ArtiosCAD Enterprise is Default Folder For Saving Parts.

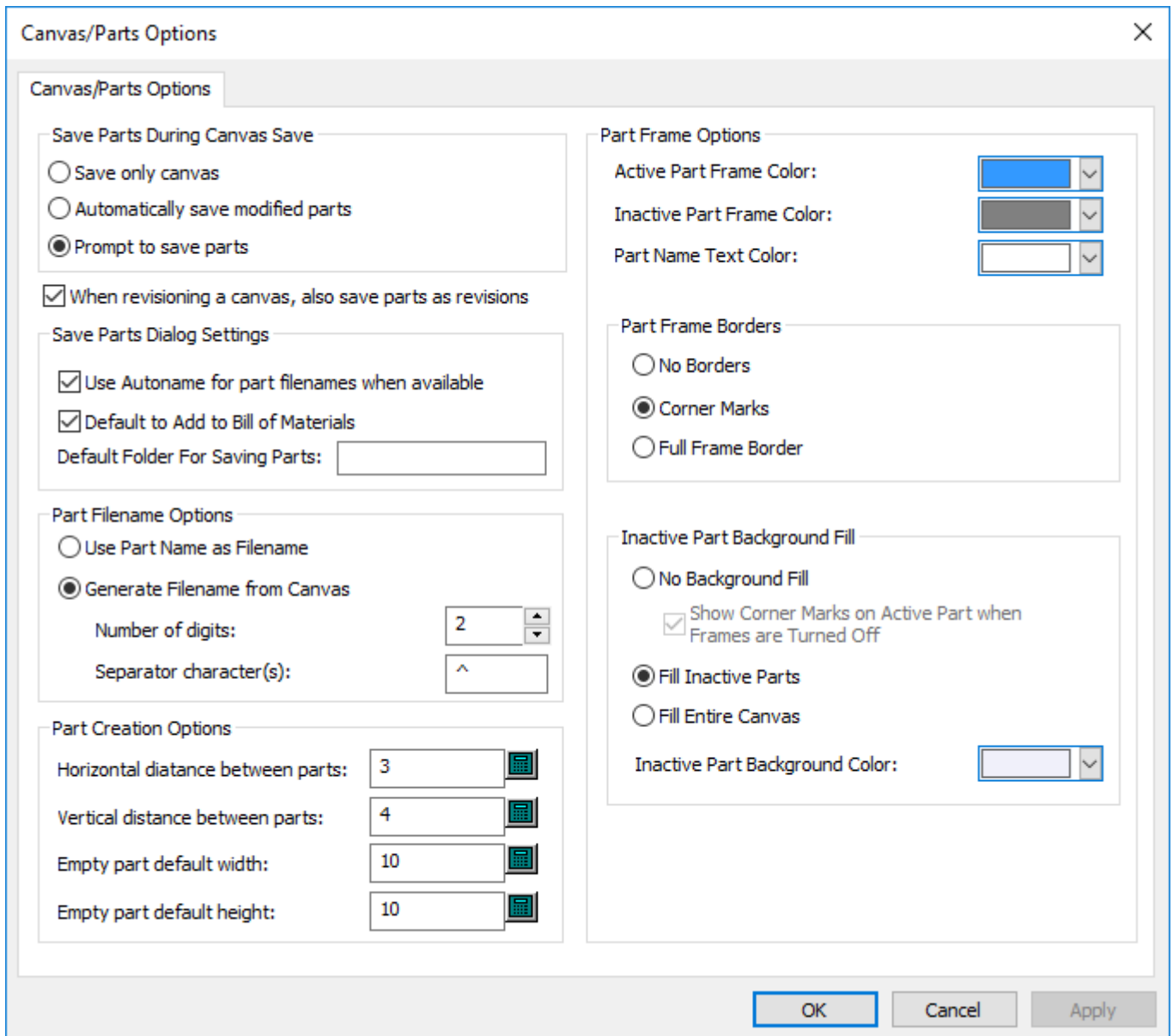

Default Folder For Saving Parts in the Save Parts Dialog Settings lets you specify a default folder in a Project for saving parts, which ArtiosCAD Enterprise will create if it does not exist. When you save parts, this folder in the Project will be the default location

Note:

Because WebCenter supports only one level of folders in a Project, you cannot specify a multi-level hierarchy such as folder1\folder2\folder3 for the default folder. ArtiosCAD Enterprise would create a folder with that name.

Export Document Naming Format Options

When you Output a version of a managed file in a different format for use by someone else, **Save revisioned document name with version number** in **Options > Defaults > Startup**

defaults > Export Document Name Format adds the revision letter and version number to the filename.

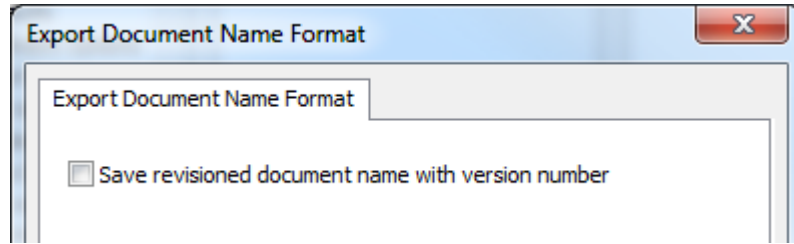

ArtiosCAD Enterprise separates the parts of the filename with underscores. First is the name of the managed document, then the revision letter, and last the version number.

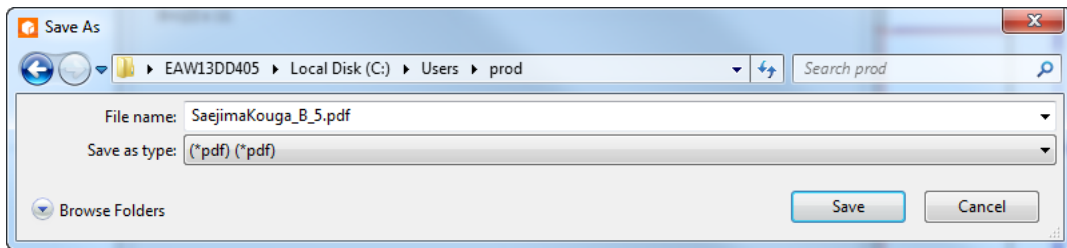

Note: This option applies to all file-based Outputs.

Sending an Output to a Project

In ArtiosCAD Enterprise, you can direct an Output to go to a Project instead of a device or file.

Destination Tab in an Output Definition

Outputs that create files can send those files to Projects rather than directories by choosing the appropriate options on the Destinations tab.

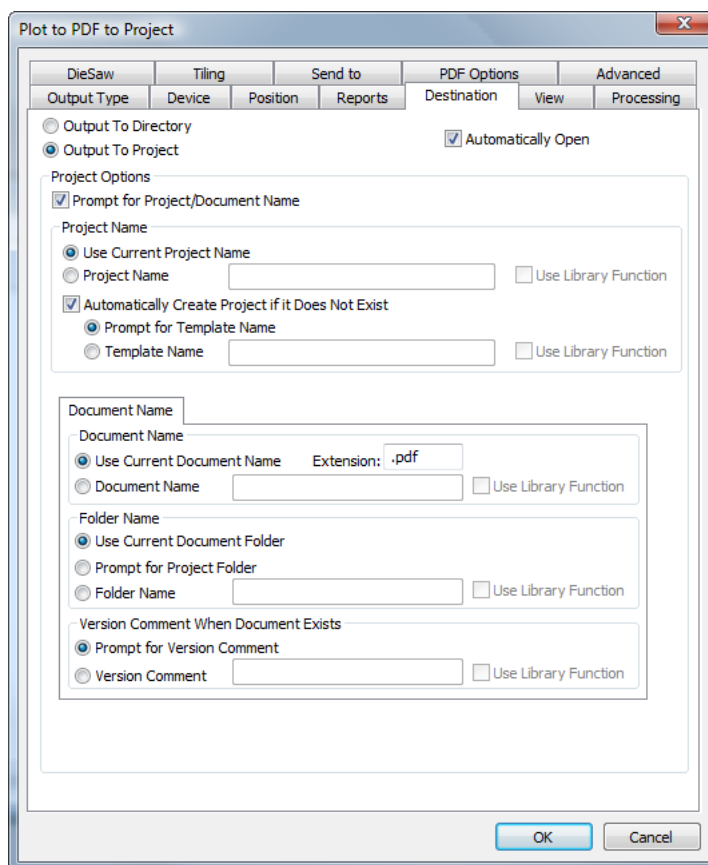

When you select **Output To Project**, many options become available for setting Project and document names and properties. If you choose any of the prompt options, when you run this Output, the Project Browser appears so you can navigate to the desired Project, set the document and folder names, and enter any prompted information.

If **Automatically Open** is selected in an Output that goes to a Project, a temporary version of the Output is downloaded to your computer and the appropriate program for the type of Output opens it. In the example above, the PDF file is saved to the Project, and then a temporary copy is downloaded and opened by the application registered to open PDFs on your system.

Setting the Title Bar Display Options

You can choose which revision and version information ArtiosCAD shows in the title bar. The Title Bar Options dialog box in **Options > Defaults > Startup defaults** presents different formatting options. Choose the preferred option and click **OK**.

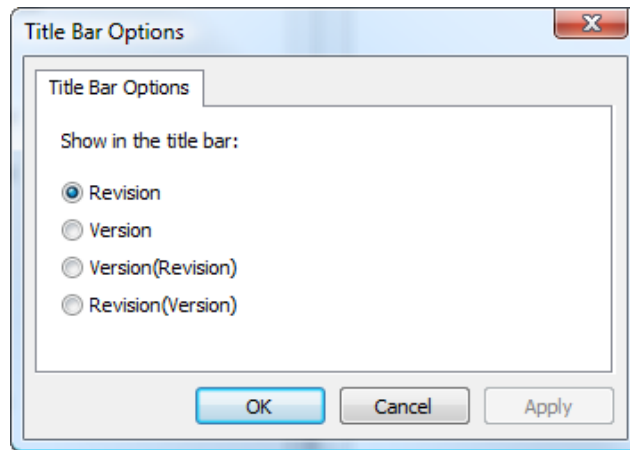

Location Defaults Overview

Location Defaults are an intermediate level of Defaults between User Defaults (used first) and Shared Defaults (used last). Each user **must** be assigned a location and be invited to the appropriate Location Defaults Project in order for that user to use Location Defaults.

A user who is a member of the ADMINS group must do the initial creation and configuration of the Location Defaults for each location.

Members of ADMINS may also control which categories of Location and User Defaults users may set by using Defaults Availability, covered later in this section.

There are three steps involved in configuring Location Defaults:

1. Perform the **Location Defaults Setup** on the Options menu logged in as a member of ADMINS with a location set.
2. Use **Defaults Availability** on the Options menu to set which Defaults are available to users.
3. Add Defaults as desired to Location Defaults in the same way as you would to User Defaults or Shared Defaults.
4. Invite the users of a location to the Location Defaults Project and set their permissions. For non-ADMINS users to be able to create Location Defaults, they must have View, Add, Update, and Lock permissions on the entire Location Defaults Project.

Location Defaults Setup

Only members of ADMINS can set up Location Defaults. Location Defaults may optionally be based on a Template that has the desired members, permissions, and contents already set.

1. Launch ArtiosCAD Enterprise and log in as a member of the ADMINS group.
2. Click **Database > Change Location** and choose the company and location for which you want to set up Location Defaults. This only temporarily assigns your company and location for this ArtiosCAD session.
3. Click **Options > Location Defaults Setup**.
4. Select the appropriate location and click **Create Defaults**.

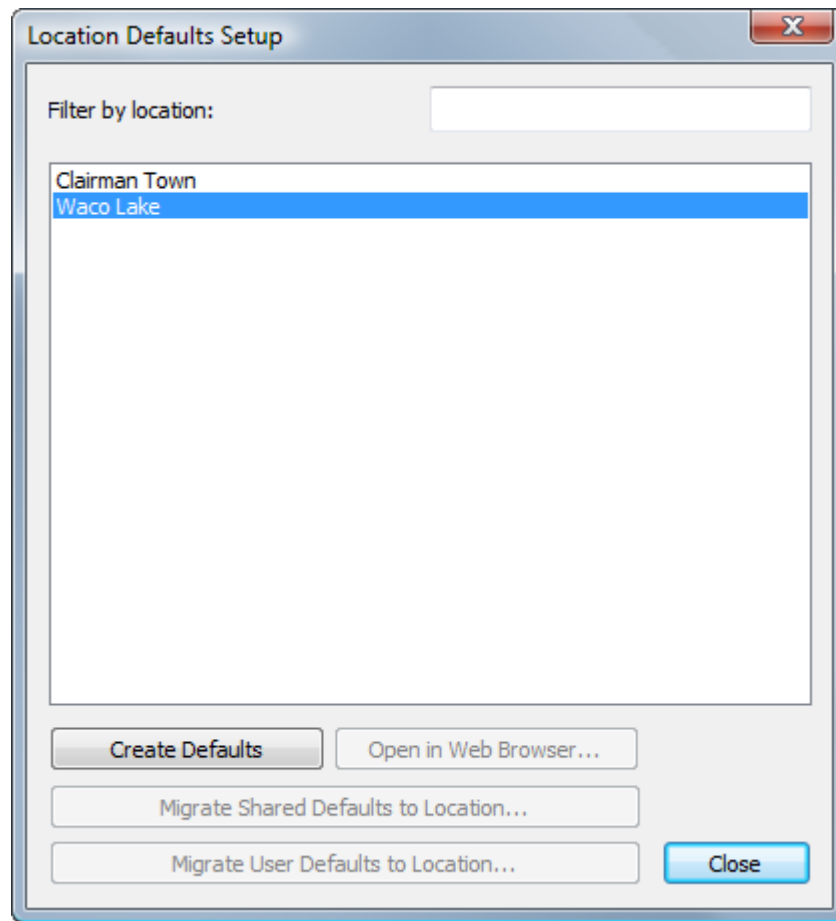

5. In the Create New Project dialog box, change the description and choose a Template, customer name and location, if desired, and click **OK**. You may not change the name of the Project, and any invalid characters in the company or location name are replaced with underscores (_). Invalid characters for Project names are ", *, ;, /, \, ?, <, >, |, =, ;, [,], ^, @, and a space. See the next section for information about creating a Template to use with Location Defaults.

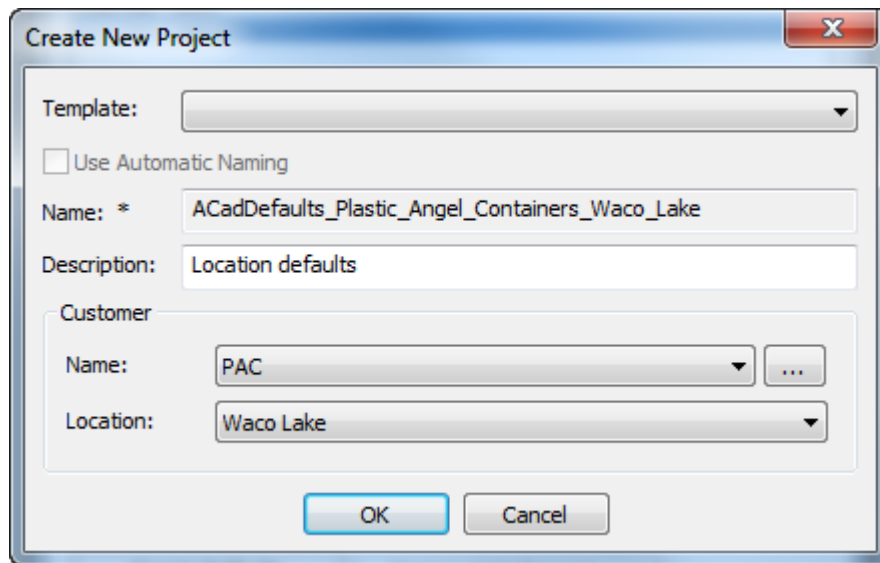

After it creates the new Location Defaults Project, ArtiosCAD changes the Location Defaults Setup dialog box so that the other commands are available.

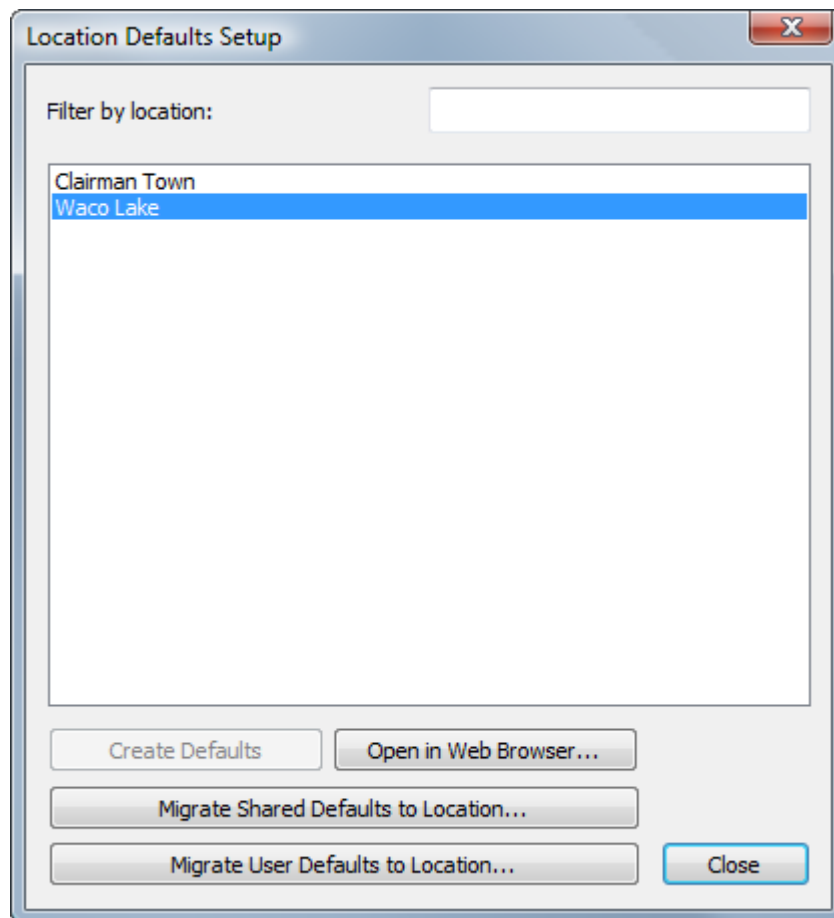

Open in Web Browser opens this Location Defaults Project in WebCenter using your default Web browser. You can then invite members, configure permissions, and so forth.

You can also migrate existing ArtiosCAD Standard Edition Shared Defaults or User Defaults into Location Defaults. Note that for User Defaults, you must currently be using the machine holding the User Defaults in order to migrate them.

Now when you open Defaults in ArtiosCAD, you can add items to the Location Defaults pane just as you would for Shared Defaults or User Defaults.

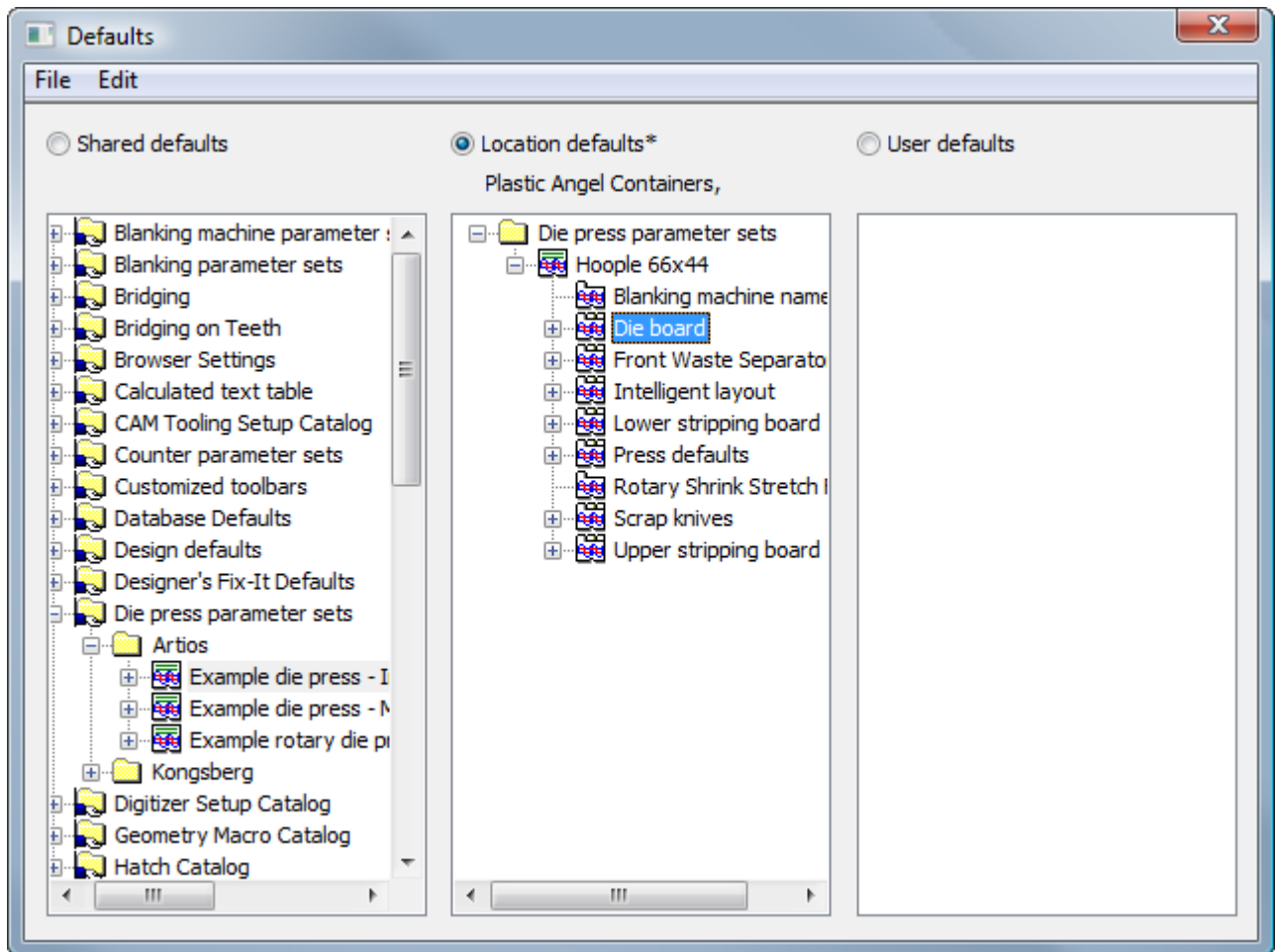

Creating a Location Defaults Project Template

To create a Template to use as the basis for Location Defaults Projects, do the following:

1. Log into WebCenter as a member of ADMINS.
2. Create a new Project to serve as the Location Defaults Template. Do not define autonaming in this Project as that has no effect for a Location Defaults Project.
3. Invite users to the Project and set their permissions.
4. Launch ArtiosCAD Enterprise and log in as a member of the ADMINS group.
 - a) Click **Options > Defaults**, click **User defaults** to activate that pane, and then click **File > New** to create a new set of Defaults.

- b) In the **New defaults** pane, create new Defaults as desired by dragging and dropping from Shared Defaults or by creating new ones by right-clicking.
 - c) Make any desired changes to these new Defaults.
 - d) Click **File > Save As > File** and save the file locally as `locationdfilt.adf`. It must have this exact name.
 - e) Click **File > Exit** to exit Defaults and return to ArtiosCAD.
5. In WebCenter, upload the file you created in the previous step to the root level of the Project serving as the Location Defaults Template.
 6. Save this Project as a Template. It is now ready to be selected when you perform Location Defaults Setup for a location.

Migrating Defaults from ArtiosCAD Standard Edition to ArtiosCAD Enterprise

After you have set up Location Defaults, you can choose to migrate Shared Defaults or User Defaults to the new Location Defaults.

Note:

Migrating existing Shared Defaults or User Defaults to Location Defaults will overwrite any existing Location Defaults. It is a good idea if your current Location Defaults have data in them to back up your Location Defaults using the browser. Drag the current Location Defaults Project to a location in the Explorer node before you begin so that you have them as a backup.

1. Still in the Location Defaults Setup dialog box, click either **Migrate Shared Defaults to Location** or **Migrate User Defaults to Location**. Note that the potential User Defaults must be from the current machine.
2. Click **Yes** in the warning dialog box to migrate the Location Defaults.
3. in the Defaults Migration Dialog box, choose the version of ArtiosCAD containing the desired Defaults and click **OK**. This process may not be canceled or aborted, so proceed with caution if you are unsure and click **Cancel** if you have any doubts.

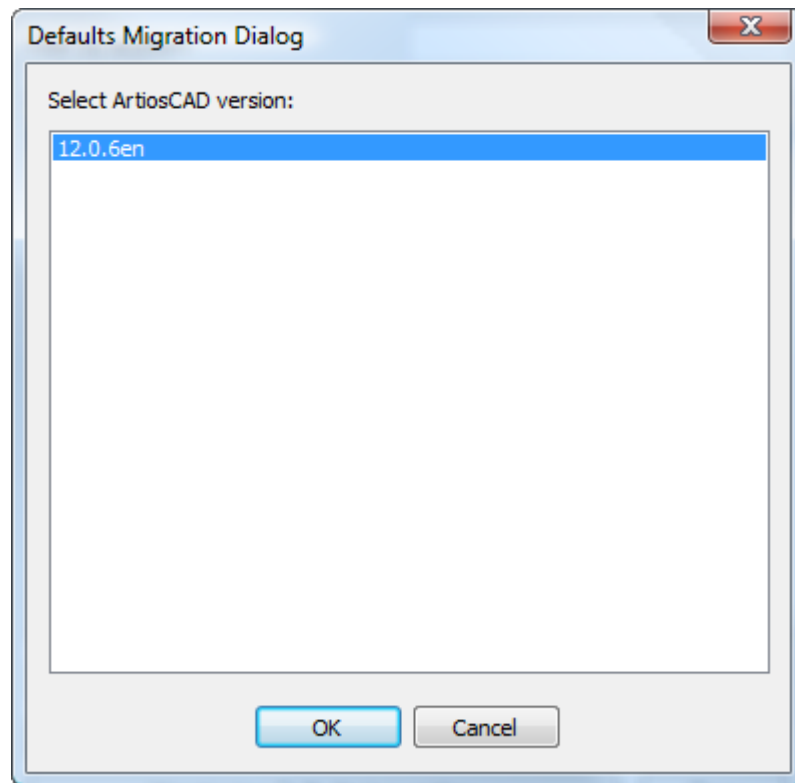

4. A progress bar will appear as ArtiosCAD uploads the Defaults to WebCenter.

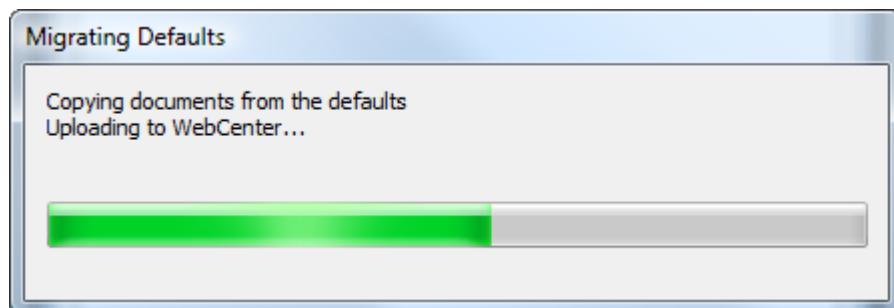

5. When the upload is complete, you will return to the Location Defaults Setup dialog box. Click **Open in Web Browser** to go to the Location Defaults Project in WebCenter, or click **Close** to return to ArtiosCAD.

Two important notes about the Defaults migration process:

- When you migrate Defaults from ArtiosCAD Standard Edition to Location Defaults in ArtiosCAD Enterprise, data files that the Shared or User Defaults reference remain on the local computer. The Defaults will continue to work as long as the files on the local computer exist. To get them fully into Location Defaults without relying on the local computer, use the Explorer node of the browser to manually drag any referenced files from ServerLib into the appropriate folders inside the Location Defaults Project, and then update the references in Location Defaults to point to the correct documents.
- Likewise, if the User Defaults you migrated reference ArtiosCAD Standard Edition Shared Defaults, the referenced information is not migrated. For example, if you have a custom

toolbar defined in User Defaults that reference Outputs that use files (such as Reports) or geometry macros, the toolbar itself will be migrated into Location Defaults but the Report files and geometry macros will not be. Use the Explorer node of the browser to manually drag any referenced files from ServerLib into the appropriate folders inside the Location Defaults Project, and then update the references in Location Defaults to point to the correct documents.

Migrating User Defaults from ArtiosCAD Standard Edition to ArtiosCAD Enterprise

If users who are Project Managers decline to migrate their User Defaults from ArtiosCAD Standard Edition to ArtiosCAD Enterprise upon their first launch of ArtiosCAD Enterprise, they can manually start the migration afterward.

Note: Users who are not Project Managers do not have this menu command available as since they may not create their User Defaults Projects themselves. Instead, they must have a member of ADMINS create their User Defaults Projects, invite them to their User Defaults Projects, and set their permissions to at least Delete and Upload.

1. Logged in as the appropriate user, click **Options > Migrate User Defaults from Conventional ArtiosCAD**.
2. Click **Yes** in the warning dialog box to migrate the User Defaults.
3. in the Defaults Migration Dialog box, choose the version of ArtiosCAD containing the desired Defaults and click **OK**. This process may not be canceled or aborted, so proceed with caution if you are unsure and click **Cancel** if you have any doubts.

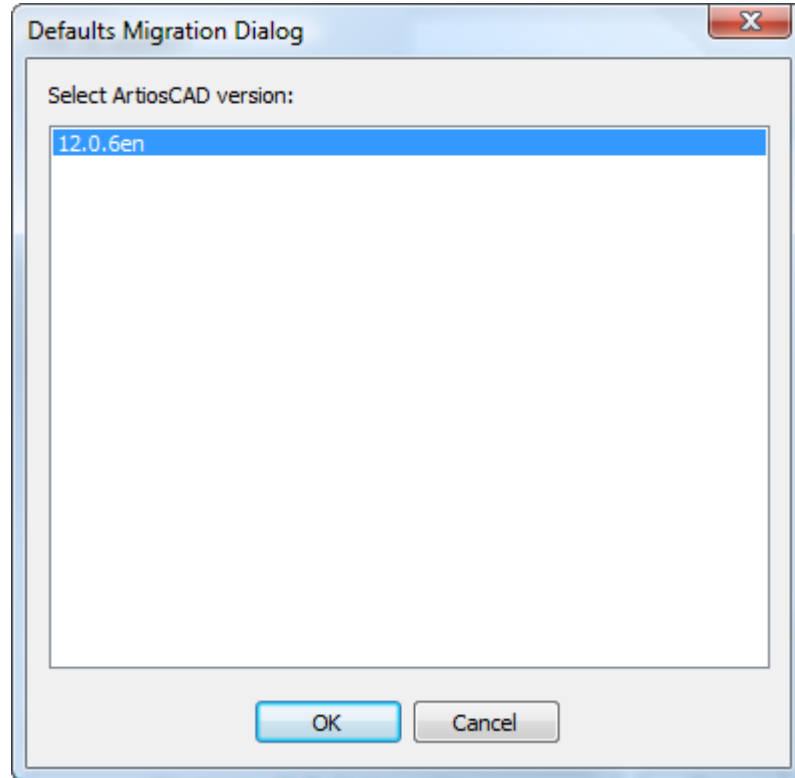

4. A progress bar will appear as ArtiosCAD uploads the Defaults to WebCenter and will disappear when the process is complete.

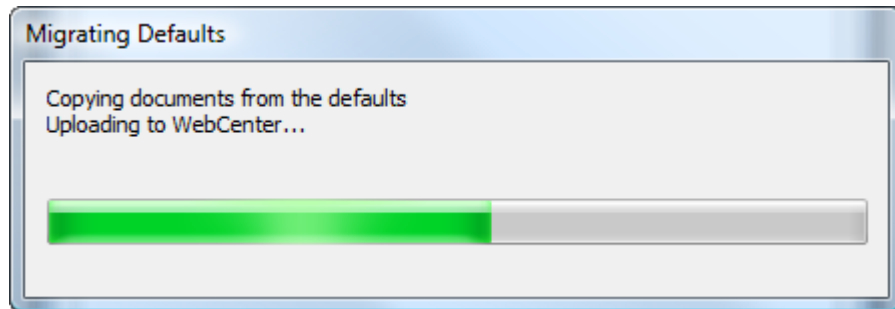

Always Showing All Boards

When users do not have default boards assigned to their locations, when they create a new design or look at the Board Information dialog box, they will not see any boards. To solve this problem, **Always show all in boards selection** in the Default boards catalog in Design defaults is enabled by default.

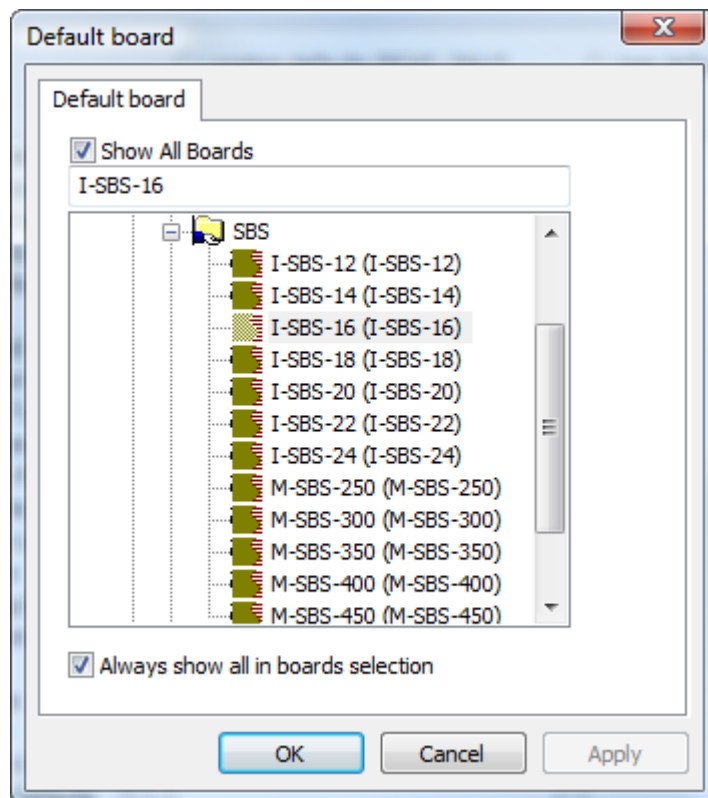

Turn this option off after you have assigned each location a default board set, else toggling **Show All Boards** will not have much effect.

Defaults Availability overview

Defaults Availability on the Options menu gives members of ADMINS control over the types of Defaults users may create and use in Location Defaults and User Defaults. For example, you may want to force users to use a particular die press parameter set and not let users create new die press parameter sets or modify the existing die press parameter set. Setting the Project permissions appropriately prevents the modification of the die press parameter set in Shared Defaults, and using the settings in Defaults Availability can prevent them from creating a new parameter set in User Defaults that would take precedence over the ones in Location Defaults or Shared Defaults.

Defaults Availability has two modes. As a member of ADMINS, you can:

- set the availability of items in Location Defaults for all locations of all companies
- set the availability of items in User Defaults for multiple locations of your assigned company simultaneously. If you do not have a company assigned, this option will be unavailable; click **Database > Change Location** to set a temporary location before using Defaults Availability.

Setting Defaults Availability for Location Defaults

To set the availability of defaults in Location Defaults for all companies and all locations, do the following:

Note:

Any Defaults categories you clear in this procedure become unavailable in all User Defaults as well.

1. Launch ArtiosCAD Enterprise and log in as a member of the ADMINS group.
2. Click **Options > Defaults Availability**.
3. In the Defaults Availability Setup dialog box, click **Set defaults availability for location defaults** if it is not already selected.
4. Clear the checkboxes next to the Location Defaults categories to which you want to deny users access. Right-click the column header to check all the checkboxes, clear all the checkboxes, or invert the selection. Any categories you clear in this step will also become unavailable in all User Defaults as well.

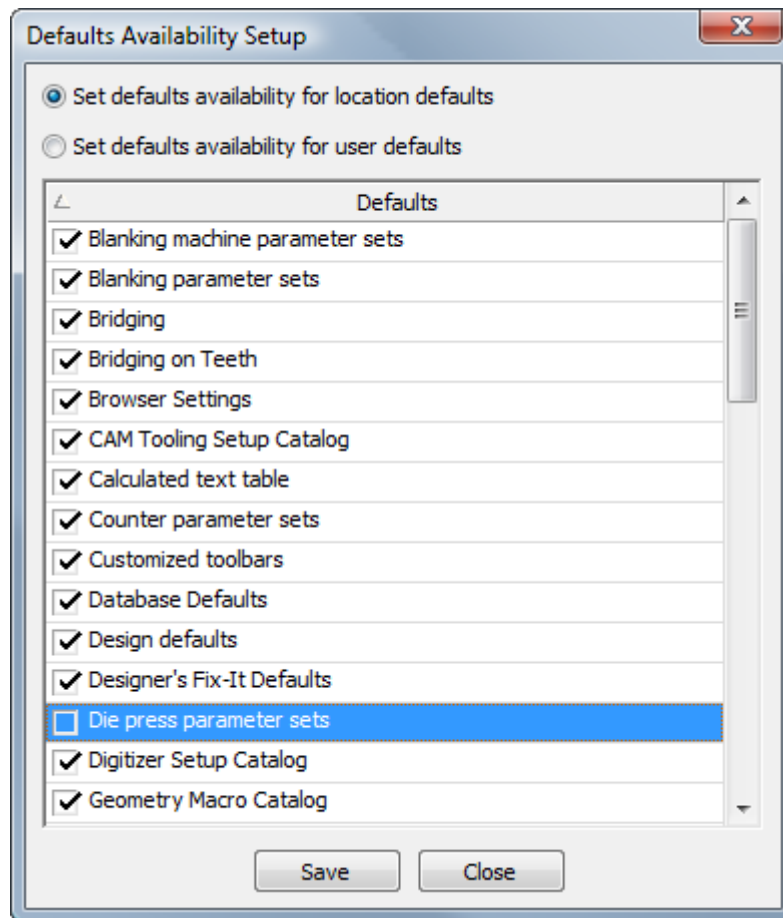

5. Click **Save** when you are done checking and clearing checkboxes.
6. Change the mode selector to **Set defaults availability for user defaults** to make those changes, or click **Close** to return to ArtiosCAD.

Setting Defaults Availability for User Defaults

To set the availability of defaults in User Defaults for all users at selected locations of your company, do the following:

Note: If you do not have a company assigned, this option will be unavailable; click **Database > Change Location** to set a temporary location before using Defaults Availability.

1. Launch ArtiosCAD Enterprise and log in as a member of the ADMINS group.
2. Click **Options > Defaults Availability**.
3. In the Defaults Availability Setup dialog box, click **Set defaults availability for user defaults**.
4. Select one more or locations containing the users to whom you are denying access.
5. Clear the checkboxes next to the User Defaults categories to which you want to deny users access. Right-click the column header to check all the checkboxes, clear all the checkboxes, or invert the selection.

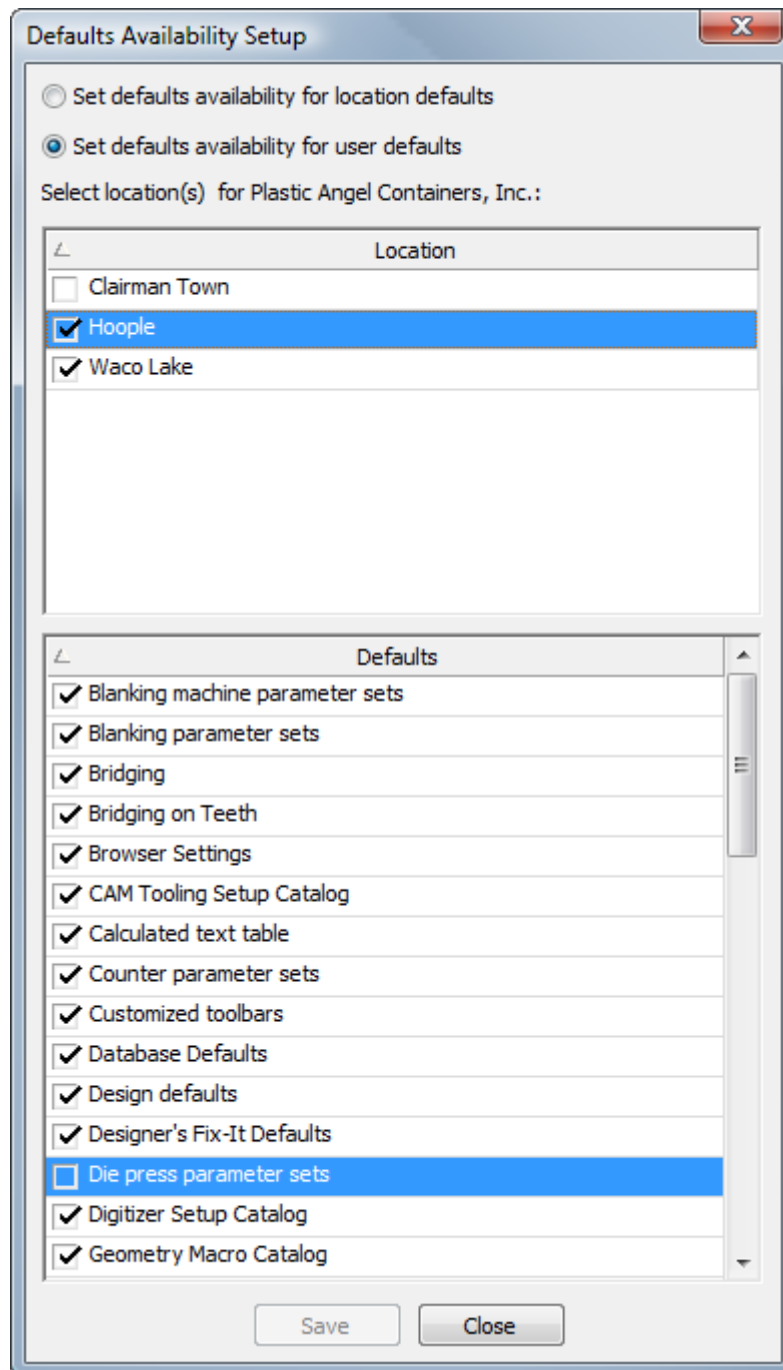

6. Click **Save** when you are done checking and clearing checkboxes.
7. Click **Yes** in the warning dialog box about overwriting defaults availability.
 - a) If any the locations you selected do not yet have Location Defaults Projects set up for them, ArtiosCAD will prompt you to create a Project for each as needed.

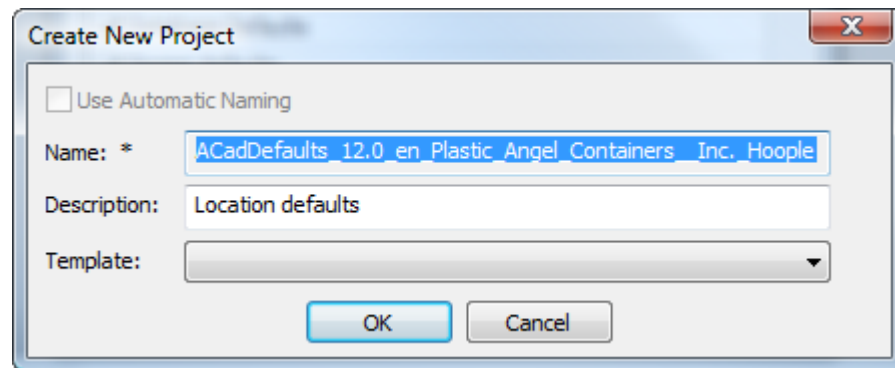

8. ArtiosCAD displays a progress bar as it makes the changes to Defaults.

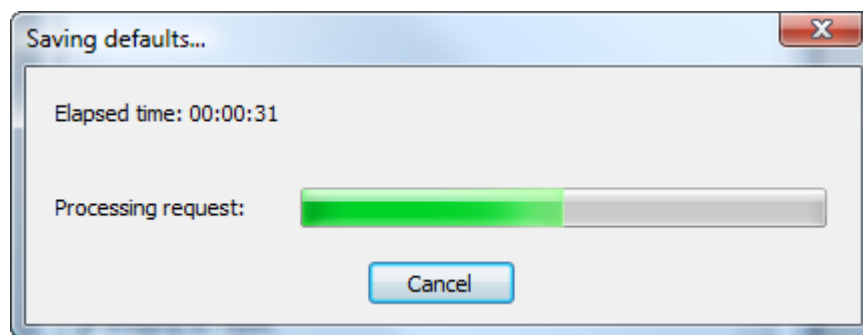

9. Click Close in the Defaults Availability Setup dialog box to return to ArtiosCAD.

Configuring the Automatic Naming Templates

There are three places in WebCenter to configure automatic naming - in **Admin > Preferences > General** for Projects and in **Admin > Preferences > Document Types** for documents. For Templates, to override the system default autonaming configuration for Projects and documents inside that Template, it is in **Admin > Projects > Templates > <template> > Configure > Project Creation or Document Creation**.

The naming templates control the prefix, body, and suffix ArtiosCAD Enterprise uses when it names Projects and documents automatically. The body is a counter that increments independently for each Project or document.

To configure the naming templates, do the following:

1. Start a Web browser and log in to WebCenter as a member of the ADMINS group.
2. For Projects, click **Admin > Preferences > General**.
 - a) Check **Use Automatic Naming for Creation of Blank Projects**.
 - b) In the Project Autoname Generation section, enter the building blocks of the prefix and suffix in the appropriate fields. Make sure to use spaces or other delimiters (not commas) between the fields, else they will run together and the counter will not increment correctly.
 - c) For a list of the building blocks you can use for the prefix and suffix, click **Help** at the top right of the page. Make sure to read the notes at the bottom of the page for restrictions.

The building blocks are case-sensitive. DO NOT USE COMMAS IN THE PREFIX OR SUFFIX.

- d) Click **+ []** to use SmartNames to define the prefix or suffix. If you want to be able to enter your own text in the name at creation time, use the **Edit Field** SmartName as a building block.
 - e) In the **Counter Length** field, enter the length of the incremental counter that will form the body of the Project/document names between the prefix and suffix. For example, enter 5 for numbers that will be five digits long.
 - f) Click **Save** to make the changes.
- 3. For documents, click Admin > Preferences > Document Types.**
- a) Check **Apply Automatic Naming to Documents in Blank Projects**.
 - b) In the **Automatic Document Naming** column, change the drop-down list box from **None** to **Custom** for each desired document type.
 - c) Enter the building blocks of the prefix and suffix in the appropriate fields. Make sure to use spaces or other delimiters (not commas) between the fields, else they will run together and the counter will not increment correctly.
 - d) For a list of the building blocks you can use for the prefix and suffix, click **Help** at the top right of the page. Make sure to read the notes at the bottom of the page for restrictions. **The building blocks are case-sensitive.** DO NOT USE COMMAS IN THE PREFIX OR SUFFIX.
 - e) Click **+ []** to use SmartNames to define the prefix or suffix. If you want to be able to enter your own text in the name at creation time, use the **Edit Field** SmartName as a building block.
 - f) In the **Counter Length** field, enter the length of the incremental counter that will form the body of the Project/document names between the prefix and suffix. For example, enter 5 for numbers that will be five digits long.
 - g) For **Scope of the Counter**, choose either **Reset per Project** to restart the document counter for each Project or **System wide Counter** to use the same counter for every document.
 - h) Repeat for other document types as desired.
 - i) Click **Save** to make the changes.
- 4. For Templates, to use custom autonaming with Projects and documents based on a Template, click Admin > Project Management > Templates.**
- a) Click the name of the Template to change.
 - b) Click **Configure**.
 - c) Click **Project Creation** or **Document Creation**.
 - d) For Projects, make sure **Use Automatic Naming** is selected, and then click **Use Custom Automatic Naming**. Configure the options as described above in step 2. For documents, for the desired document type, change the **Automatic Document Naming** drop-down list box to **Custom**. Configure the options as described above in step 3 and repeat for other document types as desired.
 - e) Click **Save** to make the changes.

5. Log out of WebCenter and close your Web browser.

Using Spot Colors in PDF files

You can configure PDF Outputs to use spot colors for the line color definitions instead of using plotting style information. To make this change, it is best to copy an existing PDF Output to a new one in Defaults and change its name, and then modify the new entry.

On the Device Type tab of the Output, click the Browse control at the end of the Tuning Filename field and navigate to the Tuning Files folder in the Shared Defaults Project. C

1. Launch ArtiosCAD Enterprise and log in as a member of the ADMINS group.
2. Click **Options > Defaults**.
3. In Shared Defaults, copy an existing PDF Output to an entry with a different name, such as Plot to PDF using spot colors.
4. Double-click the new entry and click the **Device** tab.
5. Click ... (Browse) at the end of the Tuning Filename field.
 - a) In the Project pane of the browser, navigate to the Shared Defaults Project and expand it.
 - b) Click the **Tuning Files** folder.
 - c) Change the filetype selector to **All files (*.*)**.
 - d) Click Tune.PDF.SpotColors.xml and then click **Open**. The entry in the Tuning Filename field should change accordingly.

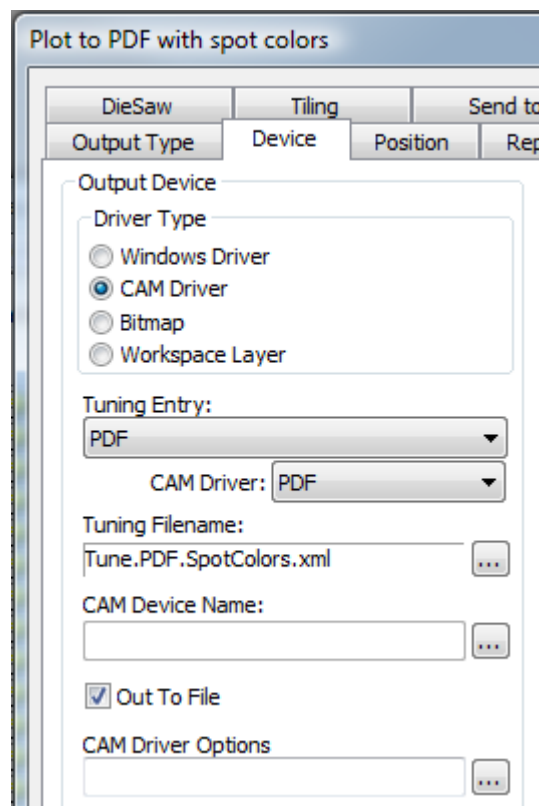

6. Click **OK** to make the change.

7. Click **File > Exit** and click **Yes** when asked to save and then overwrite the Defaults.

Shown below are the Ink Manager palettes for two PDF versions of the same single design, one using the default method and the other using the spot colors method.

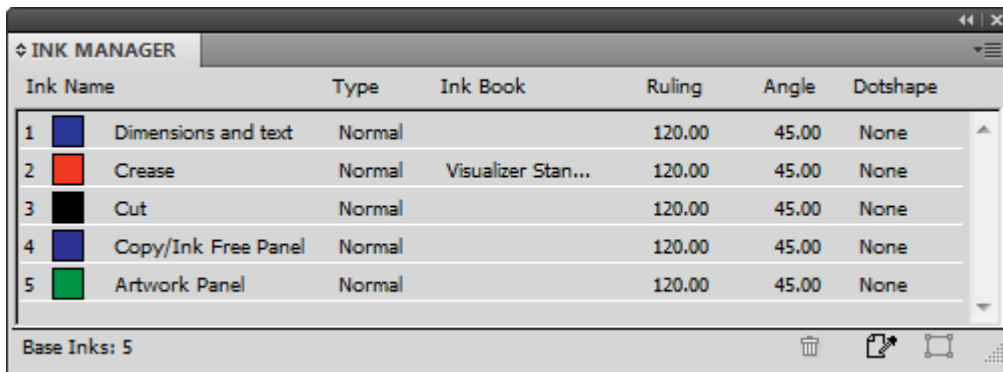
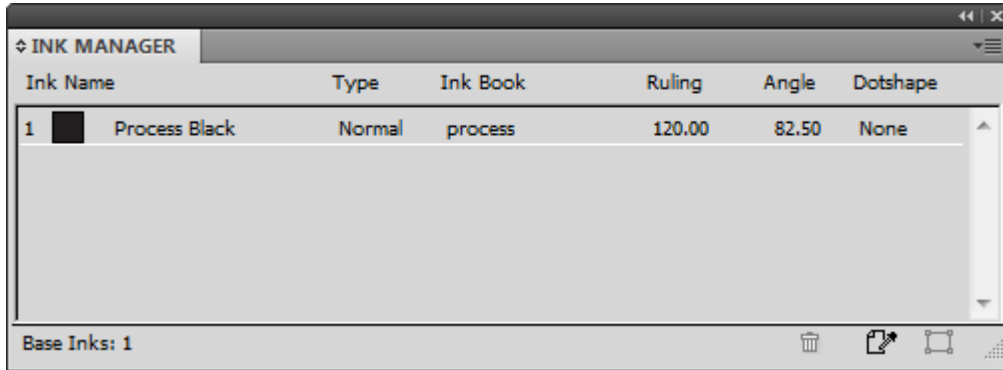

To change the ink names, RGB color values, stroke widths or stroke styles used by this method, make the changes in PDFSpotColorMap.xml.

Exporting Defaults

You can export Defaults to send them to Esko for help, to use them at another site, or for backup.

1. Click **Options > Defaults**.
2. Click **File > Export to ZIP File**.
3. Choose how to export them.
 - a) **With Folders** is meant for use at another site or as backup.
 - b) **Without Folders** is meant for use by Esko for diagnostic purposes.
4. Click the level of Defaults to export - **Shared, Location, or User**.
5. In the Save As dialog box, choose a folder and enter a filename for the ZIP archive, then click **Save**.
6. ArtiosCAD Enterprise saves the ZIP archive. If there are many Defaults, it displays a progress bar.

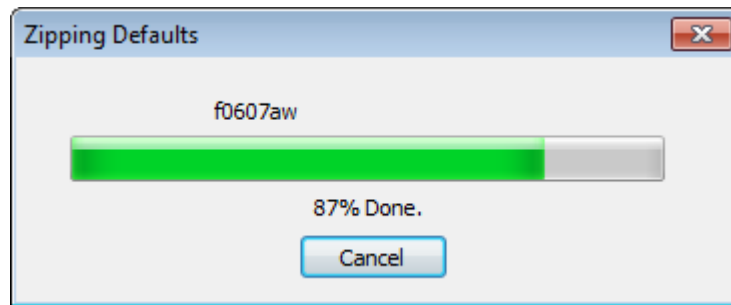

Migrating from ArtiosCAD Standard Edition to ArtiosCAD Enterprise

ArtiosCAD Enterprise has a tool that migrates information and documents from your existing ArtiosCAD Standard Edition installation into ArtiosCAD Enterprise. The migration tool analyzes the ArtiosCAD Standard Edition database and compares it to the WebCenter database. Data that already matches is not migrated.

Using the migration tool requires that both ArtiosCAD Standard Edition and an ArtiosCAD Enterprise client be installed on the same computer.

There are two parts to the migration:

- entity migration, which is metadata such as boards, companies, persons, characteristics, and userfields
- asset migration, which are the design documents themselves.

You must do the entity migration before the asset migration so that the migration tool creates the documents and Projects in WebCenter with the correct data. The tool has many configuration options for how it creates new Projects in WebCenter.

Migration can be complicated and it takes a fair amount of time. You should have a thorough understanding of how your current ArtiosCAD Standard Edition database is set up and if you want to preserve that same structure in WebCenter and thus ArtiosCAD Enterprise.

Before You Begin

Before you begin the process of migrating from ArtiosCAD Standard Edition to ArtiosCAD Enterprise, there are some considerations you should address beforehand.

- Username strategy. The migration tool will create WebCenter/ArtiosCAD Enterprise users from persons defined in the ArtiosCAD Standard Edition database. Decide upon a username creation convention. If the ArtiosCAD persons are real network users, use the WebCenter LDAP migration utility beforehand so that they can use their network credentials to log in.
- Suffix strategy. In several places you can specify suffixes that are appended to newly created items in case they conflict with existing items. Decide on suffixes to use. You can create different suffixes per migration run and/or set of saved location mapping if desired.

- Migration ADMINS user. A WebCenter/ArtiosCAD Enterprise user who is a member of ADMINS is the user who performs the migration. This user may also potentially be the Project manager for thousands of migrated Projects and owner of thousands of documents. This user must have a location assigned and the mapping for that location must be saved to the server so that the automatic conversions function properly. It is a good idea to create a separate ADMINS user for the migration.
- Attributes creation. The migration tool migrates a lot of metadata from ArtiosCAD Standard Edition into WebCenter Attributes. For this to work, the Attributes must already exist in WebCenter before you start the migration tool. Refer to the sections on migrating entities, characteristics, and userfields for more information.
- Attributes setup. For unmanaged files to work correctly when uploaded to WebCenter/ArtiosCAD Enterprise, the Default Attribute Categories set in ArtiosCAD Enterprise (**Options > Defaults > Database Defaults > Default Attribute Categories**) need to match those set on the Design Data tab of the migration tool and in WebCenter. In WebCenter as a member of ADMINS, click **Admin > Preferences > Document Types** and make sure that **Apply Default Attribute Categories to Documents in Blank Projects** is checked and that the entries in the Default Attribute Category column are set correctly.
- Tidy existing data. Before you begin the migration, clean up the ArtiosCAD Standard Edition database using DataCenter Admin. For example, delete unused companies and boards. Do an AutoLoad to make sure all the information in the design documents is in the database.

There are also several restrictions of which you should be aware.

- The calculated area userfield in ArtiosCAD Enterprise may show incorrectly when using metric units due to a conversion factor discrepancy. When comparing results after migration, the ArtiosCAD Enterprise value might be 100 times larger than the correct value shown in WebCenter.
- The calculated weight userfield using the #BRDWTG system variable shows the same value in Imperial and metric units. It is correct in WebCenter.
- If you used an old migration tool before this one, calculated expressions may have been migrated to prompted Attributes. If you want them to become calculated again, delete these prompted Attributes before performing the migration and the migration tool will create them properly.

Customizing the Migration Tuning File

Before you perform a migration, you should determine if you need to customize how the migration tool works. The migration tool uses an XML tuning file to store its configurable parameters. That file is located in \$ARTIOSDIR\Migration, and is called ECADMigrationTuning.xml. An XML file is a text file that can be edited in any text editor.

```

1  <?xml version="1.0"?>
2  <!--
3  ECAD Migration Tuning File
4  -->
5
6  <MIGRATION_TUNING>
7
8  <DEFAULT_WEBCENTER_URL>http://WebServer/WebCenter_Inst</DEFAULT_WEBCENTER_URL>
9  <DEFAULT_WEBCENTER_USERNAME>admin</DEFAULT_WEBCENTER_USERNAME>
10
11 <LENGTH_COMPARISON_TOLERANCE_MM>0.005</LENGTH_COMPARISON_TOLERANCE_MM>
12 <WEIGHT_COMPARISON_TOLERANCE_MM>0.005</WEIGHT_COMPARISON_TOLERANCE_MM>
13 <BASIS_WEIGHT_COMPARISON_TOLERANCE_MM>1.0</BASIS_WEIGHT_COMPARISON_TOLERANCE_MM>
14
15 <FLUTE_MATCHING>
16 <MATCH_CONFIDENCE_PERCENT="100"/>
17 <ATTRIBUTE NAME="HEIGHT" PERCENT="5"/>
18 <ATTRIBUTE NAME="PITCH" PERCENT="5"/>
19 <ATTRIBUTE NAME="TAKEUPFACTOR" PERCENT="5"/>
20 </FLUTE_MATCHING>
21
22 <BOARD_MATCHING>
23 <MATCH_CONFIDENCE_PERCENT="100"/>
24 <ATTRIBUTE NAME="CAL" PERCENT="35"/>
25 <ATTRIBUTE NAME="IL" PERCENT="20"/>
26 <ATTRIBUTE NAME="OG" PERCENT="20"/>
27 <ATTRIBUTE NAME="FLUTE" PERCENT="1"/>
28 <ATTRIBUTE NAME="TESTCODE" PERCENT="1"/>
29 <ATTRIBUTE NAME="TESTVALUE" PERCENT="1"/>
30 <ATTRIBUTE NAME="ROUNDINGVALUE" PERCENT="1"/>

```

At the beginning of the file are fields for the default WebCenter site and username, as well as for the default tolerance for length comparisons, weight comparisons, and the basis weight comparison tolerance.

The contents are then divided into sections containing options for tuning different aspects of the program. Most of the entries control the relative importance of different fields when the migration tool compares values in the ArtiosCAD Standard Edition database with any values which may already exist in the WebCenter database. If it determines that the values do not match, the migration tool makes a new entry in the WebCenter database.

The Match Confidence entry controls how closely the values must correlate in order for the migration tool to consider them matching. A higher value means the migration tool creates more new entries in WebCenter. A lower value means the migration tool uses more existing values even if they do not exactly match.

Flute Matching

For flute matching, the migration tool compares case-insensitive flute codes.

Board Matching

For board matching, the migration tool compares case-insensitive board codes and board descriptions. When it finds a match, it further analyzes board parameters to generate the matching percentage. If there are collisions, the migration tool appends a suffix that you specify in the migration tool options. You must migrate flutes before you migrate boards.

Company Matching

For company matching, the migration tool has features to reduce database pollution from similar database entries, as companies are usually the type of entity with the most potential problems in a migration. The migration tool uses a custom fuzzy algorithm for company matching which:

- Uses synonym sets to replace synonyms found with a master token, such as replacing **&** and **+** in a company name with the word **and**.
- Splits the company name into tokens and converts tokens in to upper case for comparison.
- Strips ignorable tokens such as THE at the beginning of company names and CO, COMP, COMPANY, and so forth at the end of company names.

You can add or remove tokens as desired by adding or deleting data in the appropriate section of the tuning file. For token separators, add to or remove from the current XML entry between the quotation marks. For synonyms, add or remove SYNONYM groups. For ignored tokens, add or remove the appropriate line. If you add an entry, make sure to use the same exact format as an existing entry.

Starting the Migration Utility

1. Select a computer that has both ArtiosCAD Standard Edition and an ArtiosCAD Enterprise client installed.
2. In the ArtiosCAD subfolder of the Esko folder on the Start menu, click **ArtiosCAD Enterprise <version> Migration**.
3. In the Migration Login to WebCenter dialog box, enter the login information for your WebCenter server. You must log in as a member of the WebCenter ADMINS group. This user must also have a location assigned in WebCenter so that future automatic conversion of design data works correctly. Depending on the options you set in the migration tool, the user whom you log in as will become Project Manager for certain migrated Projects and documents, so choose this user carefully. Click **OK**.

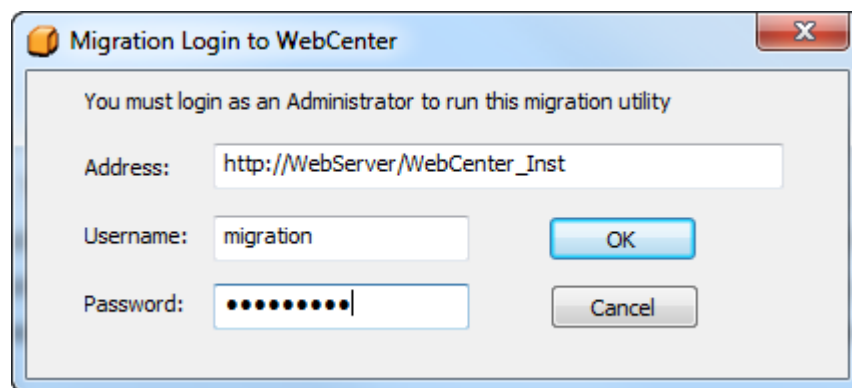

You can change the default values for the Address and Username in the migration tuning file.

4. The migration tool appears after it initializes its entity cache. For your convenience, it always shows the connected server and logged-in user at the bottom of the frame.

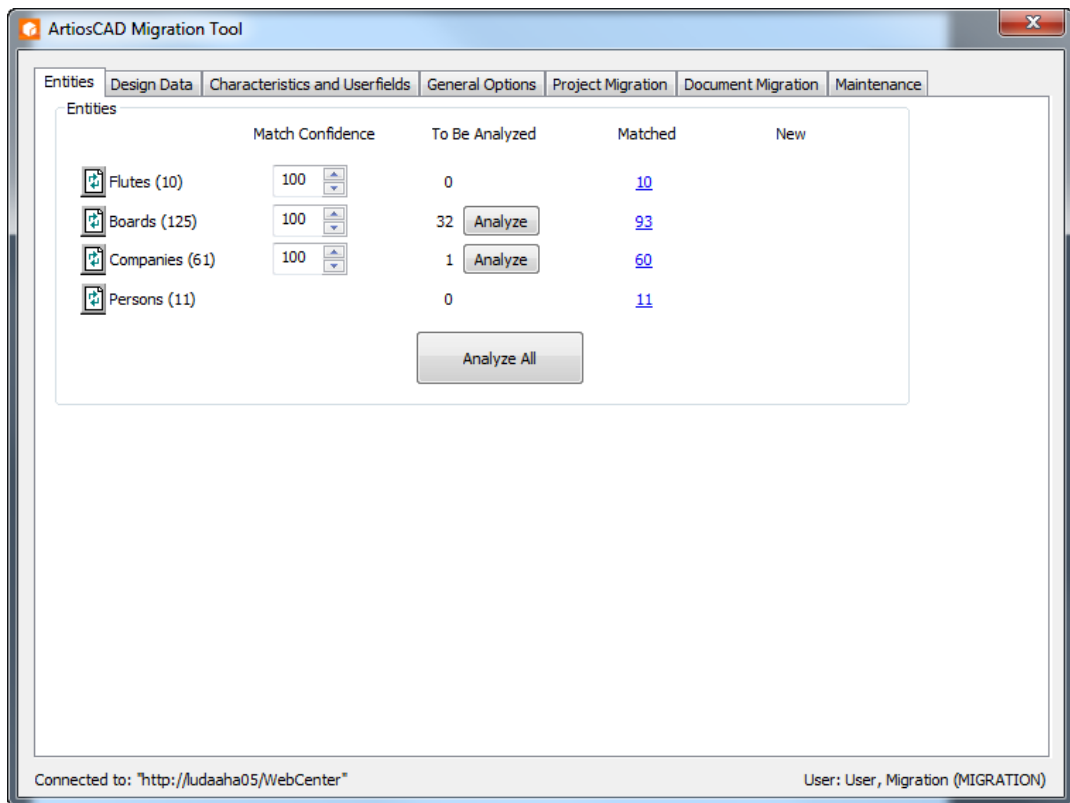

Migrating Entities

The migration tool starts and analyzes the existing ArtiosCAD Standard Edition database. It then displays the Entities tab.

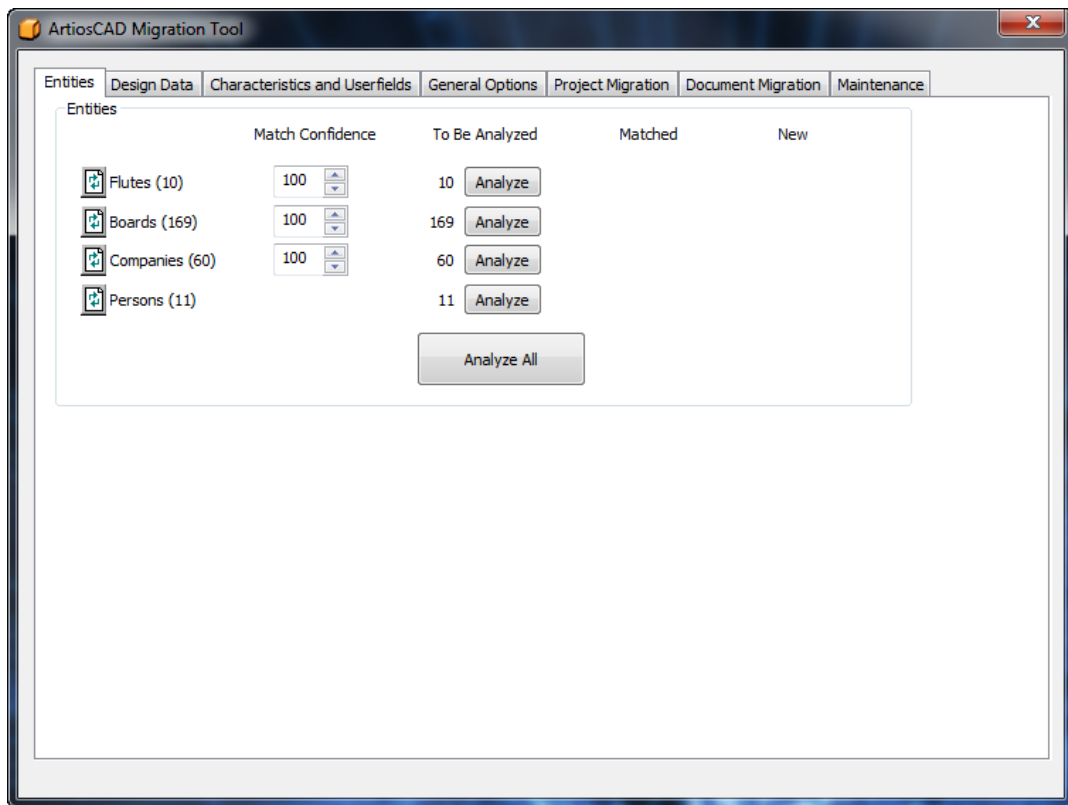

The goal of this part of the migration process is to match all the entities between the ArtiosCAD Standard Edition database and the WebCenter database. Each migration attempt is uniquely tied to a particular combination of ArtiosCAD database ID and destination WebCenter server name. In this way you can migrate data between varying databases.

The migration tool handles four types of entities:

- Flutes
- Boards
- Companies. The migration tool performs extra analysis on companies to reduce similar database entries.
- Persons

Clicking **Analyze** activates the matching process per entity type, or you can match them all together by clicking **Analyze All**. If you use **Analyze All**, you still need to review the matched and new entities individually by type.

When entities match, the migration tool creates a persistent mapping between the ArtiosCAD Standard Edition metadata and the WebCenter metadata, and displays the number of matches in the **Matched** column. The migration tool saves the mapping when you exit it so that you do not have to reanalyze the entities the next time you start the tool.



The **Reset** button resets the mapping for the entity type and rereads both databases. Use this when other people make changes to either database while the migration tool is running.

Match Confidence controls how closely entities in both databases must match in order for the entity in the ArtiosCAD Standard Edition database to not be considered a new entity to be inserted into the WebCenter database. A higher number means they must match more closely to not be considered new. One hundred means they must match exactly to not be considered new.

When an entity in the ArtiosCAD Standard Edition database does not match one in the WebCenter database, it appears in the **New** column.

To match entities individually, click **Analyze** in the row of the desired entity. After a moment, there should be numbers in the **Matched** and **New** columns. These numbers are links that open additional dialog boxes.

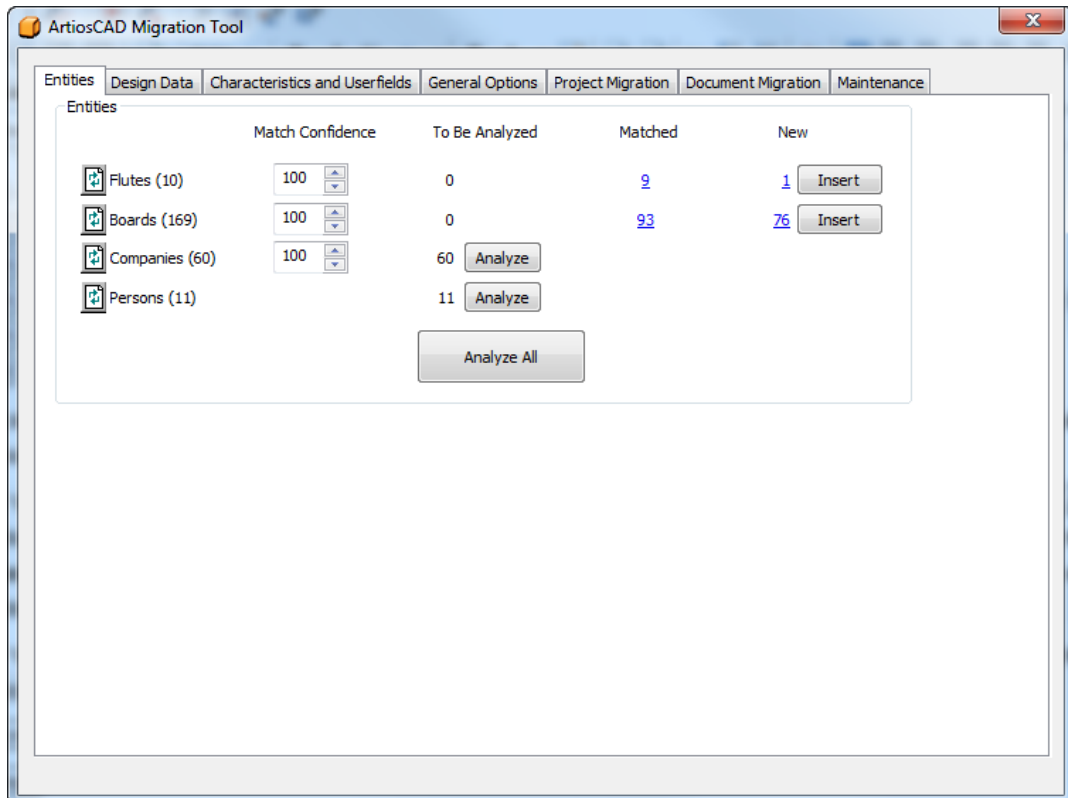

Migrating Flutes

The flute migration compares case-insensitive flute codes. Once you have analyzed the flutes to migrate, you can see which entities have been matched and which will be inserted into the WebCenter database.

1. Analyze the flutes to match.

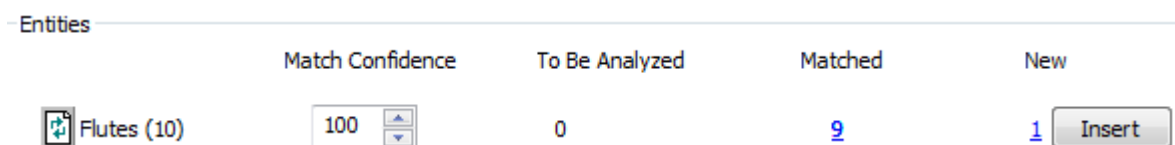

2. Click the underlined blue number in the **Matched** column to open the Entities Matched dialog box.

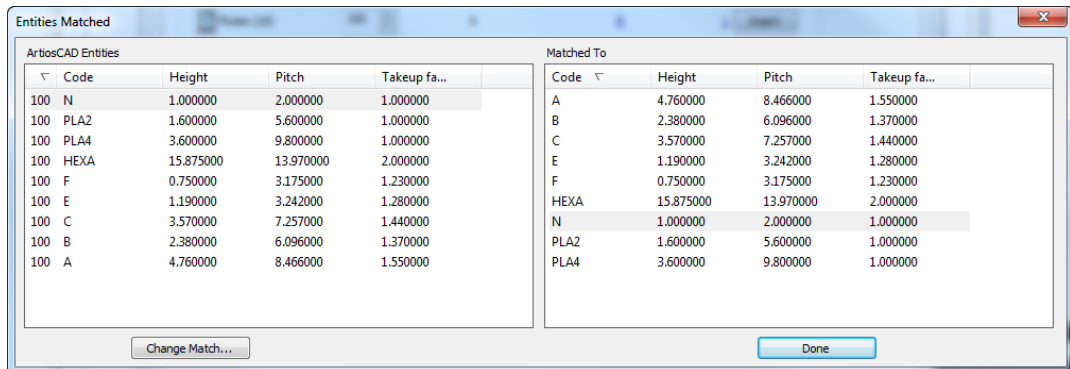

3. In the Entities Matched dialog box, the left pane is sorted by match percentage, while the right pane is sorted by code. Matching entities are shaded.
 - a) To change a match, select an entity in the left pane and click **Change Match**.

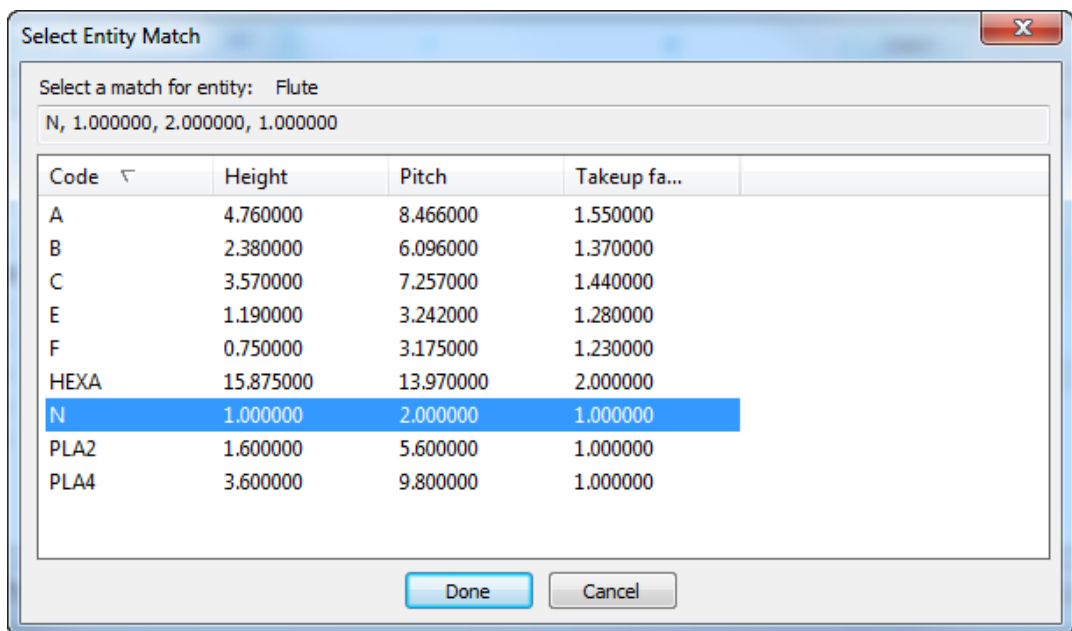

- b) The ArtiosCAD database entry is shown at the top of the dialog box. Click a new match from the list and click **Done**.
4. Back in the Entities Matched dialog box, review the other flute matches and change them as desired.
 5. Click **Done** to return to the migration tool.
 6. Click the underlined blue number in the **New** column to open the New Entities To Be Inserted dialog box.

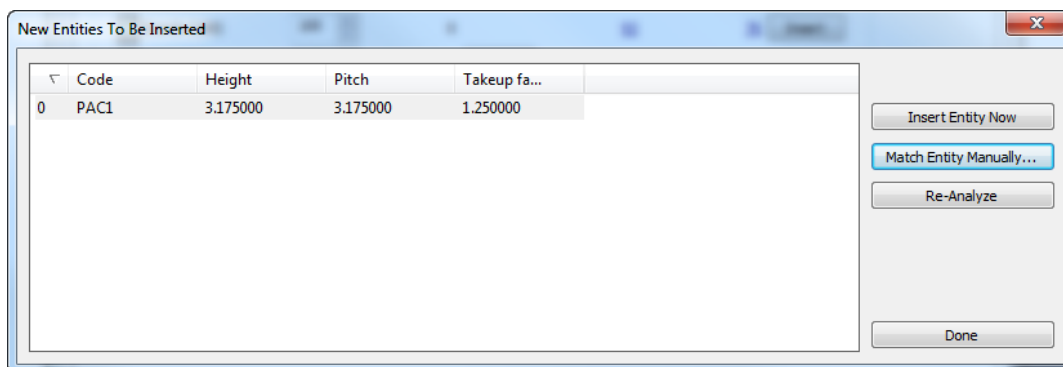

- a) If a new entity is not truly new and should be matched to an existing entity, select it and click **Match Entity Manually**.

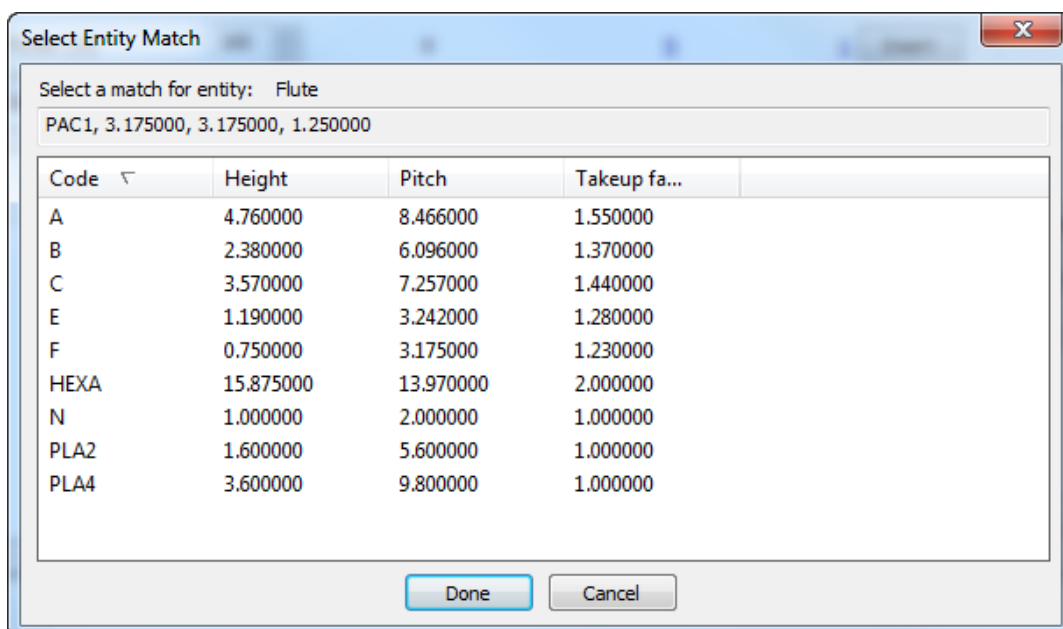

- b) Select the matching flute and click **Done** to return to the New Entities To Be Inserted dialog box.
- c) To insert this one entity into the WebCenter database, click **Insert Entity Now**.
- d) To reanalyze the flute entities in case there have been changes, click **Re-Analyze**.
- e) Click **Done** to return to the migration tool.
7. Now you are ready to migrate the flute entities. Click **Insert** in the Flutes row.
8. After a few moments, the migration tool will update the number in the Matched column, and the number in the New column and the **Insert** button will disappear.

Migrating Boards

The migration tool compares case-insensitive board codes and board descriptions. When it finds a match, it compares more attributes of the boards to calculate a matching percentage.

Note: You must migrate flutes before you migrate boards.

The process of migrating boards is similar to that of migrating flutes. Analyze the databases, review matches, change mappings if desired, and insert non-matching entities into the WebCenter database.

1. Analyze the boards to match.



2. Click the underlined blue number in the **Matched** column to open the Entities Matched dialog box.

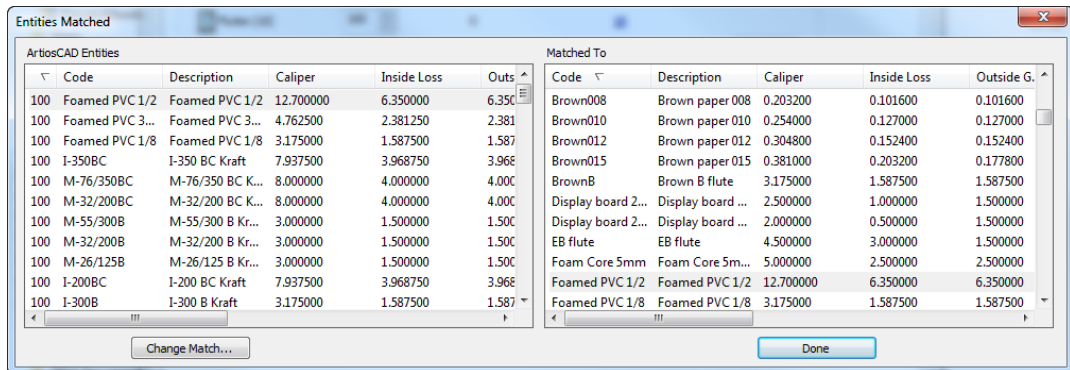

3. In the Entities Matched dialog box, the left pane is sorted by match percentage, while the right pane is sorted by code. Matching entities are shaded.

- a) To change a match, select an entity in the left pane and click **Change Match**.

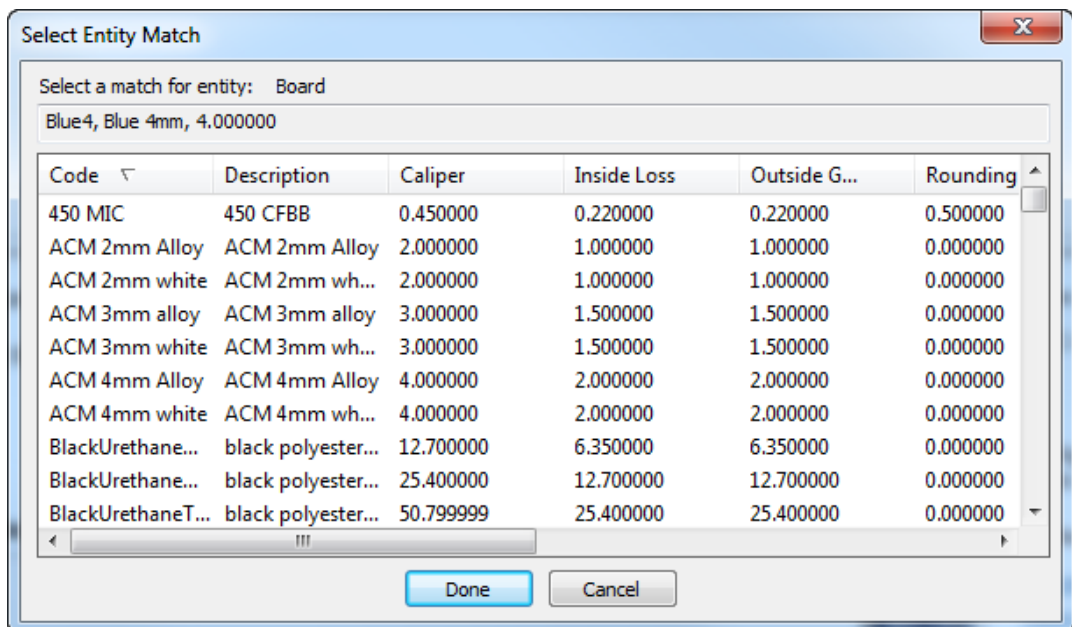

- b) The ArtiosCAD database entry is shown at the top of the dialog box. Click a new match from the list and click **Done**.

4. Back in the Entities Matched dialog box, review the other board matches and change them as desired.
5. Click **Done** to return to the migration tool.
6. Click the underlined blue number in the **New** column to open the New Entities To Be Inserted dialog box.

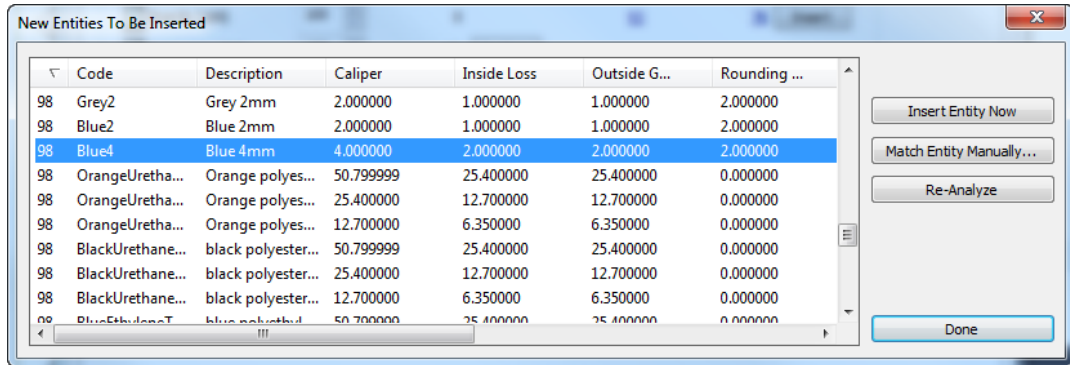

- a) If a new entity is not truly new and should be matched to an existing entity, select it and click **Match Entity Manually**.

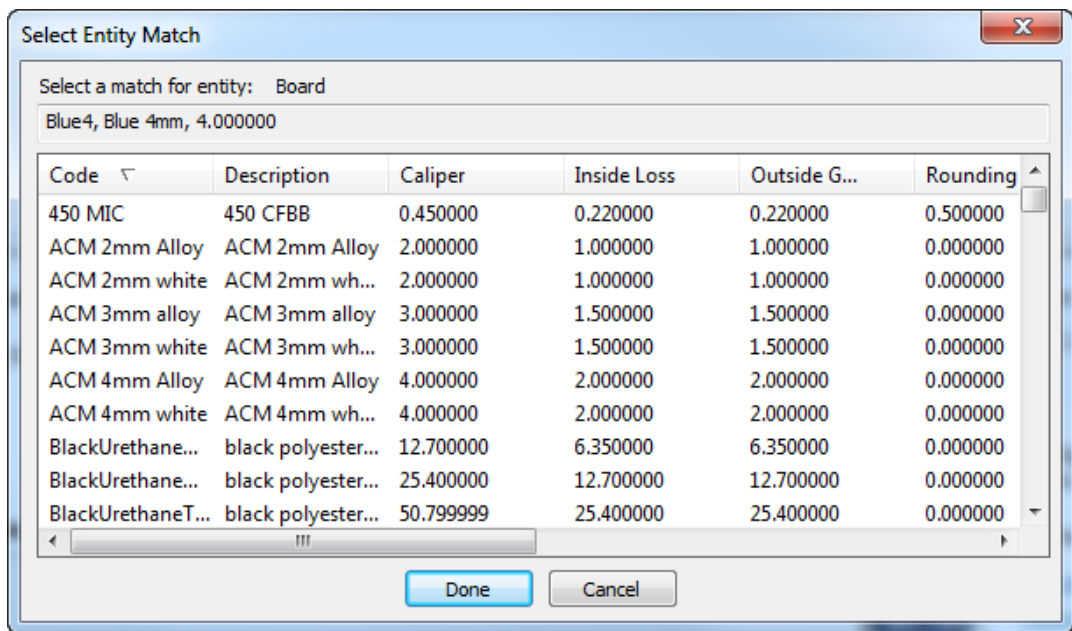

- b) Select the matching board and click **Done** to return to the New Entities To Be Inserted dialog box.
 - c) To insert this one entity into the WebCenter database, click **Insert Entity Now**.
 - d) To reanalyze the board entities in case there have been changes, click **Re-Analyze**.
 - e) Click **Done** to return to the migration tool.
7. Click **Insert** to insert the new entities into the WebCenter database.

Migrating Companies

Migrating companies is a little more complicated than migrating flutes and boards. Companies are often the part of the database with the most duplicate entries. The migration tool performs extra analysis on the companies in the ArtiosCAD Standard Edition database to reduce the number of duplicates before it compares the two databases. The matches are between ArtiosCAD companies and WebCenter locations. If the WebCenter company already exists, then the migration tool adds the ArtiosCAD company as a new location to the WebCenter company.

1. Analyze the companies.

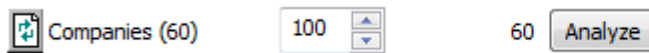

- a) If there are duplicates in the ArtiosCAD Standard Edition database, the migration tool will find them according to the settings in the migration tuning file. It then displays them in the Duplicate Companies Found dialog box.

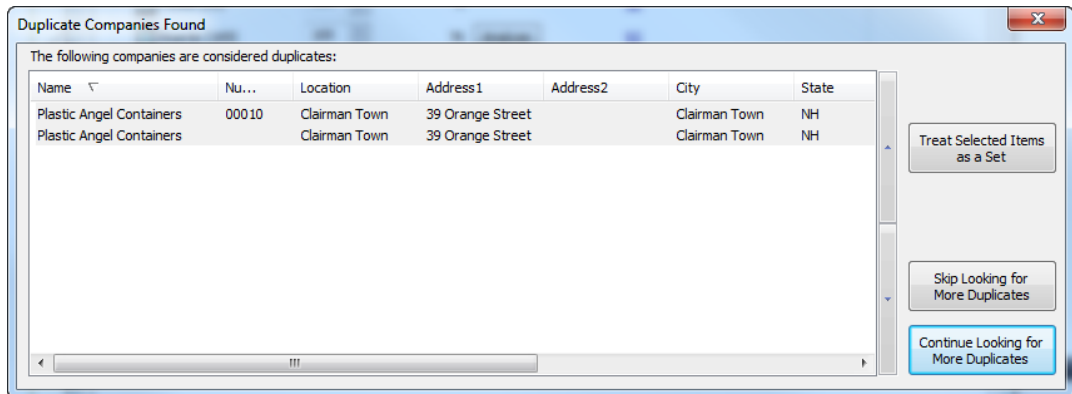

- b) **Treat Selected Items as a Set** causes the migration tool to insert the top entry into the WebCenter database and the other selected items will point to that mapping. Use the arrows at the side of the list to move the selected items up or down.
 - c) **Stop Looking for More Duplicates** and **Continue Looking for More Duplicates** do what they say.
 - d) If you click **Treat Selected Items as a Set** or **Continue Looking for More Duplicates**, the tool continues searching for duplicates and prompts you to resolve any that it finds.
2. When the migration tool finds no more duplicates, or you choose to stop looking for more duplicates, it does a normal comparison between the revised sets of companies in the two databases.



3. Click the underlined blue number in the **Matched** column to open the Entities Matched dialog box.

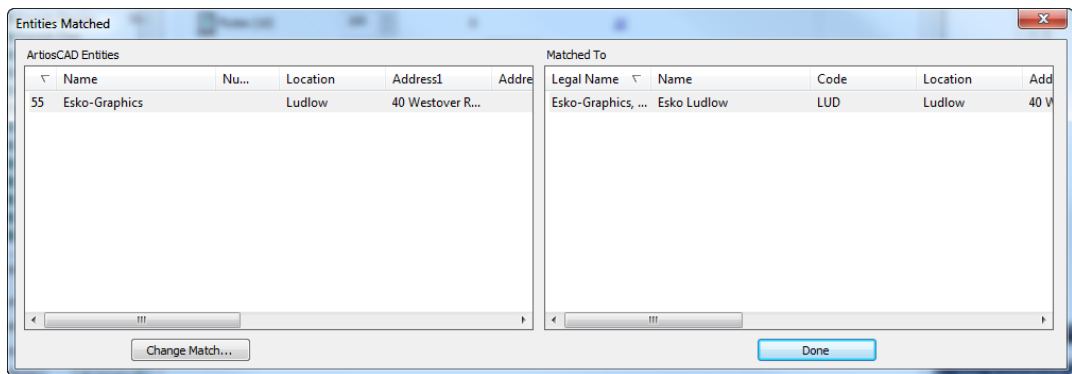

4. In the Entities Matched dialog box, the left pane is sorted by match percentage, while the right pane is sorted by legal name. Matching entities are shaded.
 - a) To change a match, select an entity in the left pane and click **Change Match**.

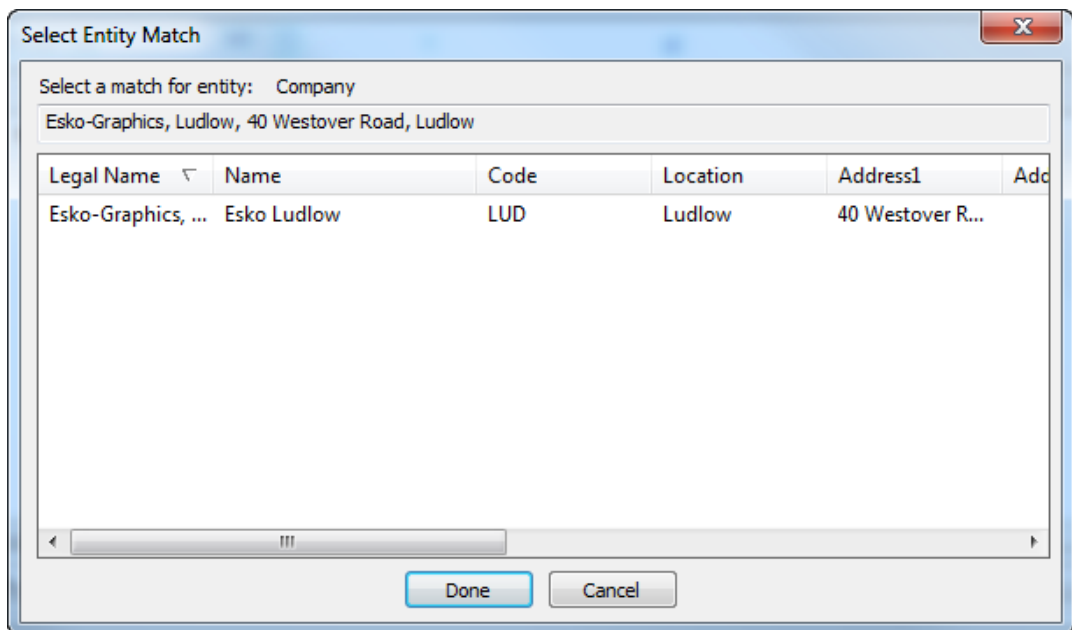

- b) The ArtiosCAD database entry is shown at the top of the dialog box. Click a new match from the list and click **Done**.
5. Back in the Entities Matched dialog box, review the other company matches and change them as desired.
6. Click the underlined blue number in the **New** column to open the New Entities To Be Inserted dialog box.

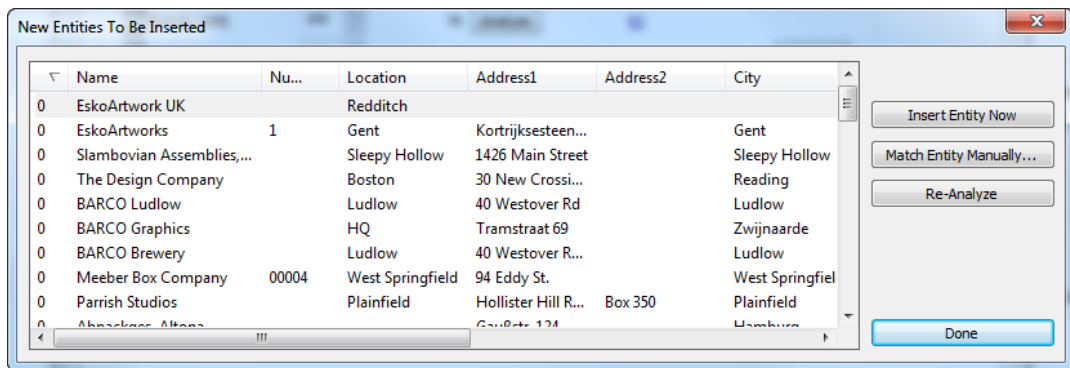

- a) If a new entity is not truly new and should be matched to an existing entity, select it and click **Match Entity Manually**.

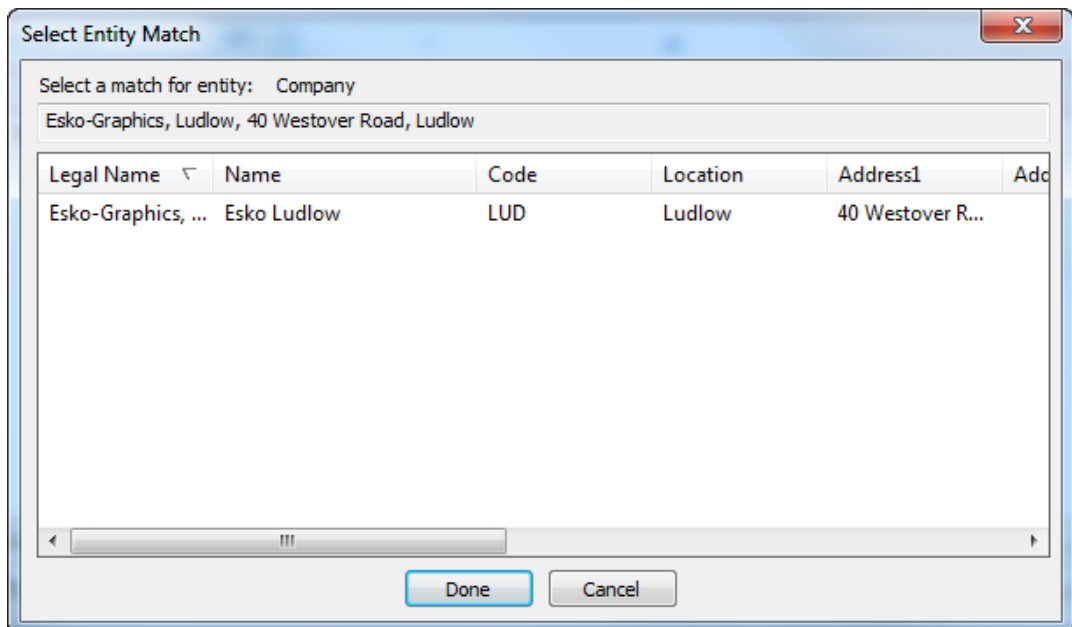

- b) Select the matching company and click **Done** to return to the New Entities To Be Inserted dialog box.
 - c) To insert this one entity into the WebCenter database, click **Insert Entity Now**.
 - d) To reanalyze the company entities in case there have been changes, click **Re-Analyze**.
 - e) Click **Done** to return to the migration tool.
7. Click **Insert** to insert the new entities into the WebCenter database.

Migrating Persons

The migration tool migrates ArtiosCAD Standard Edition database persons to WebCenter users. The migration tool case-insensitively compares first names and last names. When it finds a match, the tool uses this mapping.

If the ArtiosCAD persons are real network users, use the WebCenter LDAP migration utility beforehand so that they can use their network credentials to log in.

Note: You must migrate all companies before migrating persons.

1. Analyze the persons to match.



2. Click the underlined blue number in the **Matched** column to open the Entities Matched dialog box.

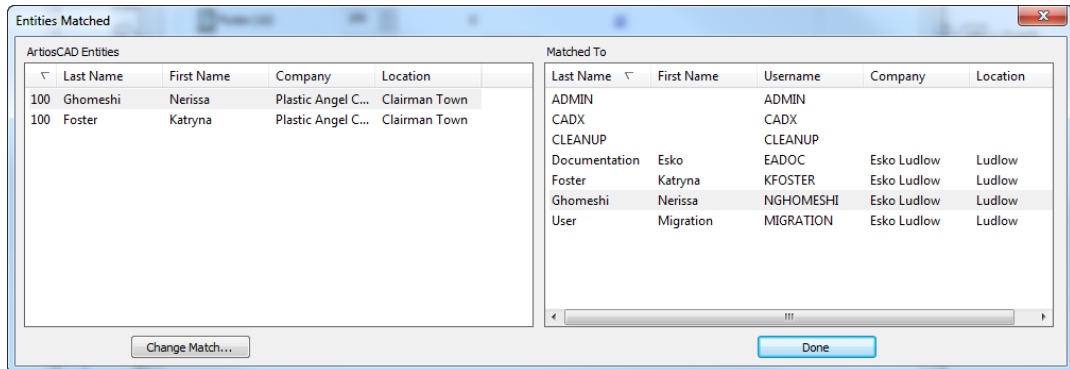

3. In the Entities Matched dialog box, both panes are sorted by last name. Matching entities are shaded.
 - a) To change a match, select an entity in the left pane and click **Change Match**.

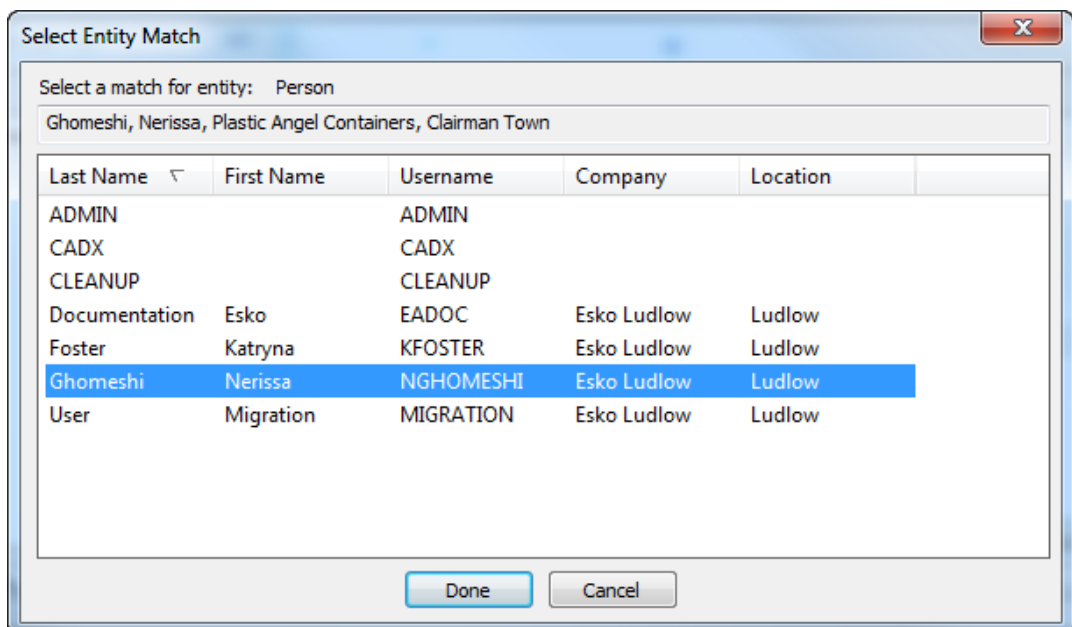

- b) The ArtiosCAD database entry is shown at the top of the dialog box. Click a new match from the list and click **Done**.

4. Back in the Entities Matched dialog box, review the other person matches and change them as desired.
5. Click **Done** to return to the migration tool.
6. Click the underlined blue number in the **New** column to open the New Entities To Be Inserted dialog box.

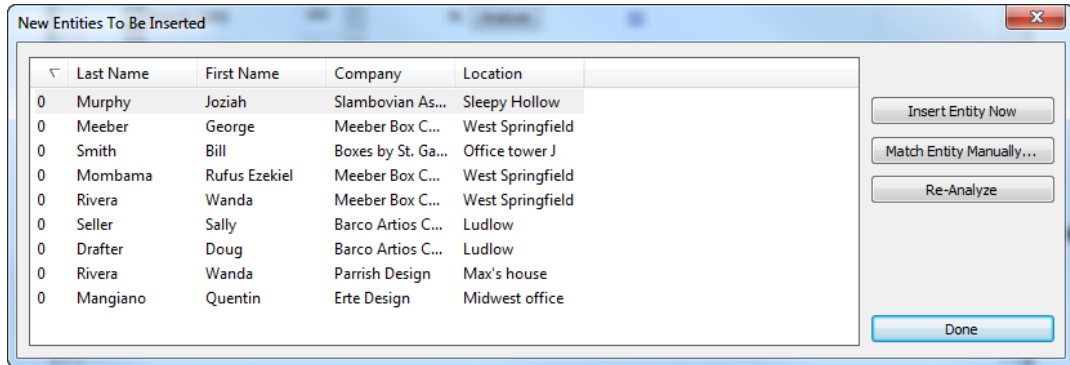

- a) If a new entity is not truly new and should be matched to an existing entity, select it and click **Match Entity Manually**.

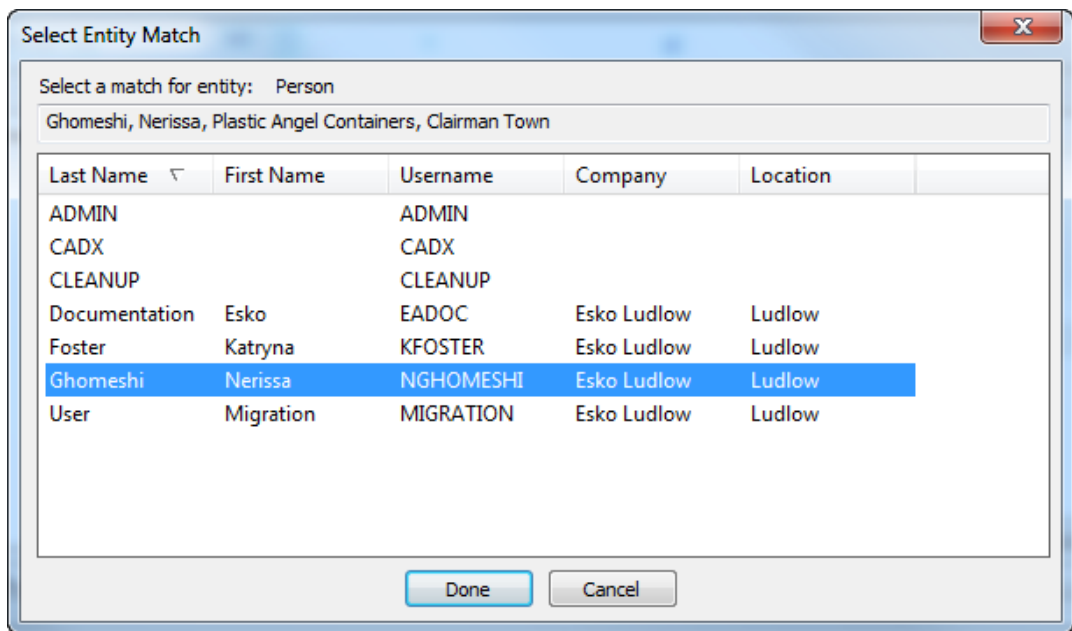

- b) Select the matching person and click **Done** to return to the New Entities To Be Inserted dialog box.
- c) To insert this one entity into the WebCenter database, click **Insert Entity Now**.
- d) To reanalyze the person entities in case there have been changes, click **Re-Analyze**.
- e) Click **Done** to return to the migration tool.
7. Now you are ready to start migrating the persons. Click **Insert** in the Persons row.
8. The Insert Persons as Users dialog box appears.

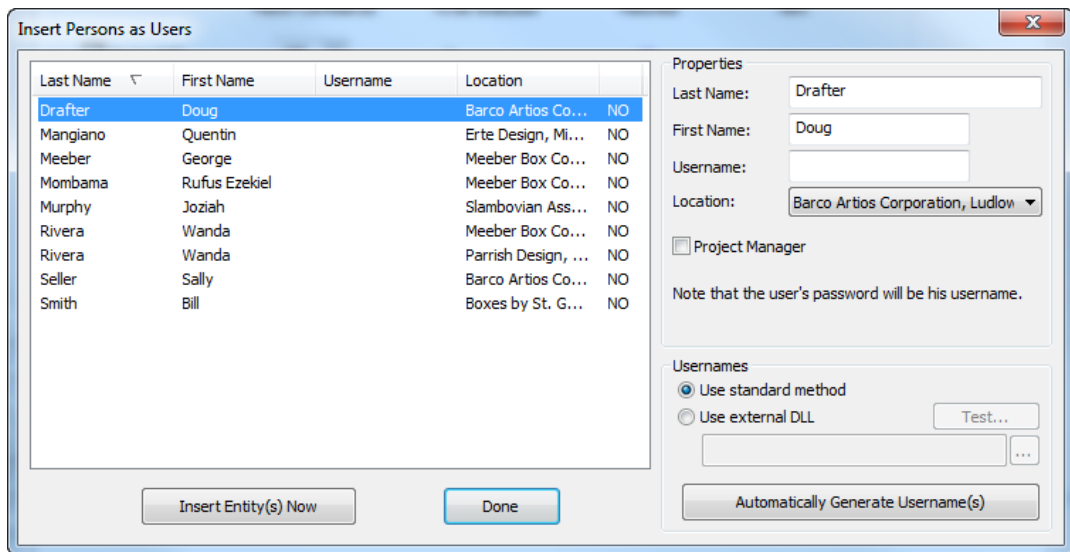

Hold down CTRL and click users to select more than one user.

- a) In the Properties pane, enter the first name, last name, username, and location for the selected person. You can also choose to make the selected person a Project manager in WebCenter - able to create new Projects. The initial password for the user is the same as the username. To change the Project manager status of many new users at once, select them and set the checkbox as desired.
- b) In the Usernames pane, you can have the migration tool automatically create usernames for the selected users. **Use standard method** causes **Automatically Generate Username(s)** to create a username for the selected person(s) out of the first letter of the first name and the entire last name, all in upper case. For example, the automatic username for the user in the example above would be DDRAFTER. The username is case-insensitive when logging in, but the password is case-sensitive, so the user could log in as DDRAFTER or ddrafter, but he would always have to enter his password as DDRAFTER until he changed it.
- c) Also in the Usernames pane, **Use external DLL** allows a custom dynamically linked library (DLL) to create the usernames for the selected users when you click **Automatically Generate Username(s)**. Your IT department or an Esko solution architect would create the custom DLL. Below is a short functional prototype as an example, along with the parameters for the DLL.

```

short GetUsername(const char * lastname, const char * firstname,
                 const char* companyname,
                 char* usernameRet, int usernameBufLen)

Parameters:
const char* lastname - the user's last name
const char* firstname - the user's first name
const char* companyname - the user's company name
char* usernameRet - (out) - the returned username - must be NULL terminated
int usernameBufLen - the length (int chars) of the usernameRet buffer

Returns:
1 - for success
    
```

9. To insert the selected users into the database, click **Insert Entity(s) Now**. Unlike other entities, this is the only way to insert users into the WebCenter database.

10. Click **Done** to return to the migration tool.

11. The migration tool will update the number in the Matched column, and the number in the New column and the **Insert** button will disappear.

Configuring Design Data Migration

The next step in the migration is to configure how the design metadata from the designs migrates into WebCenter as Attributes. ArtiosCAD Enterprise and WebCenter also use this mapping any time you upload an unmanaged document to WebCenter.

However, there are some prerequisites that you must make sure have been satisfied before you begin this phase.

1. WebCenter must already contain the Attributes that will receive the data coming out of the ArtiosCAD Standard Edition database.
 2. Once the Attributes exist, assign them to the default Attribute Categories that you will use for the migrated Projects and documents.
 3. You must have migrated all the entities on the Entities tab before beginning the design data migration.
1. In the migration utility, click the **Design Data** tab.

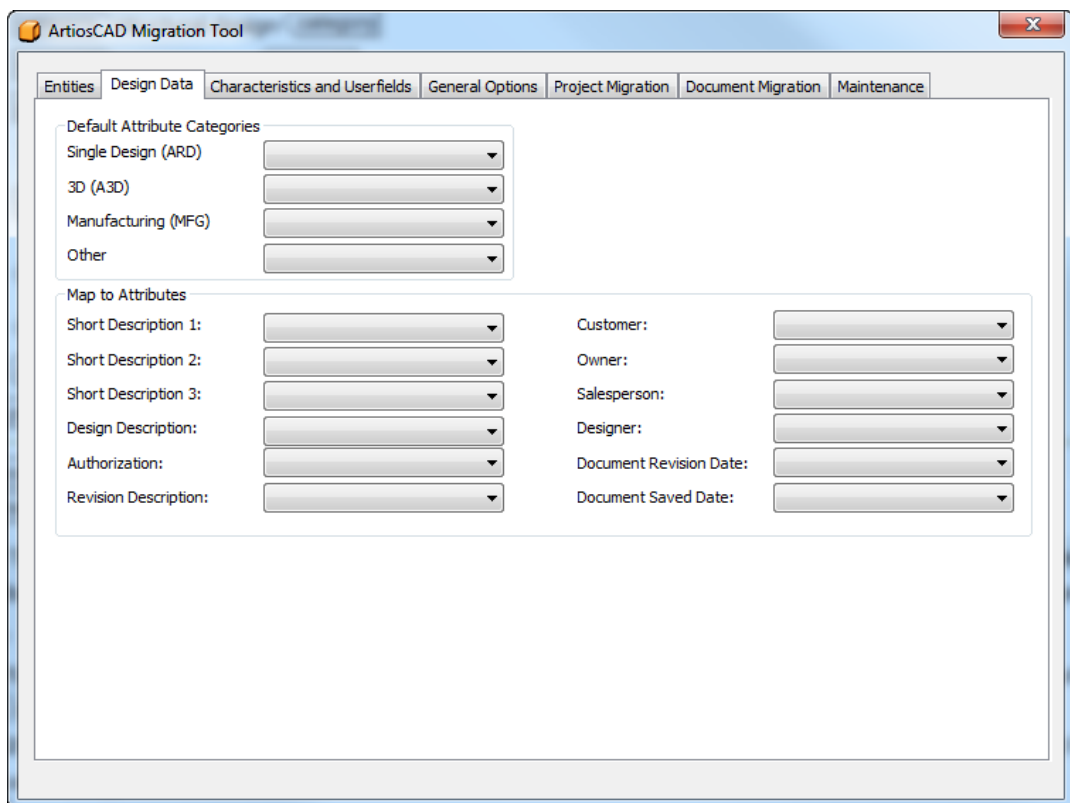

2. Assign values in the drop-down list boxes in the Default Attribute Categories and Map to Attributes groups. In the example below, all the Attributes were created with the same names in WebCenter as the corresponding fields in ArtiosCAD.

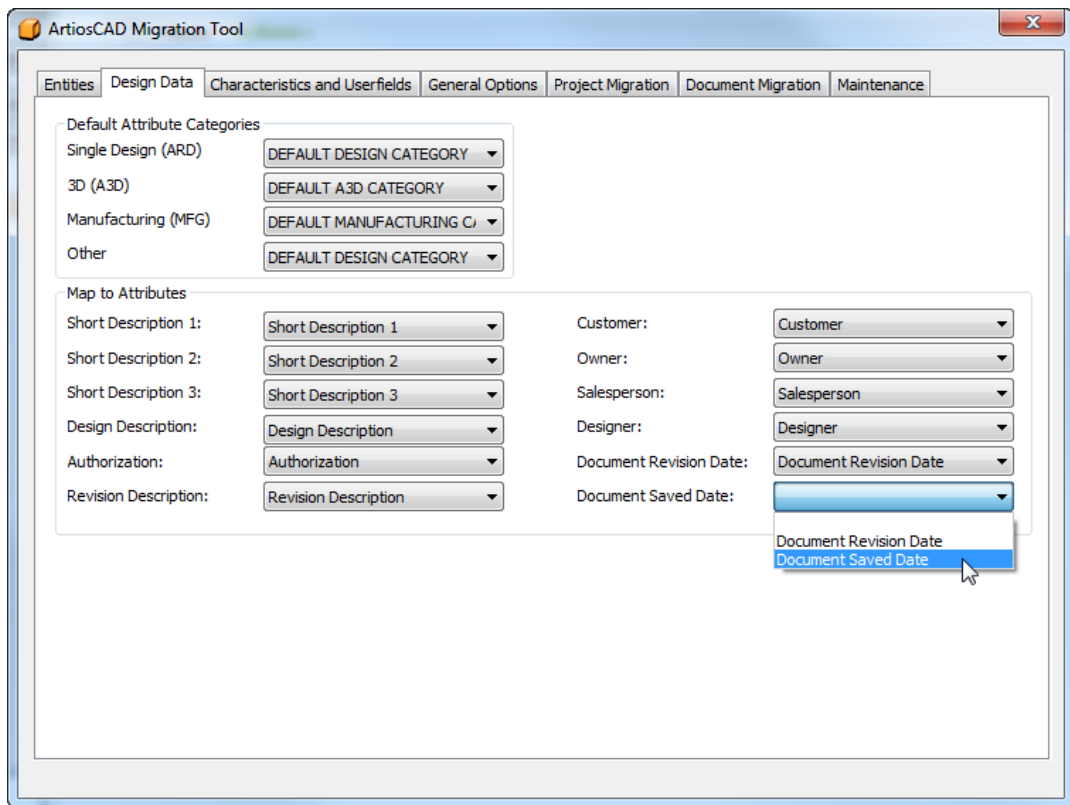

Migrating Characteristics and Userfields

The next step of the migration is to analyze the characteristics, restricted sets, and userfields, and migrate them into the WebCenter database like the flute, board, company, and person entities were.

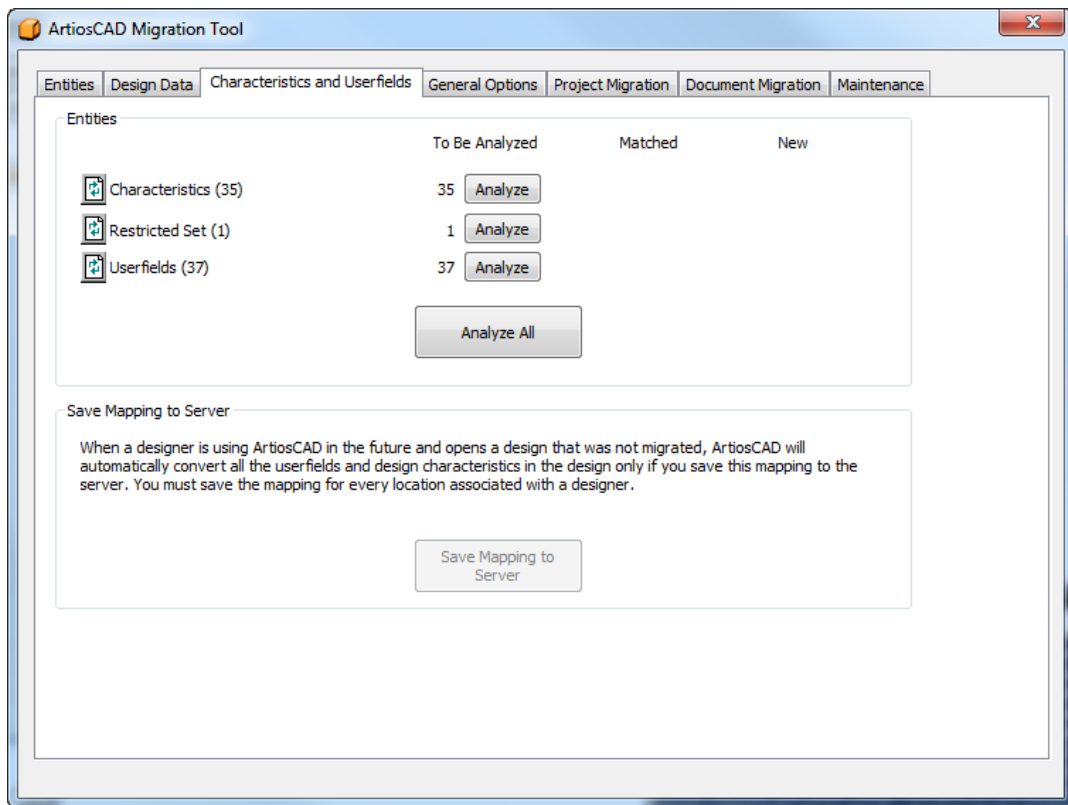

Save Mapping to Server becomes available after you have migrated the characteristics, restricted sets, and userfields.

Migrating Characteristics

The next step in the migration is to migrate the characteristics. The migration tool matches the ArtiosCAD characteristic description to the WebCenter characteristic name. It does not use the code because the same code can be used in multiple locations in the characteristic tree in the ArtiosCAD Standard Edition database.

1. Analyze the characteristics to match.



2. Click the underlined blue number in the **Matched** column to open the Entities Matched dialog box. This is only to see the matches; you cannot change the matches for characteristics.

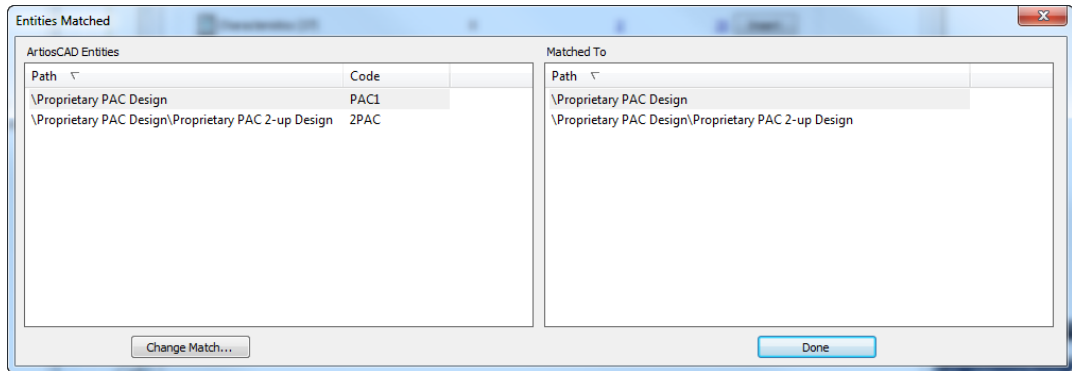

The Entities Matched dialog box sorts both panes by the paths in the characteristics trees and shades matching entities. Click **Done** to return to the migration tool.

3. Click the underlined blue number in the **New** column to open the New Entities To Be Inserted dialog box.

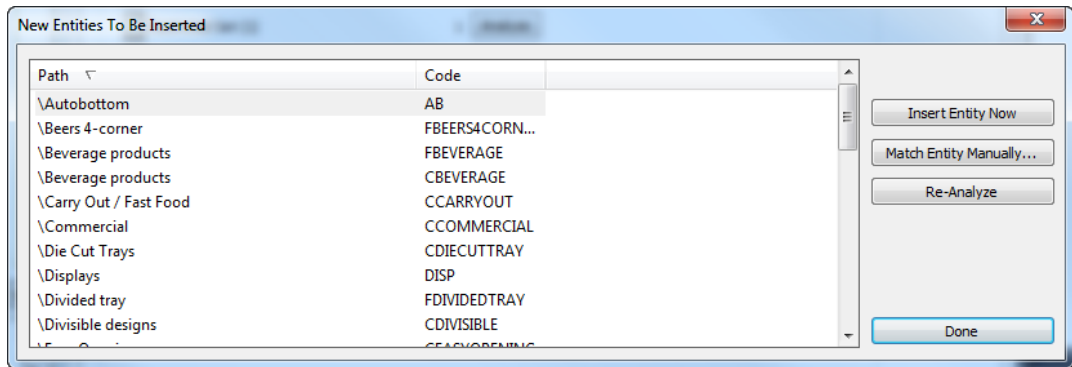

- a) Since you cannot match characteristics manually, do not click **Match Entity Manually**.
 - b) To insert the selected entity(s) into the WebCenter database, click **Insert Entity Now**.
 - c) To reanalyze the characteristics in case there have been changes, click **Re-Analyze**.
 - d) Click **Done** to return to the migration tool.
4. Now you are ready to start migrating the characteristics. Click **Insert** in the Characteristics row.
 5. A progress bar appears as the tool migrates the characteristics.

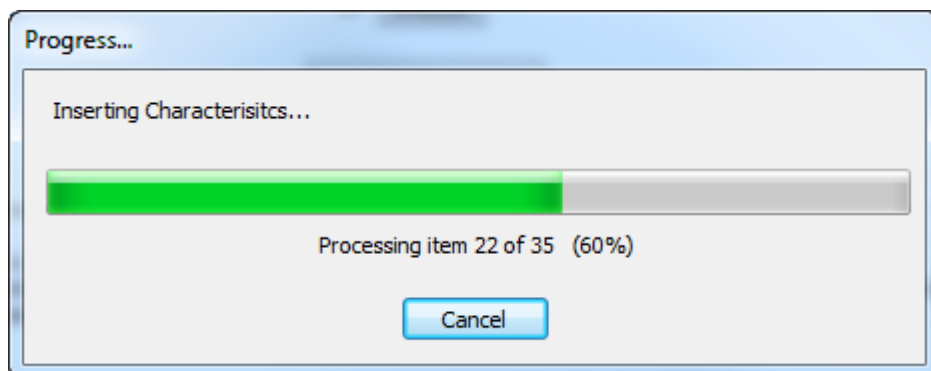

Migrating Restricted Sets

The next step in the migration is to migrate the restricted sets, which are userfields in ArtiosCAD and Attributes in WebCenter. The migration tool matches the restricted set name and unit type. It does not compare actual set values.

1. Analyze the restricted sets to match.

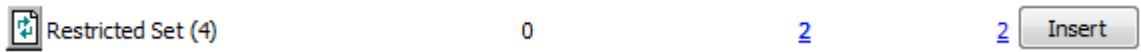

2. Click the underlined blue number in the **Matched** column to open the Entities Matched dialog box.

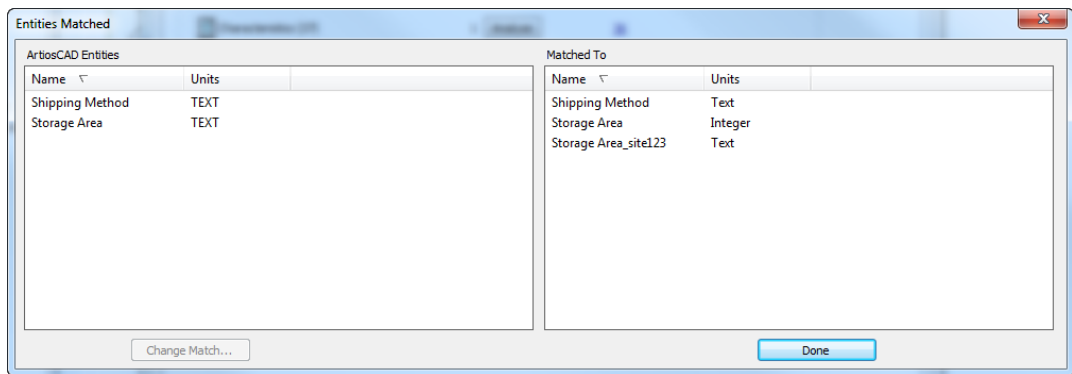

Note that there already was a Storage Area restricted set in WebCenter, so the migration tool appended a collision suffix as specified in the options to make a unique entry.

3. In the Entities Matched dialog box, both panes are sorted by name. Matching entities are shaded.
 - a) To change a match, select an entity in the left pane and click **Change Match**.
 - b) The ArtiosCAD database entry is shown at the top of the dialog box. Click a new match from the list and click **Done**.

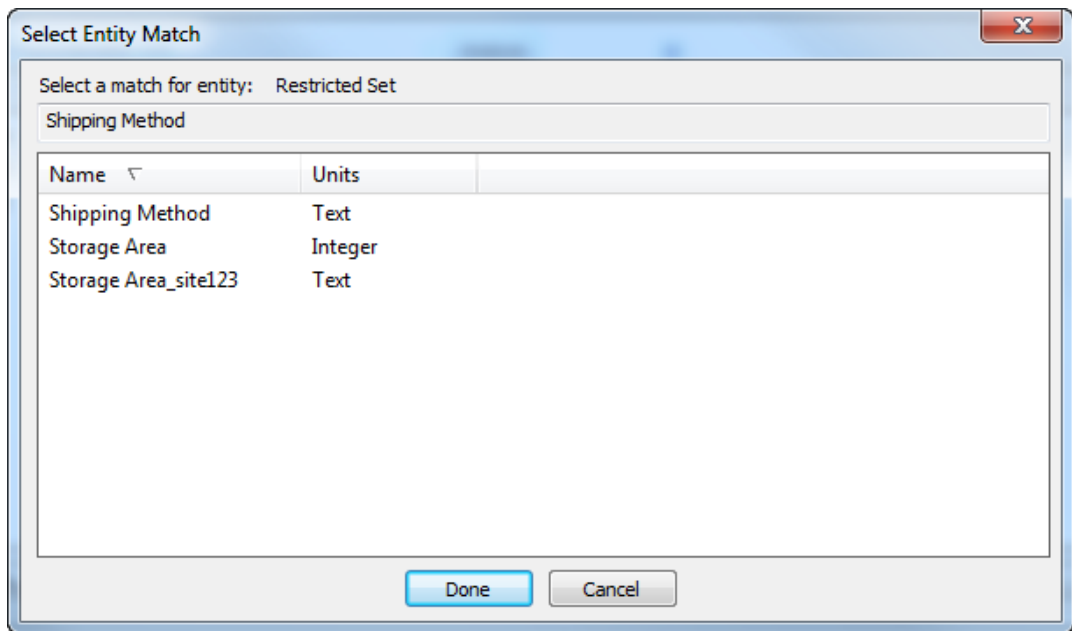

- c) Click **Done** to return to the migration tool.
- 4. Click the underlined blue number in the **New** column to open the New Entities To Be Inserted dialog box.

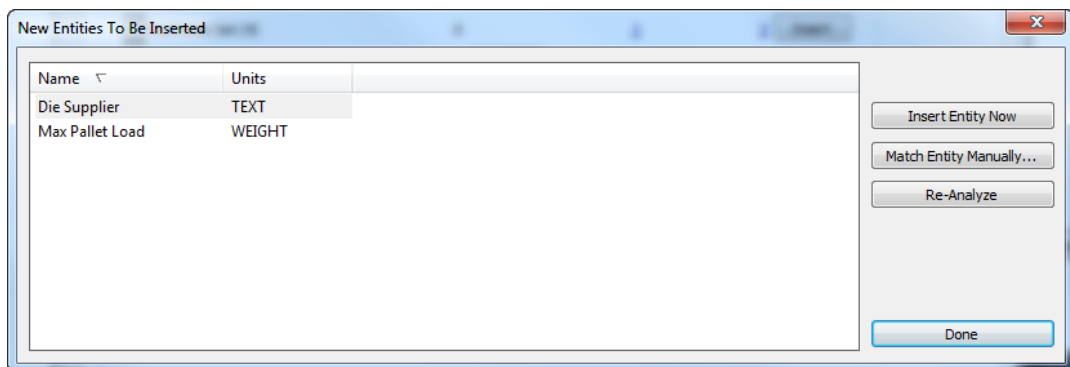

- a) If a new entity is not truly new and should be matched to an existing entity, select it and click **Match Entity Manually**.

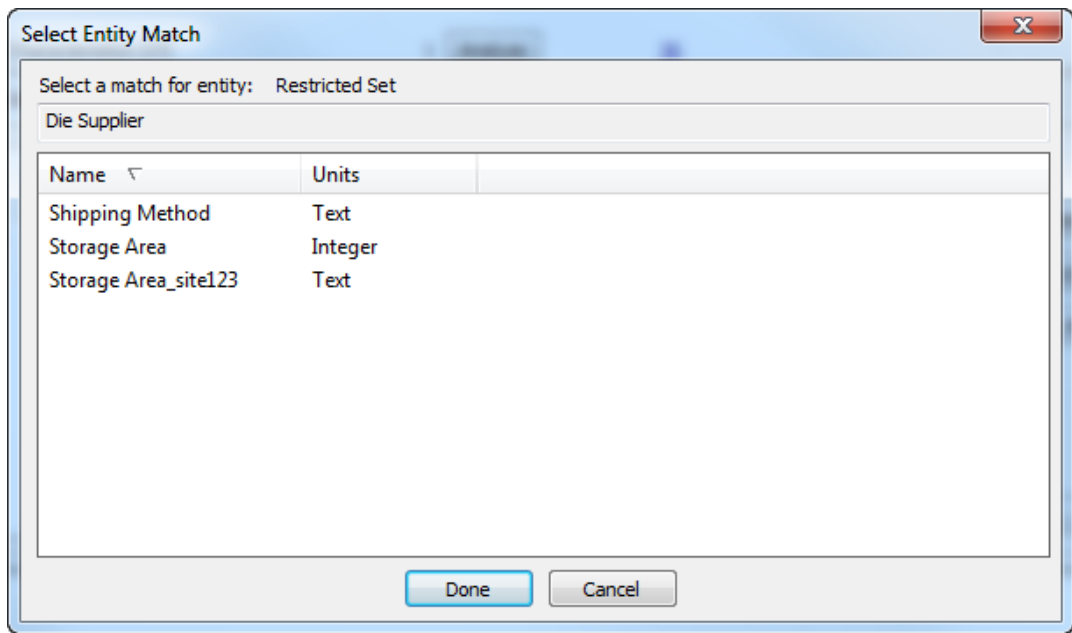

- b) Select the matching restricted set and click **Done** to return to the New Entities To Be Inserted dialog box.
 - c) To insert this one entity into the WebCenter database, click **Insert Entity Now**.
 - d) To reanalyze the restricted sets in case there have been changes, click **Re-Analyze**.
 - e) Click **Done** to return to the migration tool.
5. Now you are ready to start migrating the restricted sets. Click **Insert** in the Restricted Set row.
 6. The migration tool will update the number in the Matched column, and the number in the New column and the **Insert** button will disappear.

Migrating Userfields

The next step in the migration is to migrate the userfields, which become Attributes in WebCenter. The migration tool matches them by name and format type, but does not compare the value type (Prompted, Calculated, or Restricted).

The migration tool adds prefixes to the list of ArtiosCAD userfields: ARD for single design userfields, MFG for manufacturing file userfields, and PRJ for Project userfields. It maintains separate mappings for each group of userfields. More than one userfield can map to the same Attribute.

1. Analyze the userfields to match to Attributes.



2. Click the underlined blue number in the **Matched** column to open the Entities Matched dialog box.

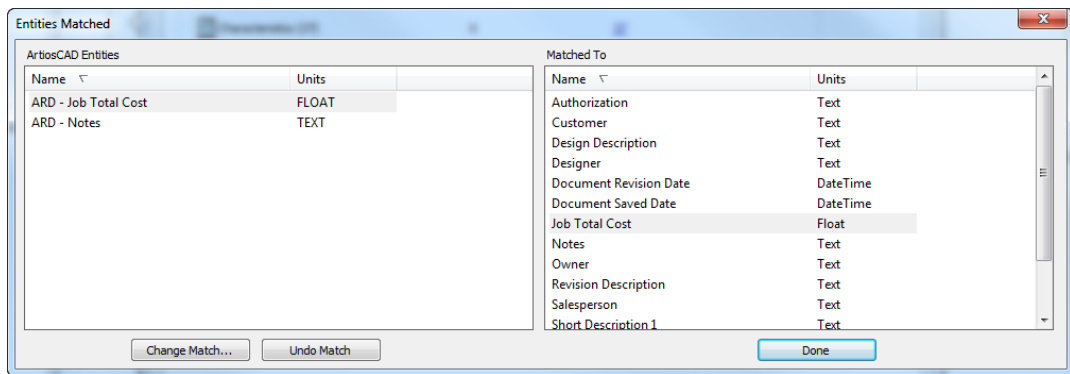

3. In the Entities Matched dialog box, both panes are sorted by name. Matching entities are shaded.
 - a) To change a match, select an entity in the left pane and click **Change Match**.
 - b) The ArtiosCAD database entry is shown at the top of the dialog box. Click a new match from the list and click **Done**.

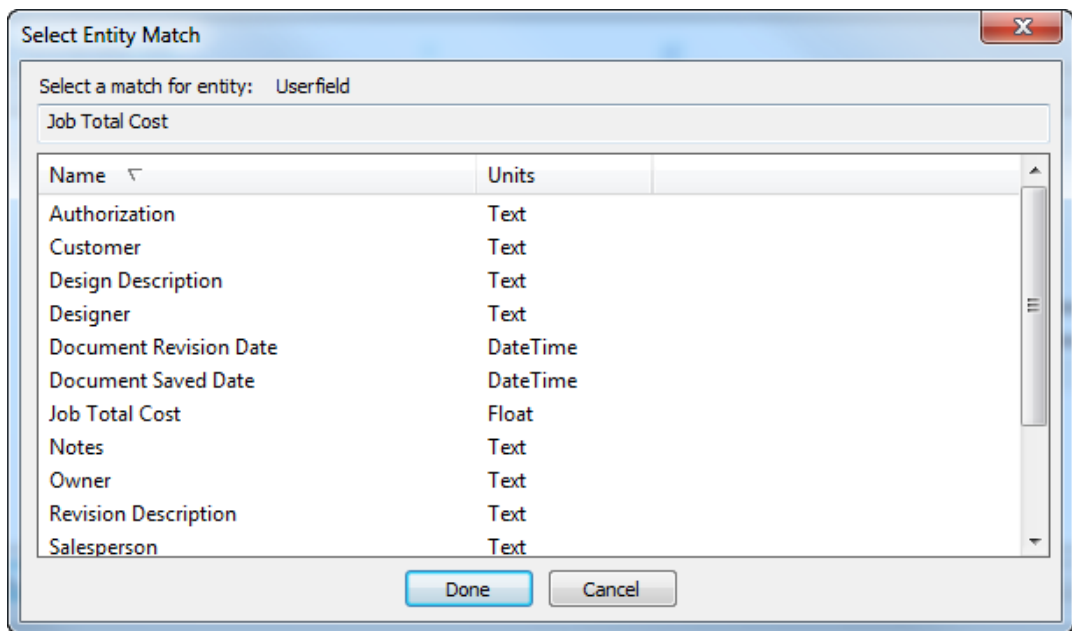

- c) To undo a match, select the entity on the left and click **Undo Match**. Use this with care as the only way to recreate the match is to reanalyze the userfields.
 - d) Click **Done** in the Entities Matched dialog box to return to the migration tool.
4. Click the underlined blue number in the **New** column to open the New Entities To Be Inserted dialog box.

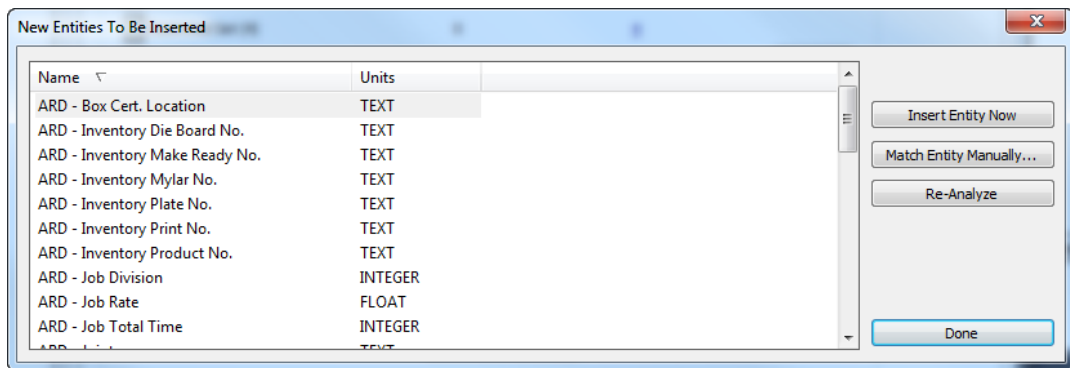

- a) If a new entity is not truly new and should be matched to an existing entity, select it and click **Match Entity Manually**.

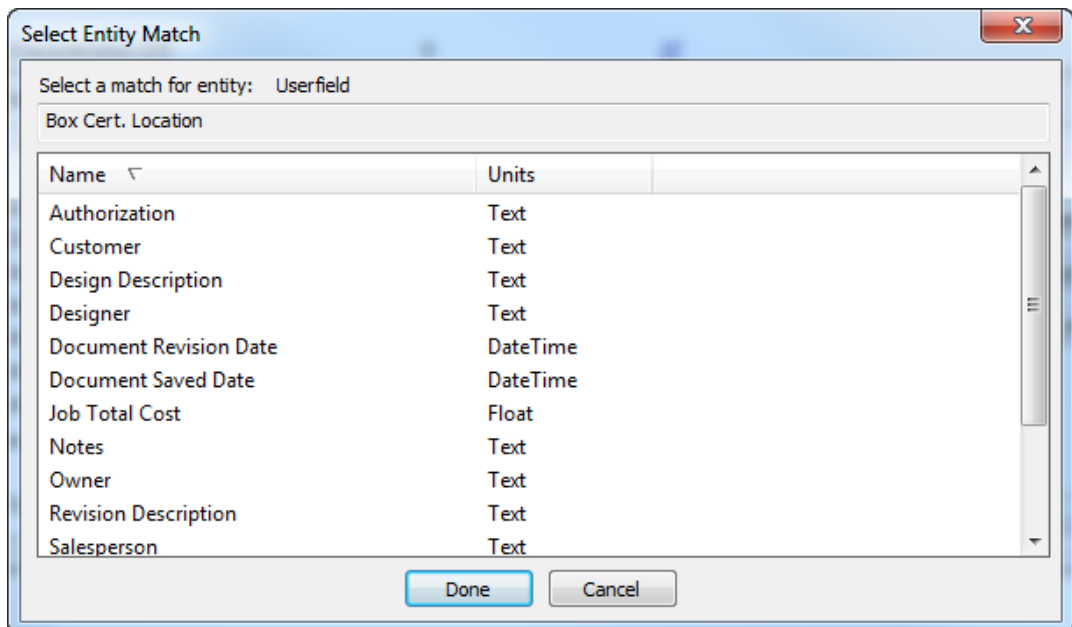

- b) Select the matching restricted set and click **Done** to return to the New Entities To Be Inserted dialog box.
 - c) To insert this one entity into the WebCenter database, click **Insert Entity Now**.
 - d) To reanalyze the restricted sets in case there have been changes, click **Re-Analyze**.
 - e) Click **Done** to return to the migration tool.
5. Now you are ready to start migrating the userfields. Click **Insert** in the Userfields row.
 6. A progress bar will appear.

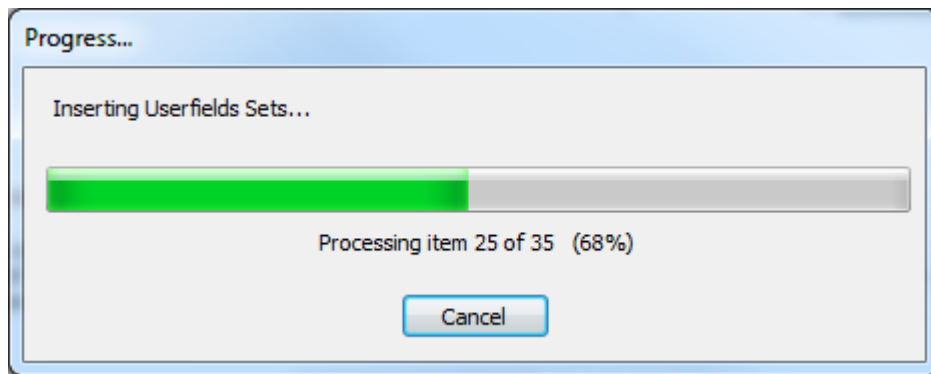

7. The migration tool will update the number in the Matched column, and the number in the New column and the **Insert** button will disappear.

Saving Mapping to the Server

The mapping you have set to get the data migrated from ArtiosCAD Standard Edition into WebCenter for use by ArtiosCAD Enterprise needs to be saved for every location for which you have a designer. You can use a different mapping for each location, but you should save a mapping for every location. If a mapping already exists for a location, saving it again will overwrite the previous mapping.

After the migration is complete, every time a user uploads an unmanaged file into WebCenter, or opens it with ArtiosCAD Enterprise, the program will use this saved mapping for the user's location to migrate the data in the design.

The legacy CAD metadata (like Owner and Salesperson) configured on the Design Data tab of the migration tool is not location-specific, but clicking this button also saves it to the server.

Note: You can only save the mappings after you have migrated the userfields, restricted sets, and characteristics.

Note: You must save mapping for EVERY INDIVIDUAL LOCATION. Click **Save Mapping to Server**, select the first location, click **OK**, click **Save Mapping to Server**, select the second location, click **OK**, click **Save Mapping to Server**, select the third location, click **OK**, and so on.

1. Migrate the userfields, restricted sets, and characteristics if you have not already done so.
2. On the Characteristics and Userfields tab of the migration tool, click **Save Mapping to Server**.

Save Mapping to Server

When a designer is using ArtiosCAD in the future and opens a design that was not migrated, ArtiosCAD will automatically convert all the userfields and design characteristics in the design only if you save this mapping to the server. You must save the mapping for every location associated with a designer.

3. In the Save Mapping to Server dialog box, click a location and click **OK** to save the mapping to the server.

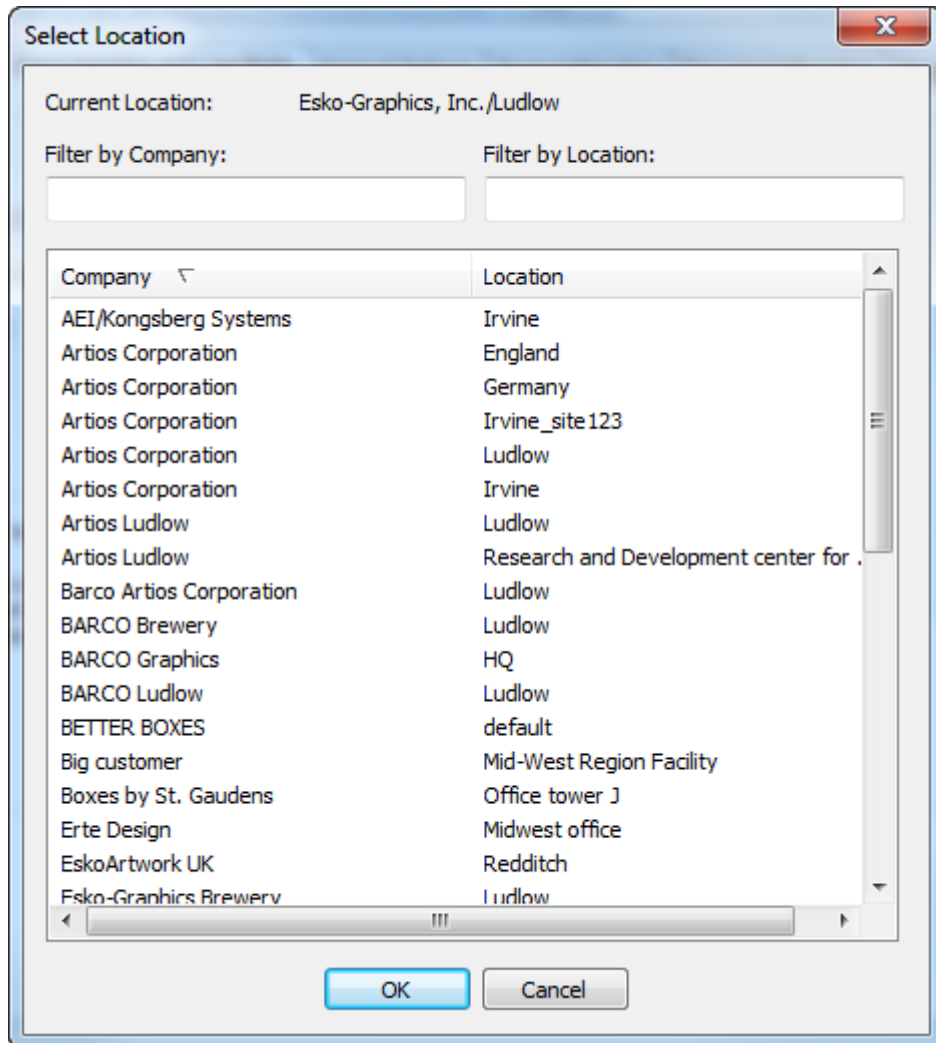

4. Repeat steps 2 and 3 for each location with which you have designers associated, or may have designers associated with in the future, for which you want to use the current mapping you have configured on the Design Data and Characteristics and Userfields tabs. To use other mappings with locations, change the mappings as desired and repeat steps 2 and 3.

Setting General Options for Project and Document Migration

The General Options tab lets you set options for how the migration tool will work.

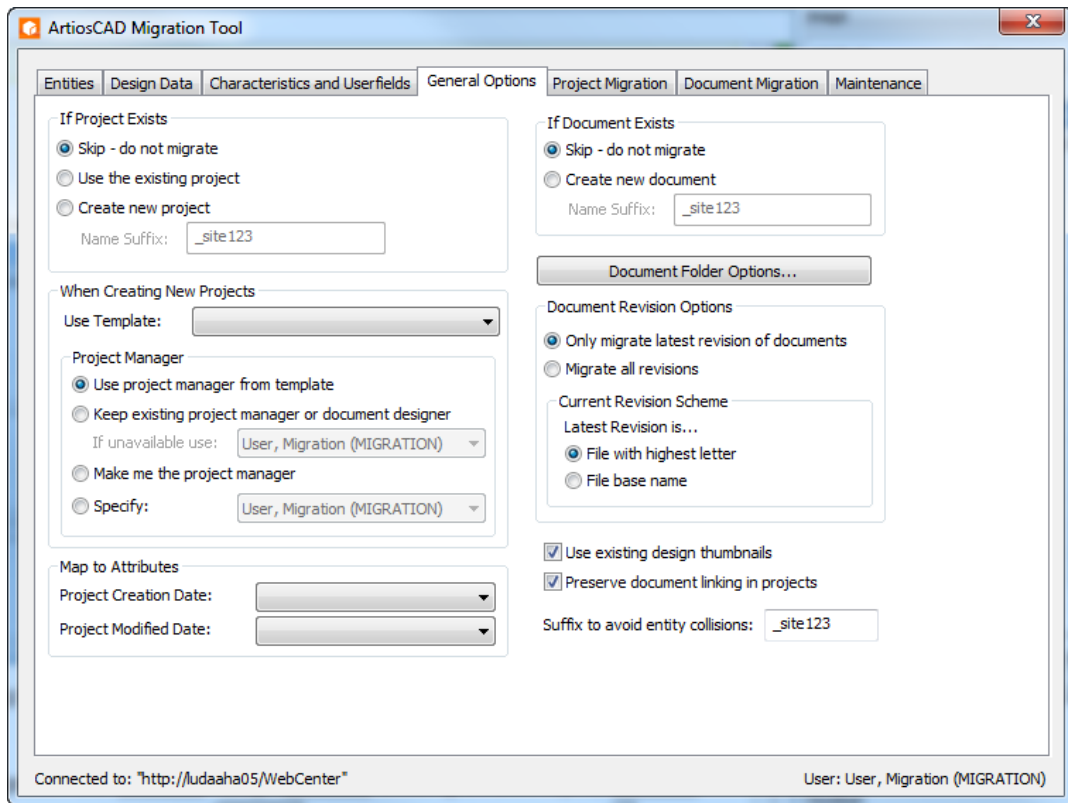

The left side of the dialog box shows groups containing the options for Projects, while the right side of the dialog box contains the options for documents.

In the If Project Exists group, you can have the migration tool **Skip** creating a new Project, **Use the existing project**, or **Create new project** with the specified name suffix.

When the migration tool creates new Projects, if you want it to use a Template, select it in the **Use Template** drop-down list box. It can only use one Template per run; if you want to apply multiple Templates, you have to run the migration multiple times, each time on a new list of search results. For new Projects it creates, it can **Keep existing project manager or document designer**, and allows you to pick a different user or group if that person is unavailable for any reason. Note that this option overrides the Project manager set in the Template. The migration tool can make the logged-in user the Project manager if you select **Make me the Project manager**. You can also **Specify** a user or group to set as the Project manager. This is one reason why it is important before you begin the migration process to decide which user is going to run the migration tool.

Note: These settings for the Project manager also apply when migrating documents that cause the tool to create new Projects.

In the Map to Attributes group, you can choose either **Document Revision Date** or **Document Saved Date** for the Project Creation Date and Project Modified Date fields. You can also leave the fields blank to not migrate these two database fields. This information is optional and does not exist in native form in WebCenter.

Suffix to avoid entity collisions is the suffix the migration tool appends to entities to avoid duplicates. This value seeds the Name Suffix fields in other groups in this dialog box.

In the If Document Exists group, you can choose to have the migration tool **Skip - do not migrate** or **Create new document** with the specified name suffix. Note that this is per Project; the same document name may exist in different Projects.

Document Folder Options leads to a dialog box where you can specify that documents with certain extensions go into certain folders within a Project. The migration tool will create folders as needed.

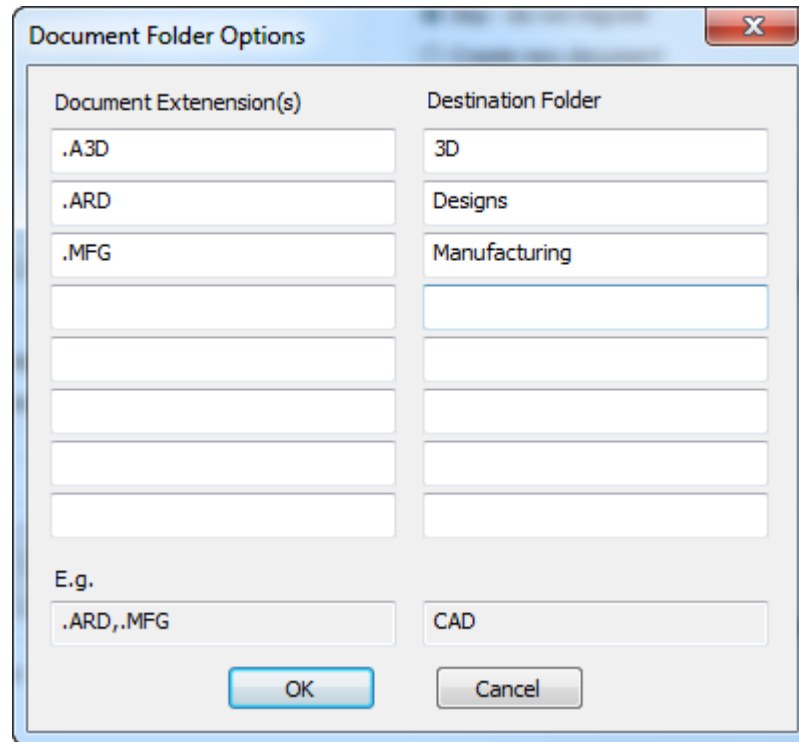

In the Document Extension(s) field, enter the filename extension(s) for documents to filter into the folder you specify in the Destination Folder field. Include the leading period in the extension and separate multiple extensions with commas as shown in the example. Click **OK** to return to the migration tool.

In the Document Revision Options group, choose to **Only migrate latest revision of documents** or to **Migrate all revisions**. In the Current Revision Scheme group, tell the migration tool if the latest revision is the **File with highest letter** or **File base name**. You can check your ArtiosCAD Standard Edition installation to see which method it uses by launching it and clicking **Options > Defaults > Startup Defaults > Revision Disk File Format**. **Don't put revision extension on latest revision** would mean **File base name** and **Don't put revision extension on first revision** would mean **File with highest letter**.

Use existing design thumbnails, when checked, uses the existing thumbnails from the ArtiosCAD database. When deselected, it causes WebCenter to regenerate the document thumbnails.

Preserve Document Linking in Projects, when checked, keeps linked documents linked. When deselected, linked documents become individual documents in each Project into which they are migrated.

Migrating Projects

Once you have adjusted the tuning file, migrated all the entities, migrated the characteristics, restricted sets, and userfields, saved all the mappings to the server, and set the options, you are ready to begin migrating the data. To migrate Projects, you search for them and then migrate those that appear in the search results. If desired, you then change the options and search for a different set of Projects to which to apply those options, and then migrate the results of that search, and so on for another set of Projects. If you do not work with Projects, skip ahead to the Migrating Documents section.

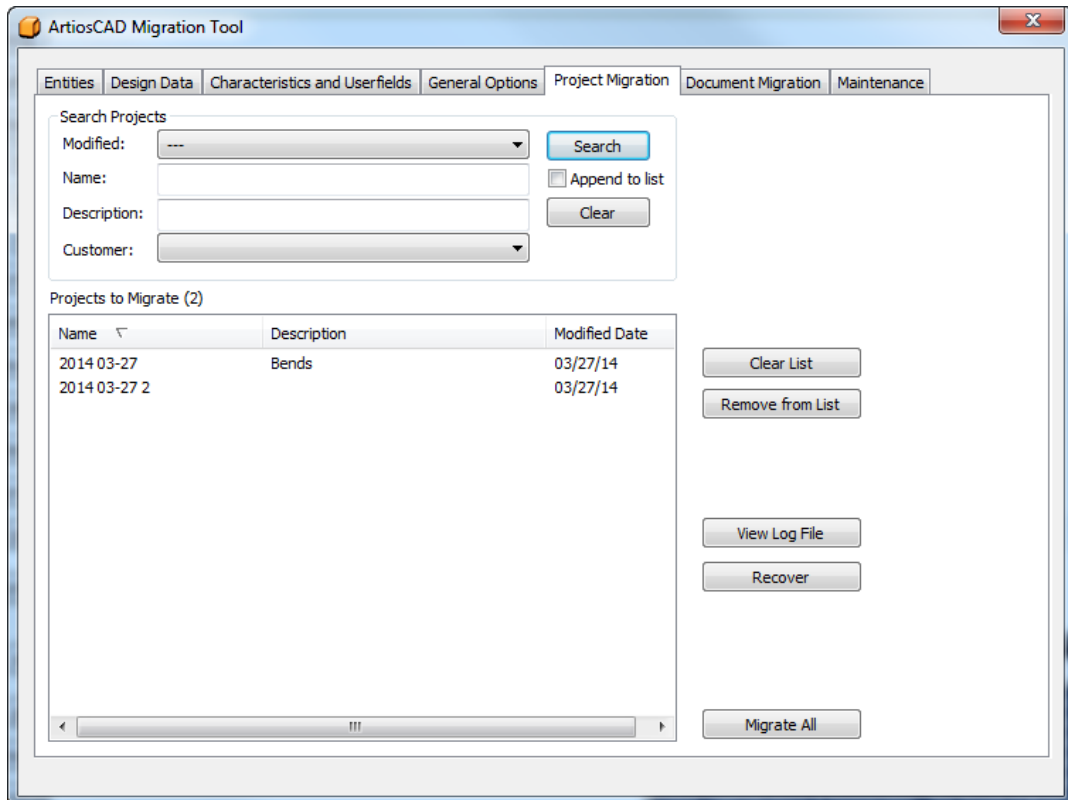

Searching for Projects to Migrate

In the Search Projects group of the Project Migration tab of the migration tool are four fields that control how you search for Projects. The migration tool searches on all the fields for which you enter values; it uses AND in the query, not OR. Searching for Projects creates a list of Projects to migrate. You can run multiple searches with different criteria each time to get only the results you want in the list before you migrate any Projects.

The 'Search Projects' dialog box contains the following fields and controls:

- Modified:** A dropdown menu currently showing '---'.
- Name:** A text input field.
- Description:** A text input field.
- Customer:** A dropdown menu.
- Search:** A button to execute the search.
- Append to list:** A checkbox.
- Clear:** A button to reset the search criteria.

- To search by when a Project was last modified, choose one of the values from the Modified drop-down list box.
 - . Use this to not specify a date.
 - Modified last day, Modified last 7 days, Modified last 30 days.** Choose a more specific time range for when a Project was last modified.
 - More options** opens a dialog box in which you can set the exact modification time to search against.

The 'Dialog' box for setting modification criteria includes:

- Modified last:** A radio button, a text field with '0', and the label 'Days'.
- Modified on day:** A radio button and a date field showing 'Thursday , April 10, 2014' with a calendar icon.
- Modified between dates:** A radio button, a 'Begin date:' field with 'Thursday , April 10, 2014', and an 'End date:' field with 'Thursday , April 10, 2014', both with calendar icons.
- Buttons:** 'OK' and 'Cancel' buttons at the bottom.

Modified last lets you enter the exact number of days for which you want to search for modified Projects. Use the calendar buttons at the end of the fields in **Modified on day** and **Modified between dates** to set either an exact day or a range of days. Click **OK** to return to the migration tool.

- In the Name field, specify the name of the Project to search for. Use wildcards as described below to find more results.
- In the Description field, specify the description of the Project to search for. Use wildcards as described below to find more results.
 - * and % mean match all characters.
 - ? and _ mean match one character.
 - To search on one of the wildcards, prefix it with a backslash (\), such as "100\% Pure".

- To search specifically on a backslash, enter “\\”.

Examples of using wildcards are shown in the following table.

Search term	Search results
Project_1	All Projects starting with “Project” and then any single character between t and 1, such as ProjectX1, Project\$1, and so forth.
Project_1	Project_1.
Project_*	All Projects starting with Project_, such as Project_1, Project_X, and Project_5BD2.
Project\\1	Project\1.

4. Choose a customer from the drop-down **Customer** list box, or leave it empty to search across all customers.
5. Clicking **Append to list** will add the results of this search to the list of Projects to migrate. Not selecting this option and doing another search will overwrite the previous list of Projects to migrate. The migration tool automatically removes duplicates from the list. **Clear** resets all the search fields.
6. Click **Search**. The migration tool will search the database for Projects matching the search criteria you set and show the results in the Projects to Migrate list.

Projects to Migrate (8)

Name	Description	Modified Date
2014 03-27	Bends	03/27/14
2014 03-27 2		03/27/14
Blue box		04/14/14
Blue box 2		04/14/14
Blue box 3		04/14/14
Blue box 4		04/14/14
Blue box 5		04/14/14
Blue tray	Blue tray	04/14/14

7. Review the list. You cannot migrate selected Projects; instead, remove the Projects you do not want to migrate. To remove a single Project from the list, click it and then click **Remove from List**. Use SHIFT and CTRL selections to select a range of Projects or multiple Projects respectively, and then click **Remove from List** to remove them from the migration list. Click **Clear List** to remove all Projects from the migration list.

Performing the Projects Migration

1. Once you have all the desired Projects in the list of Projects to migrate, click **Migrate all**. A progress bar will appear.

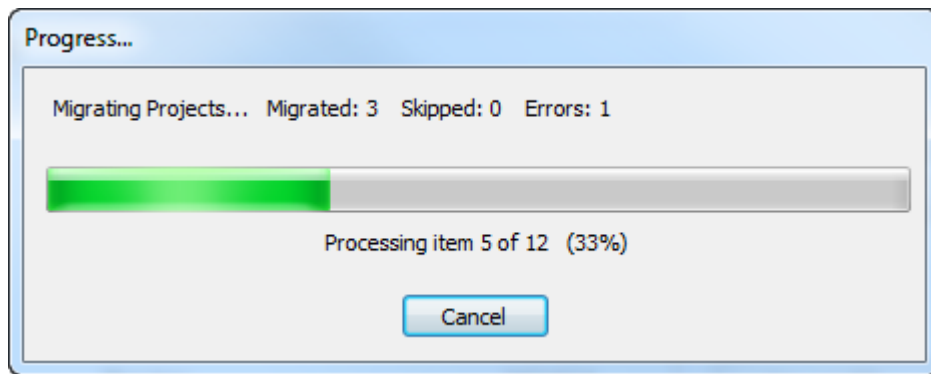

The length of time the migration will take depends on the number of Projects being migrated.

- a) As it processes each Project, the migration tool checks to see if it already exists in WebCenter. If the Project does already exist, the migration tool uses the settings on the General Options tab to determine the proper actions.
 - b) The migration tool next updates the Project's metadata, unless the Project already existed and **Use existing project** was selected in General Options. The new Project manager can be the existing Project manager if that same user is a Project manager in WebCenter, or it can be the current WebCenter user running the migration tool. The migration tool sets the Customer and Salesperson according to how they are mapped in the entity migration, as well as the Project characteristics. The migration tool maps Project characteristics as Attributes as defined during entity migration. The migration tool maps the creation and modified dates based on the Map to Attributes group settings on the General Options tab.
 - c) The migration tool next migrates single design documents into the WebCenter Project.
 - d) Finally, the migration tool updates the Bill of Materials information for the WebCenter Project. This includes if the design is included in the Bill of Materials and if so, updating the BOM count and BOM display order.
2. When the migration process finishes, the Migration Results dialog box appears for you to review the status of the migration. In it, you can add Projects back to the list of Projects to be migrated by clicking the appropriate checkboxes.

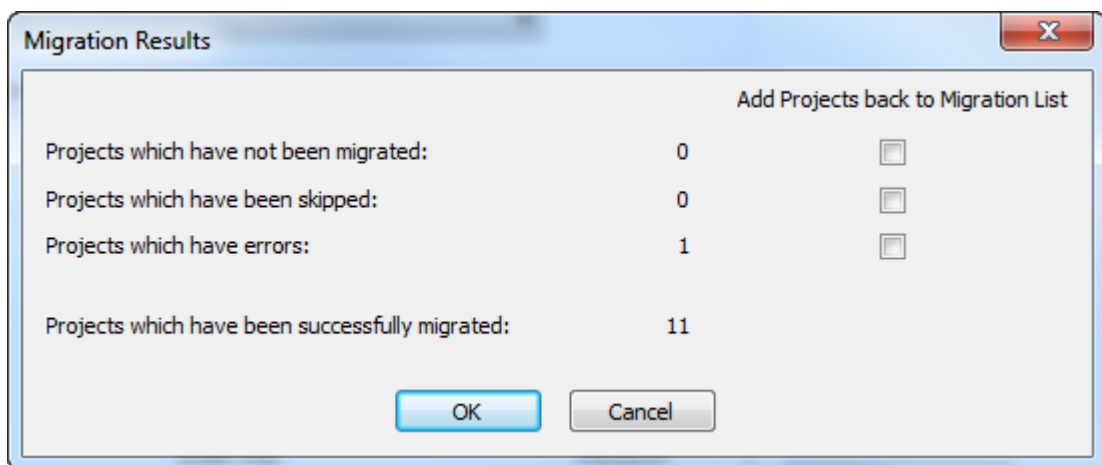

3. Click **OK** to add any Projects back to the migration list and return to the migration tool, or click **Cancel** to just return to the migration tool.

Recovering from Project Migration Errors

In the rare event that the migration tool errors when migrating Projects, there are two log files it uses to help recover.

- ..\Esko\Artios\Migration\ProjectMigrationListing.xml, which is the list of Projects to migrate;
- ..\Esko\Artios\Migration\ProjectMigrationLog.xml, which is the log of the Project migration process.

View log file on the Project Migration tab opens the log file for viewing. When Projects have errors, the most likely cause is that the migration tool cannot find one of the physical documents on disc, as shown in this excerpt from the Project migration log file. To fix this, you would find the document, copy it to the location the Project expects, and migrate the Project again.

```
DBPROJECT NAME="2014 03-27" STATUS="2" ECADPROJECTNAME="2014 03-27"
  ECADPROJECTID="00002_0000000047">
<LOG_MESSAGES><LOG_MESSAGE>STATUS - Project does not exist... creating it</LOG_MESSAGE>
<LOG_MESSAGE>STATUS - Created new project: 2014 03-27</LOG_MESSAGE>
<LOG_MESSAGE>STATUS - Updated project metadata</LOG_MESSAGE></LOG_MESSAGES>
<DBDESIGN DOCNAME="BENDS.ARD" RESOURCEID="101" RESOURCENAME="Prod" REV="1"
  DOCPATH="C:\Users\Prod\BENDS A.ARD" STATUS="2"><LOG_MESSAGES>
<LOG_MESSAGE>STATUS - Attempting to link document to: @2014 03-27:1:BENDS.ARD</
LOG_MESSAGE>
<LOG_MESSAGE>ERROR - Unable to access physical document: C:\Users\Prod\BENDS_A.ARD</
LOG_MESSAGE>
</LOG_MESSAGES>...</DBPROJECT>
```

Clicking **Recover** on the Project Migration tab of the migration tool causes the tool to analyze these two log files and regenerate the list of Projects to migrate. It then displays the Migration Results dialog box in which you can add Projects back into the list of Projects to migrate. Check the checkboxes for Projects that have a count and click **OK**.

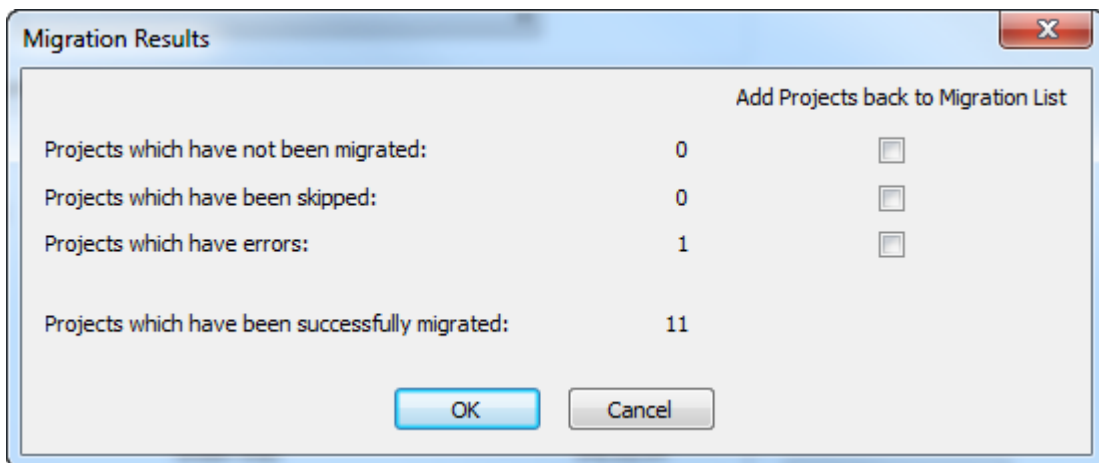

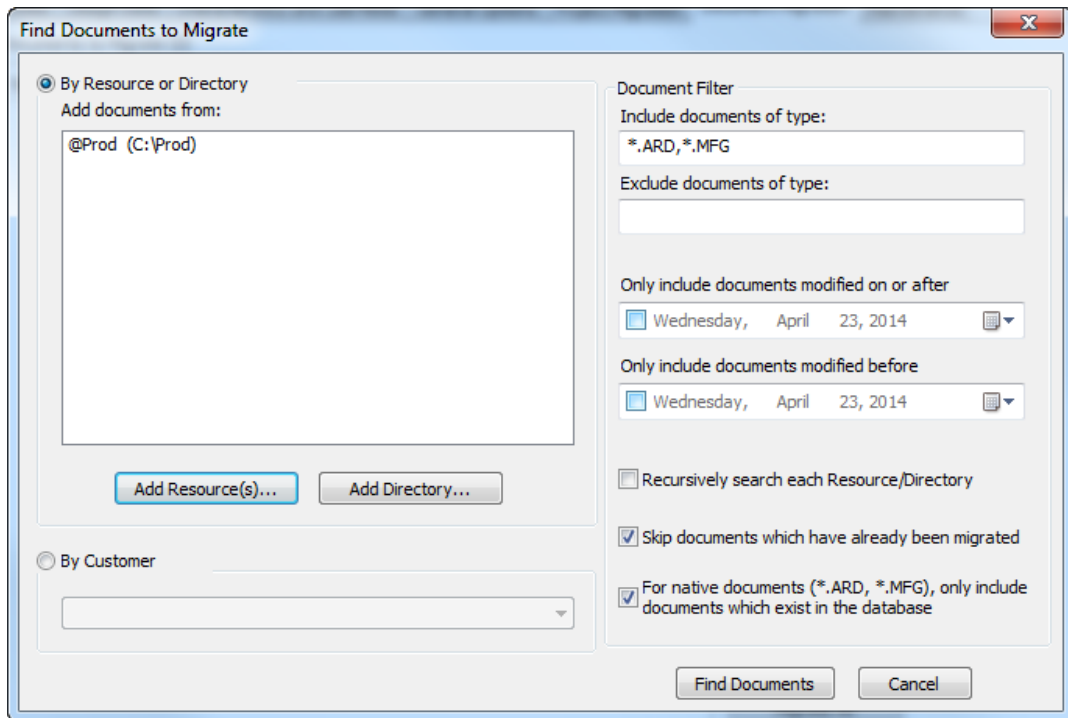

1. Choose a way to search for documents.
 - a) To search for documents by resource, click **Add Resource(s)**. The Select Resource(s) dialog box appears.

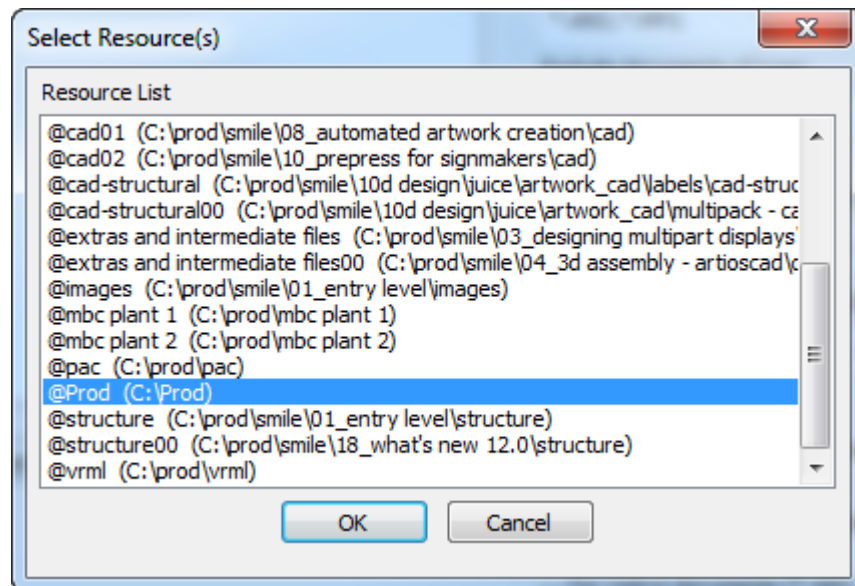

To select one resource, click it. To select multiple resources, hold down CTRL and click each resources. To select a group of resources, click the first resource, hold down SHIFT, and click the last resource. If you have nested resources, you do not have to pick each lower-level one, as there is an option to search in sub-resources and

subdirectories. Once you have selected the desired resource(s), click **OK** to return to the Find Documents to Migrate dialog box.

- b) To search for documents by directory, click **Add Directory**. The Browse for Folder dialog box appears.

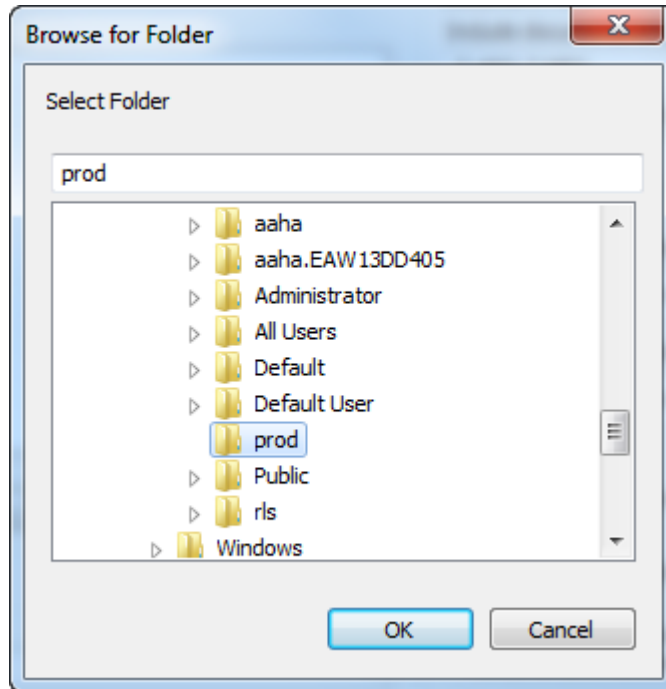

Click the desired directory and click **OK** to return to the Find Documents to Migrate dialog box. Repeat this step to search for documents in more than one directory.

- c) To search for documents by customer name independent of location, click **By Customer** and choose the customer's company name from the drop-down list box.
2. In the Document Filter group, choose the type of document(s) to search for in the Include documents of type field and to exclude in the Exclude files of type field. Use comma-separated wildcards in each field, such as X*.ARD, which would either find or exclude all single design documents whose names start with X. When searching by customer, only *.ARD and *.MFG are applicable.
 3. To search for documents using the time at which they were last modified, check **Only include documents modified on or after** or **Only include documents modified before**, or both. Use the calendar drop-down to set each date. To search within a certain range, set the modified on or after date and the modified before date where the modified after date is earlier than the modified before date. To exclude a certain date range, set the modified on or after to a later date than the modified before date; this option is not supported when searching by customer.
 4. Click **Recursively search each Resource/Directory** to search down through each subdirectory or child resource. The migration tool will only add the first instance of a document for which it encounters duplicates. This option is not supported when searching by customer.
 5. The migration tool tracks which documents have been migrated in previous migrations. Check **Skip documents which have already been migrated** to not migrate them again.

6. Sometimes there are documents that exist physically but are not saved in the database. To control if these are migrated or not, check or clear **For native documents (*.ARD, *.MFG), only include documents which exist in the database**. This option is not supported when searching by customer.
7. Click **Find Documents**. The migration tool searches in two passes.
 - a) First, the migration tool searches the specified directories/resources (or the database is searched by customer) using the document type and date filters.
 - b) Next, it filters the results again to find the highest version of the design documents, and also filters out documents which do not exist in the database or which have already been migrated (if those options are selected).

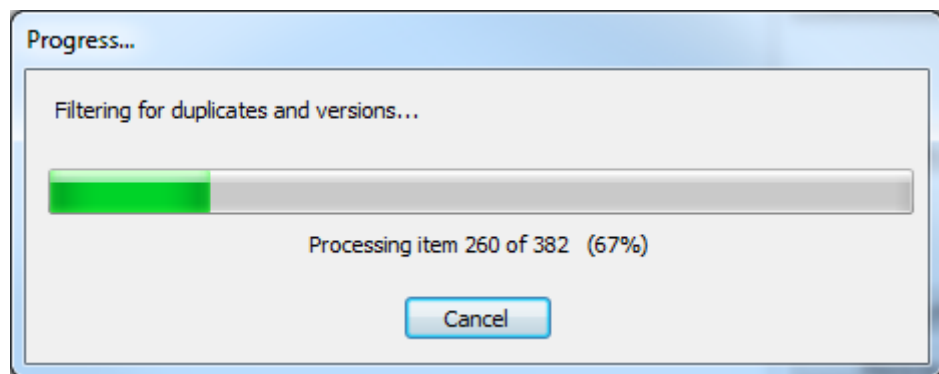

8. Finally, the migration tool displays the search results in the Documents to Migrate list. The list is initially sorted by filename but you can change the sort order by clicking a column header.

- **Use resource/directory name as project name** creates Projects analogous to your directory or resource setup in ArtiosCAD Standard Edition. The migration tool uses the last part of the directory path for the name unless the document is in the root folder of the drive, in which case it uses UNKNOWN.
- **Use document name as project name** uses the document name (without the extension) for the Project name.
- **Use external DLL** lets you use a function in a Windows dynamically linked library exported in standard C-language style to generate the name of the Project. See the next section for details.

Use workspace metadata if design does not exist in database causes the migration tool to try to use database information stored in the workspace. This includes Description, Short Description 1, 2, 3, Revision Summary, Authorization, Revision and Save Date, Characteristics, and Userfields. For Customers, Owners, Salespersons, and Designers, these will be used only if the database ID in the workspace matches the current ArtiosCAD Standard Edition database ID (meaning that the workspace was created on a local system using the current database, not a design you got from some other ArtiosCAD location).

Automatically migrate design metadata for new projects automatically seeds Project-level metadata with the metadata from the first design added to the Project when a new project is created in WebCenter.

- Designer becomes the Project manager (based on how the **When Creating New Projects / Project Manager** option is set on the General Options tab
- Description becomes the Project description
- Customer becomes the Project customer
- Salesperson becomes the Project salesperson
- Characteristics become Project characteristics
- Userfields become Project Attributes
- Short Description 1, 2, 3, Authorization, Revision Summary, Owner, Revision Date, and Save Date become Project Attributes (based on the Map to Attributes option on the General Options tab.

Click **OK** to return to the Documents Migration tab.

Using an External DLL to Generate The Project Name

To use a function in a Windows dynamically linked library exported in standard C-language style to generate the name of the Project in which to store a document being migrated, refer to the example below to guide the coding.

```
extern "C"
{
    __declspec (dlllexport )  short GetProjectNameFromDocName (...)
```

A prototype of the function would be:

```
short
    GetProjectNameFromDocName(const char * docName, int rev,
        const char* resourceName, const char* fullDocPath,
        int* projectNameOption, char* projectNameRet, int projectNameBufLen,
        int* folderNameOption, char* folderNameRet, int folderNameBufLen,
        int* documentNameOption, char* documentNameRet, int documentNameBufLen)
```

Table: External DLL Function Parameters

Parameter	Definition
const char* docName	The base .ARD or .MFG document name without the encoded revision.
int rev	The revision of the document; only applies to .ARDs and .MFGs else 0.
const char* resourceName	The resource name if a document is in a resource.
const char* fullDocPath	The full path to the document, such as C:\Users\Prod\ABC.ARD.
int projectNameOption	(out) Project name option returned. 1 - Project name returned in projectNameRet. 2 - use document name as Project name. 3 - use resource/directory as Project name.
char* projectNameRet	(out) The returned Project name; must be NULL terminated.
int projectNameBufLen	The length (int chars) of the projectNameRet buffer.
int folderNameOption	(out) The folder name option returned. 1 - folder name returned in folderNameRet. 2 - use default folder mapping.
char* folderNameRet	(out) The returned folder name; must be NULL terminated.
int folderNameBufLen	The length (int chars) of the folderNameRet buffer.
int documentNameOption	(out) Document name option returned. 1 - document name returned in documentNameRet. 2 - use default document name.
char* documentNameRet	(out) The returned document name; must be NULL terminated.
int documentNameBufLen	The length (int chars) of the documentNameRet buffer.

Table: External DLL Function Returns

Return	Meaning
0	Error - the migration tool will log this document as an error.
1	Success - the migration tool will analyze the return parameters.

Performing the Documents Migration

1. Once you have all the desired documents in the list of documents to migrate, click **Migrate all**. A progress bar will appear.

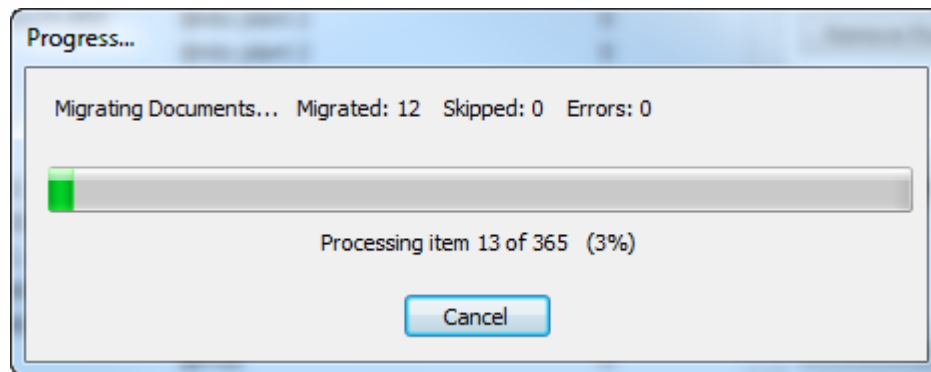

The length of time the migration will take depends on the number of documents being migrated.

The migration tool migrates all single designs before migrating manufacturing documents so that all potential embedded designs are already migrated when it starts migrating manufacturing documents.

2. For single designs:
 - a) As it processes each document, the migration tool first looks to see if a target Project already exists or, if it does not, the migration tool creates or skips the Project per the selected option in the If Project Exists group on the General Options tab. If the migration tool creates the Project, it does so using the settings in the When Creating New Projects group on the General Options tab. If it skips the document, it adds it to the list of skipped documents.
 - b) Next, the migration tool checks to see if the document already exists in the Project, and if it does, it uses the settings in the If Document Exists group on the General Options tab.
 - c) The migration tool next checks the options you set in the Document Folder Options dialog box on the General Options tab, and processes the document accordingly if it matches one of the directory-folder destination mappings.
 - d) For a single design in a resource, the migration tool applies the design's database information to the new WebCenter document. The design description becomes the document description, the design characteristics become document characteristics, design userfields become document Attributes, and the other fields are mapped according to the settings in the Map to Attributes group on the Design Data tab.
 - e) The migration tool next sets the default Attribute category as defined on the Design Data tab.
 - f) Finally, if the options are set in the Document Revision Options group on the General Options tab, the migration tool migrates the other revisions of the design.
3. For manufacturing documents:
 - a) As it processes each document, the migration tool first looks to see if a target Project already exists or, if it does not, the migration tool creates or skips the Project per the selected option in the If Project Exists group on the General Options tab. If the migration

- tool creates the Project, it does so using the settings in the When Creating New Projects group on the General Options tab.
- b) Next, the migration tool checks to see if the document already exists in the Project, and if it does, it uses the settings in the If Document Exists group on the General Options tab.
 - c) The migration tool next checks the options you set in the Document Folder Options dialog box on the General Options tab, and processes the document accordingly if it matches one of the directory-folder destination mappings.
 - d) For a manufacturing document, the migration tool applies the document's database information to the new WebCenter document. The manufacturing description becomes the document description, manufacturing userfields become document Attributes, and the other fields are mapped according to the settings in the Map to Attributes group on the Design Data tab.
 - e) The migration tool then adjusts the path of any embedded single designs. It only adjusts the path to point to embedded single designs that have already been migrated. It only modifies the manufacturing document with the new path(s) that it is uploading into WebCenter; it does not change the file(s) on disc.
 - f) The migration tool next sets the default Attribute category as defined on the Design Data tab.
 - g) Finally, if the options are set in the Document Revision Options group on the General Options tab, the migration tool migrates the other revisions of the manufacturing document.
4. The migration tool uploads all other documents (including .A3Ds) physically as there is no database information to include. It sets the default Attribute category as defined on the Design Data tab.
 5. When the migration process finishes, the Migration Results dialog box appears for you to review the status of the migration. In it, you can add Projects back to the list of documents to be migrated by clicking the appropriate checkboxes.

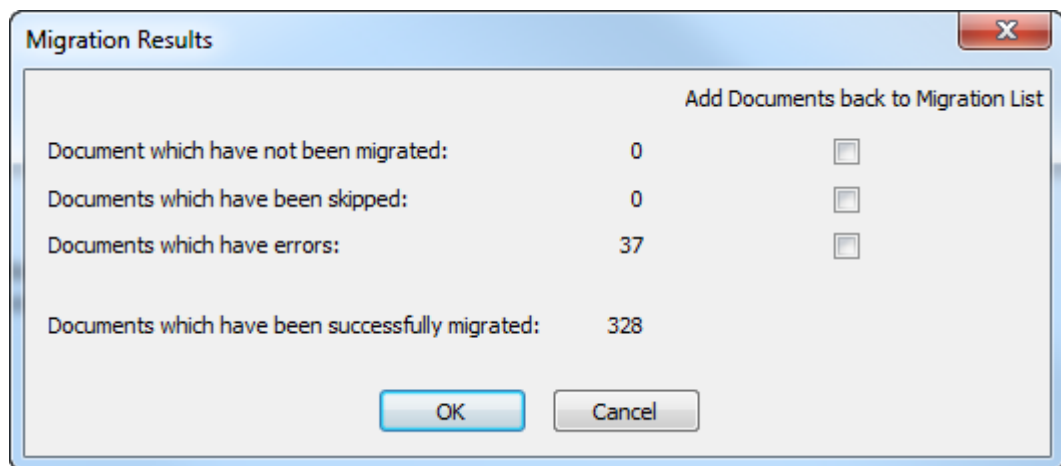

6. Click **OK** to add any documents back to the migration list and return to the migration tool, or click **Cancel** to just return to the migration tool.

Recovering from Document Migration Errors

In the rare event that the migration tool errors when migrating documents, there are two log files it uses to help recover.

- ..\Esko\Artios\Migration\DocumentMigrationListing.xml, which is the list of documents to migrate;
- ..\Esko\Artios\Migration\DocumentMigrationLog.xml, which is the log of the document migration process.

View log file on the Document Migration tab opens the log file for viewing. When documents have errors, the most likely cause is that the migration tool cannot find one of the physical documents on disc, as shown in this excerpt from the document migration log file. To fix this, you would find the document revision, copy it to the location the migration tool expects, and migrate the document again.

```
<DBDESIGN STATUS=" 2" DOCPATH=" C:\Prod\1SRELDFOC A.ARD" REV=" 1" RESOURCENAME=" Prod"
RESOURCEID=" 2" DOCNAME=" 1SRELDFOC.ARD"><LOG_MESSAGES><LOG_MESSAGE>
STATUS - Project already exists (Created by migration tool): Prod; using existing
project</LOG_MESSAGE><LOG_MESSAGE>ERROR - Unable to access physical document:
C:\Prod\1SRELDFOC_A.ARD</LOG_MESSAGE></LOG_MESSAGES><DBDESIGN
ECADVPATH=" @Prod:1:1SRELDFOC.ARD" ECADFOLDER="" ECADPROJECTID=" 00002_0000000090"
ECADPROJECTNAME=" Prod" ECADDOCVERSIONID=" 00002_0000013643" ECADVER="_1"
ECADDOCNAME=" 1SRELDFOC.ARD" STATUS=" 0" DOCPATH=" C:\Prod\1SRELDFOC.ARD"
REV=" 0" RESOURCENAME=" Prod" RESOURCEID=" 2" DOCNAME=" 1SRELDFOC.ARD">
<LOG_MESSAGES><LOG_MESSAGE>STATUS - Document does not exist in the database;
Using database metadata from workspace</LOG_MESSAGE><LOG_MESSAGE>STATUS -
Successfully uploaded document</LOG_MESSAGE></LOG_MESSAGES></DBDESIGN>
</DBDESIGN>
```

Clicking **Recover** on the Document Migration tab of the migration tool causes the tool to analyze these two log files and regenerate the list of documents to migrate. It then displays the Migration Results dialog box in which you can add documents back into the list of documents to migrate. Check the checkboxes for documents that have a count and click **OK**.

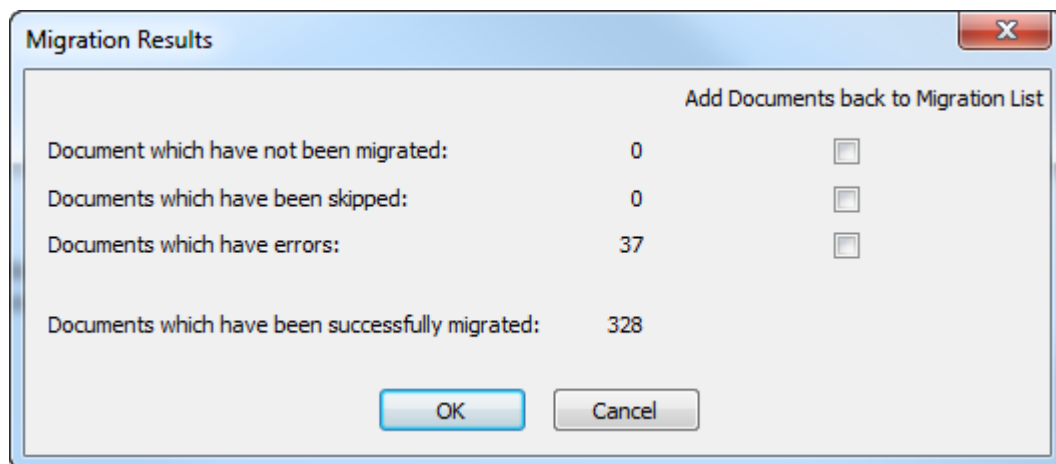

After You Are Done

After you have finished using the migration tool, there are additional things you need to do for ArtiosCAD Enterprise to be fully functional.

- Update every custom Report that previously used a userfield in ArtiosCAD Standard Edition to refer to the proper Attribute in ArtiosCAD Enterprise. Attributes are in the Calculated expressions dialog box just as userfields were.
- Update Outputs and geometry macros that refer to specific locations or files to point to their new Projects or files in the database.

Maintenance Tasks

The options on the Maintenance tab are for those customers who already used WebCenter together with ArtiosCAD Standard Edition before installing ArtiosCAD Enterprise. There are three tasks:

- Pre-10.2 Conversion. This is for those designers who have been using an older version of WebCenter that works slightly differently than the one which ArtiosCAD Enterprise uses.
- Pre-12.1 Document Maintenance. This is for those designers who have been using a version of WebCenter newer than 10.2 but older than 12.1. This option has three sub-tasks which can be performed independently of each other. Note that if applicable, you must do the Pre-10.2 Conversion before this.
- Legacy CAD Data Migration. This option migrates Short Descriptions 1, 2, and 3 database fields, along with other legacy CAD data, to WebCenter entities. This also has the Pre-10.2 Conversion as a prerequisite.

Pre-10.2 Conversion

This option is for designers who have single designs and manufacturing documents stored in a pre-10.2 version of WebCenter who have upgraded that WebCenter to the version that comes with ArtiosCAD Enterprise. These earlier versions of WebCenter show information that later versions do not. This maintenance task migrates that older data into Attributes and characteristics so that it is not lost and can continue to be searched.

1. Click **Convert**. The Server Entity Mapping dialog box opens. This entity mapping works the same way as the entity mapping for characteristics, restricted sets, and userfields. However, unlike the mapping on the Entities Mapping tab, this mapping automatically creates any required Attributes. This tool also automatically maps Attributes to userfields by name. Also unlike the other mapping, you can undo a match and insert it as a new Attribute.

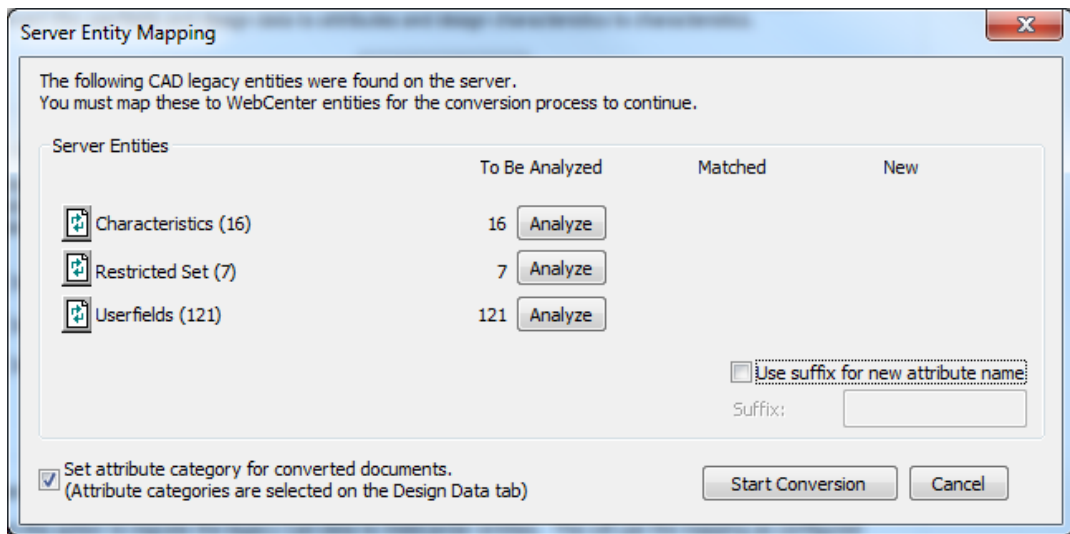

Use suffix for new attribute name adds the suffix you specify to any new Attributes the tool creates. The migration tool will also additionally append the collision suffix as needed, and a number at the end if needed to make it unique. Note that Attribute names can be a maximum of 40 characters long. **Set attribute category for converted documents** assigns the Attribute category you set on the Design Data tab to documents the tool updates.

- Analyze the characteristics to match.



- Click the underlined blue number in the **Matched** column for characteristics to open the Entities Matched dialog box.

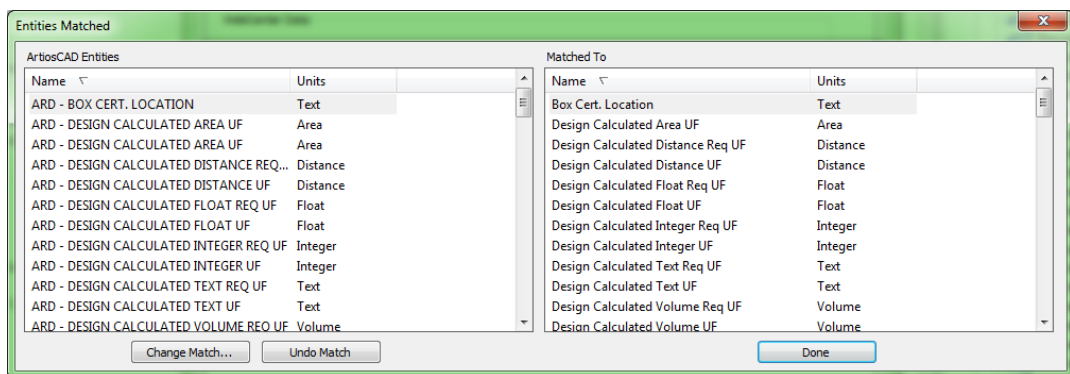

The migration tool shades matching entries. Click **Change Match** to change a match, or click **Undo Match** to undo it. Undo a match with caution, as that will lead to duplicate Attributes. Click **Done** to return to the migration tool.

- Click the underlined blue number in the New column to open the New Entities To Be Inserted dialog box.

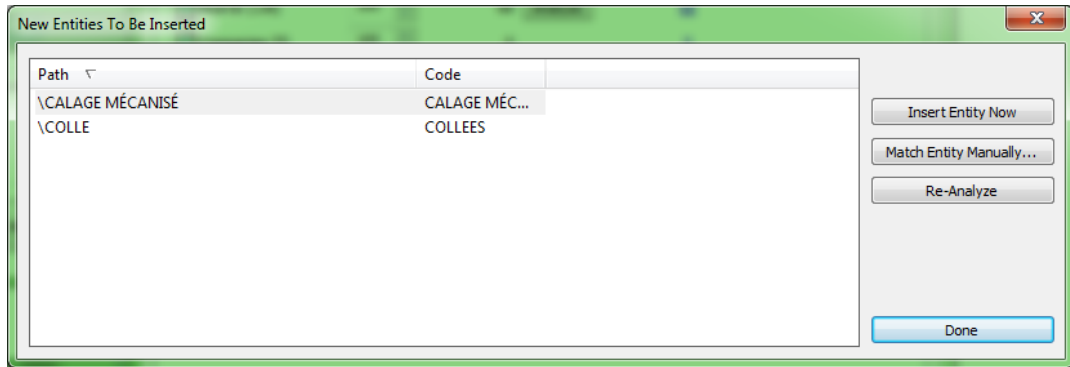

- a) If a new entity is not truly new and should be matched to an existing entity, select it and click **Match Entity Manually**.
 - b) Select the matching characteristic and click **Done** to return to the New Entities To Be Inserted dialog box.
 - c) To insert this one entity into the WebCenter database, click **Insert Entity Now**.
 - d) To reanalyze the characteristics in case there have been changes, click **Re-Analyze**.
 - e) Click **Done** to return to the migration tool.
5. Click **Insert** to insert the new Attributes.
 6. Repeat steps 2-5 for restricted sets and userfields.
 7. Click **Start Conversion** to begin converting the old data to the new format. A progress bar appears.

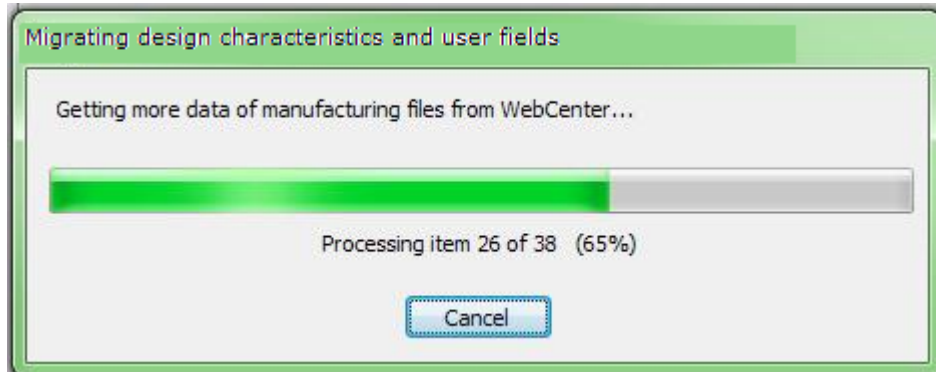

The migration tool converts each document one at a time, assigning the default Attribute categories appropriately. It flags successfully converted documents so if the migration restarts, it can skip them. Once a document is converted, you can not convert it again. If you click **Cancel**, the migration ends with nothing migrated and no mapping saved.

Pre-12.1 Document Maintenance

The Pre-12.1 Document Maintenance group contains tasks that refresh existing WebCenter documents so they are compatible with newer WebCenter features.

Note: If you have pre-10.2 documents, you must do the pre-10.2 conversion before using any of these options.

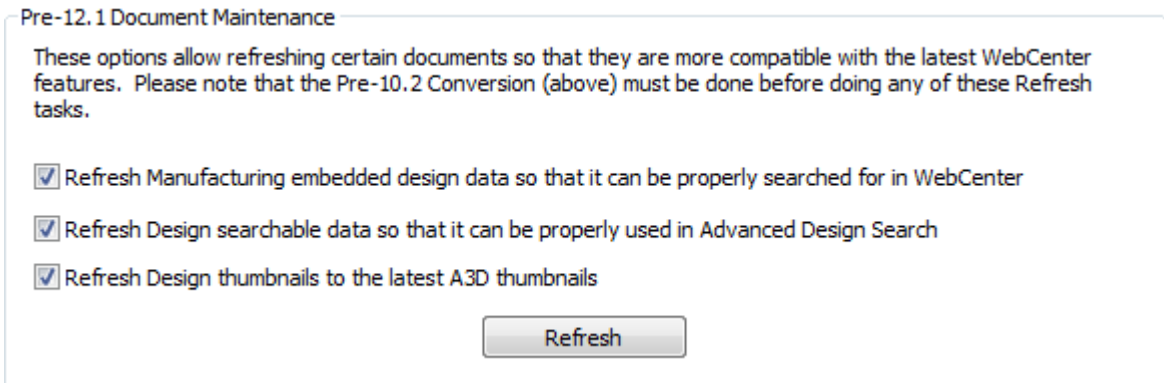

1. Select the checkboxes for the desired options.
 - a) The first option checks existing manufacturing documents in WebCenter and makes sure searchable metadata is configured properly for embedded design searching to work.
 - b) The second option does what it says so that more metadata can be searched using Advanced Search.
 - c) The third option fixes design documents that were migrated in the past before their corresponding 3D documents were migrated and thus have incorrect thumbnails. This option scans WebCenter for later 3D documents and regenerates the thumbnails.
2. Click **Refresh**. Depending on the options you chose in step 1, the migration tool shows various progress bars.

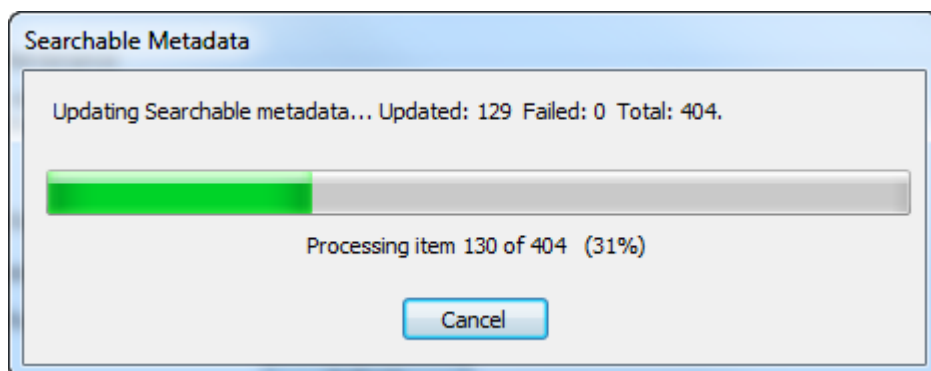
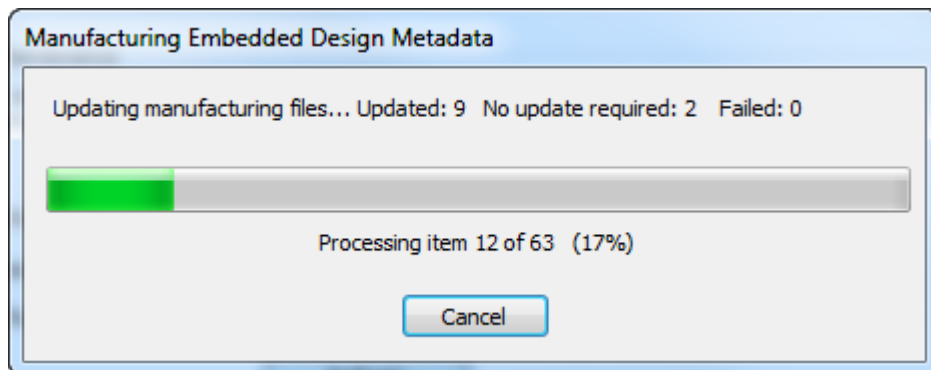

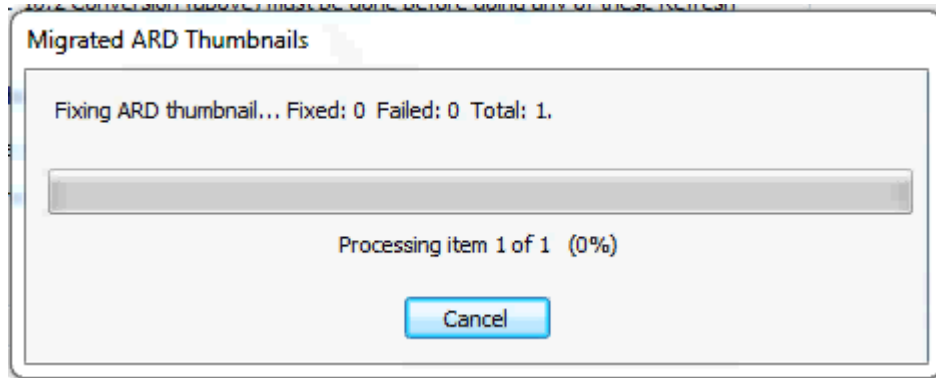

Clicking **Cancel** in any of the progress bar dialog boxes stops the update regardless of which options you chose.

3. The migration tool displays a status dialog box when it is done. Click **OK** to return to the migration tool.

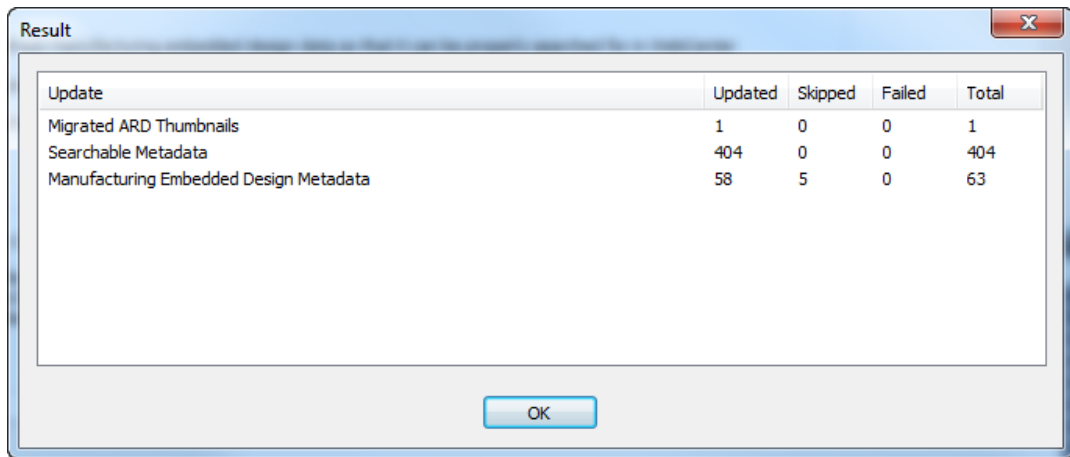

Legacy CAD Data Migration

The command in the Legacy CAD Data Migration group migrates Short Description 1, 2, 3, and similar legacy CAD data to WebCenter entities. It uses the mappings on the Design Data tab.

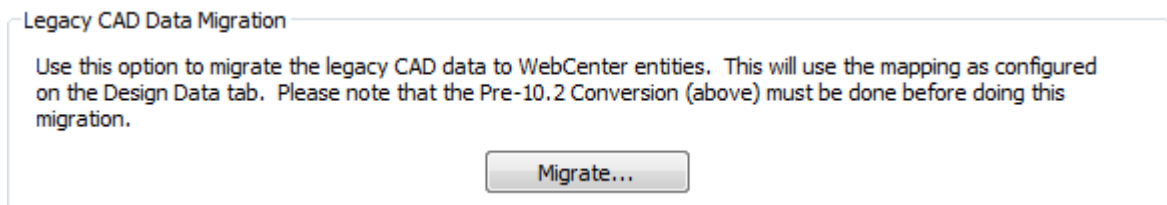

Note: If you have pre-10.2 documents, you must do the pre-10.2 conversion before using this command. You must also do the pre-12.1 document maintenance if applicable.

1. Click **Migrate**. The CAD Data Migration Options dialog box appears.

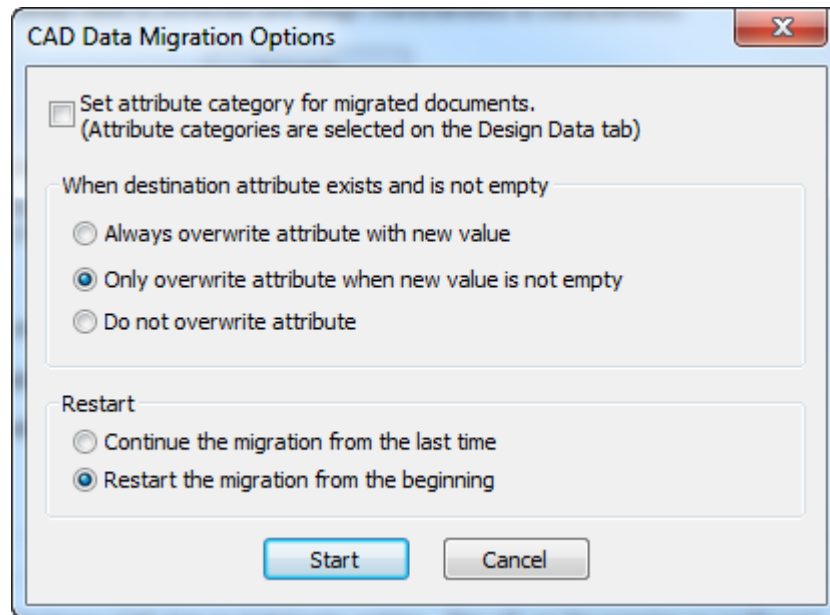

- a) **Set attribute category for migrated documents** uses the settings for the default Attribute categories on the Design Data tab to overwrite the existing Attribute category for a document being migrated.
 - b) In the When destination attribute exists and is not empty group, set the action for the migration tool to take when the Attribute already exists on the WebCenter document - to always overwrite, to overwrite sometimes, or to not overwrite.
 - c) In the Restart group, choose what the migration tool does when you restart it - continue from the last time or start new from the beginning.
2. Click **Start**. A progress bar appears.

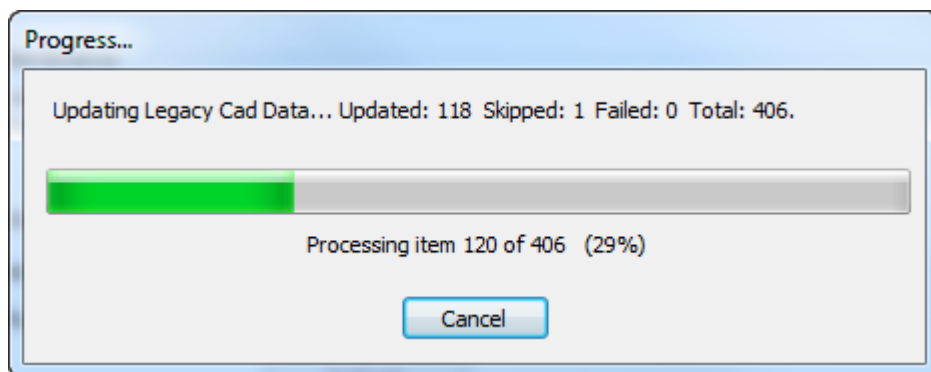

3. When the migration finishes or you cancel it, a results dialog box appears.

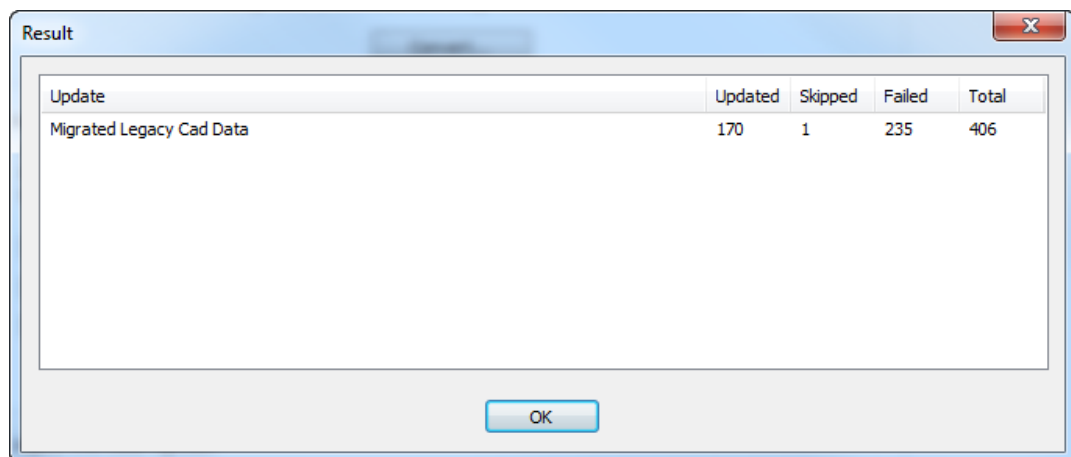

The screenshot shows a dialog box titled "Result" with a close button (X) in the top right corner. Inside the dialog, there is a table with the following data:

Update	Updated	Skipped	Failed	Total
Migrated Legacy Cad Data	170	1	235	406

At the bottom center of the dialog box, there is an "OK" button.

Updated is the number of documents that were migrated. **Skipped** is the number of documents that have already been migrated during this migration session. **Failed** is the number of documents that had errors.

4. Click **OK** to return to the migration tool.

6. Peripherals

ArtiosCAD can output to devices that use a standard Microsoft Windows driver and also to devices simply connected to a port on an ArtiosCAD computer. Devices that do not use a Windows driver use Output Destinations which are configured in the Output Destinations dialog box in Shared Defaults.

Note: This documentation refers to configuring devices in Shared Defaults for all users to access. Configuring a device for use on a single machine in User Defaults follows the same procedure, substituting User Defaults for Shared Defaults.

Installing a Windows printer

ArtiosCAD prints by default to the default Windows printer on the system on which it is running.

For information on installing a printer in the Windows family of operating systems, read the *Setting up a Printer* topic in the *How to...Set Up Hardware* section of Help.

If this is the first printer installed on the system, it is automatically designated as the system default printer. The **Print** command and the **Plot to Printer** output (**File > Outputs > Artios > Printer Output > Plot to Printer**) will use it by default.

To add an Output for a newly-installed printer if it is not the system default printer, do the following:

1. Start ArtiosCAD
2. Open Defaults by clicking **Options > Defaults**.
3. In the Shared Defaults pane, scroll down to **Outputs**.
4. Right-click **Outputs**, click **New** from the context menu, and then click **Data**.

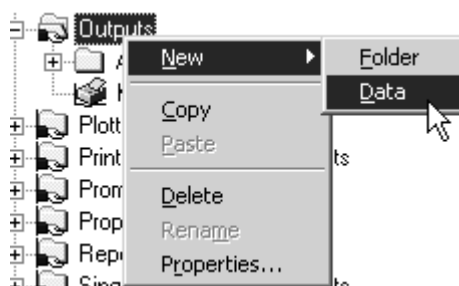

5. Enter a name for the Output such as the name of the printer; for example, **HP DeskJet 560C**.
6. Double-click the new Output just created to open its Property page.
7. The **Device** tab will be selected automatically. Leave the **Output type** set as **Plot** and change the **Scale** to **To fit one page**.

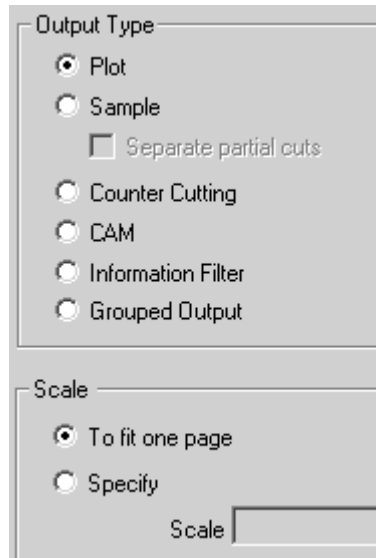

8. Click the **Device** tab. If a dialog box appears with the message **System printer information could not be read**, click **OK**.
9. Under **Windows Driver**, click the drop-down list box arrow and select the newly-created printer.

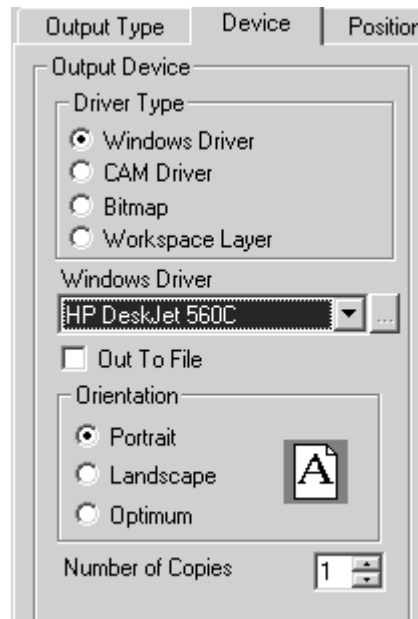

10. Click **OK**, then **File**, then **Save** to accept the printer and save the defaults.
11. Click **Yes** when asked to overwrite the defaults. The printer is now ready for use.

Output Destinations

Output Destinations enable the ArtiosIO program to carry output data from ArtiosCAD to a serial or parallel port. The port can be on the local machine or it can be on a remote computer

on the network. Output Destinations also allow a device to communicate information (such as its size) back to ArtiosCAD.

Output Destinations require the ArtiosIO program to be running on the machine to which the device is connected.

Starting the ArtiosIO program

The ArtiosIO program is installed when ArtiosCAD is installed. It is configured using the **ArtiosIO** applet in Control Panel. Only users with administrative privileges can use this applet and the commands within.



To start the ArtiosIO program and configure it to start automatically each time the computer is rebooted, do the following:

1. Open Control Panel by clicking **Start > Settings > Control Panel**.
2. Double-click the **ArtiosIO** applet. The ArtiosIO Server dialog box will appear.

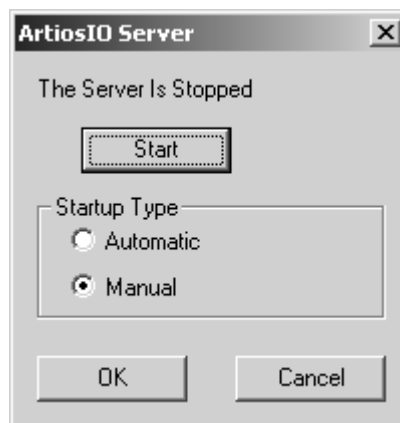

3. Click **Start** and set the **Startup Type** to **Automatic**.

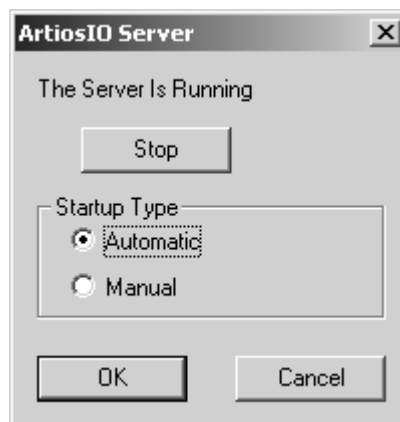

4. Click **OK**.

5. Do this on each computer which has a port to which a device that does not use a Windows driver will be attached.

Creating an Output Destination

Now that the ArtiosIO program is running, you can configure Output Destinations in ArtiosCAD.

1. Start ArtiosCAD.
2. Open Defaults by clicking **Options > Defaults**.
3. Right-click **Output Destination**, click **New** on the context menu, and click **Data**.

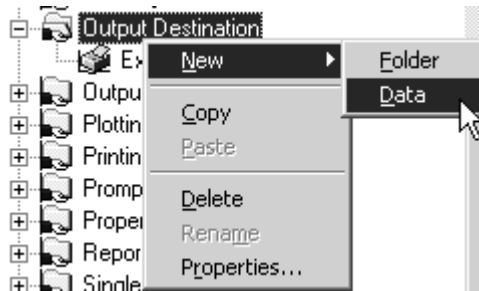

4. Enter a name for the Output Destination. One good way to name it is to use the system name and port name, e.g. ARTCAD LPT1 or SYSTEM4 COM2.
5. Once you have entered a name for the Output Destination, double-click it to open its Property page.



6. Enter the name of the system the port is on in the **Hostname** field.
7. Enter the port name in the **Port**: field. Common port names are COM1, COM2, COM3, and LPT1. The COM ports are serial ports (also known as RS-232 ports) and LPT ports are parallel ports.

8. If the port you are adding is a serial port, set its characteristics in the **RS 232 Parameters** group by choosing the options from the drop-down list boxes. If it is a parallel port, clear the **RS 232 Port** checkbox.
9. The **Short Name:** field is the internal-to-ArtiosIO name of the port and can not be changed.
10. Click **OK** when done.
11. To save these changes, click **File > Save** and click **Yes** to overwrite the Shared defaults.

Installing CAM Devices

Getting started

Use the following steps to configure a CAM (Computer Aided Manufacturing) device with ArtiosCAD. Most CAM devices are equipment such as samplatables, lasers, counter cutters, and so on.

Configuring a CAM device follows this general procedure:

- Pick the output device driver from a master list of known devices. This will tell ArtiosCAD what driver to use and how to tune it. Also check and set the size of the device.
- Specify how the peripheral will receive its instructions. This could be either by creating a disk file or by sending the instructions to a parallel or serial port on one of the computers.
- Configure a plotting style or CAM Tooling Setup catalog entry for the device to use that defines which tools on the device are to be used for each type of line in a design.

You may need to adjust the size and positioning settings copied from the master list.

When this process is complete, you will have an output that can be used by any ArtiosCAD user.

Preliminaries

First, you need answers to the following questions.

- Will you be using a Windows driver or a CAM driver?
- If a CAM driver is being used, what port will the output go to and how will it get there?
- Is there a pre-built output and plotting style/CAM Tooling Setup catalog entry for the plotter / samplemaker you need to set up?

Windows driver or CAM driver?

Use a Windows driver if possible. These should be used for all drawings if suitable and if drivers are available for your device. Many CAM devices operate correctly when driven using the IBM Graphics standard Microsoft Windows printer driver. A CAM driver is used when there is no suitable Windows driver for a device.

Is there a pre-built output and style?

If you have a plotter / samplemaker of a type listed below, there will most likely be a pre-built solution for your plotting and samplemaking needs. You can probably set up the device without going into much of the detail described in this document. If there is not a preconfigured plotting style or CAM Tooling Setup catalog entry, follow the instructions in the *Defaults* chapter to set it up.

Plotter / Samplemaker type	Driver	Notes
Artios Kongsberg samplemakers	KGB	
Artios Advantage Line samplemakers	HP	
Data Tech IPC controller	DT	Can not use print spooler
Data Tech with PC front end	HP / DT	
Elcede Vectocut	ELC / HP	
Elcede IBH controller	ELC	Can not use print spooler
Graphtec	HP	
Devices driven by HPGL	HP	
LKS Speedplot	PPS	
Alphameric	HP	
Wild TA2's and TA10's	WILD	
Wild TA-100 series	HP	
Zeta / Bruning	HP	

Example 1 - Setting up a Kongsberg XL44 samplemaker

In this example, you will learn how to open Example output defaults, copy the required entry or entries to your Shared defaults, and save them. Then, if needed, you will learn how to edit the CAM Device Name to complete the setup.

1. Start ArtiosCAD.
2. Click **Options > Defaults**.
3. Click **User defaults**.
4. Click **File > Open > Example defaults**.
5. You will see folders for **CAM Tooling Setup Catalog, Customized toolbars, Die press parameter sets, Geometry Macro Catalog, Manufacturing Parameter Sets, NC Export Turning Table, Outputs, Plotting Style Catalog, and Subtype Mapping Catalog**. Expand the **Outputs** folder until you find the Output type you are looking for. (For example: **Outputs / Artios / Kongsberg XL22 - FC**.)
6. You will see a number of pre-built Outputs. Select and drag **Kongsberg XL44 - FC sample cutting and matrix** from this side and drop it on the Outputs folder on the Shared defaults side.

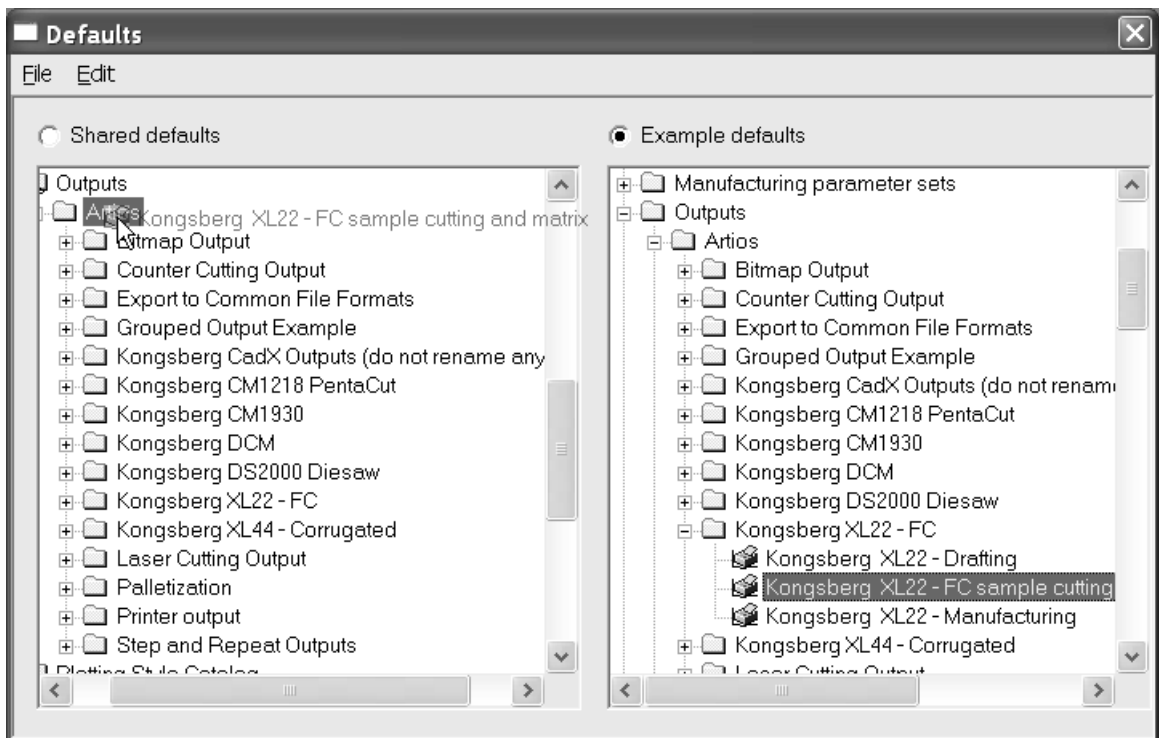

7. Double-click the new entry and click the **Directories** tab. Change the directory entries to the directory that the Kongsberg front end computer will look in.

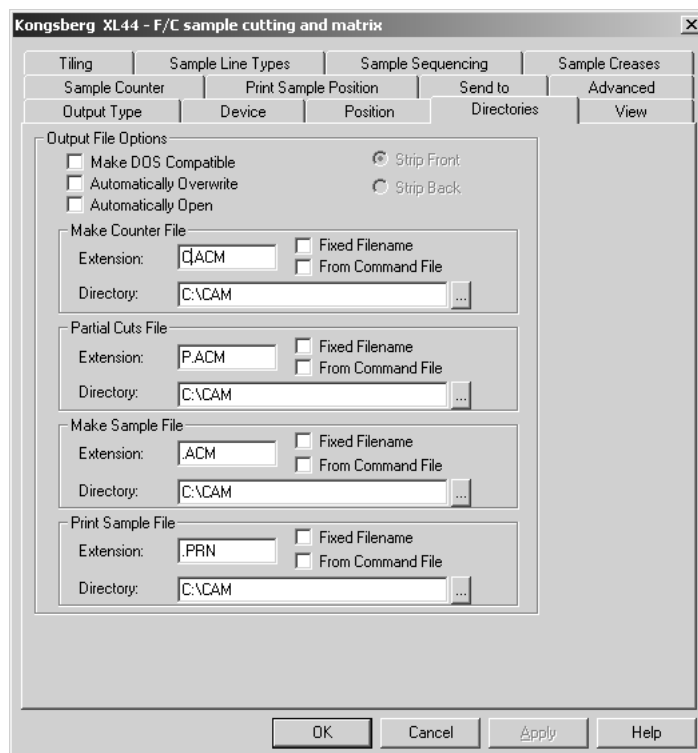

8. Click the **View** tab and note the contents of the **Specify Plotting Style** group. If the plotting style does not exist, its name will be surrounded by parentheses. If the plotting style name

is not surrounded by parentheses, click **OK** and proceed to step 12; otherwise, proceed to step 9.



9. Click **OK** to exit this dialog box.
10. Expand the **Plotting Style Catalog** in Shared Defaults by clicking the plus sign next to it.
11. Look for the plotting style you noted as being used by the Kongsberg. Copy its definition from the Example defaults in the same manner as you copied the definition for the Kongsberg.
12. Make sure the **Shared defaults** button is selected. There will be an asterisk next to it indicating that it has been modified and needs saving. Click **File** and then **Save** to do this. Confirm by clicking **Yes**.
13. Click **File** and then **Exit** to leave Defaults.

You have successfully set up a Kongsberg XL44 Samplemaker.

Example 2 - Setting up an Alphameric RS-232 samplemaker

This type of plotter can use a Microsoft shared print spooler to route the data to the particular computer/port to which the device is connected. This is preferred over using a direct connection to a port on a specific computer since it allows the device to be accessed by anyone who has access to the shared printer.

The first thing to do is set up the print spooler. Use a generic printer driver that does not modify data, such as the IBM Graphics printer driver. This driver is part of the standard driver set provided with the operating system.

1. Set up a printer on the appropriate port. Make sure that the baud rate and other RS-232 properties are set up to suit the plotter interface.
2. Let us assume that you have set up a shared printer on the computer called brunnhilde with a share name of alphameric. Add a networked printer to your system that points to that shared printer.
3. Follow the steps from Example 1, selecting the appropriate entry in Example CAM Outputs for The Alphameric Corp instead of Artios. Select the appropriate plotting style. (CAM.ALPHAMERIC)
4. Double-click the Output you just copied. Click the **Device** tab.
5. Click the Browse button (...) at the end of the **CAM Device Name:** field to open the Output Destinations dialog box.
6. Expand the **System Printers** folder by clicking the plus sign (+) next to its name.
7. Select the entry matching the printer queue, for example the \\brunnhilde\alphameric entry, and click **OK**.

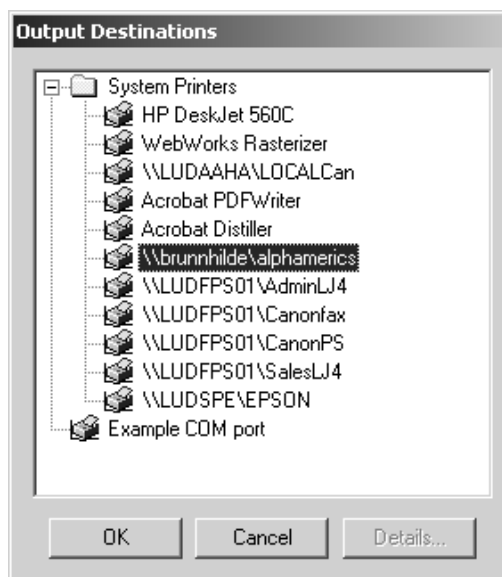

8. You are now done. Click **OK** to exit this dialog.
9. Clear the **Out To File** checkbox.
10. Make sure the **Shared defaults** button is still selected. There will be an asterisk next to it indicating that it has been modified and needs saving. Click **File** and then **Save** to do this. Confirm by clicking **Yes**.
11. Click **File** and then **Exit** to leave Defaults.

Example 3 - Adding a Calcomp DrawingBoard III digitizer

Digitizers are somewhat different from other CAM devices as they are input-only devices. They generally come in two pieces - a flat tablet and a mouse-like puck with buttons on it.

Note: DO NOT load operating system drivers for the digitizer! They will prohibit ArtiosCAD from accessing the digitizer!

Table: Suggested Digitizer Communication Settings

Digitizer settings	Suggested setting
Baud rate	4800
Data bits	8
Parity	None
Stop bits	0
Data Mode	Point mode (Required)
Data format	CALCOMP 9100-1 format compatible

Digitizer settings	Suggested setting
--------------------	-------------------

(APbxxxxxyyyy)

If choosing one of your own, it must be ASCII.

Digitizer step size 1000 lines/inch or 50 lines/mm

To install the digitizer, do the following:

1. Connect the digitizer to any free serial port (use COM1 for the purposes of this example) and supply it with power. Configure it to match the communications settings listed above.
2. Create an Output Destination for this port and if the serial port is on a remote computer, make sure ArtiosIO is running on the remote machine.
3. Start ArtiosCAD and then click **Options > Defaults**.
4. Open the **Digitizer Setup Catalog** and select either **Calcomp 16 Button** or right-click and create a new data item with the name of your digitizer.
5. Select the **Digitizer Parameters** tab.

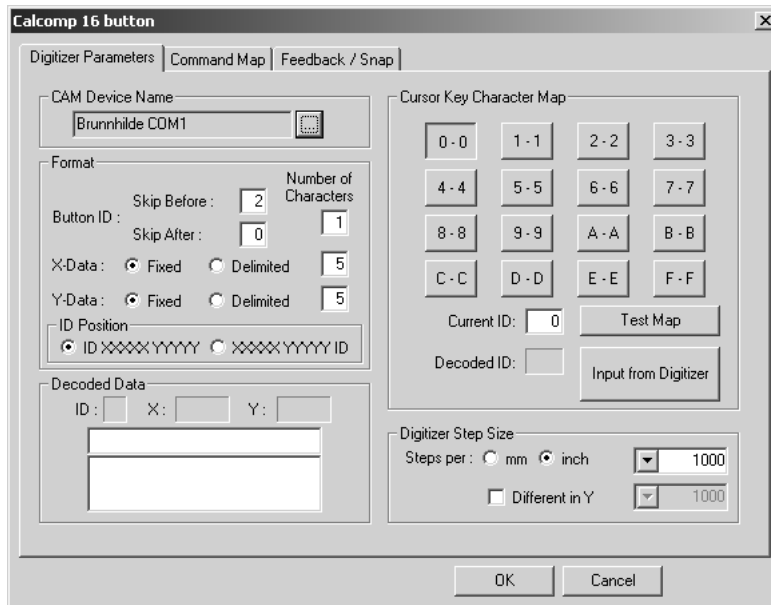

6. Make sure the correct Output Destination is selected in the **CAM Device Name** field.
7. Make sure the settings in the **Digitizer Step Size** group match the settings on your digitizer.
8. Press buttons **0, 1** and **2** on the puck. The **Decoded Data** group should look similar to the picture shown below:

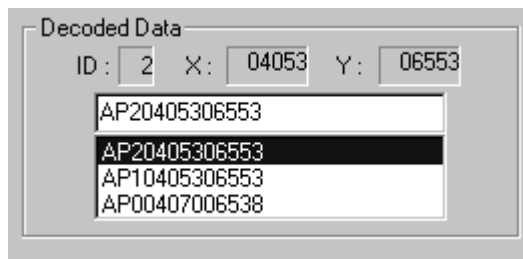

Look carefully at the third character in each line of data. Starting from the top, it should correspond to the button you pressed on the puck.

Repeat this for buttons 3-F. Each digit should match up. If it doesn't, your digitizer uses a different data format.

The digitizing menu to the left is the default digitizing menu for a Calcomp digitizer. Photocopy it at full scale or plot ..\InstLib\DIGITIZER_MENU.ARD at full size. You will need it for the next step.

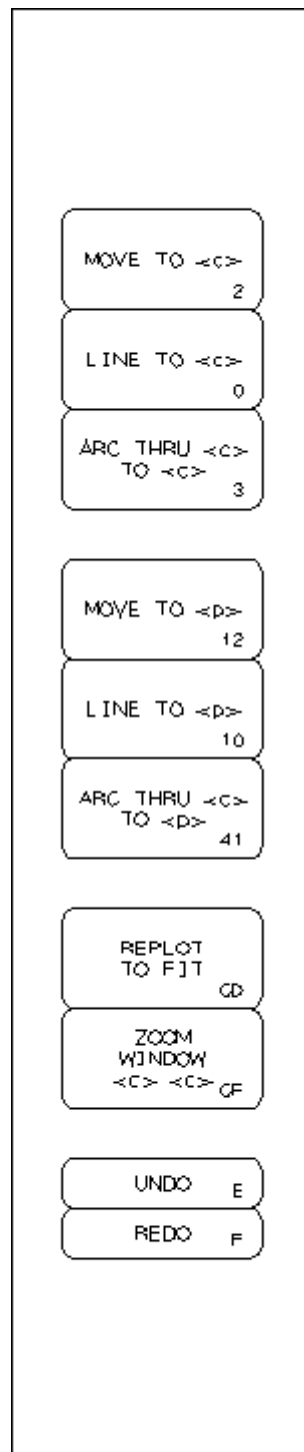

1. Click the **Command Map** tab.

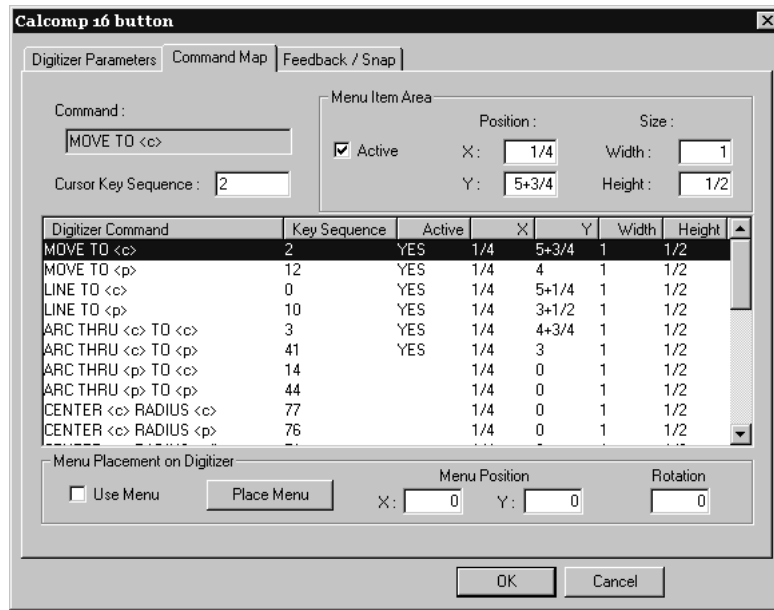

2. Tape the menu to one side of the digitizer surface.
3. Select the **Use Menu** checkbox so that it is checked, and then click **Place Menu**.

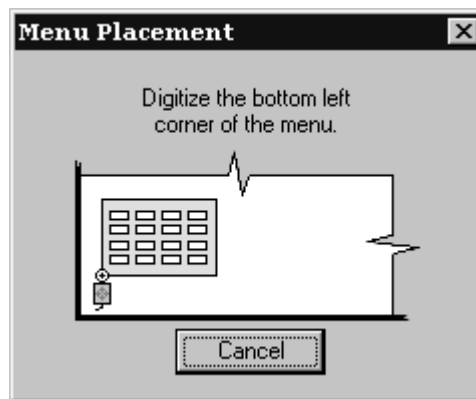

4. Move the cross-hair on the digitizing puck to the bottom left corner of the menu and click any button.
5. The puck position in the dialog box will change. Move the puck to the bottom right corner of the menu and click any button. The **Menu Position** and **Rotation** fields will now have values in them.

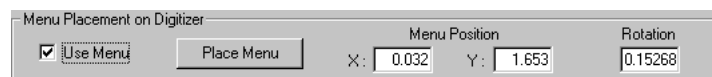

6. Click **OK** to close the Calcomp 16 button dialog box.
7. Click **File**, and then click **Save** to save the changes made to Shared Defaults. Click **Yes** when asked to confirm the operation.

8. Exit Defaults. Your digitizer is now ready for use.

Example 4 - Setting up an i-cut Production Console Output

ArtiosCAD can Output a single design or a manufacturing file to a Kongsberg samplemaker's front end computer running the i-cut Production Console. ArtiosCAD Outputs a ZIP archive containing a copy of the workspace run through the information filter and a JDF file to a submit folder on the front end which the i-cut Production Console monitors. The table operator can then process the job.

Note: The submit folder on the front end is usually a subfolder of the user who installed the i-cut Production Console. It also is not shared on the network as part of its installation. **YOU MUST KNOW THE EXACT LOCATION OF THIS FOLDER AND HAVE A PUBLICALLY WRITABLE NETWORK SHARE CREATED ON THE FRONT END FOR IT.**

An iPC Output is a Grouped Output containing three individual Outputs:

- **iPC - ArtiosCAD File**
- **iPC - JDF-V2**
- **iPC - Submit Job-V2** (or **V3** if you work with filenames in non-English languages). This is the Output you click in ArtiosCAD.

iPC Output - Copying the Example Output

The first step in creating an iPC Output is to copy the example one to one you can modify.

1. Start ArtiosCAD.
2. Click **Options > Defaults**.
3. In Shared Defaults, expand the **Outputs** catalog and the **Artios** folder within it.
4. Right-click **iPC** and click **Copy** on the context menu.
5. Right-click the **Outputs** catalog and click **Paste iPC** on the context menu.
6. Scroll down, right-click **Copy of iPC**, click **Rename** on the context menu, and enter a new name.
7. Open the folder of the new Output and rename each entry by right-clicking it, clicking **Rename** on the context menu, and entering a new name. Make sure to keep the root name of the Output the same so that you know what it does.

iPC Output - Modifying the ArtiosCAD File Output

The next step is to modify the ArtiosCAD File Output so that you do not get prompted for a filename to save the workspace as while running the Output.

1. In the expanded iPC Output, double-click the renamed **ArtiosCAD File** to open it.
2. On the Output Type tab, enable **Omit Output Confirmation Dialog**.
3. Click **OK** to return to Defaults.

iPC Output - Modifying the JDF-V2 Output

The next step in setting up an iPC Output is to modify the JDF Output.

1. Expand the iPC Output you made in the previous section.
2. Double-click the renamed **iPC - JDF-V2** to open it.
3. On the Advanced tab, in the iPC System Name field, enter the system name of the Kongsberg front end running the i-cut Production Console. It can be its hostname, its fully qualified domain name, or its IP address.

The screenshot shows a dialog box titled "Prompt for Kongsberg Material". It has a checked checkbox at the top left. Below it are two radio button options: "Use Material List from Text File (KGBMaterialList.txt)" and "Use Material List from iPC Resource Database". The second option is selected. Under the second option, there is a text field labeled "iPC System Name" containing the text "DOCVMUSWC01". There is also a checkbox labeled "Specify path to Material list file" which is unchecked, followed by a text field and a browse button (three dots).

4. Click **OK** to return to Defaults.

iPC Output - Modifying the Submit Job-V2 or -V3 Output

The next step in creating the iPC Output is to enter the name of the watched folder on the Kongsberg front end.

1. In the expanded iPC Output, double-click the renamed **iPC - Submit Job-V2** or **iPC - Submit Job-V3** to open it.
2. On the Grouped Outputs tab, delete the default entries in the list of outputs and replace them with the renamed ones in your renamed Output. There should be two, first **ArtiosCAD File** and then **JDF-V2**. Each should be set to **Zip, Insert into Zip archive**, and **Delete output disk file**.

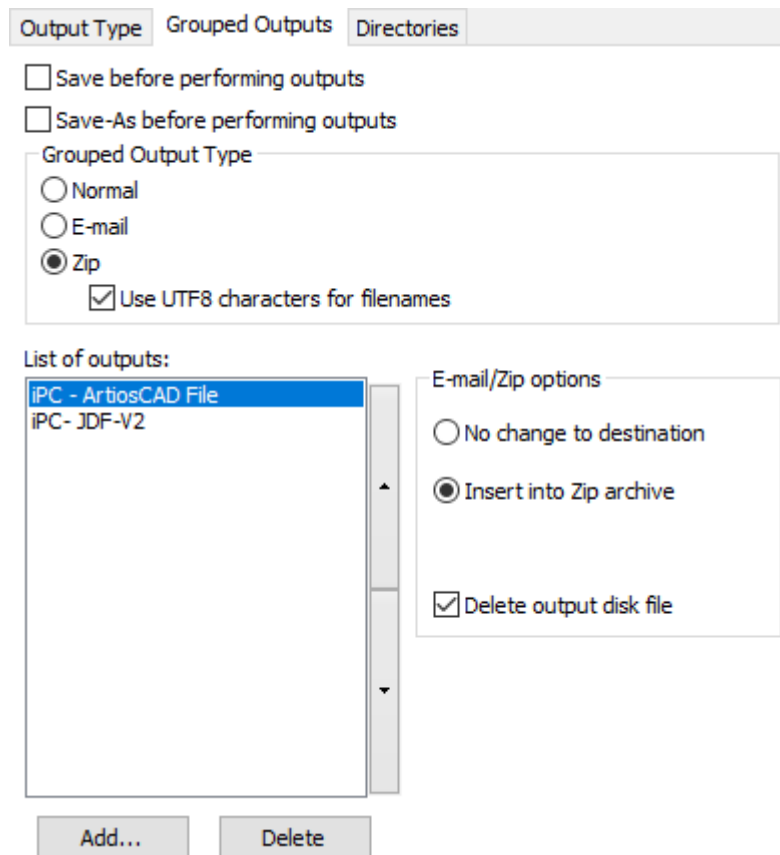

3. On the Directories tab, in the Directory field in the Output File group, enter the UNC for the watched folder on the Kongsberg. Also, enable **Omit Save-As Filename Dialog** if you do not want ArtiosCAD to prompt you for a filename every time you run the Output.

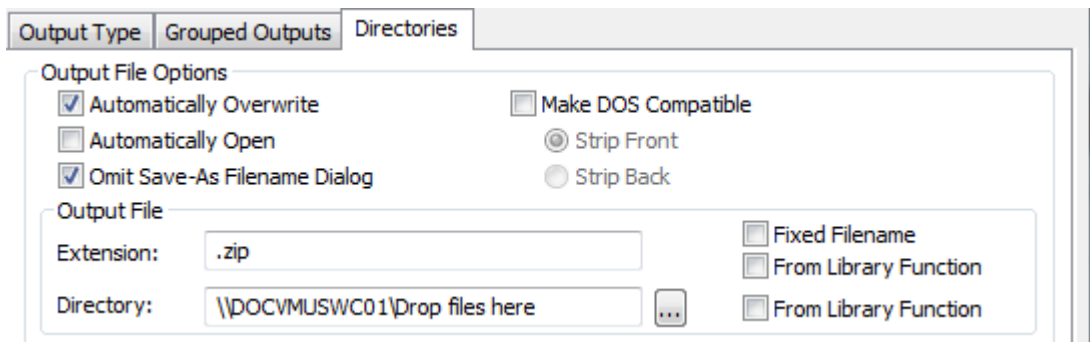

4. Click **OK** to return to Defaults.
5. Save and exit Defaults, confirming the overwriting of existing Shared Defaults.

The Output is now ready for use. Shown below is a submitted job in i-cut Production Console.

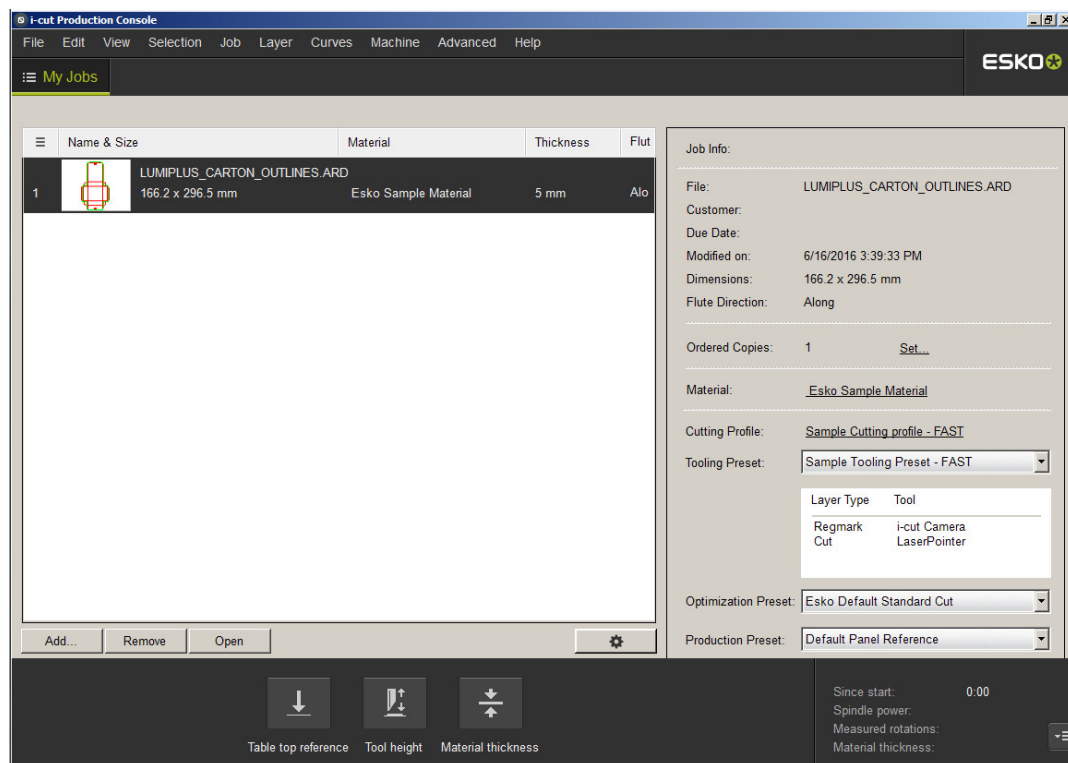

Advanced digitizer setup

Adding a non-Calcomp digitizer

If you are not using a Calcomp digitizer, the digitizer must meet these requirements:

- The digitizer must be connected via an RS-232C (serial) port on the PC.
- The digitizer must be set to **Point** mode. This means that only one set of positional data is sent when a puck button is pressed.
- The data produced when a button on the puck is pressed must contain one or two characters representing which button was pressed and also strings of numbers indicating the position of the puck when the button was pressed. The data sent must be ASCII, not binary, and must be separated by a carriage return (CR), line feed (LF), or both (CR/LF).

While not required, ArtiosCAD is easier to configure if the digitizer data is in a fixed format.

Once you have the digitizer connected, configured, and turned on, do the following:

1. Start ArtiosCAD and then click **Options > Defaults**.
2. Add an Output Destination for the port the digitizer is connected to.
3. In the Shared Defaults pane, right-click the **Digitizer Setup Catalog** and click **New**, and then click **Data**. Enter the name of the digitizer, press enter, and then double-click it to open its property page.
4. Select the proper Output Destination in the **CAM Device Name:** field.
5. Press a few buttons on the digitizer puck. You should see some data appear in the **Decoded Data** group.

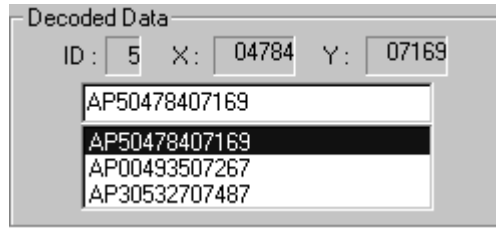

The data format should be similar to one of the entries in the **Data String** column in the table below. The letters **b** and **c** indicate button data and should always be a digit between 0-9 or a letter between A-F.

Table: Alternate Digitizer Data Formats

Data String	Button ID			X-Data format		Y-Data format		ID position
	Before	After	No.	Fixed/ Delim	No	Fixed/ Delim	No	
APb1111122222 APc5555566666	2	0	1	F	5	F	5	ID x y
APb 1111 2222 APc 5555 6666	2	0	1	F	5	F	5	ID x y
APbV +1234 -12 APcV +5678 +123	2	1	1	F	6	F	6	ID x y
PQbb00012-00034+ PQcc00562+00029+	2	0	2	F	6	F	6	ID x y
	0	0	1	F	6	F	6	x y ID

Data String	Button ID			X-Data format		Y-Data format		ID position
	Before	After	No.	Fixed/ Delim	No	Fixed/ Delim	No	
<div style="border: 1px solid gray; padding: 2px; margin-bottom: 5px;">123 456 b</div> <div style="border: 1px solid gray; padding: 2px;">197 1276 c</div>								
<div style="border: 1px solid gray; padding: 2px; margin-bottom: 5px;">b 123 345</div> <div style="border: 1px solid gray; padding: 2px;">c 1234 567</div>	0	0	1	D		D		ID x y
<div style="border: 1px solid gray; padding: 2px; margin-bottom: 5px;">123,456,b</div> <div style="border: 1px solid gray; padding: 2px;">87,10,c</div>	0	0	1	D		D		x y ID

Once you have determined which format the data is in, set the options in the **Format** group accordingly.

Format

Button ID : Skip Before : Skip After : Number of Characters :

X-Data : Fixed Delimited

Y-Data : Fixed Delimited

ID Position : ID XXXXXYYYYY XXXXXYYYYY ID

Press buttons on the digitizing puck and check that the appropriate data is appearing in the **Decoded Data** group. If it is not, adjust the format options until they do.

Decoded Data

ID : X : Y :

AP50478407169

AP50478407169

AP00493507267

AP30532707487

- Now that the formatting is set correctly, check the Cursor Key Character Map. As you press a button on the digitizing puck, the corresponding key should appear pressed on screen:

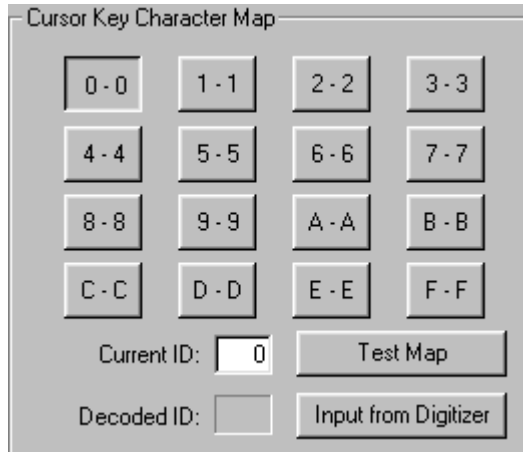

The default configuration assumes the ID character generated matches the name of the button pressed on the digitizing puck.

In most cases, the button named **F** always produces character **F** in the data string, but there are digitizers that generate characters other than those expected. For example, some generate the characters ; : and > for keys D, E and F and have a map like the one shown below:

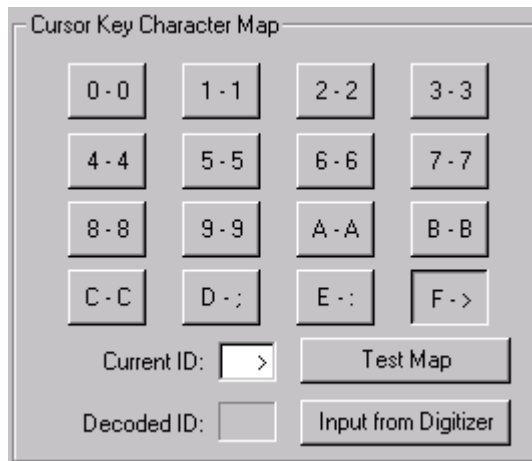

You can manually set the character map by clicking the on-screen button and replacing the value in the **Current ID** field with the one or two characters produced by the digitizer when the button on the digitizing puck is pressed. Repeat this procedure for each button on the digitizing puck.

You can also set the character map using only the input from the digitizer. First, make sure the formatting is set correctly. Next, click the on-screen **0** button and then click **Input from Digitizer**. Click the **0** button on the digitizing puck to enter the value for 0. The 1 on-screen button will then be automatically selected, so press the **1** button on the digitizing puck.

Repeat for the rest of the buttons. If you make a mistake, simply click the on-screen button you wish to reprogram, and press the appropriate button on the digitizing puck.

- Now that the character mapping is configured, test it by clicking **Test Map**. As you press buttons on the digitizing puck, the corresponding on-screen buttons should appear pressed.

Adjusting the step size of the digitizer

Over time, you may notice that your digitized geometry is not as accurate as you desire. While your digitizer may be set to have 1000 lines of resolution per inch, by digitizing a 10-inch square **with extreme accuracy** which results in a 10.03 by 10.06-inch square in ArtiosCAD, you realize that it is out of calibration. The solution to this is to adjust the step size. Open the entry for the digitizer in Defaults and adjust the entries in the **Digitizer Step Size** group.

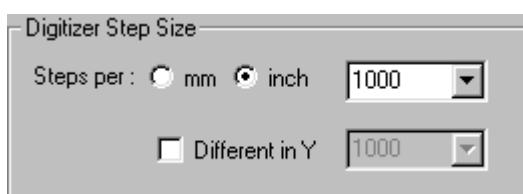

Using the values stated in the previous paragraph, change the 1000 in the drop-down list box to **1003**, click the **Different in Y** checkbox, and change the 1000 in that drop-down list box to **1006**.

Configuring the Command Map

Digitizing has 26 commands. Each can be assigned a digitizer puck key sequence and/or a digitizer Menu Item Area. If you wish to use the command while digitizing, you must assign either a Key Sequence and/or a Menu Item Area to the command. (If you think you will never use some of the commands, you may choose to leave them unassigned.)

The following abbreviations are used in the table below:

- <c>** A coordinate on the digitizer.
- <p>** An existing point. These are the end points (and intersection points) of existing lines in the current design whether just digitized, or part of the original structure. To select such a point, you must digitize a point on the digitizer within snap distance of one of these points.
- <l>** An existing line. To select such a line, you must digitize a point on the digitizer within snap distance of an existing line in the design.

Table: Digitizer Commands

Key sequence	Command
2	MOVE TO <c>
12	MOVE TO <p>
0	LINE TO <c>

Key sequence	Command
10	LINE TO <p>
3	ARC THROUGH <c> TO <c>
41	ARC THROUGH <c> TO <p>
14	ARC THROUGH <p> TO <c>
44	ARC THROUGH <p> TO <p>
77	CENTER <c> RADIUS <c>
76	CENTER <c> RADIUS <p>
7A	CENTER <c> RADIUS radius
66	CENTER <p> RADIUS <c>
67	CENTER <p> RADIUS <p>
6A	CENTER <p> RADIUS radius
52	INTERSECT <l> <l>
51	INTERSECT <l> <l> KEEP 1st
BBB	BLEND <l> <l> THROUGH <c>
BB1	BLEND <l> <l> THROUGH <p>
BBA	BLEND <l> <l> RADIUS radius
D	DELETE <l>
E	UNDO
F	REDO
CD	REPLOT - SCALE TO FIT
CC	REPLOT - CURRENT SCALE
CA	ZOOM BACK
CF	ZOOM WINDOW <c> <c>

All of these commands are mapped in the Command Map tab of the digitizer's property page in Defaults.

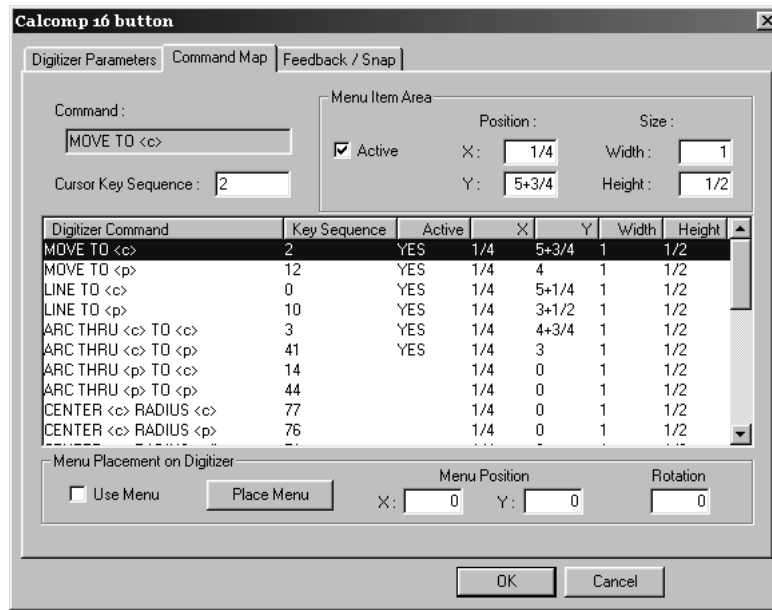

To set a key sequence, select the command you wish to assign to the key, and then type the key sequence to use it with in the **Cursor Key Sequence** field.

The sequence must be comprised of the characters 0–9 A–F. It may be up to six characters long.

A key sequence must be unique and may not mask another command. For example, if you wish to use the Key Sequence 2 for a command, no other Key Sequence may start with 2. This is because 2 by itself matches a command, and therefore masks a key sequence like 21.

The exception to this is when two commands differ only in what is selected — a coordinate, a point, or a line. In this case the commands may share a command sequence. If this is used, the command will snap to a point if one is within snap distance, or to a coordinate if one is not.

While editing this property page, you may temporarily have conflicts as described above. This is so you can easily change Key Sequences, or swap them to different commands. However, you will be warned about them as they are created. You may not exit the property page without resolving such conflicts.

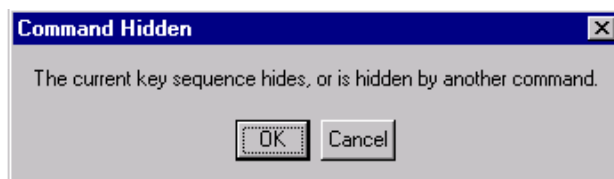

Some commands that are not turned on by default might be very useful for your work — for example, gasket makers may want to turn on the Center tools to make circle creation easier.

Configuring the menu

You can define areas on the digitizer that act as buttons that when clicked perform any of the digitizing commands. A **Menu** is a group of such Menu Item Areas. A Menu Item Area is

defined by the X and Y values adjacent to each area and the width and height of each area. These areas are best defined in Quadrant I (+X, +Y) with the origin of the digitizer in the bottom left corner.

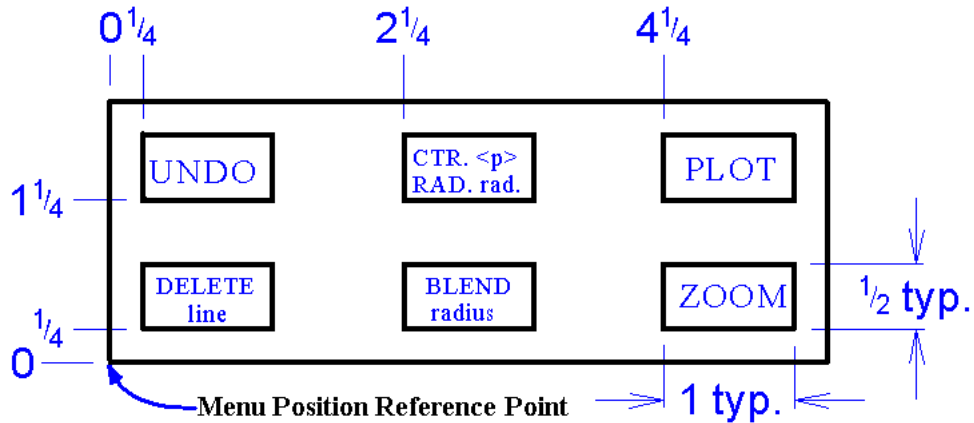

The Menu Item Area values for the above menu are shown in the following table.

Menu Item Area	X	Y	Width	Height
DELETE <I>	1/4	1/4	1	1/2
UNDO	1/4	1+1/4	1	1/2
BLEND radius	2+1/4	1/4	1	1/2
CTR. <p> RAD. radius	2+1/4	1+1/4	1	1/2
ZOOM	4+1/4	1/4	1	1/2
PLOT	4+1/4	1+1/4	1	1/2

Make sure that the **Active** checkbox is selected or the Menu Item Area will not be active.

Use ArtiosCAD's drafting features to draw the menu you have programmed. Print it out at full scale and tape it to the digitizer in the desired position. Then use the **Place Menu** button on the Command Map tab to place the menu.

Configuring Feedback and Snap

The **Feedback/Snap** tab of the digitizer's Properties dialog box lets you set the snap tolerance of the digitizer, the default radius, and the sounds heard when digitizing.

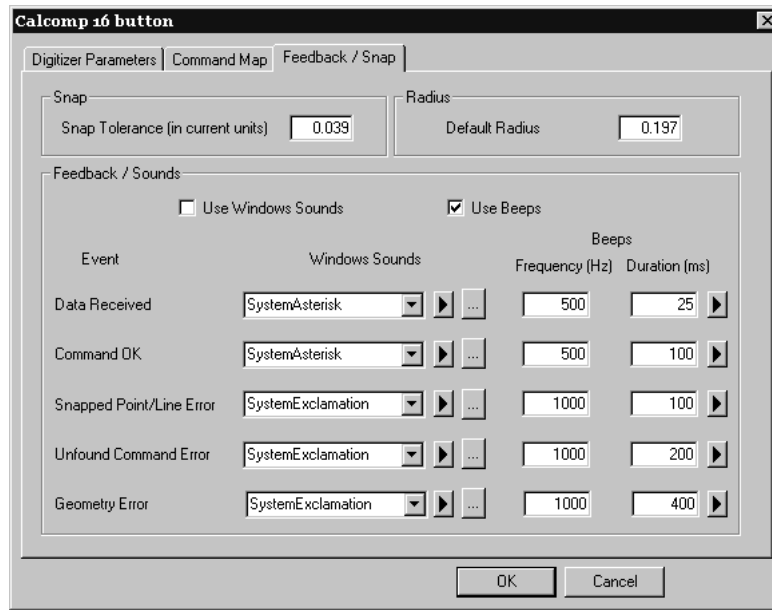

When digitizing a point to satisfy a snap point <p> or a snap line <l>, you need to be within the Snap Tolerance. If you are working on large corrugated designs, you may wish to set this value to something like a quarter-inch or five millimeters. Since the command indicates whether a snap point/line is expected, this value can be considerably larger than the normal screen snap value.

The **Default radius** field is used by some of the BLEND and CENTER commands. Set a sensible default; it is easily changed while digitizing.

The **Feedback / Sounds** group controls the audible feedback generated while digitizing. There are five types of feedback. Windows Sounds require a sound card in the computer; beeps can be made by most computers.

Table: Digitizing Feedback

Type of feedback	Meaning
Data Received	Data received from the digitizer. If your digitizer beeps when a puck button is pressed, you may wish to turn this off.
Command OK	The command was successful.
Snap Point/Line error	You were too far away for a snap point <p> or snap line <l> to be found.
Command not recognized	The key sequence does not match any of those defined.
Geometry Error	The command failed because the geometry could not be performed. (e.g. A blend would not fit.)

The fields in the **Windows Sounds** column designate which sound to use as defined in the Sounds control panel applet.



When clicked, the triangle button plays a sample of the sound or beep.



The ellipsis button lets you browse for a different sound file.

The frequency and the duration of the beeps can be set using the appropriate fields.

7. Other tasks

Uninstalling ArtiosCAD

Uninstall ArtiosCAD by using the Programs and Features applet in Control Panel. Select it in the list of programs and click **Uninstall**. You may be prompted that a reboot will be required to complete the uninstallation.

Removing individual ArtiosCAD Programs

To remove individual parts of ArtiosCAD such as the ArtiosCAD 3D Data Exchange feature, perform a **Modify** and de-select the ArtiosCAD Programs to remove. After uninstallation there may be files from these components left behind in the ..\Esko\Artios and ..\Esko\Artios\ArtiosCADn.nn folders; these files may be safely deleted if desired after all ArtiosCAD versions are removed.

Uninstalling SolidWorks separately from ArtiosCAD

If you have purchased the SolidWorks option and need to remove the SolidWorks Original Equipment Manufacturer software without uninstalling ArtiosCAD, run \ArtiosCAD\SolidWorksRemove.bat on disk 1 of the ArtiosCAD media. SolidWorks OEM software is normally removed when the version of ArtiosCAD that installed it is removed and no other versions of ArtiosCAD are using it. This is different from removing the SolidWorks Import/Export component of ArtiosCAD in that it actually deletes the SolidWorks software from the system, not just the portions of ArtiosCAD that interface with it.

Removing MSDE

Uninstall the ArtiosCAD MSDE database program files by using the Add/Remove Programs applet in Control Panel. Select **Microsoft SQL Server Desktop Engine (ARTIOSCADDB)** from the list of installed programs and click **Remove**.

Uninstalling the database software does not remove the database data files stored in ..\Esko\Artios\DataCenter\MSDE. This is intentional in case you want to resume using MSDE. If you will

not be using MSDE again, you may delete the ..\Esko\Artios\DataCenter\MSDE folder and its contents.

Removing the ArtiosCAD ODBC entry

Once all versions of ArtiosCAD are removed, open the **ODBC/Data Sources** applet in **Control Panel > Administrative Tools**, click the **System DSN** tab, and remove the ArtiosCAD datasource entry by selecting **ArtiosCAD** and clicking **Remove**.

You must remove the existing ArtiosCAD ODBC entry after uninstalling all versions of ArtiosCAD if you wish to change ArtiosCAD database types in a subsequent installation.

Uninstalling a patch

To uninstall a patch, remove that particular build through Programs and Features in Control Panel.

ArtiosCAD will revert to the build that was present before the patch was loaded.

Modifying and Repairing ArtiosCAD

You can modify or repair the ArtiosCAD installation by clicking **Change** in the **Add/Remove Programs** applet in Control Panel, and then by choosing **Modify** or **Repair**. **You must use the original ArtiosCAD media, or use the same network location, as when you first installed the software.**

Modify allows you to change the installed features and options as if you were performing an Advanced installation.

Repair looks for missing or corrupt files and replaces them as necessary. It will not overwrite Defaults. You will be given the same License Disk options as when you first installed the software. If you are trying to repair the licensing information choose **Yes, I have licensing information to apply** and use the licensing diskette, otherwise choose **License information already applied or unavailable** to keep your current licensing information.

Loading an ArtiosCAD patch

ArtiosCAD patches are installed using a single executable file. To install a patch, do the following:

1. Log on as **Administrator**, or as a user with local administrative privileges.
2. Using Windows Explorer, double-click the patch file. Patch files are named ArtiosCAD<version and build number>.exe, such as ArtiosCAD7.1Build497.exe.
3. In the Welcome dialog box, click **Update >**.
4. A status bar will appear showing the progress of the patch installation.

5. Click **Finish** in the InstallShield Wizard Completed dialog box. The patched version of ArtiosCAD is now ready for use.
6. Log off the system.

Working with the ArtiosIO Status program

The **ArtiosIO Status** program is on the Start menu in the ArtiosCAD folder. It queries the ArtiosIO program on a given machine and displays the active connections to that machine. Using it, you can close a connection that is no longer responding.

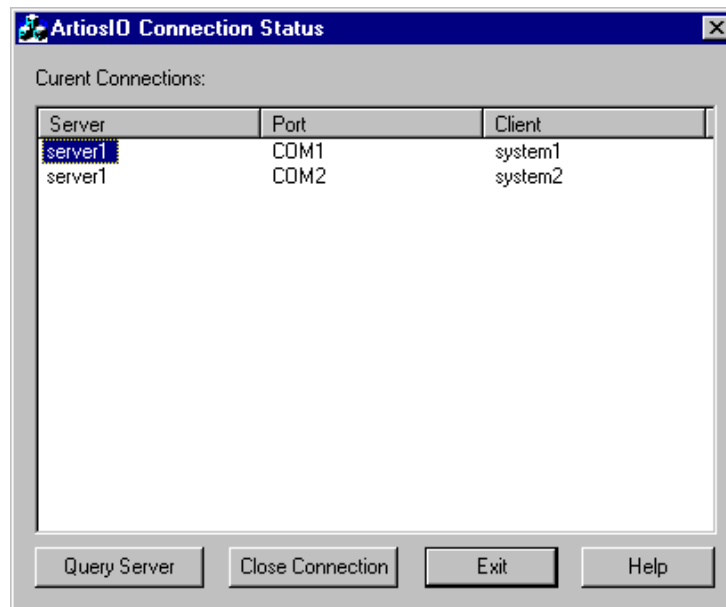

To view the connections on a machine, click **Query Server** and either enter the name of the system to query, or click the drop-down list button to view a list of available machines on the network. Only machines in the same domain will be shown.

To close a connection, highlight it and click **Close Connection**.

Using Floating Licenses

Floating licenses allow ArtiosCAD users to share software licenses among computers. Each license is accessed on an as-needed basis.

ArtiosCAD allocates licenses based on the active tools and toolbars. Tools and toolbars for which licenses are unavailable will either be unavailable or a dialog box similar to the one shown below will appear. The dialog box lists which users and systems have allocated the licenses you need. You can either go ask someone to give up the license you need and click **Wait for License**, or you can click **Cancel** and return to the previous tool you were using.



Release licenses by exiting the design, manufacturing file, or 3D workspace which took the license.

If you click **Wait for License**, a dialog box showing the needed license appears:

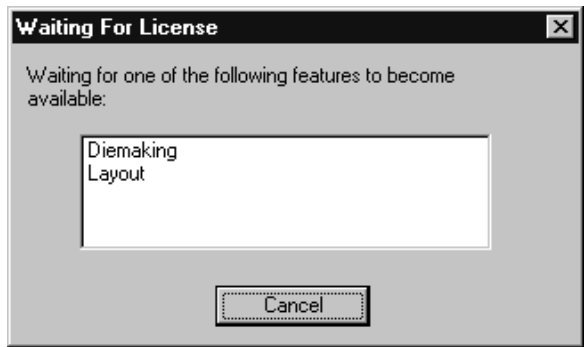

When a license becomes available, this dialog box disappears and the desired feature is activated.

Configuring floating licenses

The **Floating License Configuration** program in the **Esko > ArtiosCAD** program group on the ArtiosCAD License server lets you allocate floating licenses. You can reserve or deny licenses to certain systems. When started, the program initially appears similar to the following dialog box (but with your specific licenses listed):

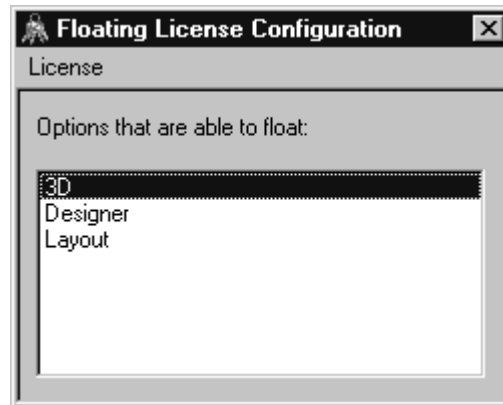

Double-click a license to configure it. A dialog box will appear in which you can reserve and deny licenses:



Reserving a license means that the system you specify will always have the license reserved for it. **Denying** a license means that the system you specify will never be able to have a license. To specify a system, click **Add**. Enter the short name of the system exactly as it is shown on the Computer Name tab of the System applet in Control Panel. The short name is the first word up to the period - the full name minus the domain name. For example, if the full name of the system is ArtCad1.plasticangelcontainers.com, the short name is ArtCad1. Make sure to match the case exactly, as it will not work otherwise. Once you have entered the name, click **OK**.

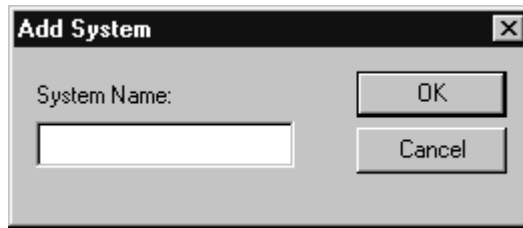

To remove a system from either the **Reserved** or **Denied** lists, select it, click **Remove**, and click **OK**.

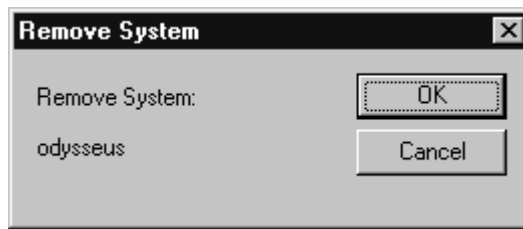

When you have finished configuring the license as desired, click **OK** to return to the Floating License Configuration dialog box, or click **Cancel** to ignore the changes you made.

To exit the Floating License Configuration dialog box, click **License**, and then click **Exit**.

Note: If you have made changes to the configuration, the License Manager will be shut down and restarted when you exit the Floating License Configuration program. **It takes the Elan License Manager three minutes to restart after shutting down.**

Troubleshooting

If you have trouble using a desired feature and get a dialog box like the one below, use either the **ArtiosLM** applet in Control Panel or the ArtiosCAD License Management utility on the ArtiosCAD License server to make sure the server is running.

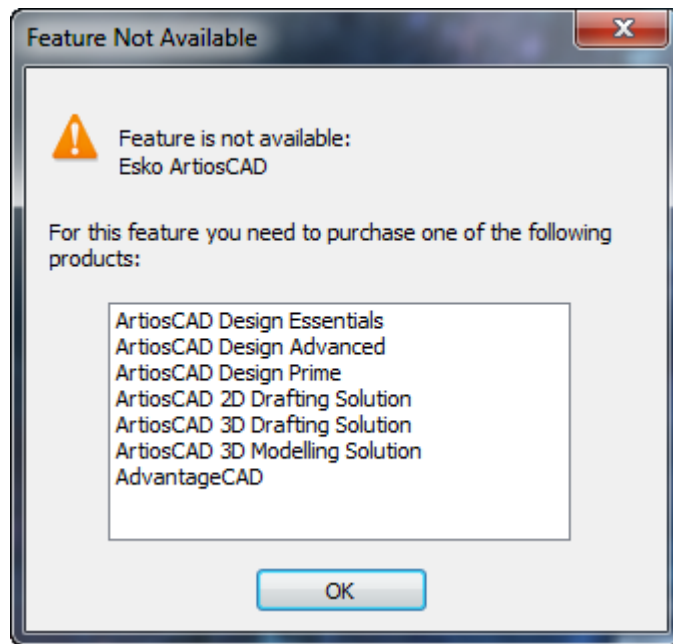

If the Floating License Utility does not start, it is because there are no floating licenses to configure.

Upgrading ArtiosCAD Licenses

ArtiosCAD licenses enable you to use the features you have bought and disable the features you have not bought. As your needs change, you may have to change your licenses accordingly.

When you upgrade a license, you usually receive a licensing file by e-mail. You then have to install that file properly as described in the following section.

You must log on to your system with administrative privileges to upgrade licenses.

Note: NO SYSTEM MAY HAVE INSTANCES OF WebCenter, ArtiosCAD, DataCenter Admin, OR SpecLink OPEN WHEN UPGRADING LICENSES!

License Manager: keyless

To upgrade a keyless license for the FlexNet license manager, do the following;

1. Save the licensing file sent to you by Esko in a place where you can access it from the machine whose license you will be upgrading, for example a network location, on a USB thumb drive, and so forth.
2. On the machine with the license to upgrade, log in as Administrator or as a user with administrative privileges.

3. Click **Start > Programs/All Programs > Esko > ArtiosCAD > Activate Local Licenses/ Activate Server Licenses**.
4. In the Esko (Local or Server) License Manager dialog box, click **Activate**.
5. Click **Next** in the Activate License Wizard dialog box.
6. In the On-line activation or off-line activation dialog box, choose either **On-line activation** or **Off-line activation** as appropriate for your system and click **Next**.
7. In the Your product keys dialog box, choose **I have a file containing one or more product keys** and click **Next**.
8. In the File containing your product keys dialog box, browse for the file you saved in step 1 and click **Next**.
9. In the Esko ID dialog box, enter your Esko ID and password and click **Next**.
10. In the Activation completed successfully dialog box, the license(s) you activated should appear. Click **Finish** to complete the license upgrade.
11. Optionally, click **Save Licenses Report** to save a report of the license upgrade for your records.
12. Close the license manager dialog box by clicking the **X** in the upper right corner and test the new license as desired.

DataCenter database administration when using MSDE or SQL Server Express Edition

All database products require some amount of administration regardless of vendor.

Failure to perform this administration will ultimately lead to a loss of some or all of your DataCenter data.

If you have any questions on these tasks, contact Support.

Use DataCenter Admin to backup and restore the MSDE or SQL Server Express Edition 2005 database.

Note: These instructions do not apply to Microsoft SQL Server Express 2008, 2012, or later database engines. Use the Microsoft SQL Server Management Studio tools to manage those database engines.

Backing up the database

The database backup procedure stops the database service, copies the database files to \Esko\Artios\DataCenter\MSDE\MSSQL\$ ARTIOSCADDB\Data\backup for MSDE or \Esko\Artios\DataCenter\SQL2005Express\MSSQL.1\MSSQL\Data\backup for SQL Server Express Edition 2005, and C:\Program Files\Microsoft SQL Server\MSSQL11.ESKO\MSSQL for 2012 and then restarts the service. You must then copy that folder to backup media, or include it in your backup program, to fully backup the database.

To backup the MSDE database, do the following:

1. Ensure that any programs using the database are not running.
2. Log on to the database server as Administrator or as a member of the **Administrators** group.
3. Start DataCenter Admin by clicking **Start > Programs > (Esko) > ArtiosCAD > DataCenter Admin**, or by using the icon on the desktop.
4. Click **File > Backup database**.
5. In the Login as the Database Administrator dialog box, enter the name and password of the database administrator and click **OK**. The defaults are **sa** and a blank password for MSDE and **sa** and whatever password you chose at installation for SQL Server Express Edition. Click **OK** when done.
6. The Status bar indicates the current operation. When the Status bar is clear, the backup is complete.

Restoring the database

The database restore procedure stops the database service, replaces the data in the database with data from the backed-up database files from `\Esko\Artios\DataCenter\MSDE\MSSQL$ARTIOSCADDB\Data\backup` for MSDE and `\Esko\Artios\DataCenter\SQL2005Express\MSSQL.1\MSSQL\Data\backup` for SQL Server Express Edition, and then restarts the database service.

To restore the database, do the following:

1. Ensure that any programs using the database are not running.
2. Log on to the database server as Administrator or as a member of the **Administrators** group.
3. Start DataCenter Admin by clicking **Start > Programs > (Esko) > ArtiosCAD > DataCenter Admin**, or by using the icon on the desktop.
4. Click **File > Restore database**.
5. In the Login as the Database Administrator dialog box, enter the name and password of the database administrator and click **OK**. The defaults are **sa** and a blank password for MSDE and **sa** and the password you chose at installation for SQL Server Express Edition. Click **OK** when done.
6. The Status bar indicates the current operation. When the Status bar is clear, the restore is complete.

Database space management for MSDE

The MSDE database files automatically expand to accommodate new data. After a few months, to compact the database, do the following:

1. Make sure no programs which use the database are active. This includes ArtiosCAD, SpecLink, DataCenter Admin, and any products using CAD-X.
2. Log on to the database server as Administrator or as a member of the **Administrators** group.
3. Start a command prompt, and change directories to `C:\Program Files\Microsoft SQL Server\80\Tools\Binn`.

4. Type `osql -Usa -P"" -Sdatabase_server_name\ArtiosCADdb` and press enter.
5. At the 1> prompt, type `use ArtiosCADdb` and press enter.
6. At the 2> prompt, type `go` and press enter.
7. At the 1> prompt, type `dbcc shrinkfile (acaddata)` and press enter.
8. At the 2> prompt, type `go` and press enter.
9. At the 1> prompt, type `dbcc shrinkfile (acadlog)` and press enter.
10. At the 2> prompt, type `go` and press enter.
11. At the 1> prompt, type `exit` and press enter.

Your screen should look similar to the one shown below.

```

C:\Program Files\Microsoft SQL Server\80\Tools\Binn>osql -Usa -P"" -Sludaaha\artioscaddb
1> use artioscaddb
2> go
1> dbcc shrinkfile (acaddata)
2> go
  DbId  FileId CurrentSize MinimumSize UsedPages EstimatedPages
-----
      5      1      1280      1280      720      720

(1 row affected)
DBCC execution completed. If DBCC printed error messages, contact your system administrator.
1> dbcc shrinkfile (acadlog)
2> go
  DbId  FileId CurrentSize MinimumSize UsedPages EstimatedPages
-----
      5      2      256      256      256      256

(1 row affected)
DBCC execution completed. If DBCC printed error messages, contact your system administrator.
1> exit
C:\Program Files\Microsoft SQL Server\80\Tools\Binn>

```

MSDE-related Application Log entries in Event Viewer

On the database server, the MSSQL\$ARTIOSCADDDB service writes warning entries of category (8) to the Application Log in Event Viewer. They are about connecting to Active Directory and can be ignored.

Using Microsoft SQL Server 2005

Microsoft SQL Server 2005 is a large, robust database which can require complex administration. The installation documentation provided below is provided as a convenience

only for initial installation. A dedicated Database Administrator (DBA) is required to administer and maintain the database, and is free to choose options other than those documented to meet local site requirements.

Make sure to load ArtiosCAD specifying **Microsoft SQL Server or Oracle** as the database type before installing Microsoft SQL Server 2005.

After installing ArtiosCAD, the steps to using Microsoft SQL Server 2005 with a new installation of ArtiosCAD are installing Microsoft SQL Server 2005, configuring Microsoft SQL Server 2005, configuring the ODBC driver, and running the database configuration batch file for ArtiosCAD.

Once all that is done, you can configure servers and resources in DataCenter Admin and start using ArtiosCAD.

Installing Microsoft SQL Server 2005

Note:

Before you begin, find out from your IT department what the password policy is, as you will need to know it to set the database user passwords.

Perform the following steps to install Microsoft SQL Server 2005 for the first time to use with ArtiosCAD.

1. Make sure the computer which you intend to make the database server meets Esko's recommended hardware specifications.
2. Log on as **Administrator** or as a user with administrative privileges.
3. Put the Microsoft SQL Server 2005 media into the media drive. It should automatically start. If it does not, navigate to its root directory using Windows Explorer and double-click `Autoplay.exe`.
4. In the dialog box that appears, read the license agreement. If you agree with it, select **Yes, I accept the licensing terms and conditions** and then click Next to continue the installation.
5. In the Installing Prerequisites dialog box, click **Install**. A progress bar shows the progress of the task.

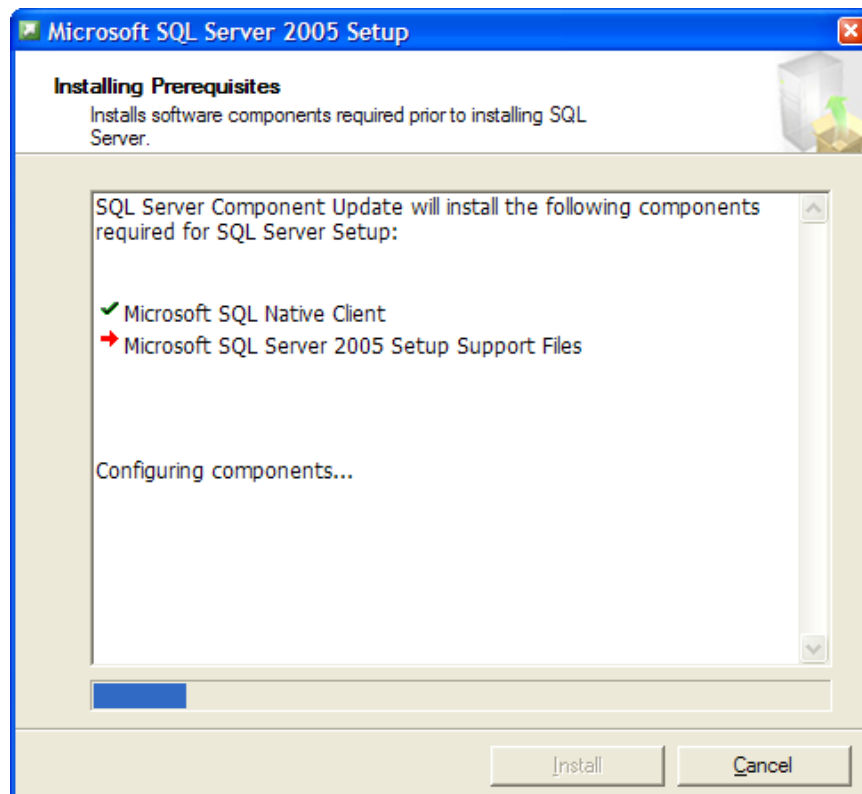

6. Click **Next** when the prerequisite components are installed.
7. In the Welcome to the Microsoft SQL Server Installation Wizard dialog box, click **Next**.



8. The installation wizard will perform a system configuration check and install any needed components. Click **Next** when it finishes.

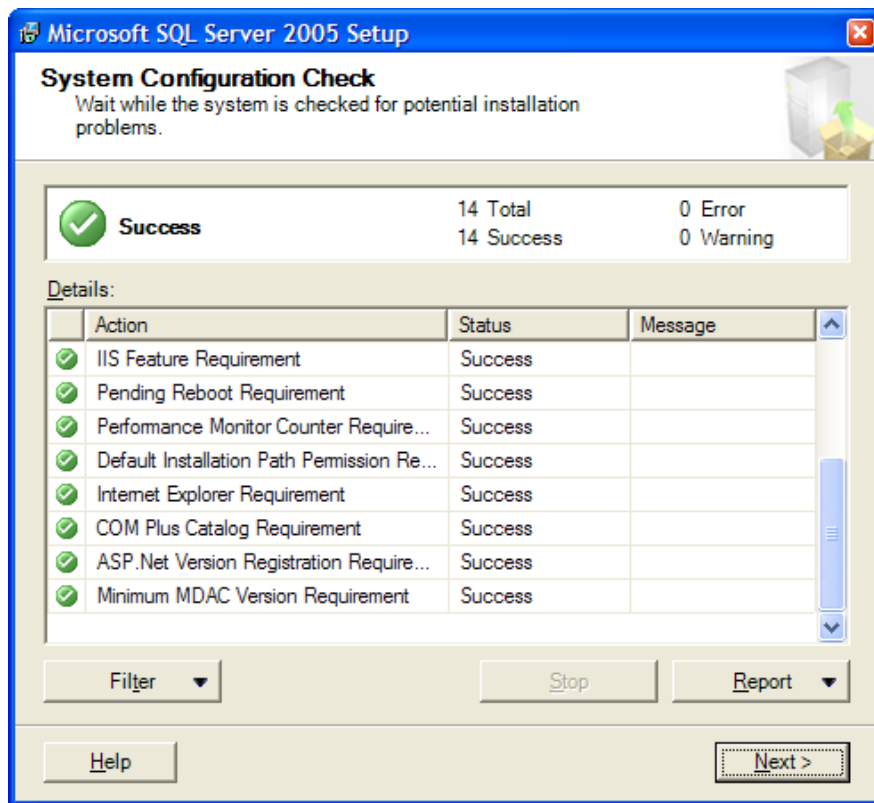

- The Installation Wizard will continue and the Registration Information dialog box will appear. Enter your name, company, and Product Key as appropriate. Click **Next** when done.

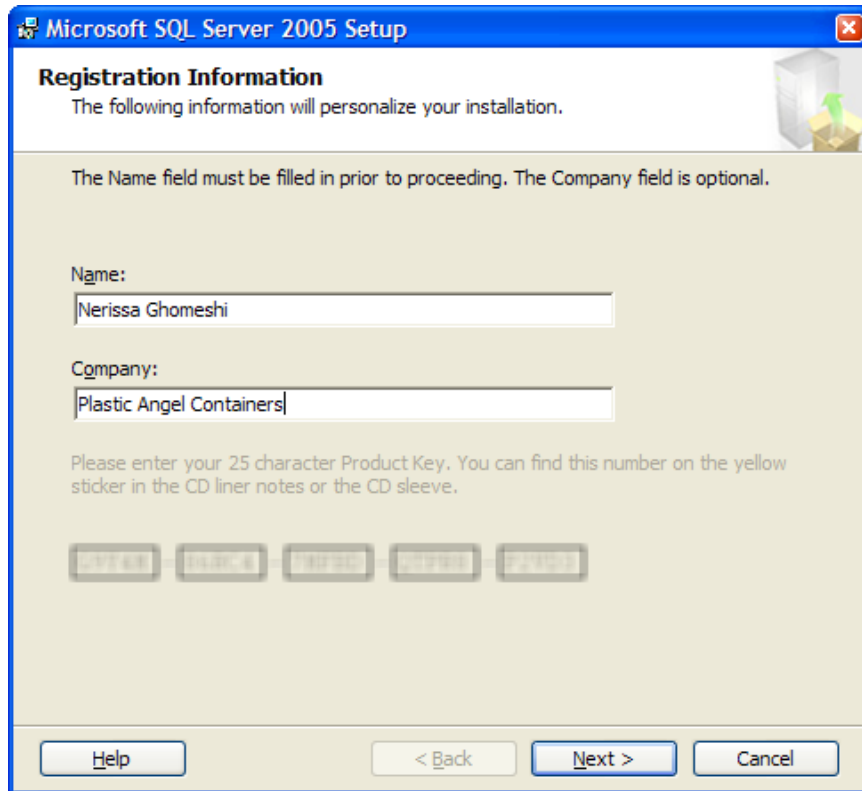

10. In the Components to Install dialog box, click **Advanced**.

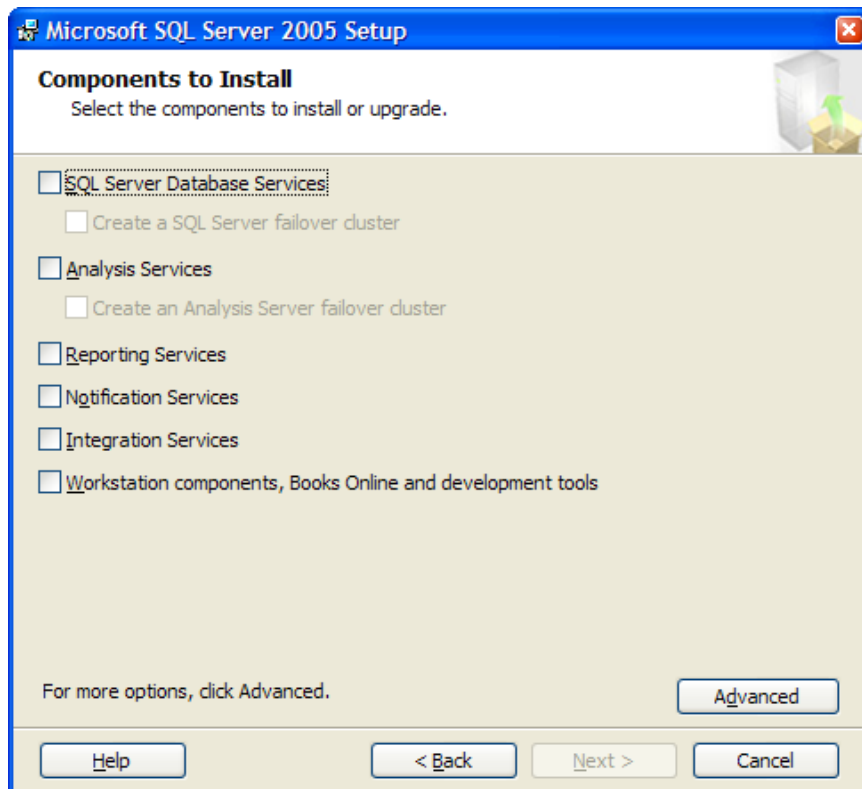

11. In the Feature Selection dialog box, click the box next to Database Services and click **Entire feature will be installed on the hard drive**.

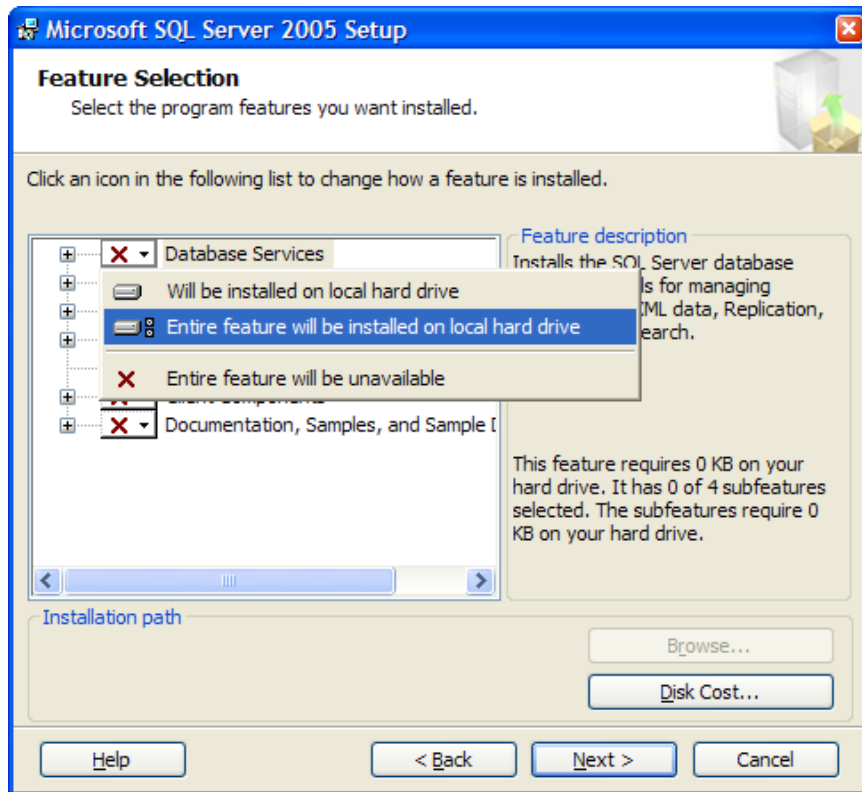

12. Still in the Feature Selection dialog box, expand the Client Components catalog, click the box next to Connectivity Components, and click **Entire feature will be installed on the hard drive**. Do the same for Management Tools and click **Next**.

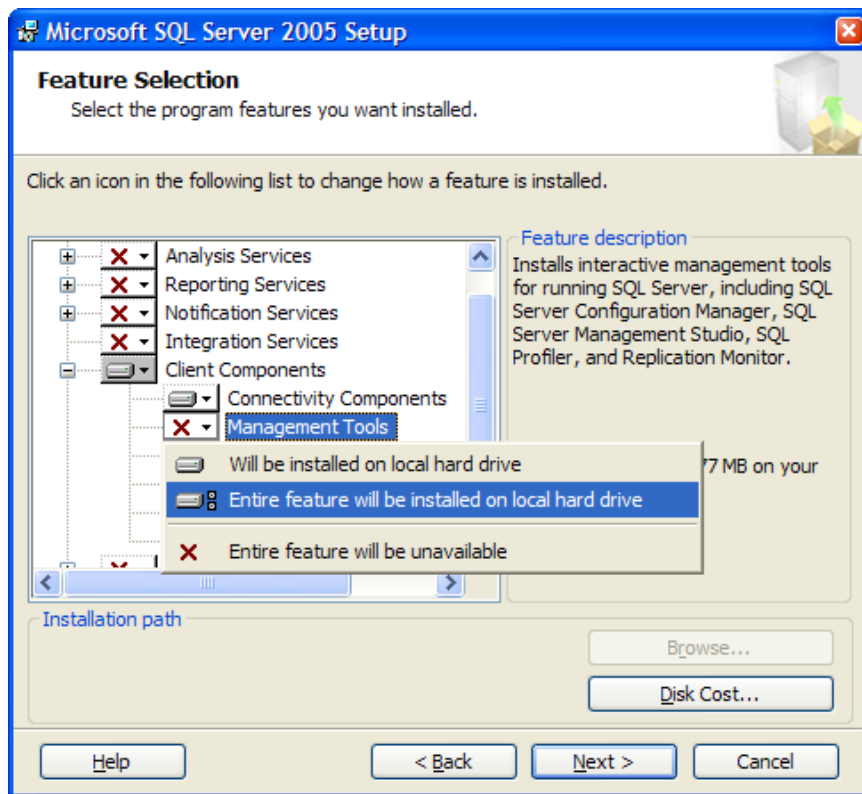

13. In the Instance Name dialog box, click **Named instance** and enter a sensible name in the field. You will need to know this instance name later, so referencing ArtiosCAD would be prudent.

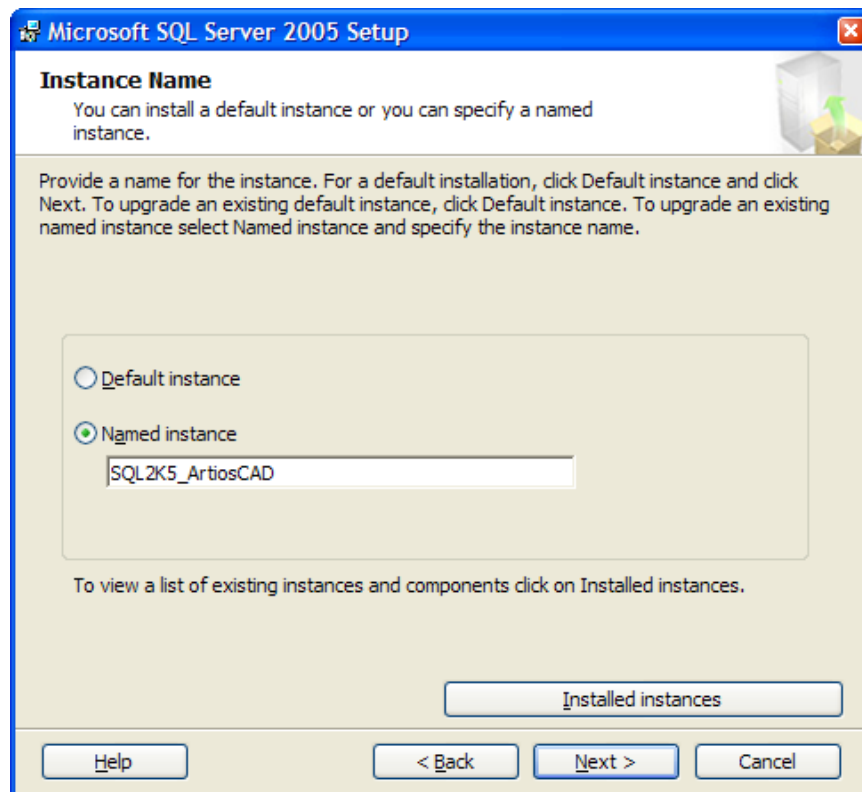

14. In the Service Account dialog box, click **Use the built-in System account** and change the drop-down list box entry to **Network service**. Click **Next**.

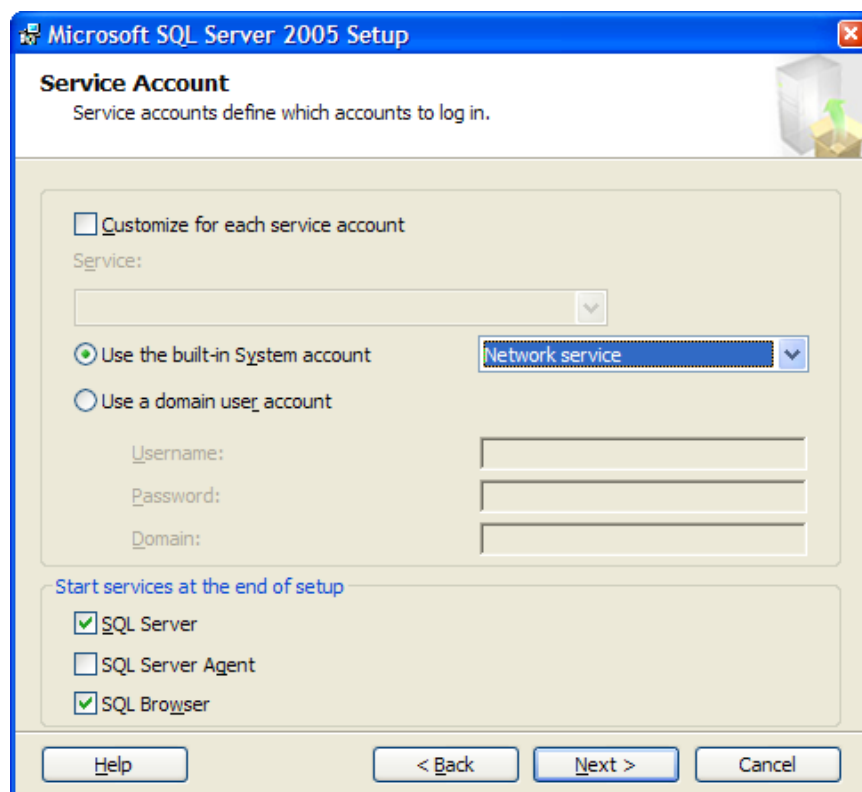

15. In the Authentication Mode dialog box, click **Mixed Mode**, and enter a password of your own choosing that complies with your local password policy in both password fields. Click **Next** after entering both passwords. **Make sure to record this password in a secure location as you will need it later.**

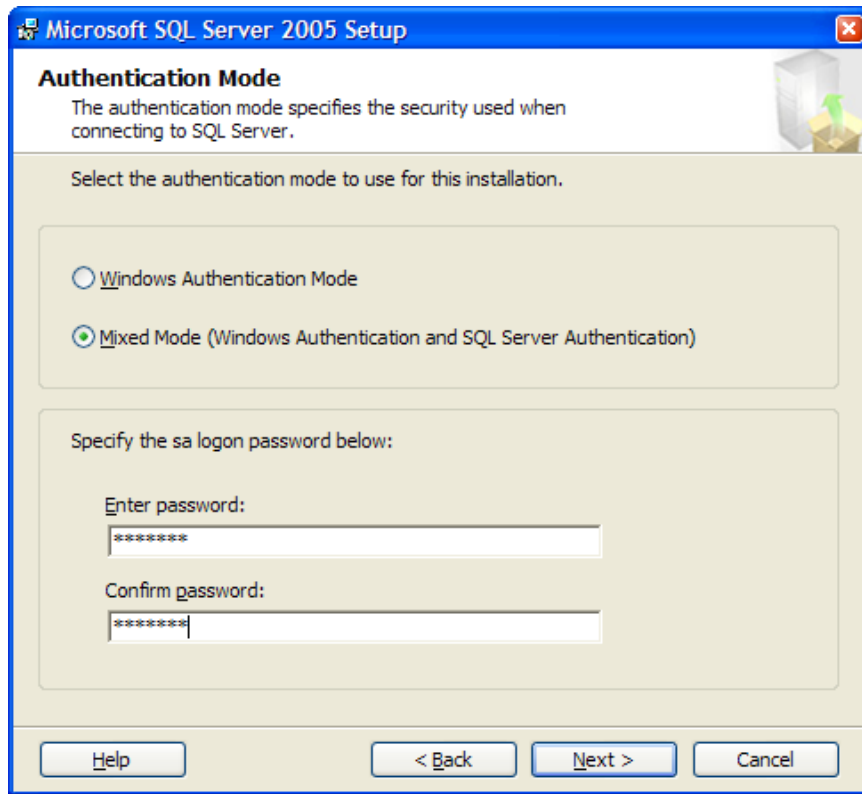

16. In the Error and Usage Report Settings dialog box, leave both checkboxes clear and click **Next**.

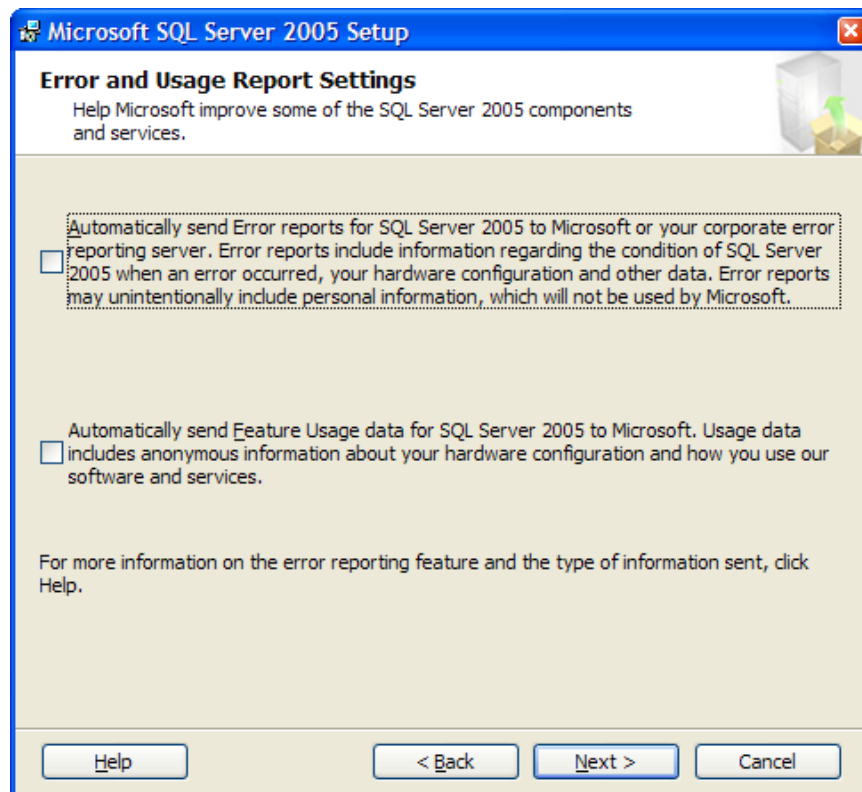

17. In the Ready to Install dialog box, click **Install** to begin the installation.

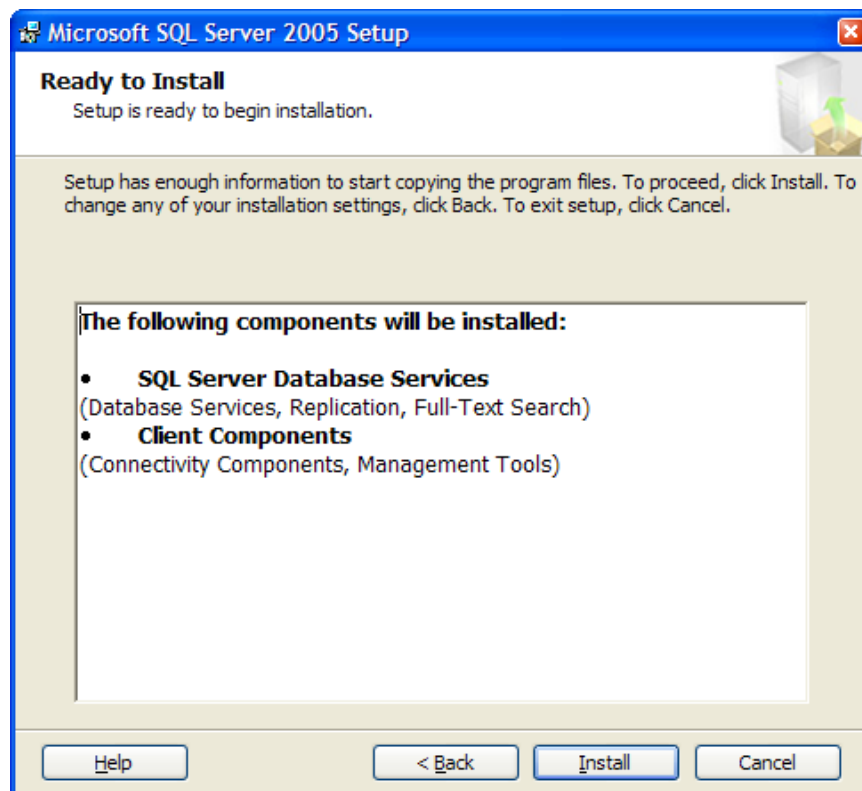

18. The Setup Progress dialog box shows the status of the installation. Click **Next** when the tasks have completed.

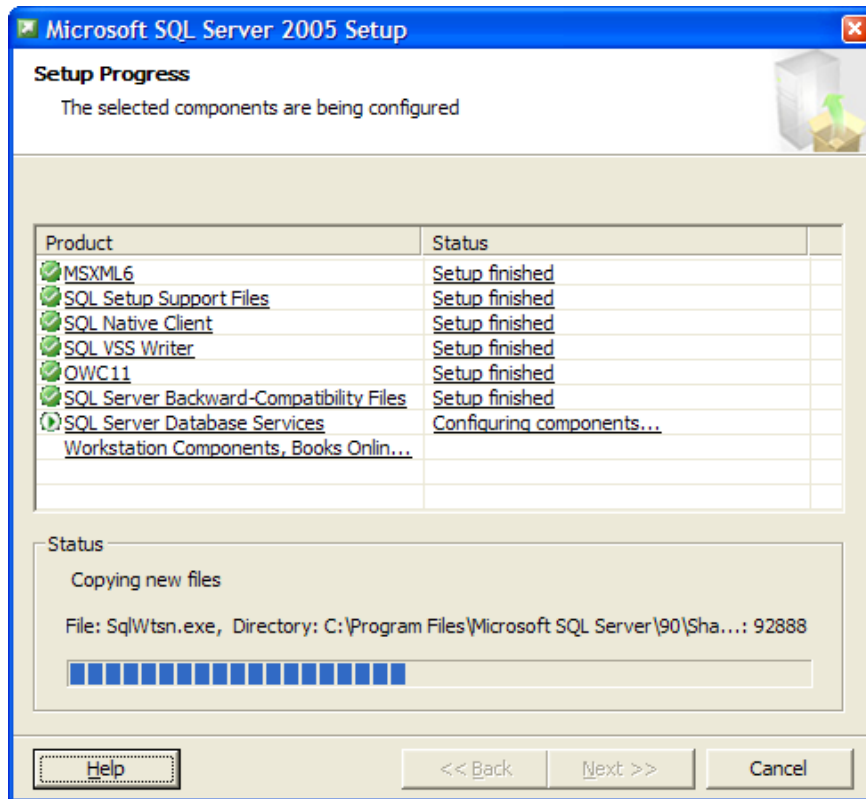

19. In the Completing Microsoft SQL Server 2005 Setup dialog box, click **Surface Area Configuration tool**.

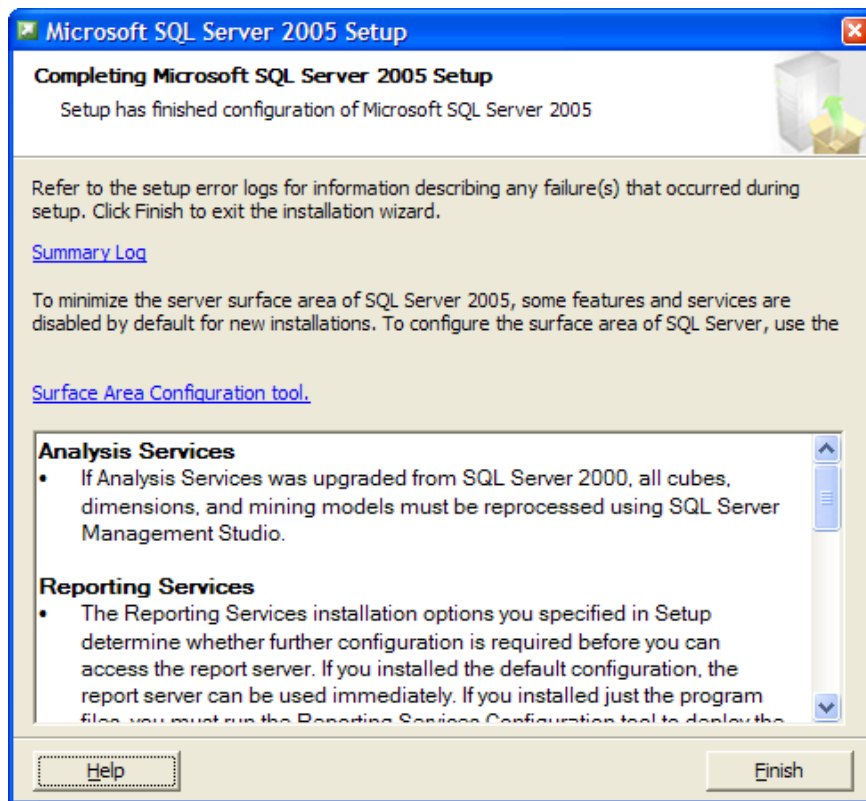

20. In the Minimize SQL Server 2005 Surface Area dialog box, click **Surface Area Connection for Services and Connections**.



21. In the resulting dialog box, click **Remote Connections** under Database Engine, click **Local and remote connections**, and click **Using TCP/IP only**. Click **Apply** when done.

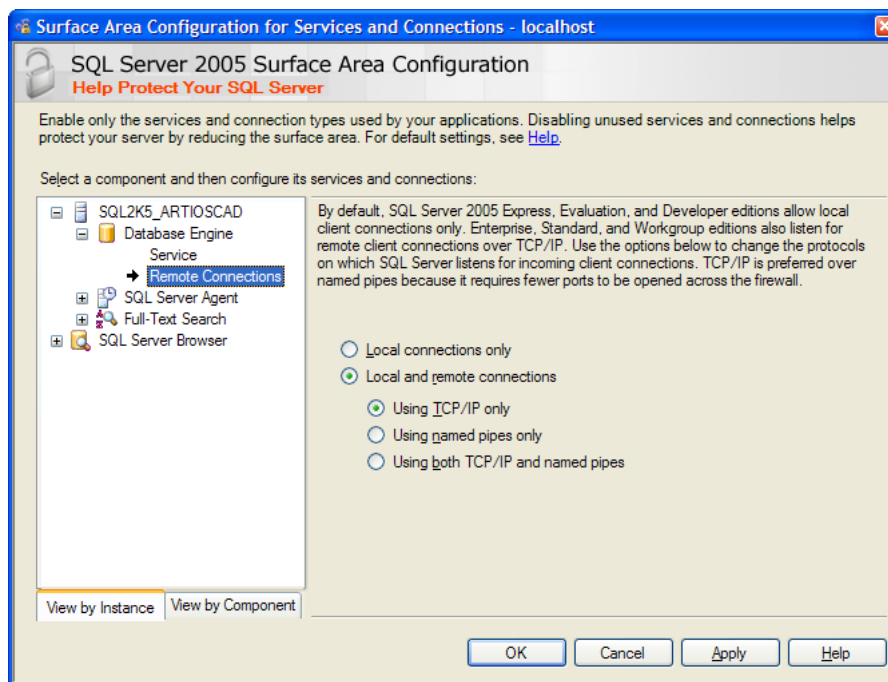

22. In the Connection Settings Change Alert dialog box, click **OK**.

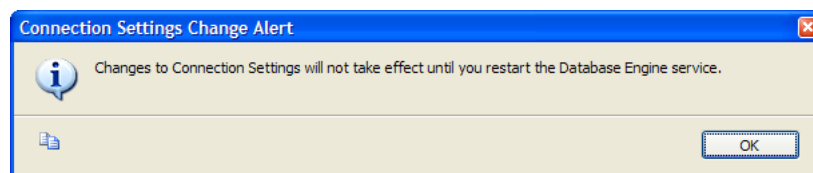

23. Click **Service** under Database Engine.

24. Click **Stop**, then **Start** to restart the database engine service.

25. Click **OK** to exit the Surface Area Configuration for Services and Connections dialog box.

26. Close the SQL Server 2005 Surface Area Configuration dialog box.

27. In the Microsoft SQL Server 2005 Setup dialog box, click **Finish**. Reboot the system if prompted to do so. Do not postpone this reboot.

Note: At this point, apply the latest Microsoft SQL Server 2005 service packs and patches available from the Microsoft web site at <http://www.microsoft.com/sql/default.msp>.

Configuring Microsoft SQL Server 2005

Once you have updated and patched Microsoft SQL Server 2005 appropriately, continue as follows. You may have to start the database by hand by right-clicking the SQL Server icon in the system tray and selecting **MSSQLServer - Start**.

Creating the ArtiosCADdb database

1. If you rebooted the machine, log in as a user with administrative privileges.
2. Click **Start > Programs > Microsoft SQL Server 2005 > SQL Server Management Studio**.
3. In the Connect to Server dialog box, ensure that the **Server name:** field is set to the instance created in the previous procedure, change the **Authentication type:** drop-down list box to **SQL Server Authentication**, and enter sa for the username and the password you specified during installation. Click **Connect**.

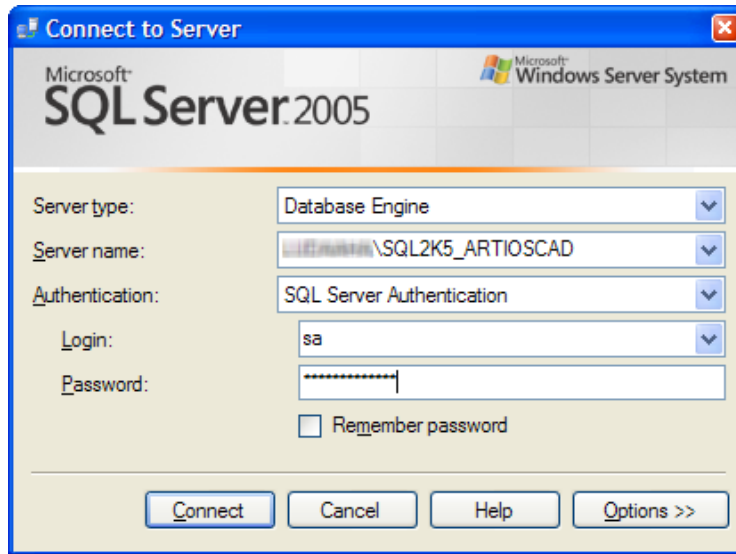

4. Right-click Databases and click **New Database** on the context menu.

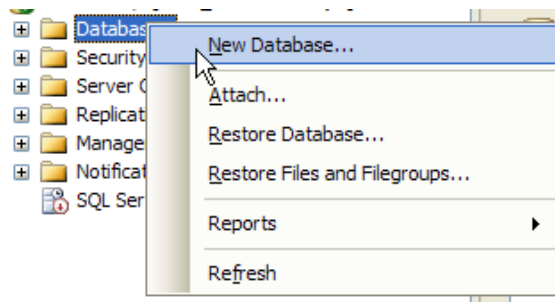

5. In the New Database dialog box, in the **Database Name:** field, enter ArtiosCADdb. Do not click **OK**.

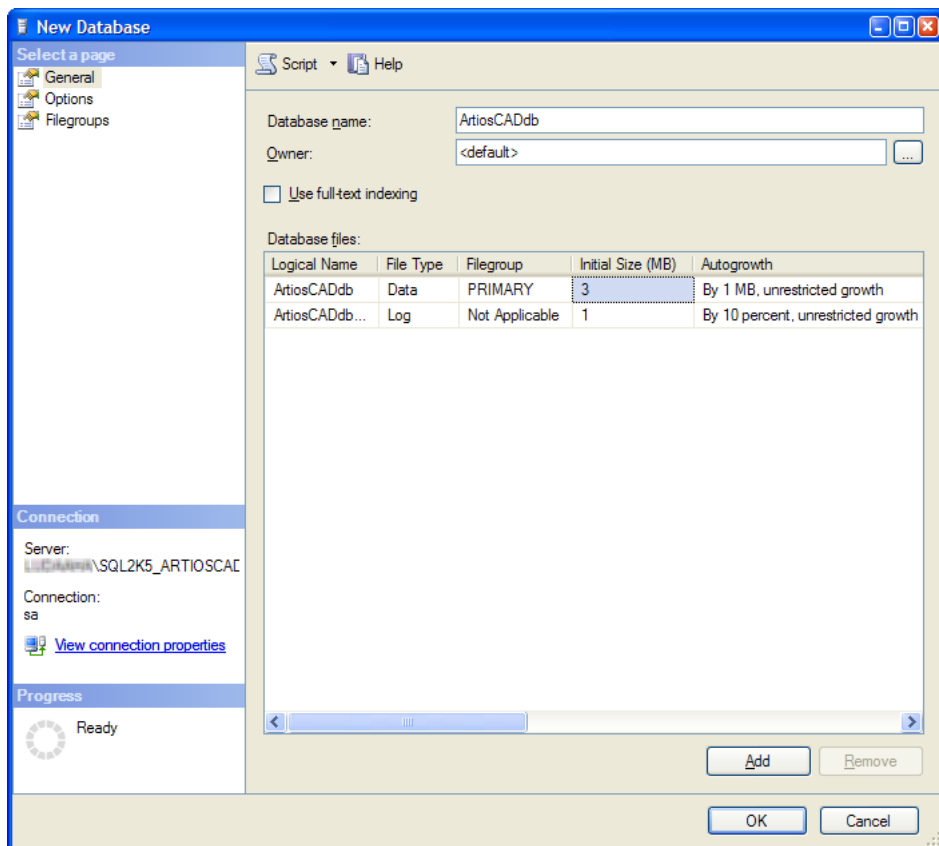

6. Click the **3** in the **Initial size (MB)** column and change it to **10**. Do not click **OK**.

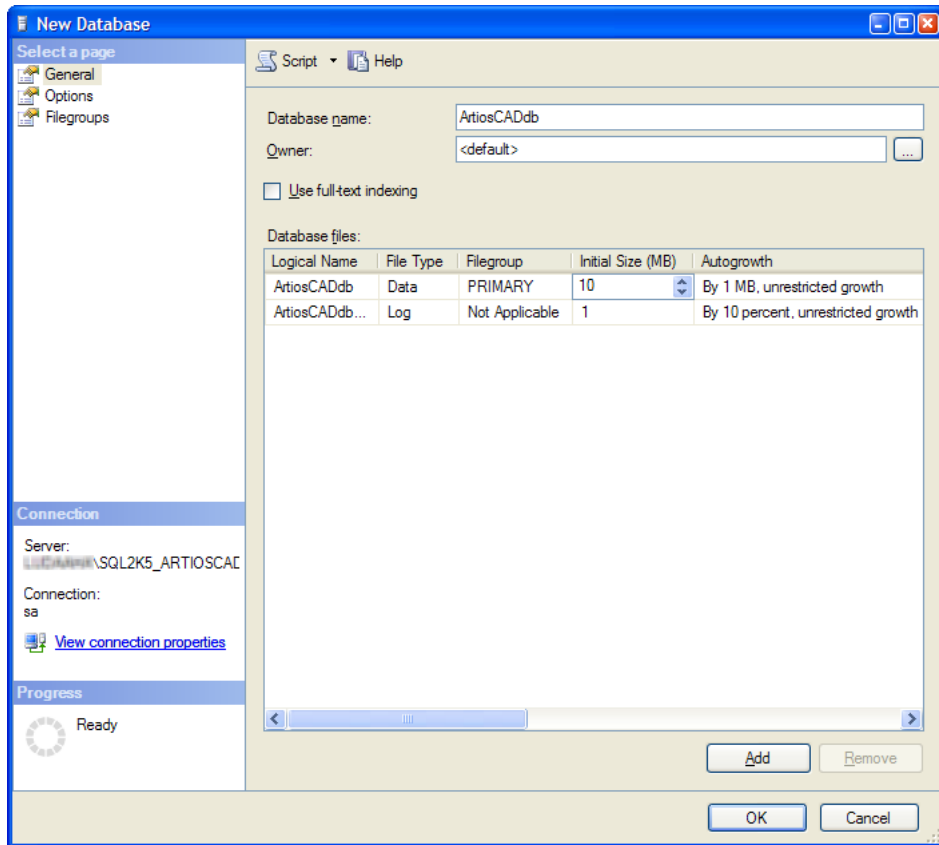

7. If this is a normal computer with one hard drive and two hard drive controllers, click **OK**.

If this is a high-end database server and has multiple hard drives and multiple controllers, use the scroll bar to scroll to the right, click the Browse (...) button for the ArtiosCADdb Log file, and locate the transaction log on a separate disk on a separate controller. This will minimize data loss when a hard drive crashes. Click **OK** when done.

The ArtiosCADdb database should appear in the group of databases as shown below.

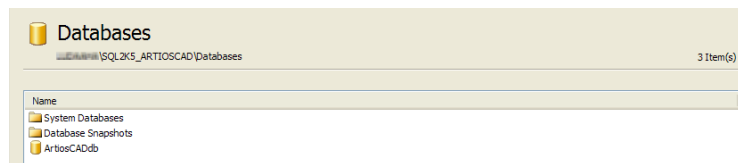

The database is now created and the next step is configuring the ODBC driver.

Configuring the ODBC driver

Microsoft SQL Server 2005 requires the ODBC driver provided by MDAC 2.8 or later. It is installed on the server when you install the database, and on client systems by ArtiosCAD when it is loaded.

If the system will not have ArtiosCAD on it, load MDAC 2.8 on it by selecting the Connectivity Components element of the Client Components catalog when running the Microsoft SQL Server 2005 setup program.

To configure the ODBC driver on both the server and on clients, do the following:

1. You should still be logged in as **Administrator** or as a member of the Administrators group. If not, log in as such.
2. Open the **Data Sources (ODBC)** applet in Control Panel. Depending on the operating system, it may be in Administrative Tools.
3. Click the **System DSN** tab, and then click **Add**.
4. Select **SQL Server** from the list of available drivers and click **Finish**.

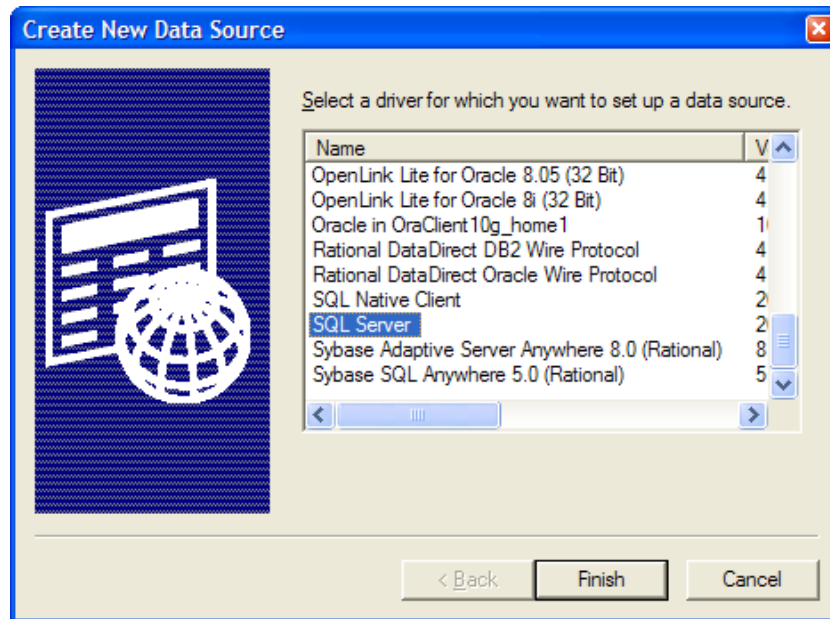

5. In the Create a New Data Source to SQL Server dialog box, enter ArtiosCAD in the **Name:** field and select the server and instance name in the **Server:** drop-down list box.

If this is a client, specify the name of the database server.

Click **Next**.

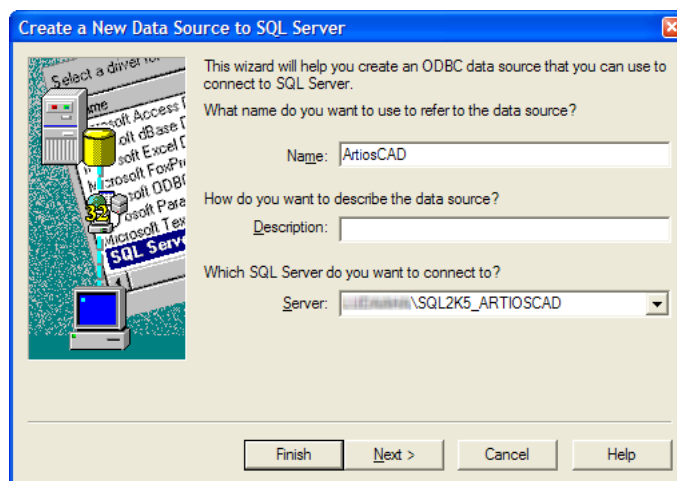

- When asked about authenticity, select the **With SQL Server authentication...** choice. In that same dialog box, deselect the **Connect to SQL Server ...** checkbox. Do not click **Next**.

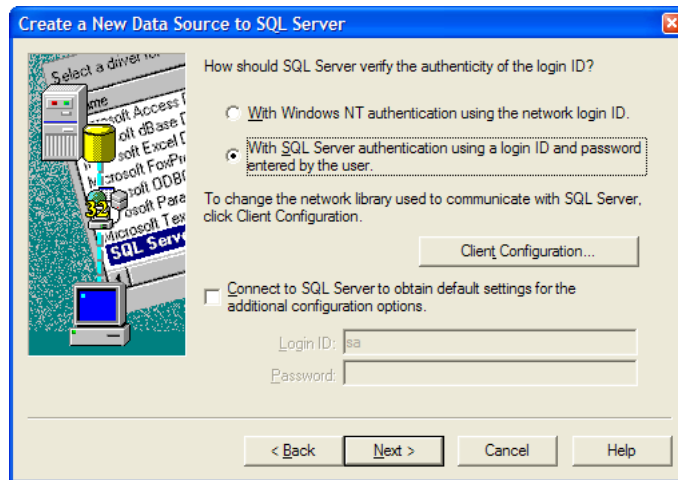

- Click **Client Configuration**. The Add Network Library Configuration dialog box appears.

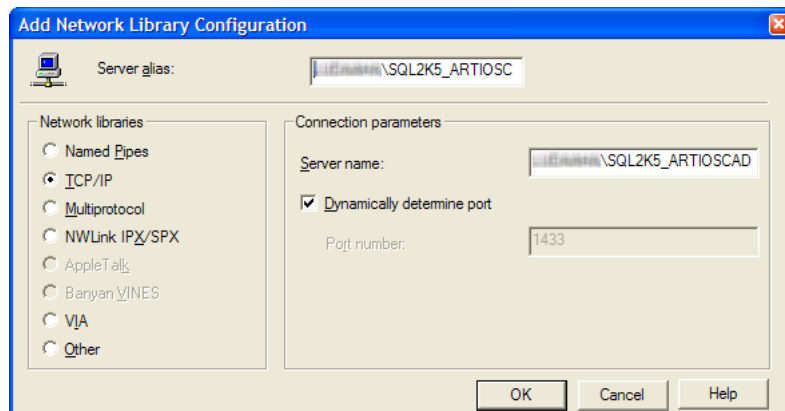

Make sure **TCP/IP** is selected in the **Network libraries** group and ensure the server name is correct. If **(local)** was selected in the **Which SQL Server do you want to connect to?** field in Step 5, only a period (.) appears in the **Server alias** field and **Server name** field.

Ensure that **Dynamically determine port** is checked and that the **Port number** is set to 1433. Click **OK**.

Click **Next** in the Create a New Data Source to SQL Server dialog box.

- In the next dialog box, leave the **Create temporary stored procedures...** and **Use ANSI...** choices selected and click **Next**.

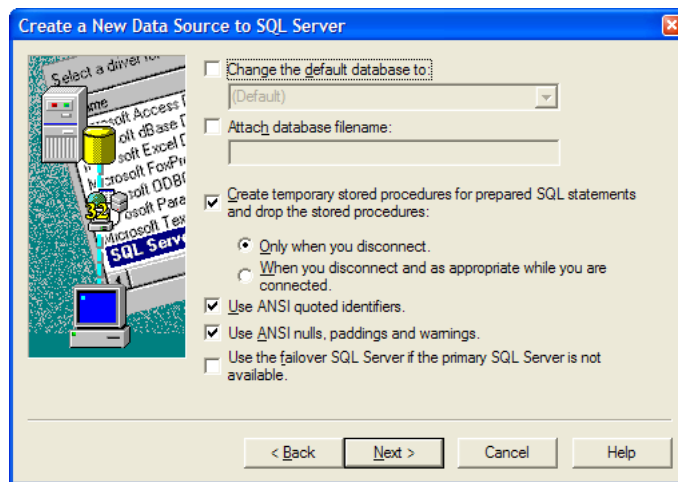

9. In the next dialog box, leave **Perform translation for character data** selected.

If the system is using non-U.S. locale settings, check the **Change the language of SQL Server system messages to:** checkbox and set the value to **English**.

Click **Finish**.

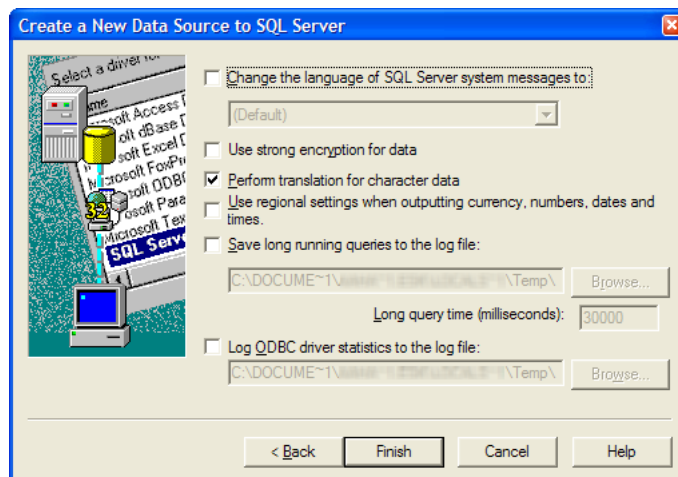

10. The ODBC Microsoft SQL Server Setup dialog box will appear showing a summary of the configuration. Click **OK**. Do not test the configuration; it will fail because the proper database user is not configured because the database configuration batch file has not yet been run.

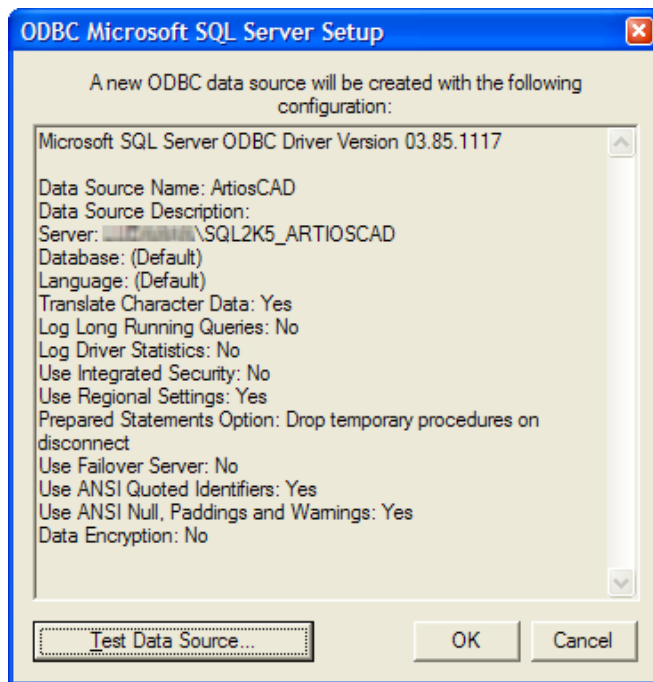

11. Click **OK** in the ODBC Microsoft SQL Server Setup dialog box.
12. Click **OK** in the ODBC Data Source Administrator dialog box.

The ODBC connection on the server is now configured properly. The next step is running the database configuration batch file.

Running the ArtiosCAD database configuration batch file

Make sure the ODBC connection to the ArtiosCAD database is configured as described in the previous section before running the batch file.

Note:

You will most likely need to edit the batch file to supply the programmer user's password before you run it.

To run the ArtiosCAD database scripts, do the following:

1. You should still be logged in as **Administrator** or as a member of the Administrators group. If not, log in as such.
2. Start a command prompt and change the directory to \Esko\Artios\DataCenter.
3. Build the database schema. The schema build command is in the form `Build_MSSQLServerSchema "<sa_user_Password>" "<instance name>" "<DataCenter root directory>" "<DataCenter program language directory>"`.

The command should be similar to the one shown below, substituting your installation information and language as needed.

```
Build_MSSQLServerSchema "SysP433w0rd***" "MBCCADSERVER\SQL2K5_ArtiosCAD" "C:\Esko\Artios\datacenter" "C:\Esko\Artios\datacenter\program\english"
```

When you have typed the command, press enter. Comments and commands will appear in the command prompt similar to example shown below.

```
C:\Artios\datacenter>rem *** Build the ArtiosCAD schema
C:\Artios\datacenter>osql -Usa -P"" -S"LUDDAAHA\ArtiosCADdb" -i "C:\artios\datacenter\msde_createdb.sql" -o "C:\artios\datacenter\msde_createdb.log"
C:\Artios\datacenter>osql -Usa -P"" -S"LUDDAAHA\ArtiosCADdb" -i "C:\artios\datacenter\mssqlserver.sql" -o "C:\artios\datacenter\mssqlserver.log"
C:\Artios\datacenter>osql -Usa -P"" -S"LUDDAAHA\ArtiosCADdb" -i "C:\artios\datacenter\mssqlserver_security.sql" -o "C:\artios\datacenter\mssqlserver_security.log"
C:\Artios\datacenter>rem *** Build the ArtiosCAD Version 7 schema
C:\Artios\datacenter>osql -Usa -P"" -S"LUDDAAHA\ArtiosCADdb" -i "C:\artios\datacenter\mssqlserver_7.sql" -o "C:\artios\datacenter\mssqlserver_7.log"
C:\Artios\datacenter>rem *** Build keys
C:\Artios\datacenter>"C:\artios\datacenter\program\BuildKeys.exe"
C:\Artios\datacenter>rem *** Build hierarchical boards
C:\Artios\datacenter>set bLoadBoardTree=1
```

4. When the command prompt returns, type exit and press enter.

The database is now ready for use with ArtiosCAD and DataCenter Admin. Add servers and resources as described in the **Working with servers and resources** section of the *DataCenter* chapter.

Notes and troubleshooting

Microsoft Data Access Components (MDAC) version 2.8 or higher must be used with Microsoft SQL Server 2005.

The following notes deal with using SQL Server Management Studio in the Microsoft SQL Server folder on the Start menu.

- If error messages appear about not being associated with a trusted SQL Server connection, right-click the server instance name, and then click **Properties > Security**. Make sure **SQL Server and Windows Authentication mode** is selected in the **Server authentication** group.
- If many script errors appear, make sure the **Implicit transactions** checkbox is clear on the **Properties > Connections** page in the **Default connection options** list.
- If error messages appear about the programmer user not existing or not having permission, do the following:
 - Expand the database instance in the left pane so the **Security** folder is open and double-click **Logins**.

- Right-click **Programmer** and click **Properties**.
- On the General page, there should be a password set in the **Password:** field, the **Default database:** should be set to **ArtiosCADdb**, and the **Default language:** should be set to **English**. If this is not so, click the **Server Roles** page and ensure that **public** is checked.

If you are using SQL Server Express Edition and you need to run the database script batch file, use Build_ExpressSchema.bat with the same syntax as Build_MSSQLServerSchema.bat.

Using Microsoft SQL Server 2012

Microsoft SQL Server 2012 is a large, robust database which can require complex administration. The installation documentation provided below is provided as a convenience only for initial installation. A dedicated Database Administrator (DBA) is required to administer and maintain the database, and is free to choose options other than those documented to meet local site requirements.

Make sure to load ArtiosCAD specifying **Microsoft SQL Server or Oracle** as the database type before installing Microsoft SQL Server 2012.

After installing ArtiosCAD, the steps to using Microsoft SQL Server 2012 with a new installation of ArtiosCAD are installing Microsoft SQL Server 2012, configuring Microsoft SQL Server 2012, configuring the ODBC driver, and running the database configuration batch file for ArtiosCAD.

Once all that is done, you can configure servers and resources in DataCenter Admin and start using ArtiosCAD.

Note:

Before you begin, find out from your IT department what the password policy is, as you will need to know it to set the database user passwords.

Installing Microsoft SQL Server 2012

This procedure describes how to install Microsoft SQL Server 2012 Standard Edition for use with ArtiosCAD. You should only use this version if you have a dedicated database administrator available.

1. Log in to your database server as an administrator.
2. Run the setup program on the Microsoft SQL Server media.
3. On the left side of the SQL Server Installation Center dialog box, click **Installation**.

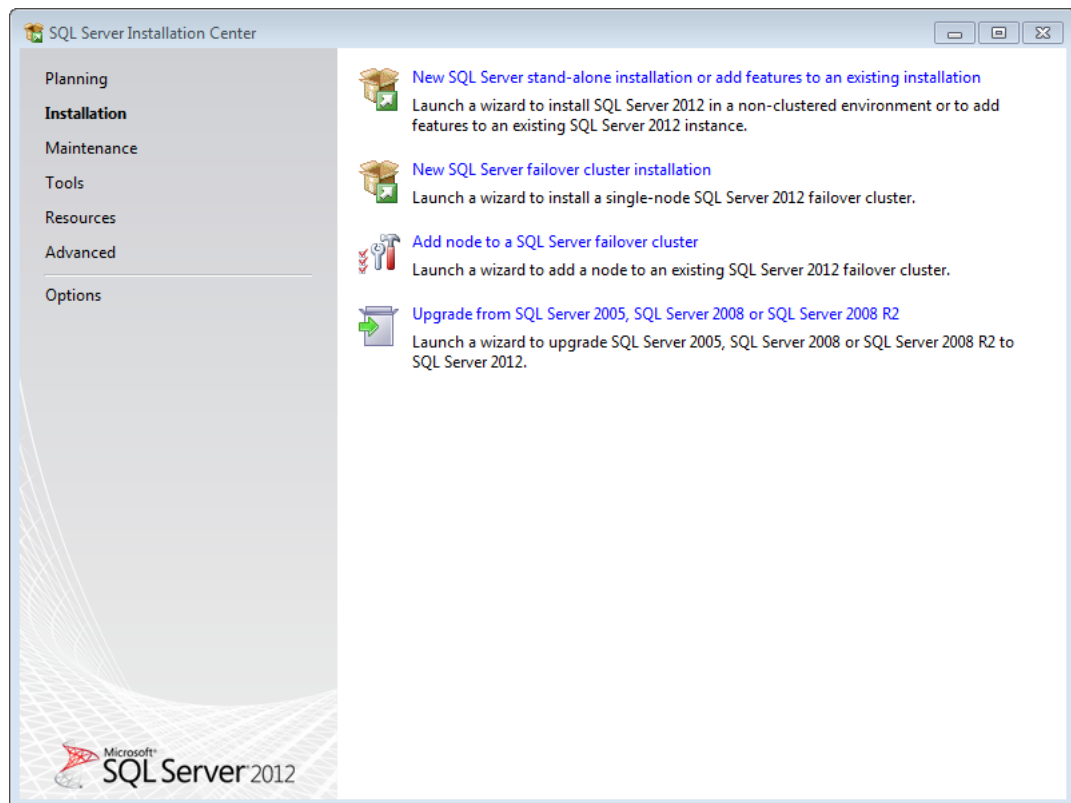

4. Click **New SQL Server stand-alone installation or add features to an existing installation**.
5. In the Setup Support Rules dialog box, click **Details**, make sure all the items passed, and click **OK**.

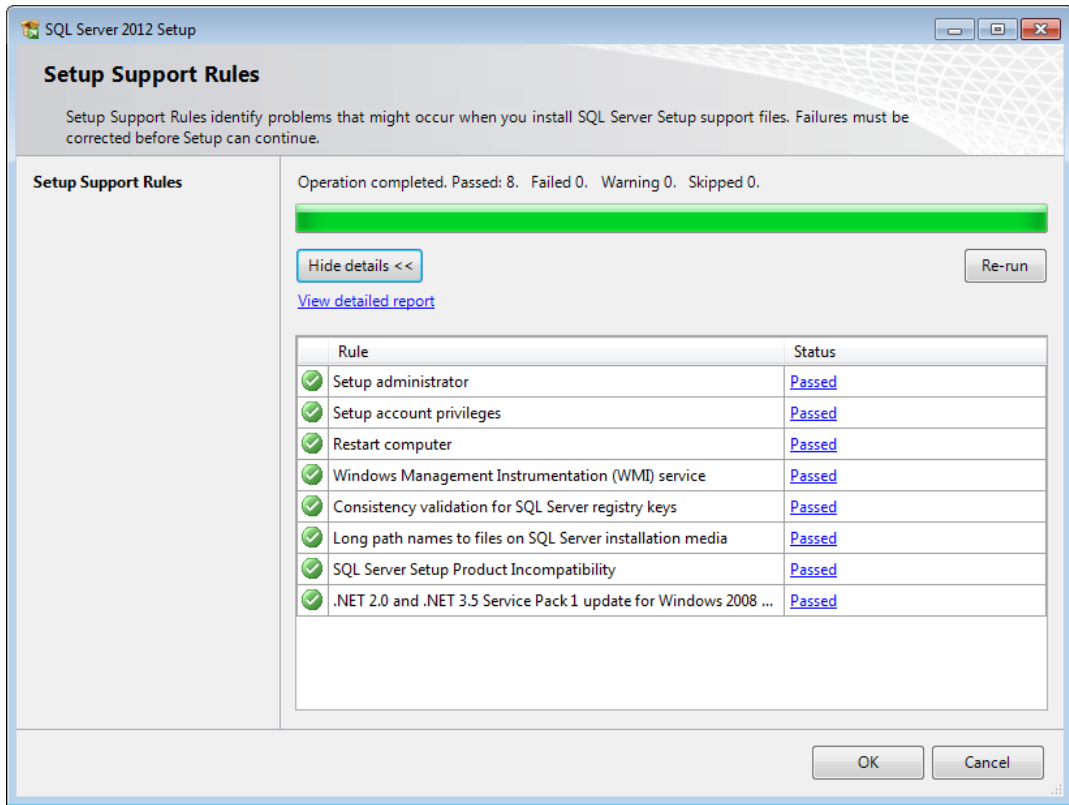

6. In the Product Key dialog box, enter the product key and click **Next**.

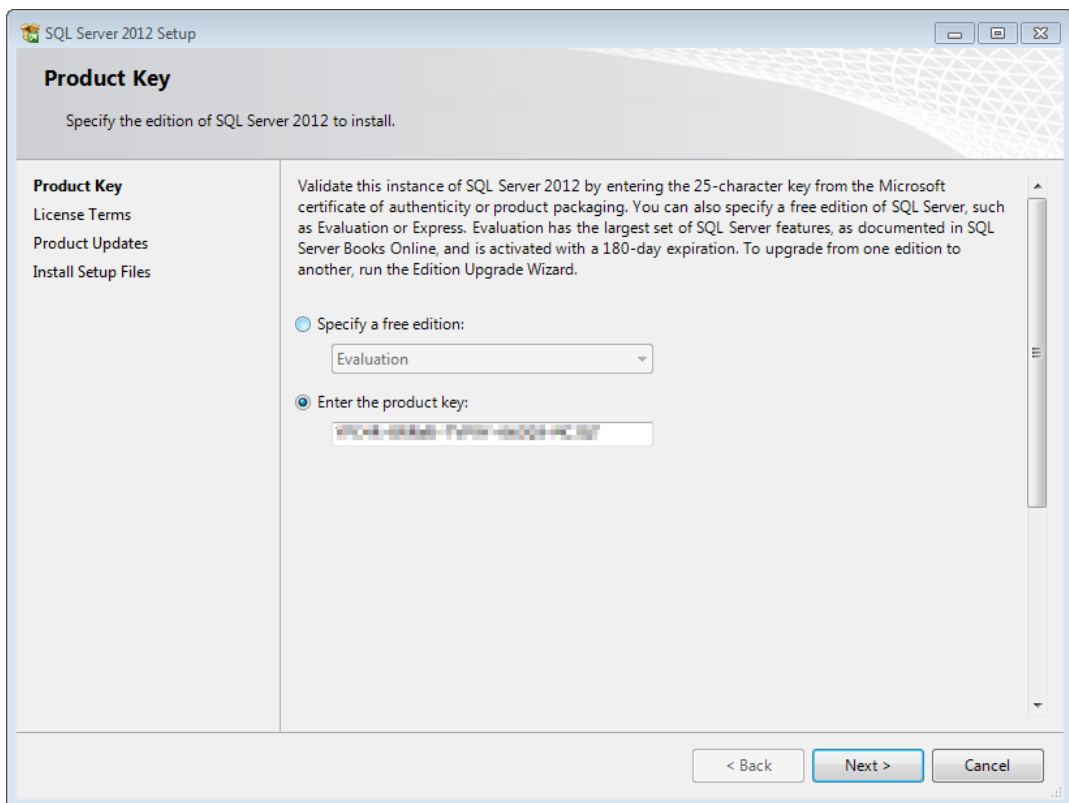

7. In the License Terms dialog box, check **I accept the license terms** and click **Next**.

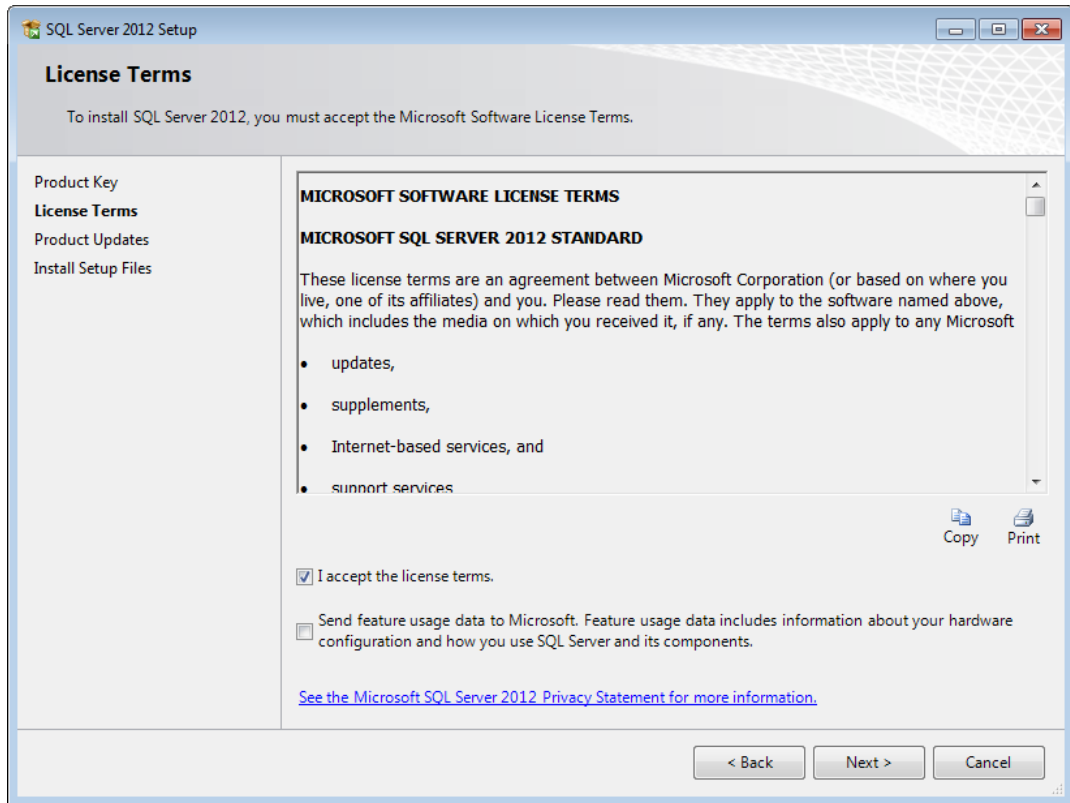

8. The Install Setup Files dialog box will show an action list and progress bar.

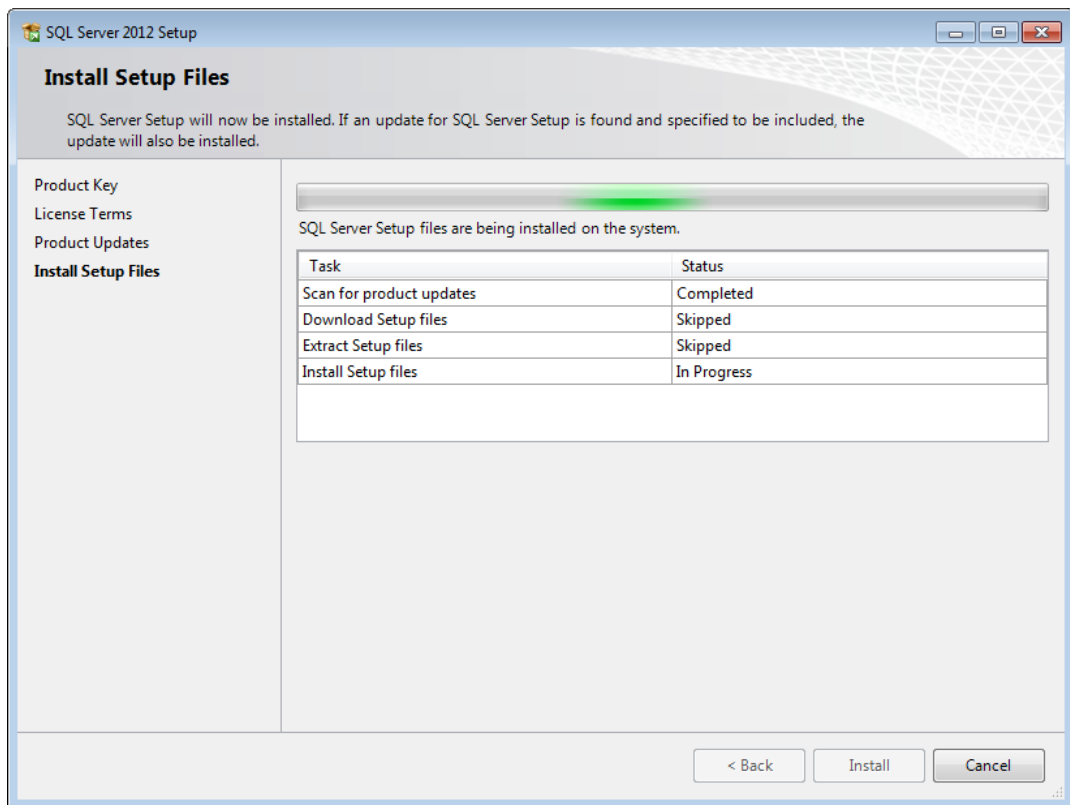

9. In the Setup Role dialog box, click **SQL Server Feature Installation** and click **Next**.

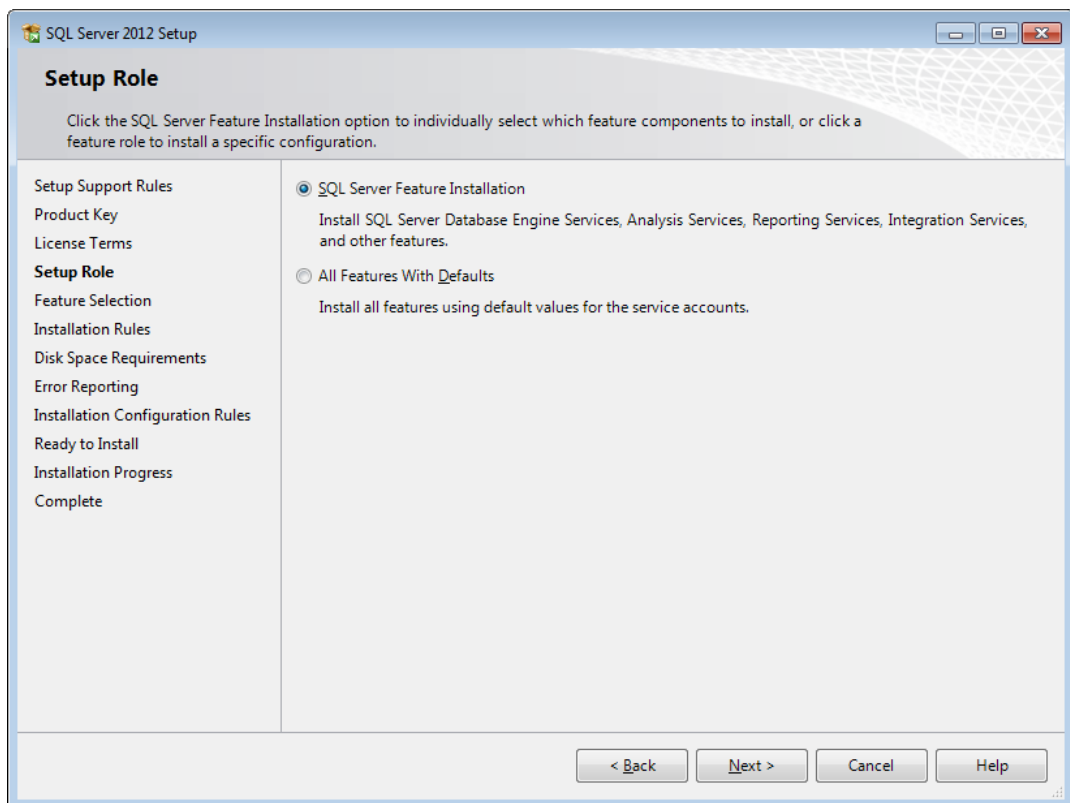

10. In the Feature Selection dialog box, check the checkboxes for the following features. You may have to scroll down to see all the items in the list. You may also change the installation directories. Click **Next** when you are done selecting features.

In the Instance Features group, select the following features:

- Database Engine Services
- SQL Server Replication
- Full-Text and Semantic Extractions for Search
- Data Quality Services

In the Shared Features group, select the following features:

- SQL Server Data Tools
- Client Tools Connectivity
- Client Tools Backward Compatibility
- Client Tools SDK
- Documentation Components
- Management Tools - Basic
- Management Tools - Complete
- Distributed Replay Controller
- Distributed Replay Client
- SQL Client Connectivity SDK

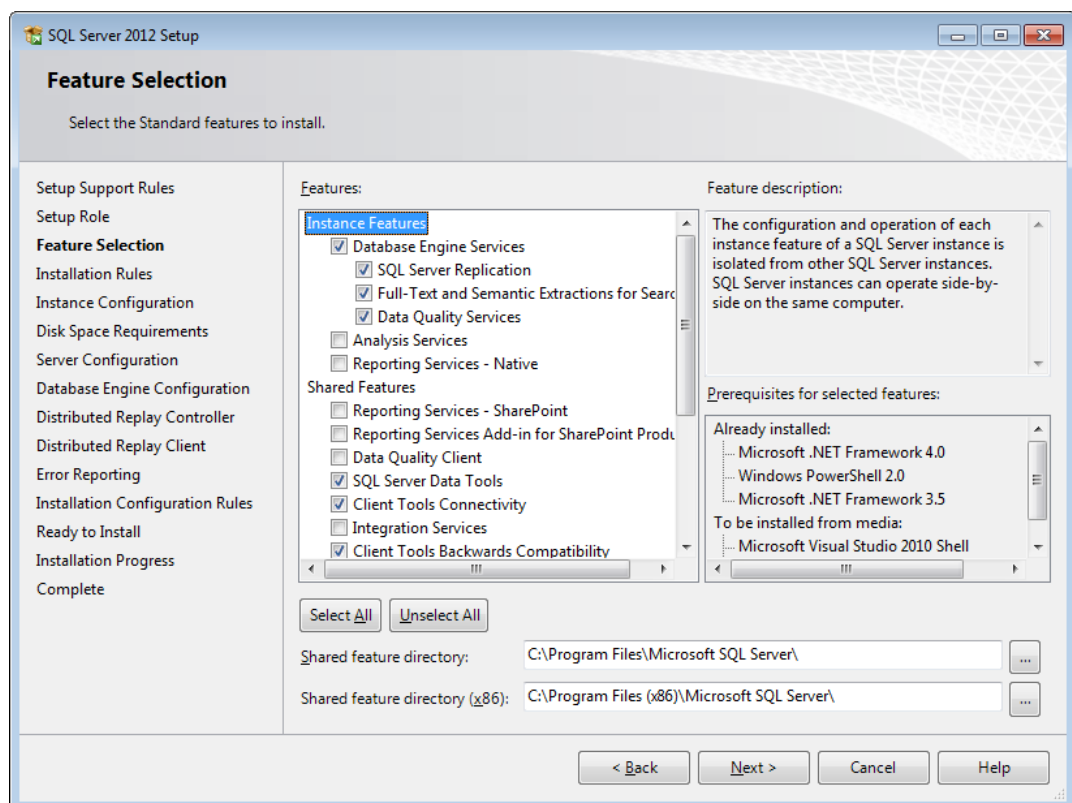

11. In the Installation Rules dialog box, click **View details** and ensure all the rules passed. Click **Next**.

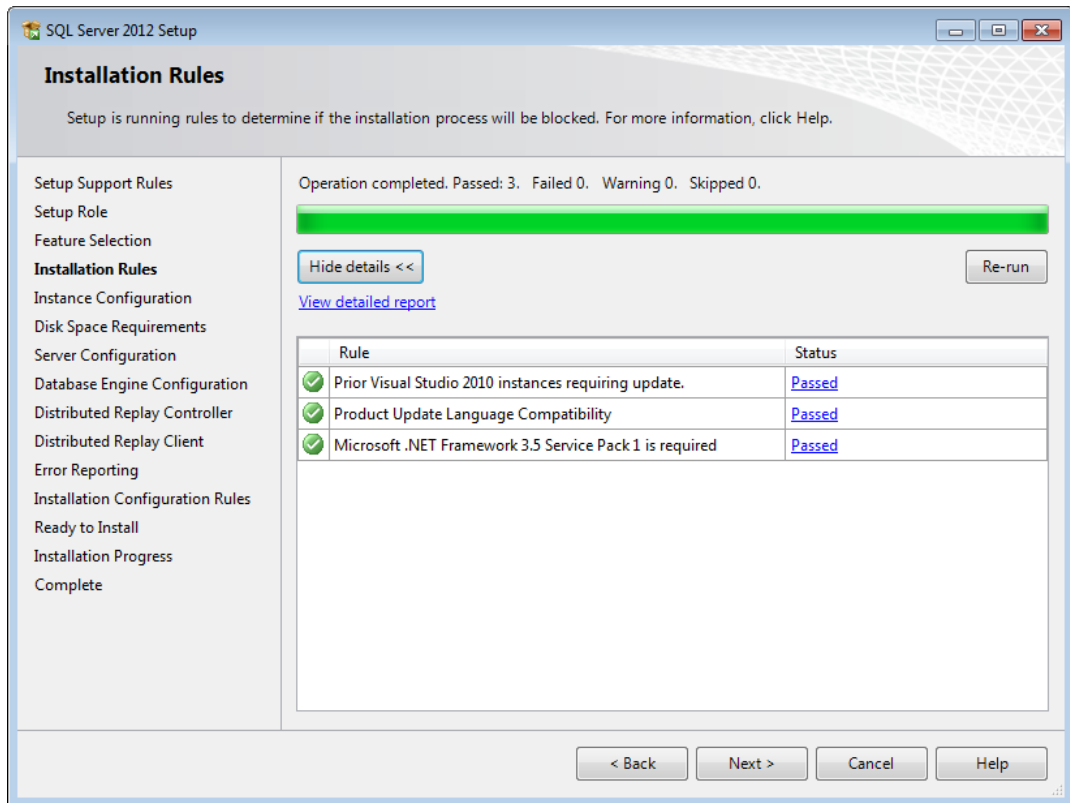

12. In the Instance Configurations dialog box, click **Named instance** and enter a sensible name for the instance. Make a note of the Instance ID as you will need it for the database scripts batch file later. Click **Next**.

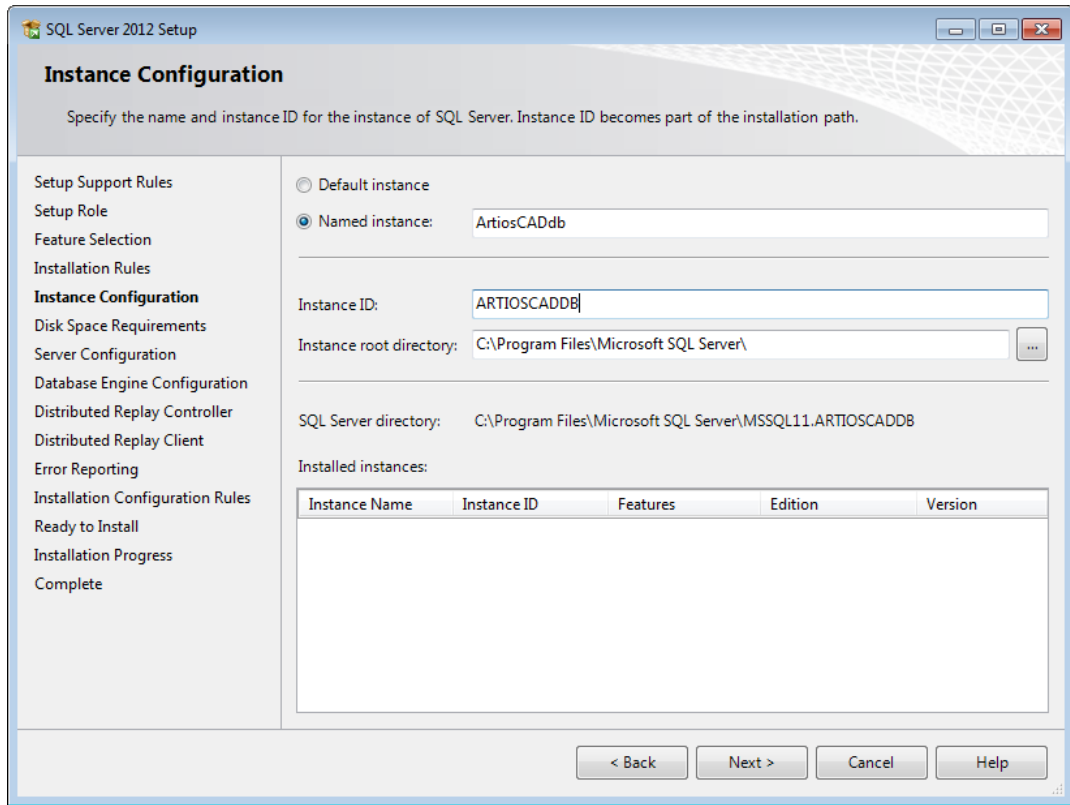

13. In the Disk Space Requirements dialog box, verify that the selected locations have enough room available and click **Next**.

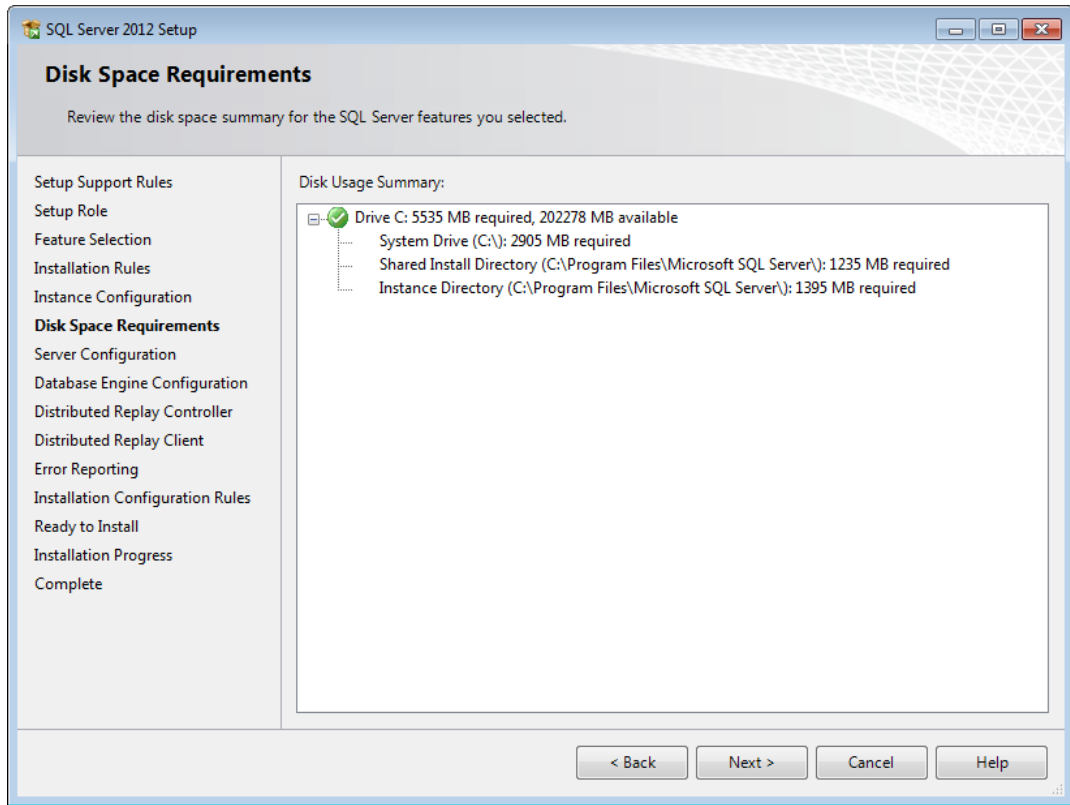

14. In the Server Configuration dialog box on the Service Accounts tab, review the service startup types and change them if desired.

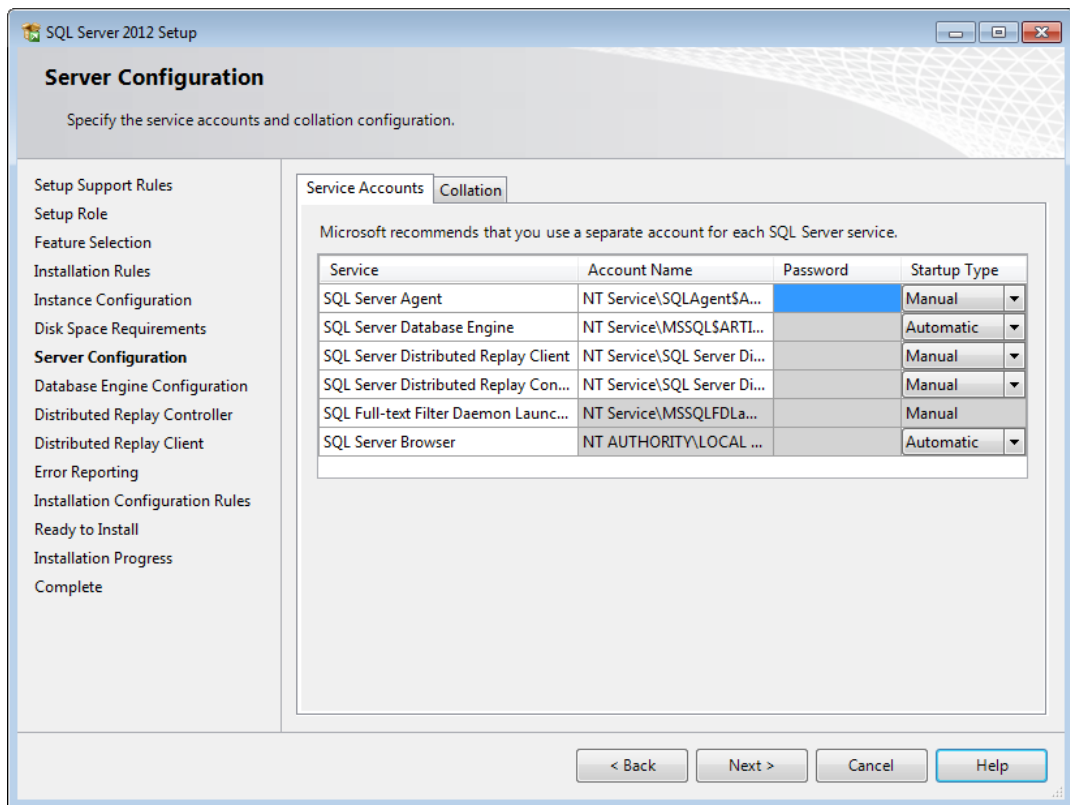

On the Collation tab, if you do not want to use the default collation (a group of location-related settings), click **Customize** and change it. Make sure to choose one that is case-insensitive and accent-sensitive. In most cases, the default collation should be sufficient; only change it if you know in advance you should.

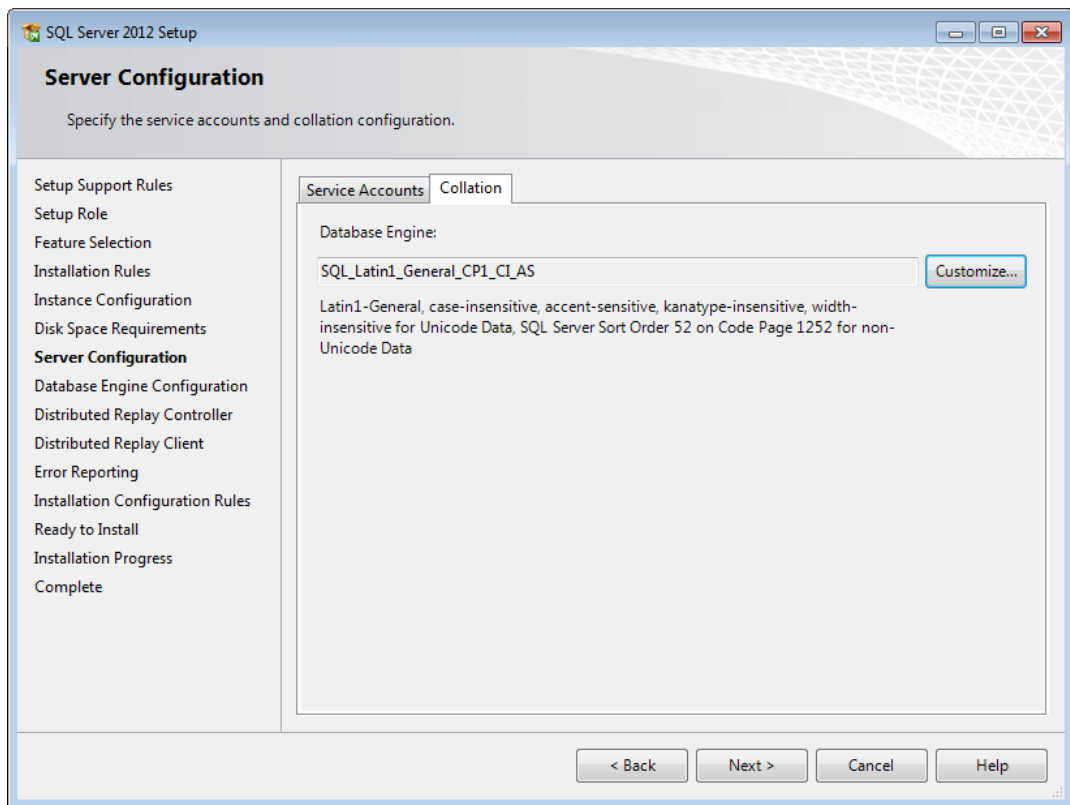

Click **Next**.

15. In the Database Engine Configuration dialog box, click **Mixed Mode (SQL Server authentication and Windows authentication)**. For the password, enter a password of your own choosing that complies with your local password policy in both password fields. **Make sure to record this password in a secure location as you will need it later.** In the Specify SQL Server administrators group, click **Add Current User** to add yourself as a database administrator, or click **Add** to add other users or groups as database administrators. You must add at least one account. Click **Next**.

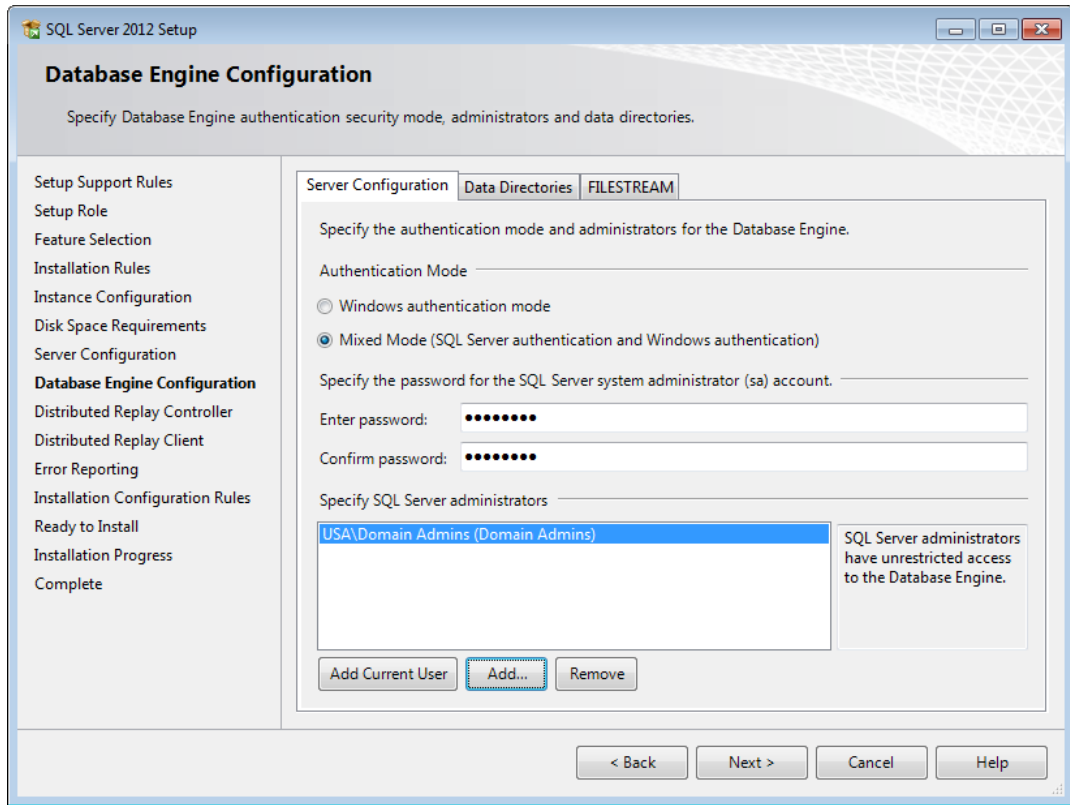

16. Click **Next** in the Distributed Replay Controller, Distributed Replay Client, and Error Reporting dialog boxes.
17. In the Installation Configuration Rules dialog box, click **View details** and ensure all the rules passed. Click **Next**.

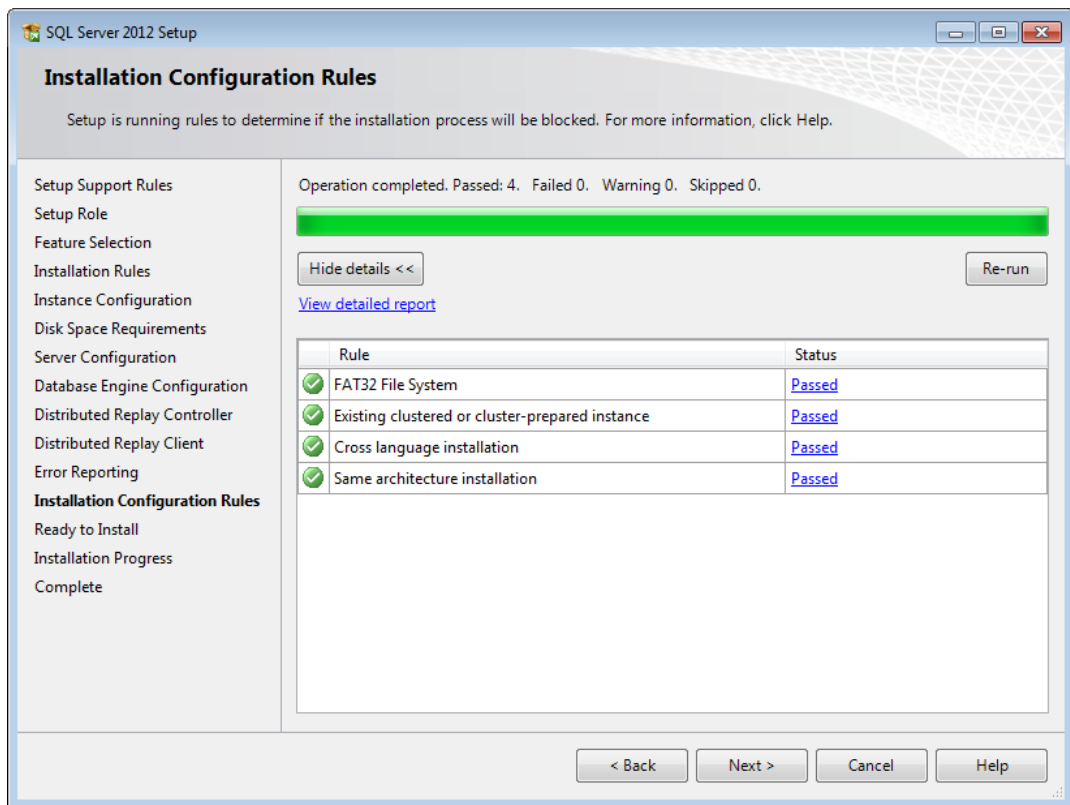

18. In the Ready to Install dialog box, scroll down the list of actions and verify them for accuracy. Click **Install** to begin installing the software. A progress bar will appear.

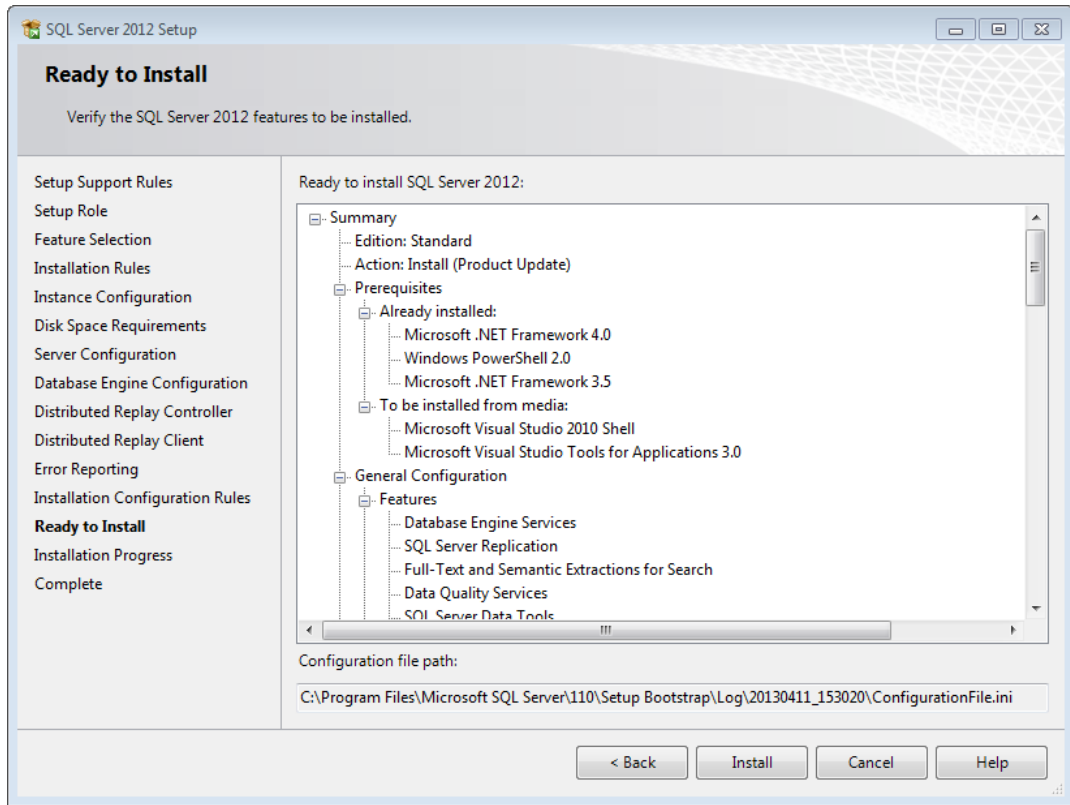

19. In the Complete dialog box, review the list of features to make sure they succeeded. Click **Close**.

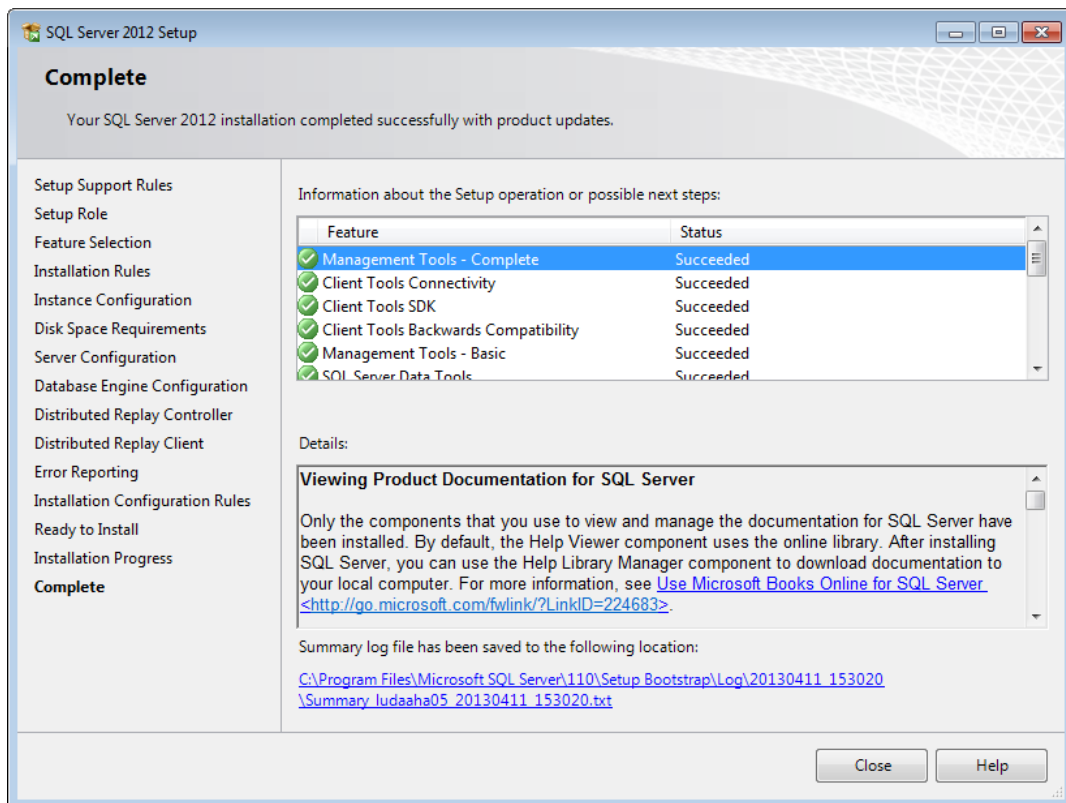

20. Close the SQL Server Installation Center.

21. Go to Windows Update, install Microsoft Update if it is not already installed, and then use it to install updates for Microsoft SQL Server 2012 and related programs.

Microsoft SQL Server 2012 is now installed and ready for you to configure it for use with ArtiosCAD.

Configuring Microsoft SQL Server 2012

Once you have updated and patched Microsoft SQL Server 2012 appropriately, continue as follows.

Creating the ArtiosCADdb database

If you rebooted the machine, log in as a user with administrative privileges.

1. Click **Start > All Programs > Microsoft SQL Server 2012 > SQL Server Management Studio**.
2. In the Connect to Server dialog box, make sure the Server type is set to Database Engine and the Server name is set to the instance you specified. Change the Authentication to **SQL Server Authentication**, enter sa as the Login, and enter the password you chose for the sa user for the Password. Click **Connect**.

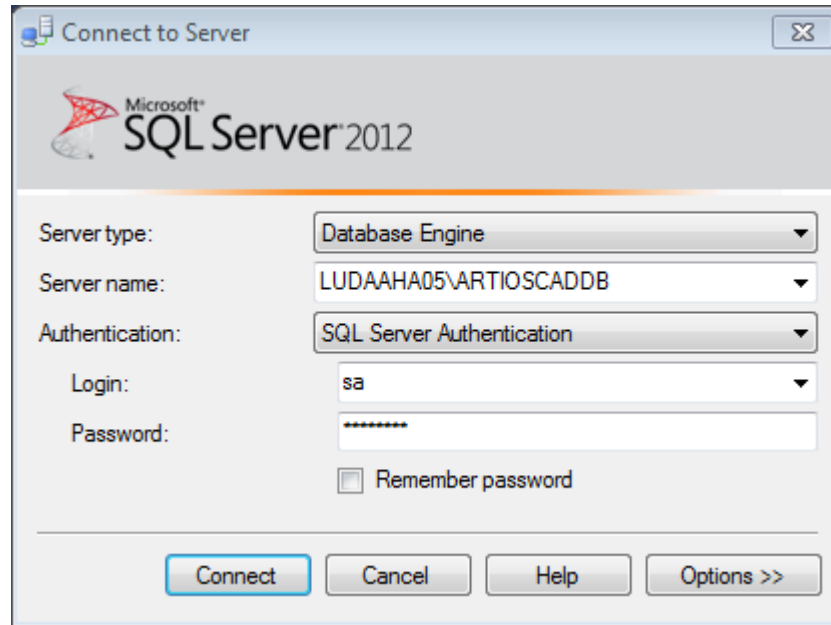

3. Right-click **Databases** and click **New Database**.

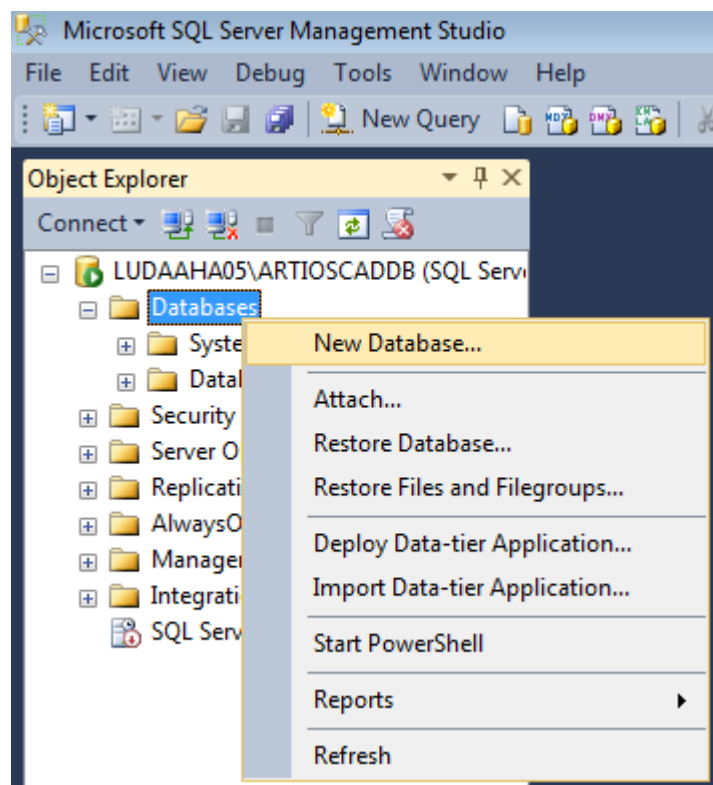

4. In the New Database dialog box, for the Database Name, enter ArtiosCADdb. Do not click **OK**.

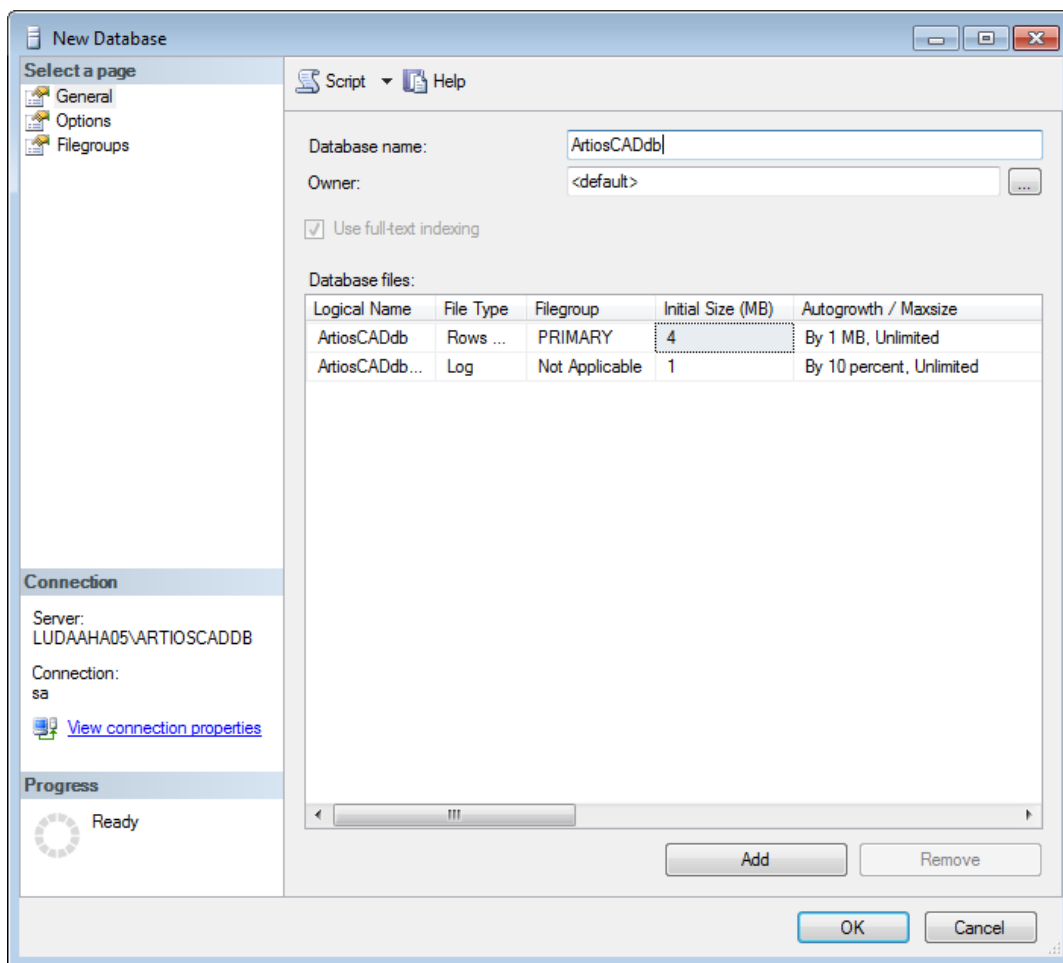

5. Click the 4 in the **Initial size (MB)** column and change it to **10**. Do not click **OK**.

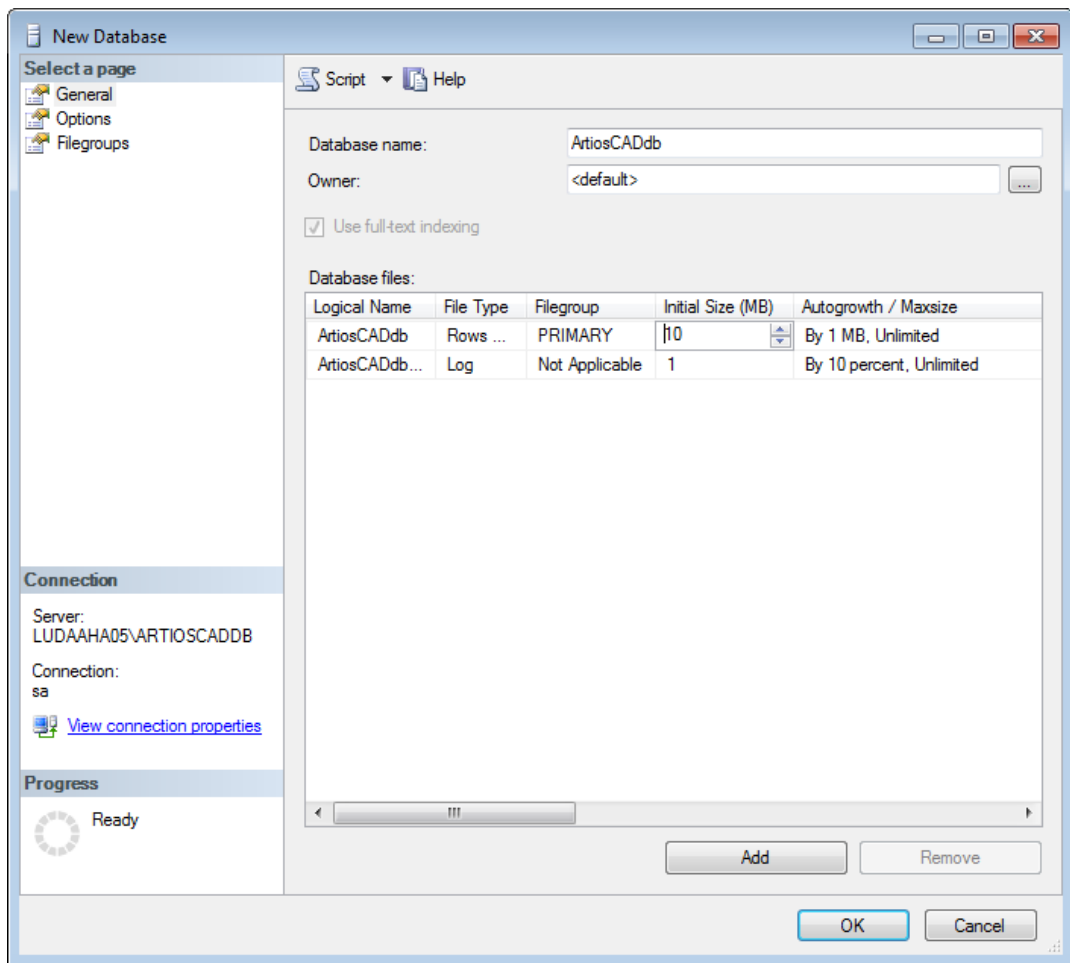

6. If this is a normal computer with one hard drive and two hard drive controllers, click **OK**. If this is a high-end database server and has multiple hard drives and multiple controllers, use the scroll bar to scroll to the right, click the Browse (...) button for the ArtiosCADdb Log file, and locate the transaction log on a separate disk on a separate controller. This will minimize data loss when a hard drive crashes. Click **OK** when done.

The ArtiosCADdb database should appear in the group of databases as shown below.

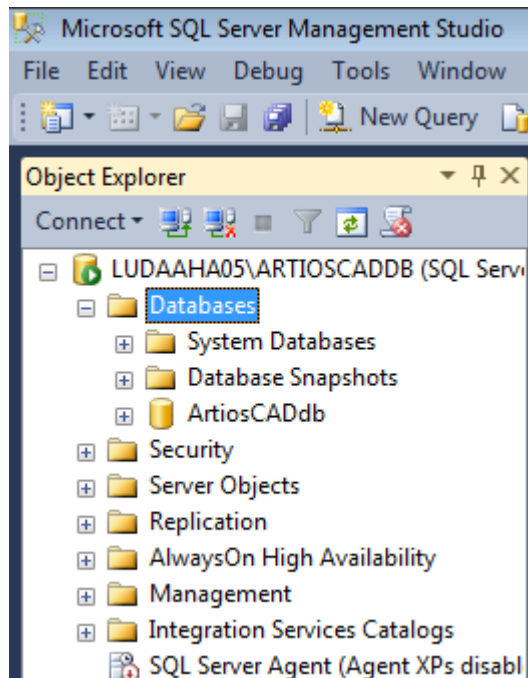

The database is now created and the next step is configuring the ODBC driver.

Configuring the 32-bit ODBC driver

As ArtiosCAD is a 32-bit application, it must use a 32-bit connection to a database. If you have installed ArtiosCAD on the database server, the installation process creates a shortcut to the 32-bit ODBC configuration application in Administrative Tools.

1. Log in as Administrator or as a user with administrative privileges.
2. If you have installed ArtiosCAD on this computer, click **Start > Control Panel > System and Security > Administrative Tools > Data Sources 32 bit (ODBC)**. If you have not installed ArtiosCAD, start Windows Explorer, navigate to C:\Windows\SysWOW64, and double-click `odbcad32.exe`.
3. In the ODBC Data Source Administrator, click **System DSN** and click **Add**.

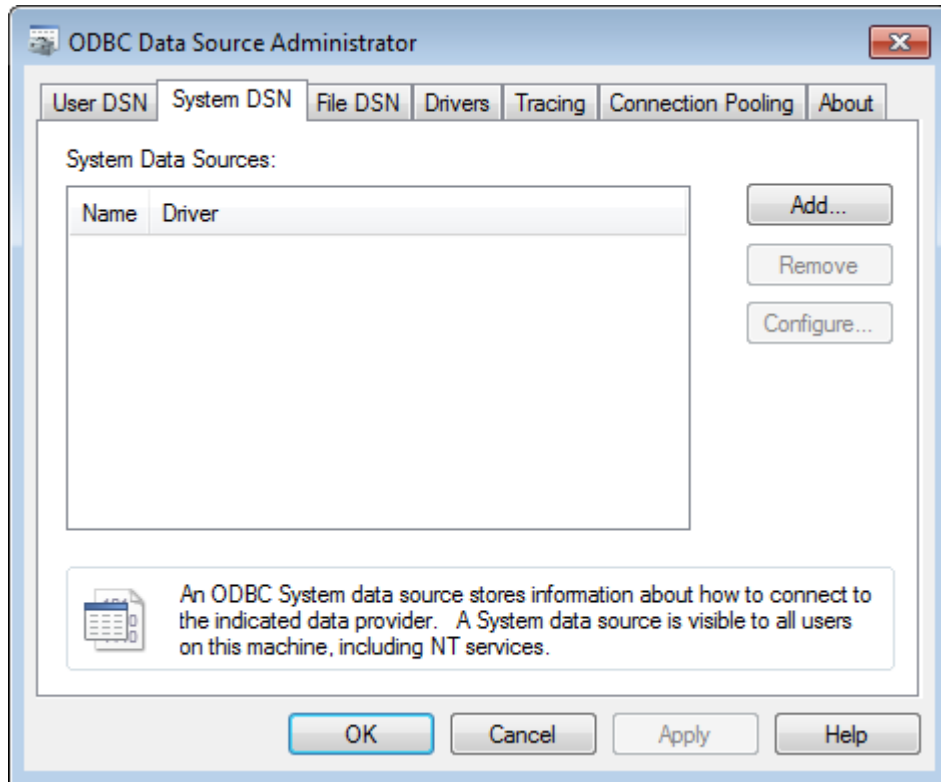

4. Select **SQL Server** from the list of available drivers and click **Finish..**

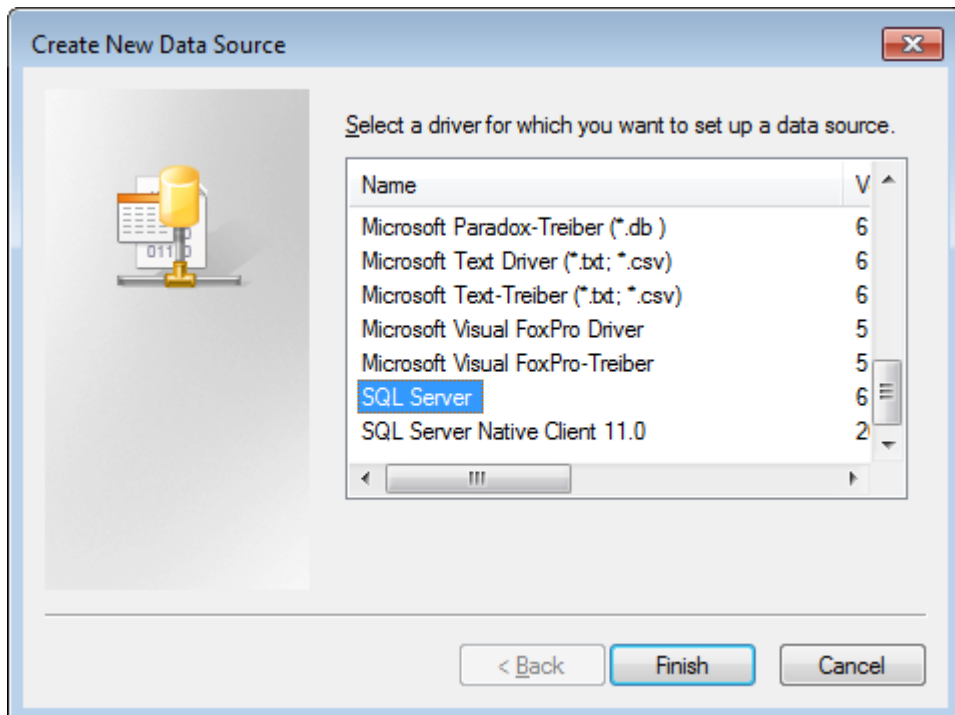

5. In the Create a New Data Source to SQL Server dialog box, enter ArtiosCAD in the Name and Description fields and select the server and instance name in the Server drop-down list box. If this is a client, specify the name of the database server. Click **Next**.

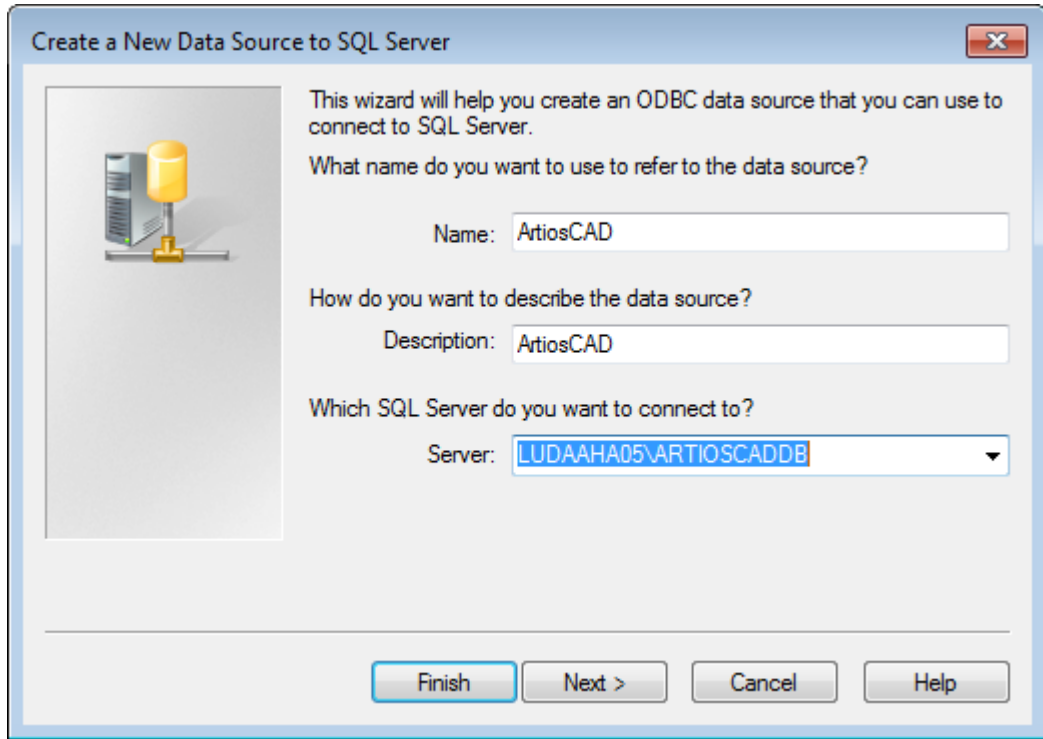

6. When asked about authenticity, select the **With SQL Server authentication...** choice. In that same dialog box, deselect the **Connect to SQL Server ...** checkbox. Do not click **Next**.

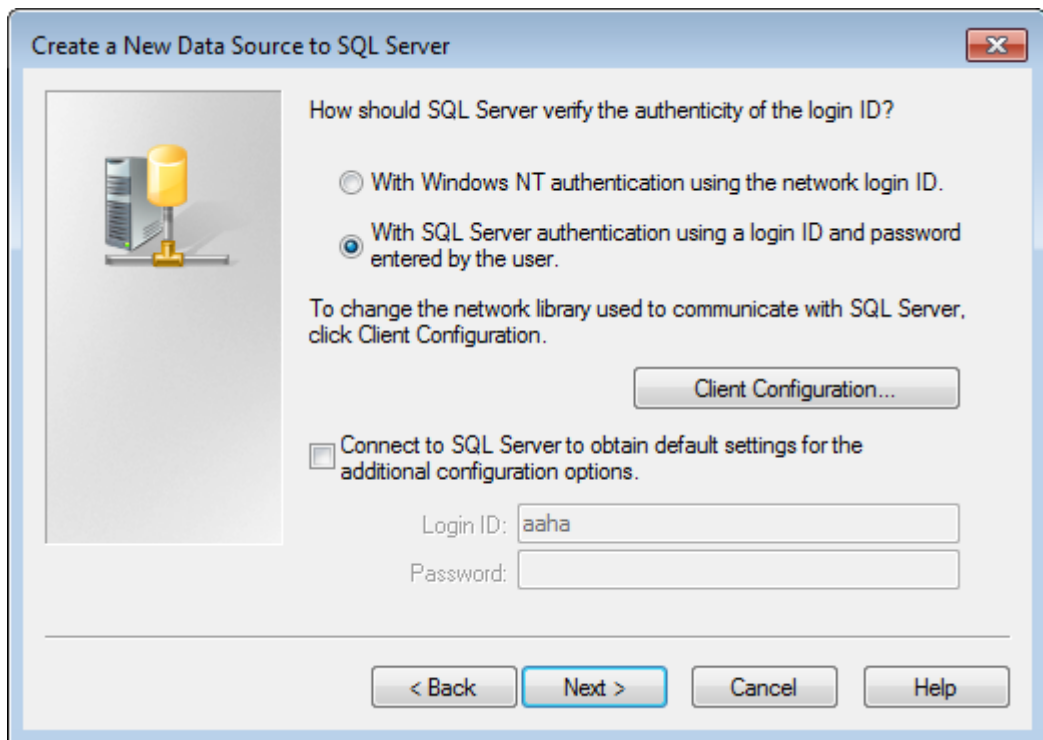

7. Click **Client Configuration**. The Add Network Library Configuration dialog box appears.

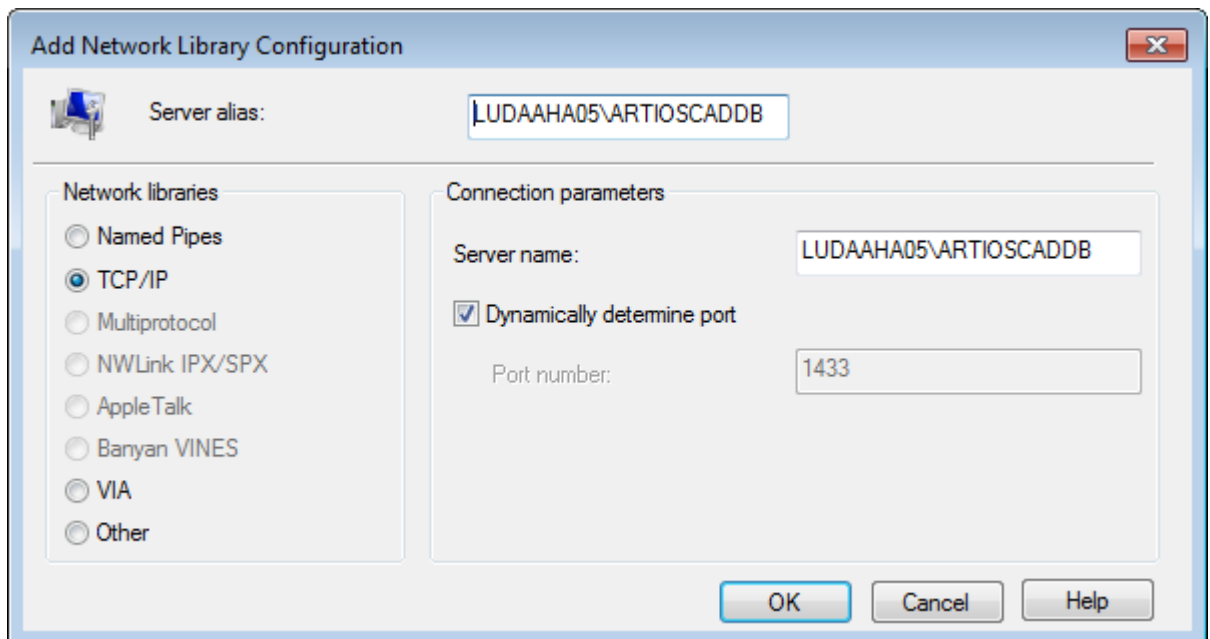

- a) Make sure **TCP/IP** is selected in the Network libraries group and ensure the server name is correct. If **(local)** was selected in the Which SQL Server do you want to connect to? field in Step 5, only a period (.) appears in the Server alias field and Server name field.
- b) Ensure that **Dynamically determine port** is checked and that the **Port number** is set to 1433. Click **OK**.

- c) Click **Next** in the Create a New Data Source to SQL Server dialog box.
- 8. In the next dialog box, leave the **Create temporary stored procedures...** and **Use ANSI...** choices selected and click **Next**.

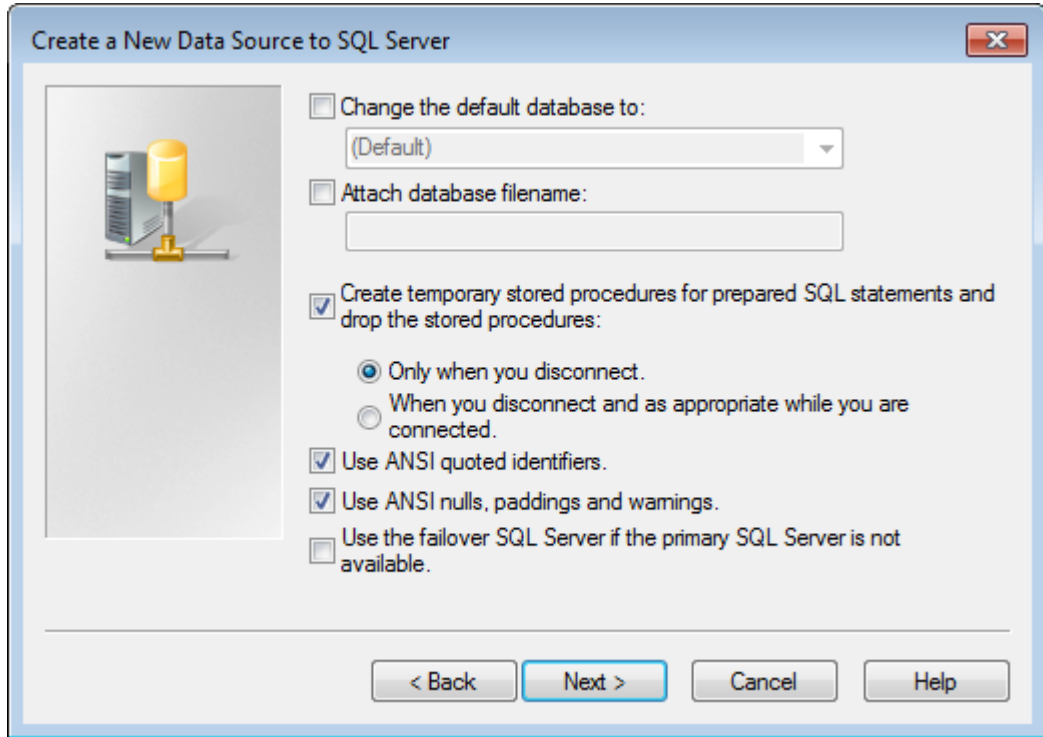

- 9. In the next dialog box, leave **Perform translation for character data** selected. If the system is using non-U.S. locale settings, check the **Change the language of SQL Server system messages to:** checkbox and set the value to **English**. Click **Finish**.

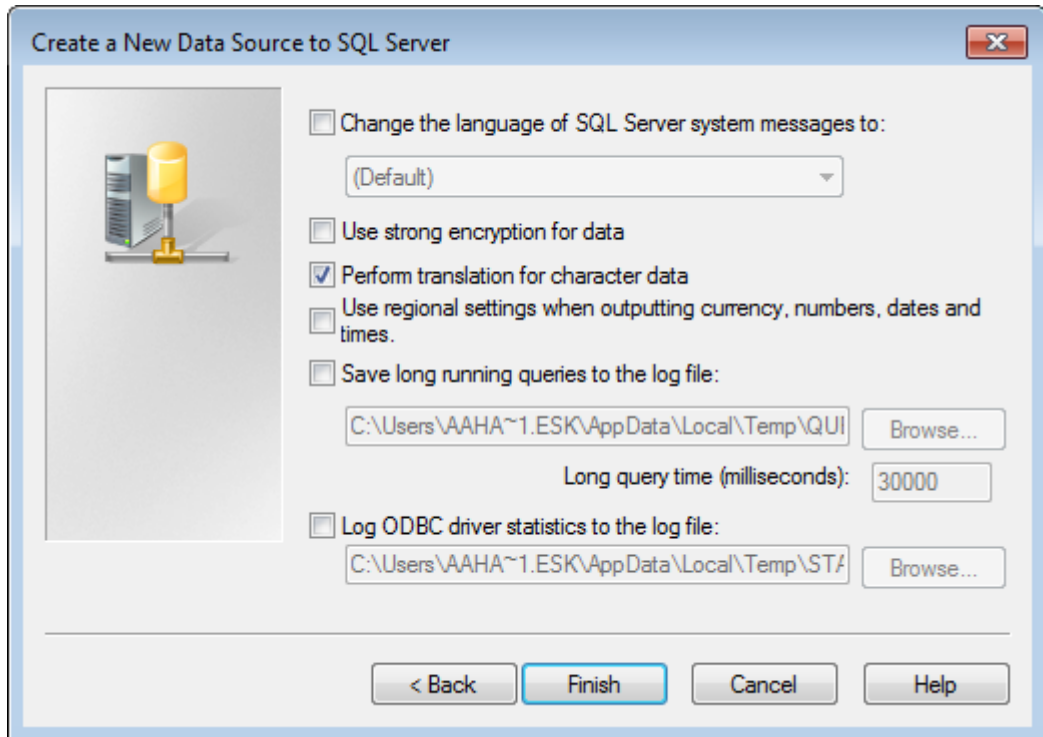

10. The ODBC Microsoft SQL Server Setup dialog box will appear showing a summary of the configuration. Do not test the configuration; it will fail because the proper database user is not configured because the database configuration batch file has not yet been run. Click **OK**.

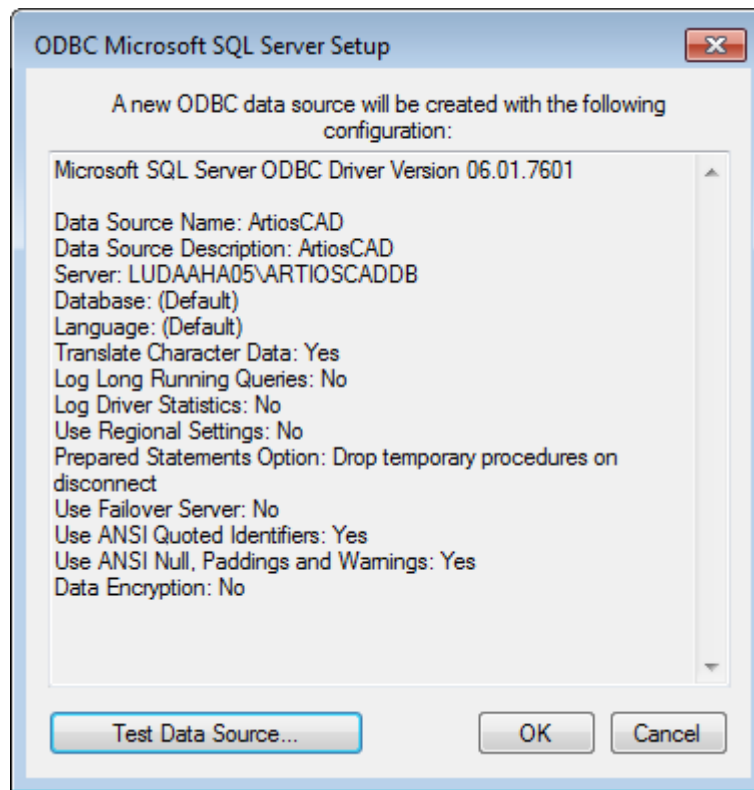

11. Click **OK** in the ODBC Data Source Administrator dialog box.

The ODBC connection on the server is now configured properly. The next step is running the database configuration batch file.

Running the ArtiosCAD database configuration batch file

Make sure the ODBC connection to the ArtiosCAD database is configured as described in the previous section before running the batch file.

Note:

You will most likely need to edit the batch file to supply the programmer user's password before you run it.

To run the ArtiosCAD database scripts, do the following:

1. You should still be logged in as **Administrator** or as a member of the Administrators group. If not, log in as such.
2. Start a command prompt and change the directory to \Esko\Artios\DataCenter. If you do not have ArtiosCAD installed on the database server, copy the entire DataCenter directory and subdirectories from a system with ArtiosCAD on it to a local temporary folder to which you have write access.
3. Build the database schema. The schema build command is in the form `Build_MSSQLServerSchema "<sa_user_Password>" "<server name>\<instance name>" "<DataCenter root directory>" "<DataCenter program language directory>"`. The command

should be similar to the one shown below, substituting your installation information and language as needed.

```
Build_MSSQLServerSchema "SysP433w0rd***" "LUDAAHA05\ArtiosCADdb" "C:\Esko\Artios\datacenter" "C:\Esko\Artios\datacenter\program\english"
```

When you have typed the command, press Enter. Comments and commands will appear in the command prompt similar to example shown below.

4. When the command prompt returns, type exit and press Enter.

The database is now ready for use with ArtiosCAD and DataCenter Admin. Add servers and resources as described in the **Working with servers and resources** section of the *DataCenter* chapter.

Notes and troubleshooting

The following notes deal with using SQL Server Management Studio in the Microsoft SQL Server folder on the Start menu.

- If error messages appear about not being associated with a trusted SQL Server connection, right-click the server instance name, and then click **Properties > Security**. Make sure **SQL Server and Windows Authentication mode** is selected in the Server authentication group.
- If many script errors appear, make sure the **Implicit transactions** checkbox is clear on the **Properties > Connections** page in the Default connection options list.
- If error messages appear about the programmer user not existing or not having permission, do the following:
 - Expand the database instance in the left pane so the **Security** folder is open and double-click **Logins**.
 - Right-click **programmer** and click **Properties**.

- On the General page, there should be a password set in the Password field, the Default database should be set to **ArtiosCADdb**, and the Default language should be set to **English**. If this is not so, click the Server Roles page and ensure that **public** is checked.

If you are using SQL Server Express Edition and you need to run the database script batch file, use Build_ExpressSchema.bat with the same syntax as Build_MSSQLServerSchema.bat.

Using Oracle

Instruction on installing Oracle is beyond the scope of this document. It should only be done by experienced database administrators. Here is a rough overview of the steps required:

- Install Oracle and create an instance. Within that instance create a database. Set up network access to it using Net Configuration Assistant to connect to that database.
- Install ArtiosCAD on the database server, making sure to do an **Advanced** installation and selecting **Microsoft SQL Server 2000 or Oracle** as the database choice.
- Set up an ODBC Data Source using the Microsoft ODBC for Oracle driver. Set the **Data Source Name:** to **ArtiosCAD**, the **Description:** to **ArtiosCAD**, and the **Server:** to **TNS:Name_of_database_defined_in_Net_Config-uration_Assistant** that you configured when installing Oracle, such as **TNS:orcl**.
- Run the database configuration batch file to build the database schema.

Start a command prompt and change the directory to **\Esko\Artios\DataCenter**.

The schema build command is in the form `Build_OracleSchema "<sys Password>" "<TNS name>" "<DataCenter root directory>" "<DataCenter program language directory>"`.

If the **sys** database user has no password, use a double set of quotation marks ("").

The final command you type at the command prompt should be similar to the one shown below, substituting your installation information and language as needed.

```
Build_OracleSchema "administrator" "orcl" "C:\Esko\Artios\datacenter" "C:\Esko\Artios\datacenter\program\english"
```

- Add servers and resources as described in the **Working with servers and resources** section of the *DataCenter* chapter.

Note: If WebCenter and your production installation of ArtiosCAD (**not** the one required for WebCenter’s Application server) are using the same database server with Oracle 9i, and you upgrade the version of Oracle on the database server, it may break the Microsoft ODBC for Oracle drivers required by ArtiosCAD. Please note that this is NOT a supported configuration and you alone are responsible for ensuring that it works. If you upgrade Oracle and start getting SQLSetConnectAttr errors, try changing two entries in the Registry on the database server. Specifically, in **HKEY_LOCAL_MACHINE > Software > Microsoft > MsDTC > MTxOCI**, change the **OracleSqlLib** key to **orasql9.dll** and change the **OracleXaLib** key to **oraclient9.dll**.

Replacing an ArtiosCAD server

As time passes, you may need to replace an existing ArtiosCAD server with a newer, faster model. Listed below are the basic steps required to replace a machine acting as the Defaults server, Database server using MSDE, and License server using a security key. Contact Esko Support for more details.

1. Make a complete backup of the system that is being replaced and verify that the data is readable. Keep this backup in safe, easily-accessible place.
2. Install the same version of ArtiosCAD on the new server as is currently on the existing server. Make sure to specify the same licensing method.
3. For pre-16 versions of ArtiosCAD, copy the `..\Esko\Artios\ArtiosCADn.nnl\ServerLib` folder from the existing server to the new server. For version 16 or later, copy `..\Esko\Artios\ServerLib`.
4. If your old server uses a security key, copy `..\Esko\Artios\ArtiosCADn.nnl\Common\tuneopt.txt` and/or `tuneopt7.txt` on the old server to the corresponding directory on the new server.
5. Move the security key to the new server.
6. If your old server uses a license manager, deactivate the license and copy the deactivation files to the new server. Activate the license on the new server.
7. Start ArtiosCAD on the new server and click **Options > Defaults**.
8. Go through the various entries and adjust them as necessary, specifically the entries for Output devices and other things which may contain system names or paths.
9. An exact image copy of the database from the old server will be made on the new server. Therefore, put the user files (if any) in the same location in the file system on the new machine as on the old machine.
10. On the old system, detach the database using the following procedure:
 - Log in as a member of the **Administrators** group.
 - Start a command prompt.
 - At the prompt, type `osql -Usa -P"" -S systemname\ArtiosCADdb` and press Enter. (If the **sa** password is not blank, insert it between the quotation marks in the `-P` switch.)
 - At the `1>` prompt, type `sp_detach_db 'ArtiosCADdb'` and press Enter.
 - At the `2>` prompt, type `go` and press Enter.
 - At the `1>` prompt, type `quit` and press Enter.
 - Type `exit` and press Enter to close the command prompt.
11. On the new server, do the same thing to detach the empty, just-installed MSDE database:
 - Log in as a member of the **Administrators** group.
 - Start a command prompt.

- At the prompt, type **osql -Usa -P"" -Ssystemname\ArtiosCADdb** and press enter. (If the **sa** password is not blank, insert it between the quotation marks in the -P switch.)
 - At the 1> prompt, type **sp_detach_db 'ArtiosCADdb'** and press enter.
 - At the 2> prompt, type **go** and press enter.
 - Do not close this program as it is needed for a future step.
- 12.** Copy the database files from the old server to the new server. They are in the **..\Esko\Artios\DataCenter\MSDE\MSSQL\$ARTIOSCADDB\Data** directory. Copy **ArtiosCADdb_data.mdf** and **ArtiosCADdb_log.ldf** to the corresponding directory on the new server. If prompted to overwrite existing files, say yes.
- 13.** On the new server, attach the new database files to the instance:
- In the command prompt window running osql, at the 1> prompt, type **sp_attach_db "ArtiosCADdb", "C:\Esko\Artios\DataCenter\MSDE\MSSQL\$ARTIOSCADDB\Data\ArtiosCADdb.mdf"** and press enter. **Note:** Do not omit the comma. Also, change the path to the .mdf file as needed if you did not install ArtiosCAD to the C: drive.
 - At the 2> prompt, type **go** and press enter.
- 14.** Reconnect the **programmer** database login to the database instance:
- At the 1> prompt, type **use ArtiosCADdb** and press enter.
 - At the 2> prompt, type **go** and press enter.
 - At the 1> prompt, type **sp_change_users_login update_one, programmer, programmer, null** and press enter.
 - At the 2> prompt, type **go** and press enter.
 - At the 1> prompt, type **quit** and press enter.
 - Type **exit** and press enter to close the command prompt.
- 15.** In DataCenter Admin, go through the entries for servers and resources and adjust them as necessary.
- 16.** If the old server used ArtiosIO, configure and start it on the new server.
- 17.** On each client, use Programs and Features in Control Panel to **Change** and then **Modify** the installation of ArtiosCAD. Specify the name of the server as appropriate.
- ArtiosCAD should now be fully functional on the new server and any clients.

8. Defaults

Introduction to Defaults

Defaults store all the configuration information used by ArtiosCAD. This is where you change options, add custom standards to the Standards Catalog, define Outputs, and so forth. You access defaults by clicking **Defaults** on the Options menu. There are many options in Defaults that are not covered in this chapter; you should open each Defaults catalog or folder and review its contents.

If you are using ArtiosCAD Enterprise, Defaults specific to it are in the *Installing and Configuring ArtiosCAD Enterprise* chapter. If you do not see the information you are looking for in this chapter, look in that one.

There are two types of defaults: **Shared defaults** and **User defaults**. Shared defaults are shared by all users served by the same ArtiosCAD server. User defaults affect only the machine being used.

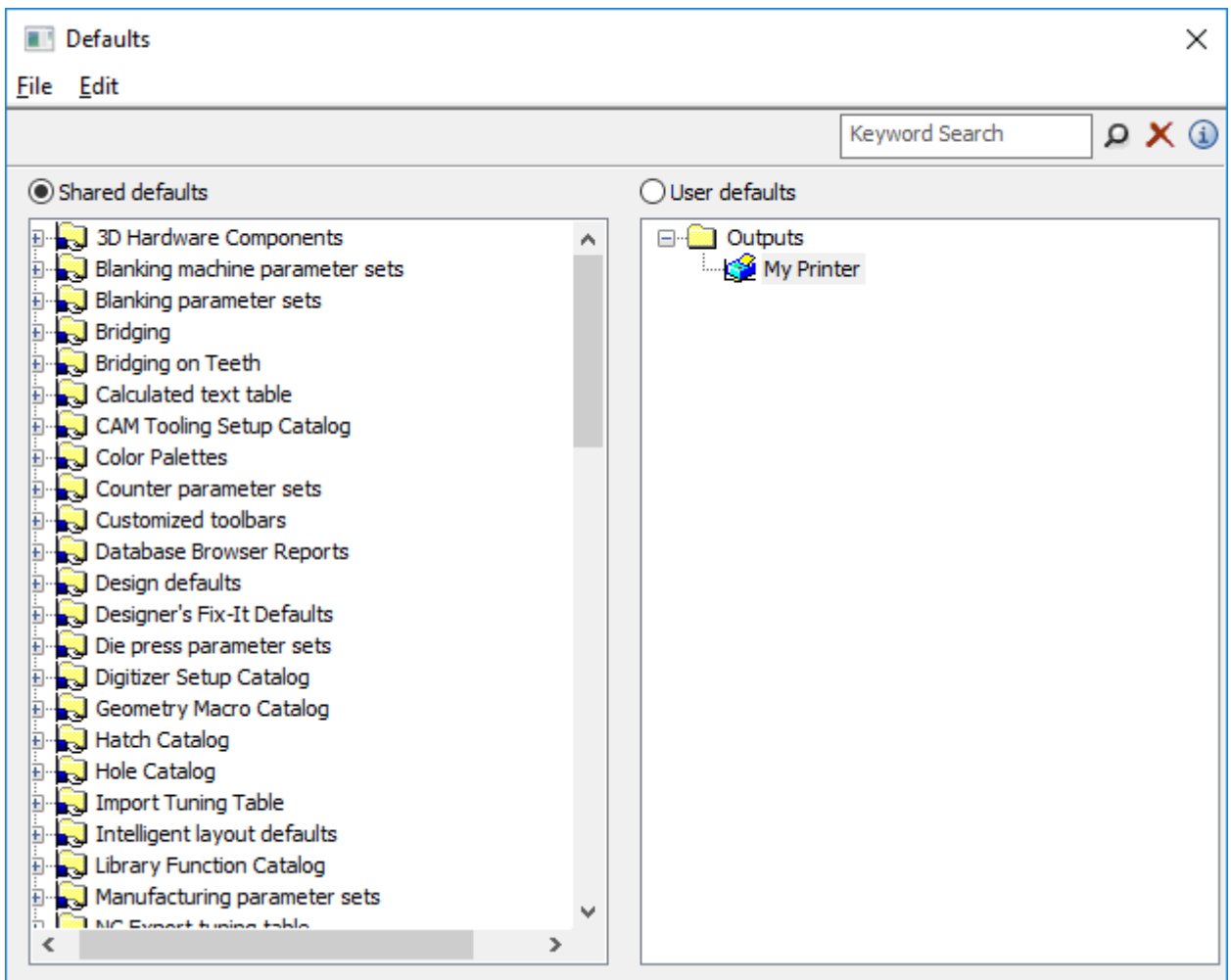

Creating defaults

There are three ways to create new defaults:

1. In the Shared defaults pane, open the folder containing the Defaults you want to add to and right-click. Clicking **Folder** adds a new folder; clicking **Data** adds a new default setting.
2. In the User defaults pane, make sure nothing is selected, and right-click. Choose the type of default to add from the pop-up context menu. When naming the new item, do not use a backslash (\).
3. Drag a pre-existing default from one pane into the other and modify as desired.

Changing defaults

To change a default, open the folder it is in and double-click it. A dialog box will appear showing all the settings you can change.

If you want to change all the defaults in a folder at once, double-click the folder instead of an individual item, and a tabbed dialog box will appear containing all the individual items.

Saving defaults

It is very important to save the defaults after you make changes. The option button above the two panes indicates which set of defaults is being affected by the commands on the File menu. Make sure the option button is set to the pane of defaults you have changed, click **File**, and then click **Save**.

Searching for Defaults

Use the Keyword Search field at the top of the Defaults dialog box to search Defaults for your desired terms. This searches across all the Defaults currently shown in the dialog box; if you have Example defaults open instead of User defaults, it will search the Example defaults and not User defaults.



The search looks in:

- Node names / catalogs
- Labels
- Field contents

 Click the magnifying glass after you have entered your desired terms in the Keyword Search field to perform the search. You may also press Enter instead of clicking the magnifying glass.

 Click **Clear Search** to erase everything in the Keyword Search field and clear any search results shown in the Defaults dialog box.

 Click or hover over the Information button to see a list of searching syntax.

Searching Syntax Examples

Terms

word
word1 word2 ... wordN
"exact string"

Wildcards

*word**
*wo*d*
wo?d

Boolean

word1 word2 (same as: *word1 OR word2*)
word1 OR word2
word1 AND word2
word1 NOT word2
+word1 word2
word1 -word2

Groupings

(word1 OR word2) AND word3
word1 AND (word2 OR word3)

ArtiosCAD builds the search index in memory each time you perform a search. It does not store it for future use. As such, searching speed is directly related to computer performance.

Performing a Defaults Search

Let's say you change the Chamfer for corner value every time you create a dieboard. You want to change it in Defaults but you don't know where to look.

1. Click **Options > Defaults**.
2. In the Defaults dialog box, enter "Chamfer for corner" in the Keyword Search field and either click the magnifying glass icon or press Enter.
3. ArtiosCAD performs the search and highlights tree nodes that have hits in yellow. ArtiosCAD dims all the other nodes but they are still functional.

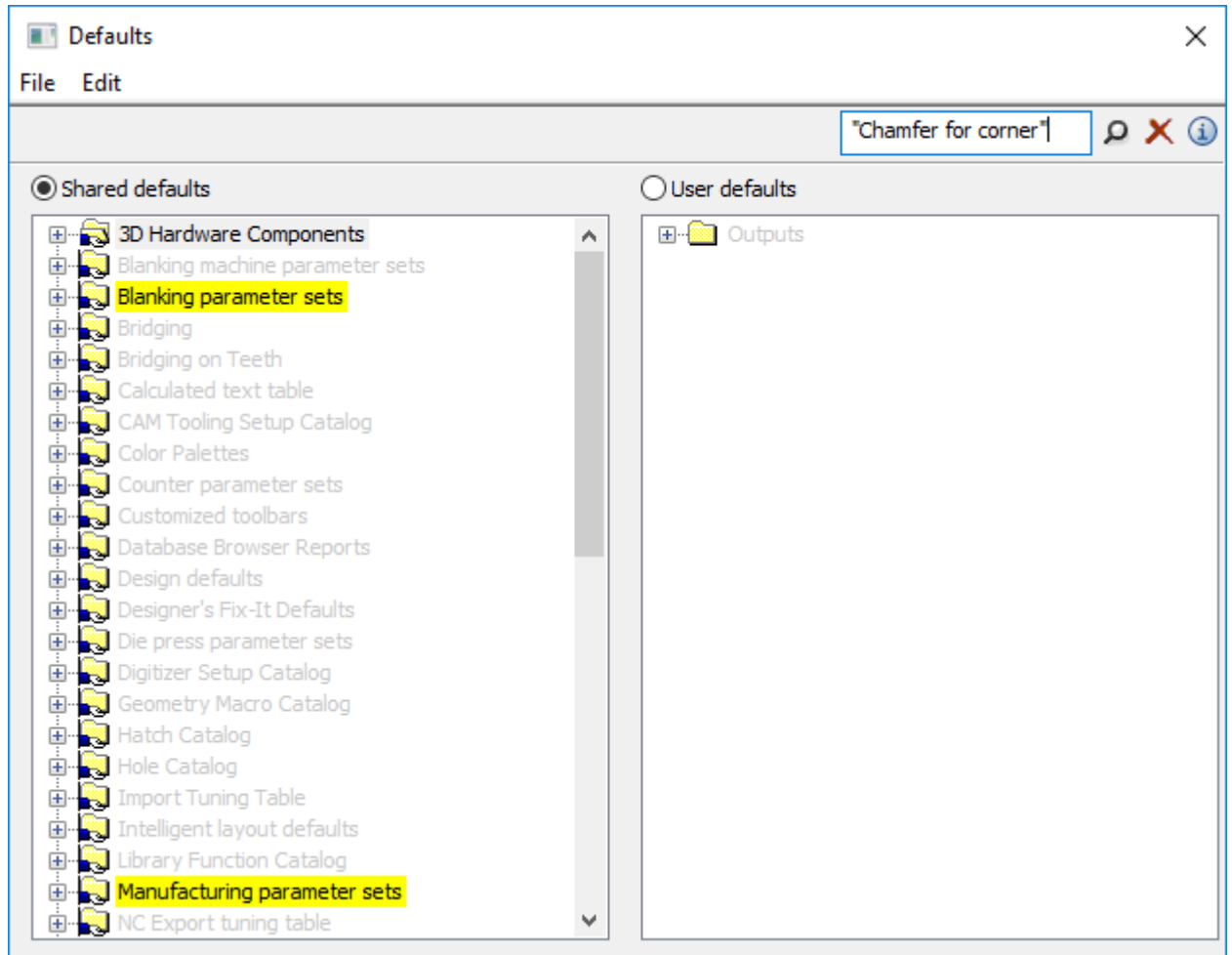

4. In this example, since you are not working with blanking, the value you want to change must be in the Manufacturing parameter sets catalog.
5. Keep expanding the highlighted nodes until you see **Wood corners** in the Die board catalog. Double-click it to open it.

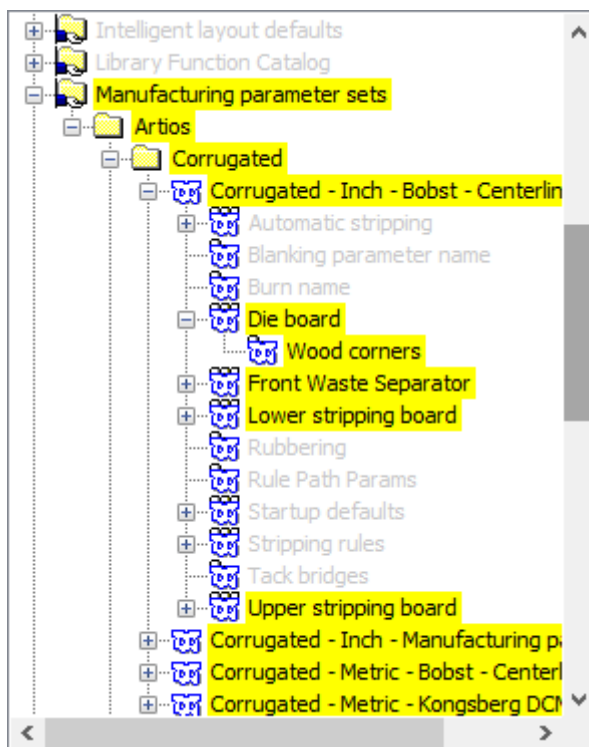

6. Change the Chamfer for corner field as desired and click **OK** to close the dialog box.

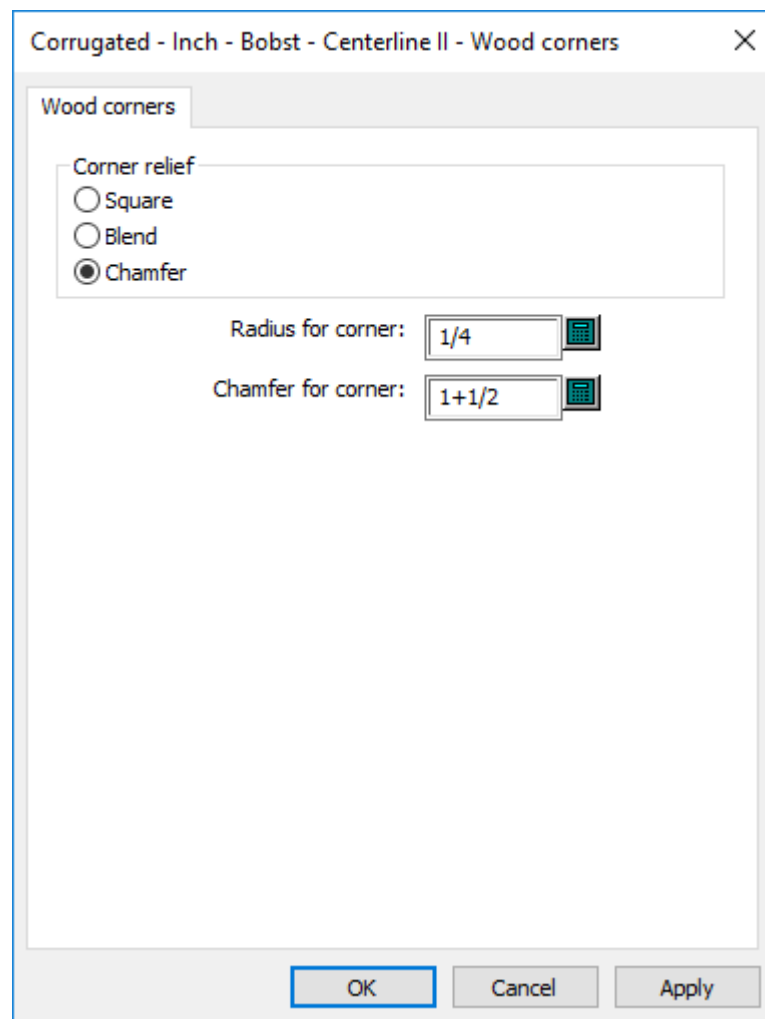

At this point, you could look at the other search results in case you want to change them too. To restore the regular view, click the red X. Save and exit Defaults as usual.

Defaults performance

ArtiosCAD loads Defaults into system memory when you launch it for more robust performance.

If you make changes to Defaults, click **Options > Clear Defaults Cache** to re-read Defaults into memory without having to restart ArtiosCAD.

ArtiosCAD re-reads the Defaults automatically when you click **Options > Defaults**, so you only need to clear the cache when you make a change and exit Defaults and then continue working in ArtiosCAD. Another time to clear the cache would be when you changed Defaults on one computer and other users were sharing those Defaults on other computers and did not want to restart ArtiosCAD; they would have to click **Clear Defaults Cache** to see your changes.

Parameter sets

Designer parameter sets

Parameter sets are collections of settings that govern how you work with designs or manufacturing files. The collection can be based on anything – by customers, by machines, or however else you want to group information.

Single design parameter sets allow you to assign different values to different sets for the following entries:

- Default bridging formulae to use
- Flute/grain setting, and if ArtiosCAD rotates designs based on standards to match
- Side up, and if ArtiosCAD mirrors designs based on standards to match

You select a parameter set when creating a design. You can change the parameter set being used by a design by clicking **Change Parameter Set** on the **Options** menu.

To create a parameter set, do the following:

1. Start ArtiosCAD.
2. Click **Options**, and then click **Defaults**.
3. To add a parameter set to Shared Defaults, open the Single Design Parameter Set entry. Right click it, select **New**, and then click **Data**.
4. Enter the name of this new parameter set and press Enter.
5. Click the plus sign (+) next to the parameter set you created.
6. Double-click **Startup defaults**. This will bring up a tabbed dialog box where you can set the initial side of the design, a default flute/grain direction, and default bridging formulae.
7. Click **OK** when you are done setting options for this new parameter set.
8. Click **File**, and then click **Save** to save the changes.

Manufacturing parameter sets

Manufacturing parameter sets, in conjunction with machine parameter sets, allow you to customize various settings per set or per machine. A partial list of the values you can set are:

- Die board size
- Automatic stripping parameters
- Default bridging formulae
- Hole mounting pattern workspaces and the side of the die used to determine if they are mirrored or not
- The Machine Reference Point, used by many things for alignment
- Settings for scrap/chop knives
- Mounting alignment hole parameters

A manufacturing parameter set references a die press parameter set and a printing press parameter set in addition to containing its own values.

To create a die press or printing press parameter set, do the following:

1. Start ArtiosCAD.
2. Click **Options**, and then click **Defaults**.
3. To add a parameter set to Shared Defaults, open the Die Press Parameter Sets or Printing Press Parameter Sets entry. Right click it, select **New**, and then click **Data**.
4. Enter the name of this new parameter set and press Enter.
5. Click the plus sign (+) next to the parameter set you created. The parameter set expands to show the top-level categories. Click each plus sign to open each category.

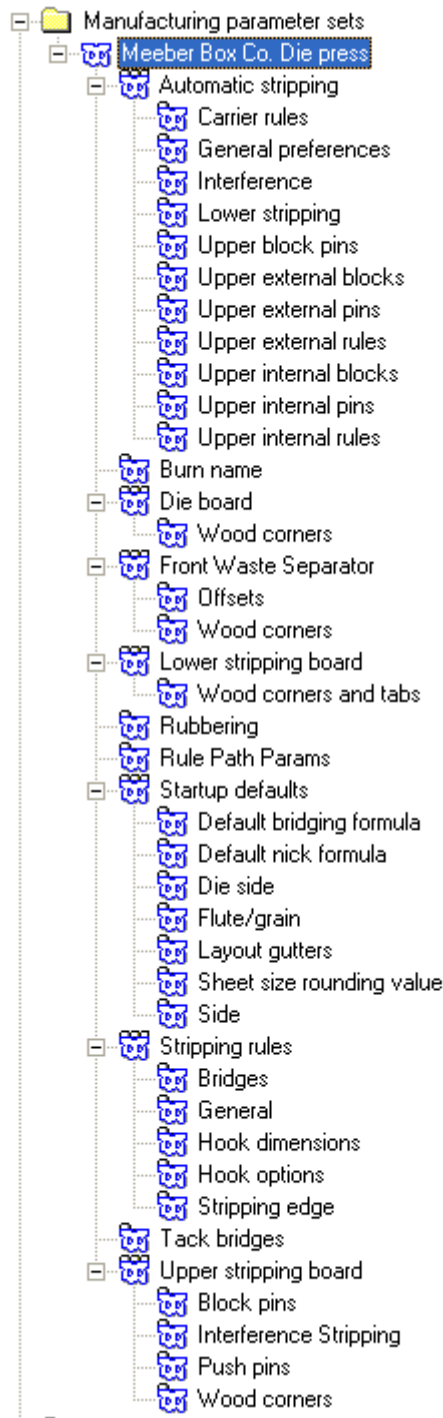

6. Double-click each entry, verify or change the settings within the dialog box that opens, and click **OK** when done. Repeat as desired for other settings.
7. Click **File**, and then click **Save** to save the changes, clicking **Yes** to overwrite previous Defaults.

Once the die press and printing press parameter sets are created, they can be incorporated into a manufacturing parameter set.

To create a manufacturing parameter set, follow the same procedure as creating other parameter sets: right-click **Manufacturing parameter sets**, click **New**, and so forth. Next, do the following:

1. Double-click the name of the parameter set to associate die and printing press parameter sets with it. Click **OK** once you have chosen sets.

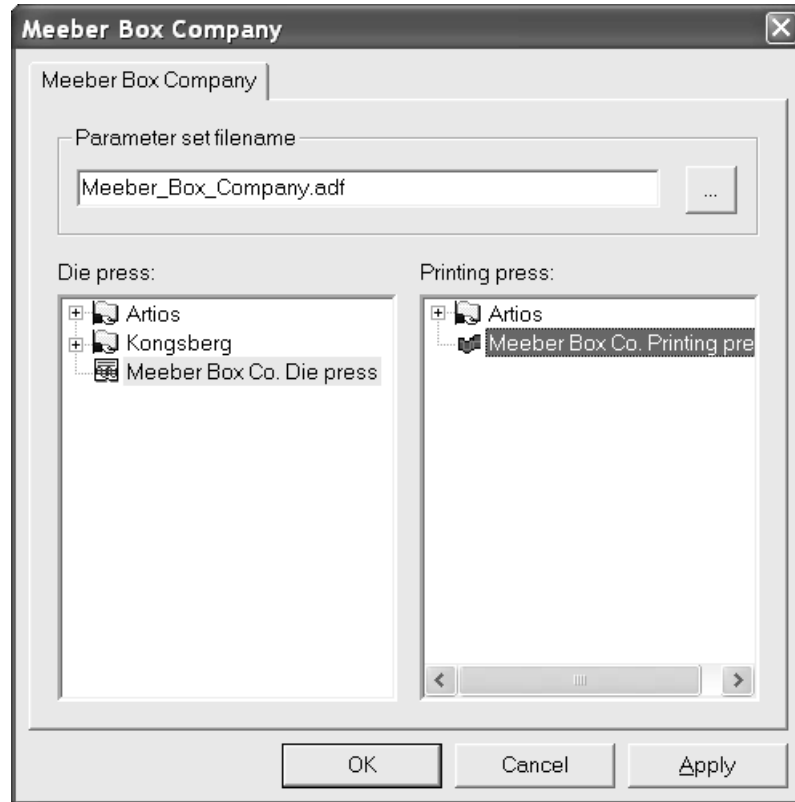

2. Open the parameter set and enter values for all the fields. Your Defaults pane with all catalogs expanded should look similar to the picture shown below.

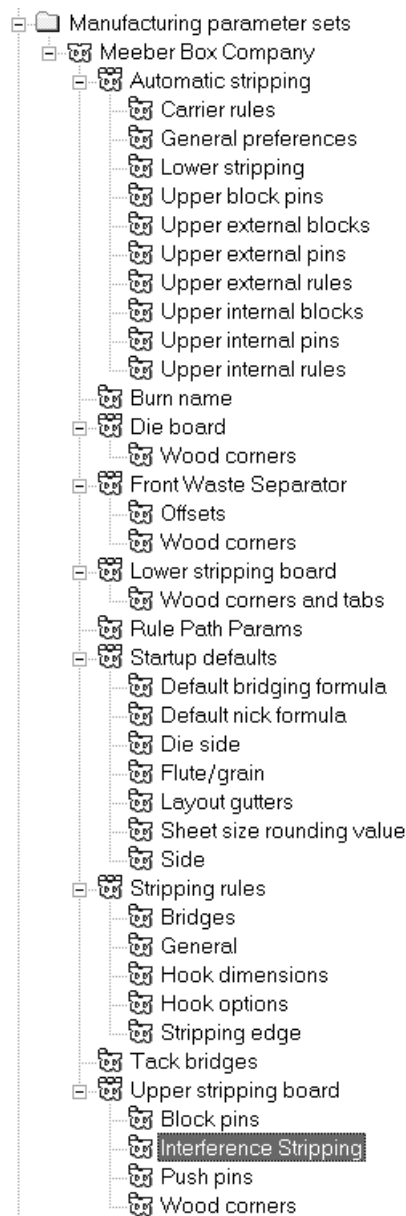

3. Click **OK** in each parameter’s dialog box to save the changes.
4. Click **File**, click **Save** to save the changes, and then click **Yes** to overwrite previous Defaults.

Note: Changing the default die press parameter set and default printing press parameter set has no effect when choosing a manufacturing parameter set. To change the die press and printing press parameter sets used by a manufacturing parameter set, change the manufacturing parameter set itself, and not the default die press and printing press selections.

Counter parameter sets

As with single design and manufacturing parameter sets, Counter parameter sets group counter parameters together for easy manipulation. You can copy a parameter set and modify

it to meet your unique needs, or you can create a new parameter set by right-clicking and selecting **New** on the context menu.

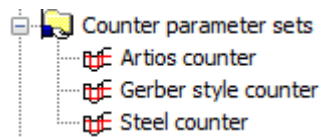

Double-click a parameter set to open it for editing.

Tool Angles, Widths tab

Shown below is **Tool Angles, Width** tab of the **Artios counter** parameter set for phenolic resin (plastic) counters and the **Steel counter** parameter set for steel counters. The **Type of counter** selection controls the options ArtiosCAD shows on the tabs across the parameter set.

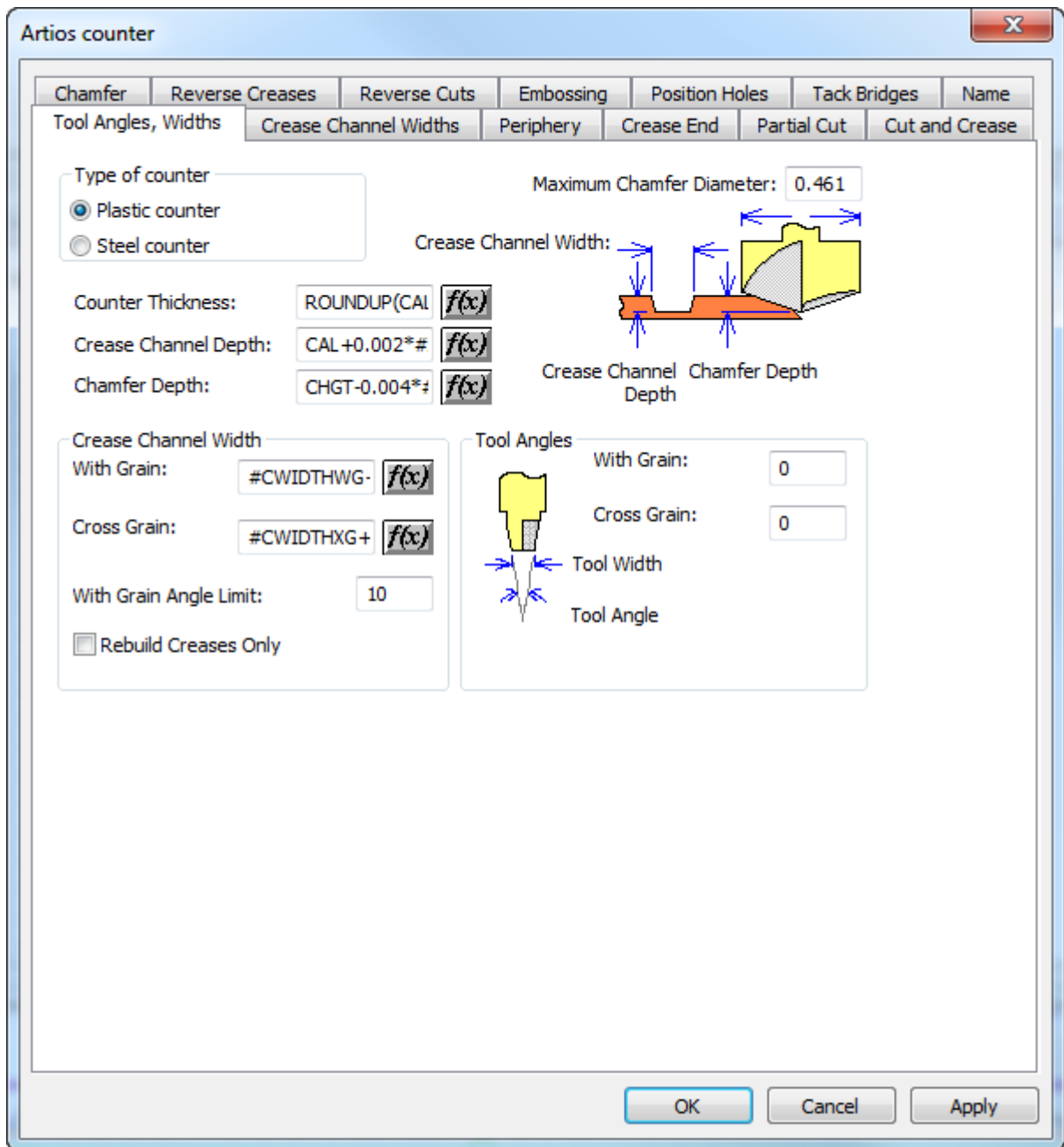

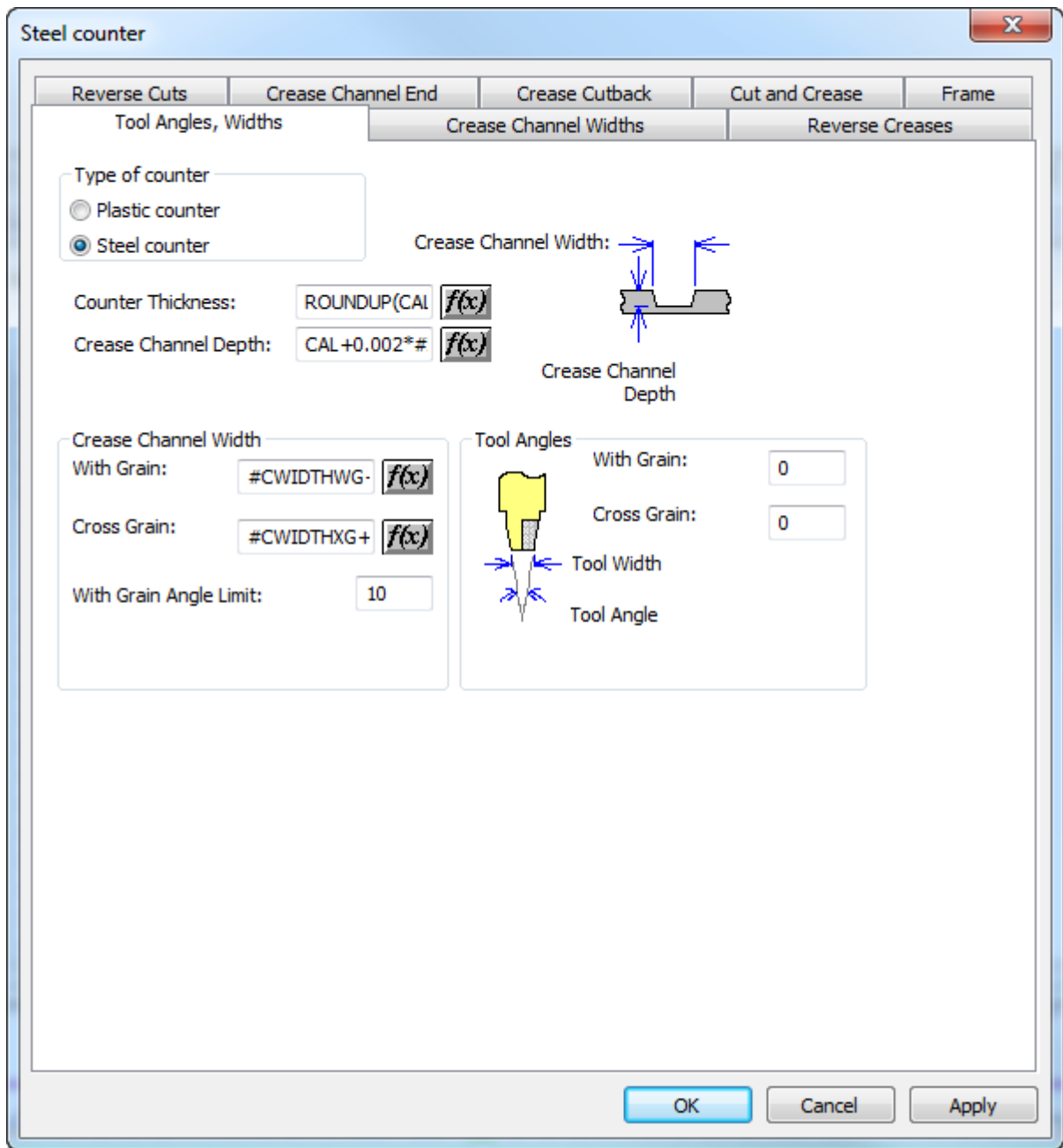

Fields followed by **f(x)** indicate that the parameter being set is dependent on the board. Clicking **f(x)** leads to the Edit Expression dialog box, where the following parameters should be used to build expressions:

- #CWIDTHWG Width of with grain creases
- #CWIDTHXG Width of cross grain creases
- CAL Board caliper

The parameters for counters are configured like this:

Description	Workspace Variable	Default Expression	Notes
Counter thickness	CHGT	ROUNDUP(CAL+0.007*#I, 0.002*#I)	Affects the periphery and chamfer tool offset.
Crease channel depth	CRECHD	CAL+0.002*#I	For information only. Does not affect tool paths.
Chamfer depth (plastic counters only)	CHAMFD	CHGT-0.004*#I	Automatically limited by maximum chamfer width.
With grain channel width	CHWWG	#CWIDTHWG+2*CAL	
Cross grain channel width	CHWXG	#CWIDTHXG+2*CAL+0.004*#I	

The **Maximum Chamfer Diameter** is usually the diameter of the chamfer tool head.

Periphery tab

The **Periphery** tab of the counter parameter set dialog box contains settings which affect the periphery tool. This tab only appears for plastic counters.

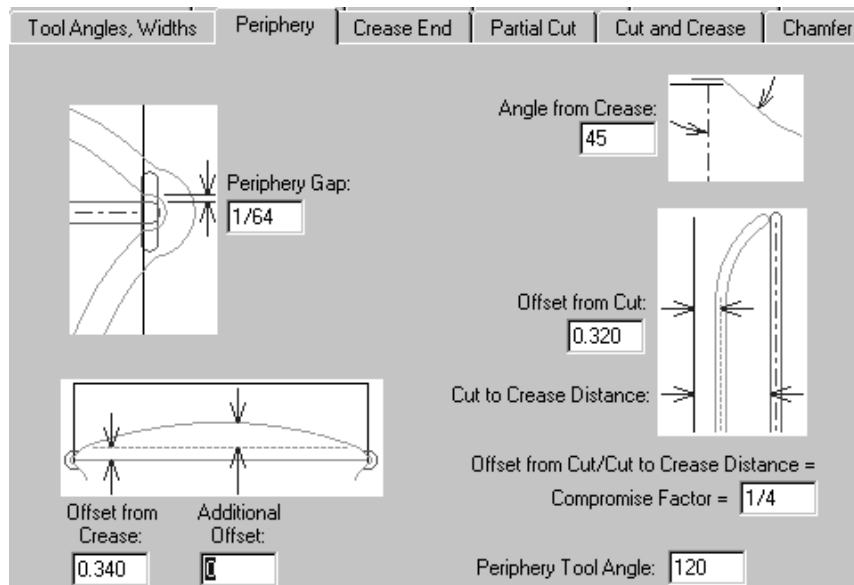

The parameters on this page of the dialog box are all measurements whose functions are illustrated in the pictures next to them except for the Periphery Tool Angle. The angle specified

in the **Periphery Tool Angle** field, along with the thickness of the counter material, determines the width of the periphery.

Crease End tab

The **Crease End** tab of the counter parameter set dialog box controls how the crease ends are machined. This tab only appears for plastic counters.

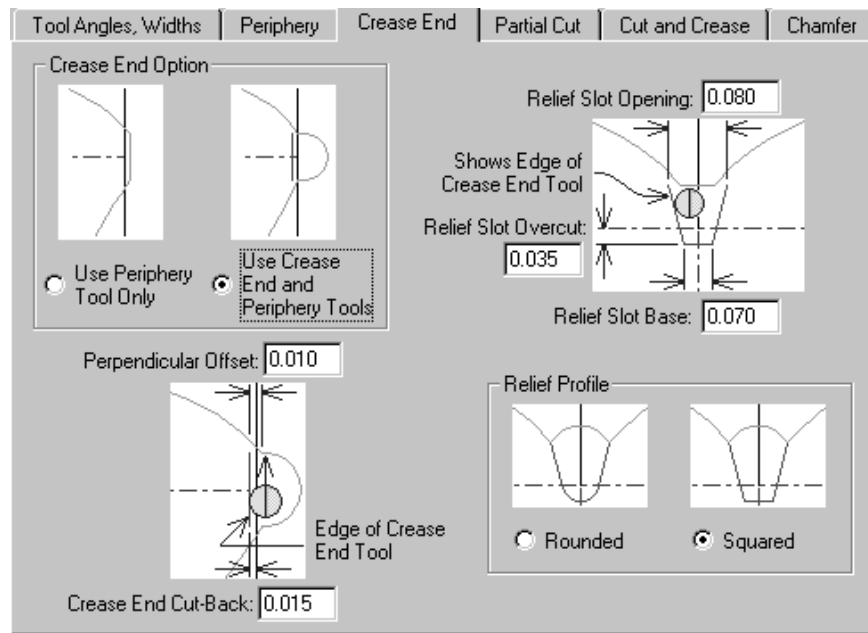

The options in the **Crease End Option** group, **Use Periphery Tool Only** and **Use Crease End and Periphery Tools** affect the display of the rest of the tab. If **Use Periphery Tool Only** is selected, all the pictures change to omit any reference to the Crease End tool's existence.

Partial cut tab

Partial cuts and glue assist lines can have the counter extend underneath them if you so desire. This tab appears only for plastic counters.

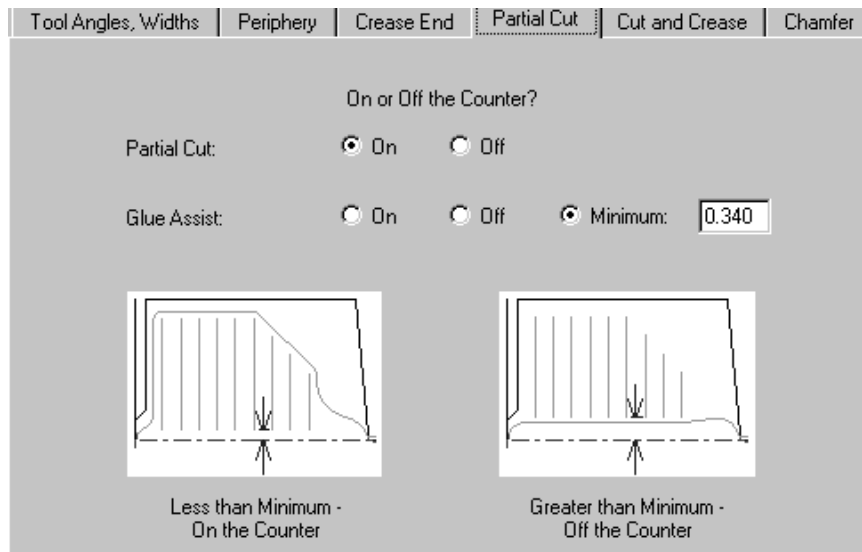

By default, Partial Cuts are set to be **On** the counter. Glue assist lines are set conditionally by default. They are off the counter if the distance between the crease and the closer end of the line is greater than the minimum specified in the **Minimum** field. Of course you can specify them to be **On** or **Off** all the time.

Cut and Crease tab

For plastic counters, the options on the **Cut and Crease** tab affect the creation of bowties, which are special constructs made necessary by having cuts and creases of such short length. All of the options are explained in the pictures.

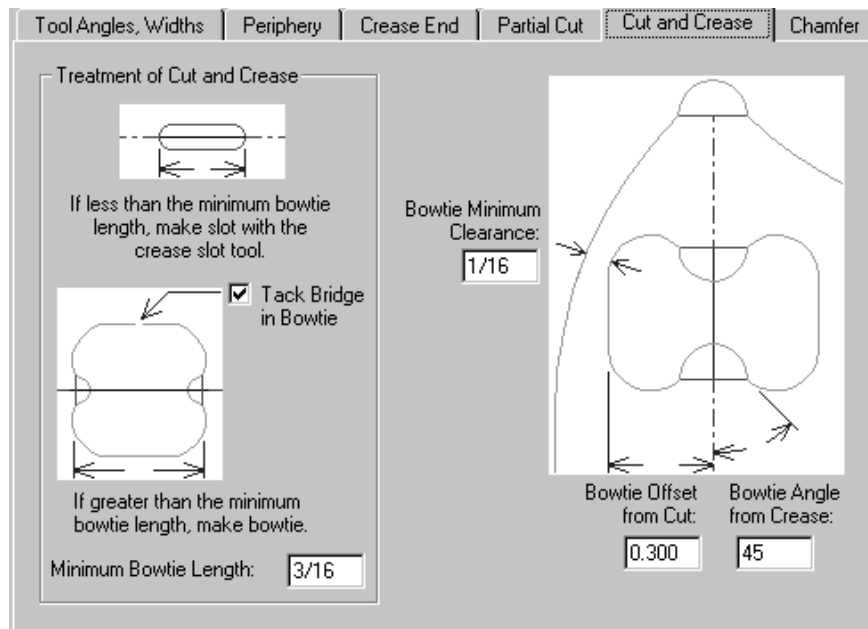

For steel counters, ArtiosCAD offers the following choices on the Cut and Crease tab:

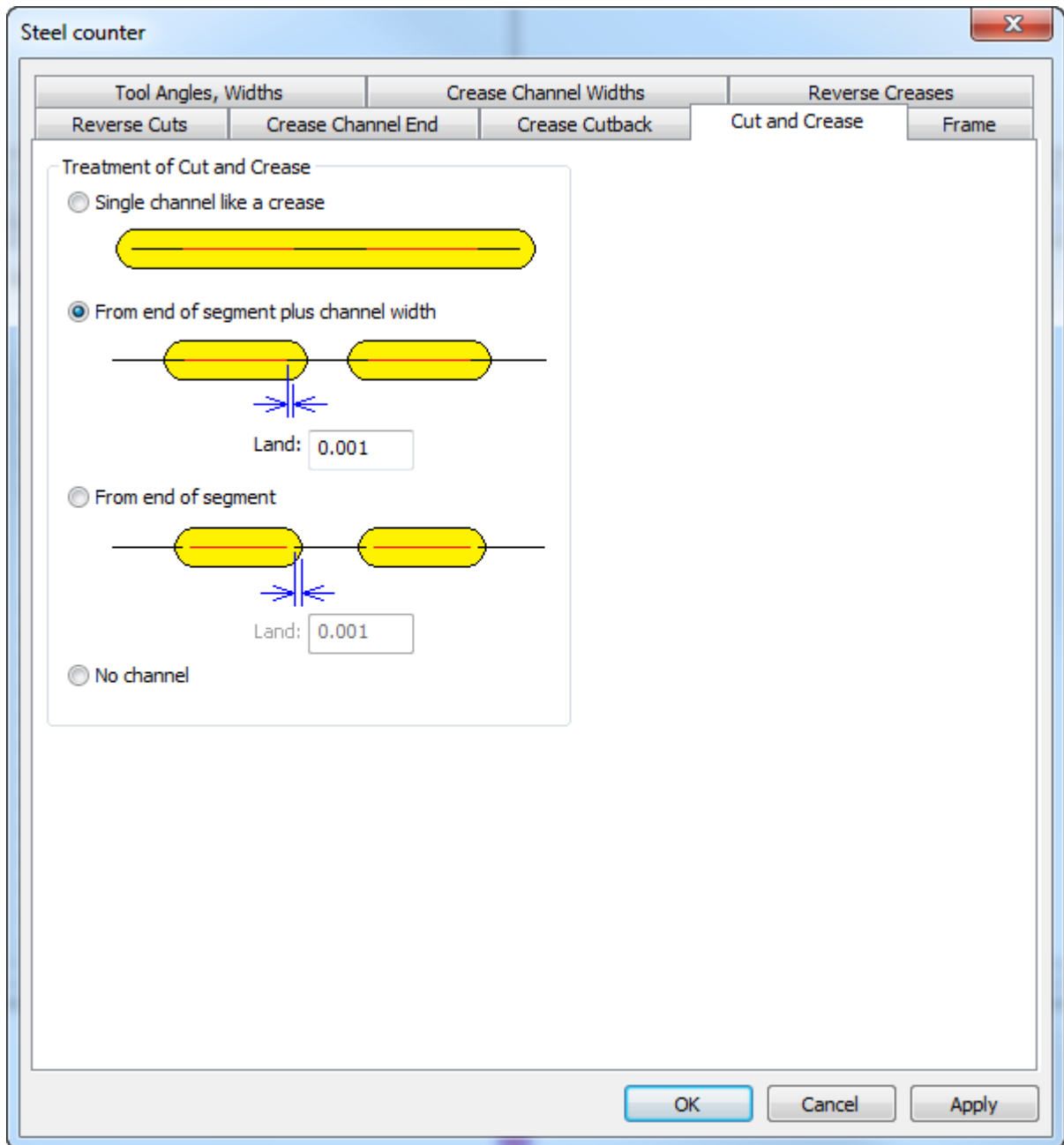

- **Single channel like a crease**, which makes one long channel
- **From end of segment plus channel width**
- **From end of segment**
- **No channel**

For separate channels, ArtiosCAD can measure the land from the end of the line or the edge of the channel. ArtiosCAD sets the land at both ends of a cut-crease line the same way as a normal crease.

Chamfer tab

The options on the **Chamfer** tab affect the counter at those places in the design where cut lines and the ends of crease lines meet. The chamfer mostly follows the periphery except it always stays a specified distance away from crease channels. This tab only appears for plastic counters.

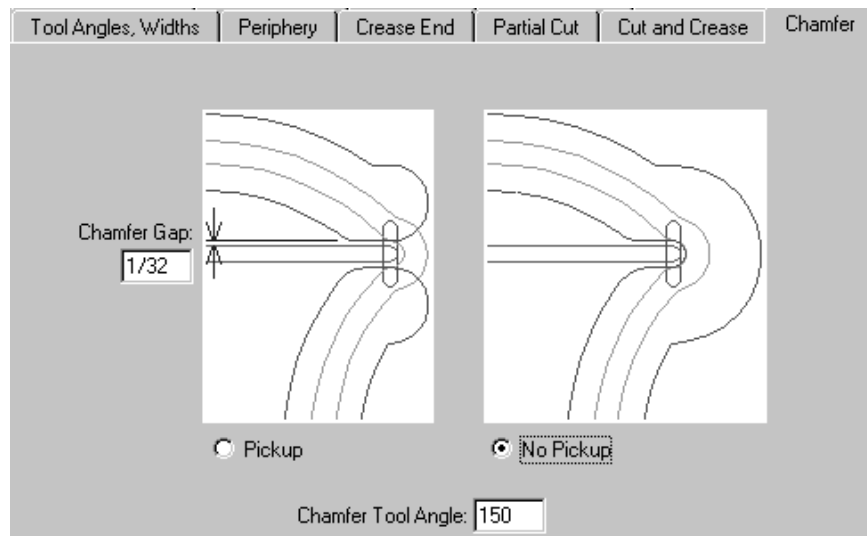

The **Chamfer Gap** is the distance between the inside edge of a chamfer and the crease channel. The **Pickup** and **No Pickup** options control whether the chamfer is continuous around the end of the crease channel. The **Chamfer Tool Angle** is the angle of the tool, which, together with the thickness of the counter material, determines the width of the chamfer channel.

Reverse Creases tab

Reverse creases are used to make a panel fold outward instead of inward.

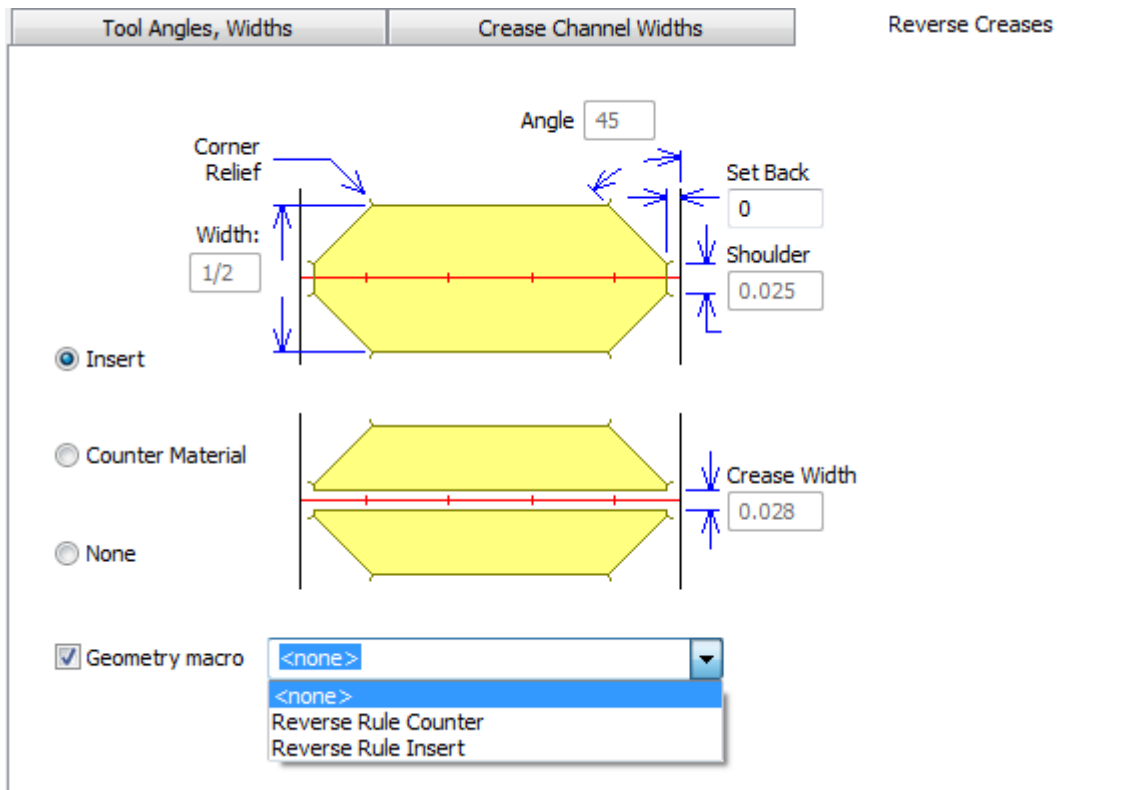

The **Insert** option indicates that a piece of foreign material will be attached to the counter to create the reverse crease. This is shown in the top picture on the tab. **Counter material** means that an area around the reverse crease will be milled out so that the board gets pushed into the depressed area. This is shown in the bottom picture on the tab. The **Crease Width** field becomes available when this option is selected. **Off the counter** disables all the fields.

Geometry macro is available only for steel counters and lets you choose a geometry macro from the Steel Counters geometry macro catalog. Should you choose to create your own geometry macro, use these guidelines:

- make the horizontal outline of a milling area using line type **Counter mill outline**
- make it rebuildable with a variable length using **L** for the variable

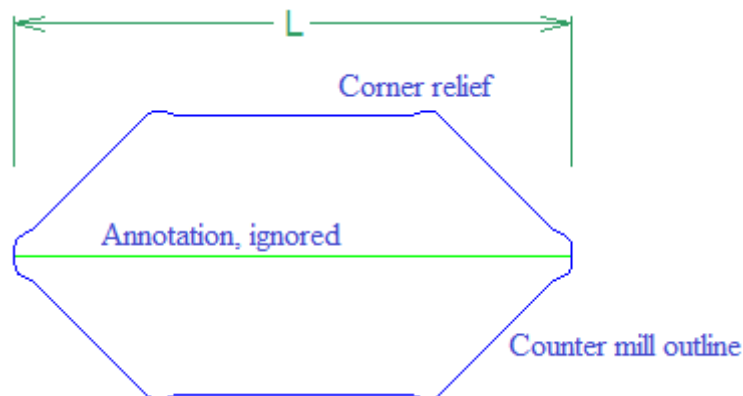

- add the geometry macro to the catalog with **Steel counter reverse rule** as the placement option
- for an insert, design it with corner relief so that the insert can be easily placed and removed
- for counter material, the macro should make one side.

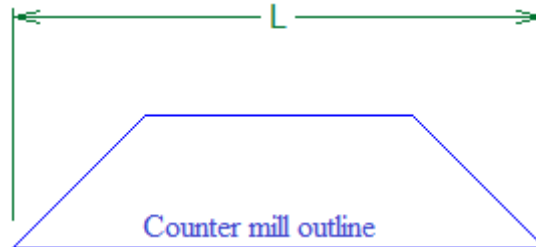

Note: ArtiosCAD treats curved reverse creases and reverse cuts like straight lines. You will need to manually edit these areas.

Reverse Cuts tab

Reverse cuts are made on the counter in the same way as the Insert method for reverse creases. The parameters on the **Reverse Cuts** tab are explained in the picture.

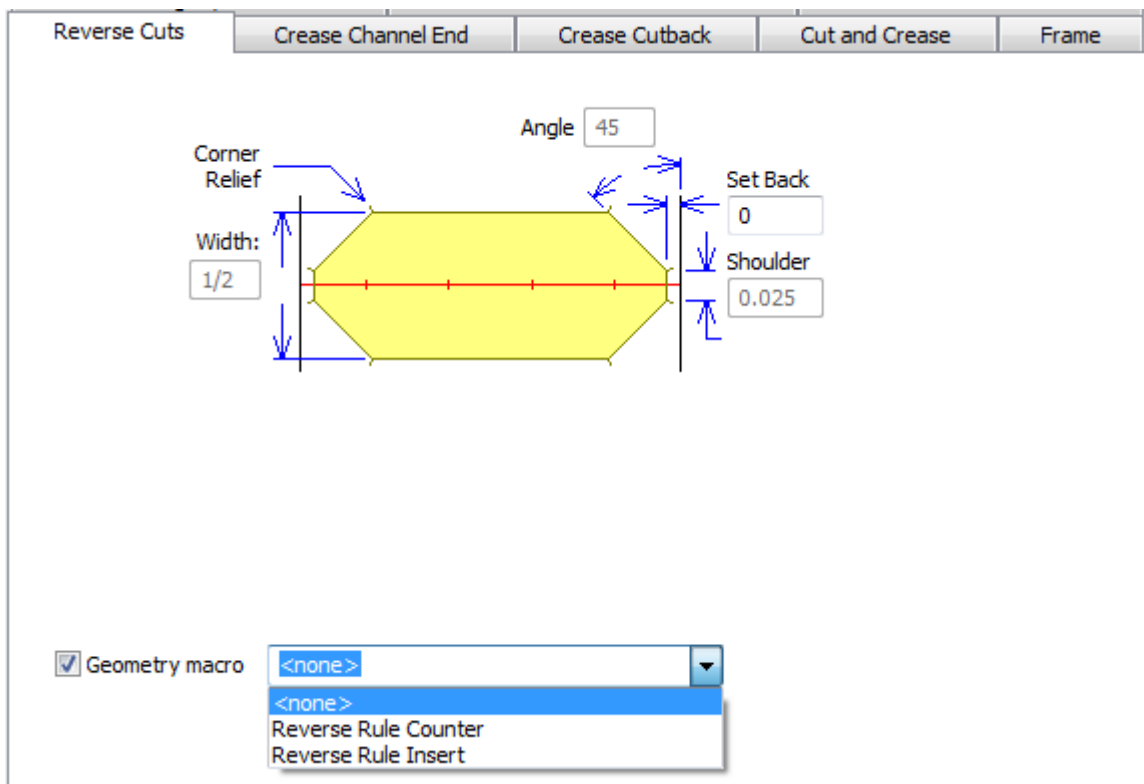

As with the Reverse Creases tab, **Geometry macro** appears only for steel counters. When you enable a geometry macro, all the fields on the tab become unavailable except for **Set Back**.

Follow the same guidelines for using geometry macros as explained in the Reverse Creases tab section.

Crease Channel Ends tab

The fields on the Crease Channel End tab control the shape of the crease channel ends, the length of the crease channel cutback, what happens when creases meet, and the minimum length of a crease channel. This tab appears only for steel counters.

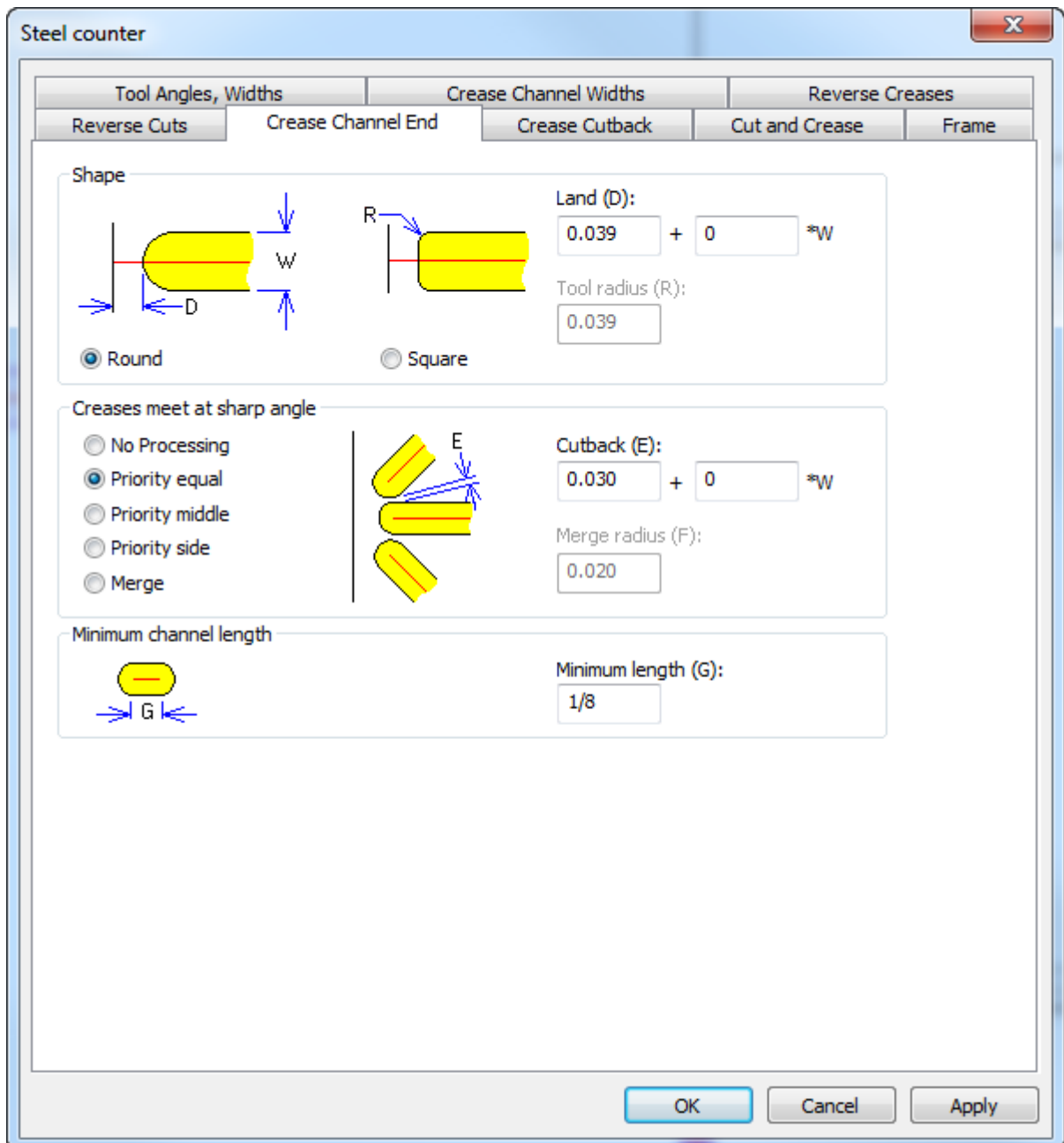

In the Shape group, choose either **Round** or **Square**. **Land** (the distance between the actual end of the channel and a line meeting it) is available for both round and square shapes, but

Tool radius is only available when using a square tool. Make sure this is accurate so that ArtiosCAD can correctly calculate the land.

In the Creases meet at sharp angle group, the picture changes depending on which option you select. **No Processing** lets the channels overlap and is sufficient for most designs. The **Priority** choices keep channels that meet from overlapping by shortening them in different ways.

- **Priority equal:** channels shortened by the same amount so they do not cross
- **Priority middle:** channels shortened so they do not cross, with the middle channel left closest to the original length
- **Priority side:** channels shortened so they do not cross, with the side channels left closest to the original length

If only two creases meet, the crease closer to horizontal/vertical is considered the middle crease. When four or more creases meet, ArtiosCAD sets the priority of the three closest creases and shortens the remainder as needed so they do not cross; use the **Shorten Creases** tool to make manual adjustments.

Merge merges them together to avoid sharp corners using the **Merge radius** for the inside corners. For this to work properly, the milling tool diameter needs to be smaller than the channel width.

Use **Minimum length** to set the smallest allowable channel length.

Embossing tab

An area of the board can be embossed by milling out the part of the counter surrounding the embossed area. This tab only appears for plastic counters. Embossing works differently for steel counters and is not defined by the parameter set. As with other tabs, the parameters on the **Embossing** tab are explained in the picture.

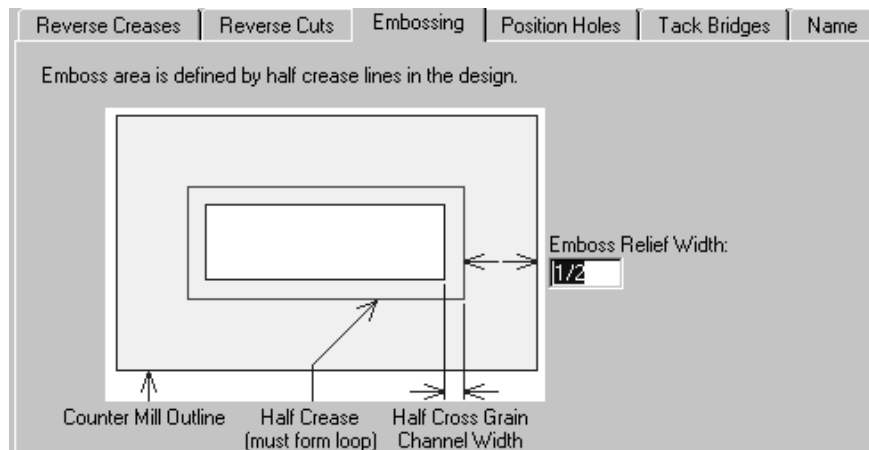

Position Holes tab

The **Position Holes** tab contains one parameter - the workspace name for the position hole. This tab appears only for plastic counters. Click **Specify** to browse for a new workspace.

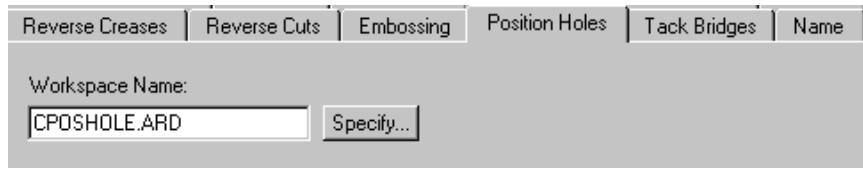

Tack Bridges tab

The **Tack Bridge Width** field on the **Tack Bridges** tab sets the width of tack bridges in the periphery of the counter. This tab is available only for plastic counters.

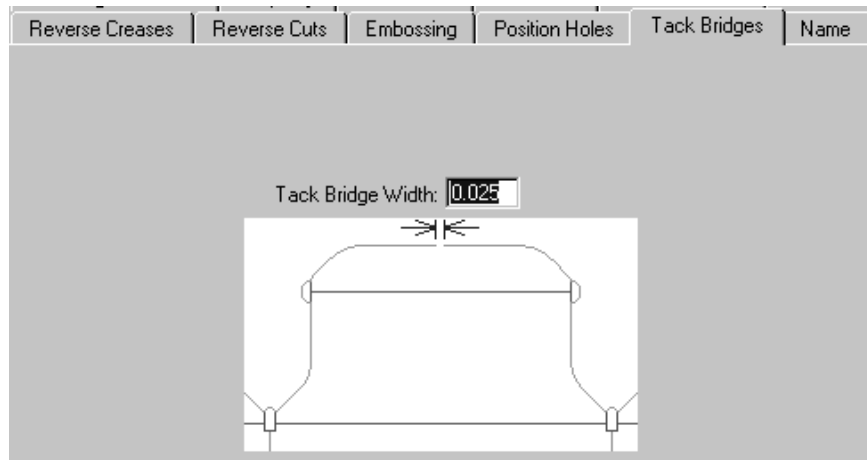

Name tab

The choices on the **Name** tab affect the output of the Name tool on the Counter toolbar. This tab appears only for plastic counters. These choices include the font to use, its size, and its position, as shown in the picture.

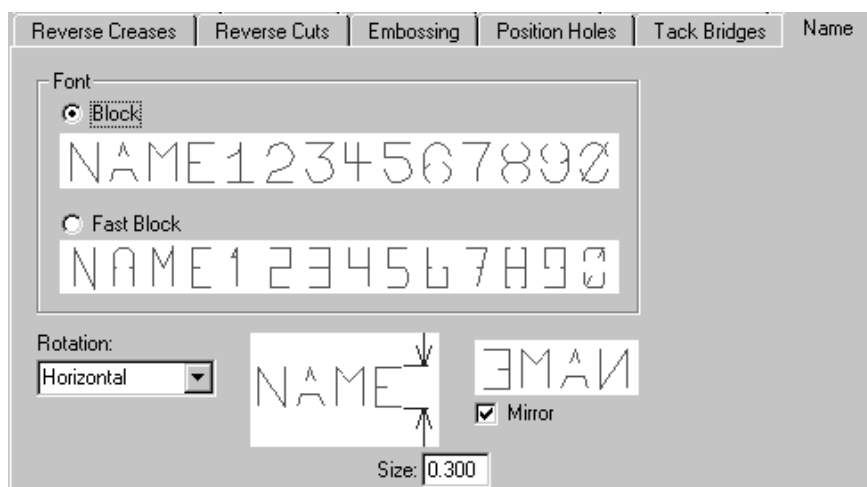

Blanking Parameter Sets

Blanking machine parameter sets control how ArtiosCAD constructs the blanking tooling per machine. In this way, ArtiosCAD can easily create the right size tooling for machines of different sizes. The values set in these parameter sets are for:

- Frames
- Lower blanker board wood alignment
- Non-stop swords
- Photocells
- Pressers
- Tie-bolt holes
- Upper blanker board requirements and wood alignment

If you use BSI frame kits, specify the one to use in the Frame catalog as described further in this section.

For information about configuring the various options, please refer to the Blanking section in the *Manufacturing* chapter.

Blanking parameter sets control how ArtiosCAD constructs the blanking tooling for different types of blanking solutions for any machine. The idea is that you first choose the machine (which will then set the sizes and tolerances from the blanking machine parameter set) and then the kind of blanking solution you will be using on that machine (defined by the blanking parameter set). The values set in these parameter sets are for:

- Blank holes
- Frame clearance, construction, and size
- Grid
- Lower blanker board allowances and wood corners
- Non-stop swords
- Pusher details
- Pusher edge
- Tool controls
- Upper blanker board allowances and wood corners

Changes from previous versions include:

- In a Blanking machine parameter set, in the Frame dialog box, **Min to Inner** and **Max to Inner** now match those from BSI software.
- The BSI Flat top blanking parameter set uses the support rail corresponding to the machine and the BSI 5mm Adhesive Runner (A02019). Other parameter sets use a non-component support rail specified by a width.

Defining a BSI Blanking Frame Kit

If you are using a BSI blanking frame kit with your set of blanking tools, you specify its parts in the blanking machine parameter set for the press and its usage in the blanking parameter set.

1. Start ArtiosCAD and click **Options > Defaults**.
2. Open the **Blanking machine parameter sets** catalog.
3. Open an existing parameter set or create a new one.

4. Double-click **Frame** to open the Frame dialog box.

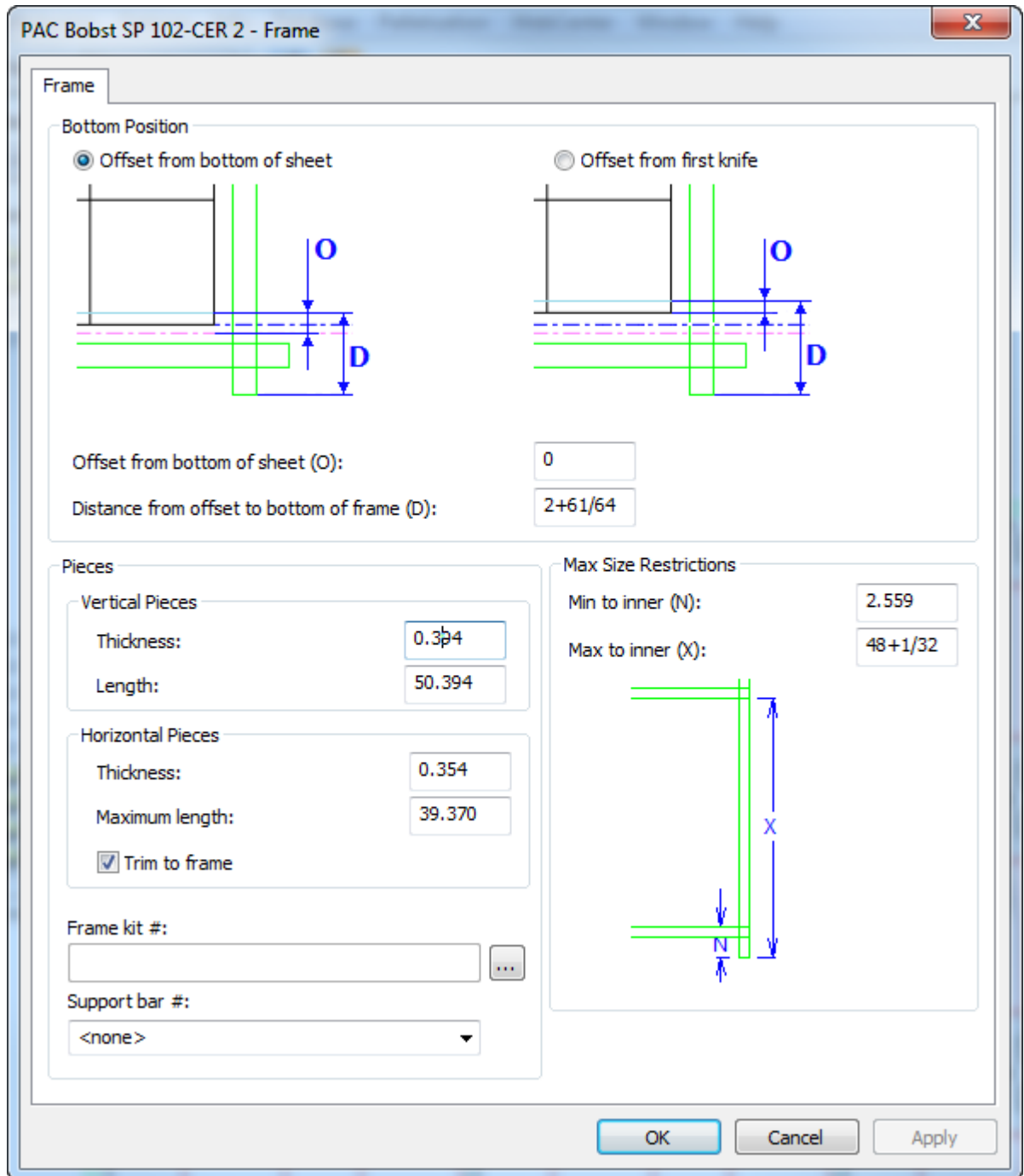

5. Click More Options (...) at the end of the Frame kit # field. This opens an empty Frame Kit Definition dialog box.

6. Enter the frame kit number in the Frame kit # field.
7. For the rails, corner, and centerline device, choose the BSI part from the drop-down list box.

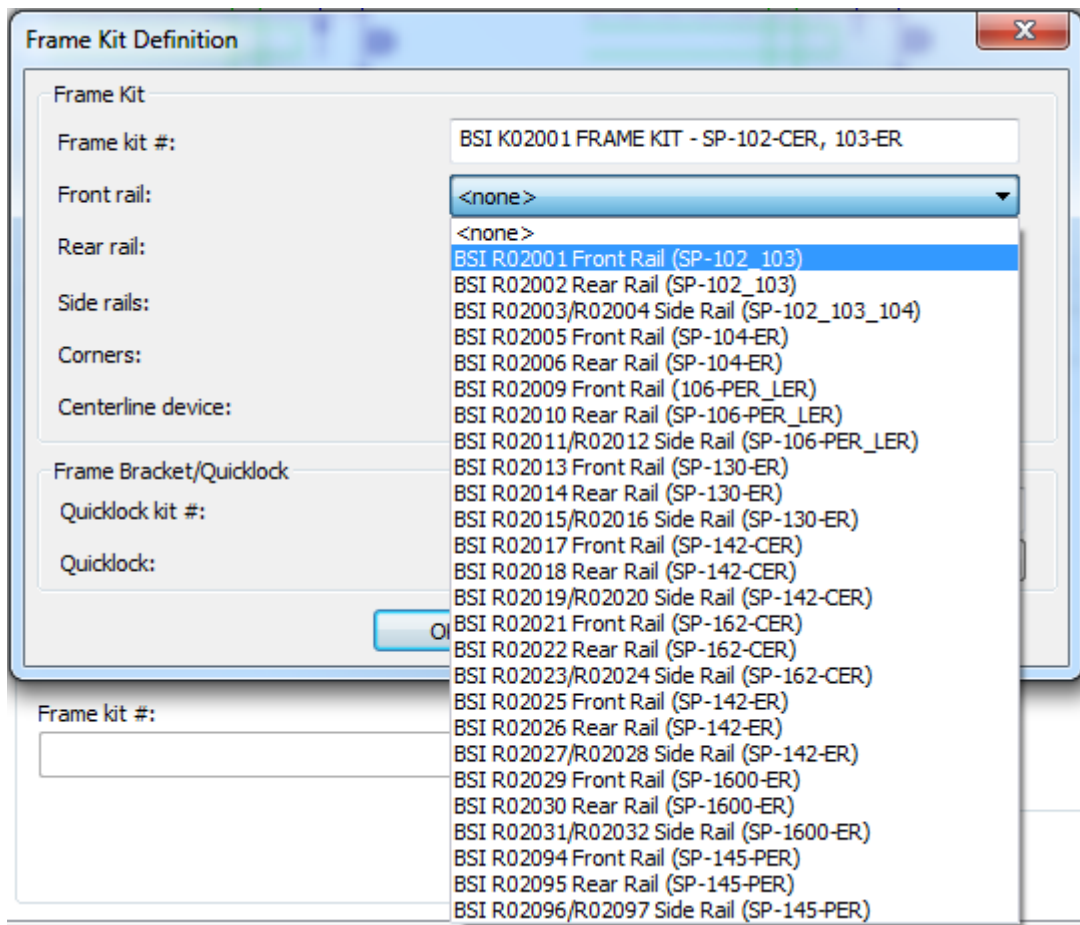

8. Enter the Quicklock kit number in the Quicklock kit # field.
9. Choose the Quicklock part from the **Quicklock** drop-down list box.
10. Click **OK** to save the frame kit definition.
11. Choose the support bar number to use with this frame from the **Support bar #** drop-down list box.
12. Click **OK** to save the change to the blanking machine parameter set and return to Defaults.
13. Open the **Blanking parameter sets** catalog.
14. Open an existing blanking parameter set or create a new one.
15. Open its Frame catalog and double-click **Frame Construction** to open the Frame Construction dialog box.

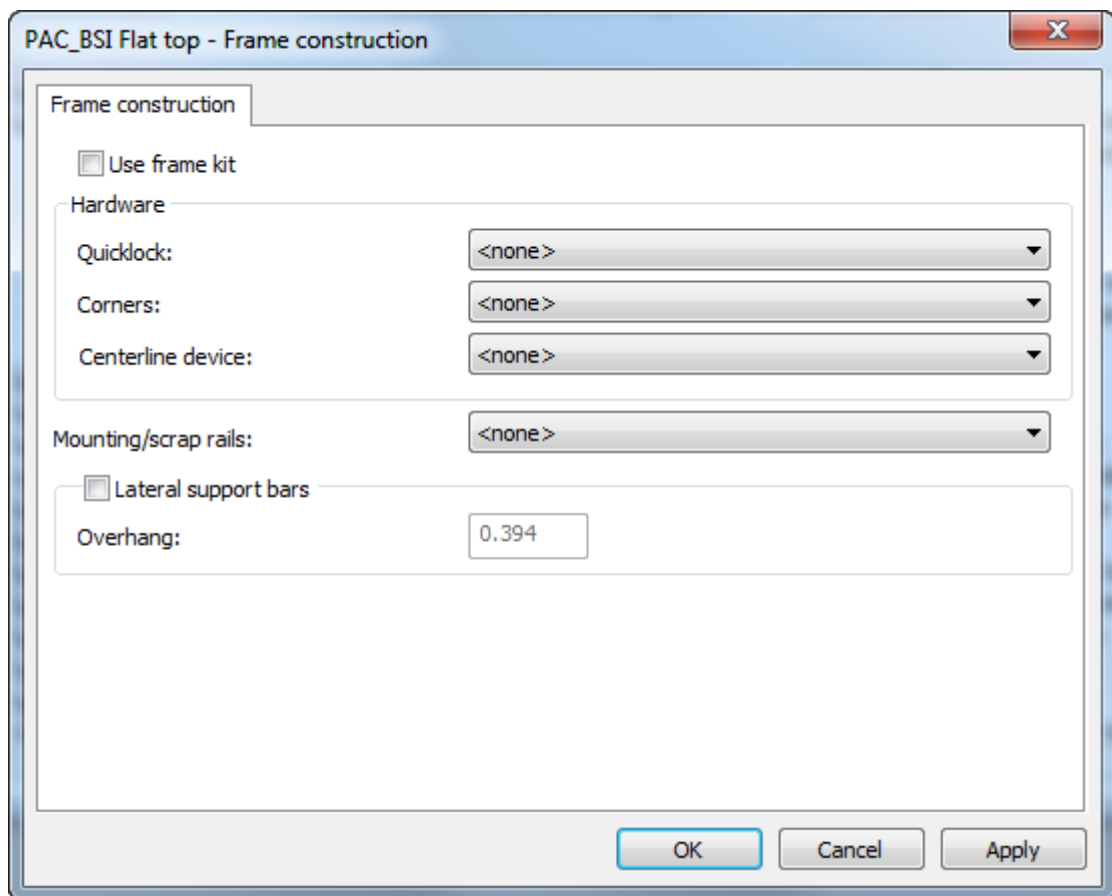

16. Check **Use frame kit**, which will make the options in the Hardware group unavailable.
17. Choose an option in the **Mounting/scrap rails** drop-down list box and check **Lateral support bars** if your tooling will use them.

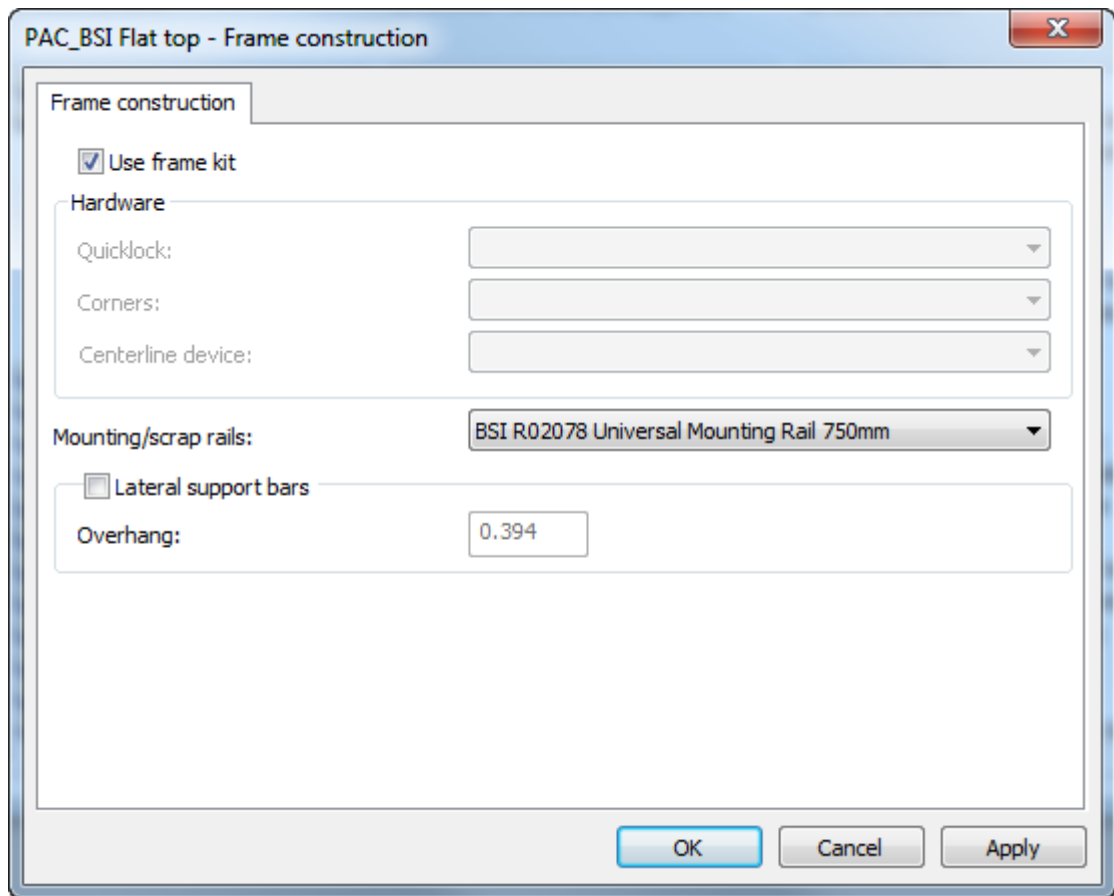

- 18. Click **OK** to return to Defaults.
- 19. Save and exit Defaults normally.

When you choose this blanking machine and blanking parameter set when using the blanking tooling creation tools, ArtiosCAD will construct the parts according to the BSI frame kit parts you specified.

Rubber types

ArtiosCAD has a default Rubber types catalog. Review its entries and modify or add to them as necessary to meet your needs.

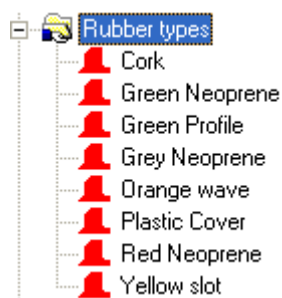

A rubber type is defined by its unique name, thickness, and stock sheet size. If there are rubber types defined that are different thicknesses of the same material, include the thickness in the name, as each name must be unique.

To edit a rubber type, double-click its name. To create a new rubber type, right-click the Rubber types catalog and click **New > Data** on the context menu.

Shown below are the properties for the Red Neoprene rubber type.

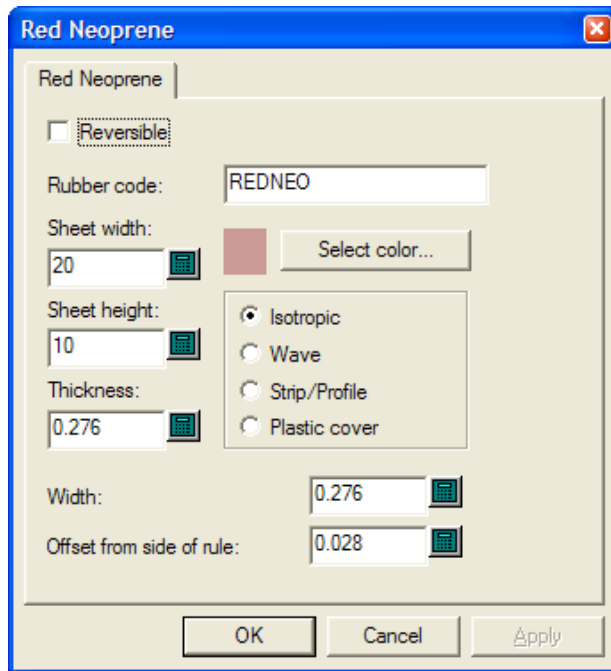

Reversible indicates if the top and bottom sides of the rubber are the same, so that a piece of rubber and its mirror image could be considered the same when making layouts. (This is different from the mirror options in Auto-Repeat.)

The value in the **Rubber code**: field is what is used on the Sheet Filename Generation page of the rubber sheets Output. Use letter and numbers only with no spaces.

Set the **Sheet width**: and **Sheet height**: fields to the appropriate sizes of the sheets for this type of rubber.

The **Thickness**: field is currently unused, but to prepare for its possible use in the future, enter the thickness of the sheet.

Select color sets the color of the rubber when **Rubber Fill** is selected in the Rubber View Options dialog box. Clicking it opens a color palette.

The four option buttons set the type of the rubber.

- **Isotropic** means it is the same in all directions, so can be rotated as necessary.
- **Wave** means it is rippled, and the long dimension of the rubber must cross the ripples. This type of rubber is generally used in long, narrow slots. Wave rubber pieces are put on the sheet with their longest dimension horizontally regardless of the state of **Fill from left**.

- **Strip/Profile** means that it is premanufactured rubber that is not calculated for layouts, but can be drawn on the dieboard so that it can be placed correctly after manually being cut.
- **Plastic cover** causes ArtiosCAD to nest the pieces of the plastic cover (if one is used) as if they were rubber.

Width is the width of the rubber when it is cut.

Offset from side of rule is the distance from the edge of the rule to the edge of the rubber which allows for pointage.

Once you have finished modifying an existing rubber type or creating a new one, click **OK** to return to Defaults, and then click **File > Save** to save the changes.

Rubber parameter sets

As with single design and manufacturing parameter sets, rubber parameter sets group rubber parameters together for easy manipulation. We recommend copying the **RubParamExample** parameter set and modifying it to meet your needs, but you can create a new empty parameter set by right-clicking **Rubber parameter sets** and selecting **New > Data** on the context menu.

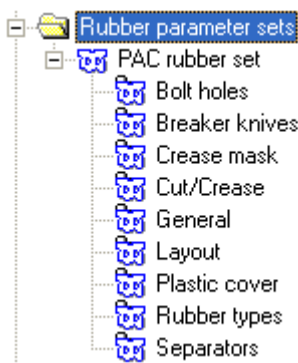

Bolt holes

After the rubber is made, it needs to be trimmed to allow for bolt holes, but because of the placement of the holes, the trimming may affect how pieces are auto-repeated. Therefore, this dialog box controls whether the trimming is automatic or not by the state of **Subtract bolt holes**. If bolt holes are not automatically subtracted from the rubber, the Subtract Bolt Holes tool allows for manual trimming after the rubber is created.

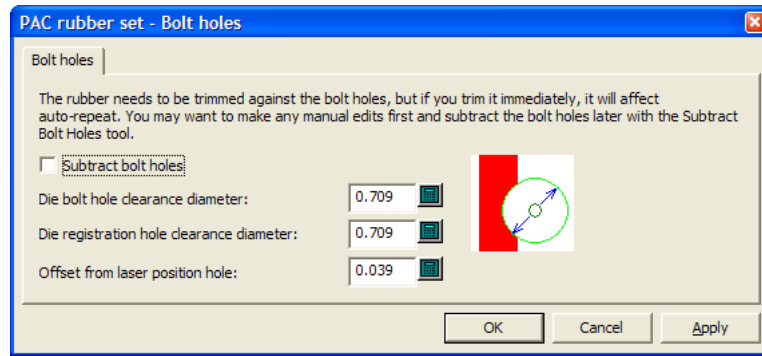

The rest of the fields in the dialog box determine how much rubber will be trimmed.

If the hole in the dieboard is almost circular and less or equal to the specified size, a circular hole of the specified size will be made in the rubber. If not, the hole in the dieboard will be copied into the rubber.

Laser position holes can be made using lines of linetype **Laser position hole** or **Unknifed diecut**. They can be triangular, square, hexagonal, octagonal, must be a reasonable size of less than 16mm, and fit around a circular pin. If a laser position hole is recognized, the hole in the rubber will be offset by the specified offset. If the laser position hole is not recognized, the hole will be copied without an offset.

Click **OK** when done to return to Defaults.

Breaker knives

Breaker knives are also known as stripping rules. When used in Rubbering, they are the stripping rules on the outside of the die. Sometimes they are rubbered to prevent injury to the people handling the dieboard. The options in the Breaker Knives section of the parameter set control how far the rubber extends past the sheet edge. Choose the desired option button and click **OK** to return to Defaults.

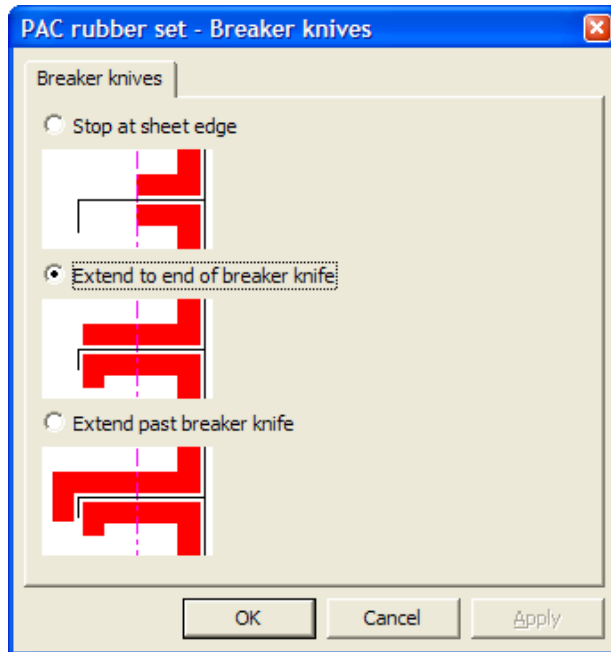

Crease Mask

The options in the Crease Mask section of the parameter set control how the rubber is cut back near creases.

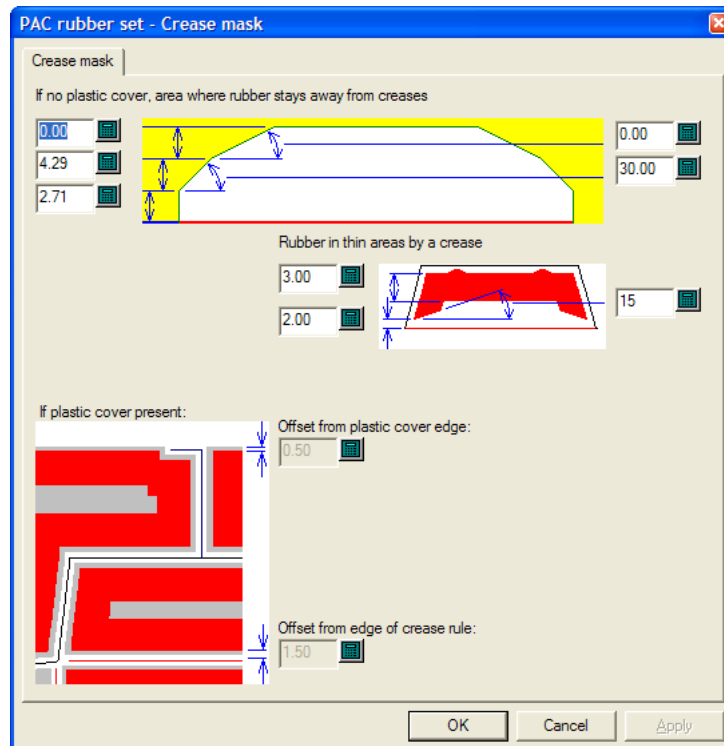

The options in this dialog box are made available or unavailable by the state of **Make Plastic Cover** in the General section of the parameter set. When that option is not selected, the controls in the bottom half of this dialog box are unavailable, and when it is selected, the controls in the top half are unavailable.

For normal areas of the design, the options along the left side of the top quarter of the dialog box are the distance that is cut back from the crease, and the values on the right side are the angles at which the cuts are made. Each end of the cutback is the same as it is symmetrical.

For thin areas of the design, the rubber pieces are smaller so there are fewer cutbacks.

When a plastic cover is used, set the offsets from the plastic cover edge and from the edge of the crease rule as desired.

Click **OK** when done to return to Defaults.

Cut/Crease

ArtiosCAD can treat cut/crease rules as if they were cuts, or creases, or a mixture of the two. They need to have different parameters than the standard crease mask so that the angle of the cutbacks can be greater, so these are set in the Cut/Crease section of the parameter set. Also, rubber pieces for cut/crease rule are made thicker (to the thickness you specify in this dialog box) so they do not break at the thin points.

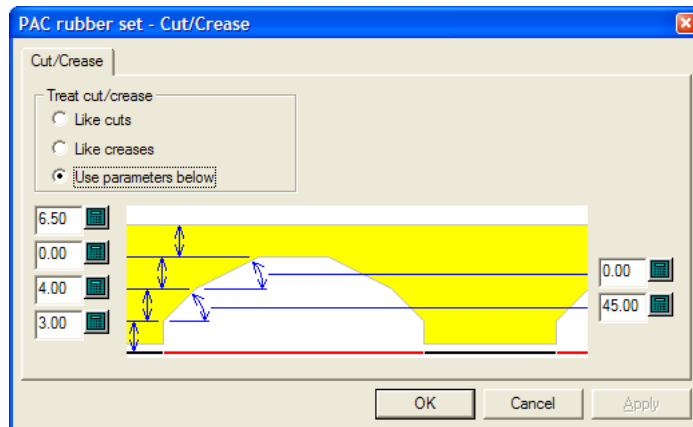

In the **Treat cut/crease** group, **Like cuts**, **Like creases**, and **Use parameters below** all behave as their names imply. **Use parameters below** enables the distance and angle fields for the crease cutback.

Click **OK** when done to return to Defaults.

General

The General section of the parameter set contains settings that affect the overall creation of the rubber.

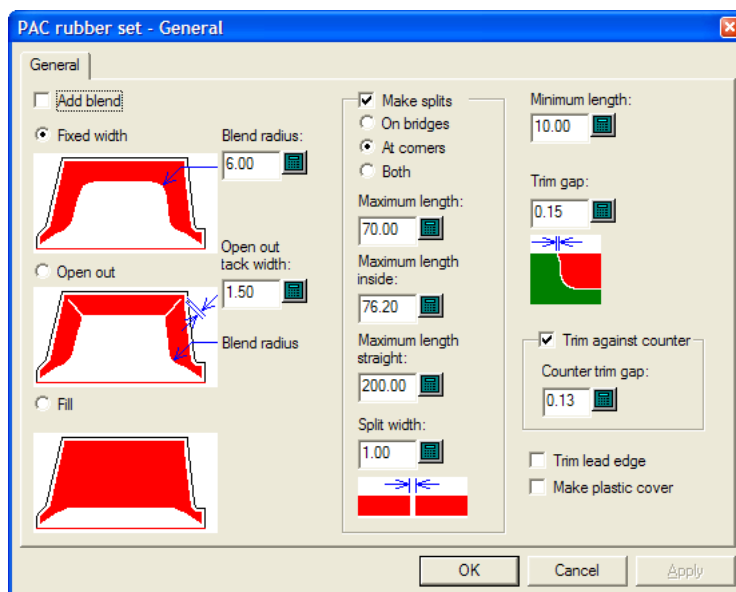

Add blend causes the Rubber Area, Add Rubber, and Subtract Rubber tools to add blends to the rubber of the size specified in the **Blend radius:** field.

Fixed width, **Open out**, and **Fill** set the style of rubber ArtiosCAD makes.

The **Open out tack width:** sets the width of the connecting piece of rubber left at the end of an open-out.

In the **Make splits** group, the title control determines if ArtiosCAD limits the length of pieces of rubber or splits them. The default is to split them. This option also controls if ArtiosCAD creates pseudo temporary stripping rules to break up large pieces of rubber for easier manufacture.

- If they are split **on bridges**, there is better airflow and less suction. If they are split **at corners**, they nest better and are easier to replace when worn out. **Both** creates splits at both locations.
- **Maximum length:** sets the largest size allowed for pieces of rubber placed outside the designs.
- **Maximum length inside:** sets the largest size allowed for pieces of rubber placed inside the designs.
- **Maximum length straight:** is a separate length for straight pieces, and should be set to longer than the **Maximum length:** value as straight pieces nest better.
- **Split width:** sets the size of automatically-created splits and also sets the default value for the Add Split tool.

Minimum length: sets the value at which small pieces of rubber are merged with longer adjacent pieces.

The **Trim gap:** field sets the size of the gap when two pieces of differing-types of rubber overlap. It can be as small as 0.001 inch or 0.05mm, but set this to a value larger than 0 so that the Adjust Outline tools can work with each piece individually.

Trim against counter controls whether the rubber is trimmed against the counter (if one is defined) and if so, the gap is set in the **Counter trim gap:** field. If this option is not selected, the rubber can be trimmed later with the Trim Rubber tool.

Trim lead edge, when selected, makes it so that no rubber goes lower than the lead edge.

Make plastic cover, when selected, causes a plastic cover to be made in its own layer when the Rubber Area tool is used.

Click **OK** when done to return to Defaults.

Layout

If you have the Rubber Design and Layout option, ArtiosCAD can automatically group pieces of rubber on the sheets based on their shapes.

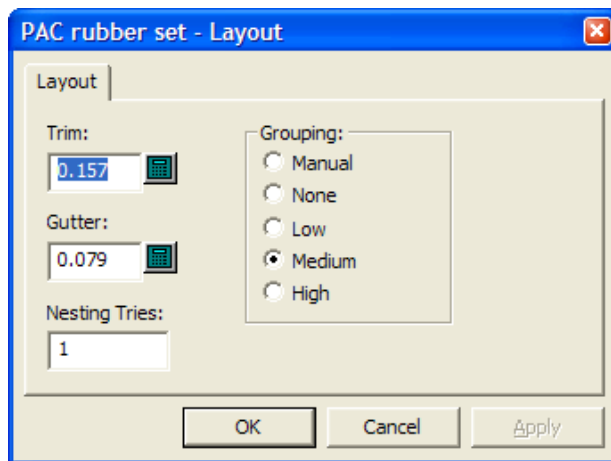

Trim is the distance from the edge of the rubber sheet to the edges of the rubber elements, and **Gutter** is the distance between each rubber element.

Increasing the value in the **Nesting tries:** field causes ArtiosCAD to try more nests, but this takes more time.

The five choices in the **Grouping** group control how the instances of each rubber element are grouped together on the sheets. **Manual** means that the grouping will be taken from the values set in the List Rubber Elements dialog box. **None** means that each item will be considered its own group. **Low** means only straight items will be grouped together. **Medium** will do an intermediate level of grouping, but **High** will group together as many instances of the element as possible. These controls are meant to let you find the balance between making pieces easy to find and wasting the least rubber.

Click **OK** when done to return to Defaults.

Plastic cover

Some diemakers glue a plastic cover on top of the pieces of rubber to keep the board from sticking to the rubber as the press operates. The plastic cover pieces are supported by pieces of rubber on all sides, including along creases. The plastic cover extends slightly past the pieces of rubber underneath. Plastic cover pieces are not generated for slots.

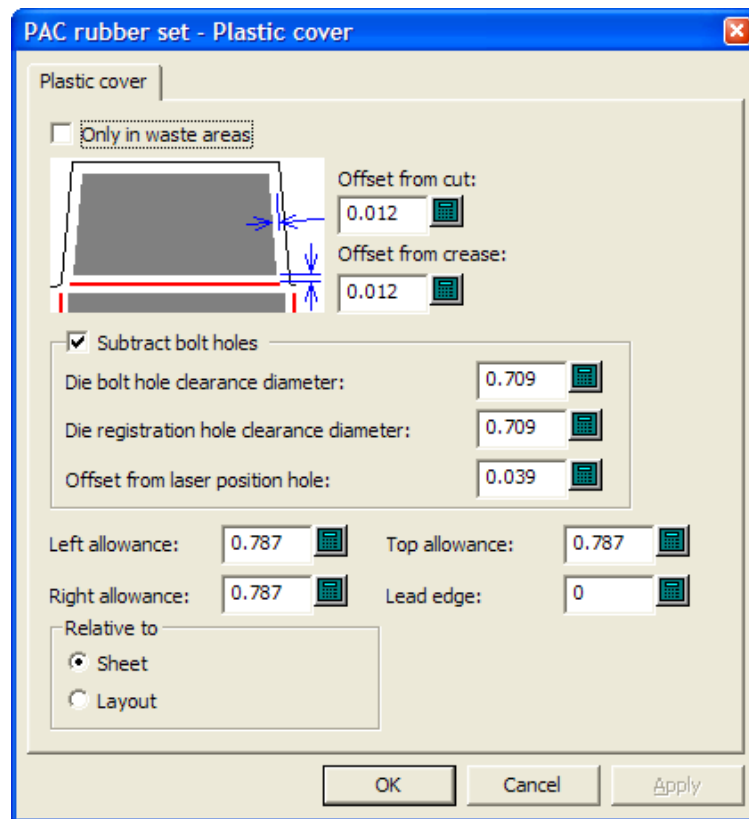

When **Only in waste areas** is selected, the plastic cover is used only to cover waste, not designs. When it is not selected, it covers both waste and designs, but not slots. Also, when it is selected, it is nested as if it were a type of rubber.

Offset from cut: and **Offset from crease:** both control how close the plastic cover gets to rule. Remember that it needs to project slightly over the rubber but not touch the rule.

Subtract bolt holes and its associated fields work the same way as they do in the Bolt holes section of the parameter set.

Left allowance; **Right allowance;** **Top allowance;** **Lead edge;** and the options in the **Relative to** group all determine how the plastic cover is positioned in reference to the edges of the layout.

Click **OK** when done to return to Defaults.

Rubber types

The **Rubber types** section of the parameter set is how ArtiosCAD determines which type of rubber to use in a given location and also how to place it.

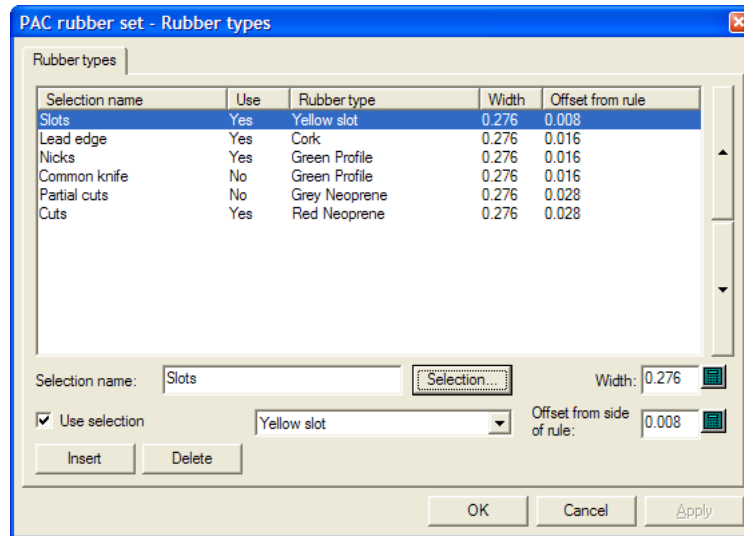

Rubber is assigned to lines on the basis of line type, knife location, knife side, slots, rule direction, and nicks. Use this dialog box to modify existing selections, create new selections, or delete existing selections.

The line entries in the Rubber Parameters dialog are applied in order, starting with the first (top) one and moving down through the list to find a match; each rule is compared with each selection in turn. The first selection that the rule matches defines the rubber type for that rule. The more critical selections with high shore rubber, such as for slots and nicks, should be first in the list.

To add a selection list entry, do the following:

1. Select an existing selection and click **Insert**.
2. A new selection is added to the table with the name of the rule from step 1 with (2) appended to its name.
3. Delete the text in the **Selection name:** field and enter the name for the new selection.
4. Enter the width of the rubber pieces in the **Width:** field, and the desired offset in the **Offset from side of rule:** field. Select **Use selection** and set the type of rubber from the drop-down list box. (The type of rubber must be defined in the Rubber Types catalog before it can be used in the parameter set.)
5. Click **Selection**. The Rubber Type Selection dialog box opens as shown below.

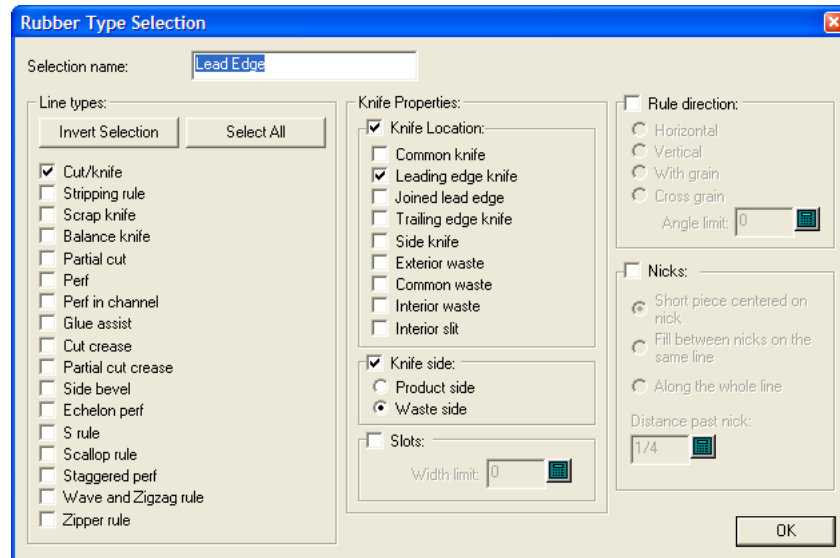

In this dialog box you select the conditions that a piece of rule must meet in order to be rubbered by the type of rubber selected. The checkboxes in the **Line types:** group and the **Knife Location:** group use OR logic, but the two groups together use AND logic: Cut/knife OR Stripping rule OR Scrap knife OR Balance knife, and so forth, AND of type Leading edge knife OR Exterior waste OR Interior slit, and so forth.

If the type of rubber you are defining is for slots, select **Slots** and enter the maximum width of the slot in the **Width limit:** field. If you define more than one type of rubber for slots, the narrowest slot should be highest in the list in the Rubber types dialog box, followed by the wider slots.

The other groups allow you to add more conditions to the rules that will receive this type of rubber; set them as desired. Nicks have the following restrictions: For **Short piece centered on nick**, the **Distance past nick:** field should be more than the width of the rubber. Also, for both of the first two options, the **Minimum length** should be less than the remaining length lines which you do not want to have the nick rubber type.

For the **Knife Location:** group, refer to the picture and table below.

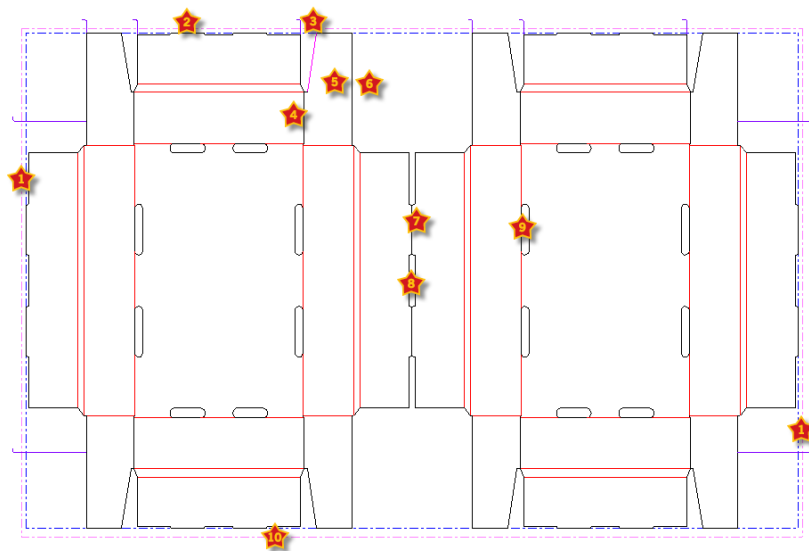

Table: Knife locations for rubbering types

Number	Location
1	Side
2	Trailing edge
3	Breaker knife (stripping rule)
4	Interior slit
5	Product side
6	Waste side
7	Common knife
8	Common waste
9	Interior waste
10	Leading edge

Once you have finished selecting the criteria for this rule, click **OK** to return to the Rubber Types dialog box.

1. Use the arrows at the right end of the list to move the selected rubber type selection either up or down in the priority list.
2. Repeat the process as desired to add selection list entries.
3. Click **OK** when done to return to Defaults.

All rule types except crease and balance knife should select a rubber type (rubber on balance knives is optional because this does not interfere with rubber on other rules). If you want no rubber on a particular rule type, because you are going to put rubber there manually, you should select rubber type **None** for this rule type, and still define an offset and a width, so ArtiosCAD knows how much space to leave for it.

For example, suppose you want no rubber on cut/crease. Copy the **Cuts** selection on the Rubber types tab, change the name to **Cut/crease**, change the rubber to **None**, and change the selection to select **Cut crease** lines. You can adjust the width and offset from rule for the rubber you are going to add manually.

If there are rules on the die with no rubber type defined, ArtiosCAD displays a warning dialog when you start the Rubber Area tool. You can either show the rules with no rubber type defined, or you can ignore the error, in which case surrounding rubber along nearby rules will cross the rules for which no rubber type is defined.

Rebuild options

The **Rebuild Options** entry in the Design defaults catalog lets you change behavior when rebuilding a single design or running a standard.

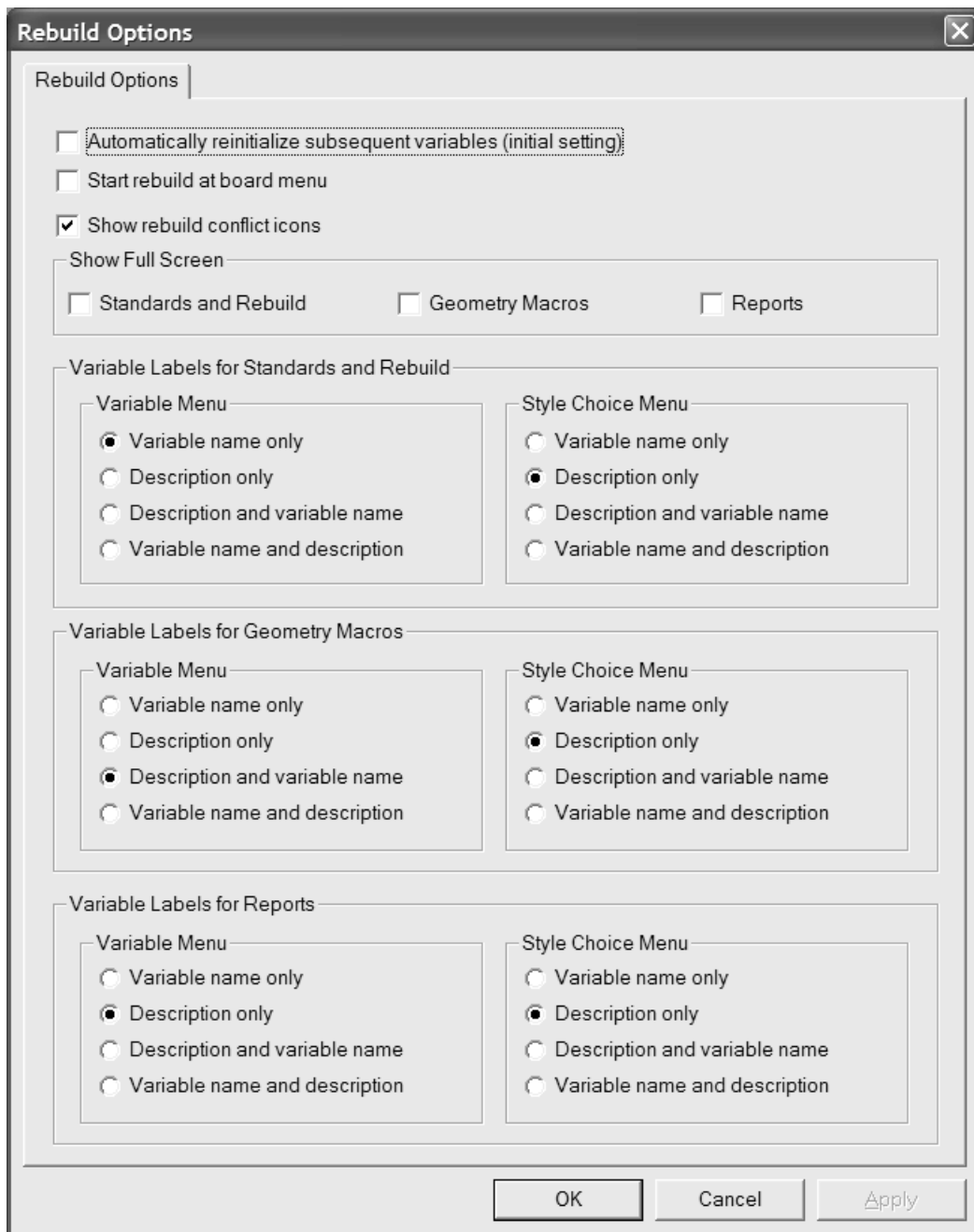

Automatically reinitialize subsequent variables reinitializes variables in subsequent menus which currently match their default values. When this option is selected and you change a variable, any subsequent variable depending on that variable which matched its default value before the rebuild started will get updated with the new value. For example, with this option selected, if you change L, any variable in any subsequent menu which depends on L gets automatically updated with the new value for L.

When this option is off, dependent variables are not automatically updated and are flagged for review in the Rebuild Conflicts dialog box

Start rebuild at board menu controls whether you may choose a new board when rebuilding a design instead of starting at the first visible menu.

Show full screen sets the Rebuild, Run Standard, and Reports dialog boxes to the maximum size possible. If you change the size of these dialog boxes manually, ArtiosCAD remembers these changes and uses your custom sizes instead.

The options in the **Variable labels...** groups control what is shown to the left of the fields when running a standard, rebuilding a design, using a geometry macro, or outputting a report. Choose from **Variable name only**, **Description only**, **Description and variable name**, and **Variable name and description**. If **Description only** is the chosen method and the variable description is blank, the variable name is used in parentheses. If there is no documentation plot for the menu, the description is shown with the variable name in parentheses. These options can be changed on the fly in the dialog boxes by clicking the tiny triangle above the variable list and selecting a different display option.

Click **OK** to make the changes and return to Defaults, or click **Cancel** to discard the changes.

3D Hardware Options

To set the default values for the gutters and offsets when using **Add Hardware** in 3D, open the 3D Hardware Options dialog box in the Startup defaults catalog.

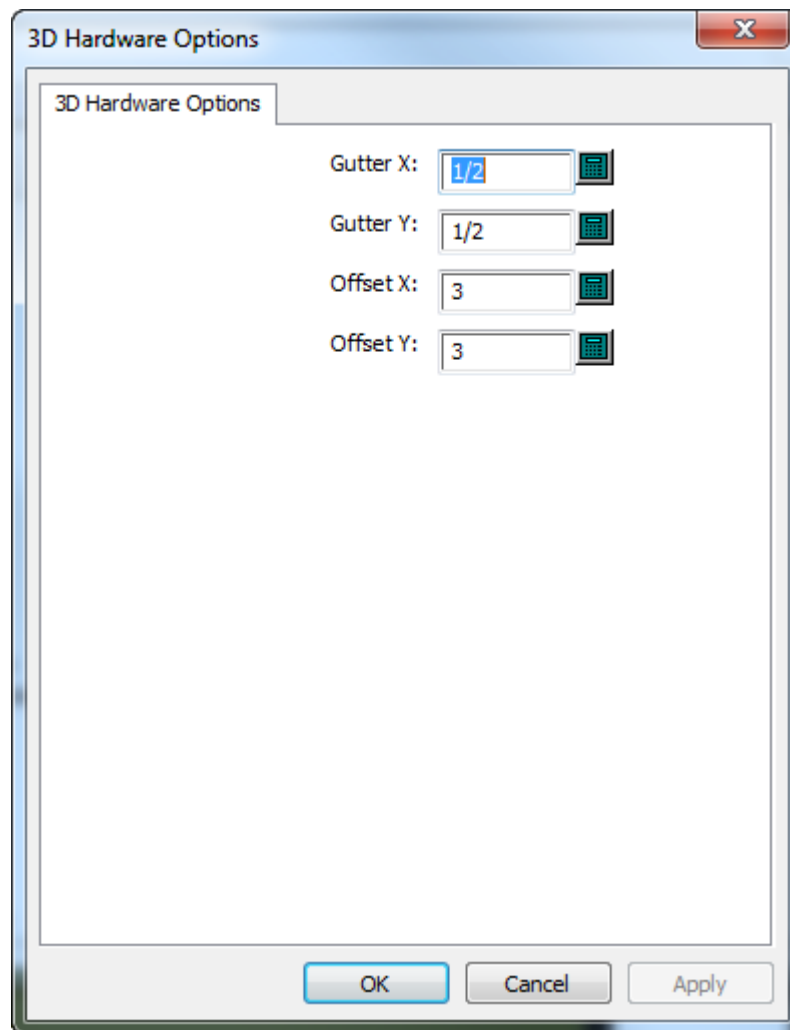

Change the values as desired and click **OK** to return to Defaults.

3D Import Options

Use the options in **Startup defaults > 3D Import** to control how ArtiosCAD imports solids.

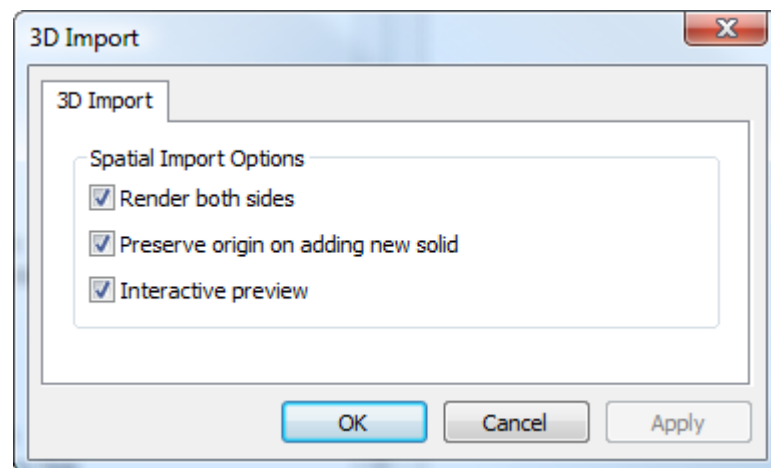

Render both sides shows the inside and the outside of the solid.

Preserve origin on adding new solid keeps the 3D workspace origin set so that when you import solids, they stitch together properly. When this option is off, ArtiosCAD adds solids centered behind existing solids.

Interactive preview shows the preview window, allowing you to choose which parts of multi-part solids to import. When this option is off, ArtiosCAD imports all parts of multi-part solids.

Click **OK** to make the changes and return to Defaults, or click **Cancel** to discard the changes.

3D Rendering method

The 3D module can use two different rendering (display) methods, **OpenGL** (the default) and **Direct3D**. Which method will perform better for you depends on the display adapter in your system. The main difference between the two methods is how data is transferred between main system memory and the display adapter. Other differences include:

- Shininess appears to work better when using Direct3D.
- ArtiosCAD using Direct3D takes longer to open a 3D workspace initially but once open draws it faster than when using OpenGL.
- Using OpenGL allows the export of bitmaps with more pixels than with Direct3D
- In wireframe view mode, OpenGL seems to be able to display more lines.
- When ArtiosCAD and the Cortona VRML viewer both use Direct3D and are open at the same time, they compete for resources and unpredictable results may occur. Change the rendering method in one of them for better results.

To change the rendering method in Defaults, open the Startup Defaults catalog and double-click **3D Rendering Options**.

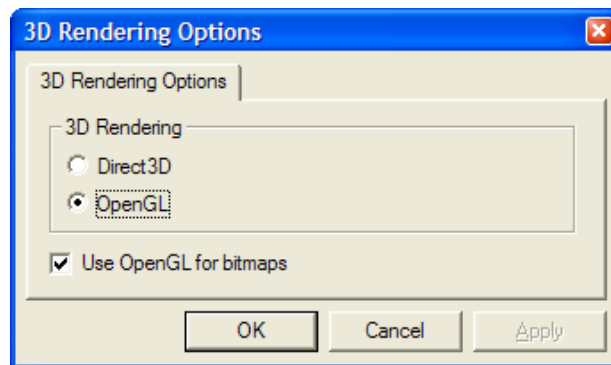

Choose the option button for the method to use and click **OK**.

Use OpenGL for bitmaps enables ArtiosCAD to output bitmaps using OpenGL regardless of the screen rendering method chosen. OpenGL supports the output of larger bitmaps than Direct3D.

Save and exit Defaults as usual. The change is effective immediately. You can also change it at any time by clicking **Options > 3D Rendering Options**.

Database defaults

Database defaults configure the operation of the ArtiosCAD database. Click **Options > Defaults**, and in the Shared Defaults pane, click **Design Defaults > Database** to open the Database dialog box.

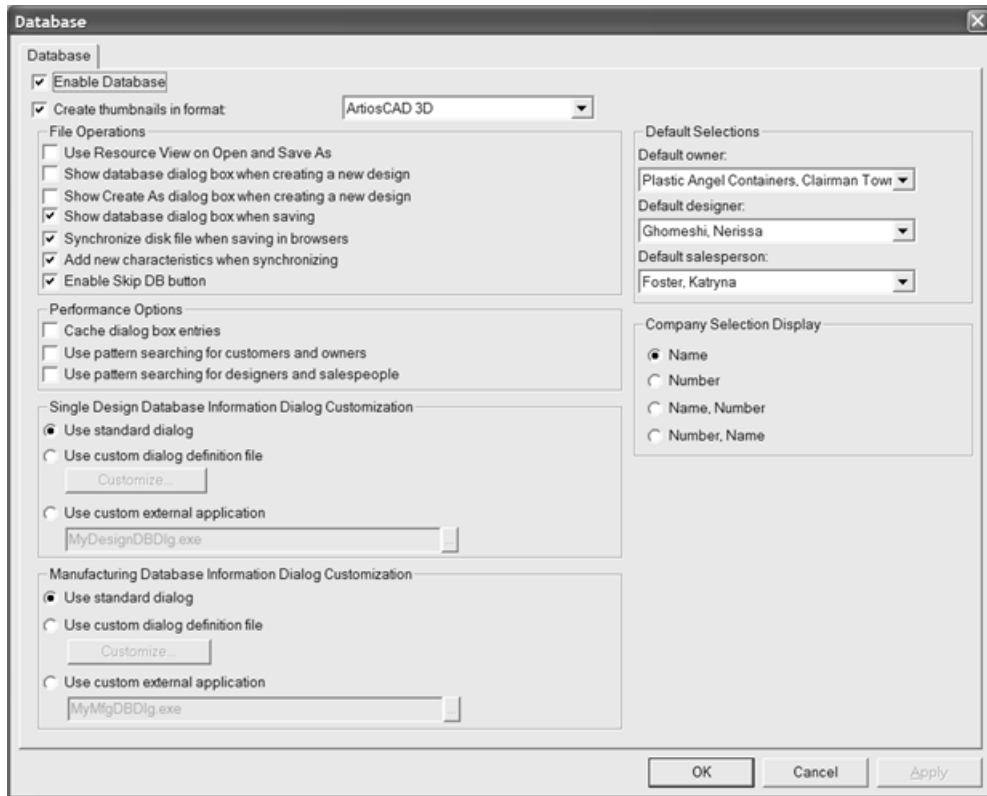

Enable Database, when checked, lets ArtiosCAD save information to the database. When the checkbox is clear, no new information is saved to the database. Database information that already exists is retained.

Create Thumbnail in Format controls if ArtiosCAD creates thumbnail pictures of workspaces when designs are saved. The thumbnails are stored in the database and are used by the database browsers.

The drop-down list box next to the checkbox controls the type of thumbnail created.

BMP with RLE compression is the default choice. It creates thumbnails in BMP format using run length encoding compression.

JPEG format creates thumbnails in JPG format, which is compressed but lossy (meaning some detail is lost).

Folded JPEG format first tries to create a folded view for the thumbnail based on saved angles in a single design. If there are no saved angles, a flat thumbnail is created. In each case JPEG format is used.

Artios3D format causes ArtiosCAD to look for an .A3D file by the same name as the workspace being saved in the same directory, and if found, that is used for the thumbnail. If it is not found, Folded JPEG format is used instead.

File Operations group

The checkboxes in the **File Operations** group control database activity when creating or saving a workspace.

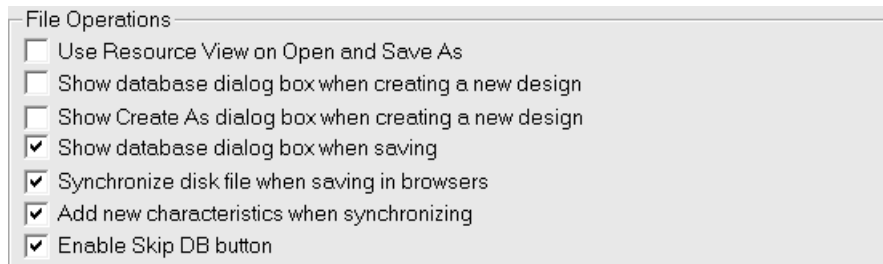

Use Resource View on Open and Save As, when checked, directs ArtiosCAD to use Resource View when opening workspaces or saving them using Save As. Directory View is used when this option is not checked.

Show database dialog box when creating a new design, when checked, instructs ArtiosCAD to prompt you for database information when you create a new design.

Show Create As dialog box when creating a new design, when checked, when checked, instructs ArtiosCAD to prompt you for the filename and resource or directory in which the design is to be saved when creating a new design.

Show database dialog box when saving, when checked, tells ArtiosCAD to prompt you for database information when you save a workspace in a resource.

Synchronize disk file when saving in browsers, when checked, causes ArtiosCAD to modify the disk file for the record you change in a database browser. This is independent of saving the record, which only affects the database.

Add new characteristics when synchronizing, when checked, instructs ArtiosCAD to compare the characteristics in a workspace being opened with those already in the database, and if there are new ones in the file, prompts you to add them to the database.

Enable Skip DB button, when checked, lets you click **Skip DB** when saving a workspace so that you can save a workspace with no corresponding database information.

Performance options group

The checkboxes in the **Performance Options** group control how ArtiosCAD retrieves certain types of information from the database.

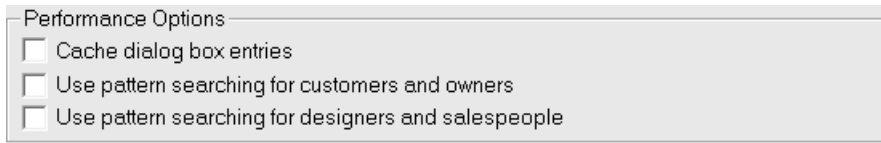

Typically, databases which run over WANs (Wide Area Networks), for example between plants, experience slower network performance compared to those which run over faster LANs (Local Area Networks). By default, ArtiosCAD requests a complete set of database entities each time the Database Information dialog box is activated, which can lead to wait times if there are many records to download from the database server.

To address this, ArtiosCAD can store the **Customer, Owner, Designer, Salesperson, Characteristics**, and **User Fields** entities from the Database Information dialog box in memory, as well as the boards, companies, company types, and Resources. This is called **caching**.

Both ArtiosCAD and CAD-X can use this feature, and each will use more memory if it is enabled.

Once the database dialog box entries or other entities are loaded into memory, ArtiosCAD does not re-request them from the database. If changes are made to the entities in the database itself, ArtiosCAD will not see them until the cache is refreshed or a new ArtiosCAD session is started. To refresh the cache, click **Database > Refresh cache > Item**.

ArtiosCAD can also search the database for specific records which match a pattern thus returning only a few records instead of thousands. This feature is called **pattern searching**.

Note: These performance options do not apply to customized database information dialog boxes. To use them, you must use the standard database information dialog boxes.

Caching

Toggle the **Cache dialog box entries** checkbox to enable and disable caching.

The table below lists how the fields in the Database Information dialog box behave when database dialog box entry caching is turned on. The Database Information dialog box behaves the same for Single Design and Manufacturing.

Table: Dialog box behavior when database dialog entity caching is enabled

Field	Behavior
Customer and Owner	All Customer and Owner entities are requested when the dialog box is first accessed, and then they are cached.
Salesperson and Designer	All Salesperson and Designer entities are requested when the drop-down list box arrow for either field is first clicked, and then they are cached. They share the same cache.
Characteristics button	Characteristics are requested the first time the button is clicked, and then cached. Only applicable to Single Design.

Field	Behavior
User Fields button	Same as Characteristics.
New button in Customer dialog box	Causes a refresh of the Customer cache.

In addition to caching Database Information dialog box entries, when caching is enabled, ArtiosCAD also caches boards, companies, company types, and Resources.

Once the database dialog box entries or other entities are loaded into memory, ArtiosCAD does not re-request them from the database. If changes are made to the entities in the database itself, ArtiosCAD will not see them until the cache is refreshed or a new ArtiosCAD session is started. To refresh the cache, click **Database > Refresh cache > Item**.

Pattern searching

Another way to ensure robust database performance over a slow Wide Area Network for the **Customer, Owner, Designer, and Salesperson** fields is to enable pattern searching by checking the **Use pattern searching for customers and owners** and **Use pattern searching for designers and salespeople** checkboxes. To maintain compatibility with previous versions, these checkboxes are both cleared by default.

When pattern searching is enabled, the Oneup Design Information and Manufacturing Database Information dialog boxes change. The drop-down list boxes for the **Customer, Owner, Designer, and Salesperson** fields disappear and the fields become disabled. In addition, there are ... buttons leading to dialog boxes which let you search for records and then display details about the selected records, or display details if there is already a selected record. Shown below is the Customer dialog box; all four dialog boxes act similarly, but only the Customer dialog box has the **New** button.



Pattern searching works by entering a few letters of a word, or a whole word, or a complete phrase, then choosing a method of searching, and then clicking **Find**. The results of the search populate the drop-down list box.

Mixing database performance modes

Database dialog box entry caching and pattern searching can be used simultaneously, but not for all four types of records. Only a pair of records (Customer and owners or designers and salespeople) for which pattern searching is turned off can be cached.

Database Information Dialog Customization groups

The options in the **Single Design** and **Layout Database Information Dialog Customization** groups allow you to choose what happens when entering database information for a single design or layout.

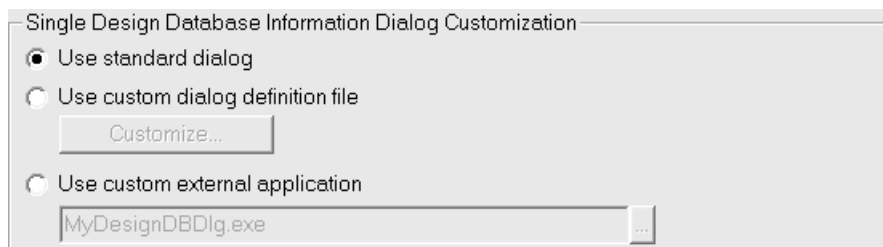

Use standard dialog uses the dialog box that is included with ArtiosCAD.

Use custom dialog definition file enables the **Customize** button, which in turn leads to the Control Layout Manager described in the next section. Using this feature requires the Information Enhancement option.

Use custom external application enables a field to specify the path to a custom program (such as an ERM program) that controls information storage instead of the ArtiosCAD database. This custom application is not provided or supported by Esko unless it was provided by the Professional Services department. Using this feature requires the Information Enhancement option.

Designing a custom Database Information dialog box

When you choose **Use custom dialog definition file** and click **Customize**, the Control Layout Manager dialog box opens showing the current dialog box.

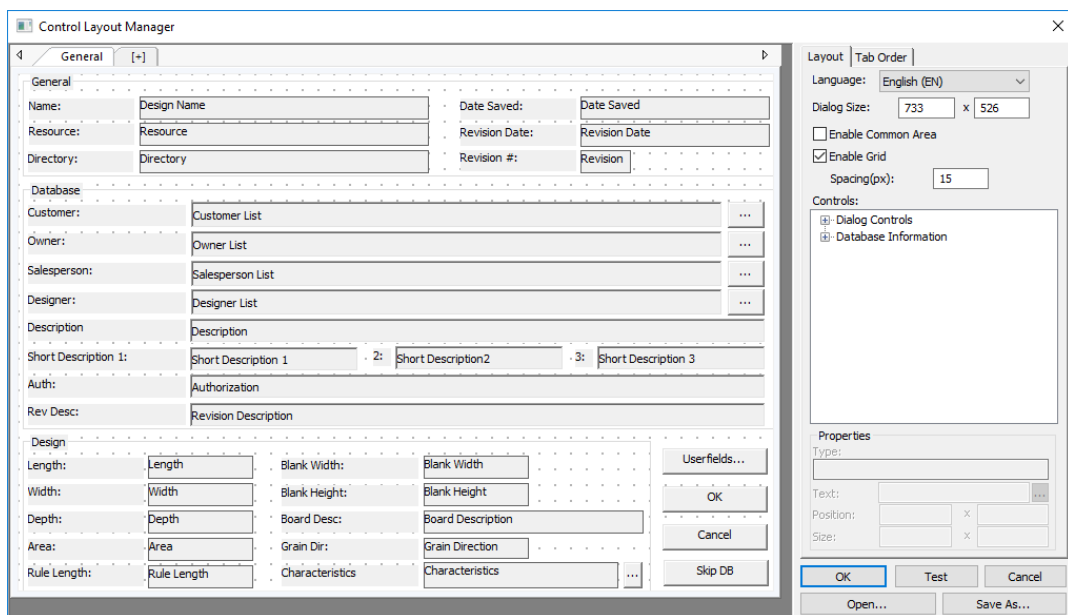

On the left is the dialog box itself showing the tabs, groups, labels, fields, and buttons. On the right are the language selector, size controls, the grid controls, the control catalogs, the **Properties** fields for the selected item, and the **OK, Test, Cancel, Open,** and **Save As** buttons.

There is no undo functionality in the Control Layout Manager, but you can click **Cancel** to discard all changes and then start again.

Each language of ArtiosCAD can have different customized database information boxes. Choose the language for the current dialog box in the **Language** drop-down list box.

To change the size of the dialog box, adjust the values in the **Dialog Size:** fields, or select the edge of the dialog box within the definition window and drag it to the desired position. To

make a dialog box larger than the current one, resize the Control Layout Manager dialog box itself using standard Windows methods, and then increase the size of the dialog box window.

Enable Common Area toggles the common area that ArtiosCAD shows when the dialog box has multiple tabs. For more information about tabs, see *Working with Tabs*.

Enable Grid and **Spacing(px)** control the appearance and spacing of the alignment grid. Turn on the grid to have controls snap to the nearest point when you drag them. The number in the Spacing(px) field is the number of pixels.

To add a control, select it from the catalog and drag it to the desired position. You may also double-click it; it will appear at the top left of the dialog box, and you may then select it and drag it to the desired position.

To select multiple controls at once, hold down **SHIFT** or **CTRL** and click each control. Alternately, you may make a rectangular marquee selection around the desired controls. The selection rectangle must completely encompass the controls. Be careful about selecting anything too close to the edge of a group box as you might accidentally select the box and not the objects within it.

To remove a control, select it and press **Delete** on the keyboard.

To move a control, select it and drag it to the desired position, or select it and use the **Position:** fields in the **Properties** group to adjust its position. You can also select it and use the arrow keys to move it in one-pixel increments.

Removing and moving multiple controls work the same way; just select them first.

To resize a control, select it, and use the handle points to change its size as desired, or select it and use the **Size:** fields in the **Properties** group to adjust its size.

To change text in a control, select it, and then change the contents of the **Text:** field in the **Properties** group.

To change the translation for a control, select it, and then click More Options (...) at the end of the Properties field. Enter the desired translations in the appropriate fields in the Text Language Options dialog box. If a field is empty, ArtiosCAD uses the text in the Default Text field. Click **OK** when done to return to the Control Layout Manager.



Note: ArtiosCAD is limited to displaying characters in the code page of the running operating system. While there might be different strings defined for a dialog box, they may not appear correctly if the code page of your current operating system cannot display them.

When editing a field in the **Properties** group, or a **Dialog Size:** field, click in another field or select a different object to activate the changes made to the first object. Do not press Enter as that is interpreted as clicking **OK** and will thus close the dialog box.

Click **OK** to save the changes to the dialog box and close the Control Layout Manager. The single design information is saved as **DBDIgDesignDef.xml**, and the manufacturing data is saved as **DBDIgMFGDef.xml**, both in ServerLib or ClientLib depending on which set of defaults was changed.

Click **Cancel** to discard the changes to the dialog box and close the Control Layout Manager.

Click **Test** to open a sample dialog box that previews the final result.

Click **Save As** to save the dialog box layout to a file.

Click **Open** to open a previously-saved dialog box layout file.

Shown below is a modified **Database** group in the Control Layout Manager and then in the test dialog box.

Database

Customer:	Customer List			...
Plate Number:	(9902)Inventory I	Sale PO Number:	(9906)Sale P.O.	Ship: (9911)Ship Method
Designer:	Designer List			...
Description	Description			
Short Description 1:	Short Description 1	2:	Short Description2	3: Short Description 3
Auth:	Authorization			
Rev Desc:	Revision Description			

Database

Customer:	<input type="text"/> ▼ ...			
Plate Number:	(9902)Inventory	Sale PO Number:	(9906)Sale P.O.	Ship: (9911)Ship Method
Designer:	<input type="text"/> ▼ ...			
Description	Description			
Short Description 1:	Short Description 1	2:	Short Description2	3: Short Description 3
Auth:	Authorization			
Rev Desc:	Revision Description			

Note: Database performance options do not apply to customized database information dialog boxes. To use them, you must use the standard database information dialog boxes.

Defining the Tab Key Order

When you are defining a custom database information dialog box, you can set the Tab key order for the controls in the dialog box on the Tab Order tab of the control layout manager.

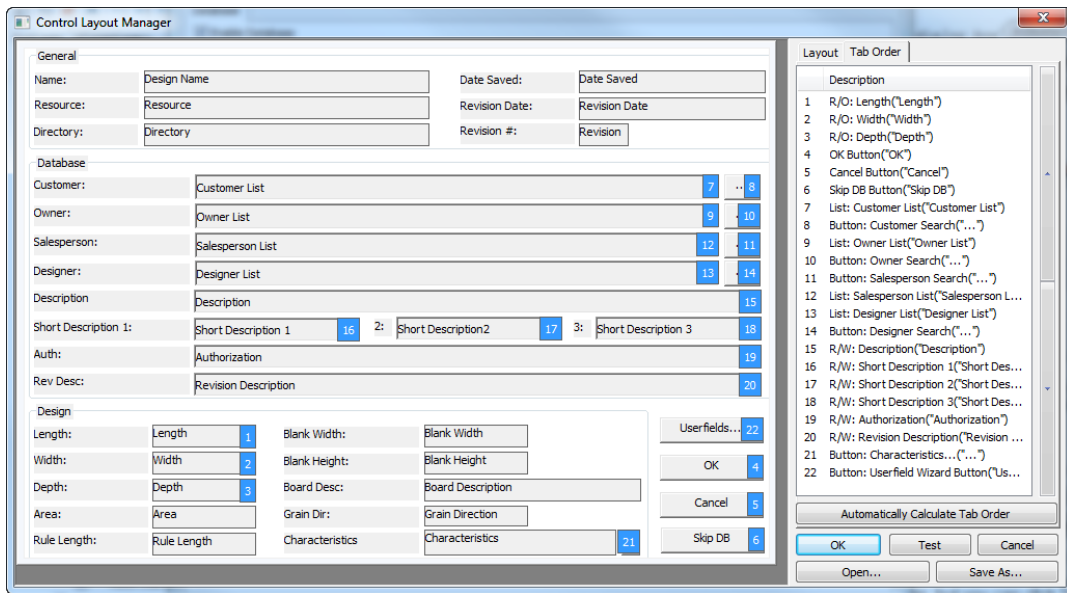

You can only set the Tab key order for fields that you can change in the dialog box. Labels and read-only fields do not have Tab key order settings.

To change the Tab key order manually, do the following:

1. Select a field or button with a blue number after it by either clicking it in the dialog designer or in the list on the right.
2. Use the arrows to the right of the list to change its position, or
3. Drag and drop the entry to its new position.

Automatically Calculate Tab Order assigns Tab key orders to elements horizontally from top to bottom of the dialog box.

Each tab of the dialog box has its own Tab key order. The common area is always after the current tab.

If you have added some controls to the dialog box, you must save those changes, exit the control layout manager, and re-enter it in order to set the Tab key order on those new controls. ArtiosCAD puts the new controls at the end of the list.

Working with Tabs

ArtiosCAD allows you to create additional tabs in customized database dialog boxes. You could have one tab for general information, one tab for design-specific information, one tab for customer information, and so on. There is also an area at the bottom of the dialog box reserved for common controls shown regardless of which tab is active. Shown below is an example of a customized tabbed single design database information dialog box in its Defaults definition, and then in use in ArtiosCAD.

General [x] Design Customer Misc [+]

General

Name: Design Name Date Saved: Date Saved

Resource: Resource Revision Date: Revision Date

Directory: Directory Revision #: Revision

Projects... Seed Database Information From Project

Add To Project

OK

Cancel

Skip DB

Database Information [x]

General Design Customer Misc

General

Name: EXPERT BOX_WINDOW Date Saved: Wednesday, August 2, 2017

Resource: Smile Revision Date: Tuesday, August 1, 2017

Directory: C:\Prod\Smile\04_3D Assembly - ArtiosCad\CAD\ Revision #: A

Projects... Seed Database Information From Project

This design is already in the project.

OK

Cancel

Skip DB

If you have upgraded from a previous version of ArtiosCAD, the default database information dialog box uses one tab and the common area is not enabled.

Adding a Tab

To add a tab, click the plus sign in brackets.



Renaming a Tab

To change the name of a tab, double-click its current name and enter a new name in the field. Press Return when done.

Tab names are specific to the selected language in the **Language** drop-down list box. The first name you enter for a new tab is the default for every language. To change the name of a tab in a different language, first select the different language, then change the name of the tab.

Deleting a Tab

To delete a tab, click the red X on the tab.

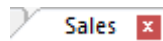

The Common Area

The common area at the bottom of the dialog box is for controls that persist regardless of which tab is active. Use **Enable Common Area** to toggle its display. To resize the common area and tabs, drag the bar separating it from the tabbed area. All the tabs are the same size.

Adding Controls

To add a control to a tab, drag it as usual from the list on the right to the desired position on the tab. Note that you cannot drag controls between the common area and a tab. In that case, delete the control and re-add it in the desired position.

Selecting Controls

You may only select controls, either singly or multiply, in either the tabbed area or the common area, but not both.

Version Interpretation

If you share customized database dialog definition files between system that are different versions, the following rules apply:

- ArtiosCAD 16.1.1 or later reading a definition created in an earlier version: One tab, no common area.
- ArtiosCAD 16.1.1 or later sending a definition file to an earlier version: Only the controls from the first tab and common area are shown by the earlier version.
- An ArtiosCAD version earlier than 16.1.1 reading a definition created in 16.1.1 or later: 16.1.1 creates a dual-format definition file with a tabbed interface section and a flat

interface section. An earlier version reads the flat interface section and ignores the tabbed interface section (but remembers it).

- An ArtiosCAD version earlier than 16.1.1 writing a definition read by 16.1.1 or later: Writes a flat version. If you use this to overwrite a tabbed version on a different system, the tab information will be lost.

Using a custom external application

Use a custom external application allows a separate standalone application to display and gather database information. Specify the absolute path name of the application in the associated field, or use the Browse button (...) to locate it. This custom application is invoked whenever the Database Information dialog box would otherwise be shown.

The exact sequence is:

1. ArtiosCAD requests database information (by clicking **Database > Database Information** or during a **Save** or **Open**).
2. The current database information is packaged into a randomly-named XML file in the directory defined as the TEMP directory in **Options > Defaults > Startup Defaults**.
3. The external application is invoked with the input XML file as the first parameter.
4. ArtiosCAD waits until the external application is done.
5. ArtiosCAD reads the XML file specified as the second parameter on the external application's command line and uses it to populate the database.

Shown below is the dialog box created by a sample application.

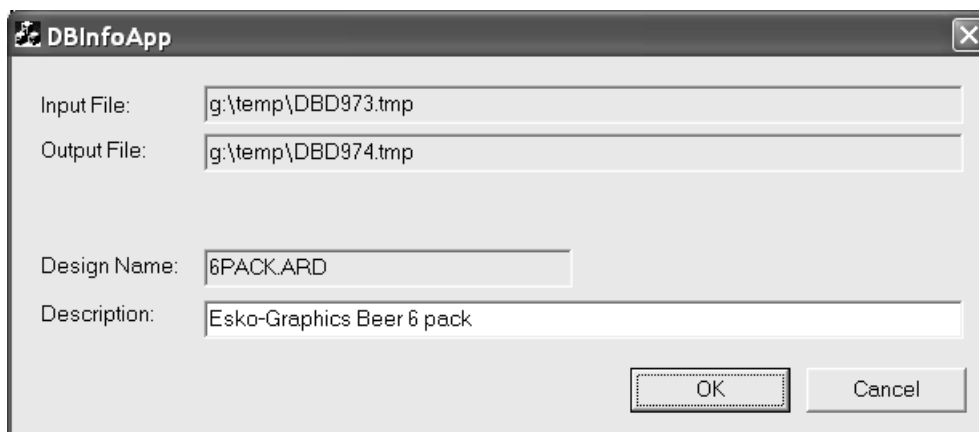

The exact command executed is:

```
Application.exe -iInputXMLDBInfo.xml -oOutputXMLDBInfo.xml
```

where Application.exe is the name of the custom application, InputXMLDBInfo.xml is the full path name of the temporary input XML file that ArtiosCAD creates, and OutputXMLDBInfo.xml is the full path name to the output XML file created by the custom application. The names of the parameters are generated randomly by ArtiosCAD; the custom application should read them from the command line.

ArtiosCAD checks for a return code from the custom application of 1 for OK and 2 for Cancel.

A sample database definition XML file is shown below.

```

<ARTIOSDBDOC>
<UNITS>
IMPERIAL</UNITS>
<DESIGN>
<NAME>
SAMPLE1.ARD</NAME>
<REV>
0</REV>
<REVNUM>
0</REVNUM>
<PATH>
C:\Artios\Designs\</PATH>
<REVDATE>
2004-04-14</REVDATE>
<SAVEDATE>
2004-04-14</SAVEDATE>
<DESC>
This is a sample long description</DESC>
<SHORTDESC1>
Short 1</SHORTDESC1>
<SHORTDESC2>
Short 2</SHORTDESC2>
<SHORTDESC3>
Short 3</SHORTDESC3>
<AUTH>
Authorization</AUTH>
<REVDESC>
Revision Description</REVDESC>
<LENGTH>
8.000000</LENGTH>
<WIDTH>
7.000000</WIDTH>
<DEPTH>
6.000000</DEPTH>
<GRAINDIR>
2</GRAINDIR>
<CAL>
0.016000</CAL>
<BLANKLEN>
780.256226</BLANKLEN>
<BLANKHEIGHT>
558.799927</BLANKHEIGHT>
<AREA>
267241.718750</AREA>
<RULELEN>
5269.554688</RULELEN>
<RESOURCE>
<ID>
1</ID>
<NAME>
ArtiosCAD</NAME>
<RELPATH>
Artios\Designs</RELPATH>
<PATH>
C:\Artios\Designs</PATH>
<MASTER>
1</MASTER>
<ACTIVE>
1</ACTIVE>
<INHERITAUTONUM>
1</INHERITAUTONUM>
<SERVER>
<ID>
1</ID>
<NAME>
ArtiosCAD</NAME>
<PATH>
C:\</PATH>
</SERVER>
</RESOURCE>
<BOARD>
<ID>
39</ID>
    
```

```

<CODE>
I-SBS-16</CODE>
<DESC>
I-SBS-16</DESC>
<FLUTE/>
<TESTCODE/>
<CAL>
0.016000</CAL>
<TESTVAL>
0.000000</TESTVAL>
<IL>
0.008000</IL>
<OG>
0.008000</OG>
<CRRV>
0.031250</CRRV>
<BASISWEIGHT>
64.000000</BASISWEIGHT>
<BASISCOST>
72.000000</BASISCOST>
<WORKSPACE>
0</WORKSPACE>
</BOARD>
<CUSTOMER>
<WORKSPACE>
0</WORKSPACE>
<ID>
1</ID>
<PUBID>
-1</PUBID>
</CUSTOMER>
<OWNER>
<WORKSPACE>
0</WORKSPACE>
<ID>
1</ID>
<PUBID>
-1</PUBID>
</OWNER>
<SALESPERSON>
<WORKSPACE>
0</WORKSPACE>
<ID>
1</ID>
<PUBID>
-1</PUBID>
</SALESPERSON>
<DESIGNER>
<WORKSPACE>
0</WORKSPACE>
<ID>
1</ID>
<PUBID>
-1</PUBID>
</DESIGNER>
<CHARACTERISTICDATALIST>
<CHARACTERISTICDATA>
<CODE>
PART</CODE>
<DESC>
Partitions</DESC>
</CHARACTERISTICDATA>
<CHARACTERISTICDATA>
<CODE>
SHIP</CODE>
<DESC>
Shipping carton</DESC>
</CHARACTERISTICDATA>
</CHARACTERISTICDATALIST>
<USERFIELDDATALIST>
<USERFIELDDATA>
<ID>
9902</ID>
<DESC>
Inventory Die Board No.</DESC>
<VALUE>
DIE45679</VALUE>

```

```
</USERFIELDDBDATA>
</USERFIELDDBDATA LIST>
</DESIGN>
</ARTIOSDBDOC>
```

For more information about using a custom application, contact Professional Services.

Default selections group

The drop-down list boxes in the **Default Selections** group set the owner, salesperson, and designer for newly-created workspaces. These fields get their lists of possible values from the Company and Person browsers in DataCenter Admin. Set the values as desired.

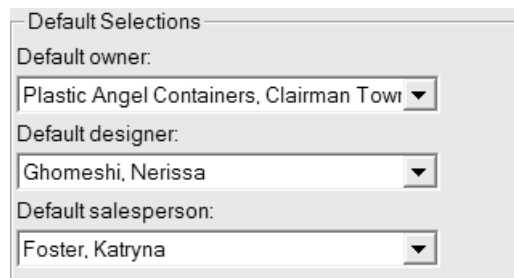

Click **OK** to save the changes made to Database defaults and return to the main Defaults dialog box. Click **Apply** to save the changes but remain in the Database defaults dialog box. To discard all changes and return to the main Defaults dialog box, click **Cancel**.

Company selection display group

The option buttons in the Company Selection Display group control how company name and identification information is shown in ArtiosCAD. **Name** is the default choice.

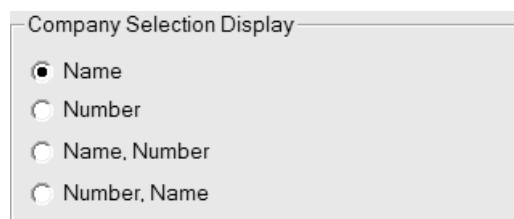

Name and **Number** are fields you set for a company in the Company browser in DataCenter Admin. Note that **Number** can be any number you set; it is not calculated. Choose the display format as desired.

Any changes made in this group will not appear in the **Default Selections** group in this dialog box until you click **OK** and then open the Database defaults again.

Shown below is an example in the Oneup Database Information dialog box when **Number, Name** is the chosen option in Company Selection Display.

Database	
Customer:	00010, Plastic Angel Containers, Clairman Town
Owner:	00003, Meeber Box Company, Chatham

Spell checking

If you have Microsoft Word installed on your system, ArtiosCAD can use its spell checking functionality in Single Design and Manufacturing in most places where you enter text using a field in a dialog box. This feature is turned on by default. You may turn it off in the Paragraph Text tool and in text fields by using the Spelling dialog box in the Startup Defaults catalog.

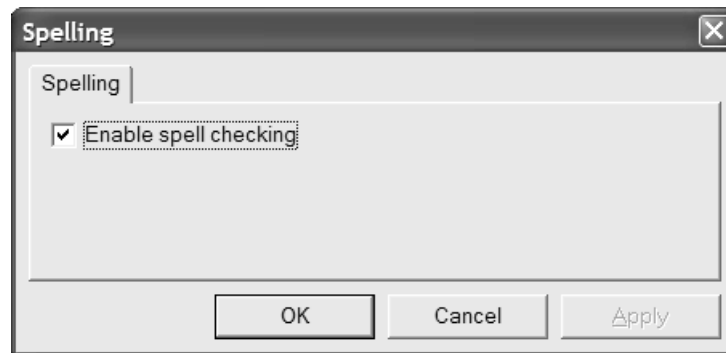

Toggle the **Enable spell checking** checkbox as desired, and click **OK** to save the change and return to the main Defaults dialog box.

Note: This setting does not affect document-wide spell check using **Tools > Check Spelling**. It is available regardless of the state of this checkbox.

Nudge Options and Defaults

Click **Options > Nudge** to set the active nudge modes per session and the distances they use. This command is available when a single design or a manufacturing file is open. Essentially the same dialog box is used in Defaults in **Startup defaults > Nudge options**.

Shown below is the **Nudge options** dialog box.

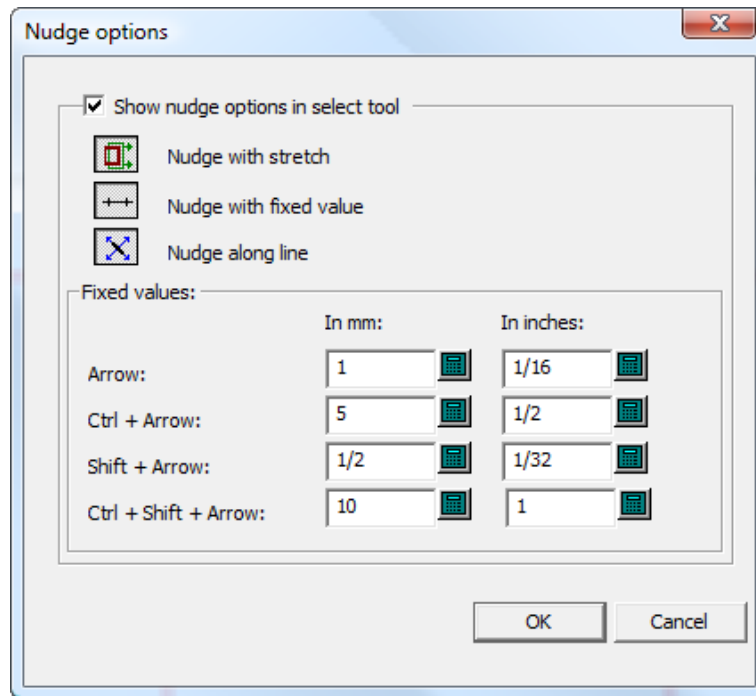

Show nudge options in select tool controls the availability of the nudge modes. When it is selected, they are active. When it is cleared, nudge moves by a pixel.

Set the three mode selectors as desired. They determine which nudge modes are active when a tool which supports nudge is started.

The values in the **Fixed values** group control the distance used by the Nudge by a Fixed Value mode. Set them as desired.

Note:

If you change the nudge options or Defaults while a Select tool is active, the tool will be restarted to update it and the current selection will be lost.

Hatch Defaults

ArtiosCAD stores Defaults for the Hatch tool in three locations: the **Hatch Catalog**, **Property defaults > Hatch**, and **Startup defaults > Hatch tool options**.

Hatch Catalog defaults

The Hatch Catalog in Defaults is where you add, remove, and change entries in the Hatch Catalog. ArtiosCAD comes with sample entries in the **Misc** folder.

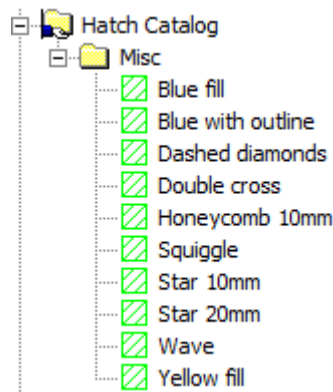

To add a folder to the catalog, right-click the folder which will contain the new folder, then click **New > Folder**. To add a new entry to a folder, right-click the folder and then click **New > Data**.

To remove a folder or an entry, right-click it and click **Delete** on the context menu. ArtiosCAD will ask you to confirm the deletion.

To change an entry, double-click it and change the properties as desired. The **Hatch Properties** dialog box is the same as it is in drawing mode.

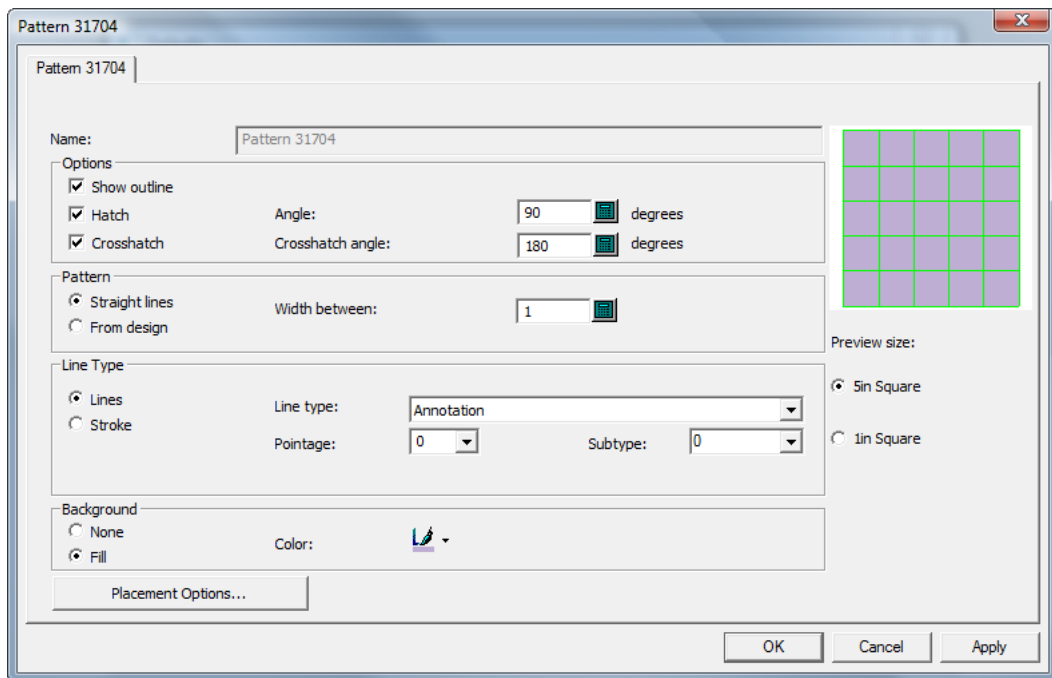

Hatch Property defaults

In **Property defaults > Hatch**, you set the Defaults for the **<custom>** Hatch Catalog entry as shown below.

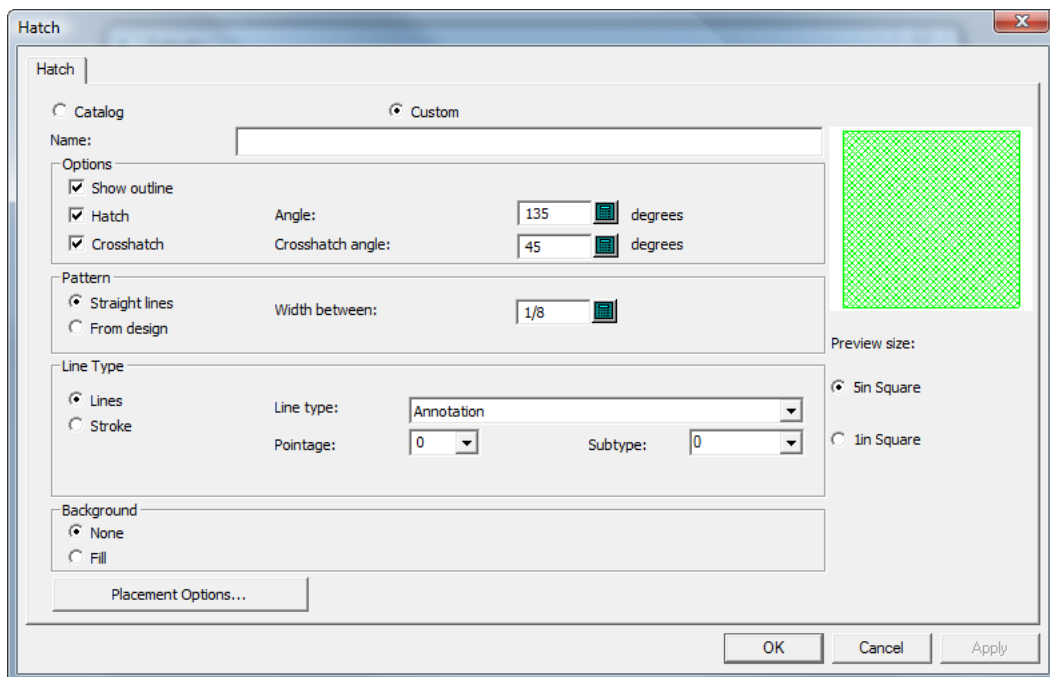

The Hatch Properties are the same as in drawing mode; set them as desired and click **OK** to return to Defaults.

Hatch Startup defaults

In **Startup defaults > Hatch tool options**, you set the options for how the **Hatch** tool will initially work.

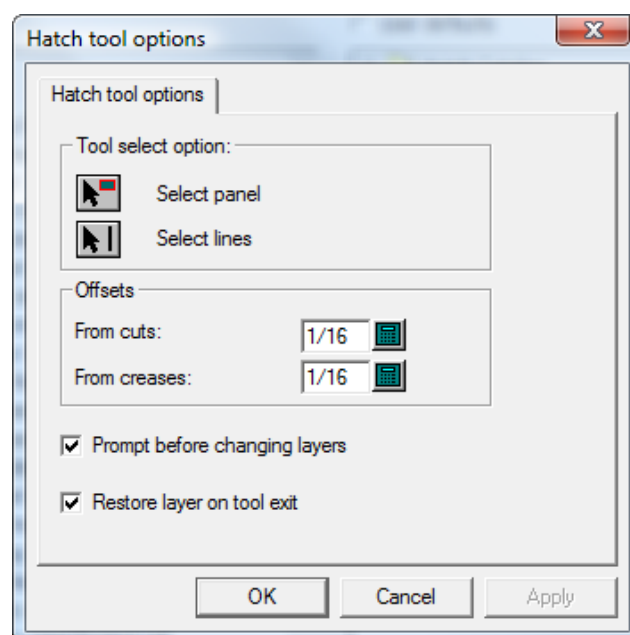



In the **Tool select option** and **Offsets** groups, set the options as desired.

Prompt before changing layers, when checked, makes you confirm changing layers to the layer specified in a Hatch Catalog entry's **Placement Options** dialog box. **Restore layer on tool exit**, when checked, returns you to the layer you were in if the layer changed due to using a Hatch Catalog entry with a layer assignment.

When you are done setting the options as desired, click **OK** to return to Defaults.

Adding Purchased Standards to Style Catalogs

To install a purchased ArtiosCAD standard, do the following:

1. Verify the data and settings in the 2D workspace.
 - a)  Open the workspace in ArtiosCAD and set the units, database information, and board code as desired.
 - b)  Convert the 2D workspace to 3D and set the base face and fold angles. The standard may already have this information set in it.
 - c) Close the 3D workspace, making sure to leave **Save fold angles and view settings...** selected. You may save or discard the 3D workspace as desired; you do not need it for the standard.
 - d) Save the 2D workspace.
2. Copy the workspace to the Shared Defaults folder or Project so everyone will be able to use it.
 - a) For ArtiosCAD Standard Edition, using Windows Explorer, copy the 2D workspace from where you saved it to ..\Esko\Artios\ServerLib.
 - b) For ArtiosCAD Enterprise, save or upload the 2D workspace to the Standards subfolder of the Shared Defaults Project. Depending on how the Shared Defaults Project security is configured, you may need administrator privileges for this.
3. Add the standard to a Style Catalog.
 - a) In ArtiosCAD, click **Options > Defaults** to open Defaults.
 - b) Scroll down the list of Shared defaults and open the **Style catalog** catalog.
 - c) Right-click the folder in which you will place the new standard and click **New > Data**. To make a new subfolder, right click its parent folder and click **New > Folder**.

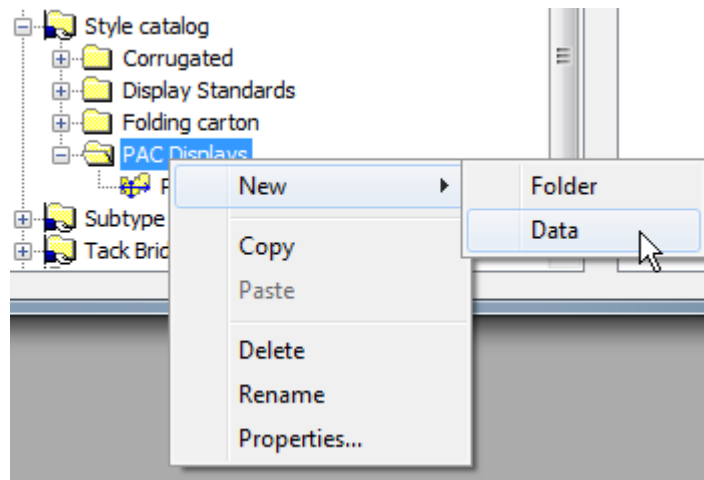

- d) Enter the name of the new standard as you want it shown in the style catalog and press Enter when done.

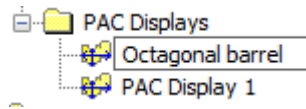

- e) Double-click the new standard entry to open its Properties dialog box.
- f) Make sure the **Standard Type** is set to ArtiosCAD.
- g) Click ... (Browse) at the end of the Filename field to navigate to ServerLib for ArtiosCAD Standard Edition, or the Standards subfolder of the Shared Defaults Project for ArtiosCAD Enterprise, and then double-click the workspace. Its filename should appear in the Filename field.

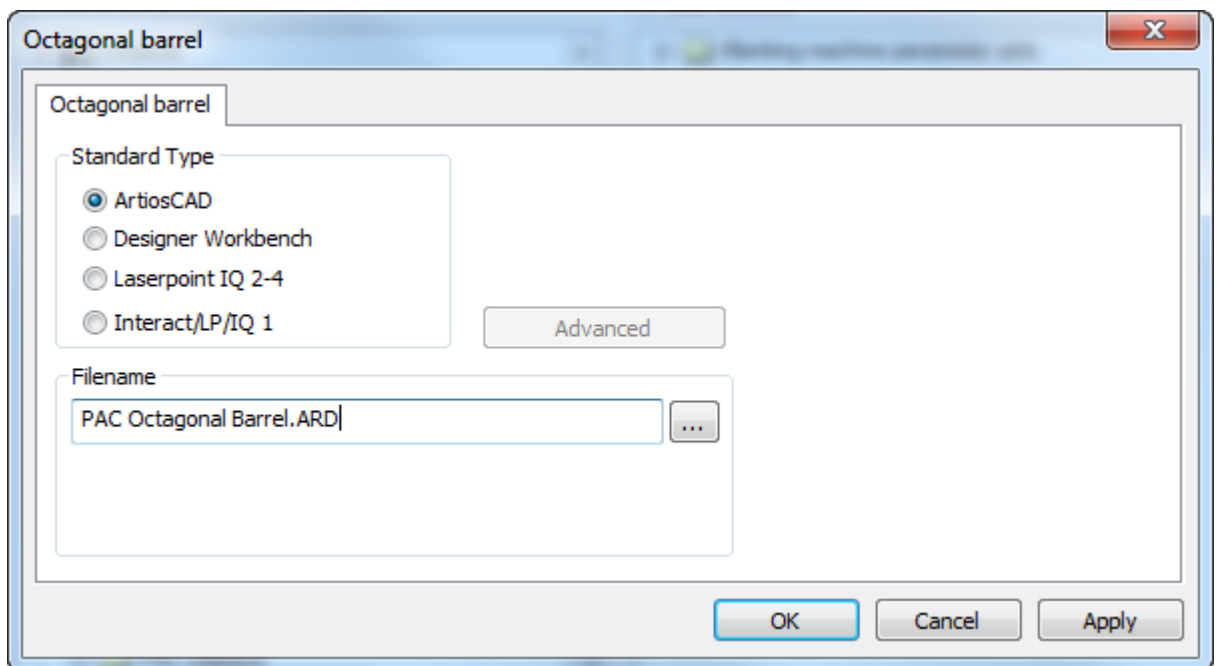

- h) Click **OK**.
- 4. Click **File > Save** and click **Yes** to overwrite Shared defaults.
- 5. Click **File > Exit** to exit Defaults.
- 6. To test the standard, do the following:
 - a) Click **File > Run a Standard**.
 - b) Navigate to the new standard and select it.

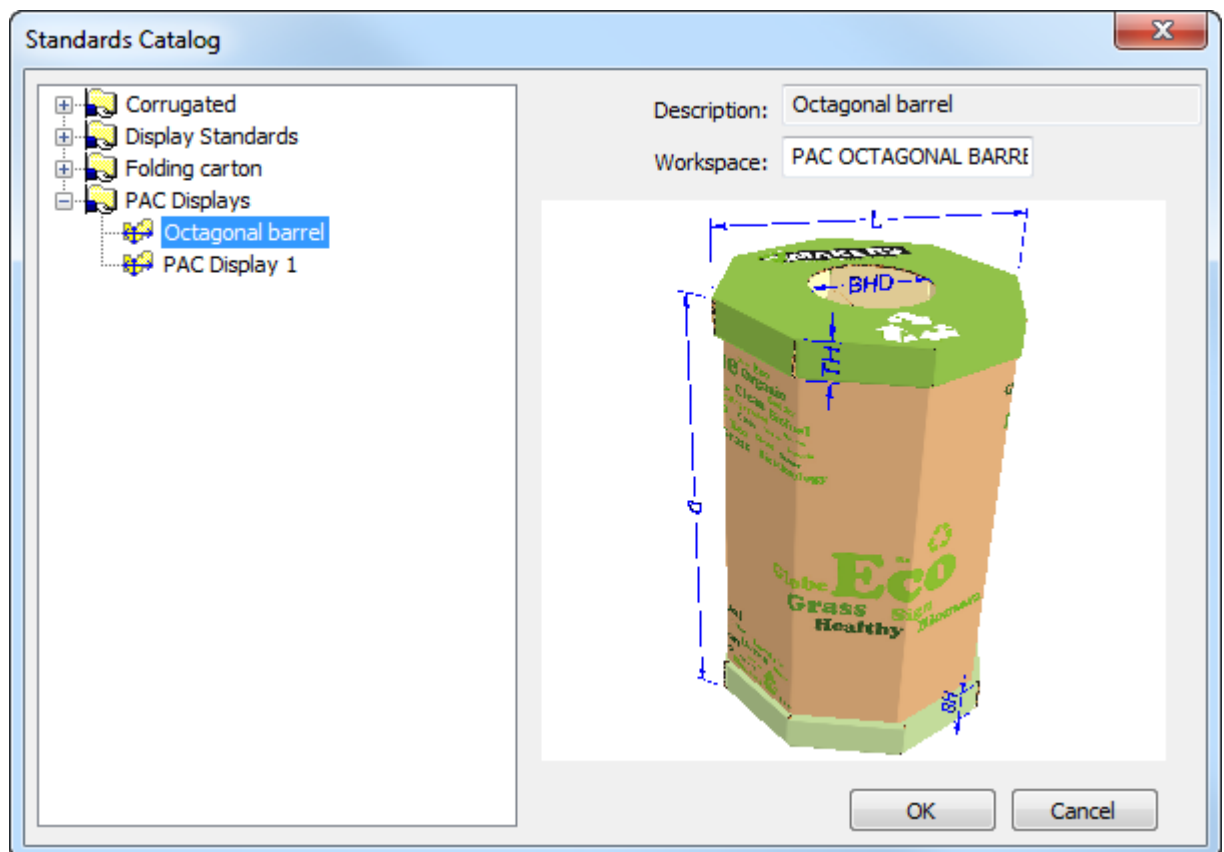

- c) Click **OK** to run the standard. Select a board code and set the style choices in the menus.
- d) Convert the 2D workspace to 3D. ArtiosCAD will use the saved fold angles you set in step 1.

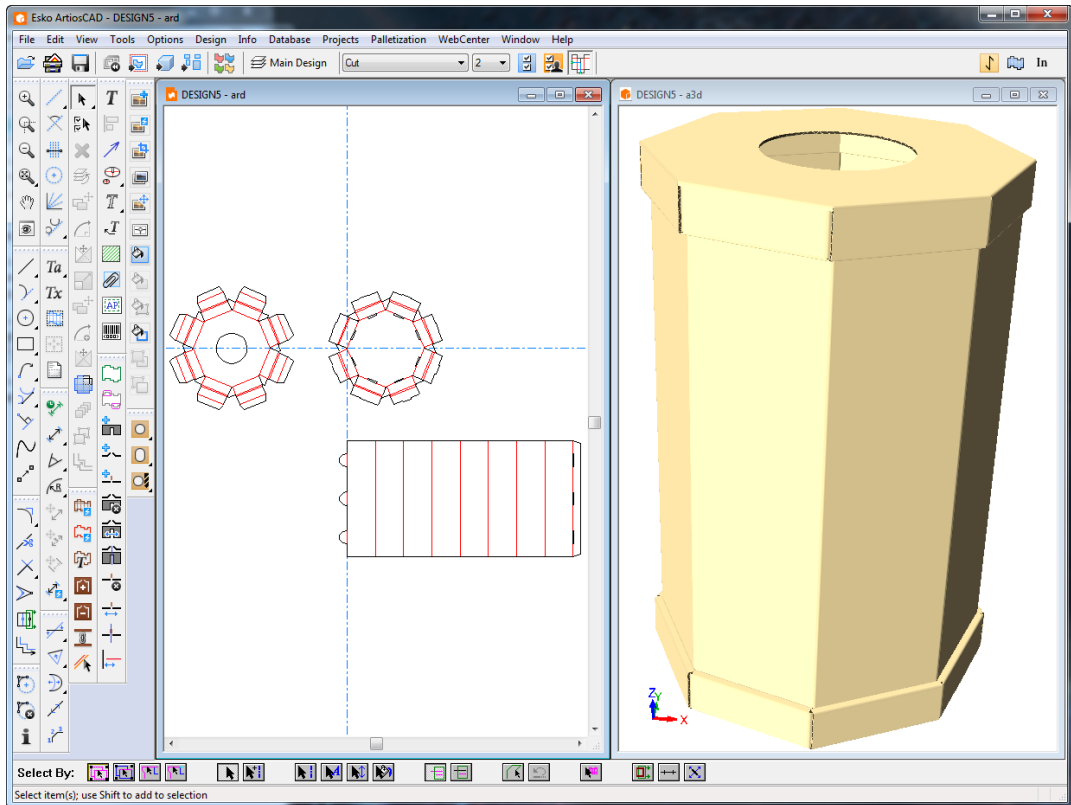

e) If everything is correct, you may now start using the standard. If it is not correct, adjust the workspace in ServerLib or the Shared Defaults Project.

Adding LASERPOINT IQ standards to Style Catalogs

Preparation

Before adding a LASERPOINT IQ standard to ArtiosCAD, it is necessary to locate the LASERPOINT IQ files needed to run the standard. The name can be determined using Menu Management. Locate the standard to add and select the **Edit** option. This will show a standard name which looks like one of the following entries:

- EXE STDMENU WITH 'XYZ' This is an entry for a LASERPOINT IQ 2.0 format standard whose name is XYZ. You will need the files XYZGEOM and XYZW.
- XYZ. This is an entry for a pre-LASERPOINT IQ 2.0 standard whose name is XYZ. You will need the file XYZ and there may also be a file called XYZW containing documentation plots.

The files for the standard you are migrating are probably in your \LP\USER_LIB1 directory. Copy them to ..\Esko\Artios\ServerLib.

Adding the standard to a Style Catalog

Add the LASERPOINT IQ standard to the ArtiosCAD style catalog using Defaults in a similar way to normal ArtiosCAD standards. Start ArtiosCAD, and then open the style catalog as follows:

1. Click **Options** and **Defaults** to open the Defaults dialog box.
2. Use the right mouse button to click **Style Catalog** in the left area of the dialog box and then click **New** and **Data**.
3. Type the descriptive name for the standard as you want it displayed in ArtiosCAD.
4. Double-click the icon beside the standard name to open the dialog box for specifying the standard.

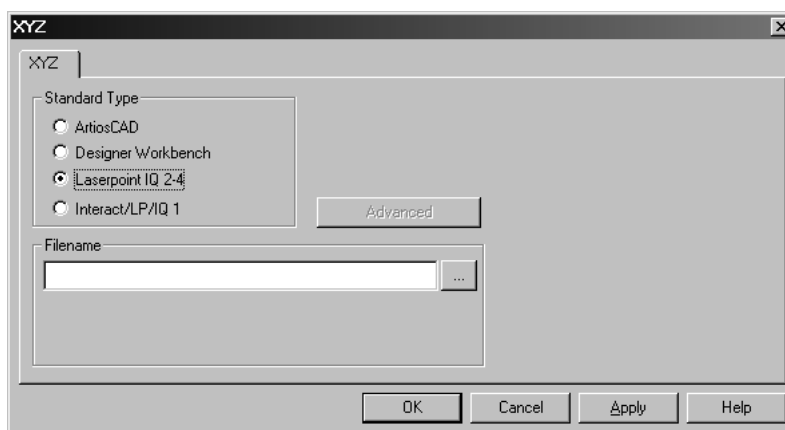

5. For LASERPOINT IQ 2-4 standards:

Type the name of the standard file without the W or GEOM suffix. In the example above with files XYZW and XYZGEOM, type XYZ.

For pre-LASERPOINT IQ2 standards:

Type the name of the standard.

If you don't know the name of the standard, click the ... button at the end of the **Filename** field. This will open the standard Open dialog box which you can use to navigate to the proper directory and open the file.
6. Click **OK** to close the dialog and save changes. ArtiosCAD will check the file and set the standard type automatically.

You are now ready to run the standard in ArtiosCAD.

Note: Move the standard to sub-folders in your style catalog if desired to give a more structured organization.

Troubleshooting newly-added INTERACT/LASERPOINT/ LASERPOINT IQ standards

Missing files

LASERPOINT IQ standards may be created based on other standards or attachments. You must copy the files for the standards to run in the ArtiosCAD environment. Any missing files will be shown in error dialog boxes when a standard is run. Remember to copy all the files – for example, if ATTACHGEOM is missing, you will also need the associated ATTACHW file.

Changing the framework

ArtiosCAD sets up a framework to execute the various types of INTERACT/LP/LASERPOINT IQ 1 standards. The framework settings are available by clicking the Advanced button.

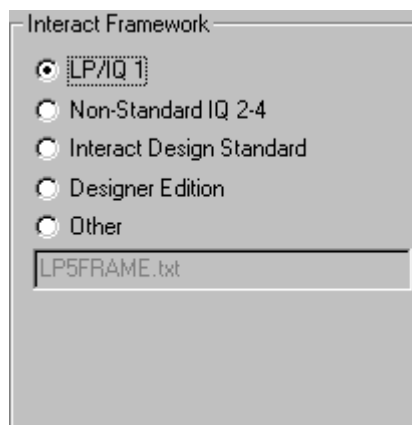

LASERPOINT IQ 2-4 standards may need to be set up using the INTERACT type if they used elements from before LASERPOINT IQ 2.0. This is set by changing to the standard type INTERACT/LP/IQ1, clicking **Advanced**, and selecting the framework **Non-standard IQ2-4**.

INTERACT/LP/IQ1 standards that fail to run properly can be tried with alternative frameworks by clicking **Advanced** and selecting one of:

- **LP/IQ1**
- **INTERACT design standard**
- **Designer Edition**

Adding Designer WorkBench designs to Style Catalogs

Preparation

Before you can add Designer WorkBench designs to a Style Catalog, ArtiosCAD needs to be told the location of the DWB resources. You will need to know the directories used for the DWB resources and then add these to the ArtiosCAD environment. The steps to do this are:

1. Start DataCenter Admin and double-click **Server**.
2. Check that there is a server set up for the drive letter where your DWB designs are located. Add a new server as necessary. For example, if your DWB designs are on the D: drive, click the Insert icon, give the new server a name and select **D:** as the server path. Click **Insert** to add the server.
3. Double-click **Resource**.
4. Do the following for each DWB resource:



Click the **Insert** icon, give the resource a name, pick the server and the path for the resource. Click **Insert** to add the resource.

5. When complete, save the changes and close DataCenter Admin.

Adding a Designer WorkBench standard to a Style Catalog

Any DWB design can be added to the ArtiosCAD Style Catalog by using the following procedure:

1. Start ArtiosCAD.
2. Click **Options** and **Defaults** to open the Defaults dialog box.
3. Use the right mouse button to click **Style Catalog** in Shared defaults and then click **New** and **Data**.
4. Type the descriptive name for the standard as you want it displayed in ArtiosCAD.
5. Double-click the icon beside the standard name to open the dialog for specifying the standard.
6. Click the ... button beside the data entry area for the design name. This will show the Open dialog.
7. Change to resource view, select the resource, and check you are showing designs of type either **All files** or **Designer Workbench Designs**.
8. Select the design and click **Open**.
9. Close the Defaults dialog box and save changes.

You are now ready to run the standard in ArtiosCAD.

Note: The standard can be moved to sub-folders in your style catalog, if desired, to give a more structured organization.

Default new design template

Each parameter set can now have a default single design template defined. This means that when you create a new single design by clicking **New Design** on the File menu, instead of getting a blank design, the standard you have associated with the parameter set will run and the new workspace will inherit the results.

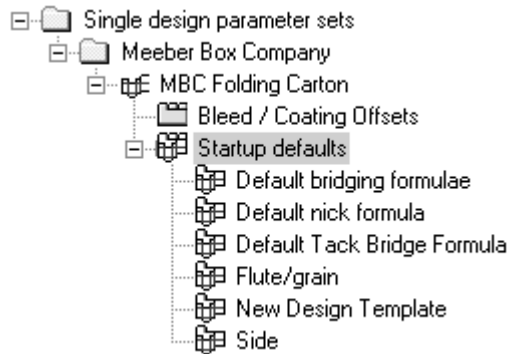

Double-clicking **New Design Template** opens the New Design Template dialog box for the current parameter set. Select the **Use Design Template** checkbox and choose a standard from one of the catalogs shown.

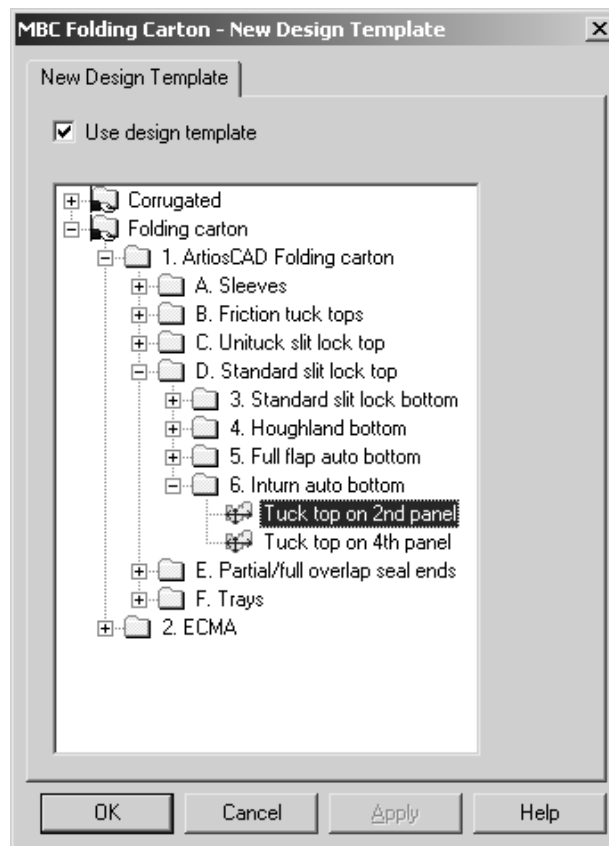

Only standards of type **ArtiosCAD** can be used as new design templates, so only those are listed in the dialog box. INTERACT, LASERPOINT, and LASERPOINT IQ standards may not be used as design templates.

The design template does not have to draw any geometry - you can simply set default variables, menus, and layers in it, and they will be copied into each new workspace made by the template.

Settings in the parameter set for the board code, bridging formula, sidedness, and property defaults take precedence over those settings in the template.

The design template is used only when explicitly creating a new single design. It is not used when creating a new embedded design in Manufacturing or when moving lines to a new design with the **Move To Layer** tool.

Default layers in Manufacturing

You can specify layers that will be created in new manufacturing files at creation and in existing manufacturing files when they are opened.

To do this, do the following:

1. Start ArtiosCAD and click **Options > Defaults > Startup defaults > Default MFG User Layers**. The empty Default MFG User Layers dialog box will open.

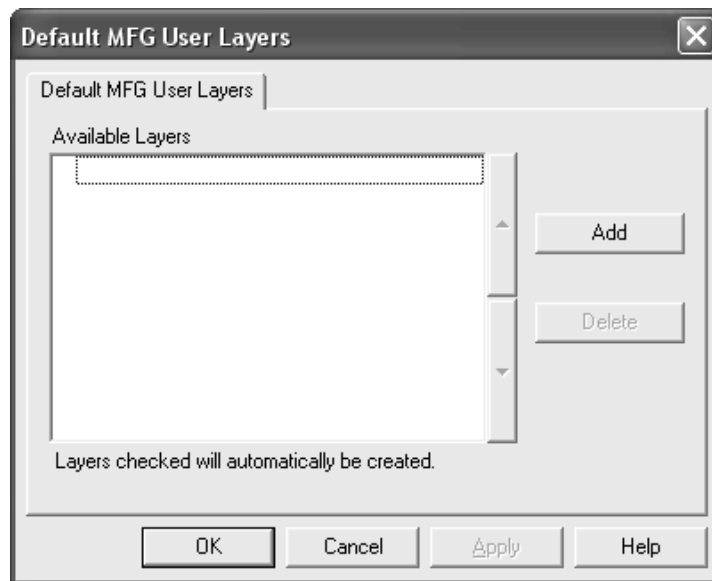

2. Click **Add** and enter the name of the new default layer in the New Default Manufacturing Layer dialog box. Click **OK** when done.

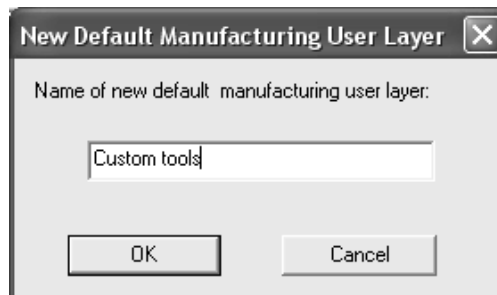

3. The new layer will appear in the dialog box already selected.

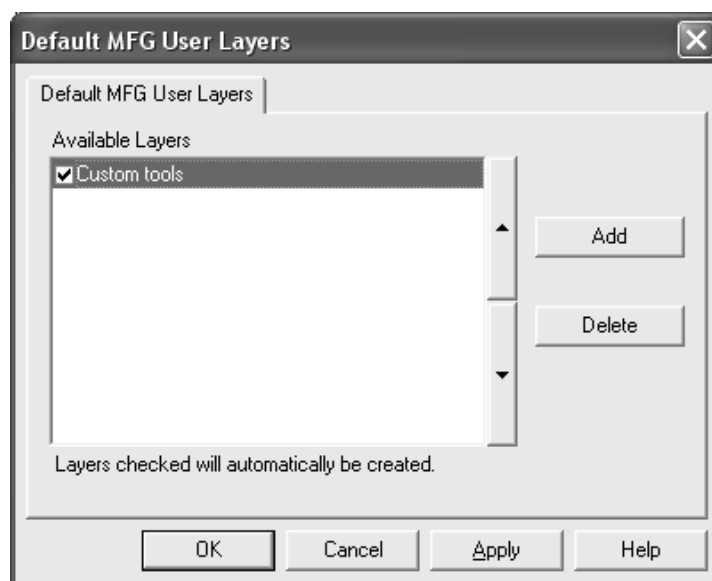

4. Continue adding layers as desired, clicking **OK** when done.
5. Save and exit Defaults.

Layers which are not selected are not created automatically; however, they are available for picking in the drop-down list box in the Create Layer dialog box in Manufacturing.

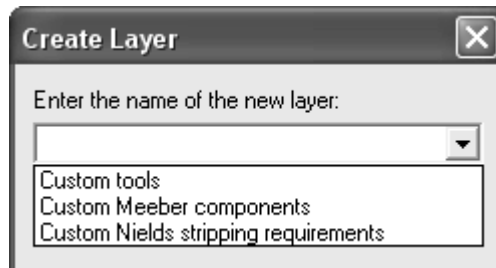

All of the default layers, whether created in the manufacturing file or not, will also be available for selection on the View tab of any Output when the **User Defined** layer set selection is active.

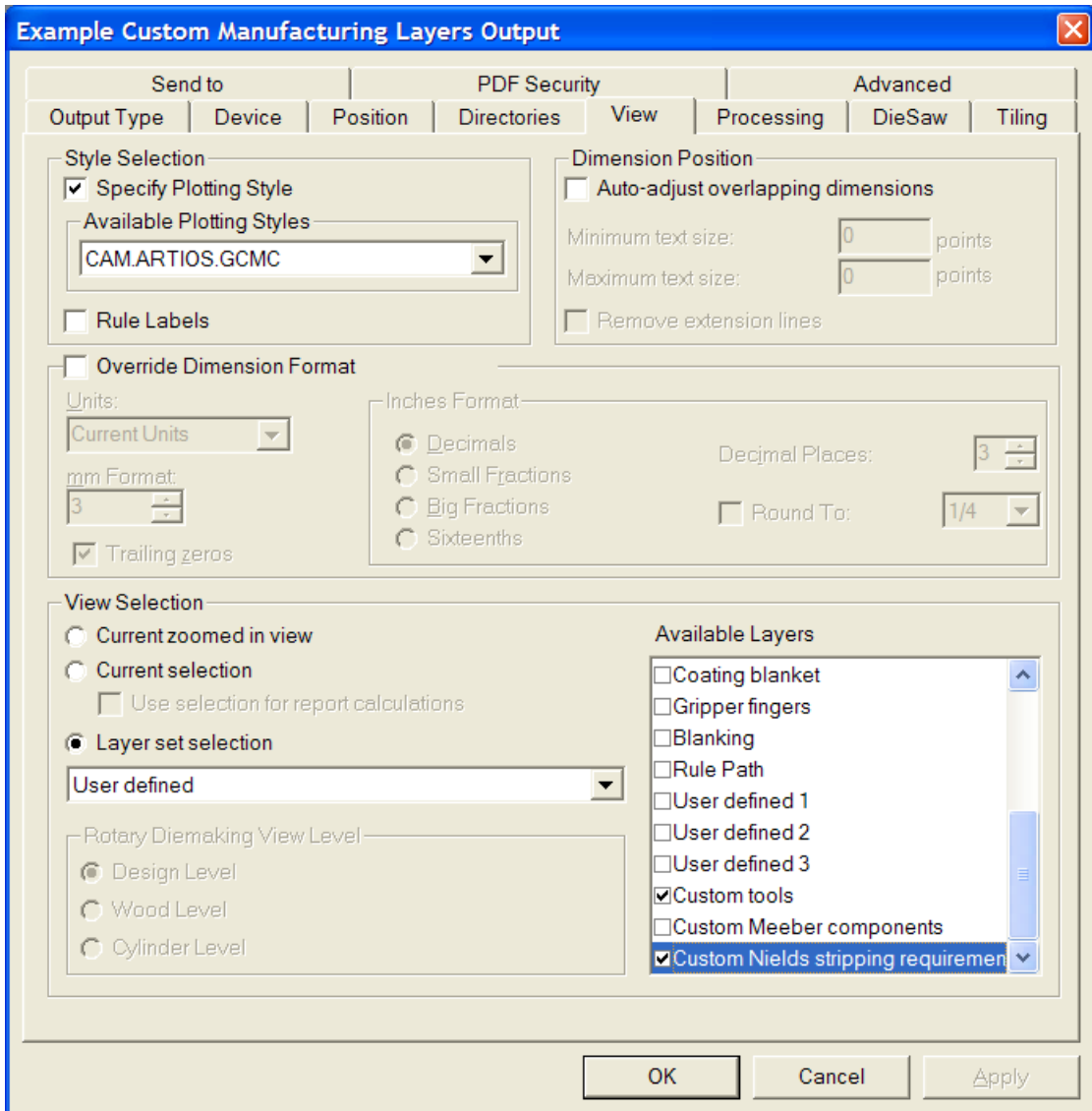

Toolbars

In ArtiosCAD you can change the background of toolbars and create customized toolbars to suit your needs. As with other Defaults, you can define toolbars either on a per-machine basis (User defaults) or on a server basis (Shared defaults). Customized toolbars can contain buttons for ArtiosCAD tools, geometry macros, Outputs, and menu commands.

Customized toolbars

Customized toolbars are managed by the Customized Toolbars catalog in Defaults. ArtiosCAD displays up to 30 customized toolbars in Single Design and canvases and 30 customized toolbars in Manufacturing, with each toolbar holding a maximum of 15 items. You can

define more than 30 customized toolbars per module, but ArtiosCAD will display a random assortment in the Customized Toolbars Master Control.

3D does not offer customized toolbars.

Each item on a customized toolbar must have a unique name. If there are items with the same name (for instance, one in Shared Defaults and one in User Defaults), ArtiosCAD executes the first one it finds when you click the button on the toolbar.

Shown below is the Customized Toolbars catalog in Shared defaults. The individual folders are empty until you create customized toolbars within them.

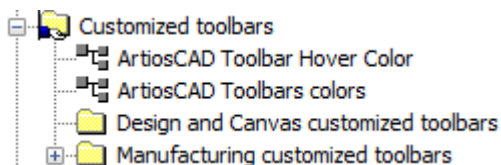

Single designs and canvases share the same customized toolbars, but the position and visibility can be different between them.

Icons for customized toolbars

By default, customized toolbars use the icon of a person's head. You may design your own icons for customized toolbars using 24-bit color. They must be 24 pixels high by 24 pixels wide in BMP format. Set the transparent color to R=192, G=192, and B=192. Icons for Shared defaults must be saved in **ServerLib**, while icons for User defaults must be saved in **ClientLib**.

Each geometry macro and Output can have a customized icon as well. Follow the same rules for them as those listed above for a customized toolbar icon. Specify the icon in the **Icon for custom toolbar** group in the Properties dialog box for the geometry macro, and in the **Icon for custom toolbar** group on the Output Type tab of the Output's Properties dialog box. If you changed the definition of an Output to specify a custom icon, save the changes, and then exit and re-enter Defaults for the changes to be shown.

You should create any desired icons before entering Defaults to create the customized toolbar.

Making a customized toolbar

Add custom geometry macros and Outputs to catalogs and save Defaults before making a customized toolbar. To make a shared customized toolbar, do the following:

1. Start ArtiosCAD and click **Options > Defaults**.
2. In the Shared defaults pane, click the plus sign (+) next to the Customized Toolbars catalog to open it.
3. Right-click the appropriate catalog, click **New**, and then click **Data** on the context menu.

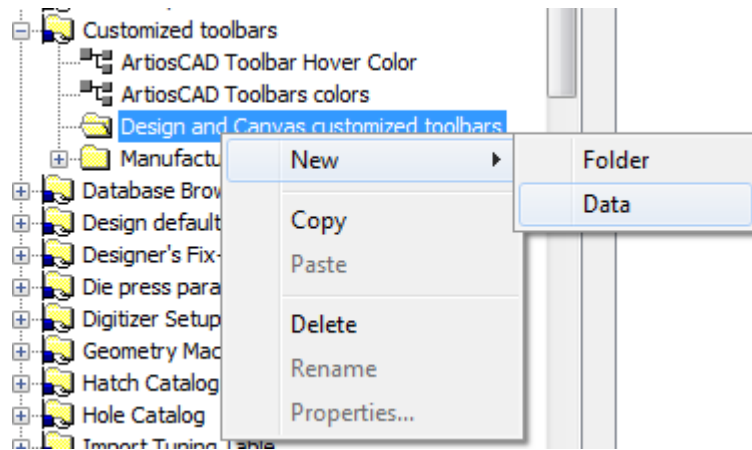

4. Replace **New Data 1** with the name of the new custom toolbar. Press Enter when you have entered the name and then double-click the new entry to access its Properties dialog box.

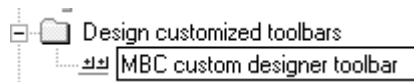

5. The Properties dialog box for the custom toolbar will appear.

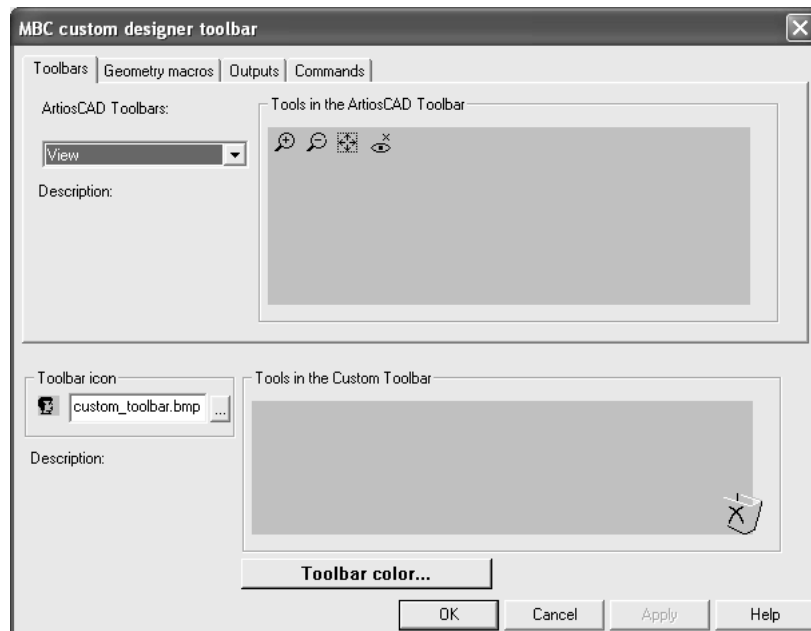

6. In the top half of the dialog box, choose the tab containing the item that will be replicated on the customized toolbar. Items from each category can be added to the same customized toolbar.

On the Toolbars tab, select the toolbar to copy from by using the **ArtiosCAD Toolbars** drop-down list box. On the Geometry Macros and Outputs tabs, expand the catalogs to access the individual geometry macros and Outputs. On the Commands tab, simply select the desired command.

7. Drag the desired tool, geometry macro, Output, or command from the top pane to the **Tools in the Custom Toolbar** group. Repeat as desired, putting up to 15 items on the customized toolbar. Shown below is act of dragging a command to the **Tools in the Custom Toolbar** group.

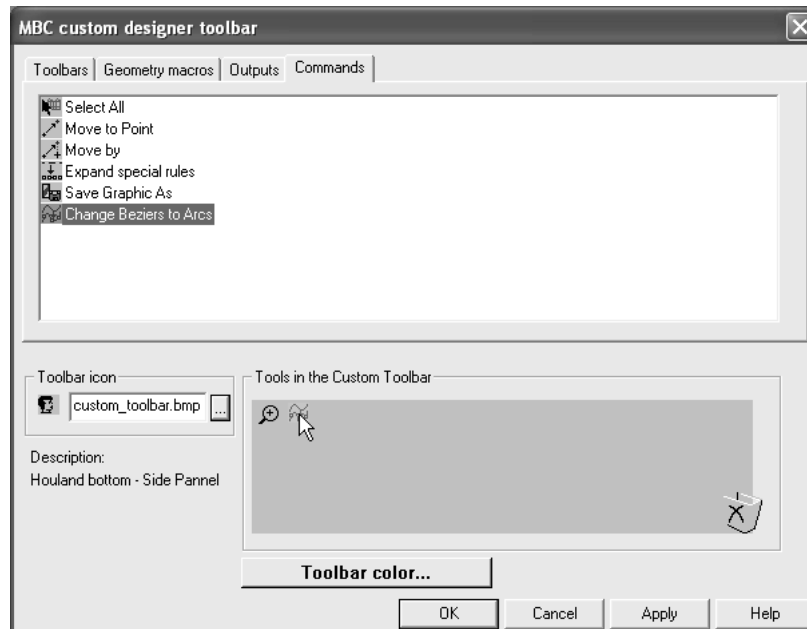

8. To change the icon used for this customized toolbar in the Customized Toolbars Master Control, enter the name of the icon file you created previously and placed in **ServerLib** in the **Toolbar Icon** group.

To create a customized toolbar for users of the current machine only, create a new Customized Toolbars catalog by right-clicking in the User defaults pane, clicking **New**, selecting **Customized toolbars**, and following the procedure above for Shared defaults.

To delete an item from a customized toolbar, drag it to the Recycle Bin icon at the bottom right of the **Tools in the Custom Toolbar** group.

To delete a custom toolbar, delete its entry from the catalog.

When adding an Output or a geometry macro to a toolbar, the number ArtiosCAD assigns the button will remain static and cannot be changed by deleting other buttons.

Note: The title of a customized toolbar may appear incorrectly after you save it. Undock and redock the toolbar or restart ArtiosCAD to fix it. It will appear correctly thereafter.

Colored toolbars

Each toolbar in ArtiosCAD can have a different background color to make it easier to identify. Color definitions in User defaults override those set in Shared defaults.

Colors on standard toolbars

To change the background color of a standard ArtiosCAD toolbar, do the following:

1. Start ArtiosCAD and click **Options > Defaults**.
2. Open the appropriate Customized toolbars catalog (either the one in Shared defaults or one in User Defaults) by clicking the plus sign (+) next to it.
3. Double-click **ArtiosCAD Toolbars colors**. The ArtiosCAD Toolbars colors dialog box will appear.

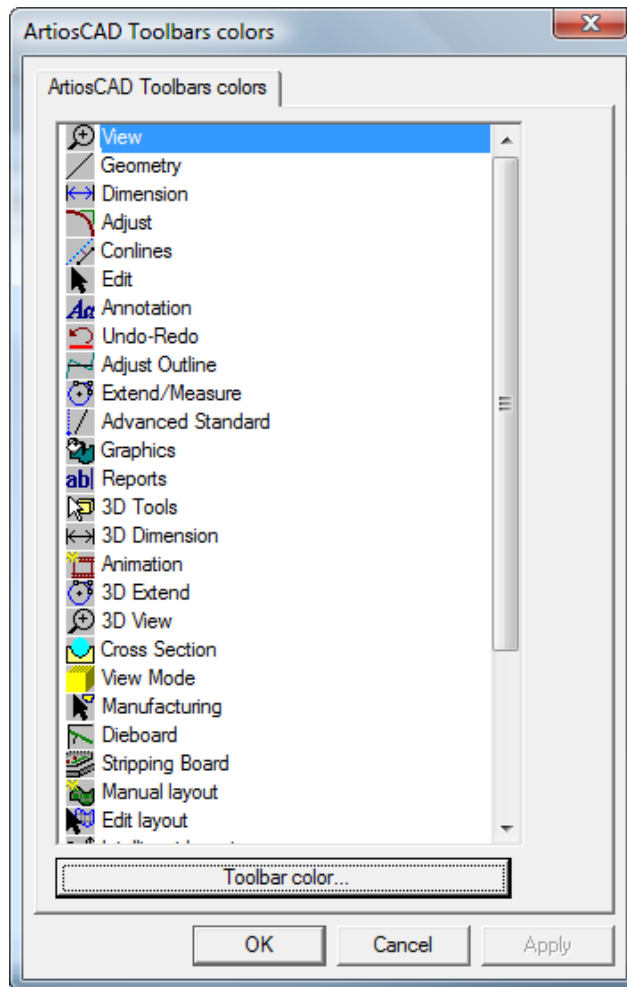

4. Click the button of the toolbar to change and click **Toolbar color** to open the Toolbar color dialog box.

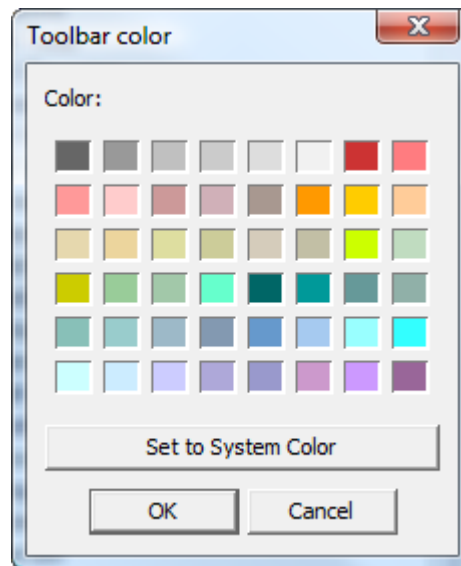

5. Click the color to set as the toolbar background and click **OK**.
To reset the toolbar background color to the default, click **Set to System Color** and then click **OK**.
6. The **Toolbar color** button in the ArtiosCAD Toolbars colors dialog box will change to the color you selected.
7. Repeat steps 4 and 5 as desired. When done, click **OK** to return to Defaults, or click **Cancel** to discard the changes.

Colors on customized toolbars

To change the background color of a customized toolbar, do the following:

1. Start ArtiosCAD and click **Options > Defaults**.
2. Open the Customized toolbars catalog (either the one in Shared defaults or one in User Defaults) by clicking the plus sign (+) next to it.
3. Open the Designer customized toolbars catalog or the Manufacturing customized toolbars catalog by clicking the plus sign (+) next to it.
4. Double-click the customized toolbar to change to open its Properties dialog box.
5. Click **Toolbar color**.

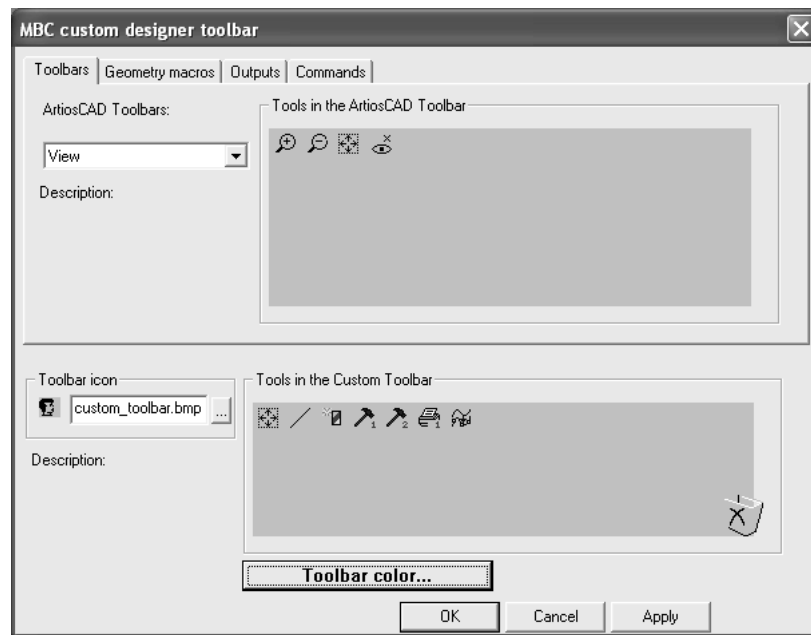

6. The **Toolbar color** dialog box will appear. Click the color to set as the toolbar background and click **OK**.

To reset the toolbar background color to the default, click **Set to System Color** and then click **OK**.

7. The **Toolbar color** button in the customized toolbar's Properties dialog box will change to the color you selected.
8. Repeat as desired for other customized toolbars. When done, click **OK** to return to Defaults, or click **Cancel** to discard the changes.

Toolbar Hover Color

The **ArtiosCAD Toolbar Hover Color** entry in the Customized Toolbars catalog sets the hover color and gradient use for the toolbars. ArtiosCAD shows the current hover color as the background of the Hover color button.

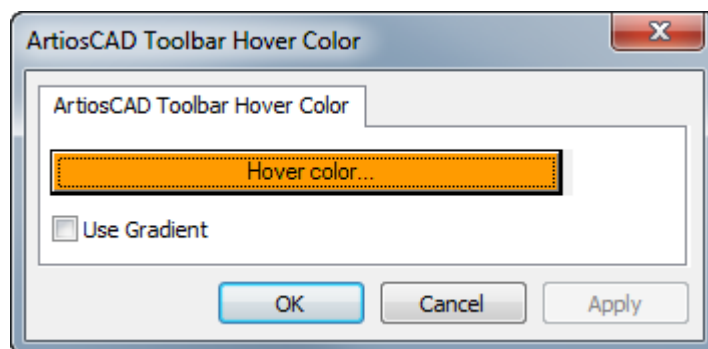

Clicking **Hover color** leads to a color palette in which you can choose a new hover color.

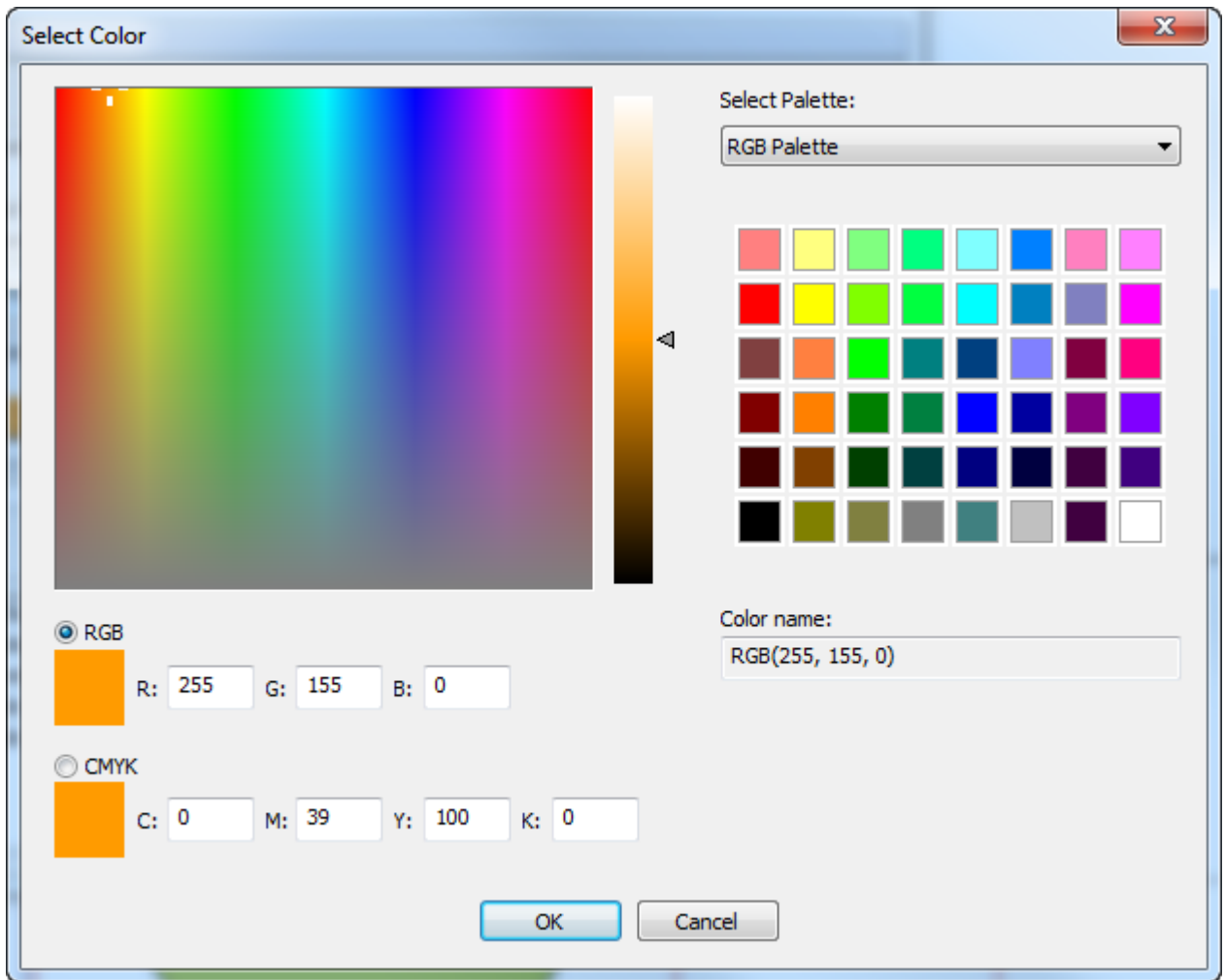

Use Gradient toggles the display of a gradient on the hover color. The gradient is not adjustable.

Shortcuts

Shortcuts are keyboard sequences that activate ArtiosCAD commands, such as pressing CTRL-N for a new single design workspace. Shortcuts are organized by where they are used: 3D, Design (single designs and canvases), and Manufacturing. Shortcuts can also be assigned to Outputs and geometry macros.

Every menu command can have a shortcut assigned to it.

Shown below are the categories for menu commands in the Shortcuts Catalog in Shared Defaults.

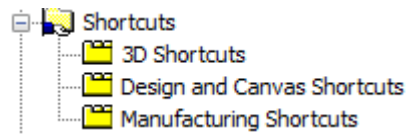

To create menu command shortcuts in User Defaults, right-click in the User Defaults pane, click **New**, and then click **Shortcuts**. A Shortcuts Catalog is created with the three entries for the types of menu command shortcuts. Save the User Defaults after creating the Shortcuts Catalog but before adding to it.

Assigning a shortcut to a menu command

To assign a shortcut to a menu command, do the following:

1. Start ArtiosCAD and click **Options > Defaults**.
2. Scroll down the list of Shared Defaults, and open the Shortcuts Catalog by clicking the plus sign (+) next to Shortcuts.
3. Double-click the category for the desired new shortcut. In this example, the **Direction** menu command on the View Options sub-menu of the View menu will be assigned a shortcut, so double-click the **Design and Canvas Shortcuts** category. The Design and Canvas Shortcuts dialog box opens as shown below.

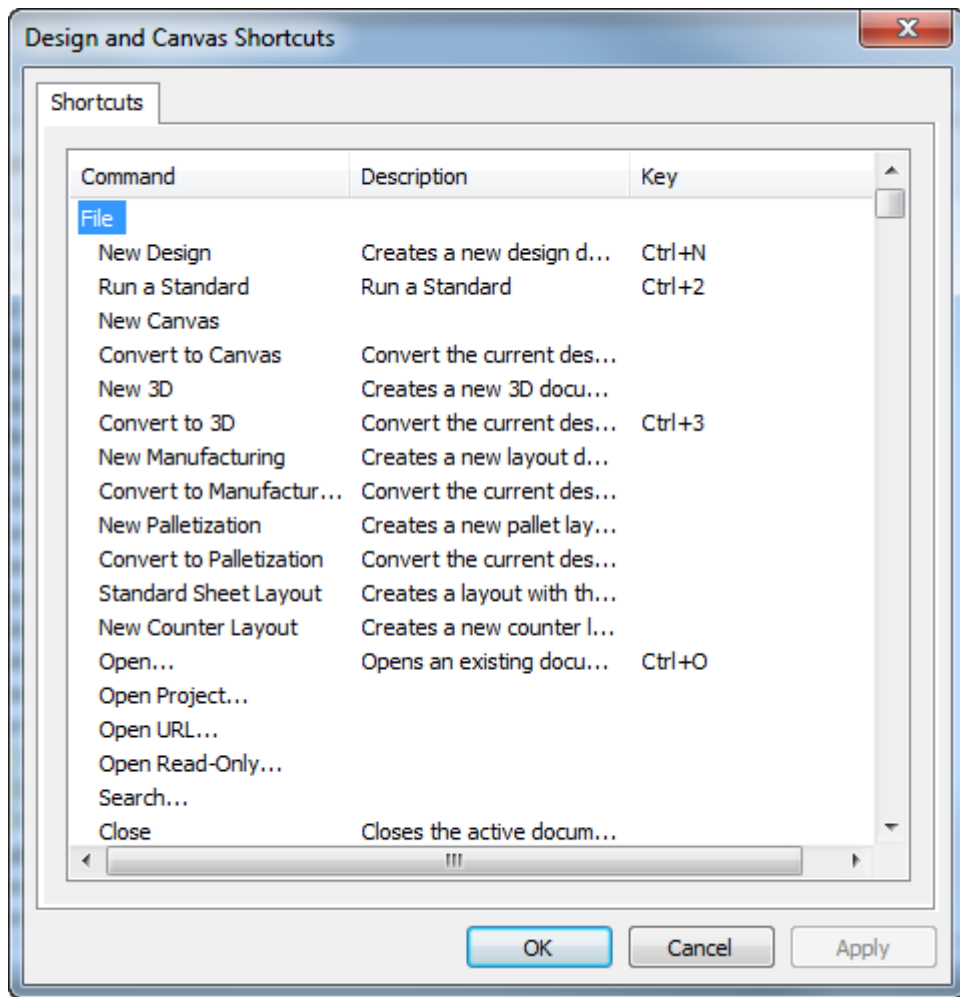

4. Scroll down to the View menu, and double-click **Direction** under View Options.

Command	Description	Key
Pan/Zoom Tool	Scrolls view in X and Y a...	
CloseUp	Creates a CloseUp	Ctrl+Space
Close All CloseUps	Closes All CloseUp wind...	Shift+Space
Extend	Adds handle point such ...	Alt+X
Clear Extend	Clears the handle points...	Ctrl+Alt+X
ArtiosCAD Toolbars...	Set the ArtiosCAD toolb...	
Customized Toolbars...		
Save Toolbar configura...		
Restore Toolbar config...		
View Mode...	Sets the plotting style a...	
View Options		
Bridges	Set bridges option on/of...	
Nick gaps	Set the nick gap option ...	
Crease cutback	Set crease cutback opti...	
Direction	Set direction option on/...	
Construction Lines	Sets Construction lines t...	
Snap Options		
Snap to middle points	Set on/off snap to middl...	
Use overrun, underrun	Set on/off use overrun,...	

- An empty Shortcut dialog box appears. Press the key combination to assign to the Direction command. For this example, press ALT-D. The key sequence and the command to which it will be assigned appear as you press it. The command is followed by the type of shortcut (**system** or **user**) and the area of ArtiosCAD in which it is active.



- Click **OK** to return to the Design and Canvas Shortcuts dialog box.
- Note that the newly-assigned command now appears in the **Key** column of the dialog box.

View Options		
Bridges	Set bridges option on/off...	
Direction	Set direction option on/o...	Alt+D
Construction Lines	Sets Construction lines to...	

- Click **OK** in the Design and Canvas Shortcuts dialog box.

9. Click **File > Save** to save the Shared Defaults. The new shortcut is now ready for use in Builder and Designer.

Assigning a shortcut to an Output

To assign a shortcut to an Output, open the Properties dialog box for that Output. Enter the shortcut in the **Shortcut:** group on the Output Type tab as shown below.

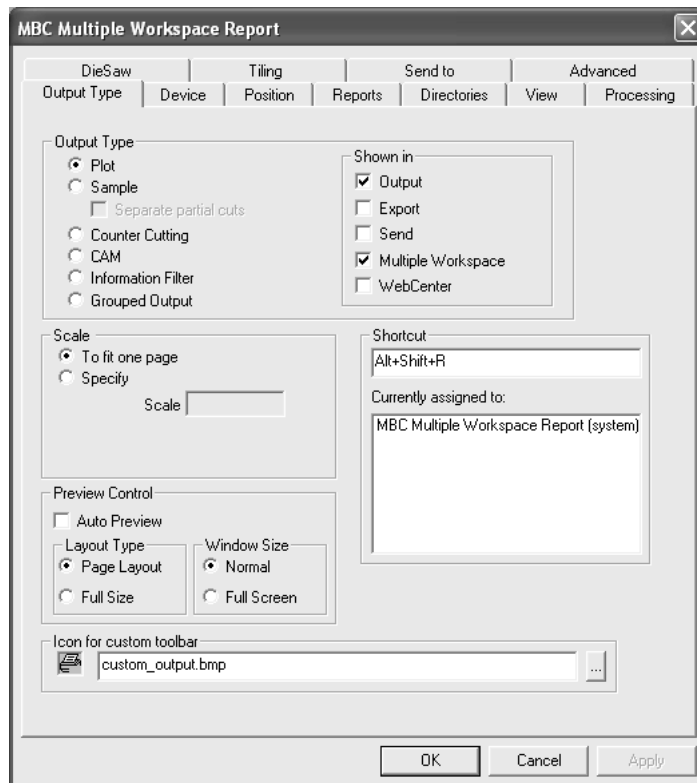

Assigning a shortcut to a geometry macro

To assign a shortcut to a geometry macro, open the Properties dialog box for that geometry macro and enter the shortcut in the **Shortcut:** group as shown below.

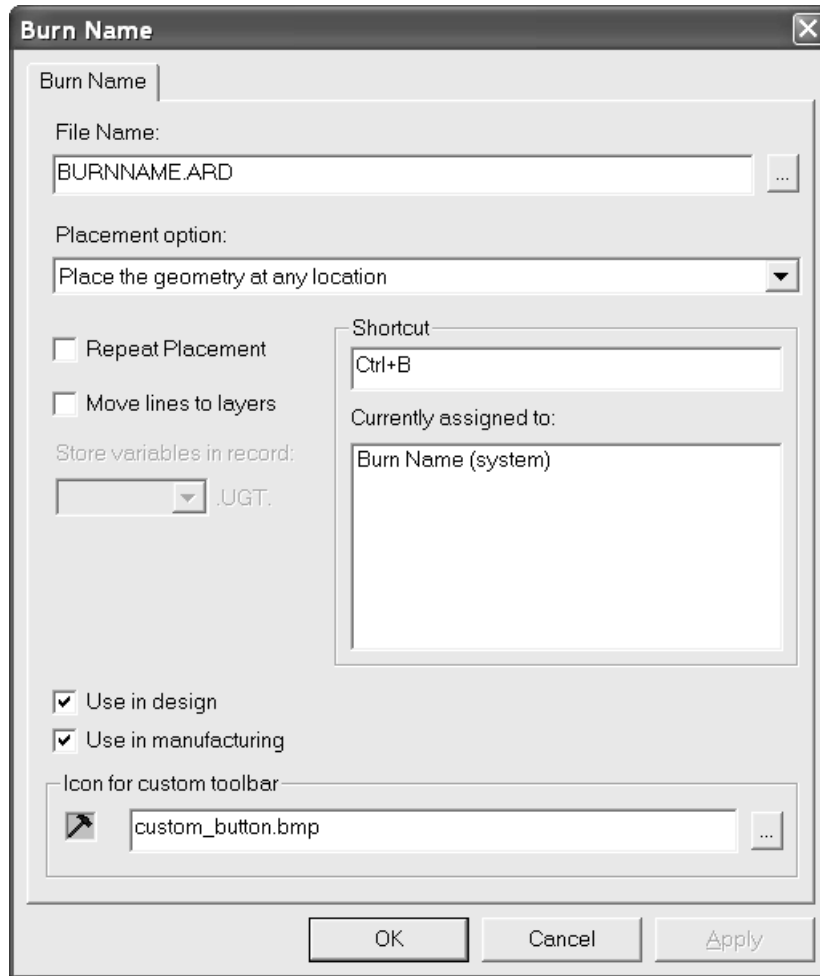

Shortcut uniqueness and priority

When a shortcut in Shared Defaults is assigned a key sequence, any other shortcuts having the same key sequence are shown. Only shortcuts in Shared Defaults and those in the current machine's User Defaults are compared. Shortcuts in other machines' User Defaults are not compared with those in the current machine's User Defaults.



The shortcut at the top of the list has the highest priority and will prevent other shortcuts assigned the same key sequence in the same module from working. However, if the other key sequences are in other modules, there will be no conflict when the shortcut is used.

Shortcuts in User Defaults take priority over those in Shared Defaults. Within User Defaults, menu items take priority over geometry macros, and geometry macros take priority over Outputs. If a shortcut is assigned to the same command in all three subcatalogs, the one in Design is listed first, then the one in Manufacturing, and finally the one in 3D.

Notes and warnings for Shortcuts

Always use an accelerator key (CTRL or ALT) when defining a shortcut with a letter. Not doing so will cause a conflict between the shortcut and StyleMaker.

Only the first 300 shortcuts defined for geometry macros are active.

Counter layouts use the same shortcuts as Manufacturing.

If the same shortcut is assigned to a menu item that displays in both single designs and canvases, it won't work in one of them, but which one is random and will change.

When a geometry macro has a shortcut, and this geometry macro is present on a customized toolbar, and the geometry macro opens a dialog box, the button on the customized toolbar is not depressed when the geometry macro is activated by the shortcut.

There is only one set of user shortcuts per machine.

If you change shortcuts and exit without saving the changes, the uniqueness tests for successive changes will not be accurate.

Enter can not be used as any part of a shortcut.

Some shortcuts are permanent as shown in the table below.

Table: Permanent Shortcuts

Command	Shortcut
Run Standard	CTRL-2
New 3D	CTRL-3
New Design	CTRL-N
File Open	CTRL-O
Help	F1
Next Pane	F6
Previous Pane	SHIFT-F6
Properties	ALT-Enter
Close CloseUp Window	SHIFT-Space
Restart current tool	ESC

Tack Bridging

Tack bridging formulae are stored in the Tack Bridging Catalog.

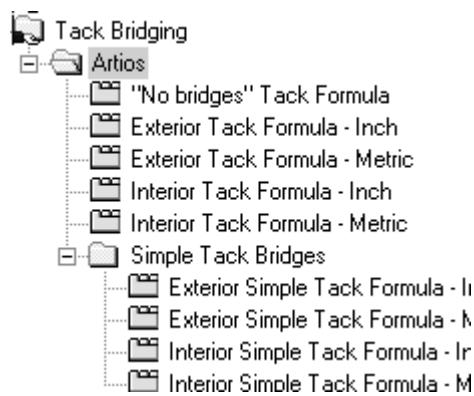

Shown below is a sample exterior metric formula.

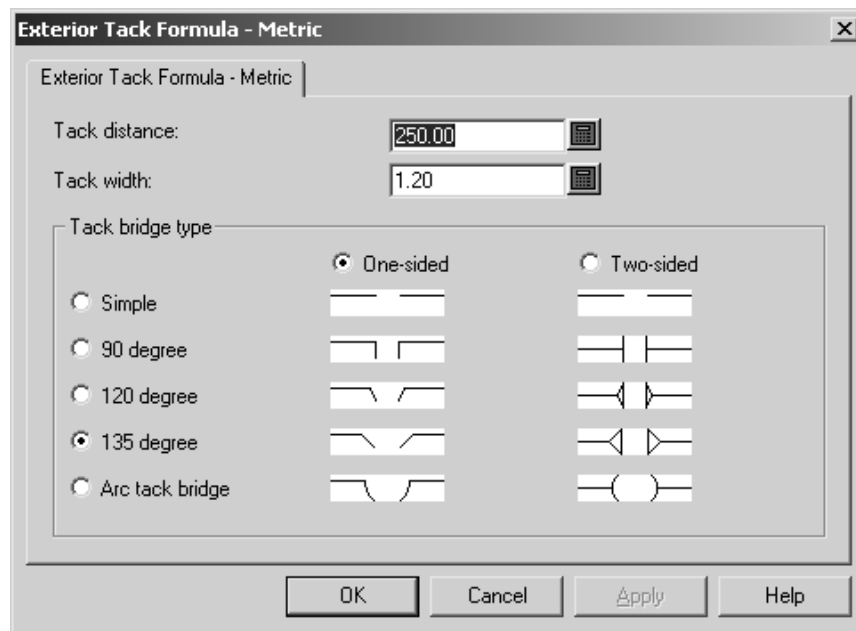

Set the distance between tack bridges in the **Tack distance:** field and set the width of each tack bridge in the **Tack width:** field.

The **One-sided** and **Two-sided** option buttons control if the tack bridges are cut only toward the interior of the carton or toward the interior of the carton and the exterior of the carton.

The **Simple**, **90 degree**, **120 degree**, **135 degree**, and **Arc tack bridge** option buttons all set the style of tack bridge as shown in the pictures in the dialog box.

Click **OK** to save the changes to the Tack Bridging formula and return to Defaults, or click **Cancel** to return to Defaults, discarding the changes.

Bridging Formulae

ArtiosCAD's default bridging formulae are stored in the Artios subfolder of the Bridging Catalog. There are corrugated and folding carton bridging formulae in Imperial and metric units. Shown below is the Corrugated - Metric bridging formula set for evenly spaced bridges.

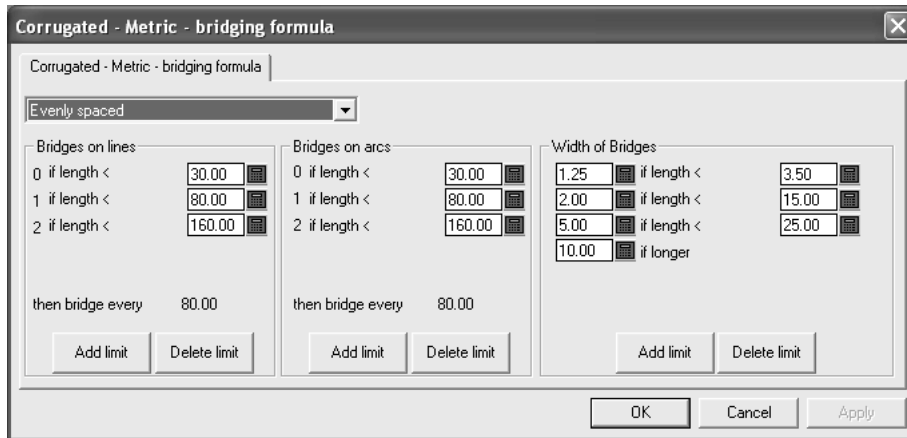

The drop-down list box controls all the other settings in this dialog box. The **No bridges** selection removes all other settings from the dialog box. **Evenly spaced** and **Inset distance from line end** are explained in the following sections.

Evenly spaced bridging formula

An **evenly spaced** bridging formula applies bridges based on the length of the line or arc. The size of the bridges is determined by the length of the line.

There are three groups of parameters in an evenly spaced bridging formula - **Bridges on lines**, **Bridges on arcs**, and **Width of Bridges**.

Bridges on lines and Bridges on arcs groups

The **Bridges on lines** and **Bridges on arcs** groups work similarly. A list of limits determines the number of bridges applied to lines or arcs. Shown below are the two groups in the Corrugated - Metric formula.

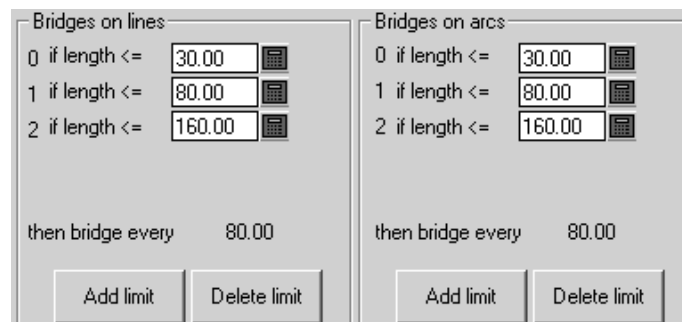

If the length of the line or arc is less than or equal to the value in the field, the integer to the left of the field is the number of bridges applied to the line or arc. If the length of the line or arc is greater than the value in the field, the limit is skipped and the next limit is applied. Click **Add limit** to add a limit; click **Delete limit** to delete a limit.

After all the limits are met, the lines and arcs are bridged according to the value shown after **then bridge every X.XX** where **X.XX** is the difference between the last two limits.

There must be at least one limit per group.

Width of Bridges group

The **Width of Bridges** group works slightly differently than the others in that there are two values to set per limit - the width of the bridge and length of the bridge for the limit.

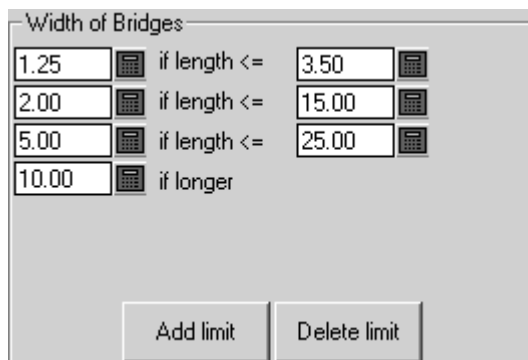

The length of the bridges will be the value on the left if the line or arc length is less than or equal to the length on the right.

Click **Add limit** to add a limit; click **Delete limit** to delete a limit. There must always be at least two limits - one **less than or equal** limit, and one **if longer** limit.

Inset distance from line end bridging formula

An **Inset distance from line end** bridging formula insets a bridge at each end of a line and then evenly spaces the bridges between the two that were inset.

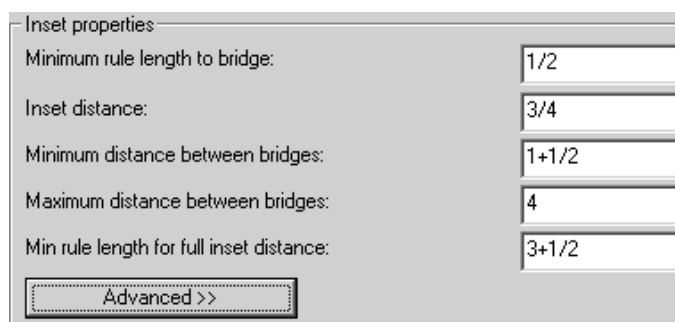

Rules shorter than the **Minimum rule length to bridge** will not be bridged. Rules whose length is between the **Minimum rule length to bridge** value and the **Min rule length for full inset distance** will have only one bridge. Rules longer than the value in **Min rule length for full inset distance** will have the two inset bridges, plus more bridges if the two inset bridges are further apart than the value in **Maximum distance between bridges**. The **Inset distance**

is the distance from the ends of the line to the centers of the inset bridges. Bridge centers can be no closer than the **Minimum distance between bridges**, and cannot be further apart than the **Maximum distance between bridges**.

The **Advanced** tab adds two parameters to the group:

Inset factor limit:	2
Inset factor:	0.285

These two fields are used when migrating bridging formulae from The Designer WorkBench into ArtiosCAD. Set the **Inset factor** to 0.285. The One Bridge Minimum equals the Minimum distance to bridge. The **Inset Factor Limit** is half the Maximum distance between bridges.

Inset Bridge Formula

If line length < One Bridge Minimum, no bridges

Calculate $BriSep = LineLength - 2 * InsetDistance$

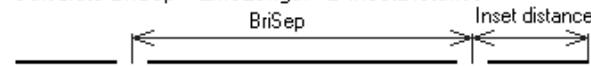

If $BriSep < \text{Minimum Distance to Bridge}$, 1 bridge centered

If $BriSep < \text{Inset Factor Limit}$, 2 bridges at $\text{InsetFactor} * \text{length}$

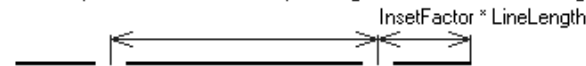

If $BriSep > \text{Maximum}$, add additional bridges, evenly spaced



Else two bridges at inset distance

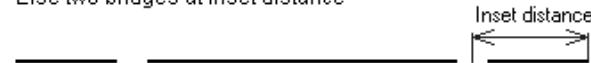

The options in the **Width of Bridges** group work the same for Inset formulae as they do for Evenly spaced formulae.

Working with tuning catalog entries in Defaults

You will most likely need to create your own tuning catalog entries for PDF or DWG/DXF files as each supplier may produce them differently. The procedures for working with DWG/DXF tuning files are the same as they are for PDF files; substitute the type of file you are working with as appropriate. Follow the instructions below to work with tuning catalog entries.

Creating a PDF vector import tuning catalog entry

ArtiosCAD comes with two example tuning files for importing PDF files as lines. However, since people can create PDF files in many different ways, you may need many different tuning catalog entries to accommodate them.

To create a new PDF vector import tuning file, do the following:

1. Log in as Administrator or as a user with administrative privileges.
2. Start ArtiosCAD.
3. Click **Options > Defaults**.
4. In the **Shared defaults** pane, scroll down the list to **Import Tuning Table**. Optionally, expand it by clicking the plus sign (+) next to it.
5. Right-click **Import Tuning Table** (or a folder underneath it if you expanded the catalog) and click **New > Data** on the context menu.
6. In the **Select import type** list box, select **PDF** and click **OK**.
7. Enter a name for the new tuning file and press **Enter**.

A tuning catalog entry has been created with specified name.

Opening a PDF vector import tuning catalog entry

To open a PDF vector import tuning file for editing, do the following:

1. Start ArtiosCAD.
2. Click **Options > Defaults**.
3. In the **Shared defaults** pane, scroll down the list to **Import Tuning Table**.
4. Expand the catalog and double-click the name of the tuning entry to open for editing.

A dialog box appears showing the tuning for this catalog entry.

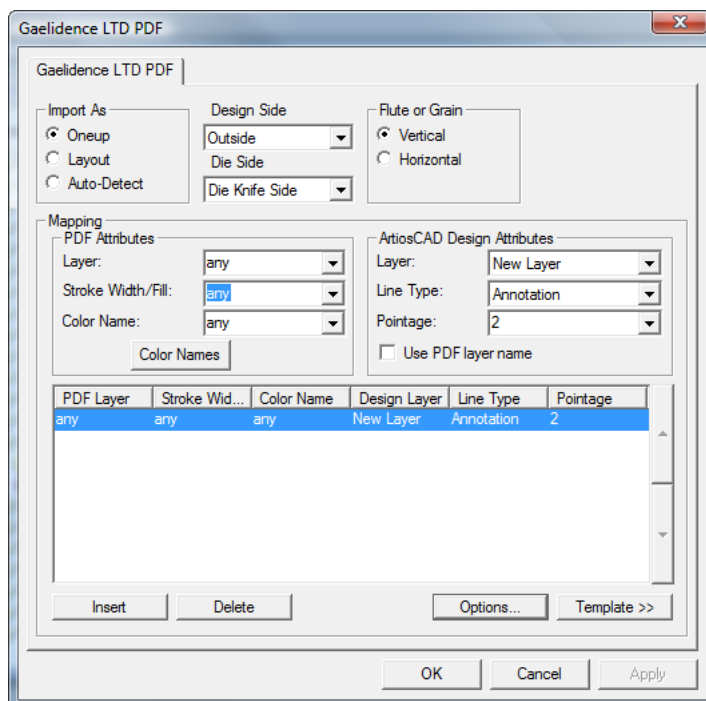

Editing a PDF vector import tuning catalog entry using a template

This procedure requires knowledge of the existence and design of the layer structure of your incoming PDF files. PDF files can have layers but also can be flattened (when all elements are in one layer). Ask the senders of PDF files about the layer structure they use, or examine them in a program that can edit PDFs, such as Adobe Illustrator. If the files are coming from Adobe Illustrator, and you want the layer information to be preserved, the **Create Acrobat Layers from Top-Level Layers** option must be selected when saving the file in PDF format, otherwise the file will be flattened and no layer information will be preserved.

To edit a PDF vector import tuning catalog entry, start ArtiosCAD and follow the instructions in *Opening a PDF vector import tuning catalog entry* to open it.

Once you have the tuning catalog entry open, set the options according to the procedure described below.

1. In the **Import As** group, select either **Oneup**, **Layout**, or **Auto-Detect**. **Oneup** means that this tuning catalog entry will always be used with PDF files containing single designs. **Layout** always processes the PDF files as if they contain multiple single designs. **Auto-Detect** reads the geometry of the vectors and process the file appropriately.

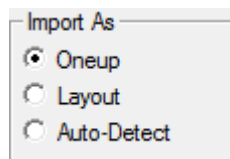

2. Set the **Design Side** and **Die Side** list boxes to appropriate values (**Inside** or **Outside** and **Die Back Side** or **Die Knife Side**) for the incoming PDF data.
3. In the **Flute or Grain** group, choose either **Vertical** or **Horizontal** for the direction of the material used to manufacture the workspace.

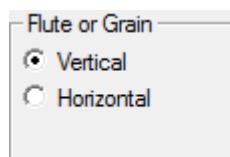

4. The controls in the **Mapping** group determine how ArtiosCAD converts vectors from the PDF data into design lines. The easiest way to set this up is to use an existing PDF file as a template. You may need to do this for each supplier of PDF files (in separate tuning files) depending on the software they use to create them.

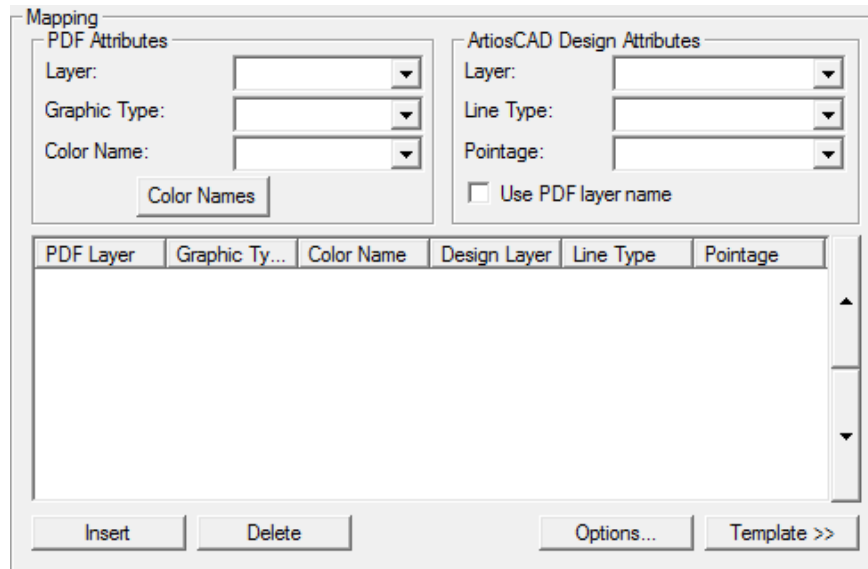

5. Click **Template**.
6. Select the PDF file to use as a template and click **Open**. If the PDF file contains more than one page, select the page to use as the template.
7. In the preview image, select a line and then set what it should be in the ArtiosCAD Design Attributes group. In the example below, the edge was selected and set to be cut lines in the Main Design layer at pointage 2. The **Zoom** controls above **Apply** and **Help** let you change the view so you can select the lines you need to tune more easily.

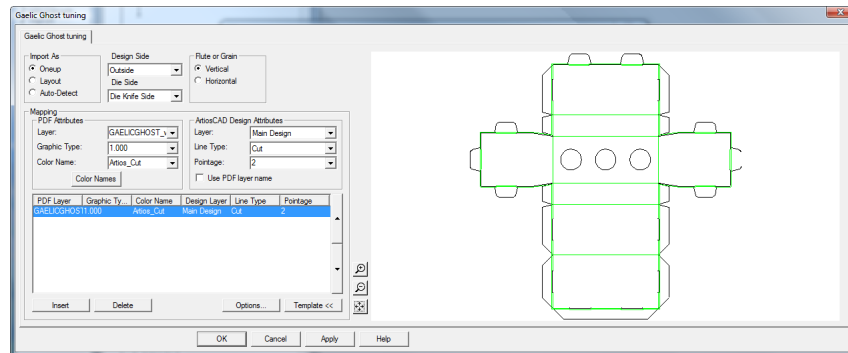

8. Continue selecting lines in the preview and defining their properties in the **ArtiosCAD Design Attributes** group. If you make a mistake, select a line of tuning and click **Delete**. ArtiosCAD applies the tuning entries in a top-down order. In the example above, it will set all the lines with color `Artios_cut` to be Cut lines, and then it will set all the lines with color `Artios_crease` to be Crease lines. Shown below is the same dialog box as above with more line types tuned. You can change the processing order by selecting a line of tuning and clicking the up and down arrows at the edge of the group control.

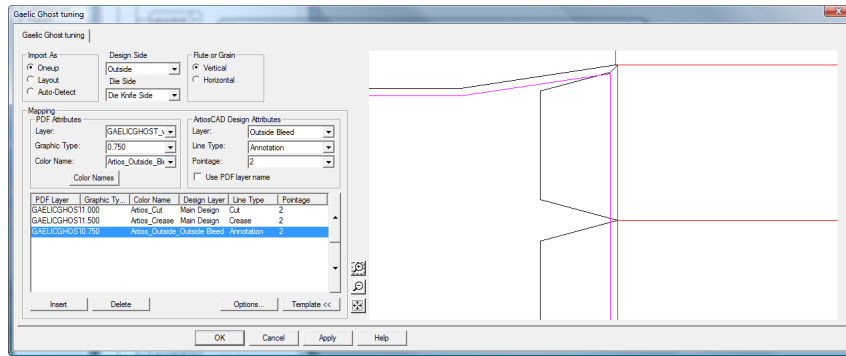

9. After you have finished selecting all the lines in the preview to tune, click **Insert** to add a final line of tuning. This final line of tuning will send all lines that are not explicitly tuned to the Annotation layer as 2-point Annotation lines.
 - a) For this final line of tuning, set the controls in the **PDF attributes** group to **any, any, and any**.
 - b) In the **ArtiosCAD Design Attributes** group, set the **Layer** to **Annotation**, the **Line type** to **Annotation**, and the **Pointage** to **2**.
10. Click **Color Names** to change the names of the colors coming in from the tuning template. In the **Color Names** dialog box, you can rename an existing color by selecting it and changing the **Name:** field. For example, if you have a color defined as 100% magenta, 30% yellow, and 15% black, you could select it and rename it reddish. You can also insert and delete color definitions as desired using **Insert** and **Delete**, but selecting lines in the template is the intended way of inserting color names initially.
 - a) There are two colors with special meaning. **White** matches all paths that have no color assigned or that have 0% for all components. **Uncolored** matches all paths that are not rendered in the PDF file, such as guides and clipping paths.
11. Click **Options** to open the **PDF Import Options** dialog box.

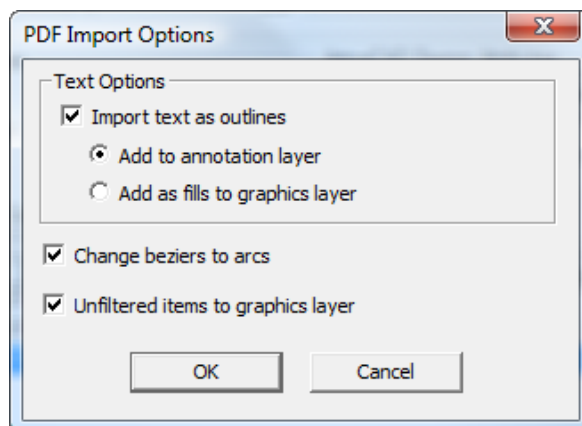

- a) **Import text as outlines** controls if text is imported or ignored and also controls the availability of the two sub-options. **Add to annotation layer** adds the text as outlines to an Annotation layer using the Annotation line type. **Add as fills to graphics layer** adds the text to a Graphics layer and fills it with the font color specified in the PDF file.

- b) **Change beziers to arcs** changes beziers to arcs during the import process instead of having to use the tool later.
 - c) **Unfiltered items to graphics layer** sends strokes and fills that were not processed by a tuning entry to the Graphics layer.
 - d) Click **OK** to return to the tuning dialog box.
12. Click **OK** to complete the editing of the tuning catalog entry and return to Defaults.
 13. Click **File > Save** to save the changes to Defaults.
 14. Click **Yes** to confirm overwriting Defaults.

Editing a PDF vector import tuning catalog entry manually

If you do not configure the PDF line type mapping using a template as described in the previous section, configure it manually by following the instructions below.

Once you have the tuning catalog entry open, set the options according to the procedure described below.

1. In the **Import As** group, select either **Oneup**, **Layout**, or **Auto-Detect**. **Oneup** means that this tuning catalog entry will always be used with PDF files containing single designs. **Layout** always processes the PDF files as if they contain multiple single designs. **Auto-Detect** reads the geometry of the vectors and process the file appropriately.

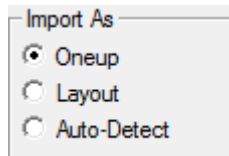

2. Set the **Design Side** and **Die Side** list boxes to appropriate values (**Inside** or **Outside** and **Die Back Side** or **Die Knife Side**) for the incoming PDF data.
3. In the **Flute or Grain** group, choose either **Vertical** or **Horizontal** for the direction of the material used to manufacture the workspace.

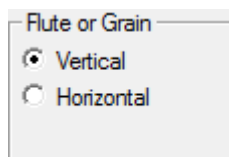

4. The controls in the **Mapping** group determine how ArtiosCAD converts vectors from the PDF file into design lines.
 - a) In the **PDF Attributes** group, **Layer:** selects the layer in the PDF file containing the lines to process for import into ArtiosCAD.
 - b) **Graphic Type:** can be a few different choices. **Any** is any stroke, fill, or bitmap. **Any_stroke** matches any stroke and **fill** matches any fill. Any positive number is a stroke width.
 - c) The **Color Names:** field and corresponding dialog box are meant for use when defining tuning using a template. Ignore them when setting tuning manually.

- d) In the **ArtiosCAD Design Attributes** group, set the **Layer:**, **Line Type:**, and **Pointage:** fields to the type of ArtiosCAD line that will be created for each line that matches the parameters set in the **PDF Attributes** group. **Use PDF layer name** names the ArtiosCAD layer the same as the PDF layer.
 - e) The mapping entries are processed in a top-down order. To change the order, select an entry, then use the up and down arrows at the side of the control to move the selected entry.
5. After you have finished selecting all the lines in the preview to tune, click **Insert** to add a final line of tuning. This final line of tuning will send all lines that are not explicitly tuned to the Annotation layer as 2-point Annotation lines.
- a) For this final line of tuning, set the controls in the **PDF attributes** group to **any, any,** and **any.**
 - b) In the **ArtiosCAD Design Attributes** group, set the **Layer** to **Annotation**, the **Line type** to **Annotation**, and the **Pointage** to **2.**
6. Click **Options** to open the **PDF Import Options** dialog box.

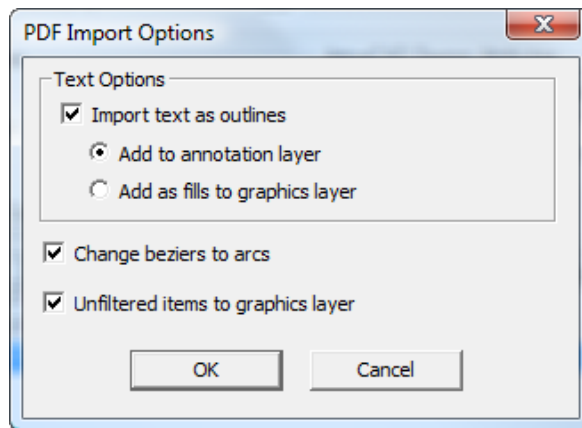

- a) **Import text as outlines** controls if text is imported or ignored and also controls the availability of the two sub-options. **Add to annotation layer** adds the text as outlines to an Annotation layer using the Annotation line type. **Add as fills to graphics layer** adds the text to a Graphics layer and fills it with the font color specified in the PDF file.
 - b) **Change beziers to arcs** changes beziers to arcs during the import process instead of having to use the tool later.
 - c) **Unfiltered items to graphics layer** sends strokes and fills that were not processed by a tuning entry to the Graphics layer.
 - d) Click **OK** to return to the tuning dialog box.
7. Click **OK** to complete the editing of the tuning catalog entry and return to Defaults.
8. Click **File > Save** to save the changes to Defaults.
9. Click **Yes** to confirm overwriting Defaults.

Line types

Line types:

- Distinguish between rules for flat dies and rules for rotary dies.
- Distinguish between lines which should be burnt on their outer edge (such as the die wood edge) and those which should be burnt on their inner edge (such as lower stripping holes).
- Support pointage of 1.5.

Line information in older workspaces will be automatically converted with no loss of information when the workspaces are opened in ArtiosCAD.

The category in which a line type resides determines its properties and also how it is processed during output. Of particular note are the **Inside Edge** and **Outside edge** categories. When line types belonging to these categories are output to a laser, they are offset to compensate for their thickness. Tool outlines must form complete loops for the direction of the offset to be well defined. Line types in the **Center Edge** category have no offset - the laser beam burns down their middle.

Only rules should have bridges defined, and only tool outline line types should have tack bridges. Other line types should be created without bridges. Only cut lines should have nicks.

Table: Line Type Categories

Line type category	Examples	Properties / Notes
Generic rules	Cut, crease, reverse crease, glue assist, balance rules, chop knives	Width, bridges, subtype
Rules	1/8 x 1/8 perf, 1/4 x 1/4 cut/crease, zipper rule, punch hole, side bevel cut, specific rotary cut rule. Defined in the rule table.	Width, Bridges, Generic type, height, name, rule geometry, rotary teeth spacing
Center edge	Unknifed diecut, unknifed lower, unknifed upper	Width, tack bridges, subtype
Inside edge	Lower stripping hole, Die registration hole	Tack bridges, subtype. Offset is applied inward during laser output.
Outside edge	Die edge, Lower stripping edge, stripping block	Tack bridges, subtype. Offset is applied outward during laser output.
Etch	Die etch, lower stripping etch, upper stripping etch	Subtype. No offset applied during laser output.
Laser output	Tool 1, Tool 2, Tool 3, .. increased from 20 to 30 laser line types.	None. Laser output will pass beam width for DDES,CFF2
Annotation	Annotation, Print image, Print registration, Bleed, Varnish	None
Sample output	Sample cut, sample partial cut, sample with grain crease, sample cross grain crease	None

Line type category	Examples	Properties / Notes
Counter output	With grain channel, Cross grain channel, Crease end tool, Periphery tool	None

Subtypes

A **subtype** is a definition to further classify a type of line - it is a label only and is used for sorting the tool assignment data when performing a CAM Output. Subtypes can have their own entries in Advanced plotting styles. Up to 100 subtypes can be defined in the Subtype Mapping Catalog.

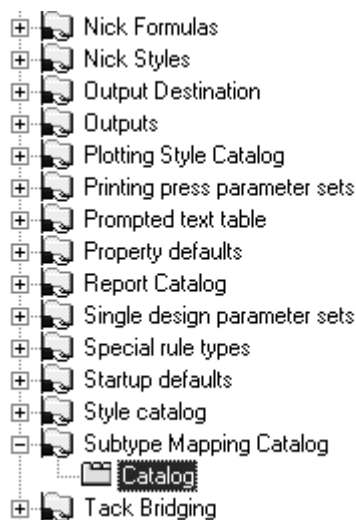

To define a subtype, select it, and enter the description of the subtype in the **Description:** field. Repeat as desired, and when done, click **OK** to save the definitions or **Cancel** to ignore them and return to Defaults.

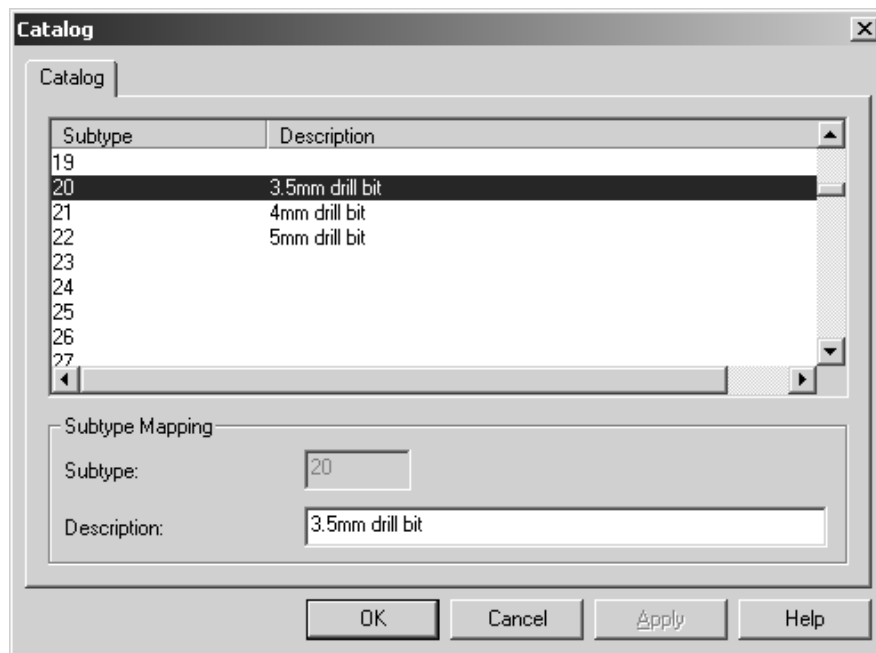

Plotting Styles

Plotting styles control the appearance of lines on screen and how lines are drawn or made on printers, plotters, samplemakers, and counter cutters. Plotting styles control the colors, widths, and styles used. They also control which physical tool an output device uses to construct the line.

Note: Plotting styles are not used to configure CAM outputs such as lasers and Kongsberg DieSaws; output to those types of devices is configured using the CAM Tooling Setup catalog.

Each plotter, samplemaker, and counter cutter should have its own plotting style configured as each has a different tool configuration. Most known output devices have plotting styles defined in the example CAM Outputs. To view the example CAM Outputs, open the example Defaults by selecting User Defaults, then clicking **File > Open > Example Defaults**. Expand the Plotting Style Catalog in the Example defaults pane, find the one you want, and drag it into the Plotting Style Catalog in the Shared defaults pane. The names may contain CAM, but rest assured these are for plotters, samplemakers, and counter cutters.

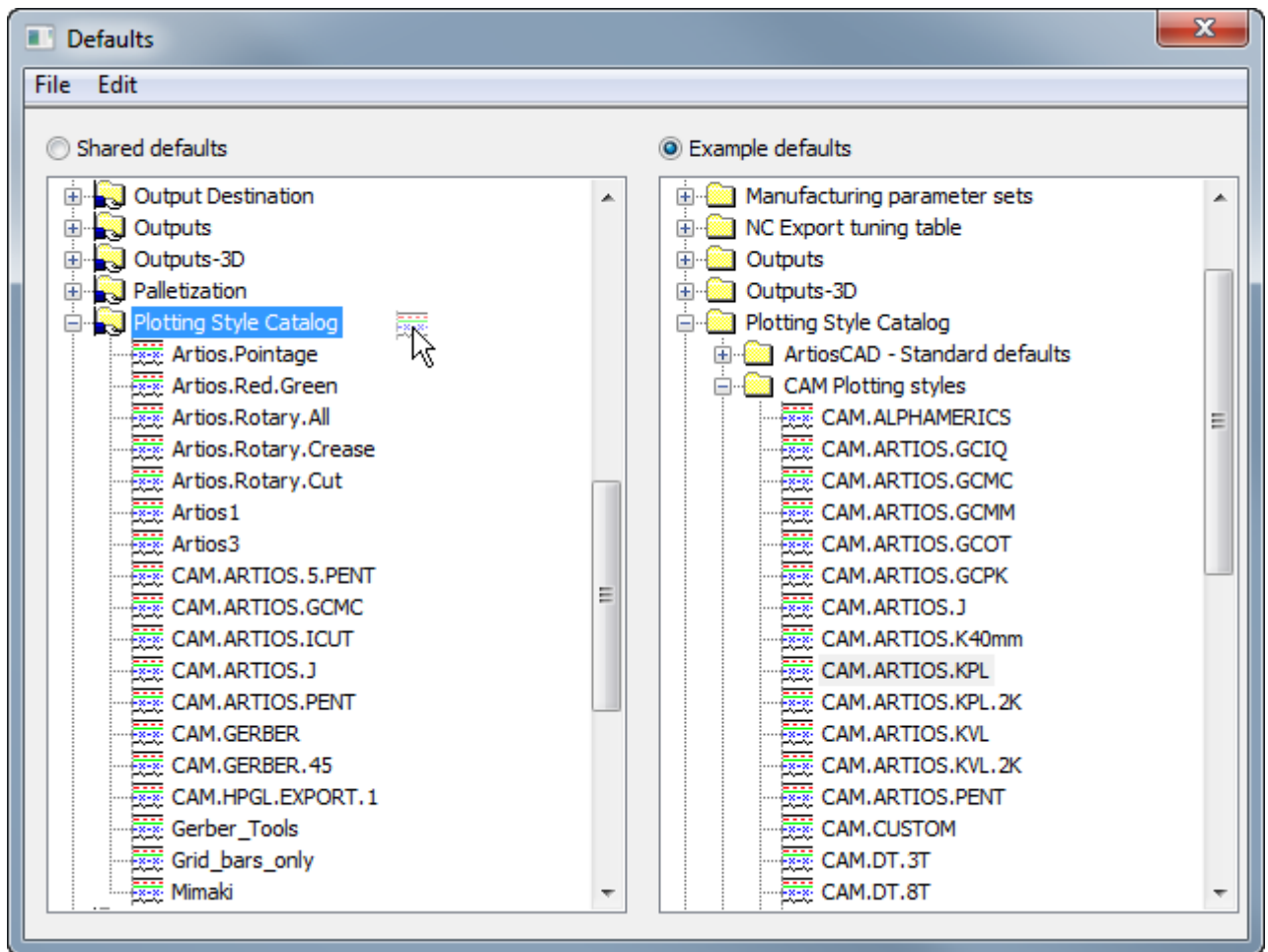

Plotting styles may be either **simple** (the default) or **advanced**. Simple plotting styles configure the line color, line width, line style, and tool number based solely on a line type. Advanced plotting styles do the same configuration, but can be based on line type, subtype, and pointage instead of just line type. An Advanced plotting style can not revert to a Simple plotting style.

Working with simple plotting styles

When the **Advanced** checkbox in the Line Types group is clear, the current plotting style is considered **simple**. In a simple plotting style, the line types are organized on five tabs - **Design**, **Manufacturing**, **Sample**, **Tooling**, and **Counter**.

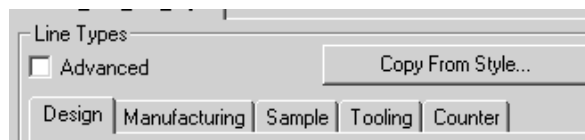

On each tab are the line types relevant to each label. For examples, the **Design** tab lists such types as **Cut**, **Crease**, **Partial cut**, and so forth. The **Manufacturing** tab contains line types

used in the Manufacturing module, such as **Stripping Rule**, **Die board edge**, and **Unknifed blanker**. The same is true for the other tabs.

When looking at the line types, shown first is the line type name, then an example of the line type using the attributes selected in the right pane, and finally the tool number. When creating a new plotting style, all the tool numbers are set to zero by default.

Cut		0
Crease		0
Partial cut		0
Reverse partial cut		0
Reverse crease		0
Half crease		0
Unknifed diecut		0

Creating a new simple plotting style

To create a completely new simple plotting style, do the following:

1. Right-click the **Plotting Style Catalog** entry in Defaults and click **New > Data** on the context menus that appear.

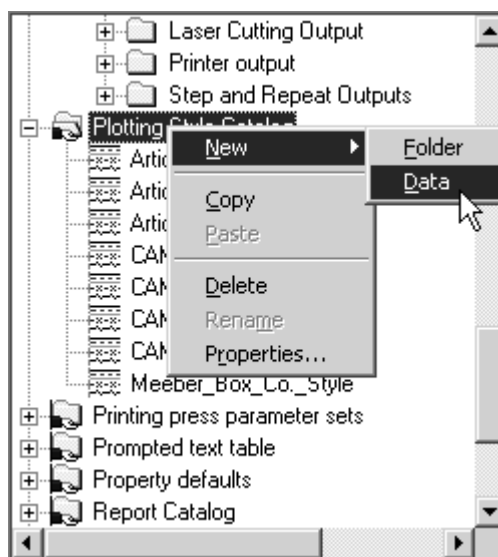

2. Enter a name for the new plotting style and press ENTER.
3. Double-click the style to access its property page in order to change its defaults. The window should appear similar to the one shown below.

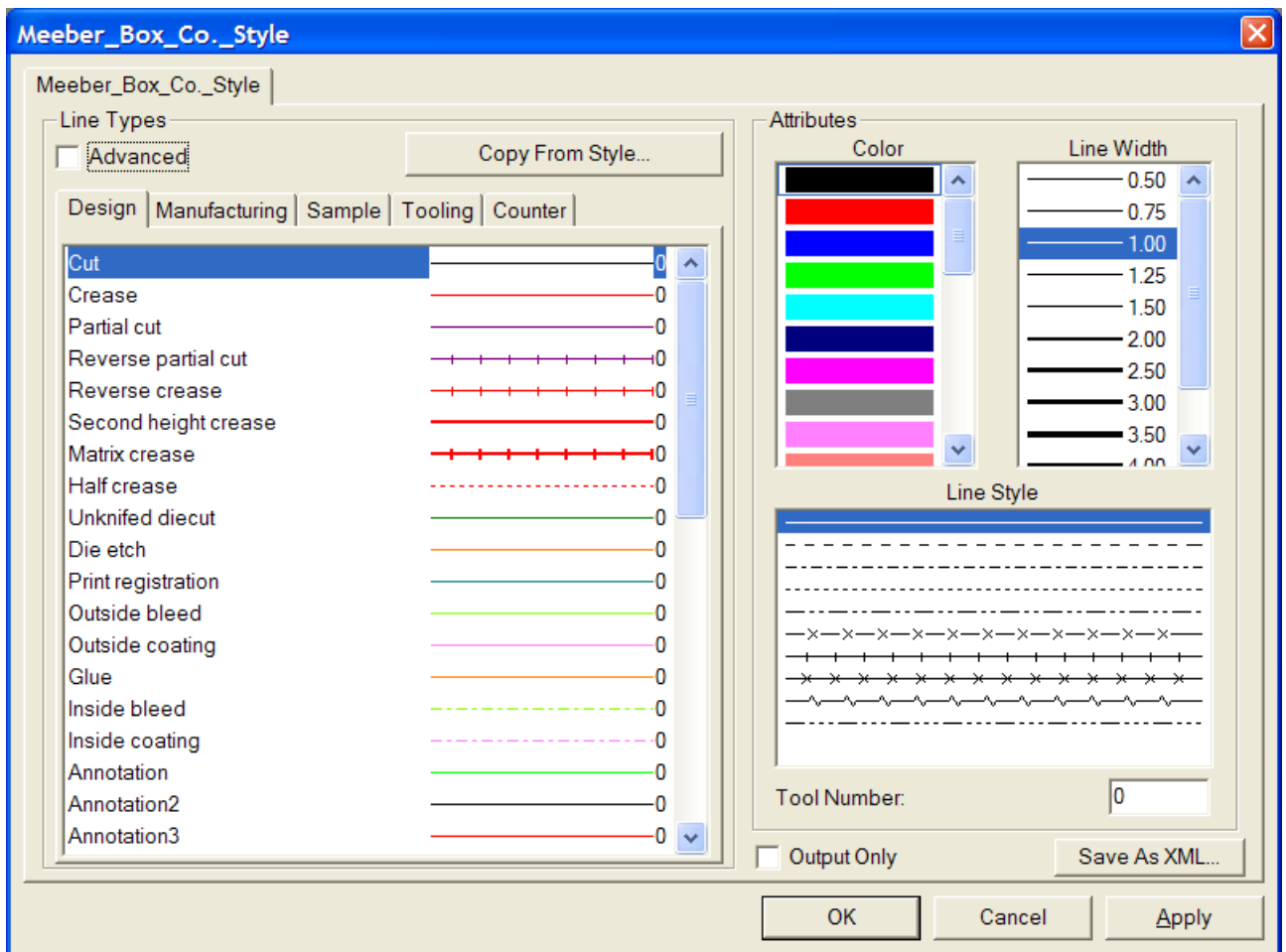

On the left is a set of five tabs that correspond to the different categories of lines. Each tab has a control showing the line name, the line style, the line color, and the currently-assigned tool number. On the right are controls to set those attributes.

Checking the **Output Only** checkbox makes this plotting style available only when configuring an Output - it is hidden when changing the plotting style in the View Mode.

Save as XML saves the plotting style as an XML file for use with the WebCenter Viewer.

For outputs, the **tool number** applies only when this plotting style will be used in an Output definition using a CAM driver.

For outputs, the **Color** and **Line Width** apply only when this plotting style will be used in an Output definition using either a Windows driver or a graphic CAM driver such as the PCL driver used for sample printing.

Copy From Style copies attributes of another plotting style into the current one.

4. Click each line style and set the line attributes as desired.
5. Click **OK** to save the changes to return to Defaults, or click **Cancel** to discard them and return to Defaults.

Changing the line attributes in a simple plotting style

To change the attributes of a line in a simple plotting style, do the following:

1. Open Defaults and double-click the plotting style to change.
2. Click the tab for the class containing the lines you wish to modify.
3. Select the line to modify in the **Line Types** group.
4. Select the new attributes - **Color, Line Width, Line Style** - from their respective lists in the **Attributes** group.
5. If desired, change the **Tool Number**.
6. Click **OK** to save the changes and return to the Plotting Style catalog, or click **Cancel** to discard the changes.

Creating a new plotting style by copying from another plotting style

To base a new plotting style on an existing plotting style, do the following:

1. Right-click the **Plotting Style Catalog** entry in Defaults and click **New > Data** on the context menus that appear.
2. Enter a name for the new plotting style and press enter.
3. Double-click the style to access its property page in order to change its defaults.
4. Click **Copy From Style**.

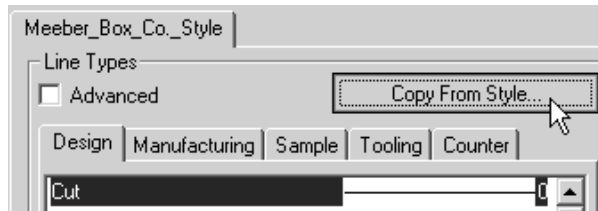

5. Select the plotting style to copy from on the left.
6. Select the line type categories to copy by checking the appropriate checkboxes in the **Line Type Subset** group. None are selected by default.
7. Select or clear the **Copy color and style** and **Copy tool numbers** checkboxes as appropriate.

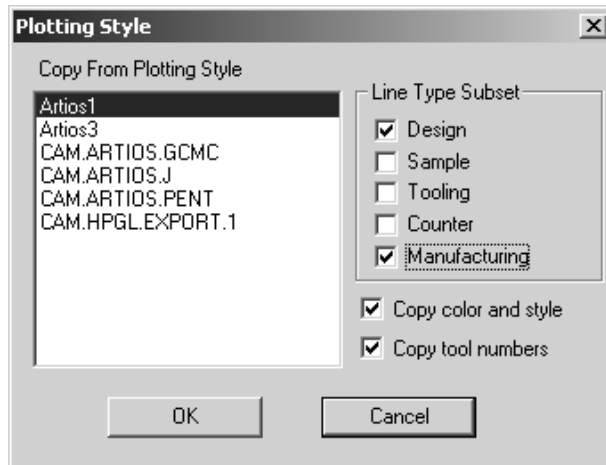

8. Click **OK** to copy the styles and attributes or click **Cancel** to return to the Plotting Style dialog box.

Working with Advanced plotting styles

When the **Advanced** checkbox is checked, the plotting style is considered **Advanced**. Configuring an Advanced plotting style takes slightly more time than a Simple plotting style but it allows greater flexibility.

Creating a new Advanced plotting style

To create a completely new Advanced plotting style, do the following:

1. Right-click the **Plotting Style Catalog** entry in Defaults and click **New > Data** on the context menus that appear.

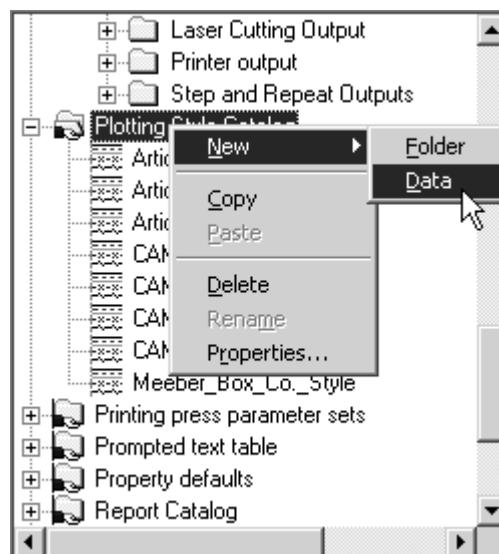

2. Enter a name for the new plotting style and press enter.

3. Double-click the style to access its property page in order to change its defaults and click the **Advanced** checkbox. You will be asked to choose whether to keep the definitions from the simple style or to create a blank style. For the purposes of this workflow, choose **Initialize to blank style** and click **OK**.



4. The blank Advanced style appears as shown below.

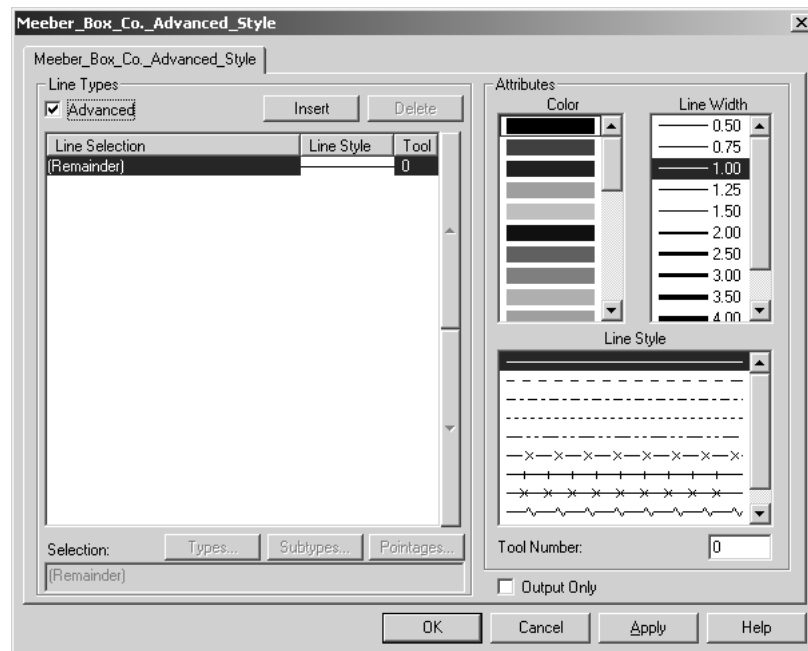

The **Attributes** group for an Advanced plotting style works in the same way as it does for a Simple plotting style. The **Line Types** group, however, works differently as explained below.

5. In a newly-created advanced plotting style, as seen in the **Line Types** group, all lines are configured to be shown as solid line style, black color, 1.00 width, and tool 0.



Advanced plotting styles work by assigning line attributes based on conditions defined in a line style statement. If a line meets a line style condition, it is assigned whatever attributes are assigned in the line style statement. The **(Remainder)** statement applies to line styles which meet none of the conditions. There will always be a (Remainder) statement; it cannot be deleted, but its attributes can be modified as desired.

6. To add line style statements, do the following:

- Click **Insert**. A new entry appears in the table and the corresponding ArtiosCAD syntax is shown in the **Selection:** field. By default, this new entry is solid line style, black color, 1.00 width, and tool 0.

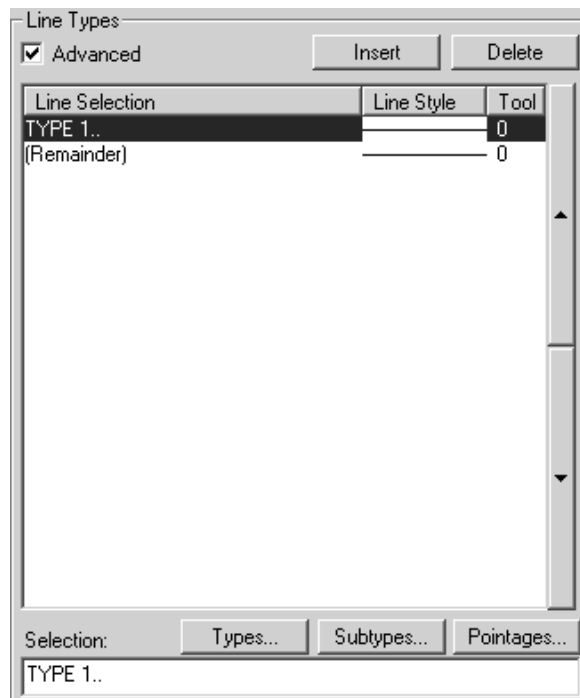

- Click **Types** to open the Types dialog box. All line types other than **Annotation** are selected by default. Select the line types to designate in this line style condition. Click category tabs (**Design, Sample, Tooling, Counter, and Manufacturing**) to choose from lists of line types in those areas of ArtiosCAD. **Select All** selects all the line types on each tab. **Invert Selection** reverses whatever is selected - each style that is checked becomes cleared and each style that was clear becomes checked. Your selection will appear in ArtiosCAD syntax in the field below the checkboxes.

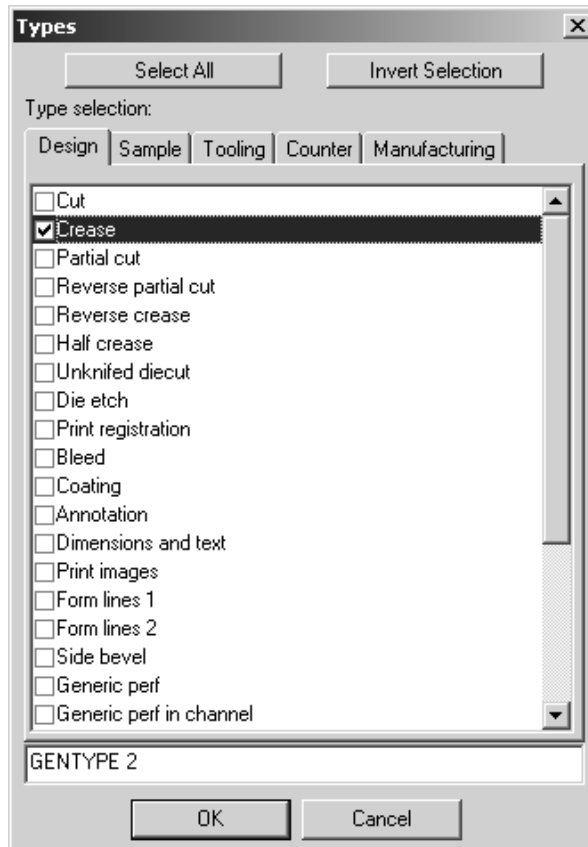

- Click **OK** to save this selection and return to the Plotting Style properties dialog box or **Cancel** to ignore this selection and return to the Plotting Style properties dialog box.
- Once back at the Plotting Style properties dialog box, click **Subtypes** to open the Subtypes dialog box and choose which subtypes to include in this line style definition. The ArtiosCAD syntax for your selection will appear in the field beneath the checkboxes.

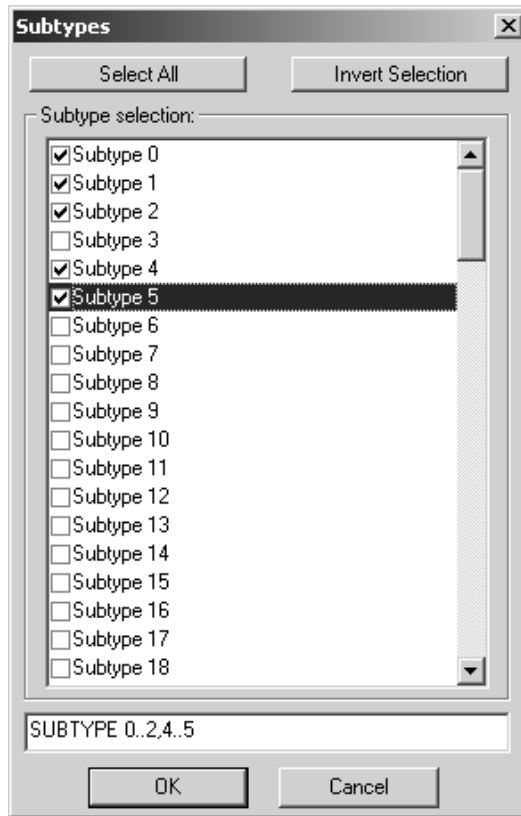

- Click **OK** to save this selection and return to the Plotting Style properties dialog box or **Cancel** to ignore this selection and return to the Plotting Style properties dialog box.
- Click **Pointages** to open the Pointages dialog box. Check or clear the checkboxes as desired. The ArtiosCAD syntax for your selection will appear in the field beneath the checkboxes.

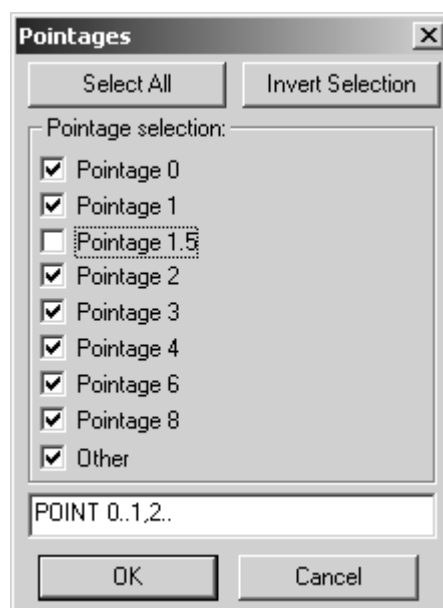

- Click **OK** to save this selection and return to the Plotting Style properties dialog box or **Cancel** to ignore this selection and return to the Plotting Style properties dialog box.
- Do not forget to also change the line attributes (color, line width, line style, and tool number) if you do not want them to be the default of black, 1.00, solid, and 0. Shown below is an example of crease line subtypes 0 through 2 and 4 through 5, pointage 0 through 1 and 2 and greater made to be red, have a line width of 1.00, a style of dot-dash, and output on tool 2.

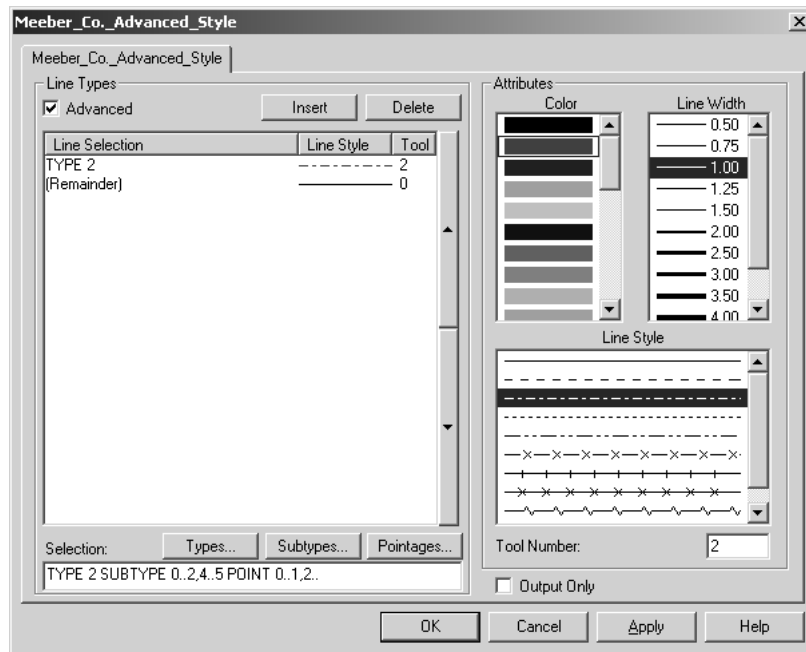

- If you are familiar with ArtiosCAD syntax, you may edit the **Selection:** field directly.
7. Repeat step 5 for each line style statement you wish to make. Shown below is the Artios.Pointage style which is based on line pointage; it uses a different color and tool number for each pointage.

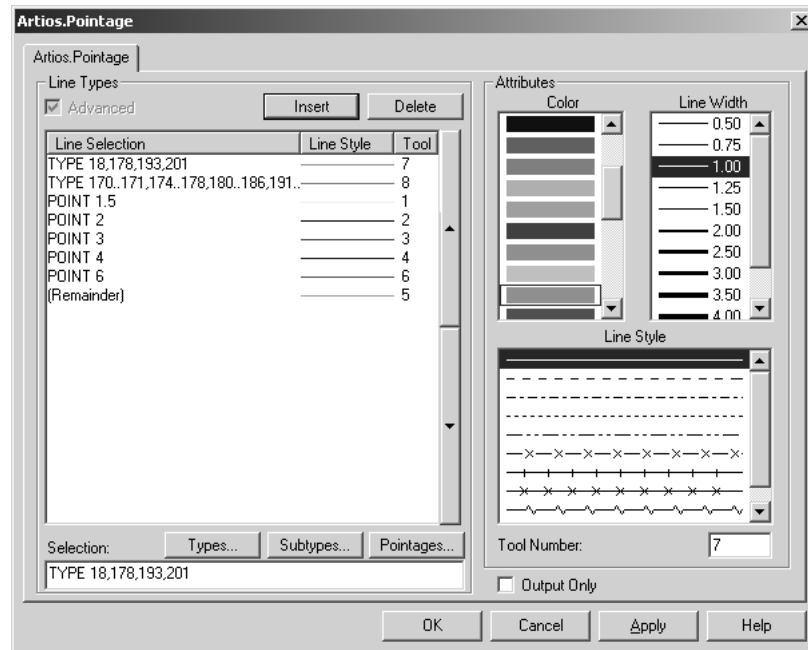

8. When you have finished adding line style statements, click **OK** to save the changes to the plotting style or click **Cancel** to ignore them and return to Defaults.
9. Save the Defaults by clicking **File > Save** and clicking **Yes** when prompted to overwrite the existing Defaults.

Converting a simple plotting style to an Advanced plotting style

When you convert a simple plotting style to an Advanced plotting style by checking the **Advanced** checkbox in a simple plotting style definition, you can choose to preserve the line style definitions, or you can initialize the Advanced plotting style with no values. Preserving the settings of the simple plotting style results in an Advanced plotting style similar to the one shown below. Initializing a blank plotting style results in having to define every line type as described in the previous section. In either case, edit the properties as desired. When done, click **OK** to accept the changes, or click **Cancel** to discard them.

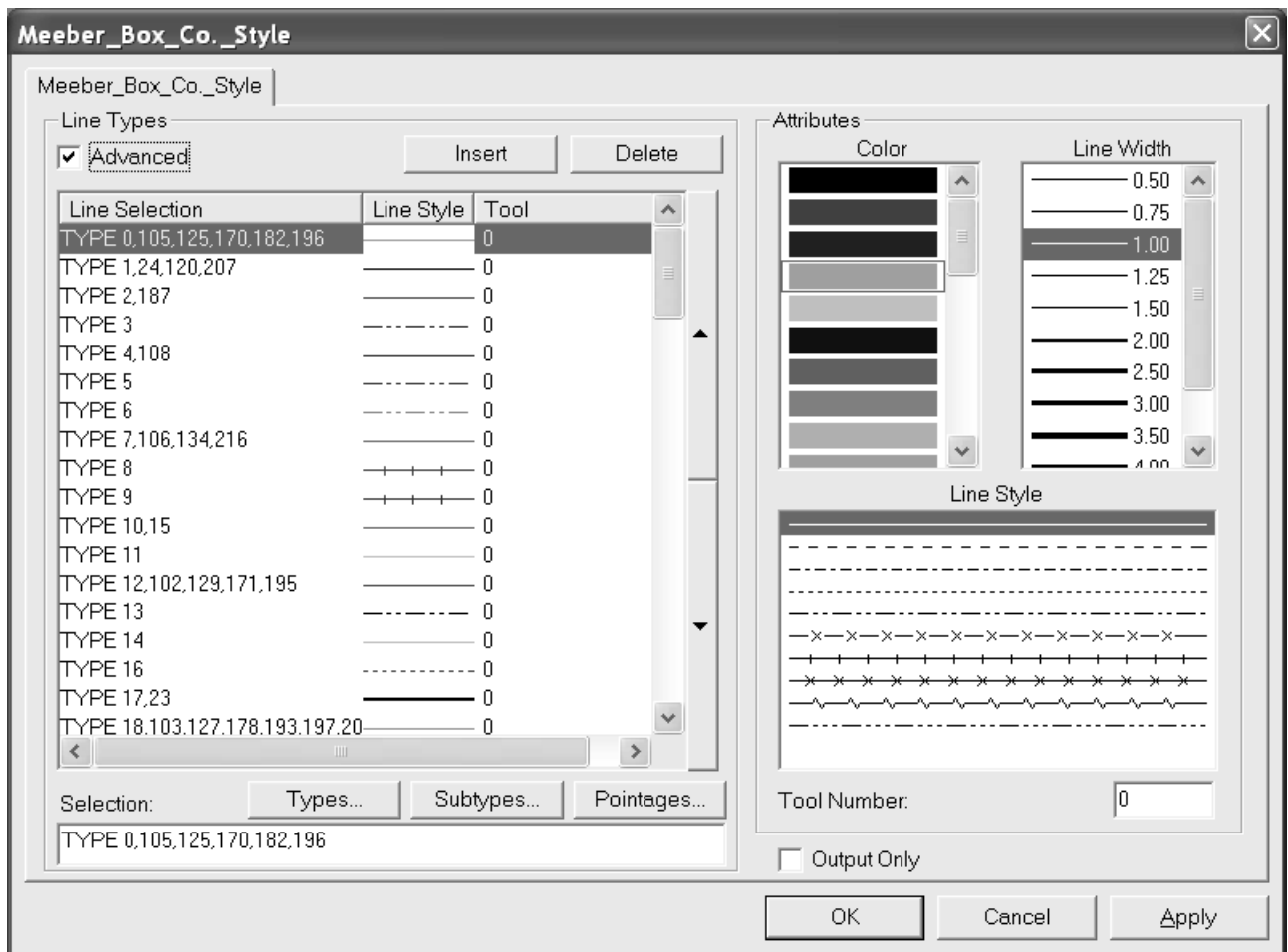

Special Rule Types

ArtiosCAD provides a series of generic rule types such as **cut** and **crease**. These are used at the design phase when how the line is cut or creased is unimportant or not known. There are other generic rule types, for example, for cut-crease lines. It is often necessary to specify that a cut-crease line is in fact ½" cut by ½" crease with crease used as the end land. In this case, a special rule should be used.

Special rules may also be used for simple cut and crease rules to allow more specific control during manufacturing. For example:

- Helmold 3pt 0.937" cut rule
- Böhler 3pt 23.6mm SN1 notched cutting rule

Specific bridging methods, rule widths, subtypes (for special cutting characteristics), and labels can be associated with special rules which aid in the flat and rotary die manufacturing process. Shown below is the Special Rule Types Catalog in Defaults.

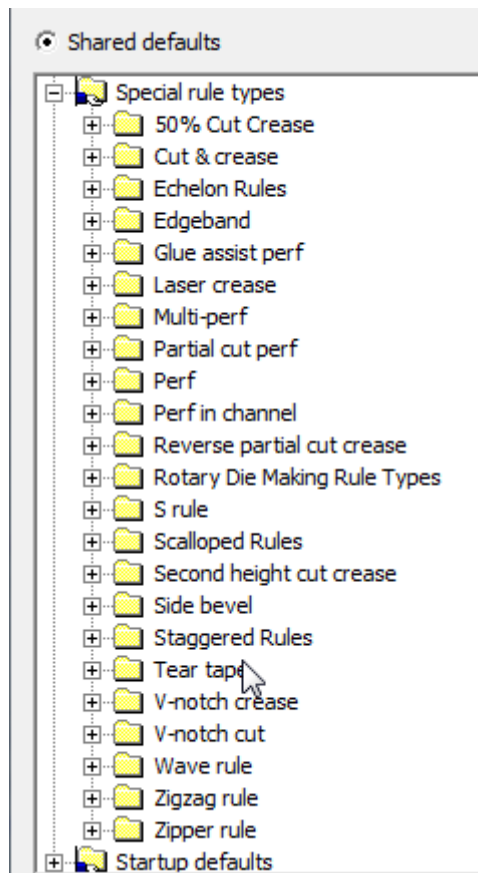

When editing a special rule, the Properties dialog box will have one or two tabs depending on the class of rule. All special rules have a **Manufacturing** tab with options such as pointage, subtype, rule height, flat rule or rotary rule, and so forth. Special rules that require more information to manufacture, such as perf, have a **Special Rule** tab in which rule-specific parameters are set, such as length of cut and crease, land length, land options, and so forth.

Manufacturing tab for special rules

Shown below is an example of the Manufacturing tab for 3-point rotary cut rule in Imperial format.

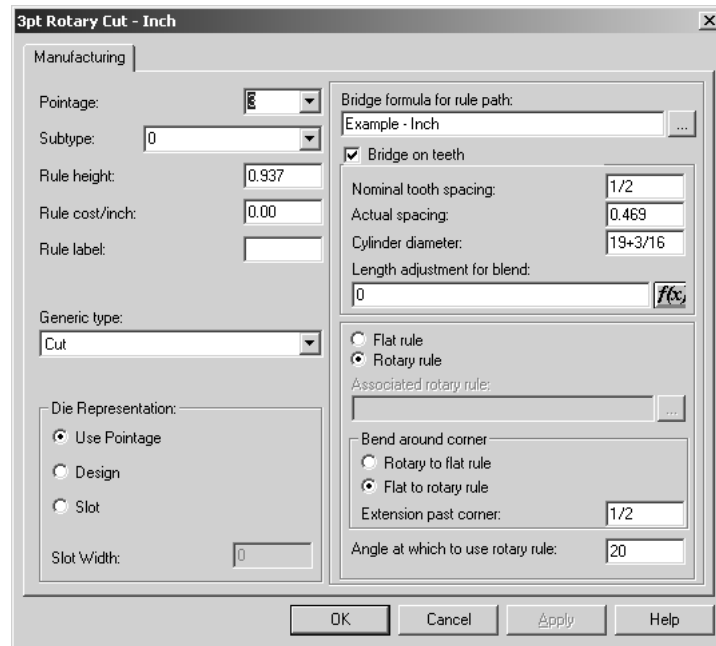

Pointage sets the pointage of the rule. You can either select a value from the drop-down list box or type your own.

Subtype sets the subtype of the rule. The subtype is used to configure specific manufacturing options in a CAM Tooling Setup.

Rule height and **Rule Cost** set the height and cost of the rule respectively. This information is used in line type legends and DDES-3 files only.

The text in the **Rule Label** field is printed when rule labels are enabled in the View Mode dialog box or in Outputs.

The **Generic Type** field is used to determine if more configuration options are needed on a second tab. For example, the cut and crease generic types do not require more configuration information, but the perfs and cut & crease types do.

The options in the **Die Representation** group determine how the rule is manufactured. Use pointage sets the slot width to the pointage * 0.014 inches. **Design** sets the slot in the die so that it follows the design of the special rule, such as waves in a wave rule. The slot width is the pointage * 0.014 inches. **Slot** lets you specify a custom slot width independent of the pointage.

Bridge formula for the rule path tells the rule which bridging formula to use. **Bridge on teeth** controls whether or not the rule has teeth, and what the tooth size, tab width, and which bridging formula to use.

Nominal tooth spacing refers to the customary size of the teeth on rotary rule. The **Actual spacing** is the distance between each tooth measured around the cylinder at cylinder level. The easiest way to measure this value is to mark off the distance between 10 teeth on a cylinder, and measure around the cylinder with an accurate tape measure, making sure to use the same point for the start and end. Divide by 10 to get the Actual spacing.

The **Cylinder diameter** is the cylinder for which this rule was made. It is used ONLY to compute tooth spacing when other-sized cylinders use this rule.

If you enter a cylinder diameter and an actual spacing value, ArtiosCAD can compute the tooth spacing when other die cylinders are used. This means that you do not have to enter separate special rules for each diameter cylinder.

Table: Rule Tooth Values

Common cylinder diameters	Tooth Spacing		Result from
	Nominal	Actual	
Inch			
21.000	0.500	0.471	Computed
19.1875	0.500	0.469	Rule table
14.125	0.500	0.458	Computed
11.500	0.500	0.450	Computed
10.1875	0.500	0.444	Computed
7.000	0.500	0.423	Computed
Metric			
530.00	11.00	10.36	Computed
487.36	11.00	10.31	Rule table
300.00	11.00	9.92	Computed
250.00	11.00	9.73	Computed

The tooth spacing is different for different cylinder diameters because when the rule is bent, it bends around the neutral axis. The neutral axis is the point in the rule that neither gets longer nor shorter when the rule is bent into a circular arc. The position of the neutral axis will be different for different types of rule. For example, some 6pt or 3pt rule will have the neutral axis a little closer to the top of the rule than simple 3pt rule. This is because the 6pt part is harder to bend than the 3pt part towards the bottom. Of course, the bottom of the rule has teeth cut out of it, so it is very easy to bend. Normal 3pt toothed rule would have the neutral axis about half way between the top of the tooth notch and the top of the rule.

As the cylinder diameter gets smaller, the teeth will get closer together, but the distance along the neutral axis will remain unchanged. The position of the neutral axis can be computed from the values given. It can then be used to calculate the tooth spacing for any diameter.

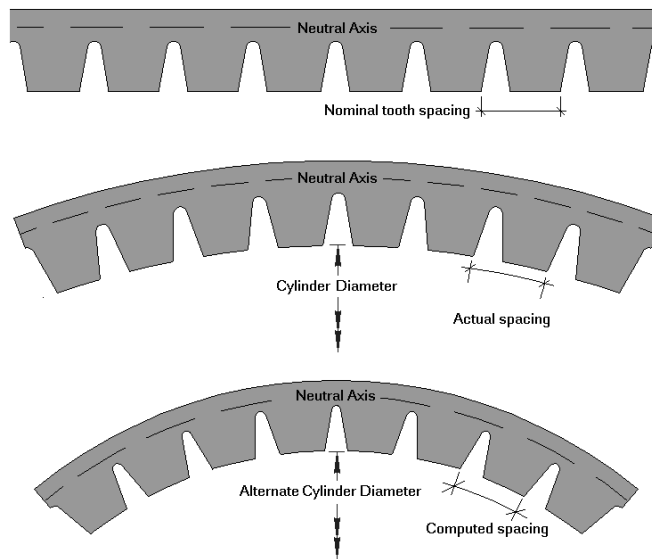

Length of adjustment for blend is used to calculate tooth positions after bending the rule. The entry in this field is derived from the table accessed by clicking the f(x) button.

Length adjustment				
<input type="radio"/> One parameter	Row parameter:	Arc radius	<input type="button" value="Add row"/>	<input type="button" value="Delete row(3)"/>
<input checked="" type="radio"/> Two parameters	Column parameter:	Angle	<input type="button" value="Add column"/>	<input type="button" value="Delete column(1)"/>
Angle	<input type="text" value="15"/>	<input type="text" value="45"/>	<input type="text" value="90"/>	
Arc radius	<input type="text" value="1/8"/>	<input type="text" value="0.018"/>	<input type="text" value="0.031"/>	<input type="text" value="0.045"/>
	<input type="text" value="1/4"/>	<input type="text" value="0.016"/>	<input type="text" value="0.029"/>	<input type="text" value="0.043"/>
	<input type="text" value="1/2"/>	<input type="text" value="0.014"/>	<input type="text" value="0.027"/>	<input type="text" value="0.040"/>

The **Flat rule** and **Rotary rule** option buttons designate the kind of rule. When **Flat Rule** is chosen, click the Browse button (...) at the end of the **Associated rotary rule:** field to choose the associated rotary rule.

In the Bend around corner group, **Rotary to flat rule** and **Flat to rotary rule** determine which is bent when a rule path bends around a corner when making a rotary die. **Extension past corner** sets the amount of rule to keep after the bend. **Angle at which to use rotary rule** sets the angle at which to switch from using flat rule to using rotary rule. The angle is measured from the horizontal axis.

When the option is set to **Flat to rotary rule**, ArtiosCAD will choose the flat to rotary option provided that the length of the vertical distance for flat in the picture below is less than the **Maximum vertical distance for flat** in the Rule Path Params catalog in the manufacturing parameter set. Note that the **Maximum vertical distance for flat** in the rule path parameters may need to be increased to get this desired result.

Wrap flat to rotary

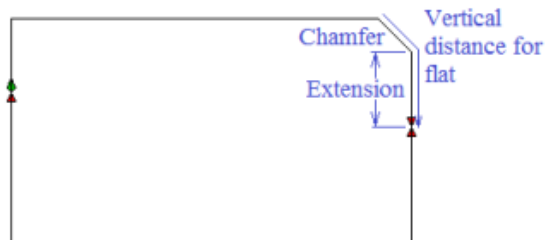

Wrap rotary to flat

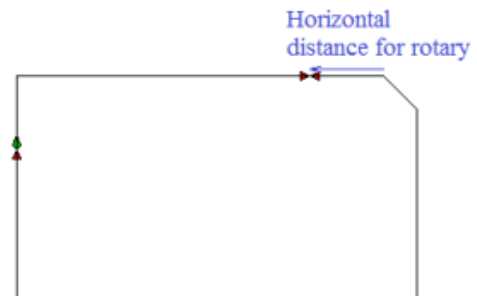

For a sufficiently large chamfer, ArtiosCAD will use the **Wrap rotary to flat** option. The picture below shows the wrap points for different size blends and chamfers.

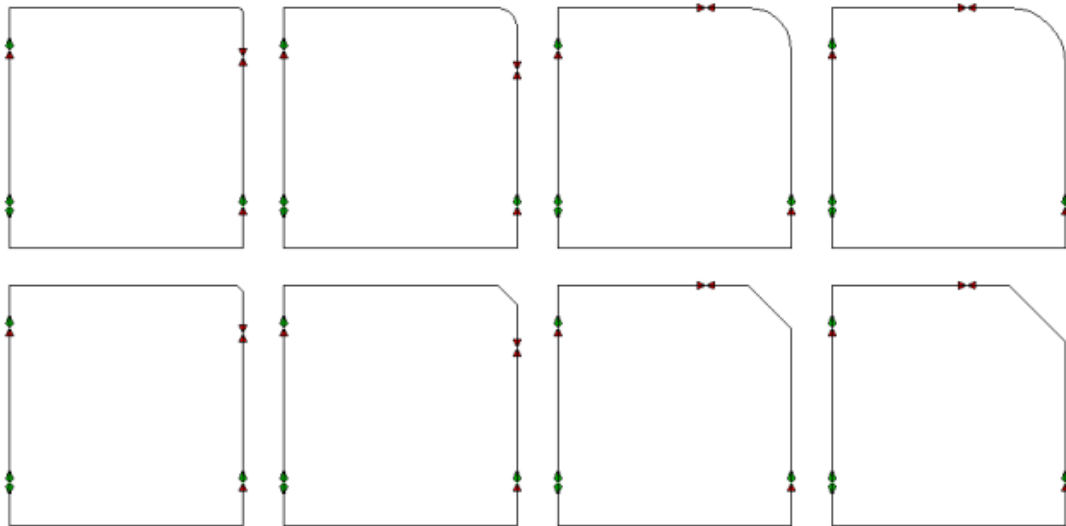

Special rule tab for special rules

The **Special Rules** tab is different for each kind of special rule. For example, for a perf rule, it looks like this:

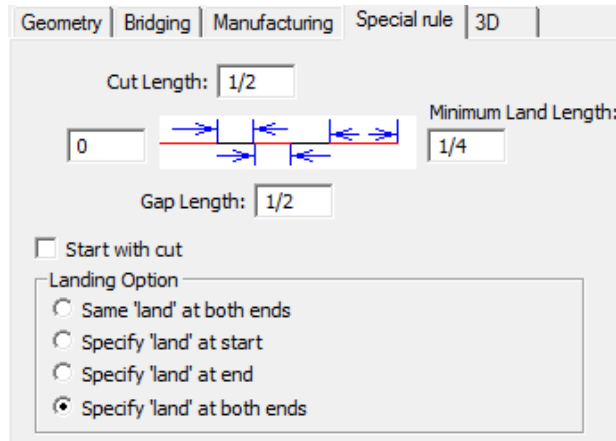

But for a scallop rule it looks like this:

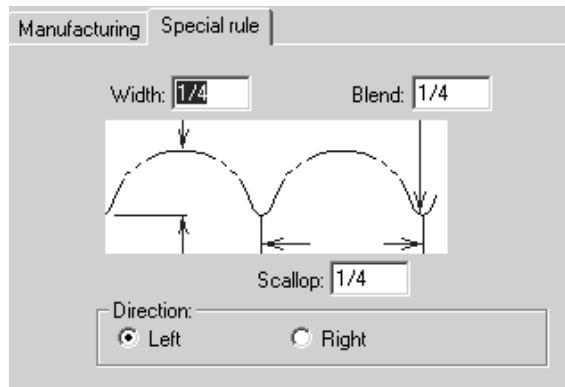

For wave and zig zag rules, the **Nick on top** option is available:

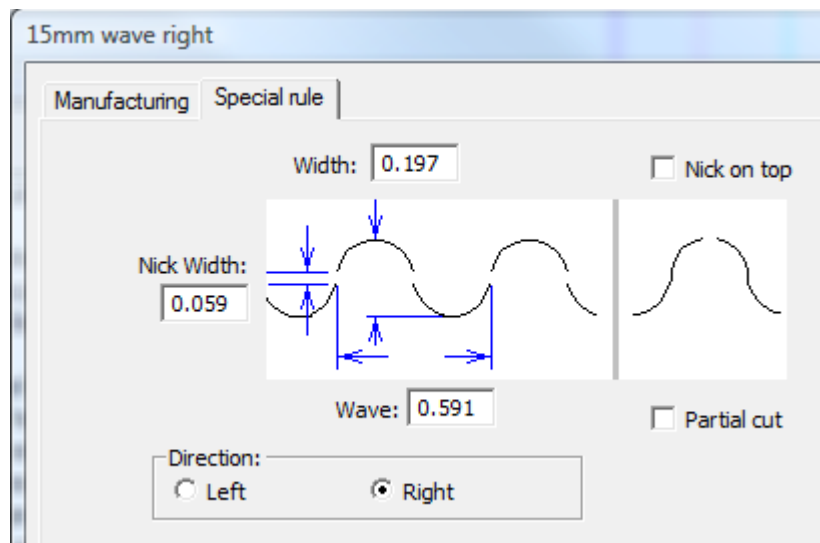

You probably already know the parameters for the rule you are configuring; enter the values and click **OK** to save the changes to the special rule and return to Defaults, or click **Cancel** to discard the changes.

Multi-Perf Overview

Multi-perf is perforation rule with a repeating pattern of differently sized teeth and gaps. Shown below are some examples of multi-perf rules.

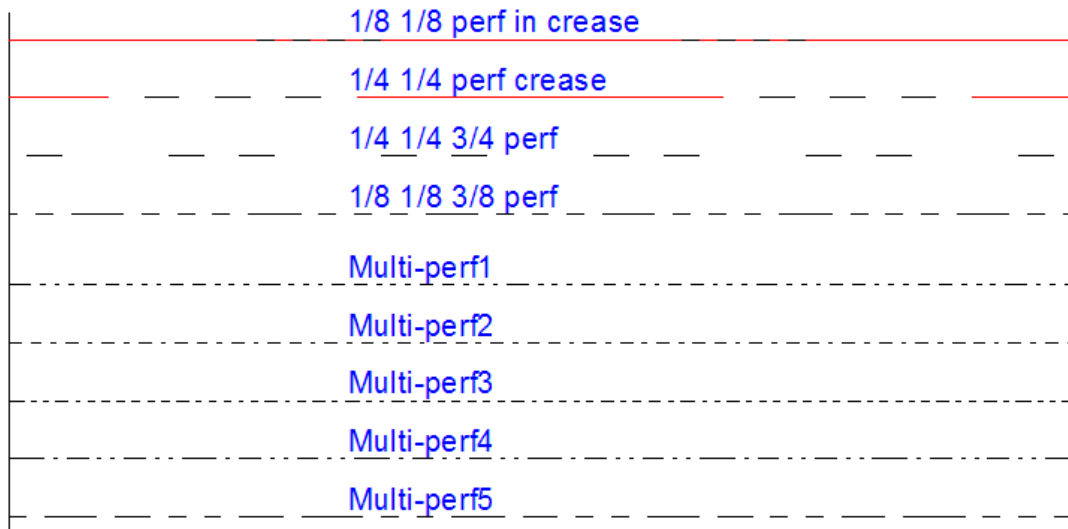

The pattern for the multi-perf is defined in a workspace.

Save your pattern definition workspace to ServerLib (conventional version) or the ServerLib folder in the Shared Defaults Project (Enterprise version).

Designing a multi-perf pattern

In each pattern definition workspace, design a combination of horizontally aligned cuts, creases, and gaps that define the pattern. You can add optional vertical annotation lines marking the land length and the ends of the pattern. Shown below are sample patterns.

Special rule type	Perf pattern workspace
1/8 1/8 perf-in-crease	
1/4 1/4 perf crease	
1/4 1/4 3/4 perf	
1/8 1/8 3/8 perf	
Multi-perf1	

The vertical annotation line in the 1/8 1/8 perf-in-crease example instructs ArtiosCAD to treat the crease as the land. For the 1/4 1/4 3/4 perf, the land is the space between the two

annotation lines, which ArtiosCAD uses to center the perf pattern along design lines. The Multi-perf1 pattern is too long for a land, so the vertical annotation line marks the end of the pattern.

Use the following line types when designing your own pattern definition workspace:

- Cut
- Partial cut
- Reverse partial cut
- Crease
- Second height crease
- Matrix crease

Defining the land

An annotation line in the middle of a pattern marks the right end of a land.

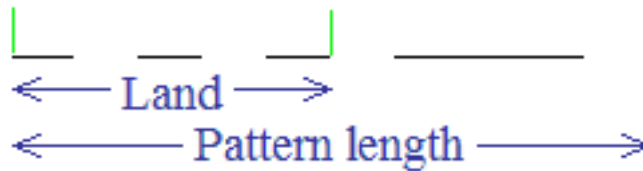

If the pattern has a land, ArtiosCAD centers the perf pattern on the line with the same land at both ends. Shown below is an example of how the pattern is centered on lines of different length.

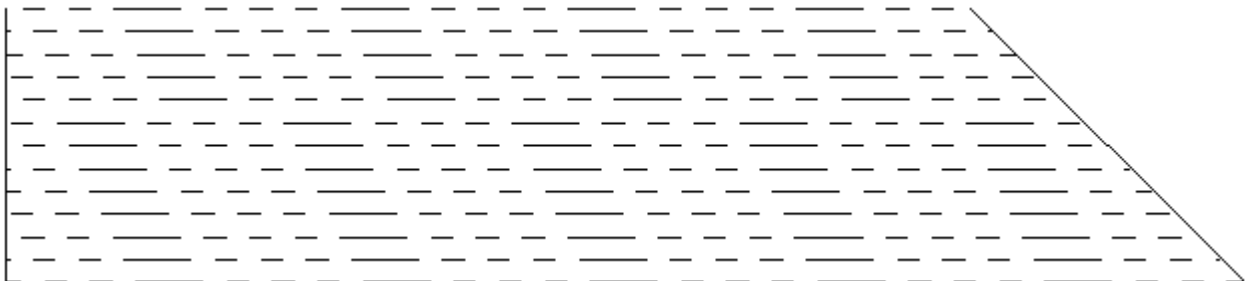

If the pattern has no land, ArtiosCAD aligns the pattern with the start of the line, and the value in the **Minimum land/pattern offset** field of the special rule definition defines the offset of the pattern along the line as shown below.

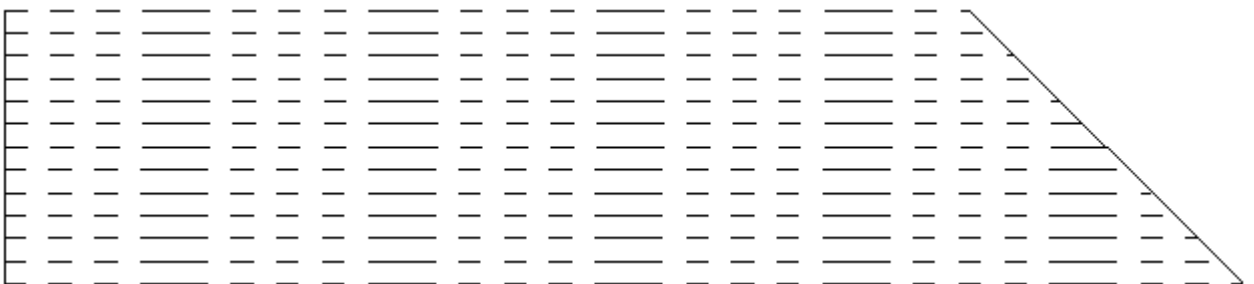

Offset 0

Offset 2mm

Offset 4mm

Offset 6mm

Offset 8mm

To make the pattern center correctly on the rule, make the land symmetrical, so it has the same cut or gap at both ends.

| Land | | Symetrical, correct

| Land | | Symetrical, correct

| Land | | Asymetrical, wrong

Adding a Multi-Perf Definition to the Special Rule Types Catalog

Once you have designed a pattern definition workspace for a multi-perf and saved it to ServerLib, do the following to add it to the Special Rule Types Catalog.

1. Start ArtiosCAD. If you are using an Enterprise version, log in as a member of ADMINS.
2. Click **Options > Defaults**.
3. In the Shared Defaults pane, expand the Special Rule Types Catalog.
4. Right-click **Multi-perf** and then click **New > Data** on the context menu.
5. Enter a name for the new multi-perf type and press Enter.
6. On the Manufacturing tab of the special rule type dialog box, select **Multi-perf** from the **Generic type** drop-down list box.

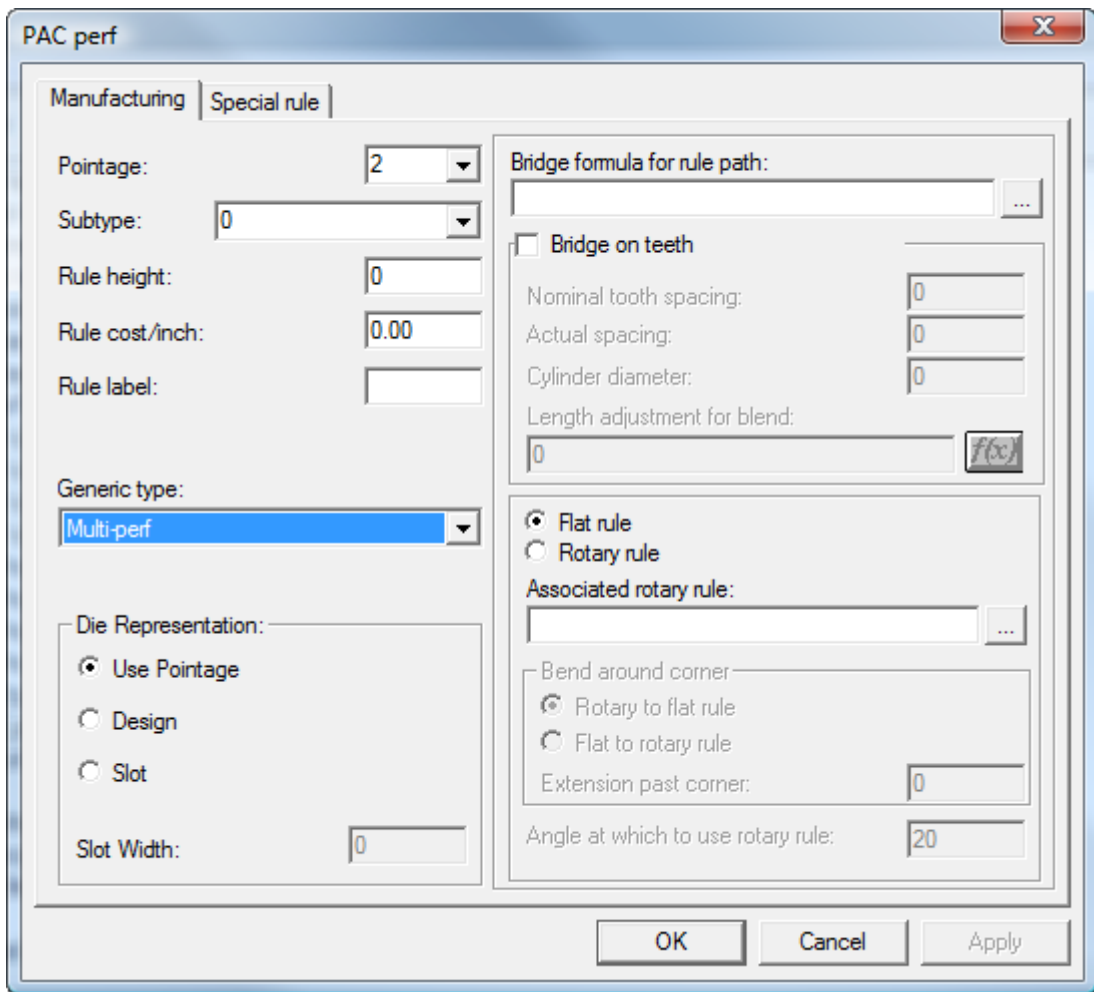

7. On the Special rule tab of the special rule type dialog box, enter or browse for the pattern definition file. Enter a value in the **Minimum land/pattern offset** field if the pattern definition workspace does not have a land defined.

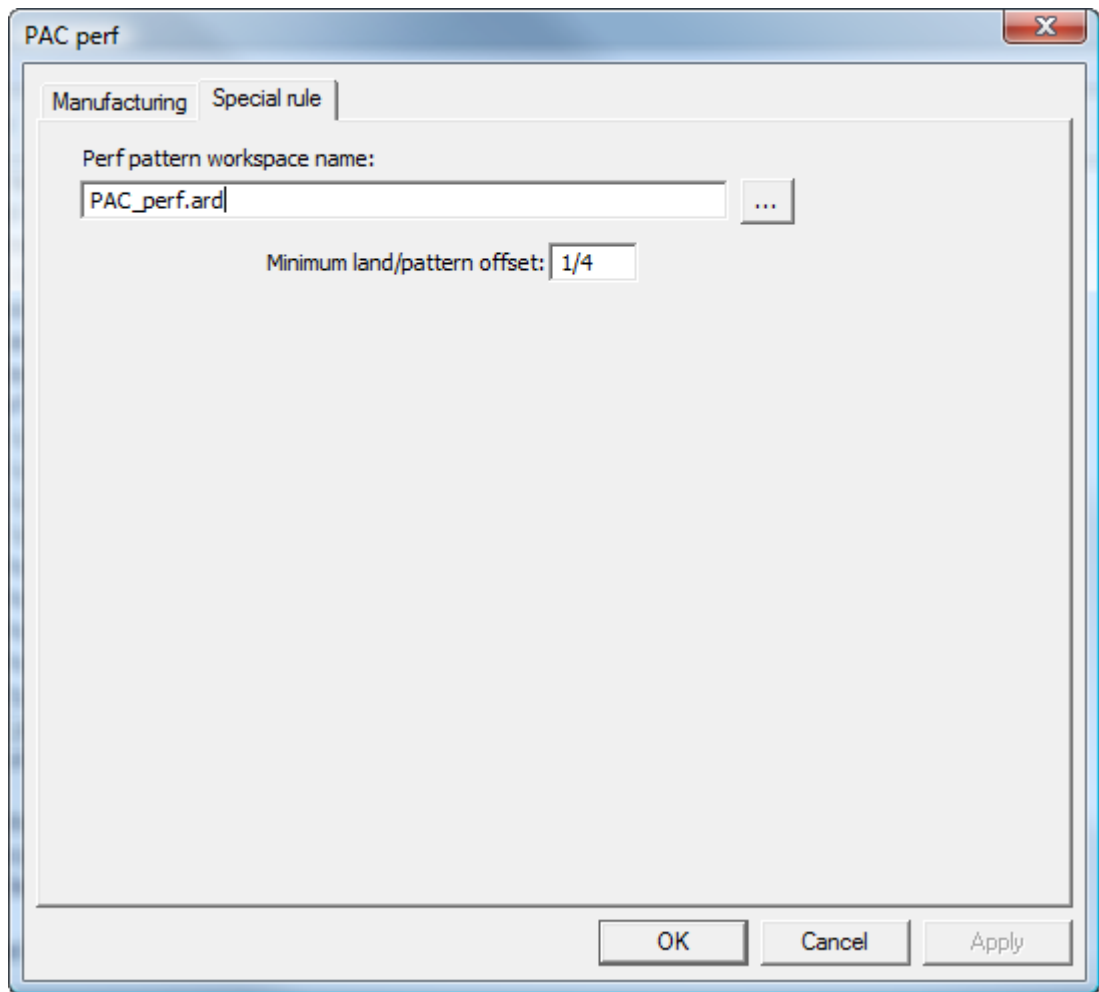

8. Click **OK** to save the new multi-perf catalog entry.
9. Save and exit Defaults as usual.

Edge band and Tear Tape Overview

Edge band is a cover that hides the edge of thick material, such as Re-board[®], usually used for displays.

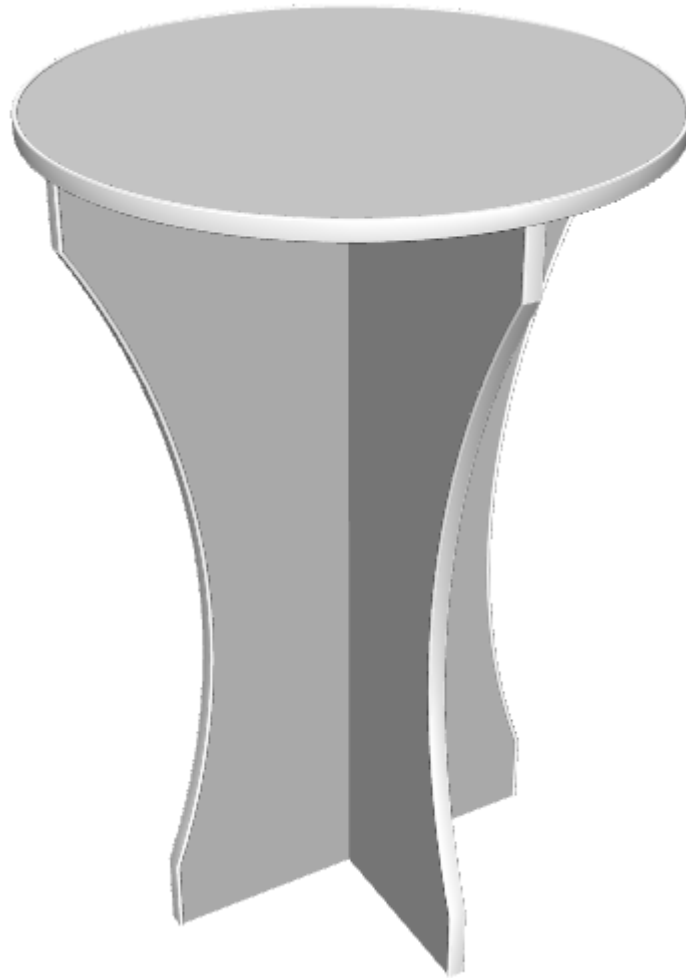

Tear tape is the thin plastic strip on the inside of box-opening features.

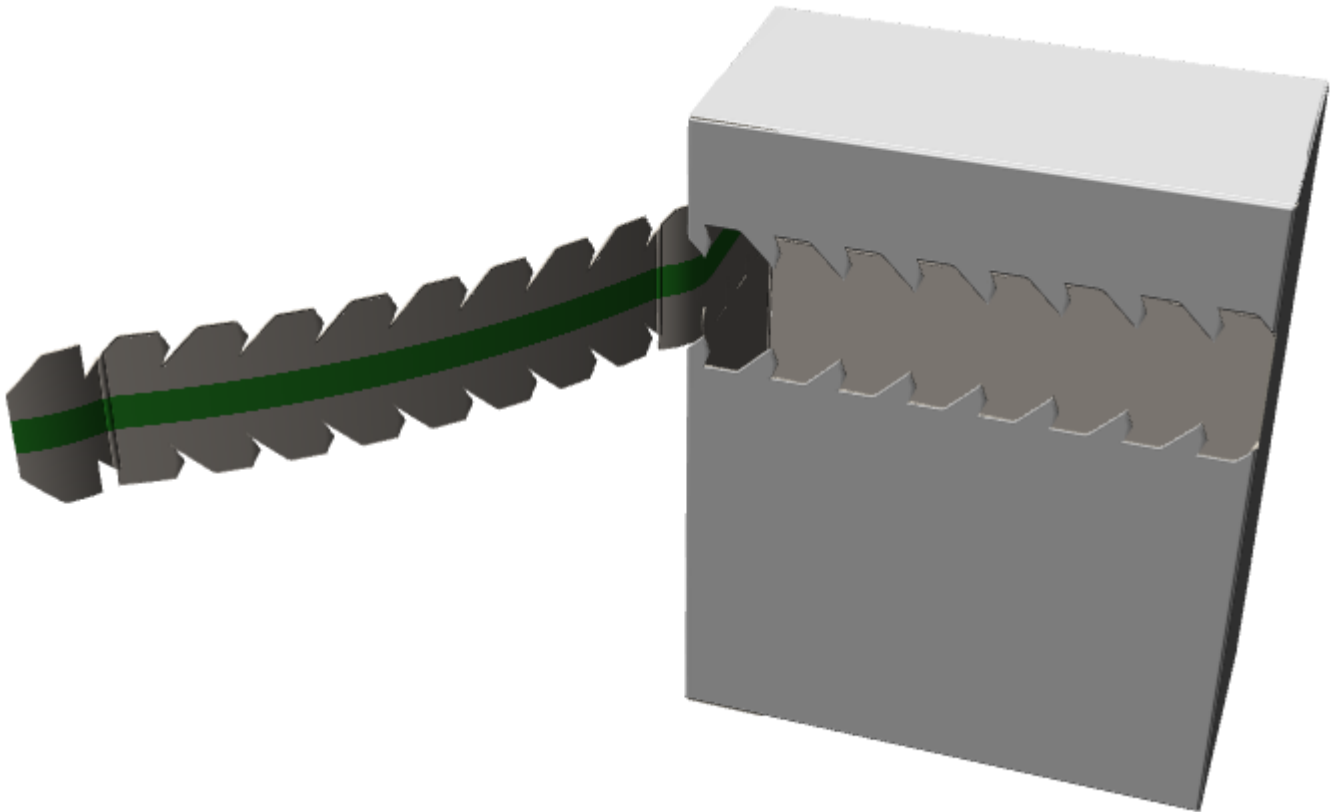

Both edge band and tear tape are special rules.

Defining an Edge Band

To define an edge band, do the following:

1. Design a cross-section of the edge band as a single design. Make sure it forms a loop and orient it horizontally so that its lower middle section aligns with the board edge.

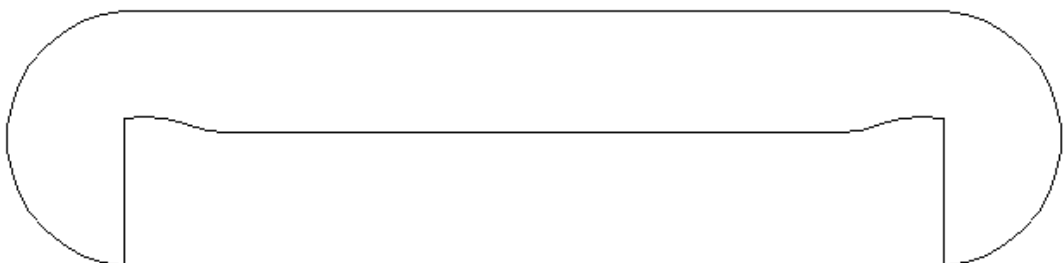

2. Copy the cross-section workspace to ServerLib.
3. In Defaults, add a new entry to the Edgeband folder of the Special Rule Types catalog by right-clicking it and then clicking **New > Data** on the context menu.
4. On the Manufacturing tab, set its **Generic type** to **Edge band**.

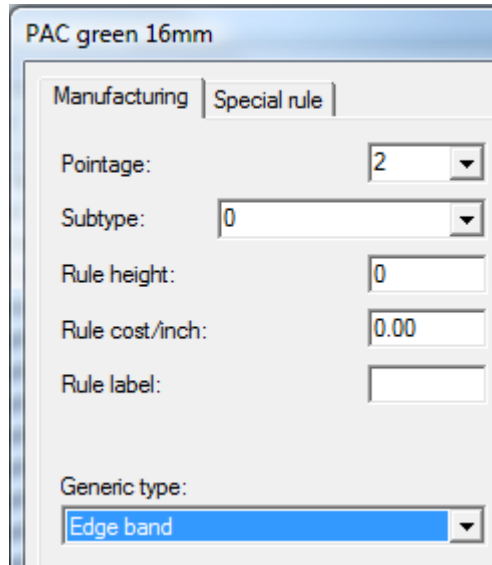

5. On the Special rule tab, enter the cross-section workspace's name or browse for it.

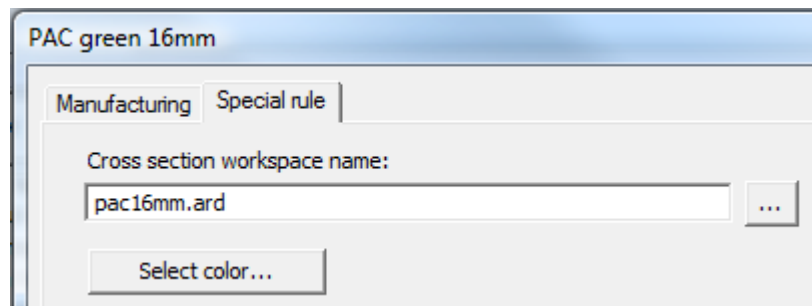

6. Click **Select Color** to set the color of the edge band.

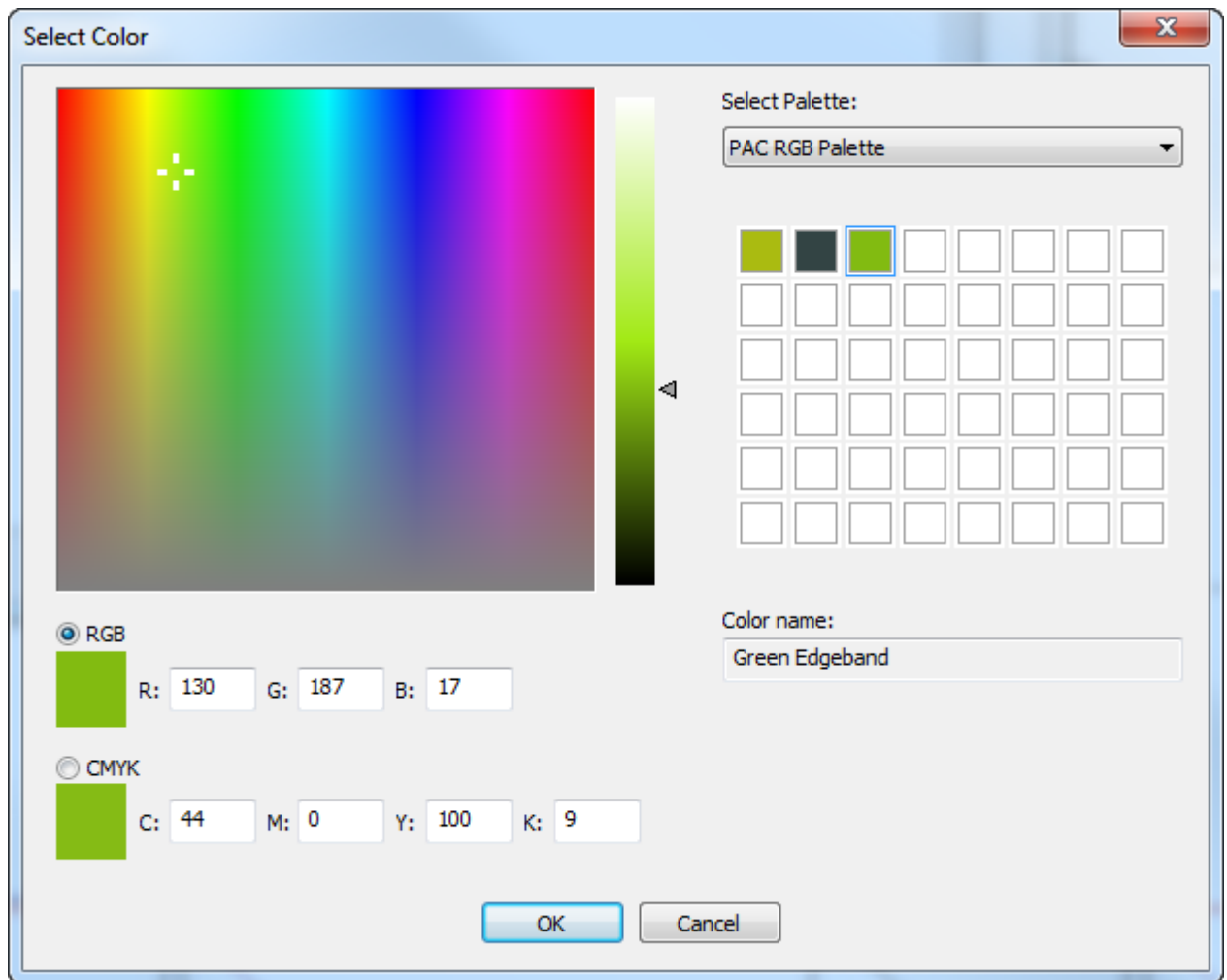

7. Click **OK** to return to Defaults.
8. Modify a plotting style to give the **Edge band** type a thick dashed line.



9. Save and exit Defaults normally.

Defining a Tear Tape

A tear tape has a thickness and a color.

1. In Defaults, add a new entry to the Tear tape folder of the Special Rule Types catalog by right-clicking it and then clicking **New > Data** on the context menu.
2. On the Manufacturing tab, set the **Generic type** to **Tear tape**.

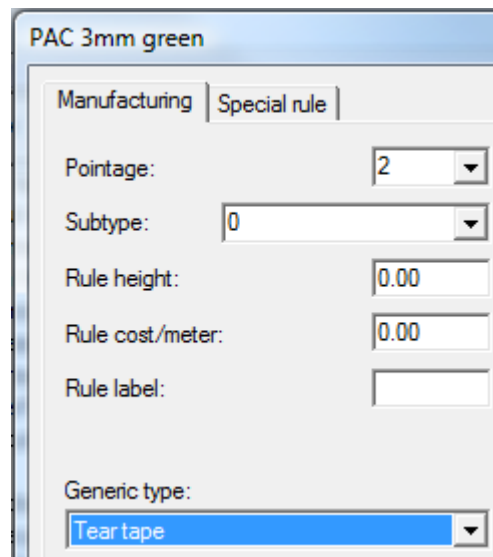

3. On the Special rule tab, enter a value in the **Width** field.

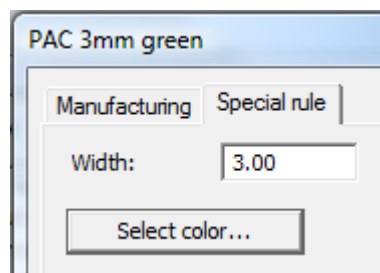

4. Click **Select Color** to set the color of the tear tape.

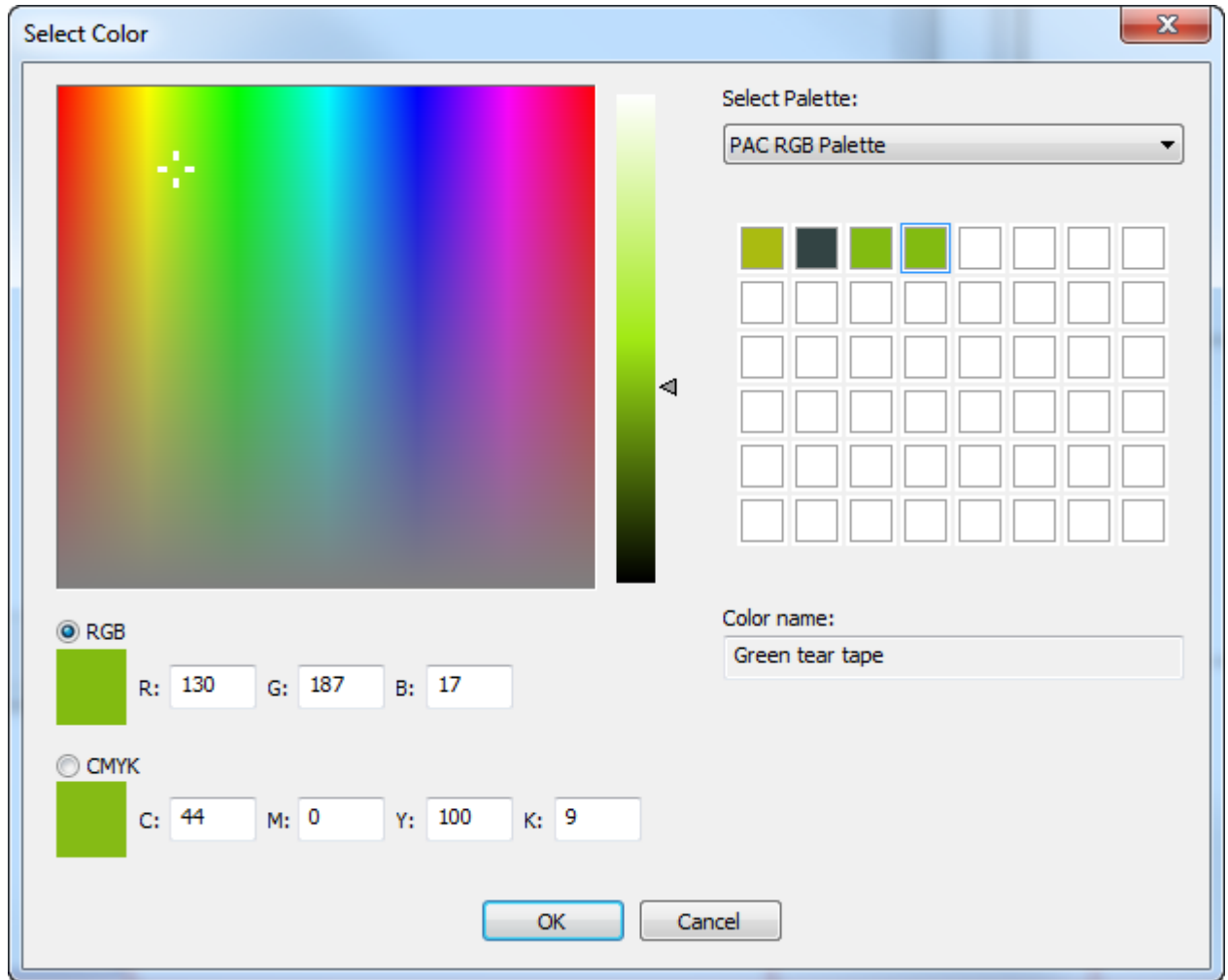

5. Click **OK** to return to Defaults. Save and exit Defaults normally.

Default line type set

When you first launch ArtiosCAD, cut and crease are the two line types available from the Line type drop-down list box in the View bar. To change the available lines at startup, double-click the **Default Line Type Set** entry in **Design defaults**. The Default Line Type Set dialog box will appear.

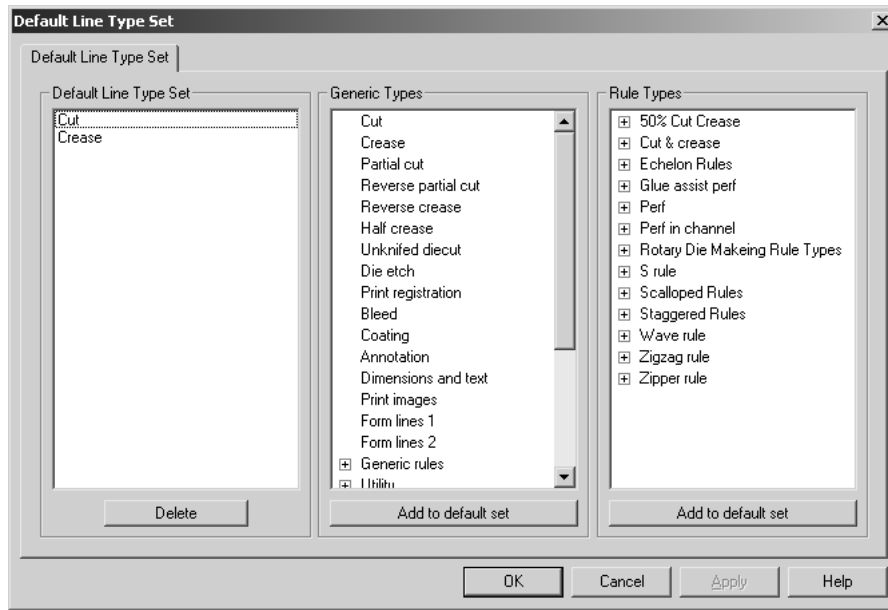

To add a line type or special rule type to the default set available at startup, select it and click **Add to default set**. To delete a line type or special rule type from the default set, select it in the **Default Line Type Set** group and click **Delete**.

When you have finished modifying the Default Line Type Set, click **OK** to save your changes and return to Defaults, or click **Cancel** to return to Defaults and discard your changes.

CAM Tooling Setup Catalog

The CAM Tooling Setup Catalog contains the configuration information for CAM output devices such as Kongsberg DieSaws and lasers. Configuration information is separated onto three tabs in each Catalog entry - **Tool List**, **Tool Selection**, and **Optimization**.

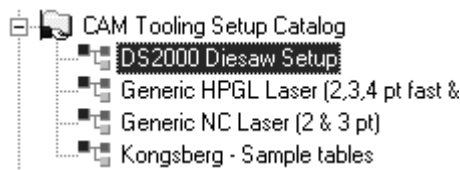

Tool List tab

The Tool List tab contains the configuration information for the tool type, width, depth (if applicable), step height, overlap, lead hole (if applicable), and name of the tool. Each combination of tool, width, and depth needs to be assigned to a different tooling line type. To use an expression to define the tool width, select **Use Expression**.

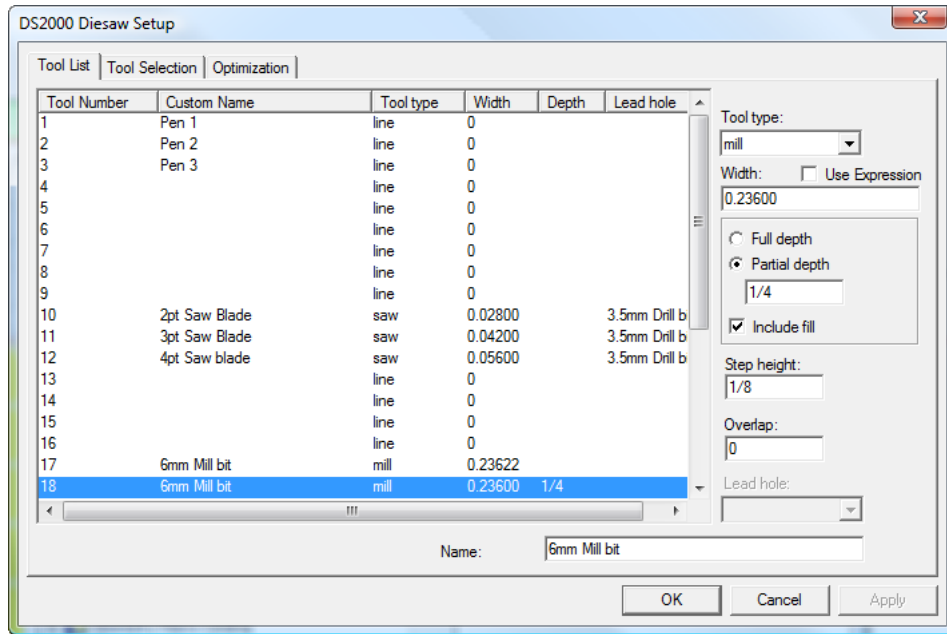

To set up the tool list, choose the tool number to modify and then set the tool type. Set the available options and enter a name for the tool in the **Name:** field.

The table below explains the function of each tool type.

Table: Tool Types, Their Properties, And Intended Uses

Tool type	Properties	Description	Intended uses
line	none	Uses the original lines;	Drawing with a pen.
slot	Width - effective width of the tool Overlap - overlap between multiple passes of the tool. Available when Partial Depth is selected.	Makes a slot of a defined width. Will envelope if the slot width is wider than the tool width.	Laser-cut slot for a rule in a dieboard
drill	Width - effective diameter of the drill Full Depth - Depth is the full depth value, defined in the output Partial Depth - Depth is defined in the CAM setup	Drills a hole at a point whose diameter is defined by the width in the CAD setup.	Mounting holes, leader holes
any drill	Full Depth - Depth is the full depth value, defined in the output	Drills a hole at a point whose diameter is defined by the diameter	Mounting holes

Tool type	Properties	Description	Intended uses
	Partial Depth - Depth is defined in the CAM setup	of the circle in the workspace.	
counter drill	<p>Width - effective diameter of the drill</p> <p>Full Depth - Depth is the full depth value, defined in the output</p> <p>Partial Depth - Depth is defined in the CAM setup</p>	Drills a hole with a counter sink drill, same as the drill tool type, but sends different commands to the Kongsberg driver.	Countersink holes.
mill	<p>Width - Effective diameter of the tool.</p> <p>Full depth - Depth is the full depth value, defined in the output.</p> <p>Partial depth - Depth is defined in the CAM setup.</p> <p>Include fill (off) - One pass inside or outside the outline.</p> <p>Include fill (on) - Multiple loops, starting in the middle of a hole, and working outwards</p> <p>Step height - Amount by which the tool penetrates into the material if the tool requires multiple passes at increasing depth to complete the hole.</p>	Mills inside or outside the outline which is usually a loop.	Holes in a dieboard that are too small to saw; the dieboard alignment notch.
saw	<p>Width - Effective width of the saw blade</p> <p>Lead hole - Which leader hole to use.</p>	Makes a slot of a specified width, same as the slot tool type, but adds a leader hole.	Lines sawn on a DieSaw.

Tool Processing and Offsets when Outputting

A combination of the Tool type in the CAM Tooling Setup and the line type category of lines in the workspace determines how the lines are offset on Output. For example, a mill, saw, or slot tool will be offset by half the tool width for inside-edge or outside-edge lines such as Dieboard edge or Lower stripping hole. The same mill, saw, or slot tool will cut on a center-edge line (such as Unknifed diecut or a rule such as Cut) without an offset.

Inside-edge and outside-edge line types are defined as the edge of a loop and do not have a slot width. When output through a CAM Output, their offset is half the tool width in the CAM

Tooling Setup. The pointage property of inside- and outside-edge line types can be used for selection purposes but does not affect the processing in a CAM Output.

Table: Offsets when Outputting

Tool Type	Line type	Processing
Line	All	Unchanged
Slot or Saw	Draw	Unchanged
	Inside edge	Cuts path inside by half tool width
	Outside edge	Cuts path outside by half tool width
	Center edge, fill off	If width is less than slot width, cuts envelope, else unchanged
	Center edge, fill on	If width is less than pointage or slot width, multipass, else unchanged
	If saw, adds leader holes as necessary.	
Drill, any drill, or countersink drill	All	
Mill	Draw	Unchanged
	Inside edge	Cuts path inside by half tool width
	Outside edge	Cuts path outside by half tool width
	Center edge, fill off	If width less than slot width, cuts envelope, else unchanged
	Center Edge, fill on	Series of loops starting in the middle and working outward
	Repeats with the next depth necessary depending on the step height	

Tool Selection tab

The **Tool Selection** tab maps line types, pointages, and subtypes to tools on the output device. It is also the place where the output priority is assigned. During output, a line is processed according to the first selection in the list that matches the line's properties. When a line matches the selection criteria, it is mapped to the specified CAM tool and then assigned to a group. Once a line has been mapped, the process begins again with the next piece of line data; lines are processed by one selection and one selection only. When all the data has been processed, the groups are internally optimized and output to the machine in ascending order

by group number. Lines that do not match any of the selections in the list are processed using the (**Remainder**) selection, which usually are not output.

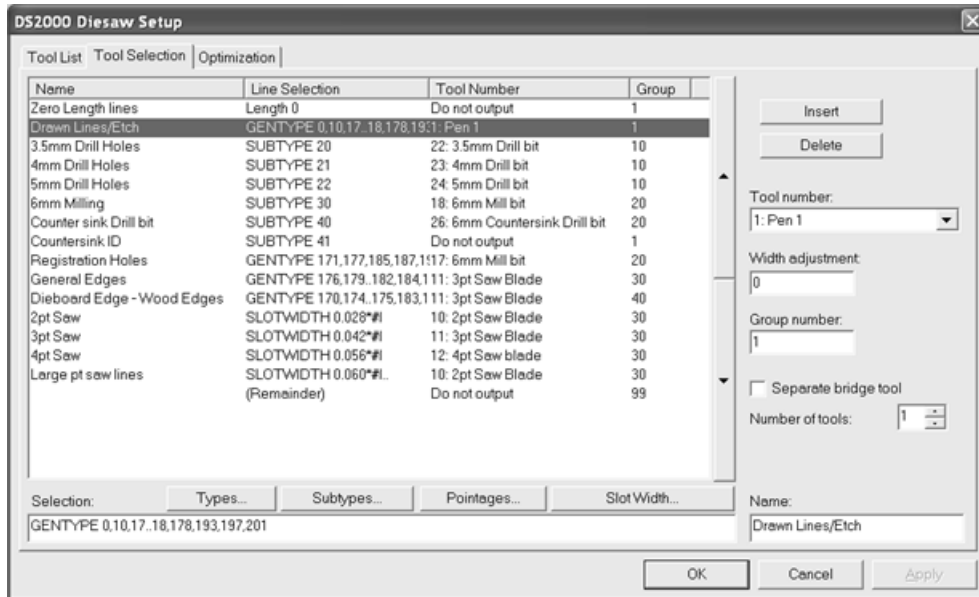

In the example above, drawn lines, etch lines, and lines with subtype Countersink ID are output first as they are in group 1. The Countersink ID lines are not actually created on the machine as they are assigned to the **Do not output** tool. Once the group 1 lines are output, then the group 10 lines are output, then 20, then 30, and so forth.

The **Types**, **Subtypes**, and **Pointages** buttons lead to dialog boxes where you can select exactly what will be output in this selection. These dialog boxes are similar to those used for selections in plotting styles.

Note: The **Text and dimensions** checkbox in **Types > Design** only applies to text and dimensions that have not had a color applied. Those with a color applied are considered graphics and are not output to CAM devices.

By default, all items are turned on when you enter the dialog box for the first time. Click **Invert Selection** to clear each checkbox. Clicking **Select All** selects all the items in the list. If you make selections other than having all selected or having none selected, the base ArtiosCAD syntax is shown in the field beneath the list. When you have finished selecting, click **OK** to return to the Setup dialog box saving your changes or **Cancel** to return, ignoring your changes.

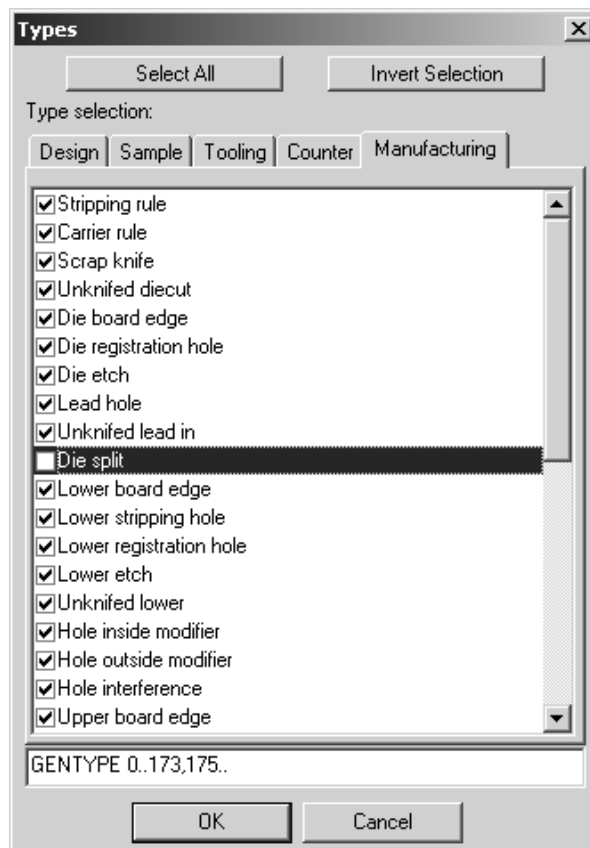

The **Slot Width** button opens the Slot Width dialog box in which you can specify a minimum slot width and a maximum slot width. Any line with a slot width between those values will be selected. #I or #M is automatically appended to the slot width selection to allow for conversion between units of measurement.



The up and down arrows to the side of the selection list move the selected entry either up or down in the list depending on which button is clicked.

Insert adds a new entry above the current selection; **Delete** deletes the current selection. The **(Remainder)** selection may not be deleted.

The **Tool number:** field selects the CAM tool to map to the line selection. Entries for this drop-down list come from the Tool List tab. The **Size only** tool is meant to be used for easier registration. Lines sent to the **Size only** tool show in a preview and are used to calculate the output size, but are only actually output when outputting to a layer.

The **Width adjustment:** field allows you to add to the slot width that is cut. Usually the slot width is defined by the slot width of the rule if so defined or by the pointage of the rule. However, the preferred way to adjust the slot width for laser output is to use a special rule with a defined slot width.

The **Group number:** defines which group the selected lines are put into. Group 1 is output first, then group 2, group 3, and so on.

If the **Separate bridge tool** checkbox is checked, another line is added beneath the selection in the list to allow the processing of bridges for that selection to be defined separately. This means that bridges can be made with a different tool.

Dieboard Edge - Wo	GENTYPE 170,174..175,183,195,1911:	3pt Saw Blade	40
...	bridges	10: 2pt Saw Blade	40

The **Number of tools** field allows for more than one tool to manufacture the lines selected by a selection criteria line. Configure the extra lines as you would any of the other selection criteria lines.

Enter the desired name for the selection criteria line in the **Name:** field.

Note: Wave rules with nick width of 0 are treated as cuts and processed by the GENTYPE 1 tool selection.

Optimization tab

The **Optimization** tab controls the internal optimization of the groups of output. Optimizing is on for all groups by default.

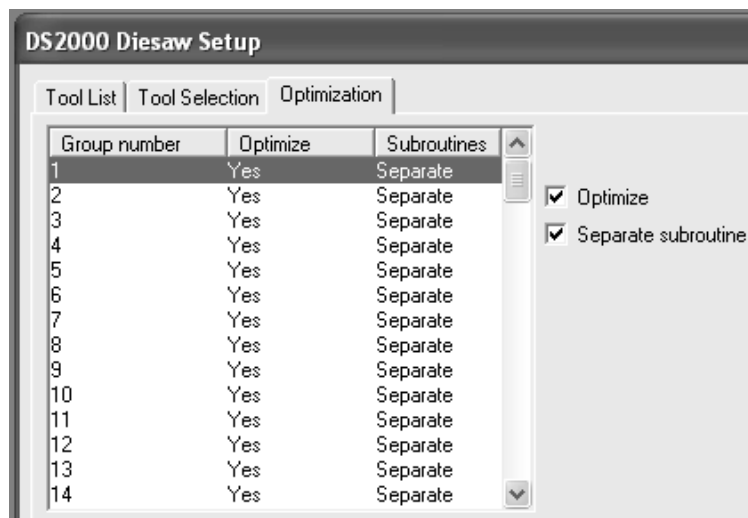

To turn off optimization for a group, select it and clear the **Optimize** checkbox. To turn it on, select it and check the **Optimization** checkbox.

Separate subroutine controls if each group will be in its own subroutine. If the box is checked, the selected group is independent. If the box is clear, the selected group shares the same subroutine as the previous group.

CAM Output of Rubber Sheets

A CAM Tooling Setup catalog entry should be set up for the following line types for output to (for example) a waterjet rubber-cutting machine.

Table: Rubber CAM tooling setup

Line type	Name	Usage
Type 220	Rubber inside edge	If using different logical tools for the inside edge and the outside edge. Otherwise make them the same.
Type 221	Rubber outline	
Type 222	Rubber name	Cuts the numbers in the rubber pieces, if Show element numbers is selected on the Processing page in the Output.
Type 97	Usable limit of sheet	If required, cuts the outline of the sheet area used.
Type 98	Sheet size	Map to Size only to see the sheet size.

Shown below is an example CAM Tooling Setup catalog entry.

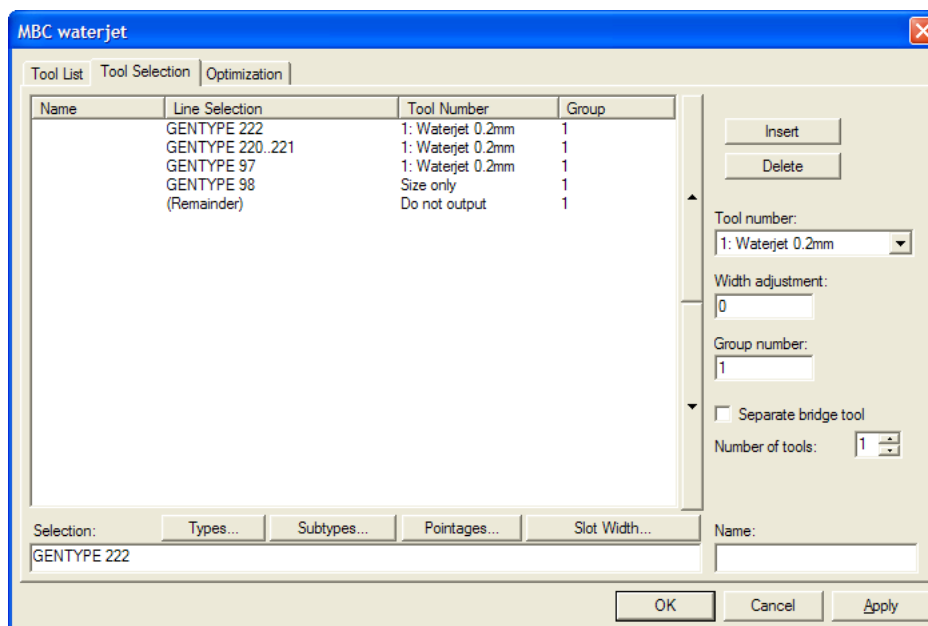

CAM Output of Steel Counters

The CAM Tooling Setup Catalog entry for a steel counter output should list the widths and depths of the available tools on the milling machine on the Tool List tab and select the counter line types on the Tool Selection tab.

- With grain crease (type 100) and Cross grain crease (type 101)
- With grain crease and Cross grain crease with the different subtypes used for different depths
- Counter mill outline (type 110) for embossing and reverse crease
- Name tool (type 107)
- Positioning holes tool (type 108), Position holes tool 2 (type 111), and Counter slot (type 112)
- Periphery (for the frame) (type 103)

Do not output other line types such as cut/crease.

To output the counter channel as a single line, set the Tool type to **mill**, the Width to **10** mm (wider than the channel), and **Partial depth**.

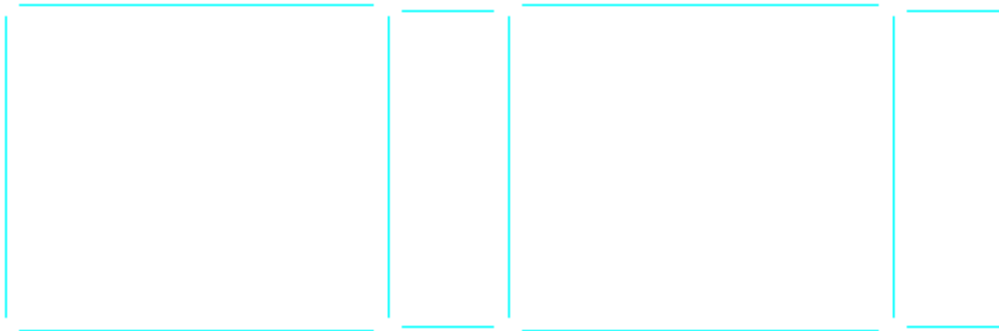

To fill the channel with multiple passes, set the Tool type to **mill**, the actual width of the tool, **Partial depth**, **Include fill**, and a small **Overlap** of 0.1.

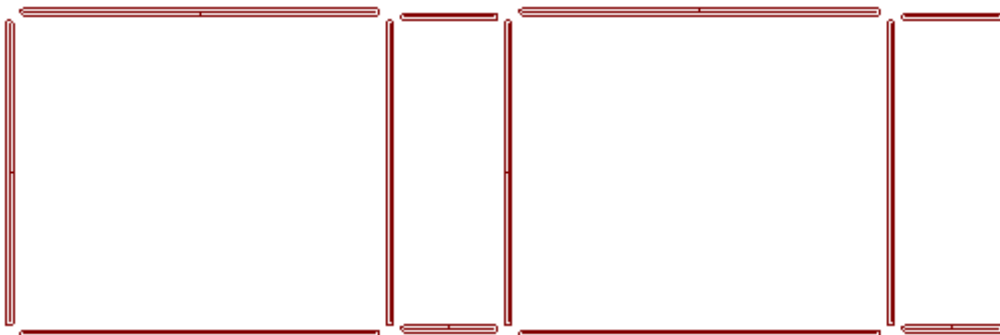

The milling path can be calculated either by ArtiosCAD or the milling machine. To output a mill area as a single outline, set the Tool type to **line**.



To output a mill area as being full of multiple passes, set the Tool type to **mill**, set a sensible **Width**, **Partial depth**, **Include fill**, and a slight **Overlap**.

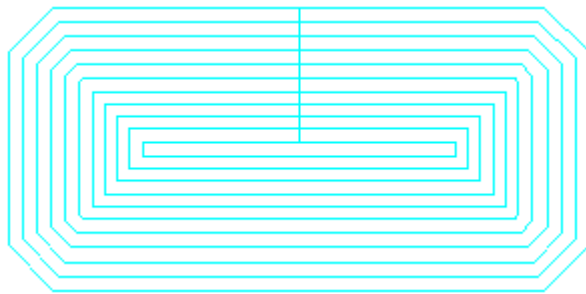

ArtiosCAD can output the same path with more than one tool. To add another tool, increment **Number of tools** for this selection on the Tool Selection tab.

- To mill an interior area with one tool and mill its periphery with another, assign two milling tools with different widths and the same depth.

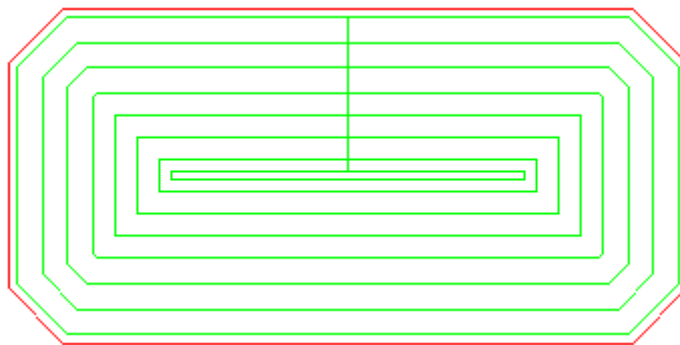

- To add a finishing tool to the edge of the mill area, set the finishing tool to Tool type **line** to trace the outside of the mill area.

Output sequence is controlled by the group number on the Tool Selection tab, with lower groups being Output before higher groups. To have the periphery cut last, give it the highest group number.

Note: ArtiosCAD mills areas with curved reverse creases and curved reverse cuts as if they were straight lines.

Specifying a rotary die in a press definition

When you first create a press, ArtiosCAD assumes it is flat by default. To specify a rotary dieboard configuration, double-click the **Rotary Shrink Stretch Factors** entry in the parameter set for that press.

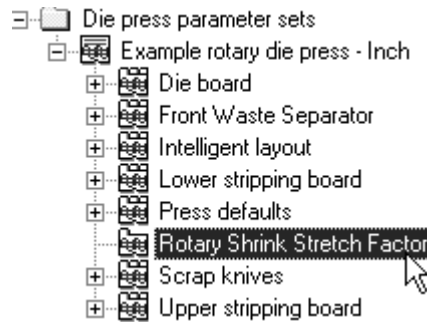

In the Rotary Shrink Stretch Factors dialog box, check the **Rotary Dieboard** checkbox and fill in the values for the **Wood Thickness**, **Cylinder Diameter**, **Design to Wood Level Shrink**, and **Cylinder to Wood Level Stretch** fields with the proper values.

Once the fields are complete, click **OK** to return to Defaults or click **Cancel** to cancel.

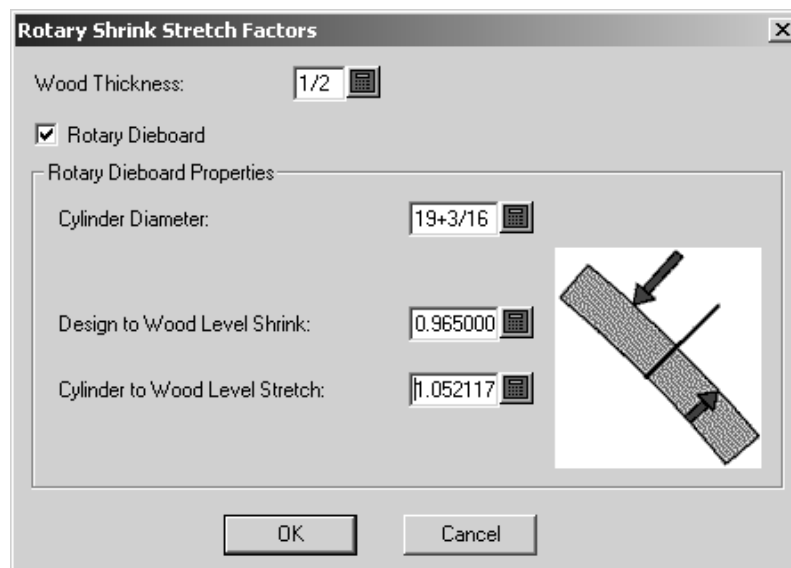

Changes to Rotary Die Press Defaults

Because of the Rotary Die Board tool, ArtiosCAD Defaults have changed slightly. In the **Die Board** catalog for a given press in Die Press Parameter Sets, the Wood Dimensions tab has changed, In the **Press Defaults** catalog, the Hole Patterns tab has changed.

On the Wood Dimensions tab, you can now set:

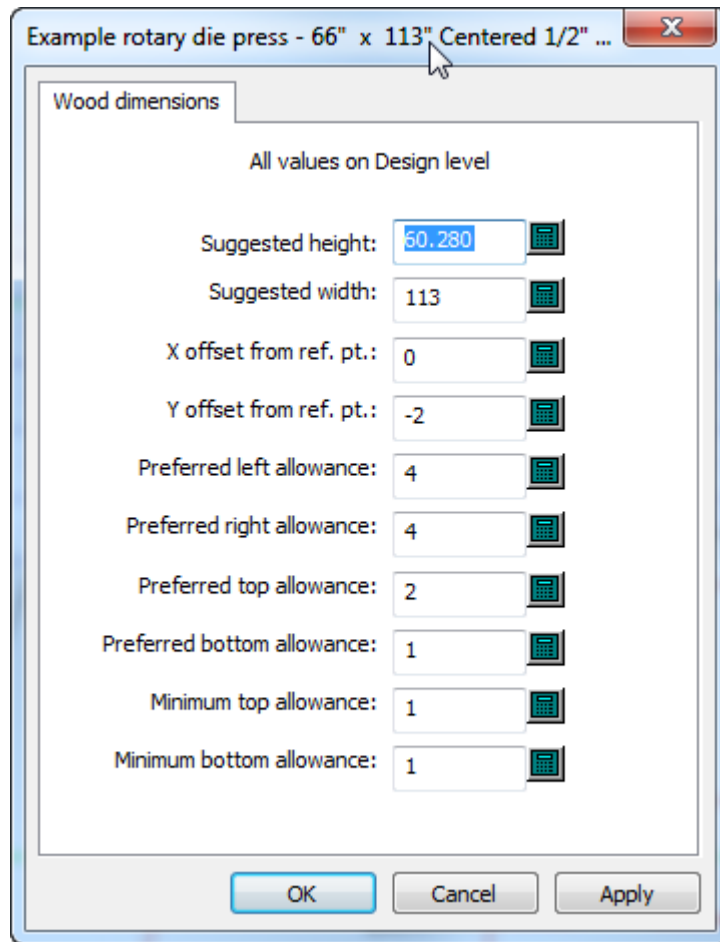

- Suggested sizes
- Offsets
- Allowances. These allowances may not be negative (which applies for flat dies as well). You can set the bottom allowance, the minimum bottom allowance, and the minimum top allowance.

All values must be for the design level, not the cylinder or wood levels. These depend on the shrink and stretch factors defined in the Rotary Shrink Stretch Factor catalog for the press definition in the parameter set. If you change those factors, you must save Defaults before ArtiosCAD changes these wood dimensions.

On the Hole Patterns tab, you can now set:

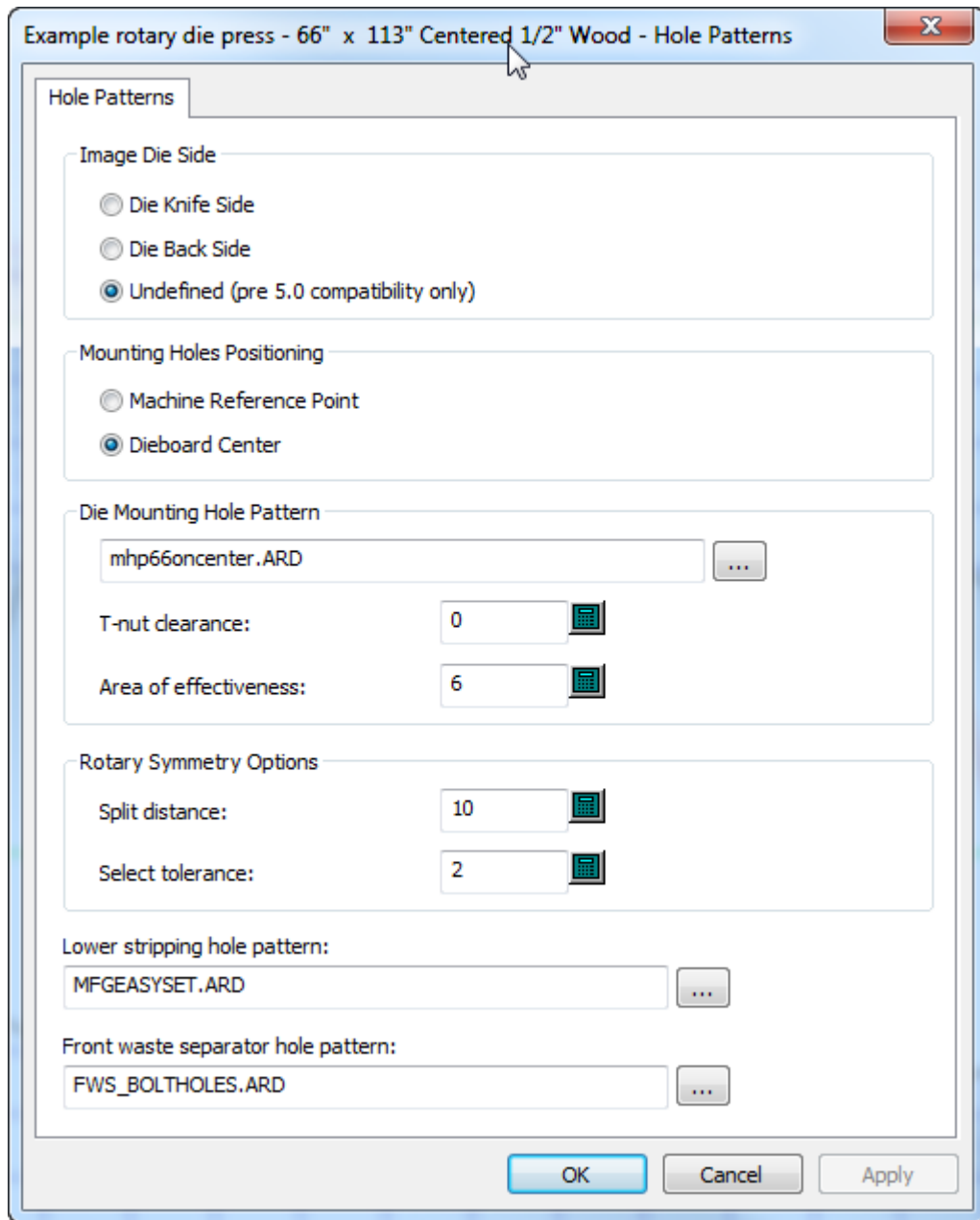

- The radius of the area of effectiveness for mounting bolts
- The split distance and select tolerance for Die Symmetry when using the Rotary Die Board tool. ArtiosCAD considers holes within the split distance from a split and within the select tolerance of the originally selected hole to be symmetrical.

When you use **Specify allowances** on the Wood edge tab for a rotary die press definition in a die press parameter set, the die board is not positioned by the machine reference point or centered on the layout; it really uses the allowances. ArtiosCAD ignores the **Centered dieboard** option when you use **Specify Allowances**.

Hole Catalog

Holes are used in manufacturing to attach the boards to the presses. There are three types of holes: **General** holes, **Drill** holes, and **Oblong** holes. As holes utilize subtypes, configure subtypes before adding holes.

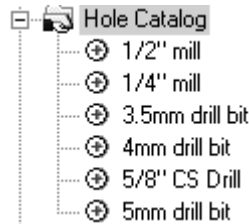

Adding a hole to the Hole Catalog

To add a hole, right-click **Hole Catalog**, and click **New > Data** from the context menu. Give the new hole a name and double-click its entry to open its Properties dialog box. Edit the values as appropriate. The **Diameter Y** field is available when the hole type is set to **Oblong Hole**. **Counter Sink Diameter** is available only when the **Counter Sink** checkbox is checked. Set the **Subtype** fields as appropriate.

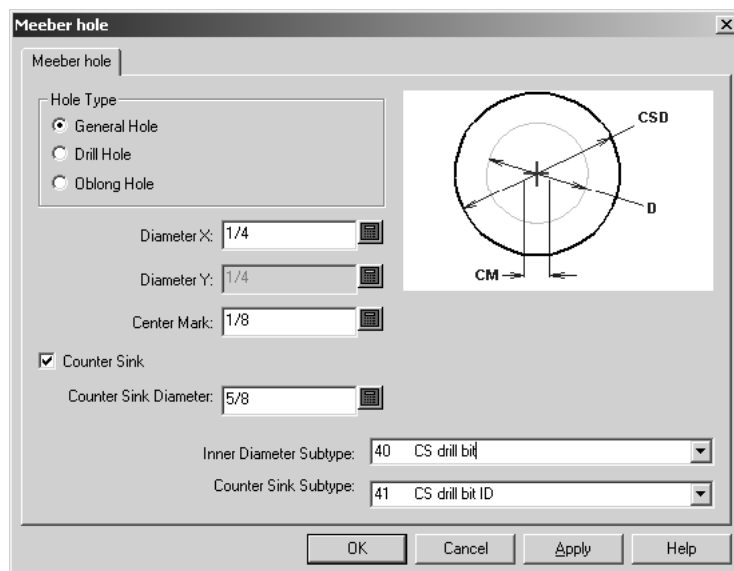





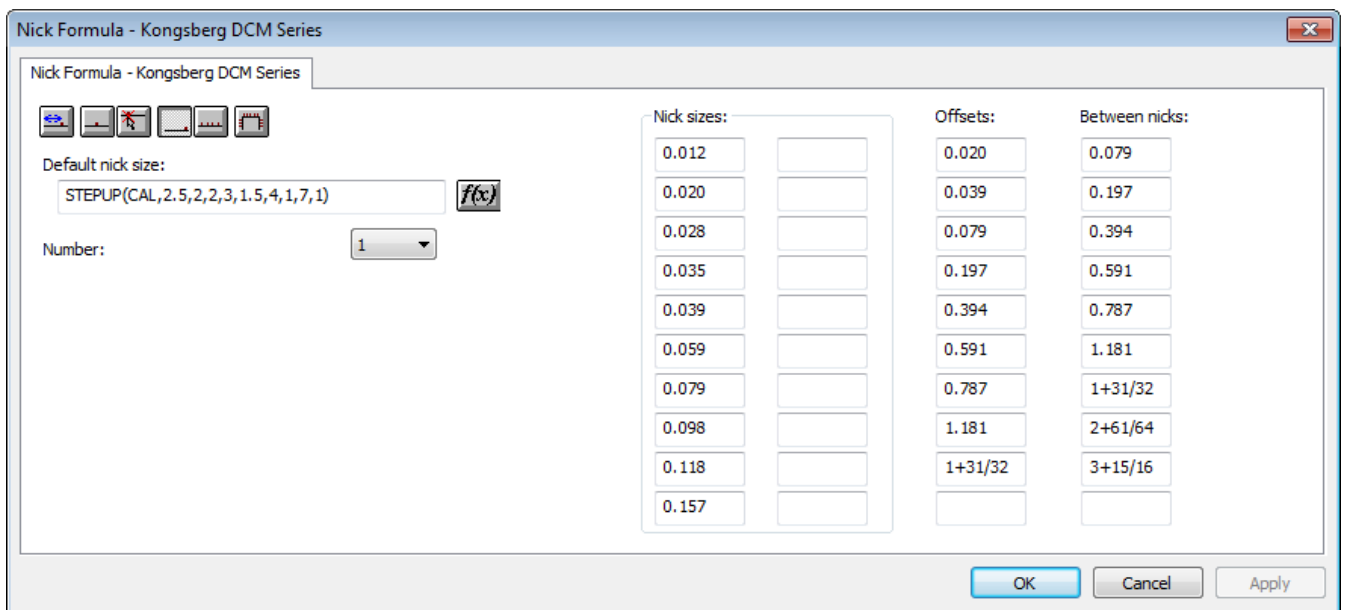

Nicks

Nick formulas

Nick formulas are stored in the Nick Formulas Catalog. Sample entries are contained in the Artios folder. The default nick formula is chosen in either the Manufacturing or Single Design parameter set. Shown below is a Kongsberg nick formula.



The six placement buttons at the upper left of the tab set the default placement option for nicks when the **Add Nick** tool is activated.

-  **Offset** sets the nicks so that they offset from the nearest endpoint of the line or arc.
-  **Center** places the nick in the center of a line or arc.
-  **Anywhere** places the nick at the point you click.
-  **At the end of the line** places the nick at the end of a line.
-  **Fill line** fills the line or arc with evenly spaced nicks with **Between sets** setting the distance between groups of nicks if the number is set to more than 1.
-  **Fill path** fills a path with nicks as controlled in the Fill Path Options group.

Fill Path Options

Between sets:

Split at corners

Corner offset:

Minimum radius:

Avoid end points

- **Between sets** sets the distance between sets of nicks.
- **Split at corners** keeps the nicks out of corners by the **Corner offset** distance. If a blend is larger than the **Minimum radius**, ArtiosCAD considers it a corner.
- **Avoid End Points** keeps the nicks from being on the shared end-point of two lines.

The fields in the **Nick sizes:**, **Offsets:**, and **Between nicks:** columns set the values for the drop-down list boxes when the **Add Nick** tool is activated.

The **Number** field sets the default number of nicks to add when the **Add Nick** tool is activated.

Set the default nick size to use by entering either an absolute value or a formula in the **Default nick size:** field. If no default size is set, the **Add Nick** tool and the Bridging properties dialog box default to the first defined size.

Nick styles

ArtiosCAD can represent nicks as a single line, a double line, a text label, a workspace you designate, a centered line, a centered line with text, or as a parallel line along the nick. You can configure different ways for nicks to be represented based on their size. Nick Styles are configured in the Nick Styles Catalog. You can either modify the default nick styles in the Artios folder or you can create your own.

By default, a newly-created nick style has only one entry in it. This one entry defines how all nicks are shown.

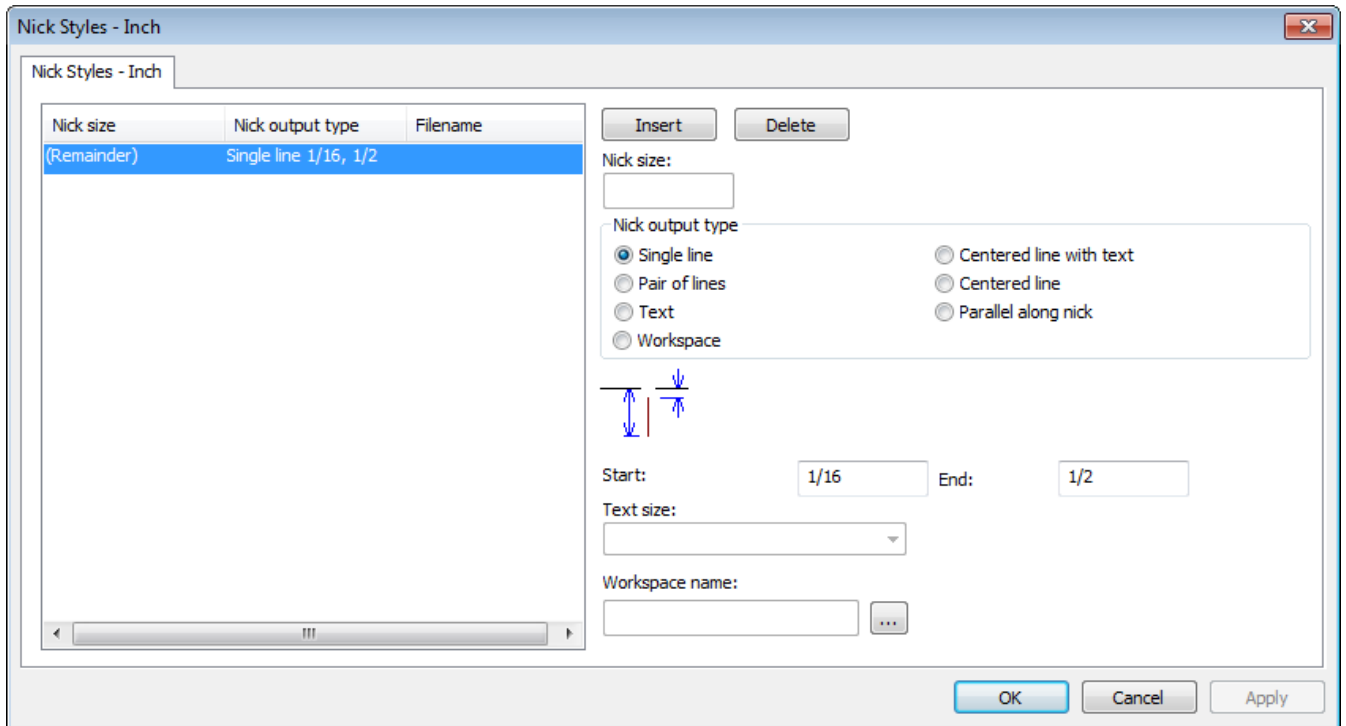

Insert and **Delete** add conditions for nick sizes. Select an entry in the list before clicking either.

The option buttons in the **Nick Output Type** group - **Single line**, **Pair of lines**, **Text**, **Workspace**, **Centered line with text**, **Centered line**, and **Parallel along nick** - control the type of nick made. **Centered line** and **Parallel along nick** are meant for outputting to a rule bender and display a mark for half split nicks (where there is a nick straddling the intersection of two end-to-end lines). For the Centered line styles, the line is a fixed length plus a multiple of the nick width.

The values in the **Start** and **End** fields set the length of the line(s) representing the nick. The value in the **Start** field sets the distance between the line containing the nick and the start of the line representing the nick. Use a negative offset to have the nick representation cross the design line. The value in the **End** field sets the distance between the line containing the nick and the end of the line representing the nick. The line(s) representing the nick are always drawn perpendicular to the line containing the nick.

The **Workspace name**: field is available only when the **Nick Output Type** is set to **Workspace**. In this field, enter the name of the workspace to use to indicate a nick, or use the **Browse** button (...) to browse for the nick workspace. The workspace must have the center of the nick representation as the origin of the workspace (where the two construction line axes meet). The line type used to draw the nick workspace is ignored; the nick is drawn as a nick line type. Anything other than lines and arcs in the nick workspace is ignored.

Add the size of the nick as text to the nick by using the **Text** nick output type in a selected Nick Style in Defaults. Set the size of the text in the **Text Size**: drop-down list box, which is available only when the Nick output type is set to Text.

When two nicks are close together, and the nicks are represented by workspaces, if the two workspaces would overlap, the second nick is shown as a line.

When zooming in on nicks, the mark size and text size increase. If two nicks are closer together than the width of the text or workspace label, the text or label is shown only once.

When a text nick style is used in a CAM Output, the text for the nick size may be converted to lines according to how text is handled by the Output. If the **Line text** option is selected, the nick size text uses the same tool number as the nick line type.

To have ArtiosCAD display the nick sizes on a printed or plotted output, make a Nick Style of all workspaces which are based on the nick size. In each workspace, enter the number, and then convert it to lines using the Line Text tool.

Table: Nick Examples

Output Type	Parameters	Output
Single line	Start = 0, End = 1/8	
Single line	Start = 1/32, End = 5/32	
Single line	Start = -1/8, End = 1/8	
Double lines	Start = -1/8, End = 1/8	
Workspace	Workspace:	
Workspace	Workspace: , Start = 1/16, End = 5/16	
Workspace, with two nicks close together	Workspace: , Start = 1/16, End = 5/16	
Workspace	Workspace: 25	

Output Type	Parameters	Output
Text	Text size in points	0.0984



When you have finished modifying the nick style, click **OK** to return to Defaults keeping your changes, or click **Cancel** to return to Defaults ignoring your changes.

Standard Sheet Layout

Parameters and standard sheet sizes for Standard Sheet Layout are configured in the Sheet Utilization catalog in Defaults.

- + Nick Formulas
- + Nick Styles
- + Output Destination
- + Outputs
- + Plotting Style Catalog
- + Printing press parameter sets
- + Prompted text table
- + Property defaults
- + Report Catalog
- Sheet Utilization
 - Sheet Layout Parameters
 - Standard Sheet Sizes
- + Shortcuts
- + Single design parameter sets
- + Special rule types
- + Startup defaults
- + Style catalog
- + Subtype Mapping Catalog
- + Tack Bridging

Sheet Layout Parameters

Double-click **Sheet Layout Parameters** to set the defaults for the trim, gutters, nest types, and other options to use in Standard Sheet Layout as shown below.

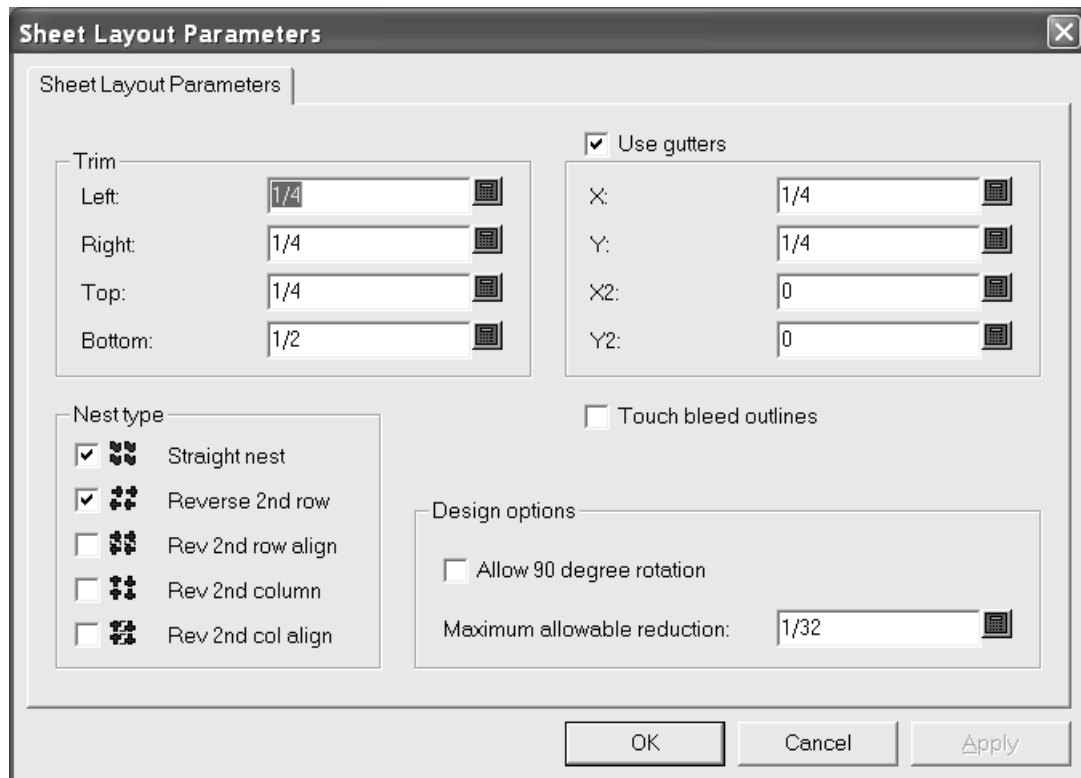

In the **Trim** group, the fields set the trim tolerances at the edge of the sheet. Set them to be less than the maximum values for the presses used to produce the layout.

Use gutters inserts gutters between designs in the nest when it is checked. When it is clear, the single designs touch. The values in the **X** and **Y** fields set the gutters in X and Y for the first and second rows and columns of single designs in the layout. The values in the **X2** and **Y2** drop-down list boxes set the gutters between the second and third rows and columns. These are repeated as appropriate between all the rows and columns in the layout.

In the **Nest type** group, the checkboxes control the kinds of nests made automatically. Select the checkboxes next to the type of nests to use; clear those next to undesired nests.

Touch bleed outlines controls whether the designs touch using the bleed outlines or the edges of the designs. If **Use gutters** is enabled in conjunction with **Touch bleed outlines**, the gutters are inserted between the bleed outlines instead of the edges of the designs.

In the **Design options** group, **Allow 90 degree rotation** lets designs rotate so they are cross-grain; the sheet grain runs in the longer direction. **Maximum allowable reduction** is the maximum distance that could be shaved off each design in order for another row or column to fit on the sheet. If such a cutback is possible in each design, a row or column will overlap the edge of the sheet when a layout is suggested and there will be values in the various **Reduction** fields of the Sheet Layout Results dialog box.

Click **OK** to save the changes, or click **Cancel** to ignore them and return to Defaults.

Standard Sheet Sizes

Double-click **Standard Sheet Sizes** to configure the defaults for standard sheets used by Standard Sheet Layout.

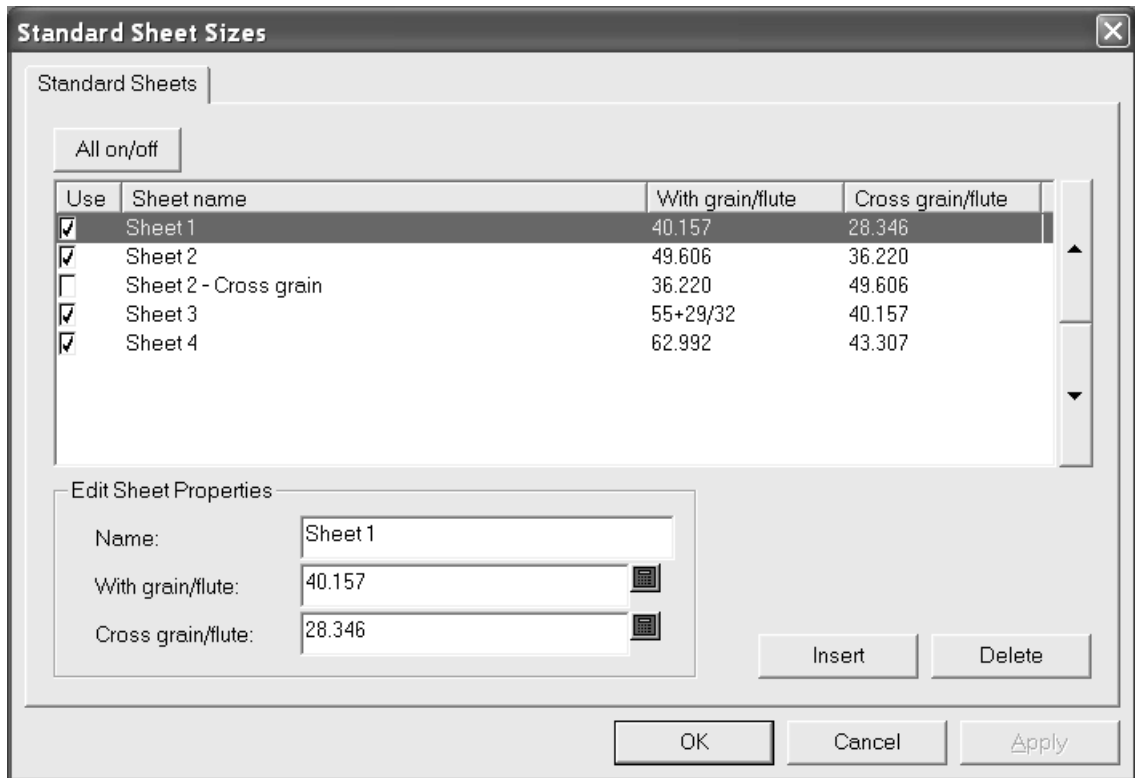

To use a sheet for possible layout solutions, check its box in the **Use** column. To disable its use, clear the checkbox. To toggle the usage of all sheets at once, click **All on/off**.

The arrows on the side of the dialog box move the currently-selected sheet up and down in the list of sheets. The order of sheets on this tab is the same order used to present layout results.

To edit a sheet, select it, and change the fields in the **Edit Sheet Properties** group. The fields change as soon as you click another field

To add a sheet, click **Insert**, and then edit the fields in the **Edit Sheet Properties** group. Set the checkbox in the **Use** column as desired.

To delete a sheet, select it, and click **Delete**.

To save the changes to the standard sheets, click **OK**. To discard the changes and return to Defaults, click **Cancel**.

Configuring Intelligent Layout defaults and Costing/ Estimating

In order to work optimally, Intelligent Layout and Costing/ Estimating must have their defaults configured accurately. These defaults should match the real-life manufacturing conditions used to make the containers.

Configuring cost centers

Costing/Estimating uses the general concept of a cost center to allow costs to be configured. A cost center represents a machine such as a printing press, die press or folder-gluer, and/or a material cost such as gold stamping or shipping. Machine costs are calculated per hour and material costs are calculated per sheet or per carton. ArtiosCAD supplies some example cost centers in Intelligent Layout Defaults, and you are expected to modify these and add your own cost centers to suit your needs.

To view or edit cost centers, do the following.

1. Start ArtiosCAD.
2. Click **Options** and **Defaults** to open the Defaults dialog box.
3. Click the plus sign next to Intelligent Layout defaults to view its contents.
4. Double-click **Cost centers**. The first cost center will be selected by default.

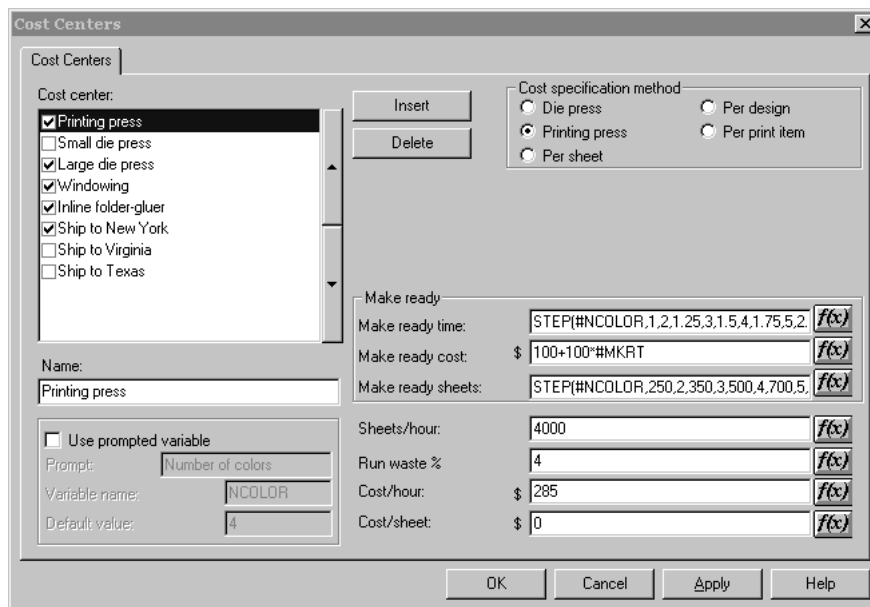

The groups and options shown depend on the option button selected in the **Cost specification method** group.

5. Make the desired changes and then click **OK** to save them or **Cancel** to ignore them.

The items in the Cost center dialog are explained in the following list:

Table: Cost Center Dialog Box

Item	Explanation
List of cost centers	The list of cost centers must be arranged in the order they are used. The output of one cost center is the input to the next. When the checkbox is off, the cost center is an option, available to be selected but is not turned on by default.
Up arrow, down arrow	Moves the selected cost center up or down in the list
Name	Changes the name of the selected cost center
Insert	Inserts a new cost center above the selected one.
Delete	Deletes the selected cost center
Per sheet	The cost center applies to sheets, for example a sheeter.
Printing press	Works the same as a sheet cost center, but identifies the printing press cost center to be reported separately.
Die press	Works the same as a sheet cost center, but identifies the die press cost center to be reported separately.
Per design	Cost center such as a folder-gluer, where make ready is needed for each different design, and a smaller make ready is needed for a different print item of the same design.
Per print item	Cost center such as windowing, if the windows were different on each print item. There is a separate make ready for each print item.
Use prompted variable	Only if a variable is to be associated with this cost center. For example FGD = folder-gluer degree of difficulty, or NCOL2 = number of colors for a second printing press, see note. The variable is added to the Prompted Variables tab of the Quantities and Costs dialog if this cost center is included.
Prompt	Prompt/description of this variable
Variable name	Name of the prompted variable to be used in expressions. A prompted variable can be used in expressions such as make ready and speed, inside the PVAR function. For example, the make ready time of the printing press is defined to be 1+PVAR(NCOLOR)/2, that is, 1 hour plus 1/2 hour for each color. The name of the variable can use up to 6 letters and digits and must start with a letter.
Default value	Default value of the prompted variable

Item	Explanation
Make ready time	Expression for the make ready time in hours
Sheets/hour	<p>The normal speed of the machine when it has reached its optimal speed.</p> <p>The theory is that the machine runs for a while at a slower speed for the first few sheets while it is brought into alignment, and then the speed is increased to its optimal speed. For a multi-step ramp up in speed, use the SPEEDSTEP function.</p>
Run waste %	The percent waste while running. A machine such as a printing press may periodically go out of alignment and waste some sheets.
Cost/hour	Cost of the machine per hour while running. Does not include the cost of the machine during make ready, which is separate.
Cost/sheet	Additional material cost per sheet apart from the board cost. If the cost specification method is per print item, this label changes to Cost/carton, for example the cost of a window in each carton.
	Opens an expression configuration dialog box. See the following section.

Changing Cost Center expressions

Clicking the **f(x)** button in a cost center expression leads to an expression configuration dialog box. For example, clicking **f(x)** for the **Make ready time** expression:

(STEP(#NCOLOR,1,2,1.25,3,1.5,4,1.75,5,2.25,6, 2.75,7,3,8,3.5))

leads to:

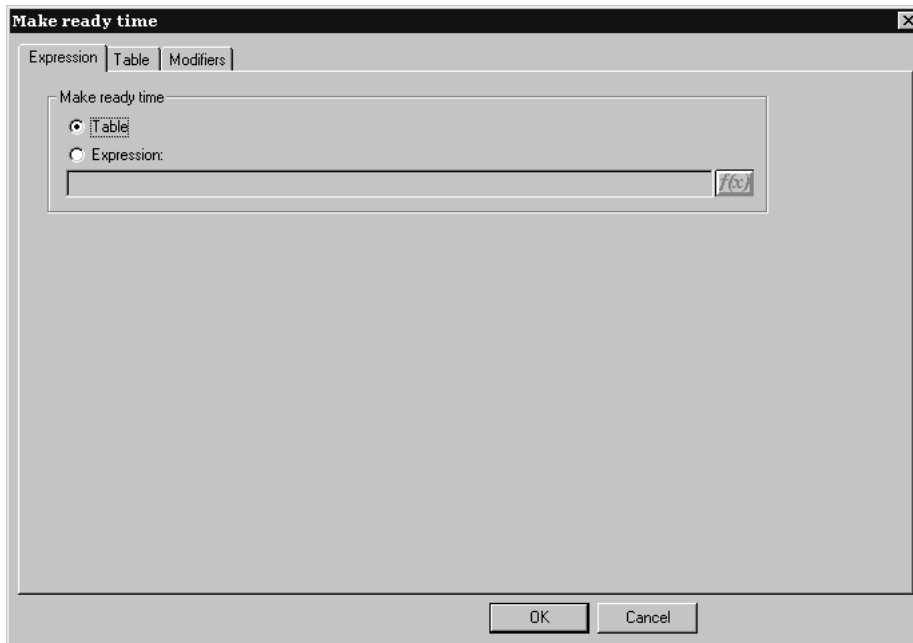

This dialog box lets you choose how the value for the selected field is determined - by a table of conditions or by an expression; in this example, the method is set to table. Only when the method is set to table is there a **Table** tab in the dialog box.

To set the value using an expression, select the **Expression** option and type the expression in the field. Click the **f(x)** button to access the Edit Expression dialog box.

Creating a table to set the value

When configuring a cost center expression, you can create a table of values to use when certain conditions are met. In the picture below, the make-ready time is determined by the number of one-ups and the board caliper.

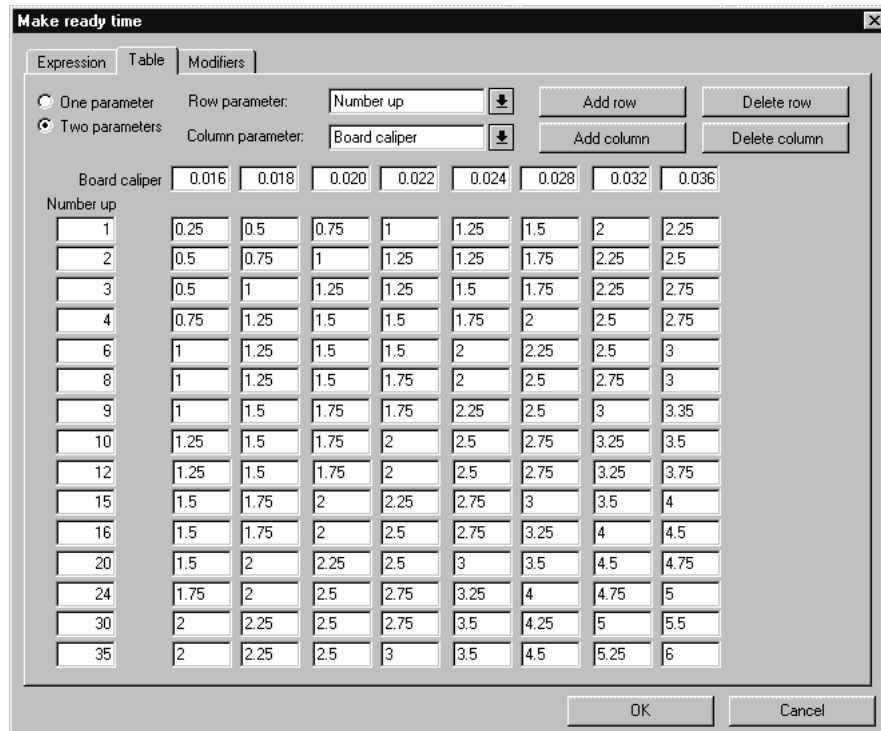

The **One parameter** and **Two parameters** option buttons control how many conditions must be met when setting a value. When **One parameter** is selected, everything relating to columns is unavailable; you may only add and delete rows.

The **Row parameter** and **Column parameter** drop-down list boxes set what is being used to determine the conditions of the table. You may type expressions of your own choosing in this box. If ArtiosCAD recognizes the expression (CAL, for example), it translates the expression to its text equivalent ("Board caliper").

Add row, **Add column**, **Delete row**, and **Delete Column** do what they say. There can be up to 18 rows and 14 columns. If the cursor is in any of the edit boxes, **Delete row** deletes that row; otherwise the bottom row is deleted. **Delete Column** deletes the column the cursor is in; otherwise, it deletes the rightmost column.

The f(x) button for the **Sheets/hour** field leads to an expression configuration dialog box which has three entries which behave exactly as those described above.

Modifiers for cost center expressions

A **modifier** allows adjustments to be made to an expression in certain situations. For example, a modifier could use this logic: **if the caliper is 0.016" or less, add 10%**. Modifiers can do the following to the output of the expression:

- Add a percentage
- Subtract a percentage
- Add a value
- Subtract a value
- Multiply by a value

- Divide by a value
- Set a minimum value
- Set a maximum value

To add a modifier to a cost center expression, do the following:

1. Click the **f(x)** button for that expression and then click the **Modifiers** tab.

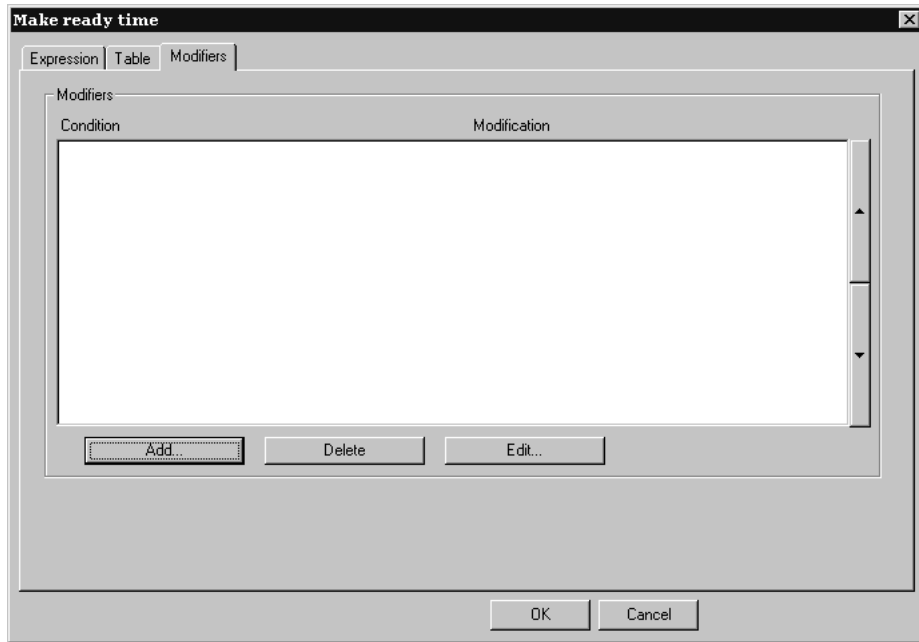

2. Click **Add** to add a modifier. A list of modifiers appears:

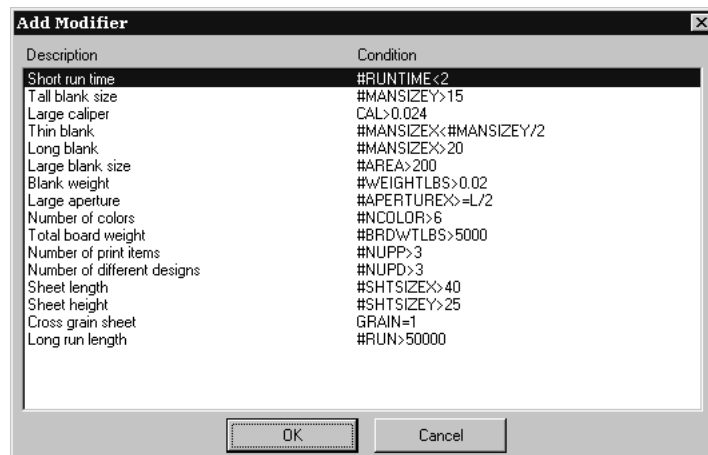

3. Choose a modifier to add to the expression (for this example, choose **Large caliper**) and click **OK**. ArtiosCAD will return to the Modifiers dialog box.

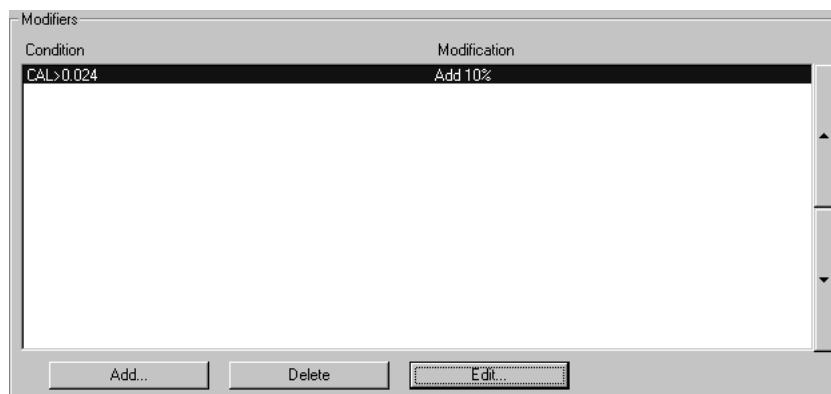

4. Click **Edit** to open the Edit Modifier dialog box.

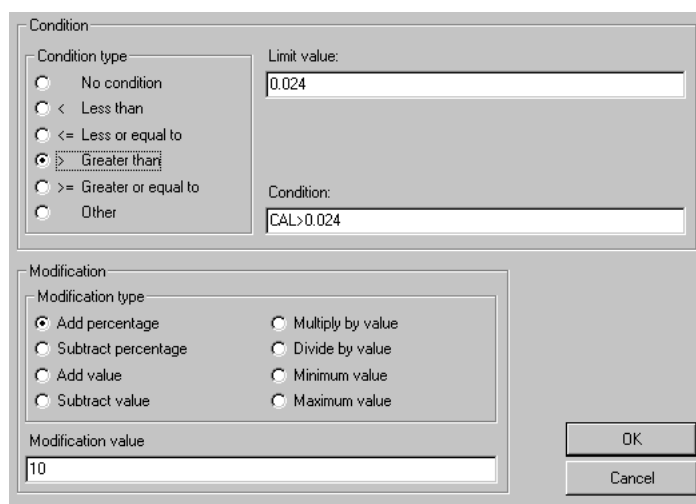

The option buttons in the **Condition type** group let you quickly change the condition with a single mouse click. If you select **No condition**, the **Limit value** and **Condition** fields are unavailable. Changing the condition type option button automatically updates the expression in the **Condition** field. The **Condition type** and the **Limit value** combine into the **Condition**.

The option buttons in the **Modification** group determine the operation of the modifier. The amount of the modification is set in the **Modification value** field.

5. Click **OK** to accept the changes to the modifier or **Cancel** to ignore them. ArtiosCAD will return to the expression configuration dialog box.

Notes on Intelligent Layout Defaults

Most defaults have the option of User defaults overriding Shared defaults. This does not work well for Intelligent Layout because the cost centers from Shared Defaults and User Defaults are mixed together. We recommend that you only use Shared Defaults for Intelligent Layout.

The order of the cost centers is important. The **Per design** and **Per print item** cost centers must be after the printing press and the die press.

If you set up a cost center with a prompted variable that has a default value, for example a printing press with 2 colors, and then want to run a layout with three colors, your first impulse might be to double-pass the sheet and use the cost center twice. This approach, however, will result in 4 colors being used in the calculations. Make sure to set up a cost center with prompted variables that have defaults specific for each case you may encounter.

Overview: Setting up a multi-color printing press cost center using a table

The following overview illustrates how to set up a cost center containing variable information. We are going to set up the following information:

Number of colors	2	3	4	5	6	7	8
Make ready time in hours	1.5	1.75	2.0	2.5	2.75	3.5	4.0

Note that you must enter time in hours, not hours:minutes. For example, 2 hours 45 minutes is represented as 2.75 hours.

1. Start ArtiosCAD.
2. Click **Options** and then click **Defaults** to open the Defaults dialog box.
3. Click the plus sign next to **Intelligent Layout defaults** to view its contents.
4. Double-click **Cost centers**. The first cost center will be selected by default.
5. Click **Insert** to create a new cost center called New cost center.
6. Change the name in the **Name:** field from New cost center to **My 8 color press**.
7. Set the **Cost specification method** to **Printing press**.

The Intelligent Layout Defaults dialog should look as follows:

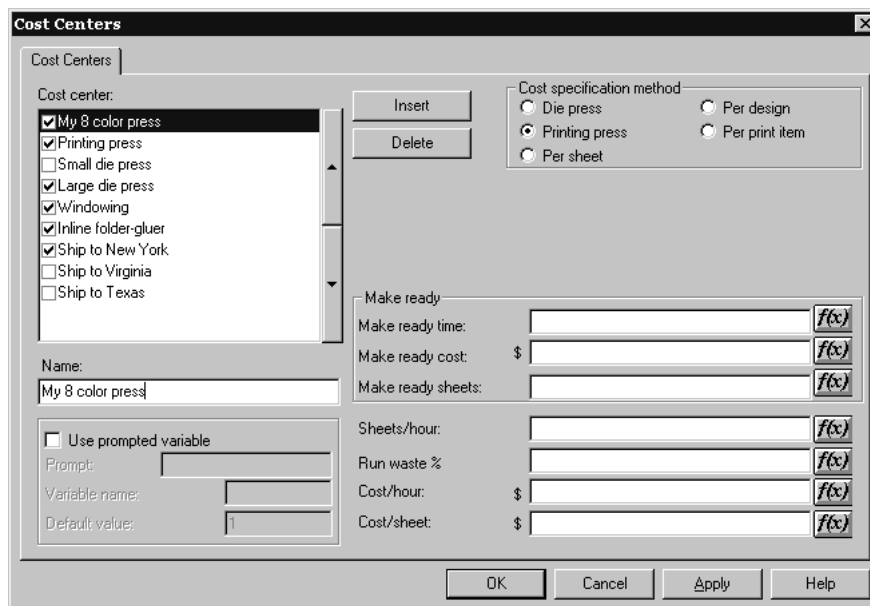

- Click **f(x)** at the end of the **Make ready time:** field to set up a table of conditions for the number of colors. The expression configuration dialog box appears:



- Click the **Table** option button in the **Make ready time** group.
- Click the **Table** tab.



- Select **One parameter** and choose **Number of colors** for the **Row parameter**.

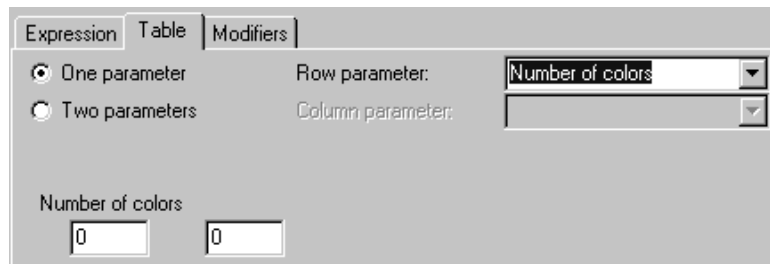

- Enter **2** and **1.5** in the first and second fields, respectively, under **Number of colors**. ArtiosCAD will change the 1.5 into 1+1/2.
- Click **Add row**. Enter **3** and **1.75** in the first and second fields of the new row.
- Repeat for the rest of the values in the table.
- When the table is complete it should look like this:

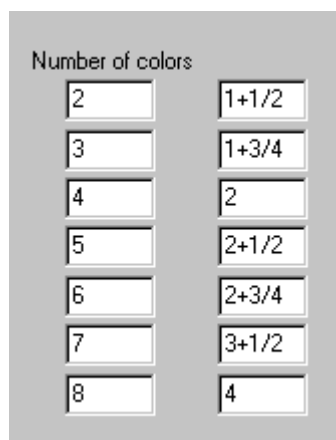

16. Click **OK** to finish configuring the table for the make ready time, and proceed to configuring the rest of the cost center.

Useful Functions for Cost Center Expressions

STEP(variable, value1, limit1, value2, limit2,..., limitn, valuen)

Returns value1 when variable < limit1

value2 when limit1 <= variable < limit2

value3 when limit2 <= variable < limit3

...

valuen when limitn <= variable

The STEP function and all its variations must have an even number of parameters, at least 4.

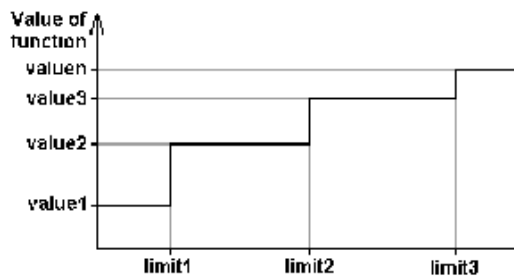

Note that we would not recommend that a step function be used for the speed of a machine because the run time of a machine using a step function like this would have discontinuities in its run time:

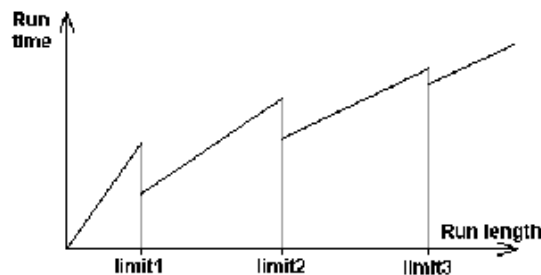

STEPUP(variable, value1, limit1, value2, limit2, ... , limitn, valuen)

Same as STEP except < and <= are reversed:

Returns: value1 when variable <= limit1

value2 when $\text{limit1} < \text{variable} \leq \text{limit2}$

...

valuen when $\text{limitn} < \text{variable}$

LINESTEP(variable, value1, limit1, value2, limit2, ..., limitn, valuen)

As a more sensible alternative to the STEP function for the speed of a machine, this function does a linear interpolation between data points, and avoids the discontinuities in the STEP function.

Returns: value1 when $\text{variable} \leq \text{limit1}$

Interpolation between value1 and value2 when $\text{limit1} \leq \text{variable} \leq \text{limit2}$

Interpolation between value2 and value3 when $\text{limit2} \leq \text{variable} \leq \text{limit3}$

...

valuen when $\text{variable} \geq \text{limitn}$

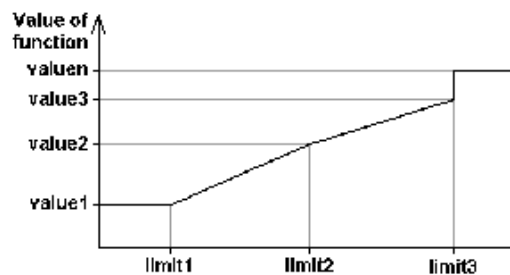

Note that to prevent a discontinuity at the last limit, the last two values should be the same, or the last value might be an expression.

SPEEDSTEP(#RUN,speed1,run1,speed2,run2, ..., runn, speedn)

The SPEEDSTEP function is an alternative for the speed of a machine (depends on how the speed is specified). The machine runs at speed1 for the first run1 sheets, runs at speed speed2 up to a run length of run2, and so on, and runs at speed speedn after the run length reaches runn. The function returns an average speed of the machine given the run length.

List of functions for configuring cost centers

This list of functions is accessible from the Cost Centers dialog box by clicking **f(x)** and then **Insert Library Function**.

Table: Functions for configuring cost centers

Function	Description
#SHTSIZEX	Sheet size X, current units (inches or mm).
#SHTSIZEY	Sheet size Y, current units (inches or mm).
#SHTSIZEWG	Sheet size with grain, current units (inches or mm).
#SHTSIZEXG	Sheet size cross grain, current units (inches or mm).
#CUTSIZEX	Knife-to-knife X of designs in the layout, in current units (inches or mm).
#CUTSIZEY	Knife-to-knife Y of designs in the layout, in current units (inches or mm).
#MANSIZEX	Design blank size X (manufacturing lines), in current units (inches or mm) of the current design. If sheet cost center, of the first design.
#MANSIZEY	Design blank size Y (manufacturing lines), in current units (inches or mm) of the current design. If sheet cost center, of the first design.
#MANSIZEWG	Design blank size with grain (manufacturing lines), in current units of the current design. If sheet cost center, of the first design.
#MANSIZEXG	Design blank size cross grain (manufacturing lines), in current units of the current design. If sheet cost center, of the first design.
#AREA	Area of design ignoring holes (zero if area fails) in current units (square inches or square mm) of the current design. If sheet cost center, of the first design.
#AREAH	Area of design minus holes (zero if area fails) in current units (square inches or square mm) of the current design. If sheet cost center, of the first design.
#RUN	(In the Intelligent Layout Parameters dialog). Run length for this cost center/item in number of sheets or number of cartons. (In a form or OCX control). Run length of the first cost center, usually the printing press.
#NUPD	(Design, item cost center) How many of this design on the sheet (Sheet cost center) 0

Function	Description
#NUPP	(Item cost center) How many of this print item on the sheet (Sheet or design cost center) 0
#NUP	Total number of designs on the sheet
#MKRT	Make ready time for this cost center/item
#MKRTA	(Design cost center) Make ready time for this cost center/item for additional items. (Sheet or item cost center) 0.
#BRDWTG	Board weight grams/square meter.
#BRDWTLBS	Board weight lbs/1000 square feet
#BRDCSTM	Board cost/1000 square meters
#BRDCSTFT	Board cost/1000 square feet
#BRDCSTKG	Board cost per kg.
#BRDCSTLBS	Board cost per lb.
#WEIGHTKG	Weight of one item (board only) in kg.
#WEIGHTLBS	Weight of one item (board only) in lbs.
#ITEMORD	(Item cost center) Ordered quantity of this item. (Sheet cost center) Ordered quantity of the first item. (Design cost center) 0.
RULELEN("TYPE 1")	(Design or Item cost center) Length of cuts in the design. (Sheet cost center or die cost) Length of cuts in the layout. Typically used in estimation of die cost. This calculation is context dependent for item cost centers. Note that it ignores double knife removal and stripping rules, because they have not been defined yet.
RULELEN("TYPE 2")	Length of creases in the layout. Also supports more general selection such as RULELEN("TYPE 1,3 RAD ..1/8")
PVAR(varname)	Value of prompted variable, e.g. PVAR(NCOLOR) or PVAR(CRW). Actual variable is CCEN.NCOLOR (per sheet) or CCEN.D[i].CRW (per design) or CCEN.P[i].MYVAR (per print item)
DESVAR(varname)	(Design or item cost center) Value of variable from design, e.g. DESVAR(L)

Function	Description
	(Sheet cost center) Value of variable from the first design. (If variable does not exist) 0
#NCOLOR	Number of colors for the printing press set in the Ink Coverage page.
#LBSKG	Number of pounds in a kilogram = 0.45359237
#KGSSTON	Number of kilograms in a short ton = 907.18474
#KGSLTON	Number of kilograms in a long ton = 1016.0469088
#SQMSQFT	Number of square meters in a square foot = 0.09290304
#LBSFTG	Number of (lbs/1000 sq. ft) in (g/sq. m) = 4.882427636383

Example Folder-Gluer Formula

To calculate the speed of a folder-gluer machine, suppose the belts on the machine run at 240,000 inches per hour. The cartons are carried through the folder-gluer side-by-side with a 1/2-inch gap between them. The blank size of a carton is given by the function #MANSIZEX and 1/2 inch is represented by #I/2, so the step distance between cartons is #MANSIZEX+#I/2. Dividing the speed of the belts by the step distance gives a speed (in cartons per hour) of:

$$240000 * \#I / (\#MANSIZEX + \#I/2)$$

However, suppose some cartons are more difficult to fold up and the machine has to run slower for these. Let us introduce a compensation factor in a prompted variable **Folder difficulty** which has values:

- 1 = Easy, Full speed 240000 inches/hour
- 2 = Moderate, Moderate speed 200000 inches/hour
- 3 = Hard, Slow speed 160000 inches/hour

To allow for this, the modified formula uses a step function of the Folder difficulty variable FGD (Folder Gluer Difficulty):

$$\text{STEP}(\text{PVAR}(\text{FGD}), 240000, 2, 200000, 3, 160000) * \#I / (\#MANSIZEX + \#I/2)$$

To use this, the estimator should enter the "Folder difficulty" for each design along with the number of colors for the job in the Prompted Variables tab in the Quantities and Costs dialog box:

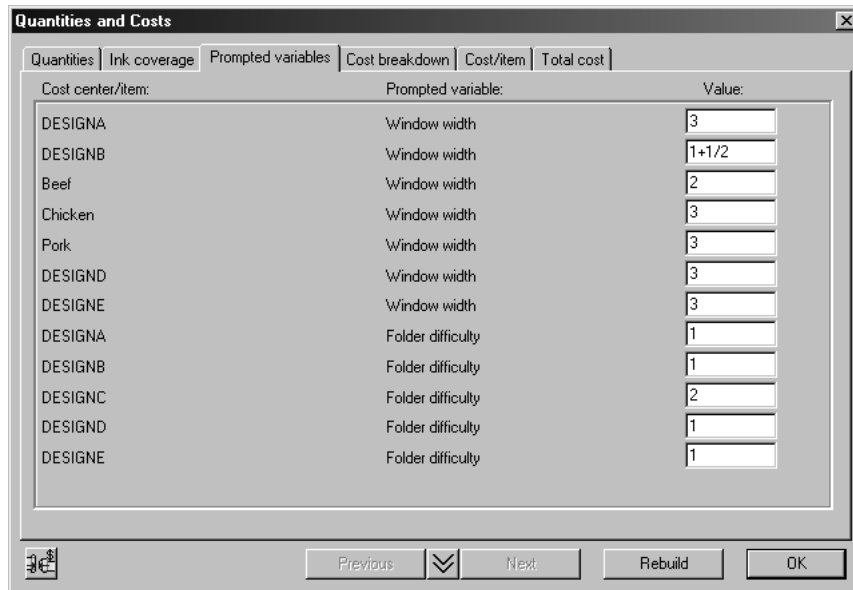

Run Length Calculation

The costing model used in ArtiosCAD has a list of cost centers in the order that the cartons are processed through the plant. Once the sheet has been processed in the die press, you no longer have sheets, and the remaining cost centers process print items (=cartons). Therefore, the sheet cost centers (printing press and die press) come before all the item cost centers (e.g. windowing, folder-gluer, shipping). Between the last sheet cost center (the die press), and the first item cost center, the sheet is divided up into print items depending on the number up of each item.

For the run length calculation, each cost center has an attribute of the number of sheets or cartons used in make ready, and a run-time waste percentage. For example, suppose you start with 100000 sheets, and the printing press uses 5000 for make ready, and has a run time waste of 4%, because it periodically goes out of registration. Then the run length of the printing press is $100000 - 5000 = 95000$, but because of the run-time waste the output from the printing press that is available for the next cost center is 96% of this, which equals 91200.

For each cost center in the list, the input to this cost center (= make ready + run length) is equal to the output of the previous cost center. When you enter ordered quantities, the calculation starts with the required delivered quantity which is the output from the last cost center, and works backwards, adding the run-time waste and make ready for each cost center, to come up with the number of sheets you need to start with.

To illustrate the run length calculation in Intelligent Layout, suppose you have ordered quantities 100000 of A and 200000 of B, and the sheet has 5 up of A and 8 up of B. The first thing we see is that with these proportions, we are going to get a larger overrun of A than of B. Suppose there was no make ready waste. There would be a run length of 12500 giving the required 200000 (100%) of B but 125000 (125%) of A. Therefore, for the run length calculation, we can ignore A with the larger overrun, and calculate the run length needed for B.

In our simple example, there are 3 cost centers:

Cost Center Name	Make Ready	Run Time Waste %
Printing Press	5000 sheets	4%
Die Press	3000 sheets	2%
Folder-gluer	500 cartons	0%

This can be represented in a diagram as follows:

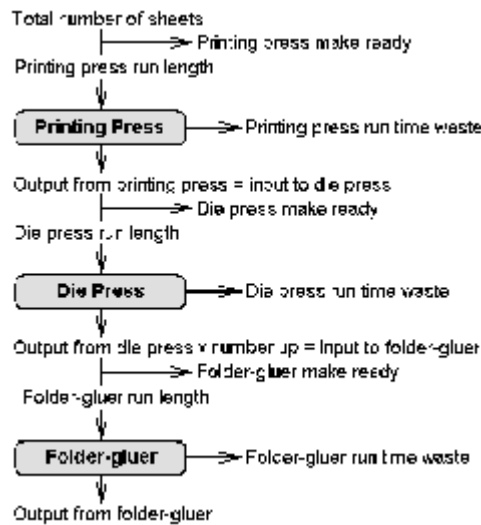

Working backwards, the delivered quantity of B is 200000. This is the output from the folder-gluer. The folder-gluer needs 500 cartons make ready, so the input to the folder-gluer is:

run length = 200000, make ready = 500, total = 200500

There are 8 of B on the sheet, so

Die Press output = 200500/8 = (rounded up) 25063.

To allow for the 2% run time waste, the input to the Die Press is:

run length = 25063 * 100 / (100-2) = 25564, make ready = 3000, total = 28564

To allow for the 4% run time waste, the input to the Printing Press is:

run length = 28564 * 100 / (100-4) = 29754, make ready = 5000, total = 34754

Therefore, the total number of sheets needed for this job is 34754.

Print Items and Folder-Gluer Make Ready

If you have several print items of the same design, you only need to set up the folder-gluer for the first item. The make ready for subsequent items is just the time needed to move them with the forklift and restart the machine. However, which is the "first item"? If the run lengths of the print items are different, Intelligent Layout picks the item with the largest overrun, and assumes that this is the "first item" you will use to set up the folder-gluer.

Configuring Outputs

ArtiosCAD provides many ways to configure Outputs to get the results your company's workflow requires.

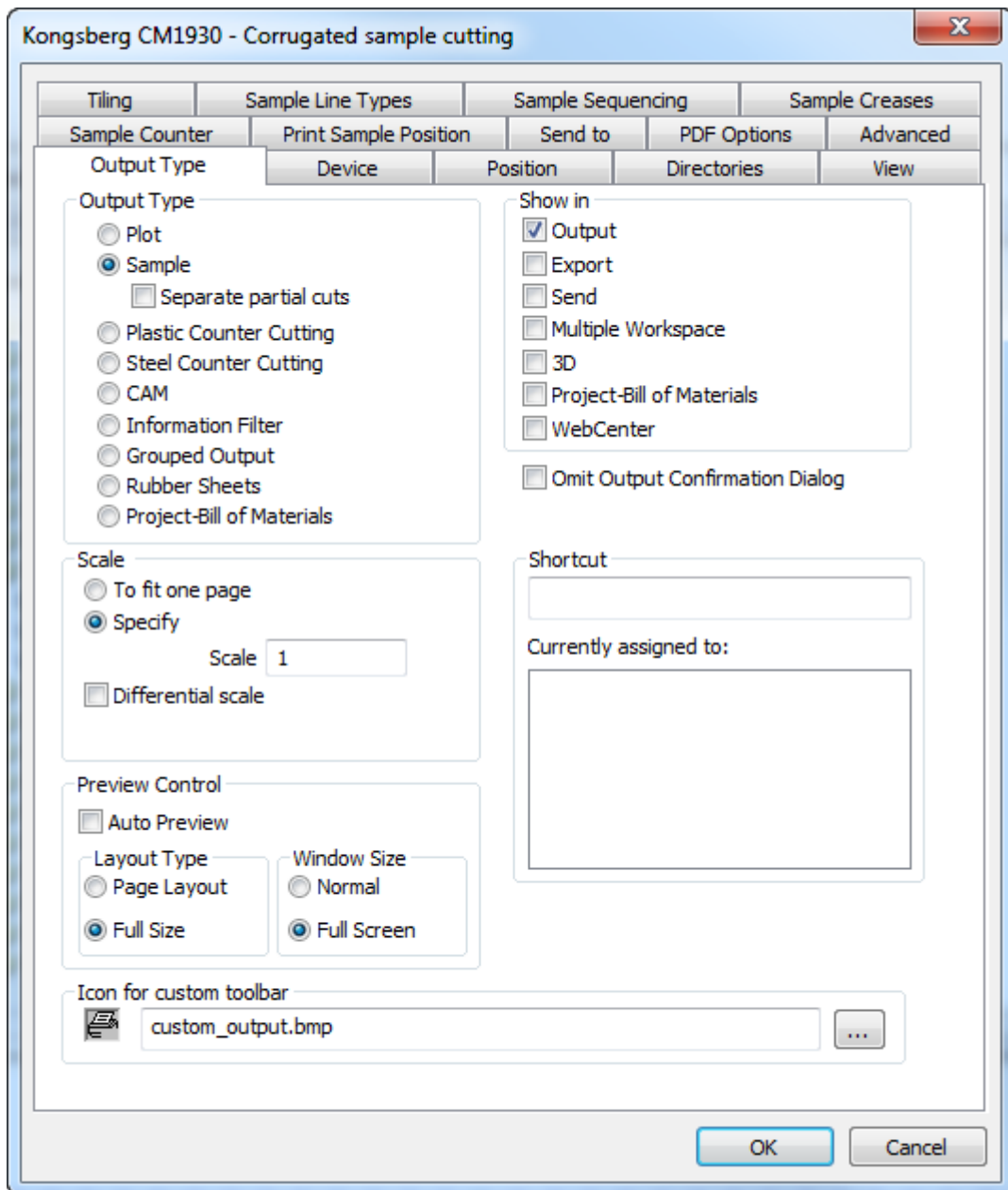

The tabs shown on an Output properties dialog box depend on the selection in the Output Type group. For example, in the picture above, there is no Reports tab, but if you set the Output Type to Plot, the samplemaking-related tabs disappear and the Report tab appears.

Note: Do not use a backward slash (\) in any Output name.

Note:

There are many sample Outputs in the Example Defaults catalog, accessed by clicking one of the panes in Defaults, then clicking **File > Open > Example Defaults**. For example, to see how to configure ArtiosCAD to make a sample with Re-board®, you could look at the **Kongsberg XL44 - V-notch sample cutting** entry under **Outputs > Artios > Kongsberg XL44 - Corrugated**.

Output Type tab

Output Type group

The choice in the **Output Type** group of the Output Type page determines which other tabs are available. In the above example, because the Output Type is set to **Sample**, there are tabs in the dialog box which only appear for samples.

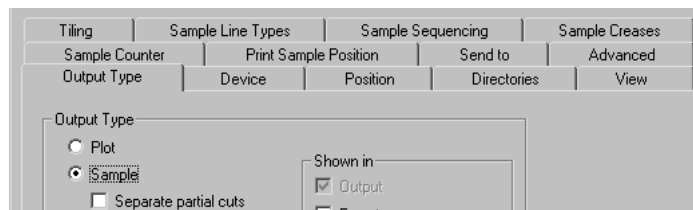

When the Output Type is set to **Plot**, the tabs which appear only for plots become visible.

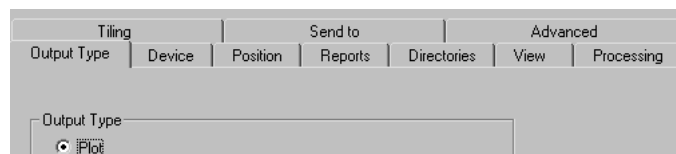

The selection in the Output Type group also determines what will be on the Output Type page itself. For example, when the Output Type is set to **Grouped Output**, the Scale group disappears from the page.

Show In group

The **Show In** group determines how this Output will be used. At least one of these choices must be selected.

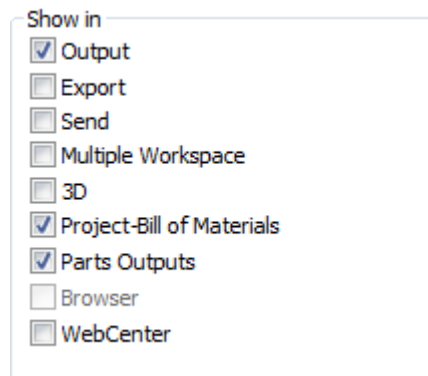

The **Export** menu is meant to be used to group commonly-used file exports together.

The **Send** menu is meant to be used to group together those Outputs which will be emailed.

A **Multiple Workspace** Output lets the same Output be used on a group of workspaces both in ArtiosCAD and in the Database browsers.

3D enables you to run this Output from a 3D workspace.

Project-Bill of Materials lets you run this Output iteratively for all objects on a BOM.

Parts Outputs causes this Output to appear on the Parts Outputs menu in a canvas. If you are using ArtiosCAD Enterprise, make sure to select this and **Browser** to be able to run this Output from a canvas.

Browser is available only for ArtiosCAD Enterprise and lets you run this Output by right-clicking in the browser.

When the **WebCenter** checkbox is checked, this Output can be used for downloading files from WebCenter. This is meant only for file outputs such as DDES, DXF, and EPSF. Outputs for WebCenter must have unique names; there may not be an Output used with WebCenter with the same name in both Shared Defaults and User Defaults.

Scale group

The options in the **Scale** group determine the size of the output.

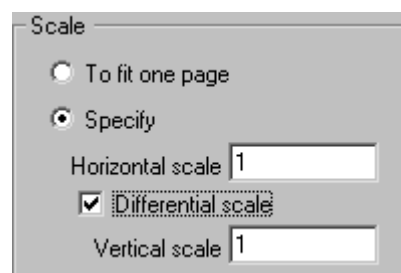

To fit one page modifies the size of the output so that it fits on one page.

Specify lets you set the size of the output. Setting a scale of one makes a full-sized output. Tiles, which are individual sections of the design, are printed if necessary.

Differential Scale makes the **Vertical Scale** field appear and changes the Scale field to **Horizontal Scale**.

Preview control group

The options in the Preview Control group control how and if the Output Preview dialog box appears when running the Output.

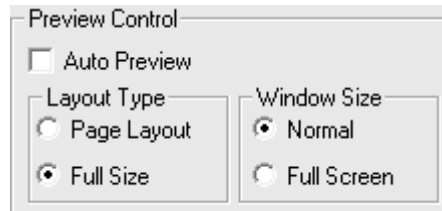

Auto Preview, when checked, causes the Output Preview dialog box to automatically open when running the Output. The options in the **Layout Type** and **Window Size** groups determine how the contents of the dialog box are shown. Shown below is the Output Preview dialog box.

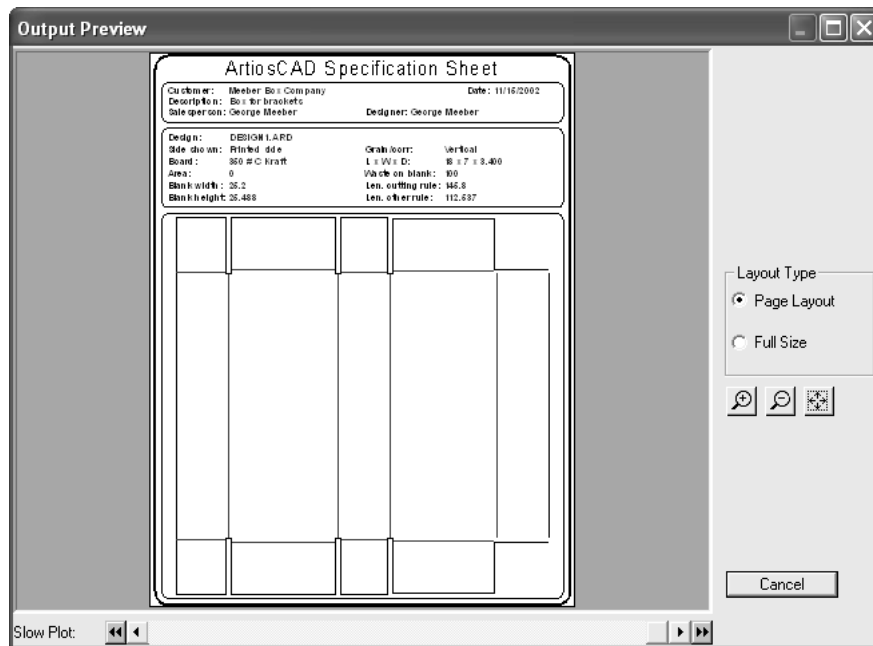

Device tab

The **Device** tab lets you specify the hardware device (if applicable) to which the Output will be sent.

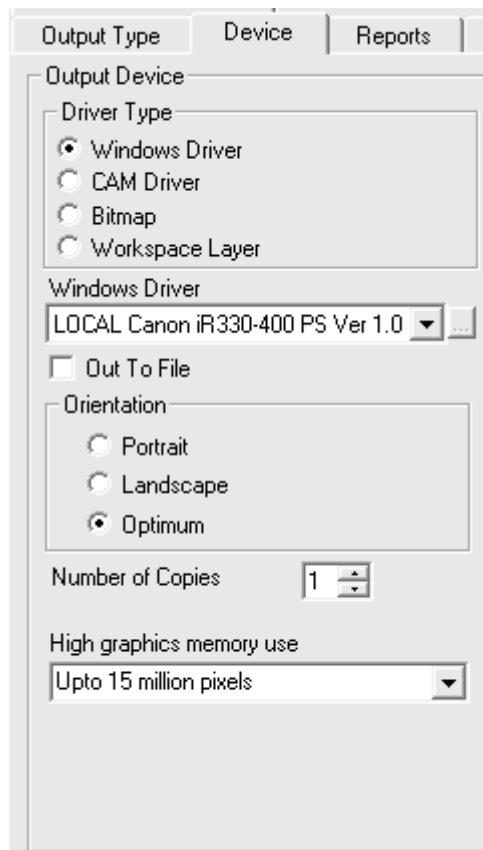

When entering this tab for the first time, you may see a dialog box informing you that ArtiosCAD was unable to find a certain printer. Ignore this and click **OK** to proceed.

In the **Driver Type** group, the **Windows Driver** option instructs ArtiosCAD to send the output information to the operating system mechanism of driving the device. The **CAM Driver** option instructs ArtiosCAD to use its internal methods to drive the device. The selected option in this group determines how the rest of the tab looks. **Bitmap** creates a picture file of the output. **Workspace Layer** creates a new layer in the workspace and draws the output data in that.

Note: When outputting to a layer, you must re-perform the Output after each rebuild to maintain correct information in the layer.

Out to file sends the output data to a disc file instead of physically out to a device through a port or network connection. Some devices such as samplermakers make a network connection to the CAD workstation and pick up the file automatically.

Number of copies allows you to set the default number of copies made when performing this Output.

The value selected in the **High graphics memory use** drop-down list box determines how much memory ArtiosCAD uses when outputting a bitmap image (typically a referenced PDF file when the PDF option has been purchased). This option is available only for Outputs of type Windows Driver or Bitmap.

A bitmap may have a maximum of 15 million pixels. The size of the bitmap is calculated dynamically during the output; system performance may be affected if a large bitmap is

required. You can set the maximum number of pixels for the Output to use to balance system speed and output resolution. There are four choices: **High graphics mode off, Upto 5 million pixels, Upto 10 million pixels, and Upto 15 million pixels.** The fewer the number of pixels used, the coarser the resolution of the output.

Windows driver

When **Windows Driver** is selected, there is a drop-down list box allowing you to choose the device that will perform the output. Devices must be set up in the operating system beforehand for ArtiosCAD to list them here. You can also choose the orientation of the output on the page by choosing the appropriate choice in the Orientation group: **Portrait**, which makes the long side of the paper the vertical axis, **Landscape**, which makes the long side of the paper the horizontal axis, or **Optimum**, which sets the orientation based on which one can output at the largest scale.

You can also set the **High graphics memory use** when using a Windows driver.

CAM driver

When **CAM driver** is selected, the Output Device group changes to look similar to the following picture, except no data will be shown in the various fields:

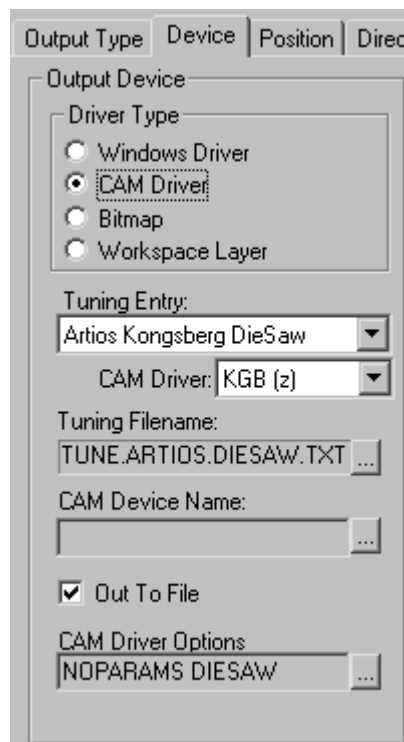

The **Tuning Entry** field indicates the type of device receiving the output data from ArtiosCAD. **CAM driver** specifies the internal ArtiosCAD method for creating the data. **Tuning Filename** lets you choose the configuration file for the device. **CAM Device Name** lets you set the Output Destination for the data if it is not going out to file. Refer to the *Peripherals* chapter for more information about installing CAM devices.

Bitmap outputs

The **Bitmap** driver type lets ArtiosCAD output a bitmap picture of a workspace.

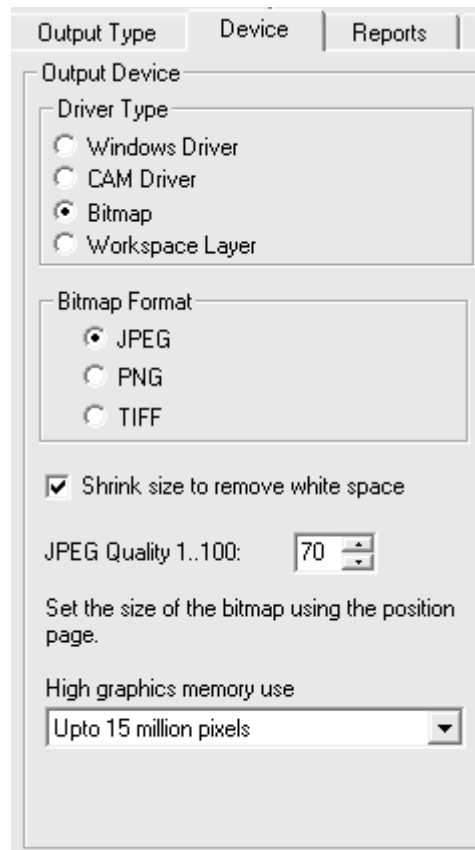

The option buttons in the **Bitmap Format** group set the type of bitmap created. JPEG output (**J**oint **P**hotographic **E**xperts **G**roup) makes compressed pictures for efficient use in other programs, but some color information is lost. PNG output (**P**ortable **N**etwork **G**raphic) is used for vector graphics (lines and arcs) shown on the World Wide Web. TIFF output (**T**agged **I**mage **F**ile **F**ormat) is uncompressed and is useful for other graphic programs such as Adobe Photoshop. Note, however, that TIFF files are usually quite large.

The **Shrink size to remove white space** checkbox, when checked, causes ArtiosCAD to crop the extra white space around the perimeter of the design upon Output.

The **JPEG Quality** field adjusts the quality and the file size of the resulting JPG file. A value of 0 makes the smallest file with the worst quality, while a value of 100 makes the largest file with the best quality. ArtiosCAD defaults to 70. Set the value in this field between 80 and 90 if you will be making Animations in 3D. This field is available only when the **Bitmap Format** is set to **JPEG**.

High graphics memory use determines how much memory ArtiosCAD uses to render PDF graphics being processed by the Output.

Getting bitmap outputs just right can take some experimentation.

Output to layer

Workspace Layer writes the results of an Output to a layer in a design.

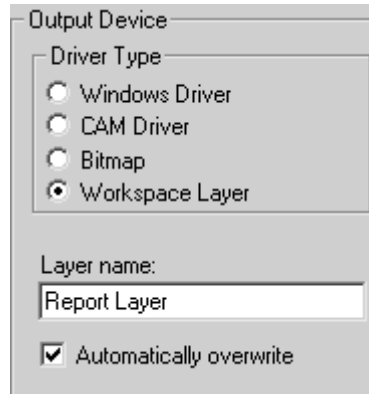

For example, you could define a Report output to go to a layer, and send the resulting file to a customer. The customer could then use the ArtiosCAD Viewer to view both the design and your report.

The **Automatically overwrite** checkbox controls whether the layer will be overwritten each time the Output is performed. If the checkbox is cleared, a number will be appended to the layer name in a sequential fashion.

Note: When outputting to a layer, you must re-perform the Output after each rebuild. When a design is rebuilt, the layer that was output to is automatically deleted as the information that was in it does not reflect the current state of the workspace.

Output to layer turns on that layer if it was not visible before the Output.

Output to layer honors locked layers.

Outputs using high graphics mode

Outputs that support bitmaps can use high graphics mode. These must be actual Outputs, as opposed to using the **Print** command on the File menu.

A bitmap may have a maximum of 15 million pixels. The size of the bitmap is calculated dynamically during the output; system performance may be affected if a large bitmap is required. You can set the maximum number of pixels for the Output to use to balance system speed and output resolution. The pixel usage is configured in the High graphics memory usage drop-down list box in the Output method's settings in Defaults, or may be configured each time in the Properties dialog box. There are four choices: **High graphics mode off, Upto 5 million pixels, Upto 10 million pixels, and Upto 15 million pixels**. The fewer the number of pixels used, the coarser the resolution of the output.

The memory usage for high graphics mode when using a 3D Output is fixed at 15 million pixels.

Shown below is the Properties dialog box for a Kongsberg CM1930 samplemaker with the Illustrator 2 printing head:

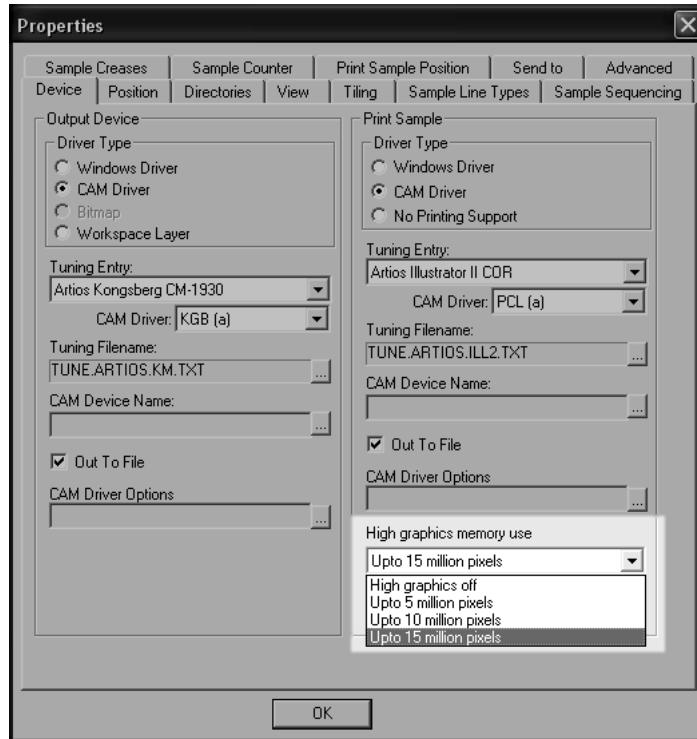

Shown below is the Plot to Printer dialog box.

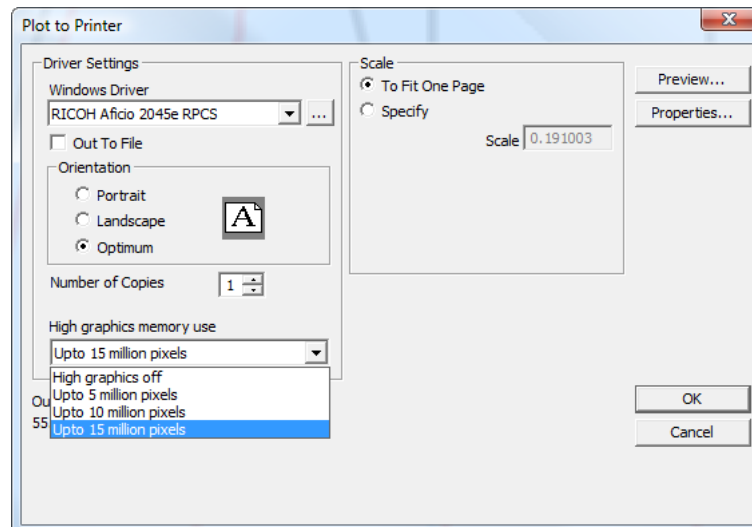

Position tab

The settings on the **Position** tab indicate the physical placement of the output on the output medium.

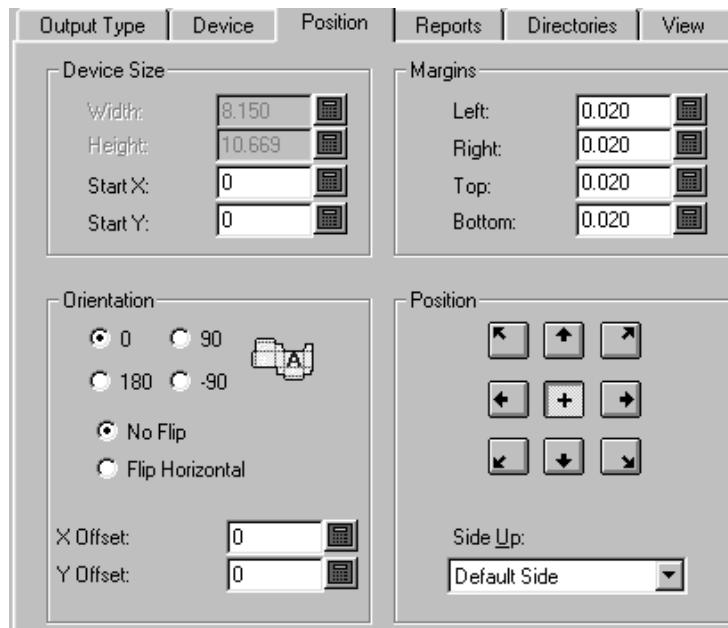

Device Size and Margin groups

The fields in the **Device Size** group let you set the size of the device (if you are using a CAM driver; otherwise, the size fields are unavailable) and the starting position as measured from the bottom left corner of the medium.

The settings in the **Margin** group set the distance between the edge of the medium and the physical area that can be printed by the device. When you set the device size to 0 (for unlimited size), you can still set the margins.

Orientation and Position groups

The commands in the **Orientation** group let you specify the relative position of the output on the device.

The options in the **Position** group control the point to which the output is snapped on the device and the side of the design which is output. The nine buttons snap the design to their respective location on the page - top left corner, top center, top right corner, right center, bottom right corner, bottom center, bottom left corner, left center, and center.

The **Side Up** list box lets you choose which side of the design is output: the Inside, Outside, Die Knife side, Die back side, or the default side, which is the current side of the design.

Reports tab

The **Reports** tab lets you specify a report to output using the data in the design. Check the **Use Report** checkbox and choose the report to use.

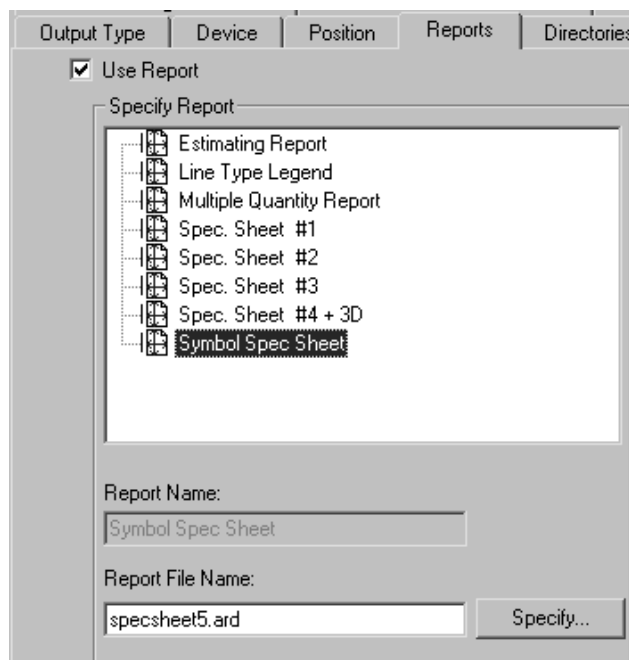

If the desired Report is not in the Reports Catalog, use the **Specify** button to browse for it.

Directories tab

The **Directories** tab lets you specify if the output data is written to a disc file instead of going to the physical device. The **Out to file** checkbox on the **Device** tab must be checked in order for these options to work. The contents of this dialog box will vary depending on what Output type is selected on the Output Type tab. The examples shown below are for plots. If the Output Type were set to Sample output, there would be many more fields for the different kinds of files that sample output can generate.

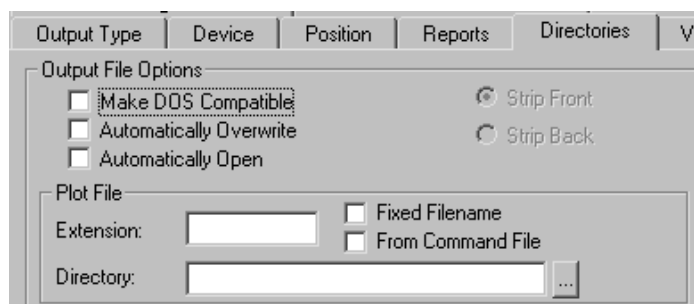

Make DOS Compatible truncates the filename so that it conforms to the 8.3 file-naming convention used in MS-DOS. When this checkbox is checked, the **Strip front** and **Strip back** option buttons become available. These control which part of the filename is stripped off to make it eight characters.

Automatically Overwrite controls if you are prompted to overwrite (delete) an old output file with the same name as the output file you will create when performing the output. This

option is usually checked by default in pre-defined Outputs that create files. If this option is checked for an Output that is added to a Grouped Output, the current filename with the default extension is used. The current directory is also used; you are not prompted to select a directory, You might have to search for the file created by the Output as it may not be where you expect it. Use this option with care.

Automatically Open opens the file in the associated Windows application after being output. For example, if you output a .txt file, Windows would recognize it as a Notepad document and open it in Notepad.

File groups

The names and amount of data fields in this dialog box depends on the type of Output selected on the Output Type tab. When the Output type is set to plot, for example, there is one file group, **Plot File**, but when the Output type is set to Sample, there are four file groups - **Make Counter File**, **Partial Cuts File**, **Make Sample File**, and **Print Sample File**. In each group, however, the fields and checkboxes are all the same and work the same.

The **Extension** field lets you use the same filename extension, which is the part of the file name which follows the last period, each time this Output is performed. By default, the filename is the same as the workspace name. Leave this field blank to specify an extension when creating an output file.

The **Directory** field lets you type the location of the directory in which to store the output file. Use the ellipsis button to browse for a directory.



The **Fixed filename** checkbox lets you specify the same filename for all files created using this Output. When this checkbox is on, and the directory specified in the Directory field is valid, the filename selection dialog box is suppressed.



From command file indicates that the filename is generated by a command file. When this option is checked, the output file name will be the result of executing the function **TLIBRARY(GenSName.txt)**. Since **Fixed Filename** is not checked, the resulting filename is the default filename when the output is run.

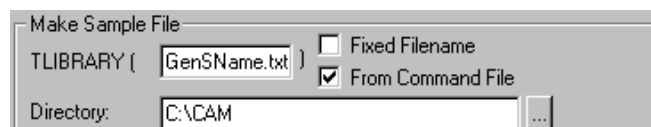

View tab

The options on the **View** tab of the Output dialog box control how the layers and line types are output.

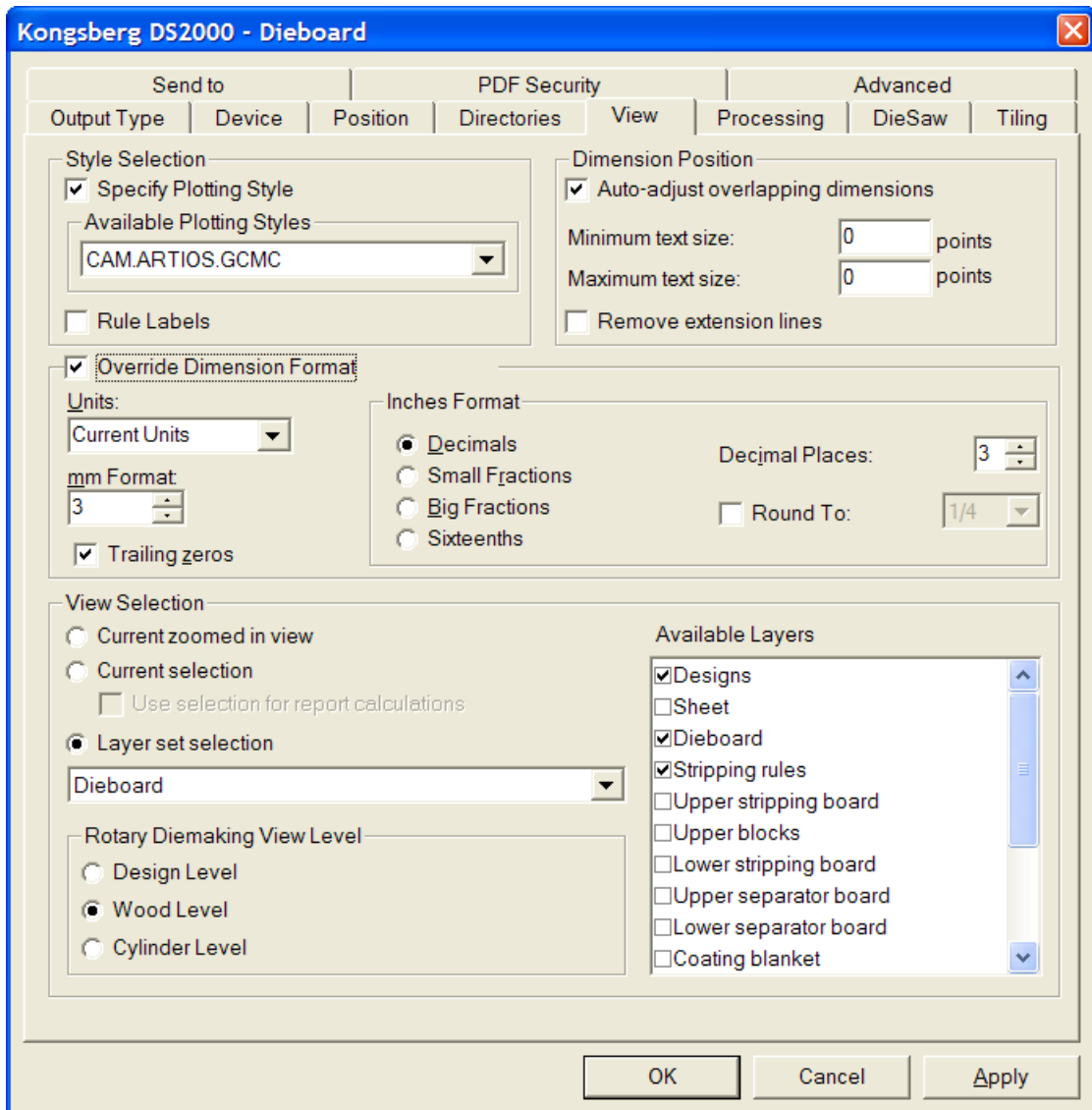

Style Selection group

Specify Plotting Style overrides the plotting style at time of output with the plotting style specified in the **Available Plotting Styles** drop-down list box. The list box is available only when this option is checked. Checking **Rule labels** turns on rule labels for this Output.

Dimension Position group

Auto-adjust overlapping text prevents rogue text items from being printed on top of each other. You can specify the range of text sizes to consider when ArtiosCAD looks for overlapping text by entering point values in the **Minimum text size** and **Maximum text size** fields.

The **Remove extension lines** checkbox controls whether extension lines are removed if text has to be moved to make it not overlap.

Override Dimension Format group

The options in the **Override Dimension Format** group allow you to override the workspace settings for the dimension format with those that you choose in this group. Set them as desired.

View Selection group

The options in the **View Selection** group control which layers are output when running the output.

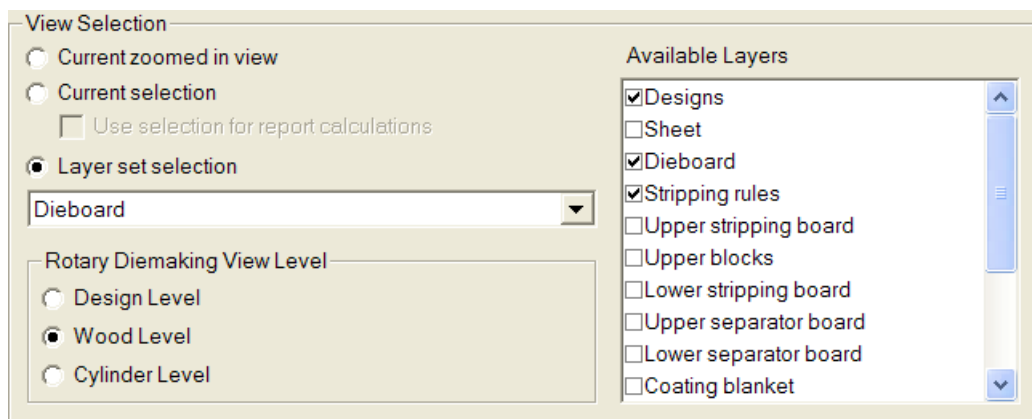

Current zoomed in view Outputs the objects in the current zoomed in area. In this case the **Layer set selection** is set to **Current View** and the **Available Layers** list is unavailable.

Current selection uses the currently selected items as the Output. All non-selected items are ignored. If no items are selected, the Output defaults to the Current View Layer set selection.

The **Use selection for report calculations** checkbox is only available with **Current selection** and is only applicable if the Output uses a Report. This option forces the calculated text commands in the Report to be evaluated against a temporary document which contains a copy of the selected item.

Choose the layer to output from the **Layer Set Selection** drop-down list box.

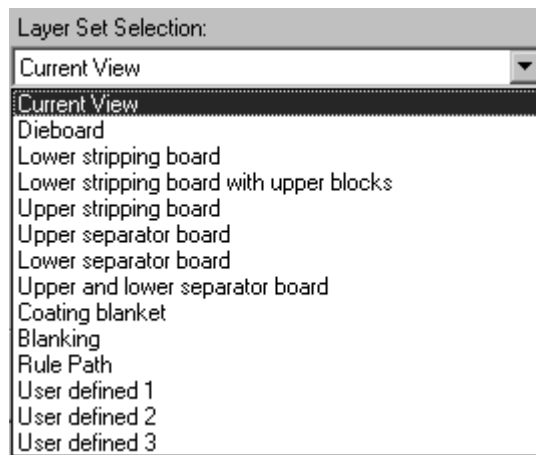

Choosing a layer set from the drop-down list box toggles different layers in the **Available Layers** group. Select or deselect layers as desired. To choose specific layers without starting from a preconfigured layer set, select the **User Defined** layer set, and then select layers as desired.

Note: Do not select both the Designs layer and Rule Path layer for any Output.

The options in the **Rotary Diemaking View Level** group control how the size of the Output is manipulated when the Layer Set Selection is set to **Dieboard**. **Design Level**, **Wood Level**, and **Cylinder Level** apply the appropriate shrink or stretch factors to the output data so that the output is sized correctly.

Processing tab

The commands on the Processing tab control how the data is manipulated between when you click Output and when the data arrives at the output device or disc file.

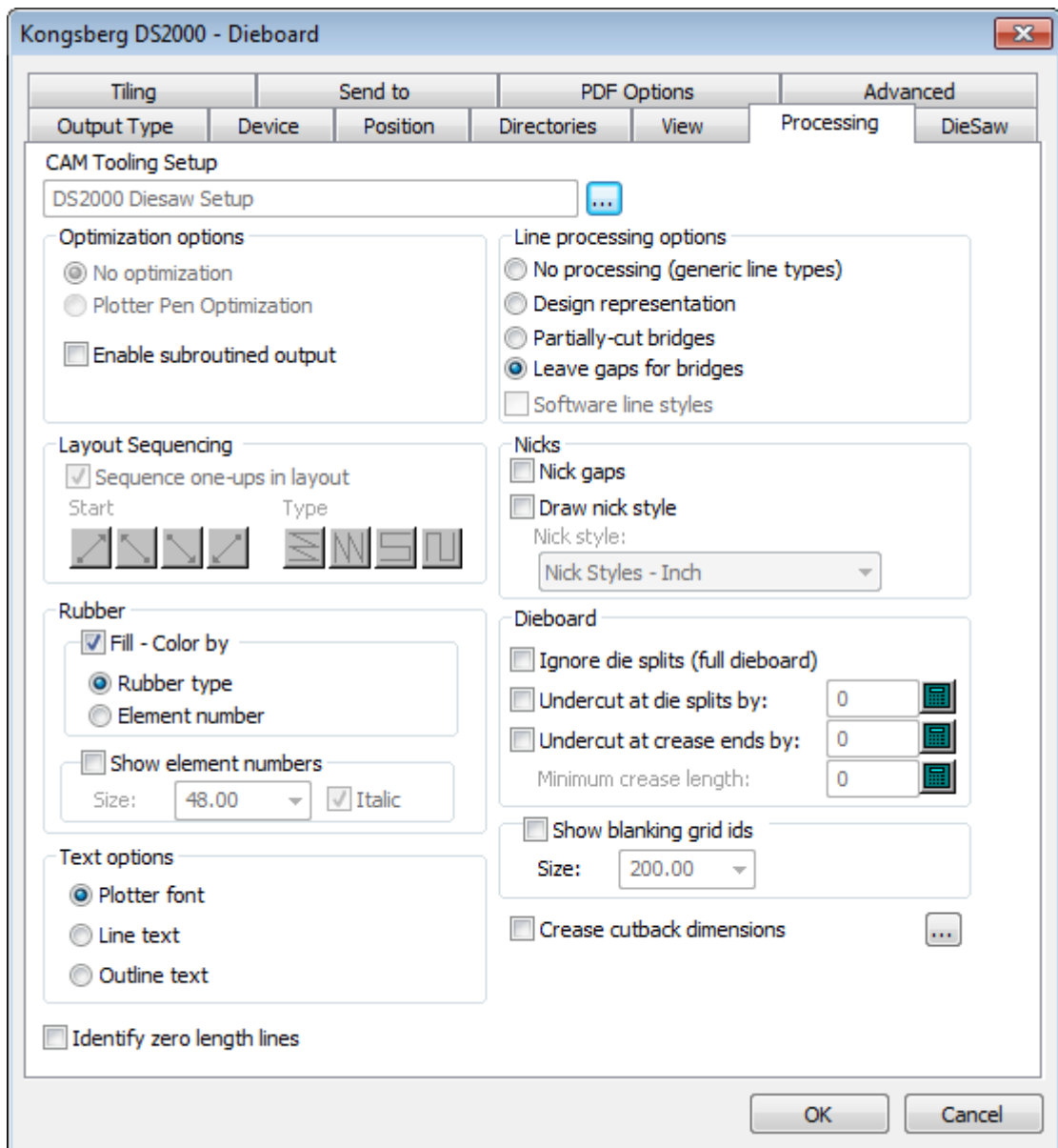

Note: The options on the Processing tab depend on the type of output chosen on the Output Type tab. Different outputs have different options.

 The **Browse** button at the end of the **CAM Tooling Setup** field lets you choose the CAM Tooling Setup to use in this Output. The CAM Tooling Setup maps which line types are mapped to which physical tools on the output device. Click it to choose an entry from the Select Cam Tooling dialog box.

Optimization options group

Depending on the Output Type chosen, items in this group may be unavailable.

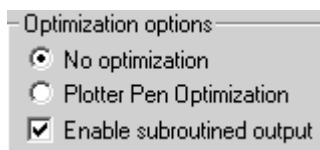

No optimization makes no changes to the output data.

Plotter Pen Optimization examines each 100 lines of output code, groups together lines made with the same pen, outputs them, and then examines the next 100 lines.

Enable subroutined output means support subroutines in the NC (numeric control) output, which only works with the PUNCH command and certain SAVE commands. Turning this checkbox off combines all elements of the design or manufacturing file into one set of data on output.

Enable subroutined output also works and should normally be checked for CFF2-Save and DDES-Save and Elcede exports. For a driver that supports this option, checking this checkbox causes each different design to be output as a subroutine, with a call to that subroutine for each instance of the design on the sheet. This saves memory in the controller for an NC output, and differentiates each design from the layout in DDES and CFF2 output. When this checkbox is clear, the entire layout is output **flat**, as if it were one big design. This option must be checked for the Layout Sequencing group to be available.

Line processing options group

The option buttons in this group determine how lines are physically output.

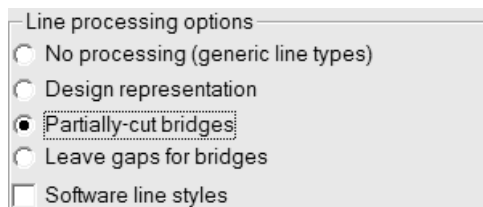

No processing ignores bridges and outputs each special rule as a single line.

Design representation means that special rules are output as “actual” lines; for example, a wave rule would be output as a series of arcs.

Partially-cut bridges instructs the output device to cut into the material at a partial depth to make room for bridges in the rule.

Leave gaps for bridges splits the line output data into pieces and leaves gaps in the output data for bridges, meaning that no slot or line is created in the output material where the bridges occur.

Software line styles processes all line styles before they are sent to the driver. For example, when this option is selected, a perf would be broken up into a series of short cut lines and gaps instead of one line marked perf that the driver would then process. This option is available only for Plot outputs.

Layout Sequencing group

The options in this group are shown only when the output type is set to **Plot**, **CAM**, **Sample**, or **Counter** on the Output Type tab. **Enable subrouted output** in the **Optimization options** group must be turned on for this group to be available in **Plot** and **CAM** outputs.

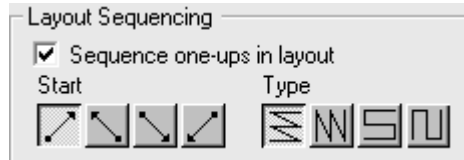

The **Sequence one-ups in layout** checkbox determines if ArtiosCAD automatically resequences the single designs in the layout when they are output. Clear this checkbox if you plan to always use the **Layout Manual Sequencing** tool with this Output.



The first group of four buttons sets the starting point for the sequencing. The first button starts the sequencing at the bottom left of the layout. The second button starts the sequencing at the bottom right of the layout. The third button starts the sequencing at the top left of the layout. The fourth button starts the sequencing at the top right of the layout.



The second group of four buttons controls the sequencing direction and is not available until a button in the first group is pressed.

The first button sequences each horizontal row, starting each row on the same side of the layout so that each row is sequenced in the same direction, as shown in the picture above, with the starting point at the bottom left.

The second button sequences each vertical column, starting each column on the same side of the layout so that each column is sequenced in the same direction.

The third button sequences each row, starting on opposite sides of the layout so that each row is sequenced in the opposite direction, forming a horizontal snake pattern.

The fourth button sequences each column, starting on opposite sides of the layout so that each column is sequenced in the opposite direction, forming a vertical snake pattern.

Nicks group

Nick gaps controls if ArtiosCAD leaves a gap in the line for a rule bender to interpret as a nick.

The **Draw nick style** checkbox controls whether nicks are drawn on the output, and the drop-down list box lets you choose the style to use from the Nick Styles Catalog.

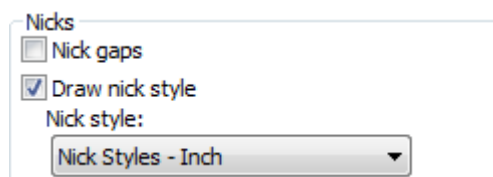

Note: You can make gaps for both bridges and nicks in the same Output, provided that the nicks and bridges are not on top of each other, which weakens the rule and should be considered an error. The rule bender would typically consider gaps of hypothetically 1mm or less to be a nick, and wider gaps to be bridges.

There are three ways to Output nicks:

- Line crossing perpendicular.

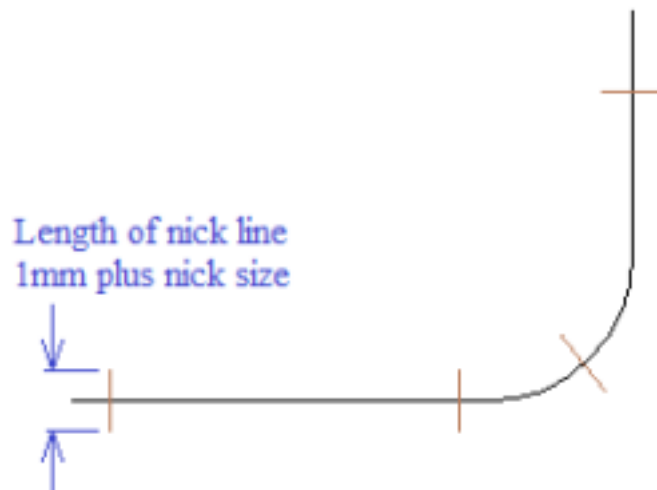

- Line parallel with a line.

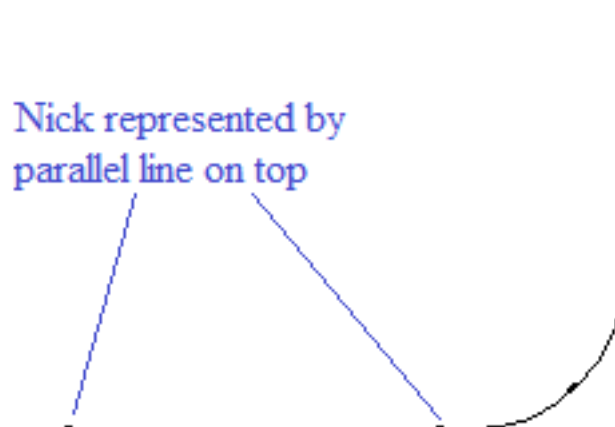

- Leave a gap.

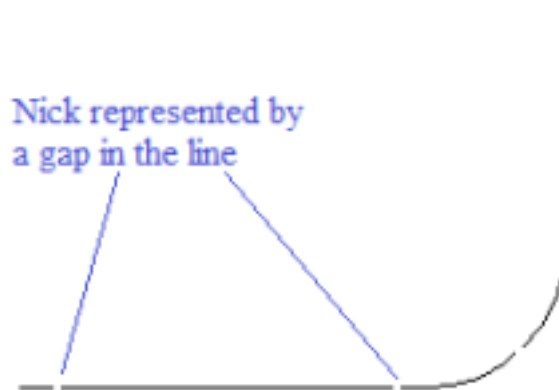

For the Line crossing perpendicular or Line parallel on top options:

- Add an appropriate nick style if it does not already exist in Defaults.
- Edit the export tuning file to map nick type 17 to the appropriate output type.

For all 3 cases:

- Add an output with the appropriate driver for the rule bender.

For Line crossing perpendicular:

- Check **Draw nick style** and choose a nick style where the nick is centered on the line.

For Line parallel on top:

- Check **Draw nick style** and choose a nick style where the nick is parallel to the line

For Leave a gap:

- Turn on **Nick gaps**.

Rubber group

The options in this group affect how rubber is shown on the Output.

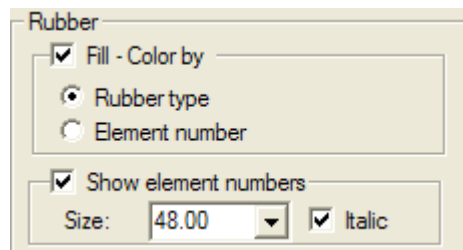

If **Fill - Color by** is selected, the rubber is drawn filled with color; choose to color the rubber by **Rubber type** or **Element number**. ArtiosCAD cycles through about 10 colors when drawing by element number. If **Fill - Color by** is not selected, the rubber is drawn as outlines.

To draw the element number inside each piece of rubber, select **Show element numbers**, and then set the **Size**: field (in points) and **Italic** checkbox as desired.

Dieboard group

The options in the this group control how the dieboard is created for a relevant Output type.

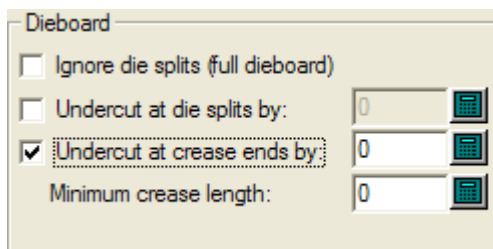

Ignore die splits (full dieboard) makes a full dieboard regardless of any splits.

Undercut at die splits by instructs the output device to cut back each line leading up to a die split from the split by the amount specified. Bridge positions are correctly maintained.

Undercut at crease ends by instructs the output device to put a bridge of the size specified at each end of all creases. If a crease line is bridged, any cutback may not exceed the size of the bridge width. If this option is chosen, set the minimum size of the line that will be undercut in the **Minimum crease length**: field.

Text options group

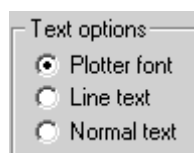

Plotter font tells the output device to use its built-in font for rendering the text. Use this option for pen plotters or for a driver that supports simple text entities, but not fonts, such as CFF2, DDES, Elcede DieCAD, and DXF.

Line text converts the text to geometry, which is then affected by transformations on output. Line text is suitable for etching text on a die. This is particularly useful for Asian languages, because the **Name** tool in Manufacturing only supports ASCII characters. To use Line text on a die or stripping tool, add a text item in a suitable font to the die or stripping board layer, with no color, and use an output configured with Line text. A suitable font for line text should be simple, have parallel edges, and not be too thick.

Normal text leaves the text alone. Normal text will always be output so that it is readable, regardless of dieboard orientation. This is suitable for output formats that support fonts, such as all Windows drivers, EPSF, and bitmap outputs

Text is always output right side up, for all three of the above options. The only way to output text backwards is to convert the text to lines in the design using the **Outline Text** or **Line Text** tools.

Identify Zero Length Lines

Identify zero length lines, when checked, warns you about zero-length lines and draws a small pink rectangle around them when you perform the Output.

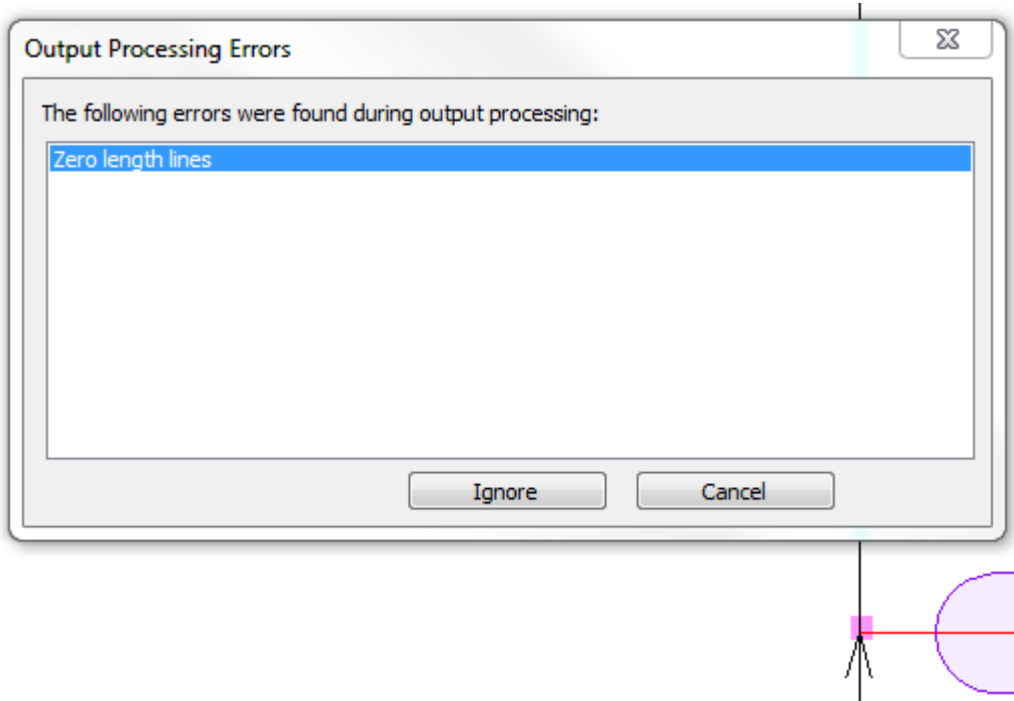

Click **Ignore** to ignore them and continue the Output, or click **Cancel** to stop the Output so you can delete them using Designer's Fix-It.

Crease Cutback Dimensions

Crease Cutback Dimensions on the Processing tab toggles the display on an Output of crease cutback distance dimensions for steel counters or for any other time when the top side of the rule is a different length than the bottom side of the rule. The Crease Cutback Plot example in the Steel Counter folder on the Outputs menu uses this option. If you use this feature, you may want to create custom Outputs that send the Output to a layer so that the crease cutback distance dimensions are saved with the workspace.



Shown below is a close-up of the preview of a crease cutback plot Output.

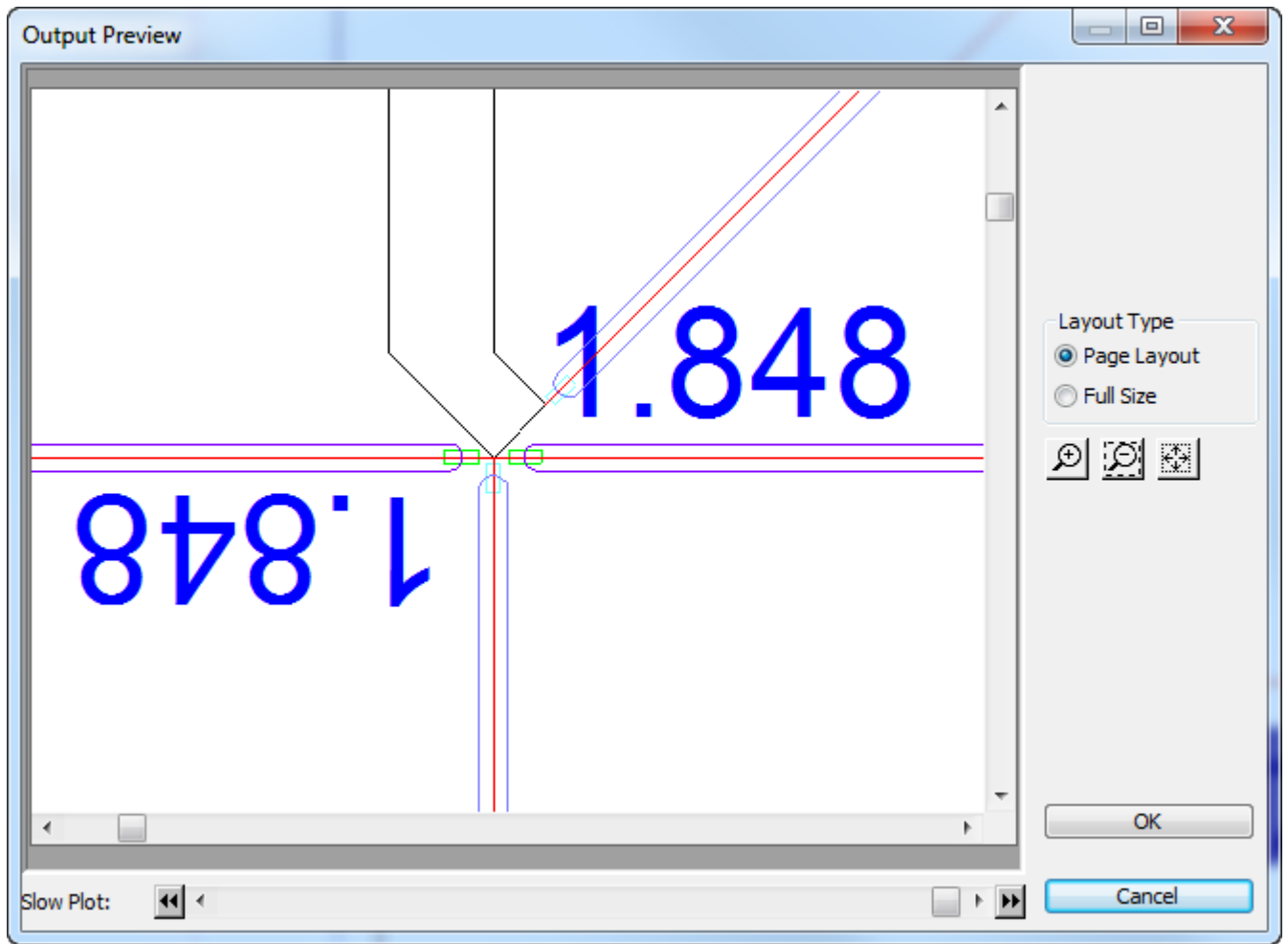

On the Processing tab in Outputs, clicking the More Options (...) button opens the Crease Cutback Dimensions dialog box.

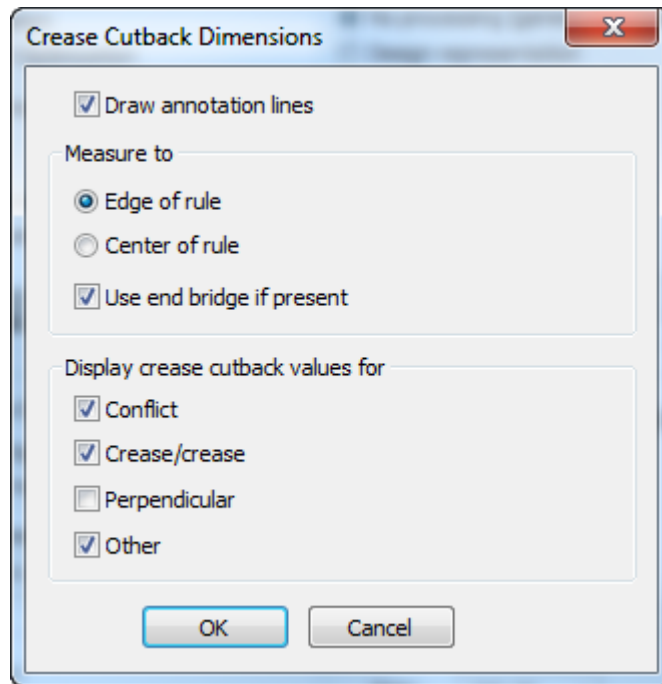

Draw annotation lines draws a rectangle of annotation lines from the crease cutback to the point you select in the Measure to group:

- **Edge of rule** is the point ArtiosCAD calculates so that the crease rule does not overlap any abutting rules.
- **Center of rule** is the end of the crease as drafted.
- **Use end bridge if present** measures to the end of the bridge on the crease.

The checkboxes in the Display crease cutback values for group determine if ArtiosCAD flags special conditions in the Output.

- **Conflict** is when the estimated rule end is further than the crease cutback. ArtiosCAD shows !!! in this case. These are line type Annotation3.
- **Crease/crease** flags creases that intersect other creases with an asterisk *. ArtiosCAD always assumes that the crease is cut back enough to not touch another rule. When two creases meet, it is not sure which one takes priority, so flags them for human checking. These are line type Annotation4.
- **Perpendicular** is when the expected end of the crease is exactly half the width of the cut rule. As this is the expected case, this option is off by default. This check may not work as expected if the rules in the design are different pointages. These are line type Annotation5.
- **Other** is when a crease rule intersects a cut at an odd angle, or any other case. These are line type Annotation.

Note:

- The size of the text is based on the Text catalog entry in Property Defaults.
- Dimensions display 3 decimal places for Imperial measurements and 4 for metric.

Restrictions

- ArtiosCAD treats special rules as regular lines. There is no way to specify slot or actual.
- ArtiosCAD assumes the crease end is squared, not chamfered or rounded.
- ArtiosCAD does not detect that a crease needs to be split if it is intersected in the middle.

- There is no way to customize the appearance of the dimensions other than the size. The font, color, and number of decimal places are all fixed.
- There is no way to customize the shape or type of the annotation lines.

Diesaw tab

Kongsberg DieSaw group

This tab appears only when the output is to a Kongsberg DieSaw.

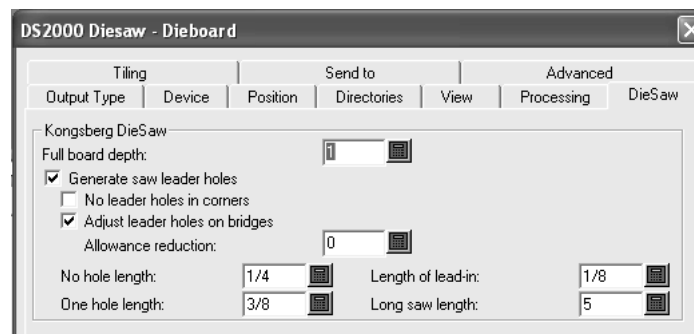

Full board depth is the thickness of the dieboard.

Generate saw leader holes controls whether ArtiosCAD creates leader holes. **Leader holes** are drilled holes in the dieboard which allow the saw to position itself to start cutting in the proper position. They are made before any saw cuts.

No leader holes in corners, when checked, prevents ArtiosCAD from automatically creating leader holes in corners. Leader holes are instead put on bridges of the lines that meet to form a corner.

Adjust leader holes on bridges allows ArtiosCAD to move the leader holes further apart from each other if they occur at either end of a bridge. When this happens, the amount of material left between the two holes is not strong enough and could break; therefore, the centers of the leader holes are offset from the ends of the lines to prevent bridge breakage. The picture below illustrates this process.

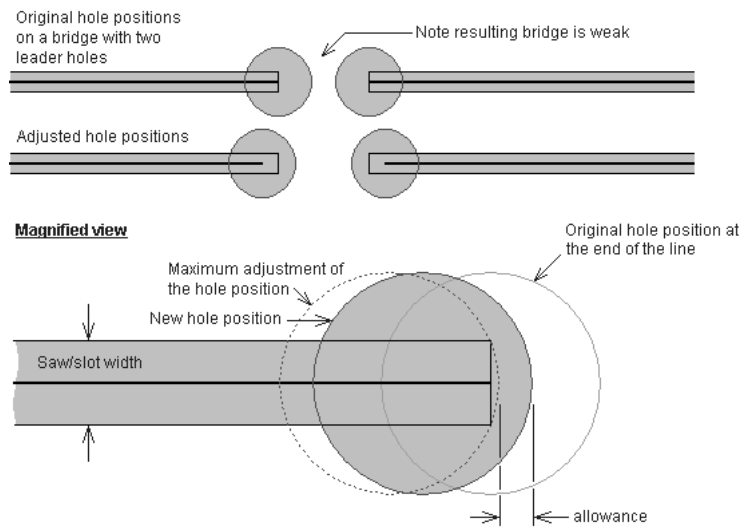

The **Allowance reduction** specifies by how much the edge of the leader hole is offset from the maximum adjustment of the hole position. The maximum adjustment would position the edge of the leader hole tangent with the end of the rule path. The Allowance reduction is the distance by which the leader hole is moved away from that tangent position.

Lines shorter than the length specified in the **No hole length** field do not have leader holes drilled for them; rather, they have a lead-in line cut for them with a hole at the beginning of the lead-in line. The length of the lead-in line is specified in the **Length of lead-in** field.

Lines shorter than the value in the **One Hole Length** field (but longer than the value of the **No hole length** field) get only one leader hole drilled.

The value in the **Long saw length** field sets the minimum length of lines that are optimized for the quickest sawing time. For lines longer than the long saw length, the direction of the line and the leader hole is determined by optimizing the sawing time. For lines shorter than this value, the direction of the line is determined to use the minimum number of leader holes. Connected lines that are longer than this value will not share leader holes.

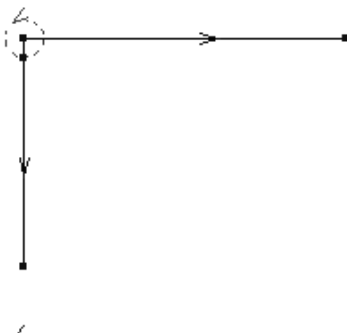

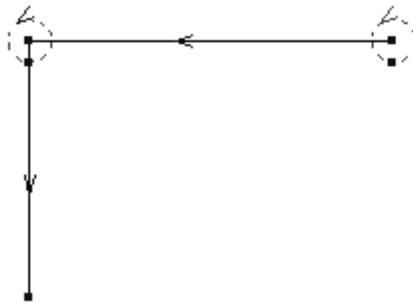

Tiling tab

The settings on the Tiling tab control what happens when the scale of the output is too big to fit on one sheet of output medium.

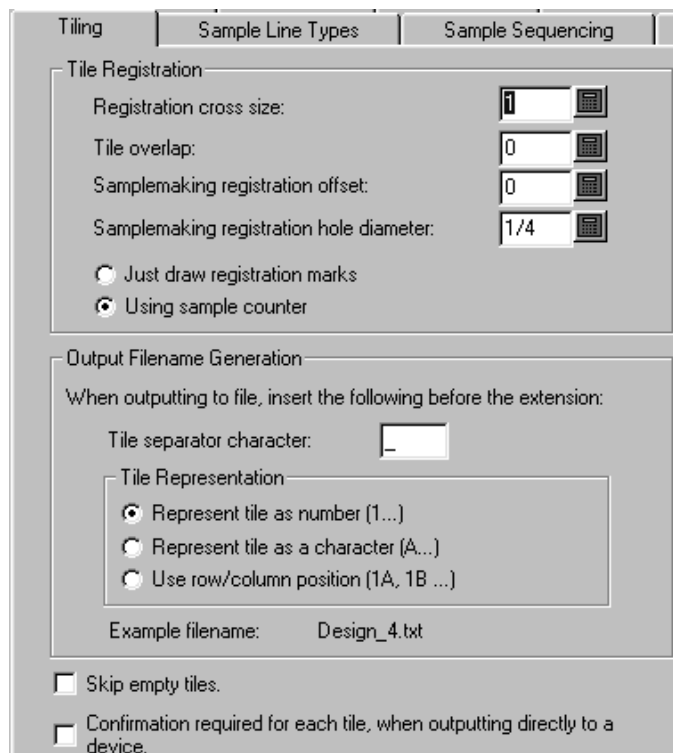

Skip empty tiles tells ArtiosCAD to not output blank tiles. If you will be assembling all the tiles together into one big sheet, you may want to leave this option unchecked so as not to confuse the assembler.

Confirmation required for each tile, when outputting directly to a device tells ArtiosCAD to prompt you to click **OK** before outputting each tile. This is handy for when you have to reload media on the output device in between tiles.

Tile registration group

The options in this group control how the tiles are marked for assembly.

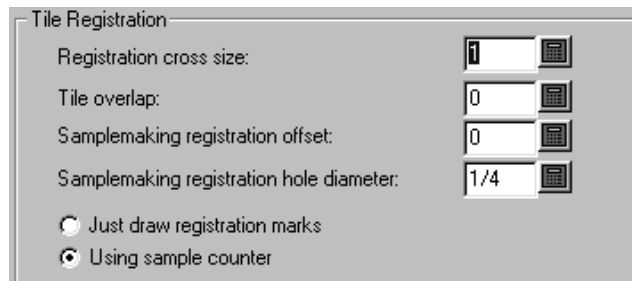

Registration cross size is the overall height and width of the cross mark. Setting this option to zero turns off the drawing of registration crosses in the output. Also, registration crosses are only drawn in the corner of tiles which align with other tiles; a registration mark will never be drawn in the bottom left corner of the first tile.

Tile overlap is the amount of overlap from one tile to the next. This value will be used for both the horizontal and vertical overlap. A value of zero means no overlap, and when used with registration crosses, turns the cross marks into corner marks.

Samplemaking registration hole diameter is only available for Sample outputs and is the diameter of the hole cut into the sample material to aid in registering oversized samples. The diameter value must be between zero and the size of the registration crosses. The hole is centered on the registration mark.

Using sample counter and **Just draw registration marks** are also only available for Sample outputs. These options indicate if a counter is being used when this Output is run. If **Just draw registration marks** is selected, then the **Make Counter** button on the main sample output dialog (what you see when you perform the Output) is replaced with a **Draw Registration** button. This button is unavailable if tiling is not required. Selecting this option will generate output files (using the Make Counter file designations) with just the tile registration marks drawn using a sample pen.

Output filename generation group

The options in the **Output Filename Generation** group automatically constructs a unique file name for each tile when the output is set to go out to file. When both conditions are met (Out to file and a scale larger than can fit on the output device), the options in this group change the name out of the output file to indicate the separate tiles.

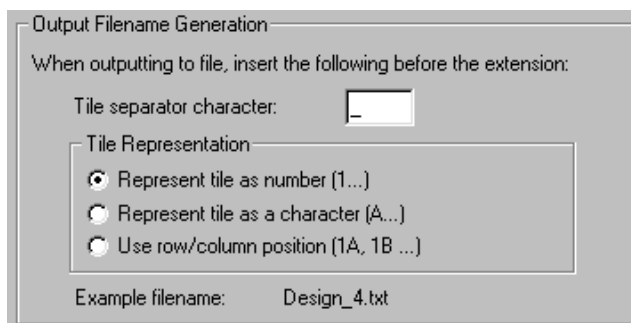

Sample line types tab

You configure the line types and tools used in samplmaking on the **Sample line types** tab.

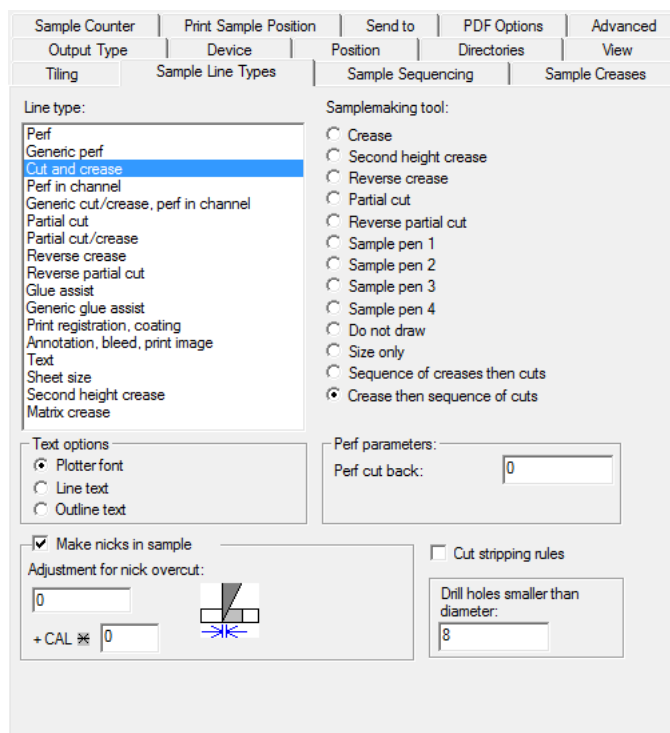

To configure how the line type is handled when performing this Output, select the line type in the **Line type:** group and choose the tool in the **Samplmaking tool:** group. There may be settings for the tool that appear in the bottom right corner; if there are, set them as desired.

As with other tabs, the information displayed on this tab is conditional; that is, the information requested on the right side of the tab depends on the selected item on the left side of the tab. What you see will not necessarily look exactly like the picture above.

To make nicks in the sample whose size based on the caliper of the board, enter a multiplier in the field next to **+ CAL ***.

To cut stripping rules on the sample, check the **Cut stripping rules** checkbox. Stripping rules are cut outward from the design to avoid overcuts.

The **Size only** samplemaking tool is used to calculate the output size. Use it only when outputting to a layer.

When using Re-board®, samplers cannot cut small holes in the material and use a drill tool instead. Therefore, enter an appropriate value in **Drill holes smaller than diameter** for holes that are drilled and not cut. If you will be using drill holes, you should update the **Sample drill hole** line type on the Sample tab of your plotting style definition so that it uses a thicker solid line instead of the default.

Text options group

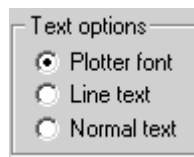

Plotter font tells the output device to use its built-in font for rendering the text. Use this option for pen plotters or for a driver that supports simple text entities, but not fonts, such as CFF2, DDES, Elcede DieCAD, and DXF.

Line text converts the text to geometry, which is then affected by transformations on output. Line text is suitable for etching text on a die. This is particularly useful for Asian languages, because the **Name** tool in Manufacturing only supports ASCII characters. To use Line text on a die or stripping tool, add a text item in a suitable font to the die or stripping board layer, with no color, and use an output configured with Line text. A suitable font for line text should be simple, have parallel edges, and not be too thick.

Normal text leaves the text alone. Normal text will always be output so that it is readable, regardless of dieboard orientation. This is suitable for output formats that support fonts, such as all Windows drivers, EPSF, and bitmap outputs

Text is always output right side up, for all three of the above options. The only way to output text backwards is to convert the text to lines in the design using the **Outline Text** or **Line Text** tools.

Make nicks in sample group

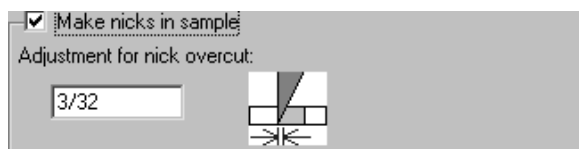

The **Make nicks in sample** checkbox controls if nicks are made when cutting a sample. Check the box to have the samplecutter make the nicks as defined in the design being output, or clear it to ignore nicks. When the checkbox is checked, the **Adjustment for nick overcut:** field

is available. This is the offset distance between the tip of the blade and the point where the blade exits the material.

Sample Sequencing tab

The settings on the Sample Sequencing tab control how some problematic scenarios are dealt with when making a sample, as well as controlling layout sequencing.

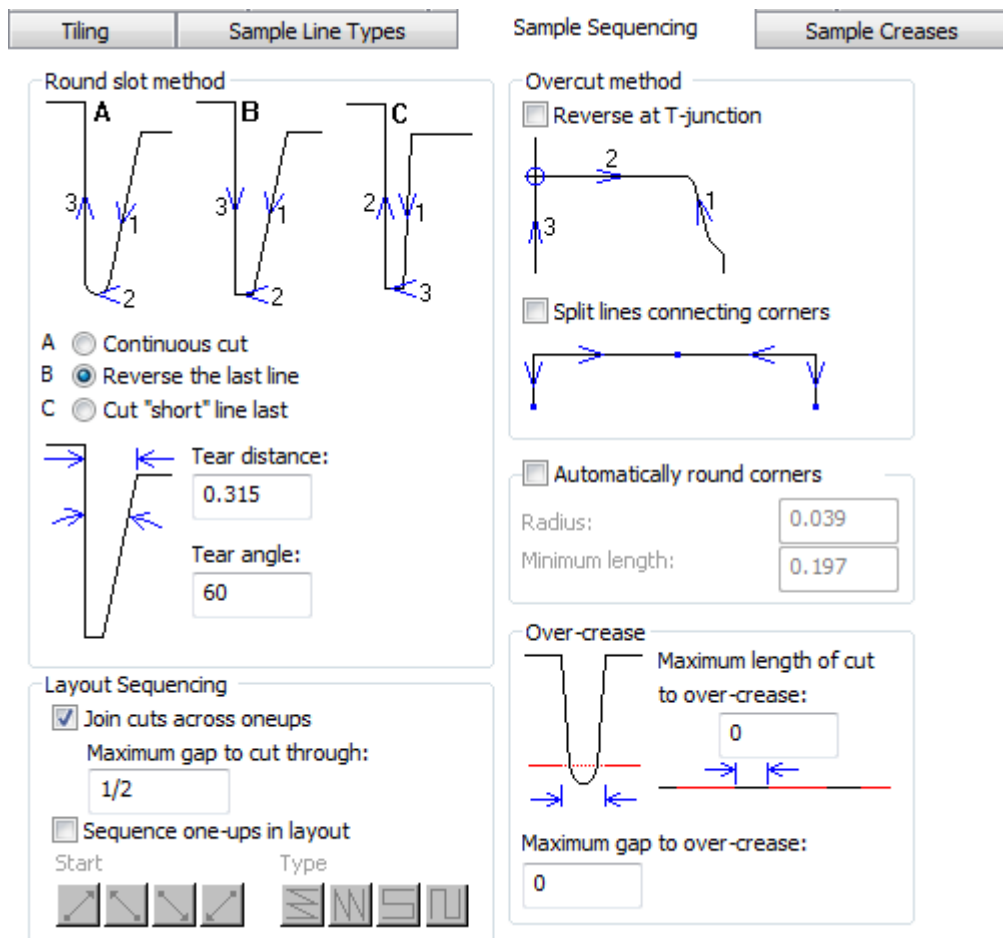

Split lines connecting corners and **Automatically round corners** may not both be selected.

For **Sequence one-ups in layout**, see the Layout Sequencing group section for the Processing tab.

When you cut labels on a samplemaker, **Join cuts across oneups** causes the samplemaker to keep cutting through the gaps between aligned labels for faster progress instead of having to lift the knife and turn to cut label by label. **Maximum gap to cut through** sets the size limit for this behavior.

Note: When you select **Join cuts across oneups**, **Sequence one-ups in layout** is unavailable.

Round slot method group

Cutting a sharp corner can tear the material being cut. The options in the **Round slot method** group control how sharp corners are cut. Sharp corners are identified using **Tear Distance** and **Tear Angle**.

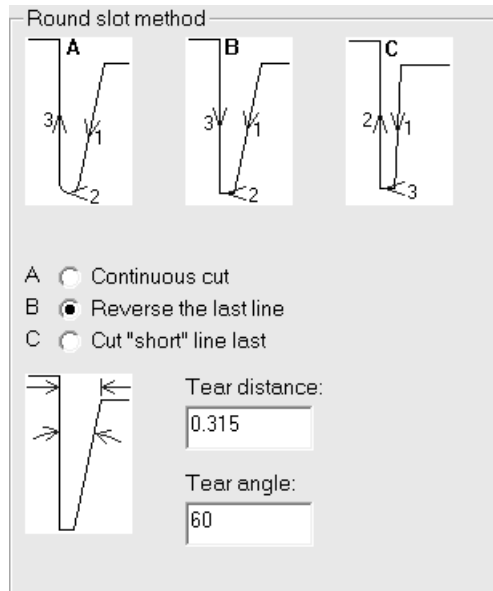

If a corner is narrower than the distance defined for the Tear distance, it is a sharp corner. If a corner has an angle less than the angle specified in Tear angle, it is a sharp corner.

Option A, **Continuous cut**, cuts all the lines in the slot in one direction.

Option B, **Reverse the last line**, reverses the last line to cut into the slot.

Option C, **Cut short lines last**, cuts the long lines first and then the connecting lines.

Overcut method group

The mechanics of samplmaking require that the knife cuts a little past the end of a line. If the direction of the line is into the sample, this will leave a mark on the sample. On a sample table such as a Kongsberg with a vertical rear edge to the knife, this problem can be fixed by reversing these lines (but only where this does not conflict with the line order required for sharp corners).

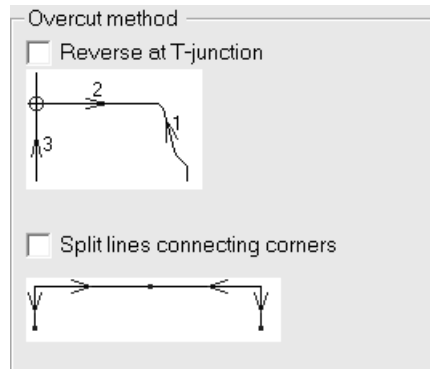

In the **Overcut method** group, you can set the overcut method to reverse at perpendicular intersections (called **T-junctions**). You can also specify to **Split lines connecting corners**.

Automatically round corners group

Some samplemakers can automatically replace a corner with a radius, reducing the number of knife lifts.

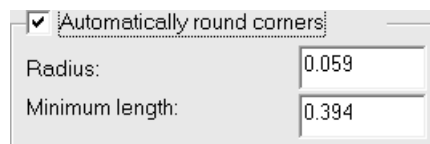

The **Radius:** field sets the size of the radius. The shortest lines intersecting to form a corner must be at least the length specified in the **Minimum length:** field to replace a corner with a radius.

Over-crease group

Over-crease is when the creasing wheel makes a continuous crease through gaps and on top of cuts. In the **Over-crease** group, specify the maximum sizes of gaps and cuts to run the creasing wheel over without it lifting.

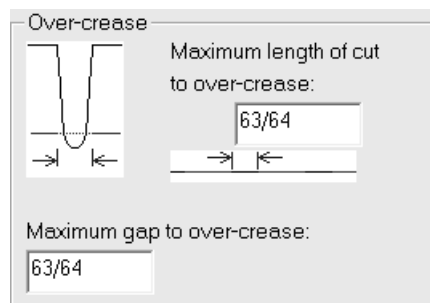

Set the value in the **Maximum length of cut to over-crease:** field in the **Over-crease** group to set limits on what is output as one line and what is output as separate lines.

The value in the **Maximum length of cut to over-crease:** field sets a limit so that short cuts and creases are output as a sequence while long cuts and creases are output separately. Adjust this field as needed to result in a series of short cuts with one long crease.

Set the value in the **Maximum gap to over-crease:** field to the maximum size of the gap the creasing wheel will pass through without lifting.

Sample creases tab

The commands on this tab control how creases are made on the samplemaking machine.

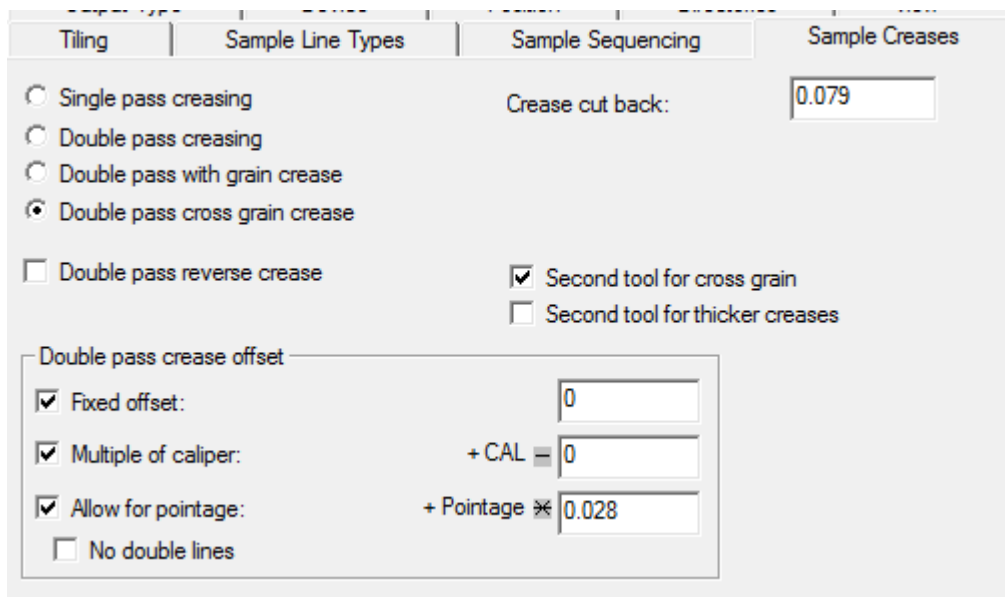

Single pass creasing and **Double pass creasing** control the number of times the creasing tool passes over the material to make a crease. **Double pass with grain crease** and **Double pass cross grain crease** only perform double pass creasing for creases in the specified direction, and use the options in the **Double pass crease offset** group.

Double pass reverse crease, **Second tool for cross grain**, and **Second tool for thicker creases** enable their namesake actions when checked.

The **Crease cut back** is the amount by which creases are shortened at both ends.

Double pass crease offset group

The options in this group are available only when **Double pass creasing** is selected.

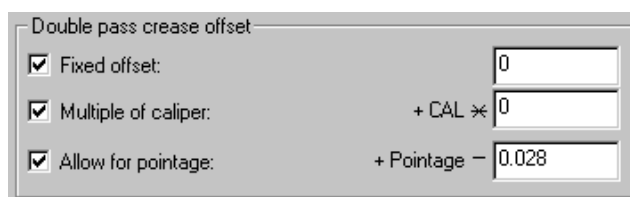

The offset can be a fixed distance (in current units), a multiple of the caliper, or an allowance for the pointage, or any combination of the three.

If **Double pass for reverse creases** is selected, the same crease offset applies as for creases, but no counter channel is made for reverse creases.

A fixed offset is specified by checking the **Fixed offset** checkbox and entering the value. A multiple of the caliper is entered by checking the **Multiple of caliper** checkbox and entering the value. To allow different pointage creases to have different crease offsets, check the **Allow for pointage** checkbox and enter the width of the scoring wheel. This defaults to 0.028 inches = 2 points; this adds (pointage - value) to the crease offset.

Sample Counter tab

The options on this tab control how sample counters are made. For each type of crease in the **Parameter for:** group, you can set the type of crease channel as well as the widths, counter cut back, and the channel angle. Routed counters invoke conditional text by deleting the field for the channel angle and inserting fields for the routing tool widths. The grain angle tolerance is the same for all crease types.

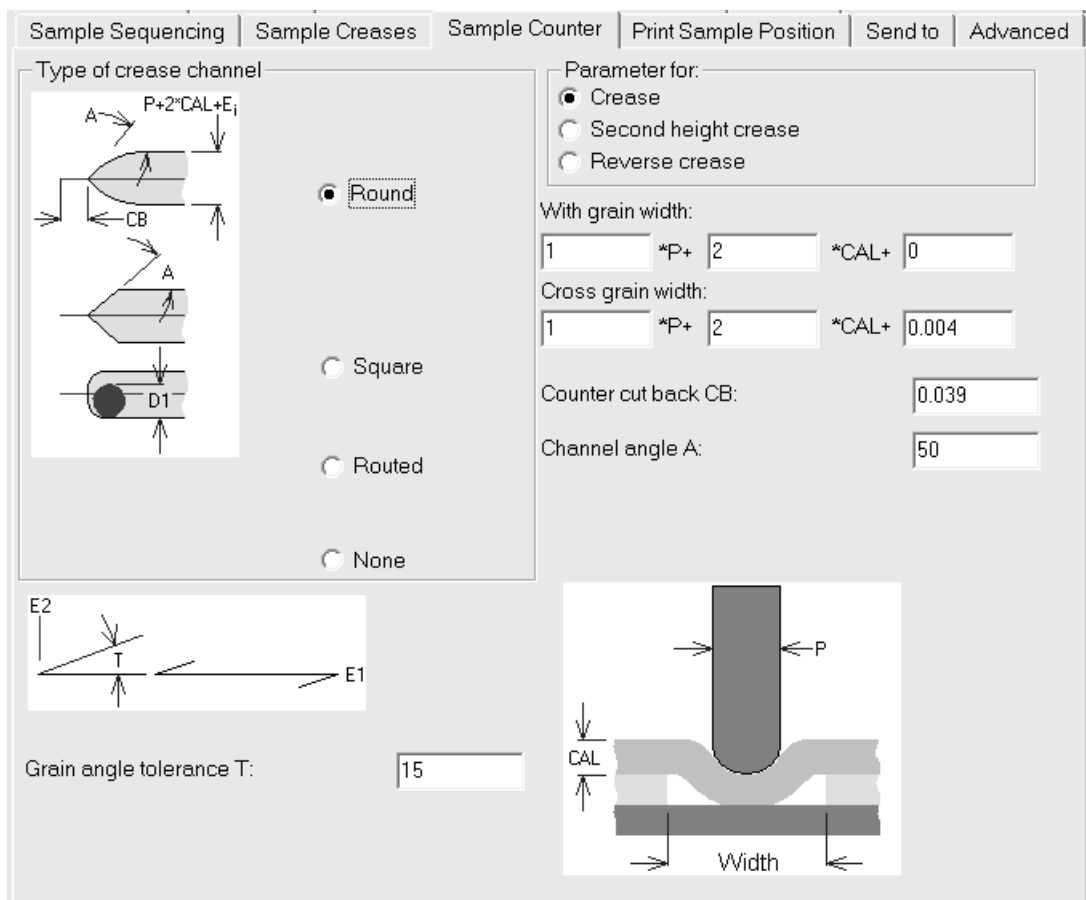

Print Sample Position tab

The **Print Sample Position** tab lets you specify how to print sample graphics on your sample printer.

This tab contains the exact same controls as the **Position** tab.

Send to tab

The commands on the **Send to** tab let you send the **results** of the Output via email. **The design file itself is not sent when an Output with this option enabled is run.** You must have a MAPI-compliant mail program such as Microsoft Outlook installed on your computer for this to work. If you do not have a MAPI-compliant email program installed, you will receive error messages when you attempt any email-related functions.

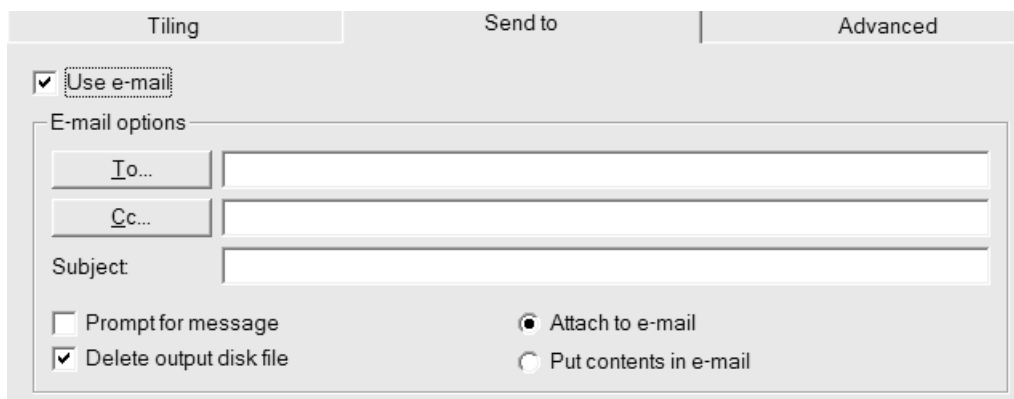

The **Use email** checkbox turns on this feature.

The **To** and **Cc** buttons let you choose recipients from your mail program's address book.

Prompt for message opens the message in your email program. If this option is not checked, the message is sent with no user intervention.

Attach to email sends the output as an attachment, while **Put contents in email** inserts the text of the output into the message body.

Delete output disk file deletes the file created by the Output after it is added to the email. To preserve the file, clear this checkbox.

Advanced tab

The commands on the **Advanced** tab are meant to be used by people with very specific needs.

Show Command for Diagnostics

Use prompting report file: ...

Use post processing command file:

EXE ...

Output through command file:

EXE ...

WITH OUTCM. OUTPT.

Launch Executable

Application to Launch ...

Block ArtiosCAD until complete

Add input parameter (full path to temporary XML file)

Include Database Information in XML file

Include Workspace Variables in XML file

Add and process return parameter (full path to temporary XML file)

Additional Parameters (evaluated as a text expression)

Prompt for Kongsberg Material

Use Material List from Text File (KGBMaterialList.txt)

Specify path to Material list file ...

Use Material List from iPC Resource Database

iPC System Name

Run Time Data Set:

Show Command for Diagnostics displays the instructions ArtiosCAD follows when making the output. ArtiosCAD then instructs you to click **OK** to perform the Output or **Cancel** to cancel it as shown below:

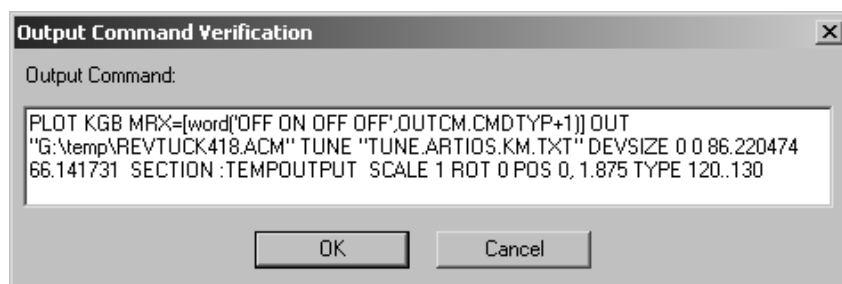

Use prompting report indicates that a special report is used with this Output. Prompting reports prompt you for workspace variables and do not produce a printed output. Once this report is run, the variables are copied into the workspace. This is useful for setting variables that you want to track in DataCenter.

Use post processing command file lets you specify the name of a command file that modifies the geometry in the :TEMPOUTPUT section. You should only use this feature if you have extensive knowledge of the INTERACT programming language. The command file you specify must not have any menu windows and must not crash.

Output through command file directs the output data through a command file specified in the **EXE** field with parameters specified in the entry box after **OUTPT**.

Launch Executable and its associated options are meant for use by Esko personnel who design custom solutions. It launches a program to which you can pass data from ArtiosCAD and pass data from the program back into ArtiosCAD.

Prompt for Kongsberg Material is covered in the next section.

Run Time Data Set is used with an Output that uses the GNC driver.

Prompt for Kongsberg Material group

In the Prompt for Kongsberg Material group, **Use Material List from Text File** prompts you to select a Material Setup File when running this Output. Material Setup files are usually configured when your Kongsberg sample table is installed. Shown below is the Specify A Kongsberg Job Setup File dialog box when the Output is performed.

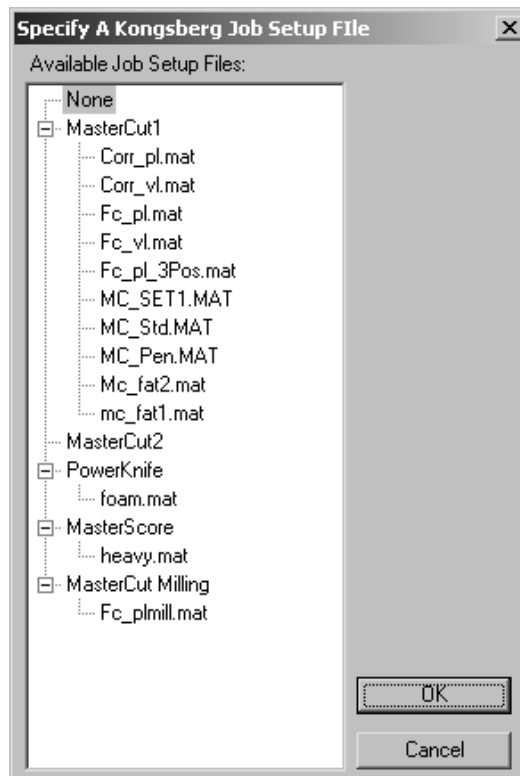

Specify path to Material list file lets you enter the default location of the files rather than having to specify it when the Output runs.

Use Material List from IPC Resource Database allows you to query the i-cut Production Console (IPC) server running on a Kongsberg front end for a list of materials. In the iPC System

Name field, enter either the hostname, fully qualified domain name, or IP address of that machine. If you use firewalls, open ports 80 and 10003.

Record Variable Definition

These records and variables are created in the Output that is acted upon by the command file you specify in the **Output through command file** checkbox. Use these records to get information from the design to the command file.

Record	Variable	Sub-variable	Definition
&OUTCM.			
	CMD\$		the actual command that would be issued
	DEBUG		1 if "Show Command for Diagnostics" is ON, else 0
	CMDTY\$		the command type "PLOT", "PUNCH" or "SAVE"
	CMDTYP		command type - if (OTPTYP = 0 or 2) = 0, else (OTPTYP = 1) = 0 for Make Counter, 1 = Make Sample, 2 = Partial Cuts, 3 = Print Sample
	DRV\$		the driver name e.g. "PRTMAN", "HP"
	DEV\$		the device name - when going directly to the device - not defined when going out to a file
	USRTX\$		additional user defined command parameters
	OPT\$		driver "opt" flag - either "OPT" or empty ("")
	DRVOP\$		additional driver options
	KGBMF\$		KGB Material file name - not defined if not used or empty
	OUTFL\$		the output file name - not defined when going directly to the device
	TUNE\$		the tuning file name
	DVSZLX		the lower X of the device size (in current units)

Record	Variable	Sub-variable	Definition
	DVSZLY		the lower Y of the device size (in current units)
	DVSZUX		the upper X of the device size (in current units)
	DVSZUY		the upper Y of the device size (in current units)
	WINLX		the lower X of the window - not defined if not tiled output
	WINLY		the lower Y of the window - not defined if not tiled output
	WINUX		the upper X of the window - not defined if not tiled output
	WINUY		the upper Y of the window - not defined if not tiled output
	SEC\$		the section to output e.g. “:TEMPOUTPUT” or “:TEMPOUTPUT:GRAPHOUT” (for print sample)
	SCLSTR		scale or stretch - 1 for “SCALE” - 2 for “STRETCH”
	XSCALE		x scale factor
	YSCALE		y scale factor (set to XSCALE when SCLSTR = 1)
	NEGX\$		either “NEG X” or EMPTY (“”)
	ROT		rotation in degrees
	POSX		X position in current units
	POSY		Y position in current units
	LTYPS\$		the parameters to the TYPE keyword e.g. “TYPE #SCUT, #SCREASE..#SRXCREASE NOGRAPH” or empty (“”)
	STY\$		the plotting style to use e.g. “STY artios1” or empty (“”)

Record	Variable	Sub-variable	Definition	
&OUTPT.	TILEX		for tiling - the row of this tile	
	TILEY		for tiling - the column of this tile	
			output properties	
	OTPTYP		the output type 0 = PLOT, 1 = SAMPLE or 2 = MFG	
	OTPNM\$		the name of the output	
	USESCL		1 to use the scale given - else automatically calculate it	
	SCALE		the scale factor given	
	USESTR		1 to use "STRETCH" instead of "SCALE"	
	YSCALE		the y-scale factor given	
	USEFRM		1 - this output uses a form	
	FRMNM\$		the name of the form	
	DRV.		the driver/positioning data	
		DRVTYP		0 - Windows driver, 1 = CAM driver
		PRTR\$		name of the windows printer
		TOFIL		1- when output is set to file
		ORIENT		0=Portrait, 1=Landscape, 2=Optimum - only used for a windows driver always portrait for CAM
		TNDES\$		the description as read from TUNEFILES
		TNFIL\$		tuning file name
		DRVNM\$		the driver name as read from TUNEFILES e.g. HP
		DVNAM\$		name of CAM device for LP devices; e.g. HP1, DDES etc.
	DROPT\$		the CAM driver options	
	DEVSZX		CAM device size in X in current units	

Record	Variable	Sub-variable	Definition
		DEVSZY	CAM device size in Y in current units
		MGTOP	CAM top margin in current units
		MGBOT	CAM bottom margin in current units
		MGLEFT	CAM left margin in current units
		MGRGHT	CAM right margin in current units
		OFFSTX	X offset from the justification position in current units
		OFFSTY	Y offset from the justification position in current units
		STARTX	X origin shift
		STARTY	Y origin shift
		ROT	Rotation flag: 0=rotate 0, 1=rotate 90, 2=rotate 180, 3=rotate -90
		MIRROR	Mirror flag: 0=no mirror, 1=mirror horiz., 2=mirror vert
		JUST	Justification flag: 0=top left, 1=top center, 1=top right, 3=center left, 4=center, 5=center right, 6=bottom left, 7=bottom center, 8=bottom right
		SIDE	Side flag: 0 = PRINTEDSIDE, 1 = UNPRINTEDSIDE, 2 = default side
		TILED	0 if we don't need tiling
		TILESX	number of tile rows
		TILESY	number of tile columns
		TLOVLP	tile overlap
	PSDRV.		the optional print sample driver/ positioning data
		DRVTYP	0 - Windows driver, 1 = CAM driver, 2 no printer
		PRTR\$	name of the windows printer

Record	Variable	Sub-variable	Definition
		TOFIL	1- when output is set to file
		ORIENT	0=Portrait, 1=Landscape, 2=Optimum (2 is only used for a Windows driver) always portrait for CAM
		TNDES\$	the description as read from TUNEFILES
		TNFIL\$	tuning file name
		DRVNM\$	the driver name as read from TUNEFILES e.g. HP
		DVNAM\$	name of CAM device for LP devices; e.g. HP1, DDES etc.
		DROPT\$	the CAM driver options
		DEVSZX	CAM device size in X in current units
		DEVSZY	CAM device size in Y in current units
		MGTOP	CAM top margin in current units
		MGBOT	
		MGLEFT	CAM left margin in current units
		MGRGHT	CAM right margin in current units
		OFFSTX	X offset from the justification position in current units
		OFFSTY	Y offset from the justification position in current units
		STARTX	X origin shift
		STARTY	Y origin shift
		ROT	Rotation flag: 0=rotate 0, 1=rotate 90, 2=rotate 180, 3=rotate -90
		MIRROR	Mirror flag: 0=no mirror, 1=mirror horiz., 2=mirror vert
		JUST	Justification flag: 0=top left, 1=top center, 1=top right, 3=center left, 4=center,

Record	Variable	Sub-variable	Definition
			5=center right, 6=bottom left, 7=bottom center, 8=bottom right
		SIDE	Side flag: 0 = PRINTEDSIDE, 1 = UNPRINTEDSIDE, 2 = default side

Information Filter tab

The commands on the Information Filter tab let you select the ArtiosCAD data included in the Output. The Output type must be set to **Information Filter** to make this tab appear.

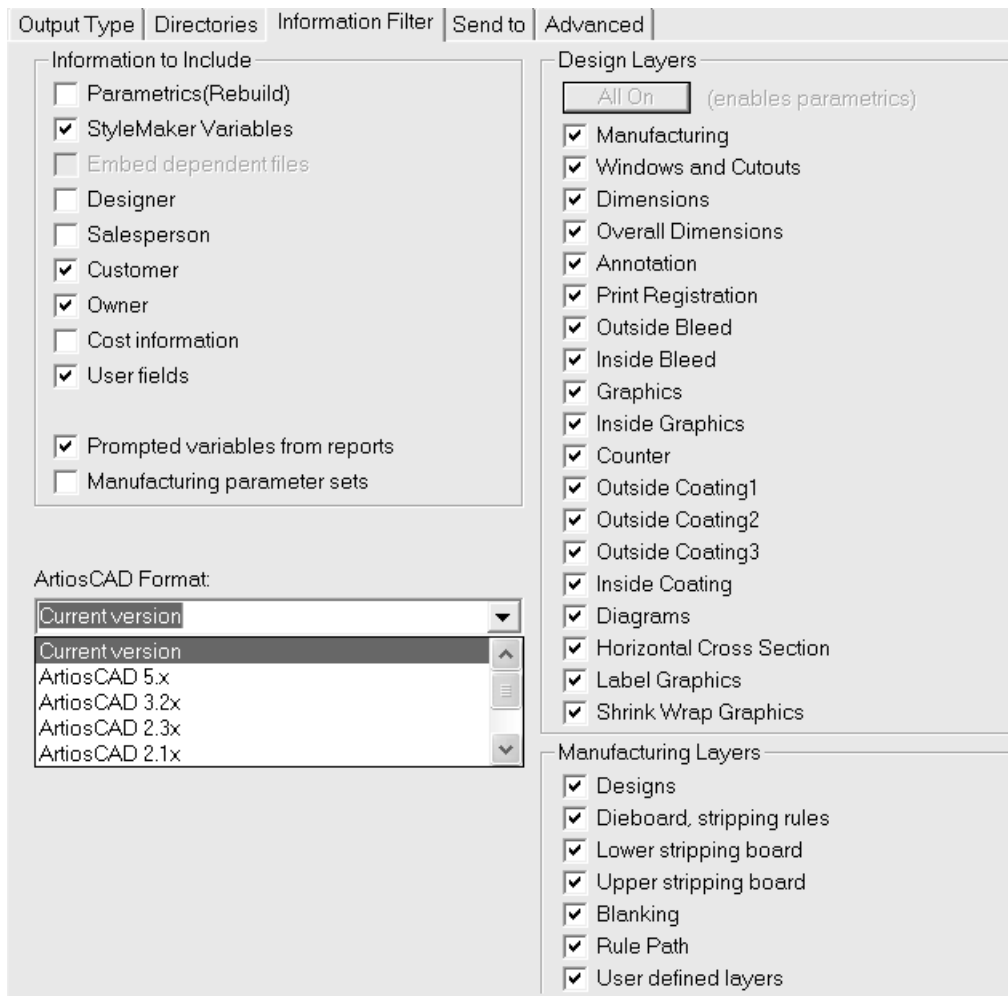

Note: The settings on this tab supersede any view settings you have set in ArtiosCAD when you select this Output. This means you may send information you do not mean to send, or vice-versa.

All layers must be turned on for the resulting workspace to be rebuildable. If all the layers are not turned on, the **Parametrics(Rebuild)** checkbox is cleared and cannot be checked until all layers are turned on. Click **All On** to turn on all the layers.

If the **Manufacturing parameter sets** checkbox is not selected, the Information Filter will remove manufacturing parameter set information from Manufacturing files and copies of parameter sets that are embedded in design files.

When using the Information Filter to strip prompted text variables from an Output, only those variables defined in the Prompted Text Catalog are stripped from the Output.

The output format for an information filter is usually an ArtiosCAD workspace. The allowed formats for an information filter output are the current version of ArtiosCAD, the major previous ArtiosCAD releases, a **LASERPOINT IQ 3 or 4** workspace, and a **LASERPOINT IQ 2** workspace.

Counter Tool Widths tab

All the fields which are unavailable in this tab in Defaults become available when performing the actual Output. The values for them are dependent upon the board used and parameter set. These fields are calculated automatically when this Output is invoked and cannot be changed during an Output.

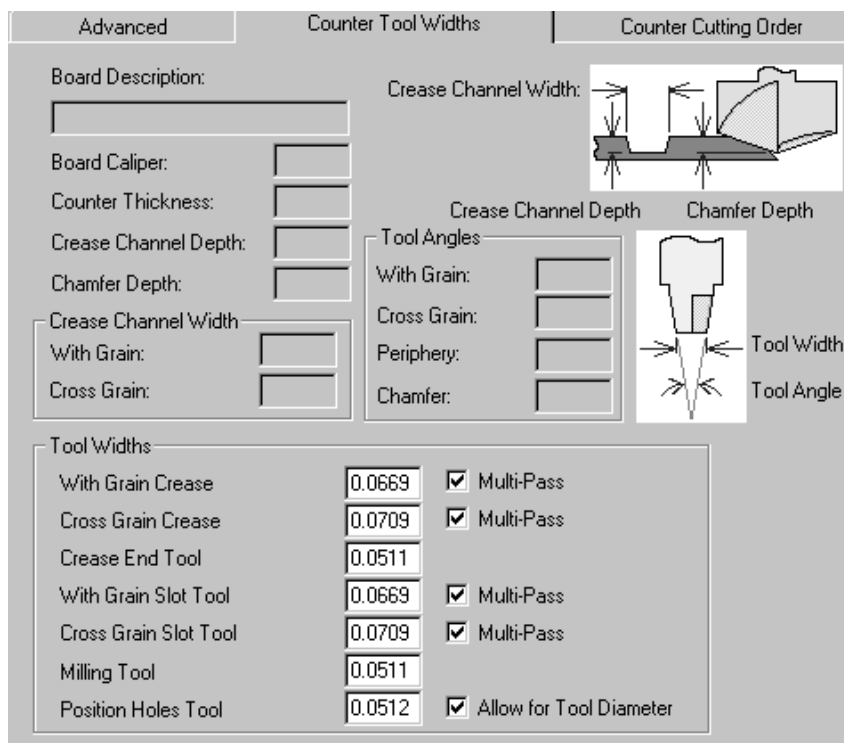

The fields in the **Tool Widths** group are measured in current units and are enabled only when their respective checkboxes are checked.

When the **Multi-Pass** checkbox is off, the corresponding field is automatically set to the crease channel width and disabled. When the **Multi-Pass** checkbox is on, the edit box is enabled. Enter a tool width greater than zero and it will multi-pass with this tool.

For the **Position Holes** tool, the **Allow for Tool Diameter** checkbox follows the design lines when it is not selected, and allows for the width of the tool when the checkbox is selected.

If the specified tool width is too large to fit within the programmed lines, it will always cut something rather than nothing.

If the tool width of the crease tool is wider than the required crease channel it will cut with a single pass.

If the crease end shape is narrower than the crease end tool, it will cut a path that is the same distance from the crease end.

Counter Cutting Order tab

As the name implies, the tools on **Counter Cutting Order** tab control the direction in which the counter lines are made on the counter cutter.

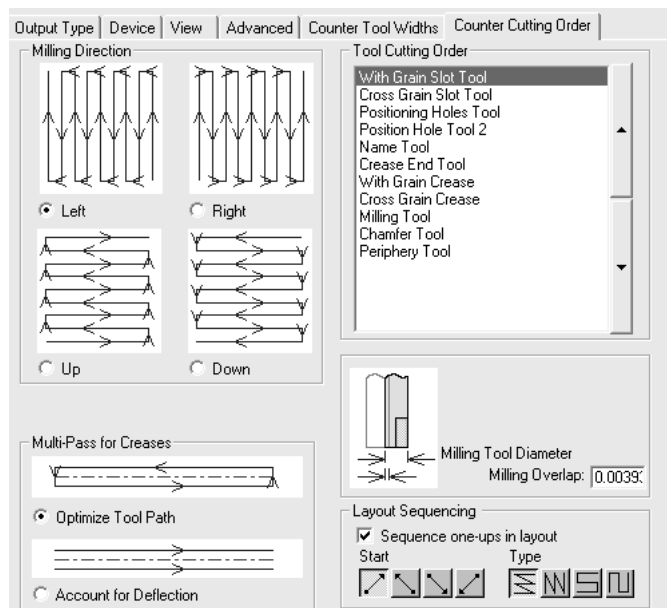

The four option buttons in the **Milling Direction** group control the milling order.

The tools listed in the **Tool Cutting Order** group cut from the top of the list to the bottom of the list. To change the cutting order, select a tool to move, and then click the arrows to the right of the list.

The options in the **Multi-Pass for Creases** group control how the multiple passes for creases are made if that option is turned on. **Optimize Tool Path** makes a small rectangular crease channel out of four passes, while **Account for Deflection** makes two parallel passes in the same direction.

The value you set in the **Milling Overlap** field indicates the overlap the milling tools will use when the machine mills lines close to each other. This is to ensure all material is milled correctly.

Grouped Outputs tab

The Grouped Outputs tab, which appears only when the Output Type is set to **Grouped Output**, lets you group already-defined Outputs into one. For example, with one click, you could save the workspace, print a spec sheet, export a DDES file, send an email containing a DXF file, and cut a sample.

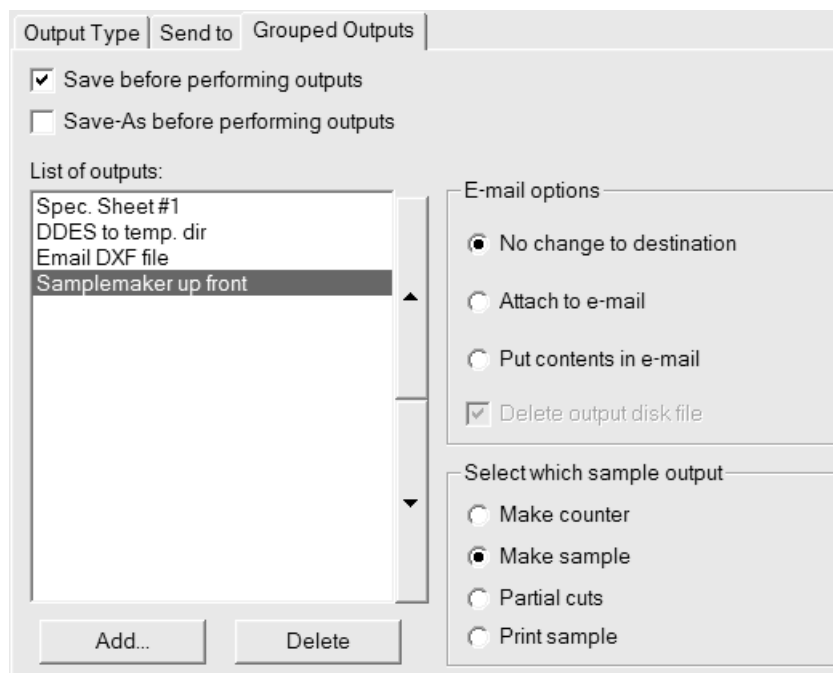

If any of the component Outputs you select go out to a file, they do not need to be configured to automatically overwrite the file if necessary; ArtiosCAD will prompt for a filename when necessary.

To add an Output to this Grouped Output, click **Add** and select it from the list of Outputs; to delete it, click **Delete**.

Also, the **Scale** group on the Output Type tab is unavailable for Grouped Outputs as the scales are set for each component Output.

The Outputs listed are processed in top-down order. To change the position of an Output, select it, and then move it by using the arrows at the side of the list box.

Save before performing outputs uses the current name of the workspace if one is defined. If it is not defined, ArtiosCAD prompts for the information needed. **Save-As before performing outputs** lets you select a new folder or resource as well as a new filename. ArtiosCAD works with the new file as soon as it is saved, so any Outputs in this grouped Output will use the new file.

In both cases, any dialog boxes normally opened by the save process will be opened during the Output, such as the Database Information dialog box. Use caution when using the **Save** or **Save-As** options with CAD-X as it may lead to unpredictable results.

Both **Save before performing outputs** and **Save-As before performing outputs** may be checked at the same time to allow saving the workspace with its original name and then saving it as a new name.

Grouped Outputs can also be added to a compressed archive in ZIP format; select **Zip** in the **Grouped Output Type** group and **Insert into Zip archive** in the **E-mail/Zip options** group. If you are working with filenames in non-English languages, check **Use UTF8 characters for filenames** so that the filenames are encoded correctly within the ZIP archive.

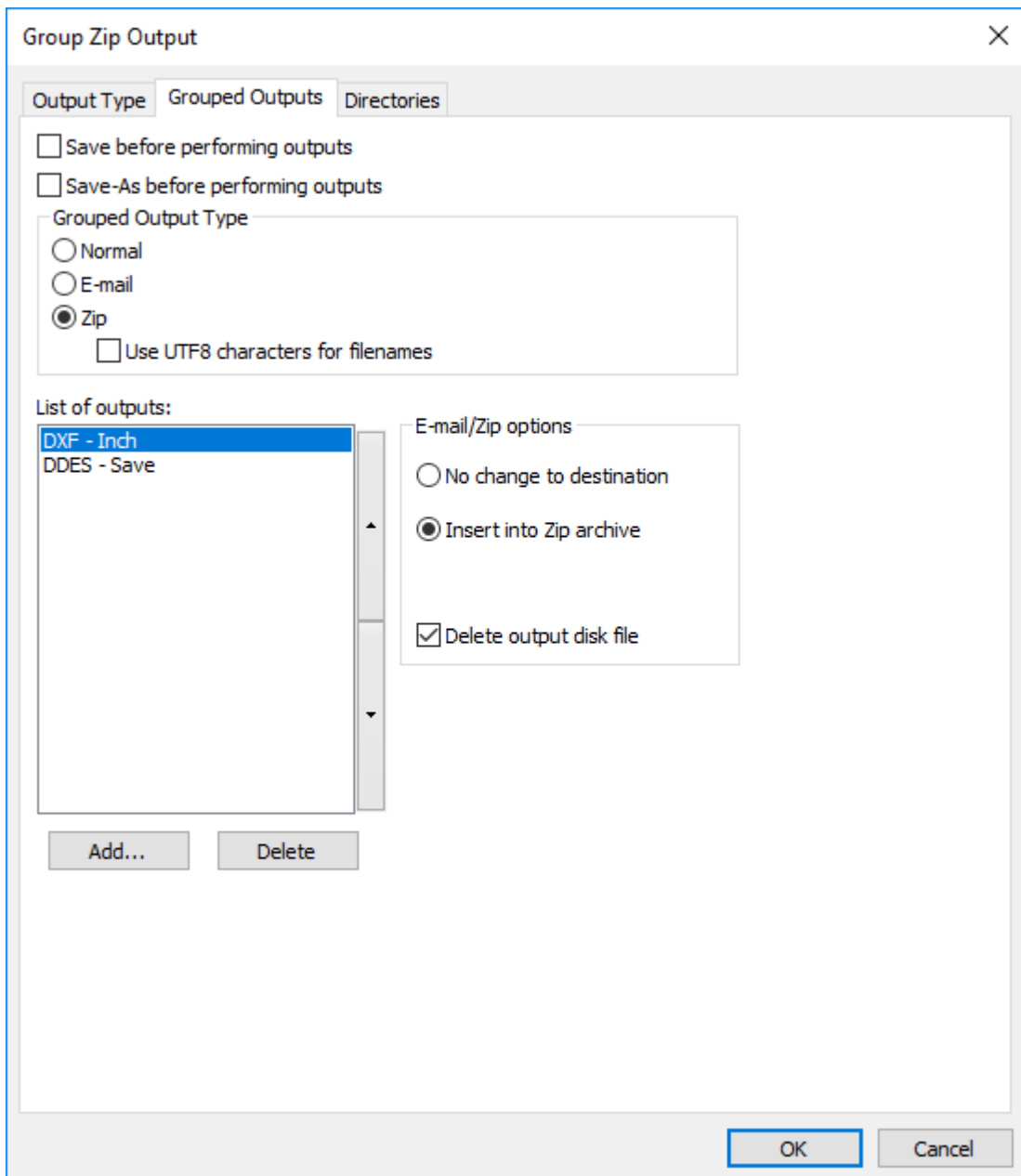

Delete output disk file deletes the working files that the Grouped Output creates after inserting them into the ZIP archive. In this example, those would be the DXF and DDES files.

As the **E-mail** and **Zip** Grouped Output types are mutually exclusive, in order to e-mail a zipped archive, you have to create a Zip Grouped Output first and then include that in an E-mail Grouped Output.

E-mail options group

A Grouped Output can also have its own top level email output (configured on the **Send to** tab) in addition to each individual Output going to email.

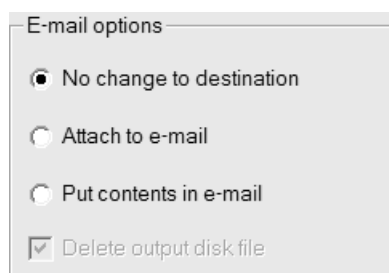

No change to destination indicates that the selected individual Output runs without any changes.

Attach to e-mail intercepts the output file for this component Output and embeds it as part of the group mail output. For example, if the output is to a Kongsberg samplemaker, the .MAP file will be attached to the email message instead of being sent to the table.

Put contents in e-mail means take the contents of a text file created by this component Output and put it in the e-mail message rather than attaching the file. It is intended for inserting text such as ordering information in the message. This should only be used with outputs through command files which generate text files.

Delete output disk file deletes any temporary files needed to add the output to an email message.

Select which sample output group

This group is conditional; it appears only when a sample output is selected in the list of Outputs.

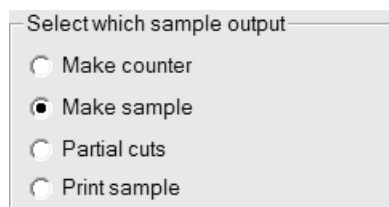

Select the option button for the type of sample output you wish to create.

PDF Security tab

The PDF security options available in an ArtiosCAD Output correspond to those used in Adobe Acrobat.

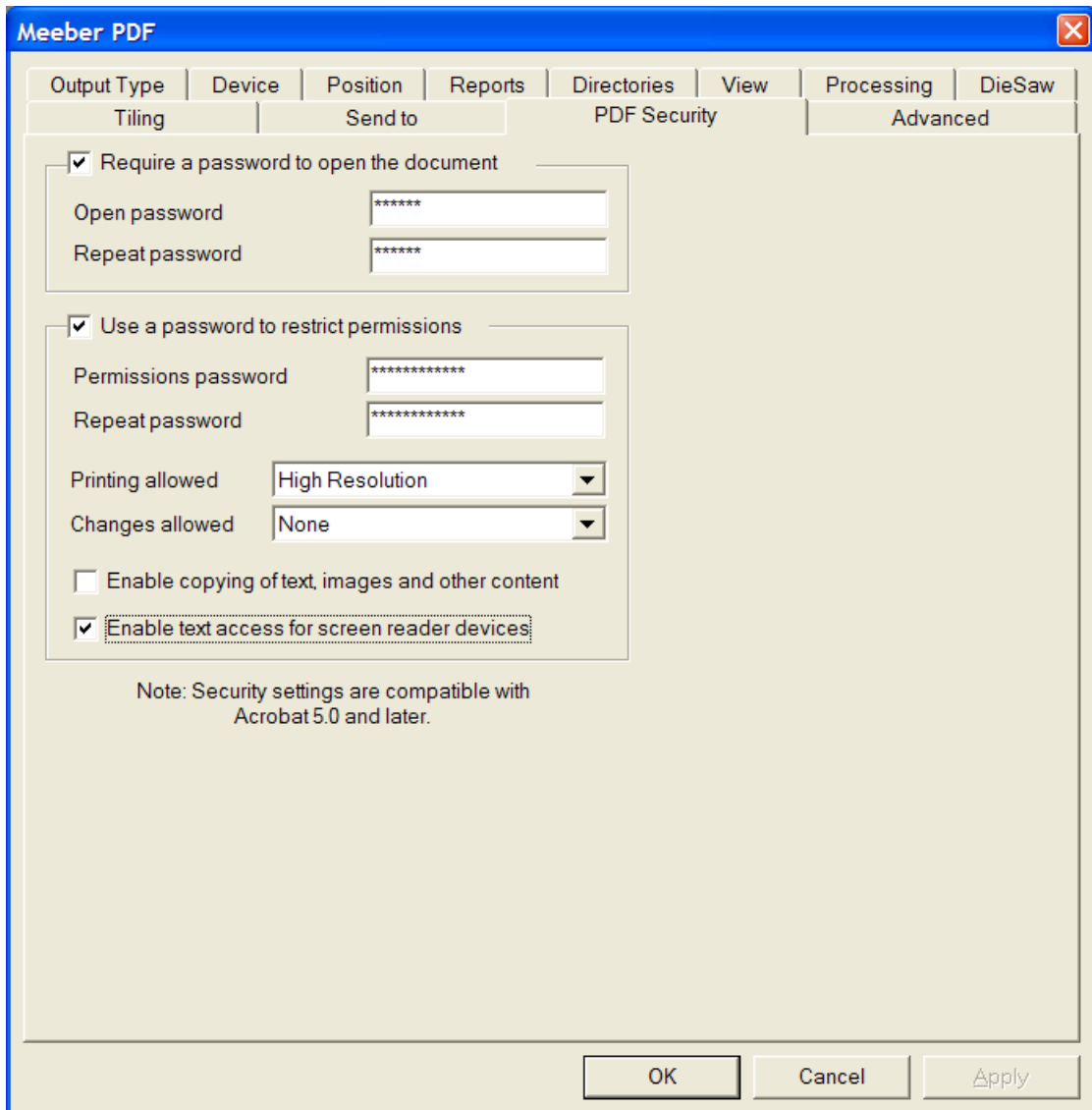

Checking **Require a password to open the document** requires the recipient of the file to enter a password when opening the PDF file using Adobe Acrobat Viewer. Enter this password in the **Open password** and **Repeat password** fields; they must match exactly. There is no way to recover this password if it is lost or forgotten.

Checking **Use a password to restrict permissions** requires the recipient of the file to enter a password to change how the file is protected. Enter this password in the **Open password** and

Repeat password fields; they must match exactly. There is no way to recover this password if it is lost or forgotten.

If both password options are used, the two sets of passwords must be different.

Note: If you forget a password, change the password in Defaults, save the changed Defaults, and then regenerate the PDF document. It will use the new password.

In the **Printing allowed** drop-down list box, there are three settings: **None**, **Low Resolution**, and **High Resolution**. **None** means the recipient may not print the document. **Low Resolution** allows printing as a bitmap up to 150 dpi. **High Resolution** allows printing the document at any resolution, and to use high-quality vector output and other advanced printing features if the printer supports them.

In the **Changes allowed** drop-down list box, there are three choices: **None**, **Page content changes only**, and **All changes allowed**. **None** allows no changes in Adobe Acrobat. **Page content changes only** restricts changes to what is shown on the page, but prevents other changes such as page rotation. **All changes allowed** allows any change.

The recipient of a PDF file created by ArtiosCAD with security options set must use Adobe Acrobat 5.0 or later to open the file.

Note: ArtiosCAD cannot open PDF files with an Open password, nor can it open PDF files that have restricted permissions and that do not have content copying enabled.

Configuring a PDF Output using Adobe® Acrobat® 5

To configure an ArtiosCAD Output that creates a PDF file using Adobe Acrobat 5, do the following:

1. Install Adobe Acrobat 5 as a custom installation, making sure to install the **Acrobat PDFWriter**.
2. Start ArtiosCAD, open Defaults, and create a new Plot output using the procedures described earlier in the chapter.
3. In the **Scale** group on the Output Type tab, click **To fit one page**.
4. On the Device tab, set the **Driver Type** to **Windows Driver** and select **Acrobat PDFWriter** in the Windows Driver drop-down list box. Also set the **Orientation** to **Optimum**. The orientation in ArtiosCAD works independently from the orientation in the printer driver; you may have to adjust the settings manually to achieve the desired output.
5. In the **Plot File** group on the Directories tab, set the extension to **.pdf**. Make sure to include the period before pdf.
6. Click **OK** and save the defaults.

Later versions of Adobe Acrobat will not work correctly with ArtiosCAD.

Note: ArtiosCAD also has a predefined PDF export and Output that use its native PDF method without requiring Adobe Acrobat 5 to be loaded on the system. These require no special configuration for use, but the option must be purchased and installed for them to work. If you have Adobe Acrobat 5, you can make PDF files in the method described above without having to purchase the PDF option in ArtiosCAD. However, without purchasing the PDF option, you will not be able to import PDF files or use high graphics mode.

Configuring 3D Outputs

3D has its own table in Defaults for Outputs. Shown below is the Artios catalog in **Shared Defaults > Outputs-3D**.

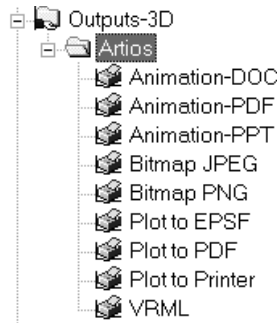

For detailed information about the options available in these Outputs, see *3D Outputs* in the *Outputs* chapter.

Creating a new 3D Output

To create a new 3D Output, do the following:

1. Start ArtiosCAD and click **Options > Defaults**.
2. In the Shared defaults pane, scroll down to the **Outputs-3D** catalog, right-click it, click **New**, and then click **Data** on the context menu.
3. Replace **New Data 1** with the name of the new Output.

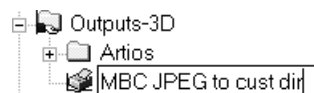

4. Press enter when you have entered the name and then double-click the new entry to access its Properties dialog box.

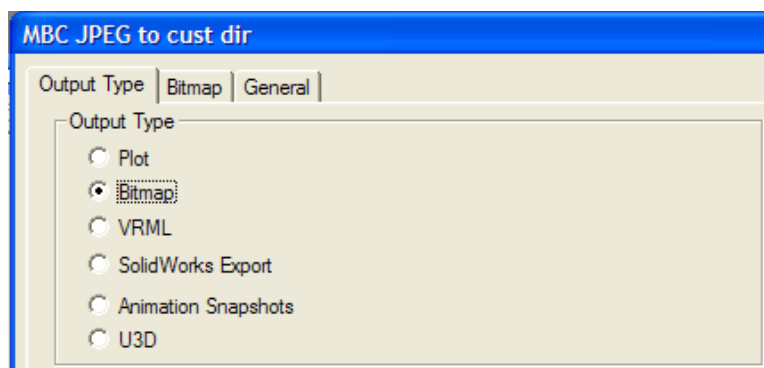

5. On the Output Type tab, choose the type of Output to make. **Plot** can either make a PDF file (if you have purchased that option), an Illustrator 8.0-compatible EPSF file, or the data can be sent to a device using a Windows printer driver. **Bitmap** makes a JPEG or PNG file. **VRML**, **SolidWorks Export**, and **U3D** all export to those file types. **Animation Snapshots** makes a series of bitmaps images of an animation and can output those to Microsoft Word, Microsoft PowerPoint, or PDF document, or to individual bitmap files. For this example, choose **Bitmap**.
6. Click the Bitmap tab.

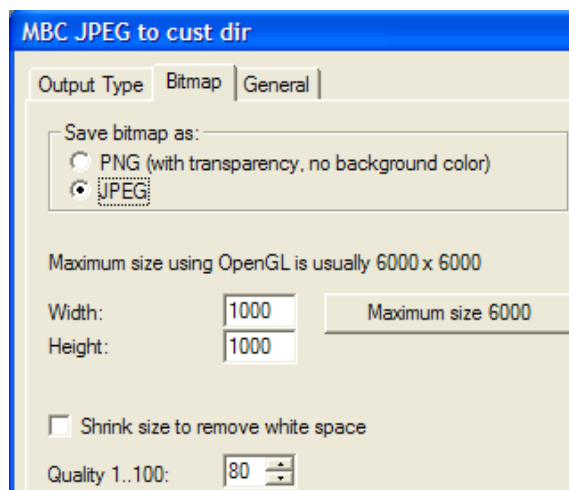

7. In the **Save bitmap as** group, choose **JPEG**. Set the other options as desired.
8. Click the General tab and enter a directory in the **Output directory:** field. Set the other options as desired.

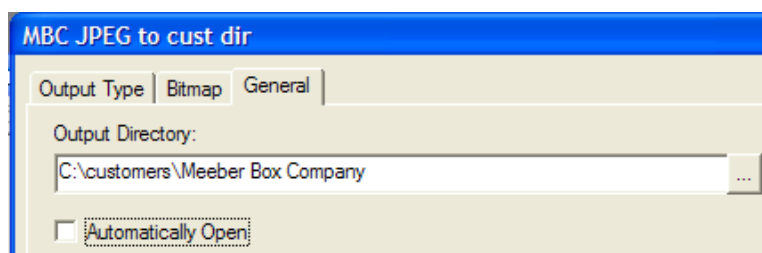

9. Click **OK** to finish defining the Output.
10. Click **File > Save**, and then click **Yes** to confirm overwriting shared Defaults.
11. The new Output in 3D is ready to use.

There are some slight differences between the options on the tabs in Defaults and those in the Outputs at time of use. For example, the **Use OpenGL for bitmaps** checkbox on the Bitmap tab when using an Output is set in the 3D Rendering Options entry in Startup defaults, not the Output defaults.

There is a fifth type of 3D Output available; **Animation Snapshots** exports each frame to individual PNG or JPEG files. For example, if you have an 8-frame animation, an Output of this type would produce 8 .JPEG or .PNG files in the same directory. When configuring an Output

of this type, on the Animation tab with **Export animation as:** set to **Bitmaps**, the **Bitmap Filename Generation** group appears. The options in this group configure how the different filenames are named. The root of each filename is the workspace name, and then the **Frame separator character** is inserted after the name, and either a number or letter is added as a suffix depending on the option chosen.

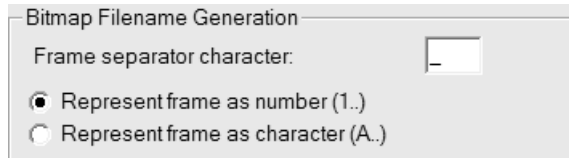

Changing Collada defaults

Using the Collada entry in the Outputs-3D catalog in Defaults creates a .ZAE file with .PNG images at the current graphics resolution.

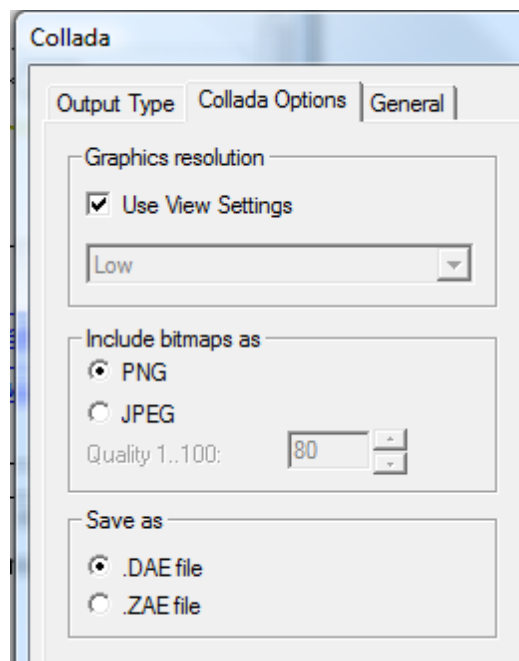

To change the settings, do the following:

1. Start ArtiosCAD.
2. Click **Options > Defaults**.
3. In the Shared Defaults pane, scroll down to the Outputs-3D catalog and open it by clicking the plus sign (+) next to it.
4. Double-click the **Collada** entry.
5. Click the **Collada Options** tab.
 - In the **Graphics resolution** group, **Use View Settings** uses the resolution set in the **View Mode** dialog box. Deselect it to enable the drop-down list box that sets the resolution setting manually.

- **PNG** and **JPEG** in the **Include bitmaps as** group control how the images are stored. Select **JPEG** to enable the quality setting.
 - In the **Save as** group, choose to save Collada files as standalone **.DAE** files or **.ZAE** archive files.
6. Click **OK** when done setting the options to return to Defaults.
 7. Click **File > Save** to save the changes.
 8. Click **Yes** to overwrite the existing Defaults.

Note:

You may want to create additional Collada entries with different options set for ease of output. Make sure to set the Output Type to **Collada** on the **Output Type** tab of the dialog box.

Rule labels

You can define rule labels for special rules that appear in the design when viewing the design, or when printing the design, or both. Rule labels display the specific rule type as the generic rule type plus whatever label you specify.

To configure this, you must add a rule label to the rule definition in the Special Rule Types catalog in Defaults.

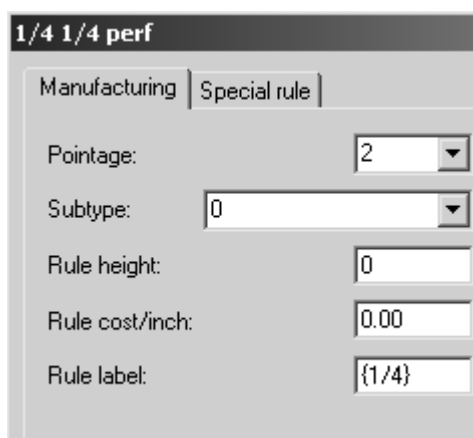

Enclosing the fraction in braces causes ArtiosCAD to display it as a real fraction, such as $\frac{1}{4}$.

To turn on rule labels when working in ArtiosCAD, open the View Mode dialog box, select the **Rule labels** checkbox, and click **OK**.

Shown below is a hanger hole made from $\frac{1}{4}$ by $\frac{1}{4}$ perf with rule labels turned off.

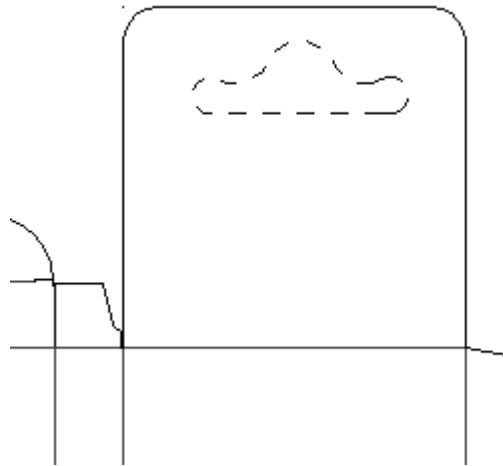

Here is the same hanger hole with rule labels turned on:

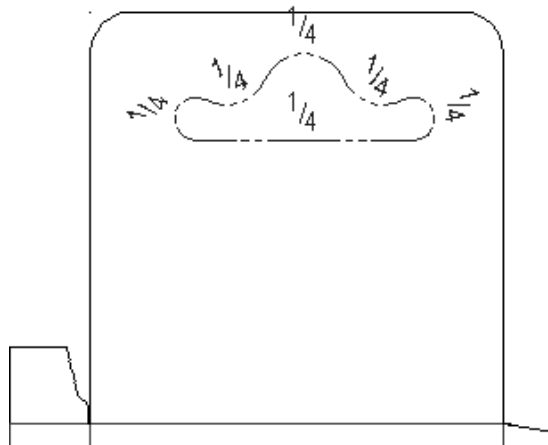

To turn on rule labels as a function of an output, check the Rule Labels checkbox on the View tab of the output's properties page.

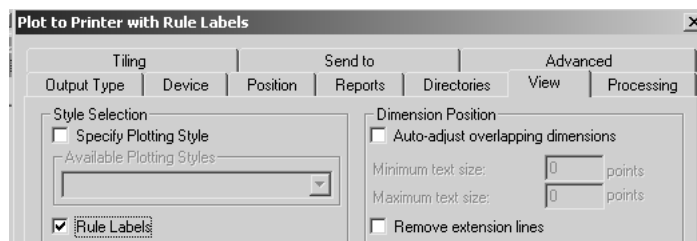

The defaults for the size and default appearance of the rule labels are stored in the **Rule Labels** entry in Design defaults.

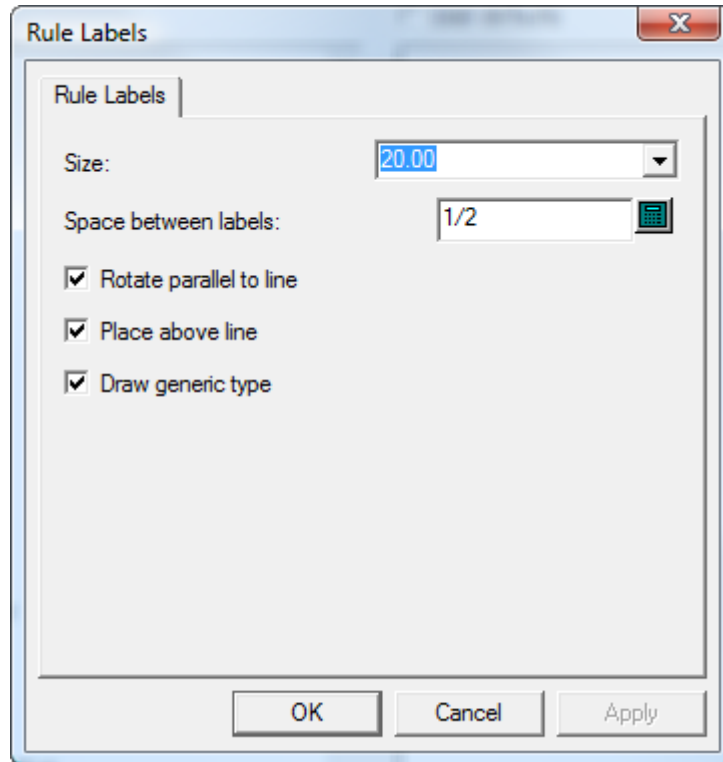

The **Size**: of the rule label is in points. The value in the **Space between labels** controls how often along the line the label is repeated. **Rotate parallel to line** determines if the label is parallel to the rule or always shown so that it is easily readable. **Place above line** controls if the label is in the line or above the line. Draw generic type controls if ArtiosCAD

Shown below is the same hanger hole with **Rotate parallel to line** and **Place above line** turned off.

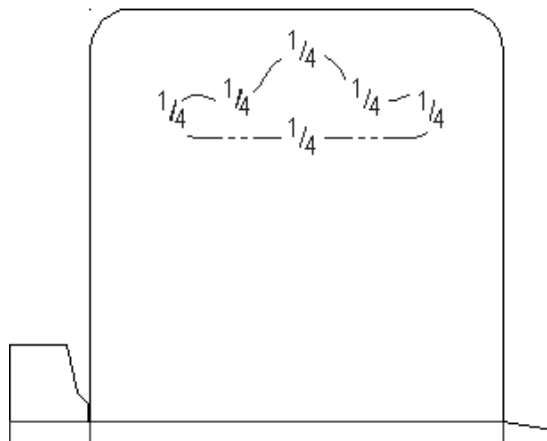

Configuring the Output Scale Table

To add or remove values from the Output Scale Table, do the following:

1. Start ArtiosCAD and click **Options > Defaults**.
2. Open the **Startup Defaults** catalog by clicking the plus sign preceding it (+) and double-click **Output Scale Table**. It should look similar to the picture below:

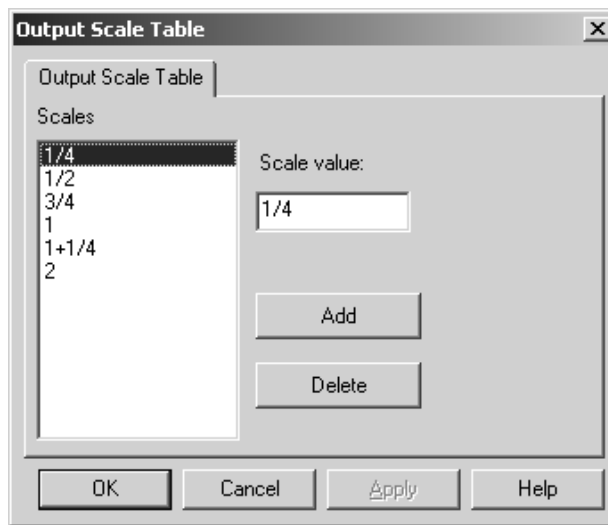

3. To add a value to the table, click **Add** and enter the value in the **Scale value:** field. The value you enter must be a least 0.005 units of measurement different from any other value.
4. To delete a value from the table, select the value and click **Delete**. There must always be at least one value in the table; the last value can not be deleted.

Notes on using the Output Scale Table

When using the Output Scale Table, the scale that is actually used is stored in the **Plotting Scale** variable in the General Information calculated text catalog. Insert this item of calculated text on the report to show the scale used.

If the report itself is scaled when it is output, that scale will be applied to the file window. In addition, all calculated text fields that use the Plotting Scale system variable (#FWSCALE) will be reevaluated using the combined file window scale and report scale.

AutoSave / Local Temp Directory

The **AutoSave** default in Startup defaults automatically saves a backup copy of open workspaces in the **Local Temp Directory** at the interval defined in the **AutoSave every:** field. ArtiosCAD AutoSaves only when the **Activate AutoSave** checkbox is selected.

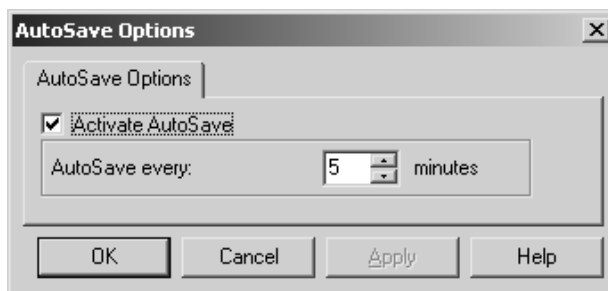

The **Local Temp Directory** is configured in the **Local Temp Directory** default in Startup Defaults.

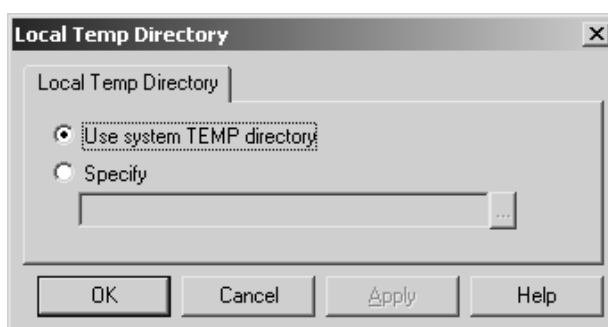

The system TEMP directory is defined by an environment variable. See your system administrator, or refer to your operating system documentation for more information on changing the system TEMP directory.

To set your own TEMP directory, select the **Specify** option and browse for the desired directory. Everyone must have write access to that directory. The Local Temp Directory must be on the current machine - it may not be set to a network drive.

The AutoSave timer is NOT active when:

- a dialog box is open
- when the Rebuild Playback tool is in use
- when the Interact window is open.

The AutoSave file is named BCKxxxxx.AAS, where **xxxxxx** is a random number, and AAS stands for **ArtiosCAD Auto Save**.

No database synchronization is done with the AutoSave file, nor is it saved in the database.

Recovering AutoSave files

The first time ArtiosCAD starts after an improper termination, the AutoSave Recovery dialog box will appear listing the workspaces for which AutoSave files exist.



Check the checkboxes next to each file to recover and click **OK**. The AutoSave files will be restored for the selected files; SAVE the workspaces once they are open. AutoSave files that are not selected for restoration are deleted automatically.

Revision Disk File Format in Revision History

The **Revision History** feature of ArtiosCAD relies on changing the name of files as they are stored on the hard drive. How file name is changed is controlled by **Options > Defaults > Startup defaults > Revision Disk File Format**.

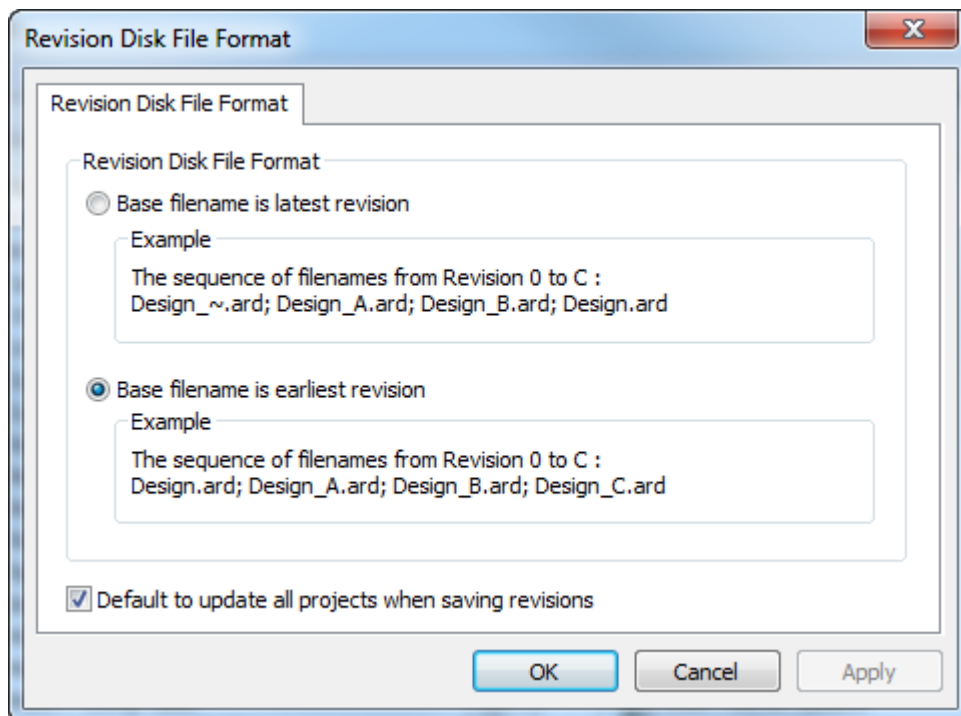

For example, consider a file called **FILE**. If you choose the first option, **Base filename is latest revision**, and create a new revision, then the latest revision becomes **FILE** and the original becomes **FILE_~**. If you then make a new revision, then the latest file will still be **FILE**, the original will be **FILE_~**, and the first revision from the original will be **FILE_A**. In this case the latest **FILE** would also be **FILE_B**, but the **_B** extension will not be visible; if you open other revisions they will warn you that the latest revision is **FILE_B**.

If you choose the second option, **Base filename is earliest revision**, then each new revision gets appended in sequence: the original is and will always be **FILE**, the second revision will be **FILE_A**, the third will be **FILE_B** and so on. The most recent revision will be the one with the highest extension.

Default to update all projects when saving revisions, when checked, causes ArtiosCAD to update all Projects that contain the current design when you use **Save As Revision**. When cleared, ArtiosCAD updates only the current Project when you use **Save As Revision**. Also when this option is cleared, If the design is not in a Project, or the design is not in the active Project, no Projects are updated with information about this revision. This option is checked by default.

Note:

As of ArtiosCAD 16.1, the default option is the second option to better support canvases. If you have upgraded from a previous version, the previous setting is preserved.

Database Browser Reports

This information is supplied for reference only. Only the most advanced users of ArtiosCAD who are very familiar with XSLT and XML technology should consider modifying the database reports.

There are two types of Database browser reports - those used in the ArtiosCAD browsers and those used in DataCenter Admin.

ArtiosCAD Database browser reports are configured in the Database Browser Reports Catalog in Defaults.

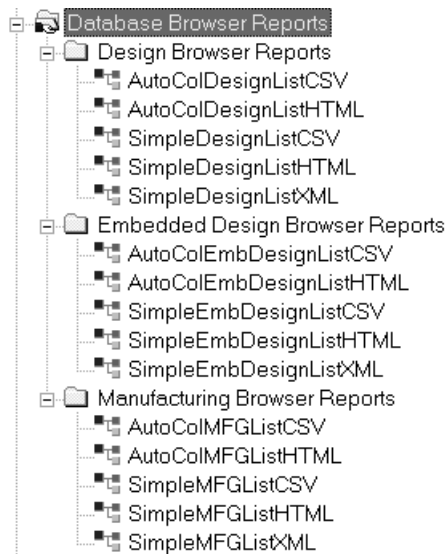

There are two reports for each ArtiosCAD browser. The **AutoCol Browser List format** automatically detects which data are selected for inclusion in Defaults and includes them on the report.

The **SimpleEmb Browser List format** presents just the information shown in the browsers.

The reports use three formats:

- CSV - produces a CSV (Comma Separated Values) file suitable for importing into a spreadsheet.
- HTML - makes an HTML (Hyper Text Markup Language) document which can be viewed in a Web browser.
- XML - makes an XML (eXtensible Markup Language) file suitable for delivering data to other applications in a rich, structured way. Only the Simple reports use this format.

Shown below is the Properties dialog box for the AutoColDesignListHTML report for illustrative purposes. For the reports with Simple in their name, any modifications made to the data included in the report require modifying the XSLT transformation file to put that data into the output file. The reports with **Auto** in the name automatically recognize the data included so the items in **Select Data to Include** can be added and removed as desired.

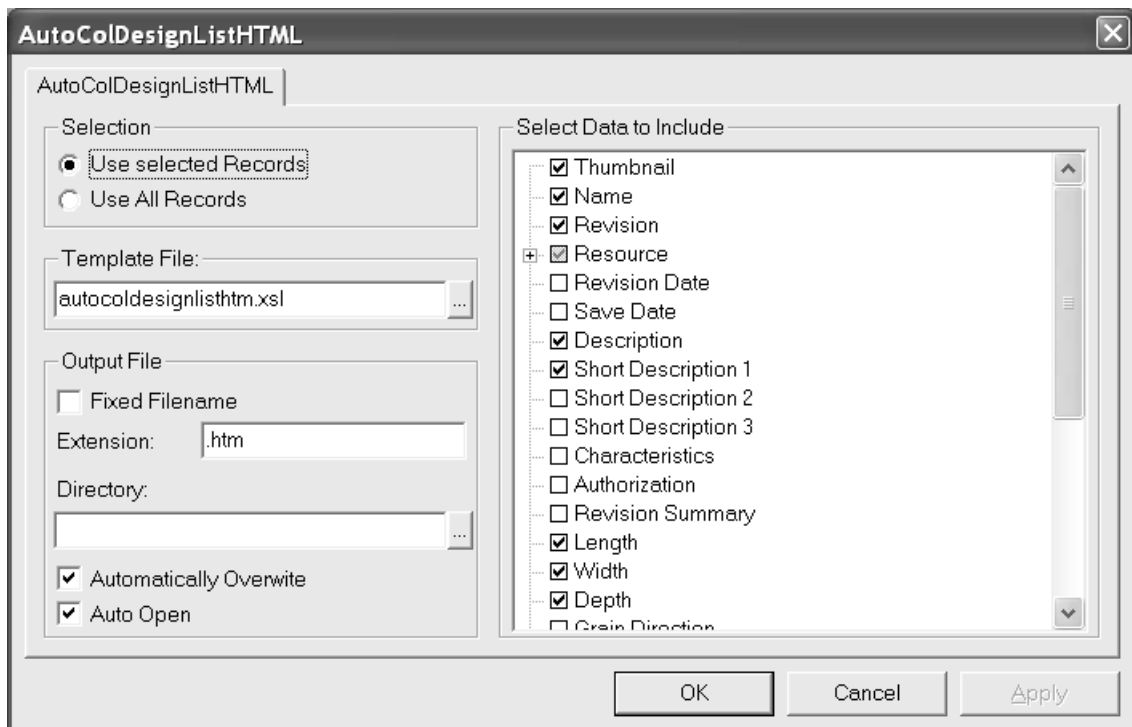

The option buttons in the **Selection** group control which database records are included in the report when it is output.

The **Template File**: field controls which XSLT template is used with the report. For the ArtiosCAD browsers, the template files are stored in InstLib. For the DataCenter Admin browsers, the template files are stored in the language directory of the DataCenter program folder.

The options in the **Output File** group control where the output file is created and how it is treated after it is created.

The **Select Data to Include** group controls the data going into the raw XML file before it is translated into the output file by the XSLT file. If **Thumbnail** is selected, a JPG thumbnail for each record is saved in the same directory as the report file.

DataCenter Admin reports use hard-coded report names with extension .XSL that are in \Esko\Artios\DataCenter\Program\ <language> .

The reports use XSLT files that are not meant for modification except by the most advanced users who are already familiar with XSLT and XML. Modifying the catalog entries in Defaults only modifies the information going into the raw XML file - the XSLT transformation template must also be updated to use the information. **It is your responsibility to edit or create a new XSL template file used to format the data into the output file.**

Publishing ArtiosCAD documents to WebCenter

To configure ArtiosCAD for publishing documents to WebCenter, double-click **Publish to WebCenter** in the WebCenter catalog in Shared Defaults.

Note: The WebCenter servers must be running version 6.1 or greater. ArtiosCAD can publish to a single WebCenter site. Change the **WebCenter address** field in the Publish to WebCenter dialog box in Defaults as needed to publish to more than one WebCenter site.

Shown below is the default Publish to WebCenter dialog box.

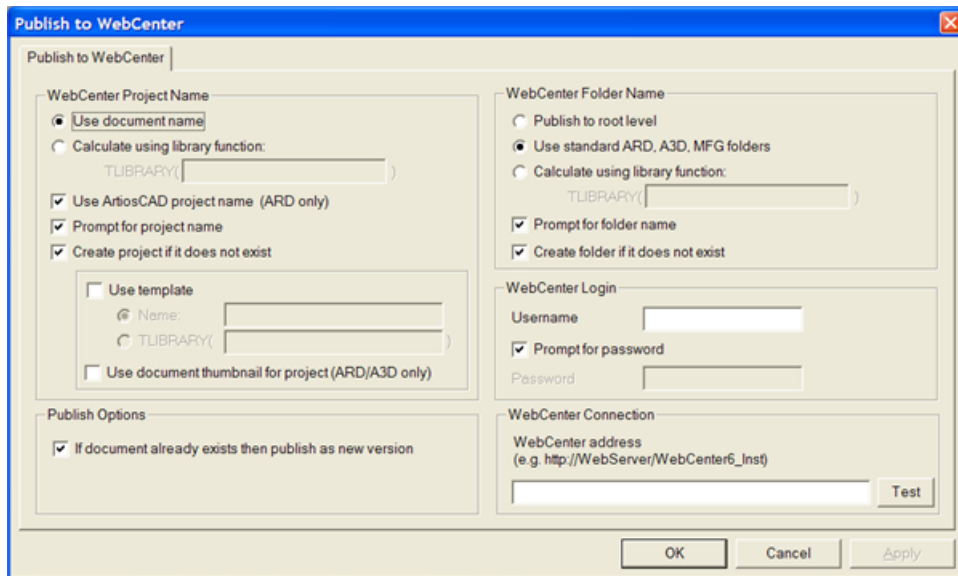

WebCenter Project Name group

The options in the **WebCenter Project Name group** control which WebCenter Project receives the ArtiosCAD document.

Use document name uses the ArtiosCAD document name as the WebCenter Project name.

Calculate using a library function lets users with advanced ArtiosCAD knowledge use a library function to determine the WebCenter Project name. Enter the name of the library function in the **TLIBRARY()** field.

Use ArtiosCAD project name (ARD only) names the WebCenter Project after the ArtiosCAD project name if one was defined. This option overrides **Use document name** and **Calculate using a library function**.

Prompt for project name prompts for the Project name. If any Prompt option is selected, the Publish to WebCenter dialog box appears when publishing. They all must be deselected in order to hide that dialog box when publishing.

Create project if it does not exist creates the WebCenter Project named using the options selected in the previous fields if it does not already exist. If this option is deselected and the WebCenter Project does not exist, when ArtiosCAD tries to publish a document into that WebCenter Project, an error will occur.

Use template lets you specify the template to use to create the Project. Enter its name in the **Name** field or enter the name of the library function used to calculate the name in the **TLIBRARY()** field.

Use document thumbnail causes WebCenter to use the thumbnail for the single design or 3D document as the Project thumbnail.

Publish Options group

If document already exists then publish as new version controls what happens when a document with the same name as the document being published already exists in the same folder in the WebCenter Project. When this option is selected, the document being published is treated as a new revision of the document already in the WebCenter Project. When this option is not selected and a document exists with the same name as one being published, an error will occur.

WebCenter Folder Name group

The options in the **WebCenter Folder Name** group control where in the WebCenter Project the ArtiosCAD document is placed once it is published.

Publish to root level puts the ArtiosCAD document in the default folder in the Project. Security on this folder is inherited from the WebCenter Project security settings.

Use standard ARD, A3D, MFG folders uses folders with those names for ArtiosCAD documents with those filename extensions. Single designs would go into a folder called ARD, 3D documents into A3D, and manufacturing files into MFG.

Calculate using a library function lets users with advanced ArtiosCAD knowledge use a library function to determine the folder name. Enter the name of the library function in the **TLIBRARY()** field.

Prompt for folder name prompts for the folder name. If any Prompt option is selected, the Publish to WebCenter dialog box appears when publishing. They all must be deselected in order to hide that dialog box when publishing.

Create folder if it does not exist creates the folder named using the options selected in the previous fields if it does not already exist. If this option is deselected and the folder does not exist, when ArtiosCAD tries to publish a document into that folder, an error will occur.

WebCenter Login group

The WebCenter system administrator must provide a username and password for the account ArtiosCAD will use to publish documents to WebCenter. Enter the username in the **Username** field. Prompt for password causes the ArtiosCAD user to have to enter a password when publishing. Deselecting this option causes the **Password** field to become available. If you

specify a username and a password, they will be automatically entered in the Publish to WebCenter dialog box when publishing.

WebCenter Connection group

Enter the URL for the WebCenter server in the **WebCenter address** field.

Note: ArtiosCAD may only publish to the WebCenter site listed in this field. To publish to another WebCenter site, change this field as needed.

Test tests the connection to the WebCenter server. The test is successful **only** if you receive a message that the WebCenter Web-API was properly installed. Any other response means the test failed.

Graphic PDF file rotation import option

A PDF file can contain an internal flag to indicate if the document is rotated or not. ArtiosCAD has ignored this setting until version 7.35. In **Options > Defaults > Shared Defaults > Startup defaults > PDF Options** is the **Honor Acrobat Rotation** checkbox. To have ArtiosCAD respect this flag when importing a PDF file as graphics, enable this checkbox. The checkbox is not selected by default, and has no effect for PDF files imported as lines.

Using Spot Colors in PDF files

You can configure PDF Outputs to use spot colors for the line color definitions instead of using plotting style information. To make this change, it is best to copy an existing PDF Output to a new one in Defaults and change its name, and then modify the new entry.

1. Click **Options > Defaults**.
2. In Shared Defaults, copy an existing PDF Output to an entry with a different name, such as Plot to PDF using spot colors.
3. Double-click the new entry and click the **Device** tab.
4. Click ... (Browse) at the end of the Tuning Filename field.
 - a) Navigate to InstLib.
 - b) Change the filetype selector to **All files (*.*)**.
 - c) Click Tune.PDF.SpotColors.xml and then click **Open**. The entry in the Tuning Filename field should change accordingly.

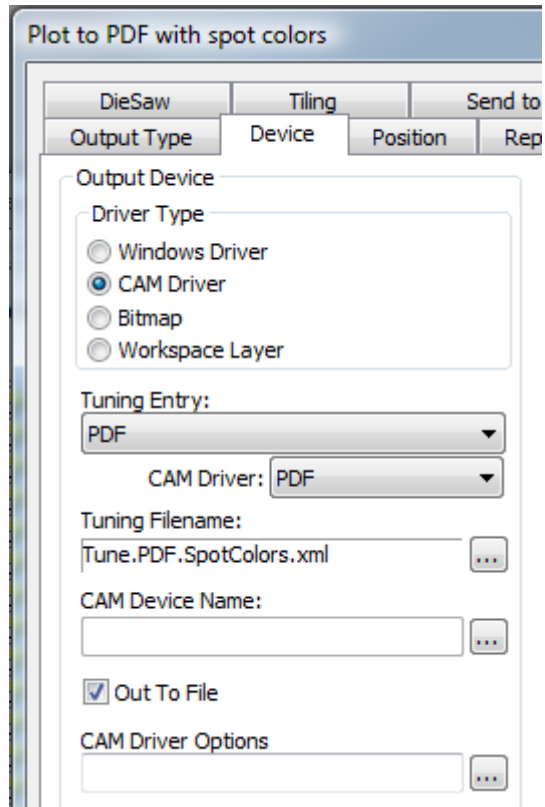

5. Click **OK** to make the change.

6. Click **File > Exit** and click **Yes** when asked to save and then overwrite the Defaults.

Shown below are the Ink Manager palettes for two PDF versions of the same single design, one using the default method and the other using the spot colors method.

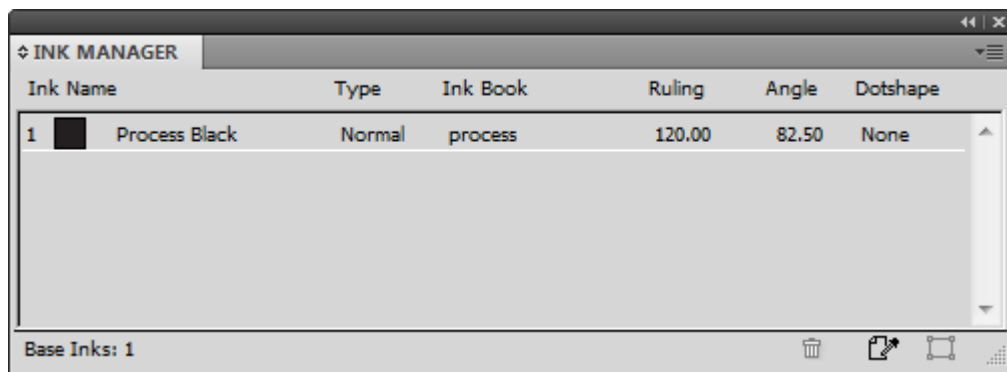

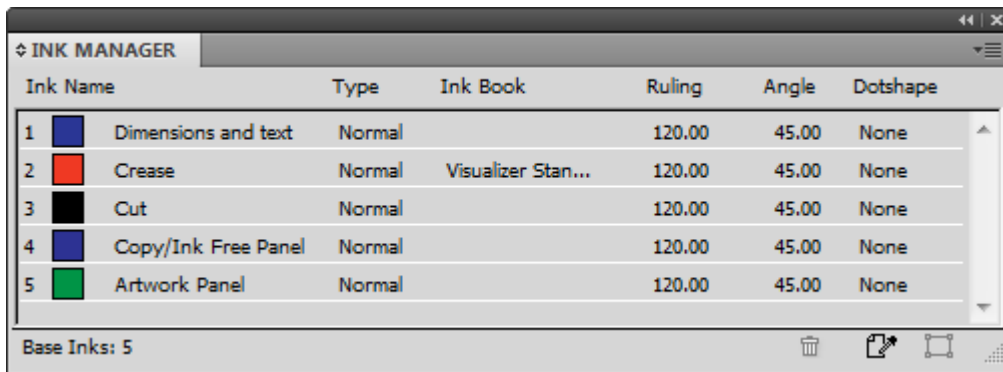

To change the ink names, RGB color values, stroke widths or stroke styles used by this method, make the changes in PDFSpotColorMap.xml.

Layered PDFs

You can specify custom PDF Outputs that maps linetypes into layers. PDF Output tuning works using an XML tuning file. The easiest way to do this is to copy the example Tune.PDF.Layered.xml tuning file in InstLib and modify it to suit your needs. Save your modified version to ServerLib and add a new Output using that tuning file.

Shown below is an excerpt from the tuning file.

```
<!-- Line type 20 is used for Text items - map these to a layer called "Text Layer"-->
<MAP ARTIOSCAD_LINE_TYPE="20">
  <PDF_LAYER NAME="Text Layer"/>
</MAP>

<!-- Line type 14 is used for Image and graphics items (strokes and fills).
Map these to a layer called "Image Layer"-->
<MAP ARTIOSCAD_LINE_TYPE="14">
  <PDF_LAYER NAME="Image Layer"/>
</MAP>
```

To map a specific line type to a layer:

1. Create your custom tuning file by copying the example one from InstLib to ServerLib and opening it in a text editor. Save it with a different name.
2. Copy one of the MAP nodes to the bottom of the PDF_LINE_TYPE_MAPPING node. Copying the comment (the part enclosed in <!-- and --> is optional).
3. Change the line type number to the new line type. A list of line types is in the appendix.
4. Change the name of the layer in the NAME attribute of the PDF_Layer tag.
5. Save the file.

For example, to have all Outside Bleed lines in their own layer, create a block like this:

```
<!-- Line type 11 is used for Outside Bleeds.
Map these to a layer called "Outside Bleeds"-->
<MAP ARTIOSCAD_LINE_TYPE="11">
  <PDF_LAYER NAME="Outside Bleeds"/>
</MAP>
```

For more examples of how you can customize PDF output, refer to the following example files in InstLib.

- Tune.PDF.UsePlottingStyle.xml shows how to use the current plotting style to render PDFs. This is the default if no tuning is specified or is not found.
- Tune.PDF.UseSpotColors.xml shows how to use technical inks in the PDF.
- Tune.PDF.Layered.xml shows how to map particular line types to PDF layers.
- Tune.PDF.Example.xml is an example tuning using a combination of layers and rendering options.

Setting Cape/TOPS Defaults

Before you use the palletizing features, you must set the Cape Pack/TOPS Defaults by doing the following:

1. Start ArtiosCAD.
2. Click **Options > Defaults**.
3. In the list of Shared defaults, scroll down to the Palletization catalog and open it by clicking the plus sign (+) next to it.
4. Double-click **CAPE/TOPS Defaults**.

The Cape Pack Defaults dialog box opens as shown below.

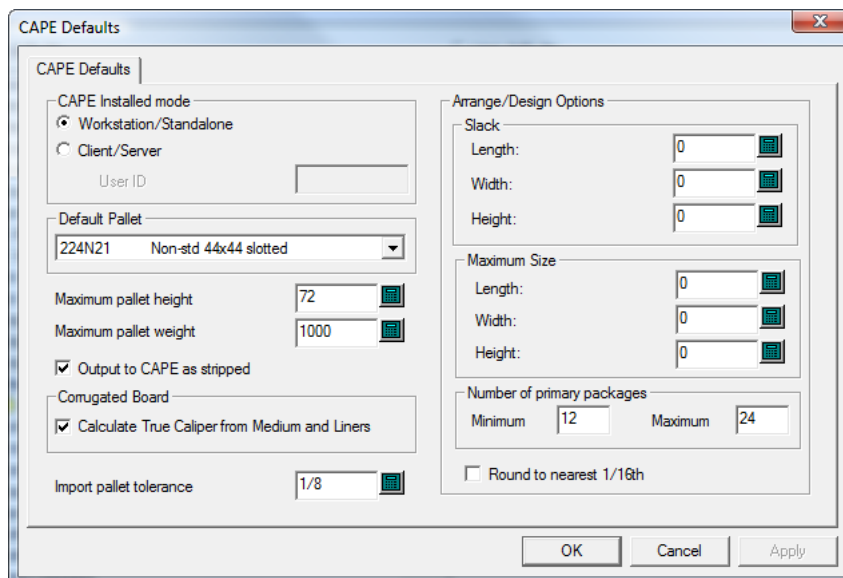

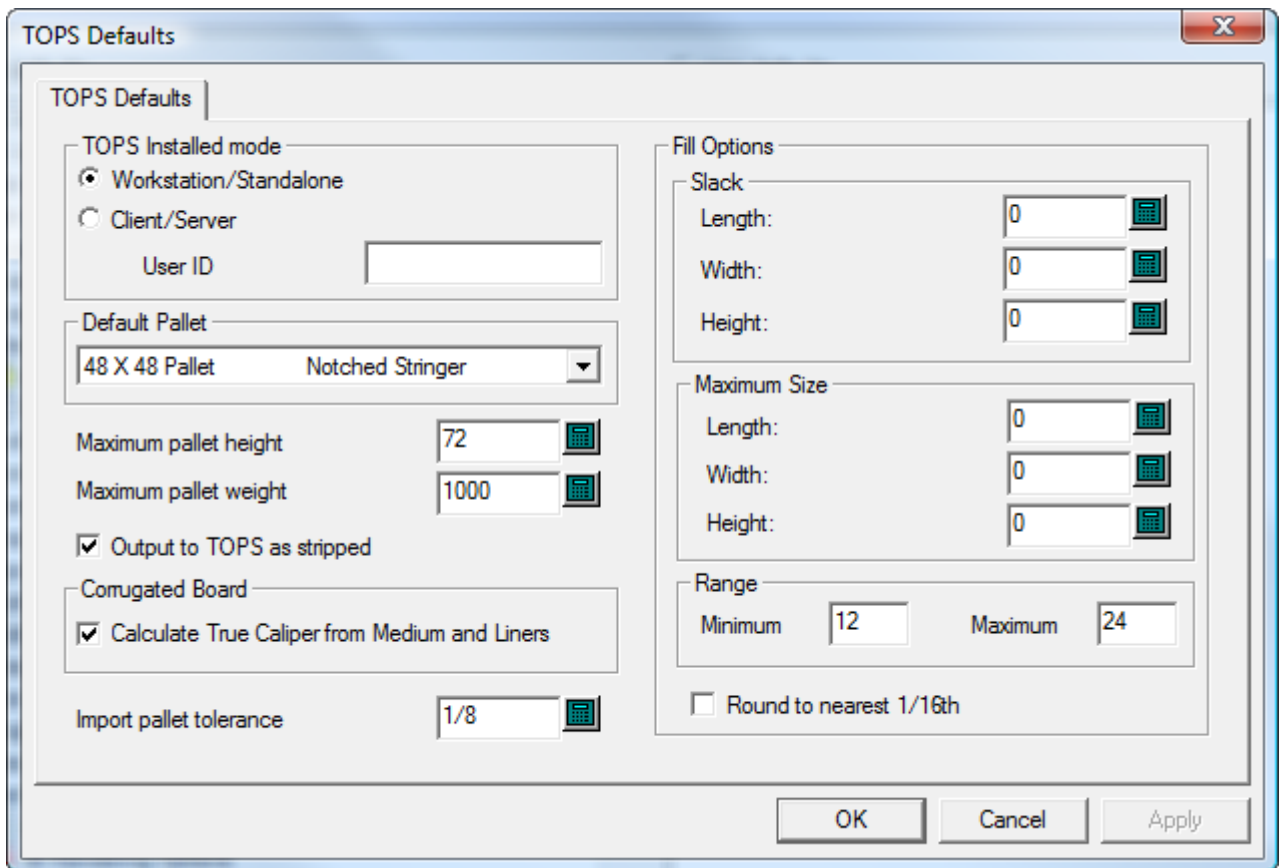

5. Set the options in the dialog box as desired.
 - a) If you are using Cape Pack/TOPS in client/server mode, select **Client/Server** and enter the User ID for Cape Pack/TOPS in the field provided. If you are using it in workstation/standalone mode, leave this field empty.
 - b) Choose a default pallet from the drop-down list box in the **Default Pallet** group.
 - c) Set the **Maximum pallet height** and **Maximum pallet weight** appropriately using inches and pounds or millimeters and kilograms.
 - d) To not see the waste areas of the layout and see only the designs in CAPE/TOPS, check **Output to CAPE/TOPS as stripped**.
 - e) To calculate the caliper from the board elements instead of using the caliper defined by the board code, check **Calculate True Caliper from Medium and Liners**.
 - f) Set an **Import pallet tolerance** for use when exchanging design data between ArtiosCAD and Cape Pack/TOPS. As the outer dimensions of the Cape Pack/TOPS pack type and the ArtiosCAD standard may not match, the tolerance will make it easier to generate pallet loads.
 - g) In the **Arrange/Design Options** group, set the default amount of slack and the default maximum package size.
 - h) In the **Number of primary packages group**, set the minimum and maximum number of primary packages in the secondary package.
 - i) Set **Round to nearest 1/16th** as desired. This works in Inches mode only.
 - j) Click **OK** to return to Defaults when you are done setting the Cape Pack/TOPS Defaults.
6. Click **File > Save** to save the changes.

- Click **Yes** to confirm the saving of the changes to Defaults and return to ArtiosCAD.

Setting DWG/DXF Options

DWG/DXF Options in the Startup defaults catalog is where you:

- set whether or not to use third-party import libraries
- map font names in DWG/DXF files to Windows TrueType fonts.

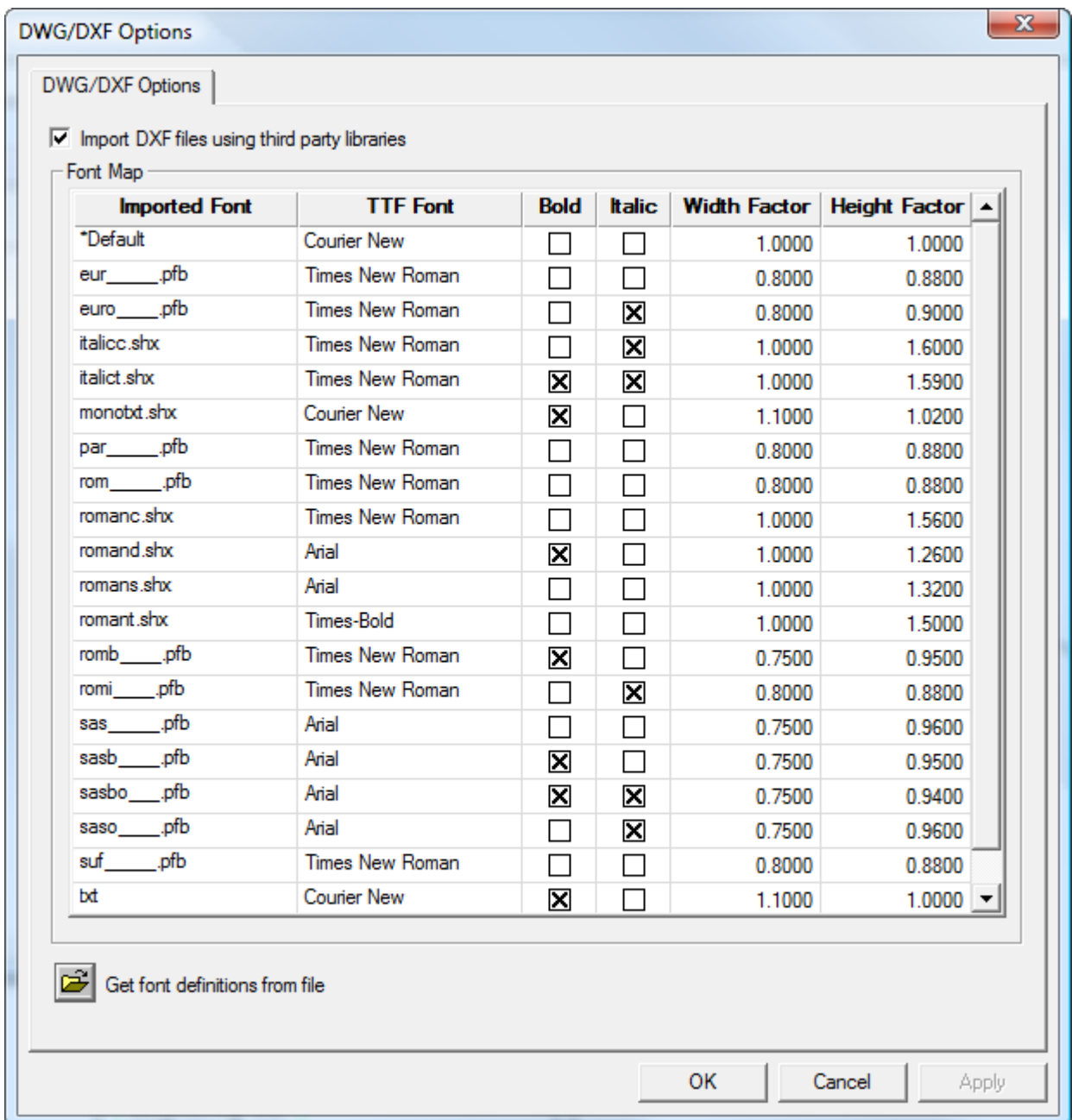

Import DXF files using third party libraries controls whether or not ArtiosCAD uses a more robust method to open DWG or DXF files than its built-in method. If you have trouble importing DWG or DXF files, try deselecting this checkbox.

ArtiosCAD does not display the fonts that DWG or DXF files use. Therefore, those fonts have to be mapped to the Windows TrueType (TTF) fonts that ArtiosCAD does display. In the default map shown above, **Width Factor** means the kerning and **Height Factor** adjusts the height of the text. To change any of the fields other than **Imported Font**, click in the field. ArtiosCAD maps any unmapped fonts using the ***Default setting**.

If you have a DWG/DXF file containing unmapped fonts (text will be the wrong size), click **Get font definitions from file**, then browse for the file. ArtiosCAD scans the file and sets up new map entries with which you can then configure as desired. It then stores FontMap.XML in ClientLlb which you can copy between machines as needed.

Note: ArtiosCAD does not use font mapping if **Import DXF files using third party libraries** is not checked.

Color Palettes

ArtiosCAD comes with three color palettes that you use to pick colors. A palette can have RGB colors or CMYK colors. RGB is way of defining colors based on the amount of red, blue, and green in them. CMYK defines colors based on cyan, magenta, yellow, and black. You can also make custom palettes as desired.

The three default palettes are:

- Artios CMYK Palette. This palette contains some of the colors from the color picker in previous versions of ArtiosCAD.
- CMYK Palette. This palette contains a selection of CMYK colors.
- RGB Palette. This palette contains a selection of RGB colors.

Note: Plotting styles and toolbar colors use color choices specifically chosen for clarity. They do not use palettes.

Adding a New Color Palette

To add a new color palette, do the following:

1. Click **Options > Defaults**.
2. Right-click **Color Palettes** and click **New > Data**.
3. Enter a name for the new color palette and press Enter. You should include the type of palette it is, either CMYK or RGB, in the name so that you know what kind of palette it is when you use it.

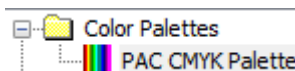

4. Double-click the new color palette to open its Properties dialog box.

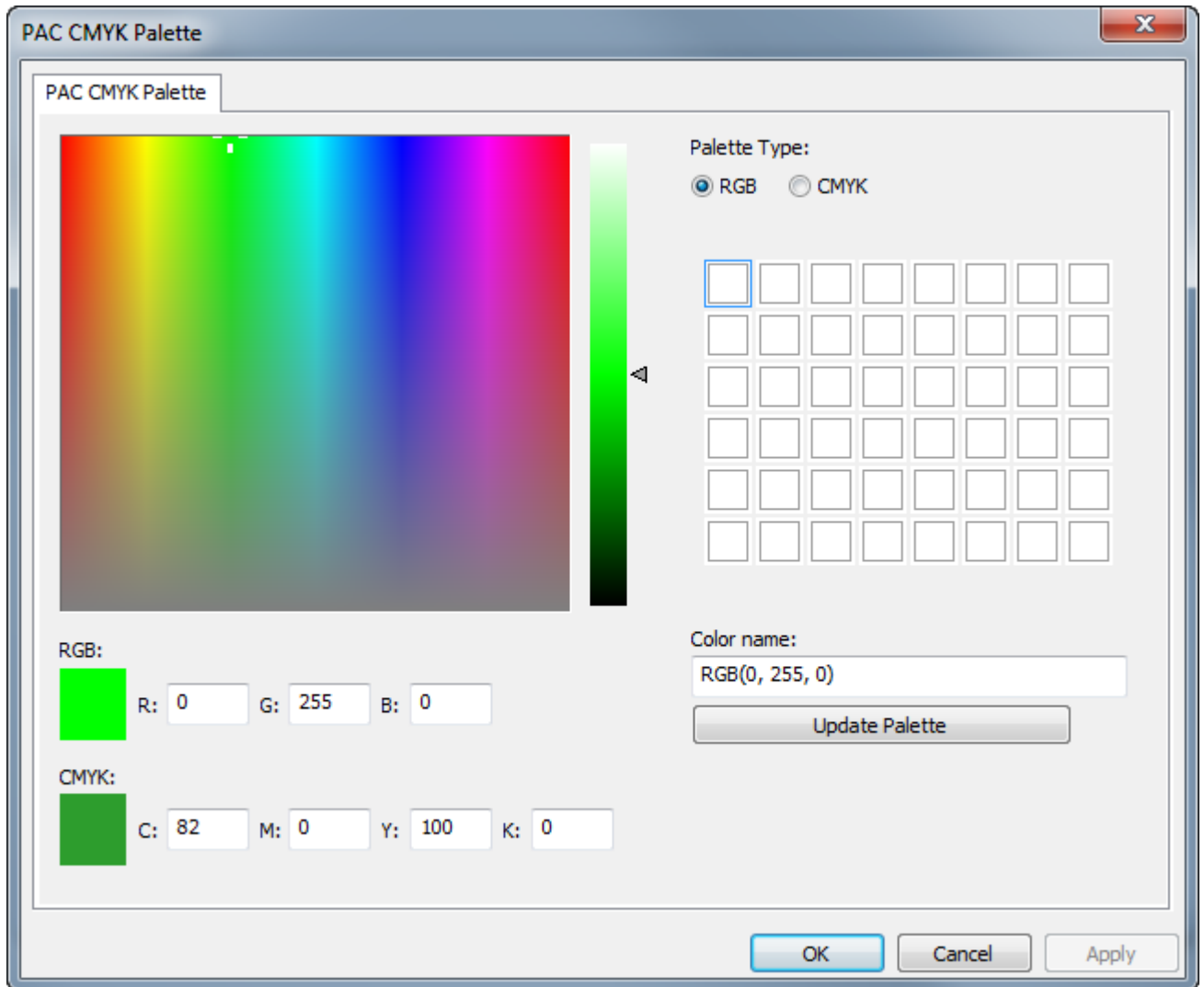

When you create a new palette, ArtiosCAD sets its type to RGB and initializes the colors to white.

- a) Change the palette type to **CMYK** if you are creating a CMYK palette.
- b) Click the square of the palette which will contain the color you are about to define. It will have a rectangle around it to show it is selected.
- c) Define the color by either typing the color values in the input fields for the type of color, or by using the mouse to set the hue and saturation in the color field and the luminance on the slider, or a combination of the two methods.
- d) ArtiosCAD automatically names the color *PaletteType(Values)*. If you leave the default name and later change the palette type, the color name changes automatically to reflect the different palette type. You can give the color a custom name, but it will not change automatically if you change the palette type.
- e) Click **Update Palette** to add the color to the palette. ArtiosCAD then automatically selects the next color square.
- f) Repeat the steps above to add colors as desired. Each palette can have up to 48 colors.

5. Click **OK** to save the changes to the color palette and return to Defaults. Save and exit Defaults normally.

Note: If you are adding new colors or palettes to use when setting a board color, you must completely exit Defaults after you have made the desired changes.

Color Palette by Feature

Some features in ArtiosCAD can use both color palettes, while others are limited to CMYK. For features that can only use CMYK palettes, ArtiosCAD only lets you select CMYK colors. If you want a palette that works in every tool that uses color, create a CMYK palette.

RGB Palettes or CMYK Palettes

3D Outputs > VRML Options > background color

Outputs > U3D Options > background color

3D > Light Source tool > light color

3D > View > Ambient Light

3D > Select > Double-click an object > Material properties tab > Outside board and Inside board colors

3D > View Mode > Background color > Select color

DataCenter Admin / Enterprise Board Browser > Boards > Create a new board or select an existing board and click Edit > Select Color

DataCenter Admin / Enterprise Board Browser > Boards > Create a new board or select an existing board and click Edit > Advanced color > Select color

Defaults > Customized toolbars > ArtiosCAD Toolbar Hover Color

Defaults > Startup defaults > 3D View Mode > Background color > Select color

Defaults > Startup defaults > Document Bar Options > Project Button Color

Defaults > Design defaults > VRML Export Options for CAD-X > Background color

Defaults > Property defaults > Mate > Glue type > 3D bead color

Single Design > Mate tool > Mate properties > Glue type > Bead color

Single Design > Select > Double-click the edge of a Mate > Properties > Glue type > Bead color

Defaults > Rubber types > Individual type color

Defaults > Special rule types > Tear tape > Individual tear tape > Special rule > Select color

Single Design > Select > Double-click a line with type Tear tape > Properties > Special rule > Select color

Defaults > Special rule types > Edgeband > Individual edgeband > Special rule > Select color

Single Design > Select > Double-click a line with type Edgeband > Properties > Special rule > Select color

CMYK Palettes Only

Defaults > Property defaults > Graphics > Fill Color and Stroke Color

Defaults > Property defaults > Text > Color > More colors

Defaults > Property defaults > Hatch > Custom > Line Type > Stroke > Color > More colors

Defaults > Property defaults > Hatch > Custom > Background > Fill > Color > More colors

Defaults > Property defaults > Line type label > Text color > More colors

Defaults > Property defaults > Text > Text color > More colors

Defaults > Startup defaults > Artwork Panels > Font and Color > Text Line 1 color > More colors

Defaults > Startup defaults > Dynamic Art > Label or Text color > More colors

Single Design > Select a filled or stroked object > Edit menu > Properties > Pick Fill Color and Pick Stroke Color

Single Design > Select > Double-click a filled or stroked object > Properties > Pick Fill Color and Pick Stroke Color

Single Design > Select a dimension > Edit > Properties > Color > More Colors

Single Design > Select > Double-click a dimension > Color > More Colors

Single Design > Paragraph Text > Color > More Colors

Single Design > Select text > Edit > Properties > Color > More Colors

Single Design > Select > Double-click a piece of text > Color > More Colors

Single Design > Hatch > More Options > Custom > Line Type / Stroke or Background / Fill > Color > More Colors

Single Design > Select a hatched panel > Edit > Properties > Custom > Line Type / Stroke or Background / Fill > Color > More Colors

Single Design > Select > Double-click a hatched panel > Custom > Line Type / Stroke or Background / Fill > Color > More Colors

Single Design > Edit > Property Defaults > Hatch > Custom > Line Type / Stroke or Background / Fill > Color > More Colors

Single Design > Line Type Label > More Options > Color > More Colors

Single Design > Line Type Label > More Options > Text box > Fill > Color > More Colors

Single Design > Select a line type label > Edit > Properties > Color > More Colors

Single Design > Select > Double-click a line type label > Color > More Colors

Single Design > Select a line type label > Edit > Properties > Text box > Fill > Color > More Colors

Single Design > Select > Double-click a line type label > Text box > Fill > Color > More Colors

Single Design > Edit > Property Defaults > Line type label > Color > More Colors

Single Design > Edit > Property Defaults > Line type label > Fill > Color > More Colors

Single Design > Color Stock > Pick Color

CMYK Palettes Only

Single Design > Artwork Panels > More Options > Font and Color > Text Line 1 > Color > More Colors

Single Design > Dynamic Art > More Options > Label or Text > Color > More Colors

Single Design > Select a Dynamic Art object > Edit > Properties > Label or Text > Color > More Colors

Single Design > Select > Double-click a piece of Dynamic Art > Label or Text > Color > More Colors

Choosing Default Color Palettes

You can specify a default color palette for ArtiosCAD to use in features that can use both RGB and CMYK palettes, and features that support only CMYK palettes.

1. Click **Options > Defaults**.
2. Expand the **Startup defaults** catalog.
3. Double-click **Color Palette Options**.

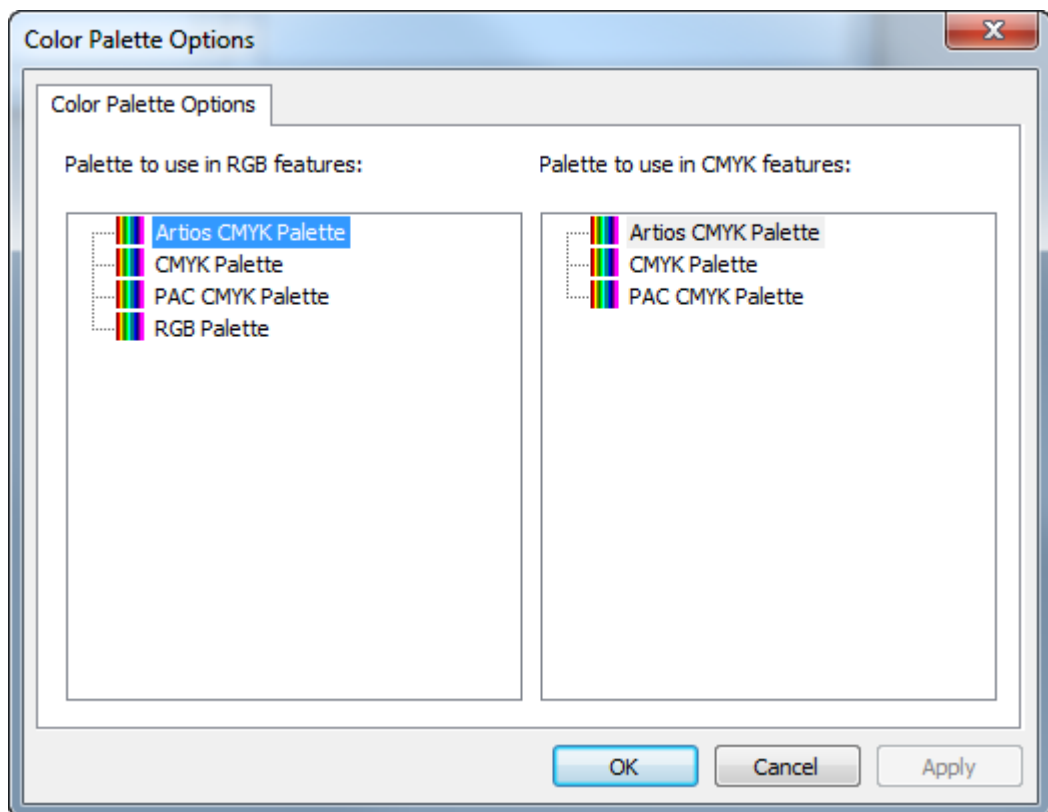

4. In each pane of the Color Palette Options dialog box, select the palette to set as the default for the type of feature.
5. Click **OK** to return to Defaults.

Canvas/Parts Options

Defaults for canvases and parts are in the **Startup defaults** catalog.

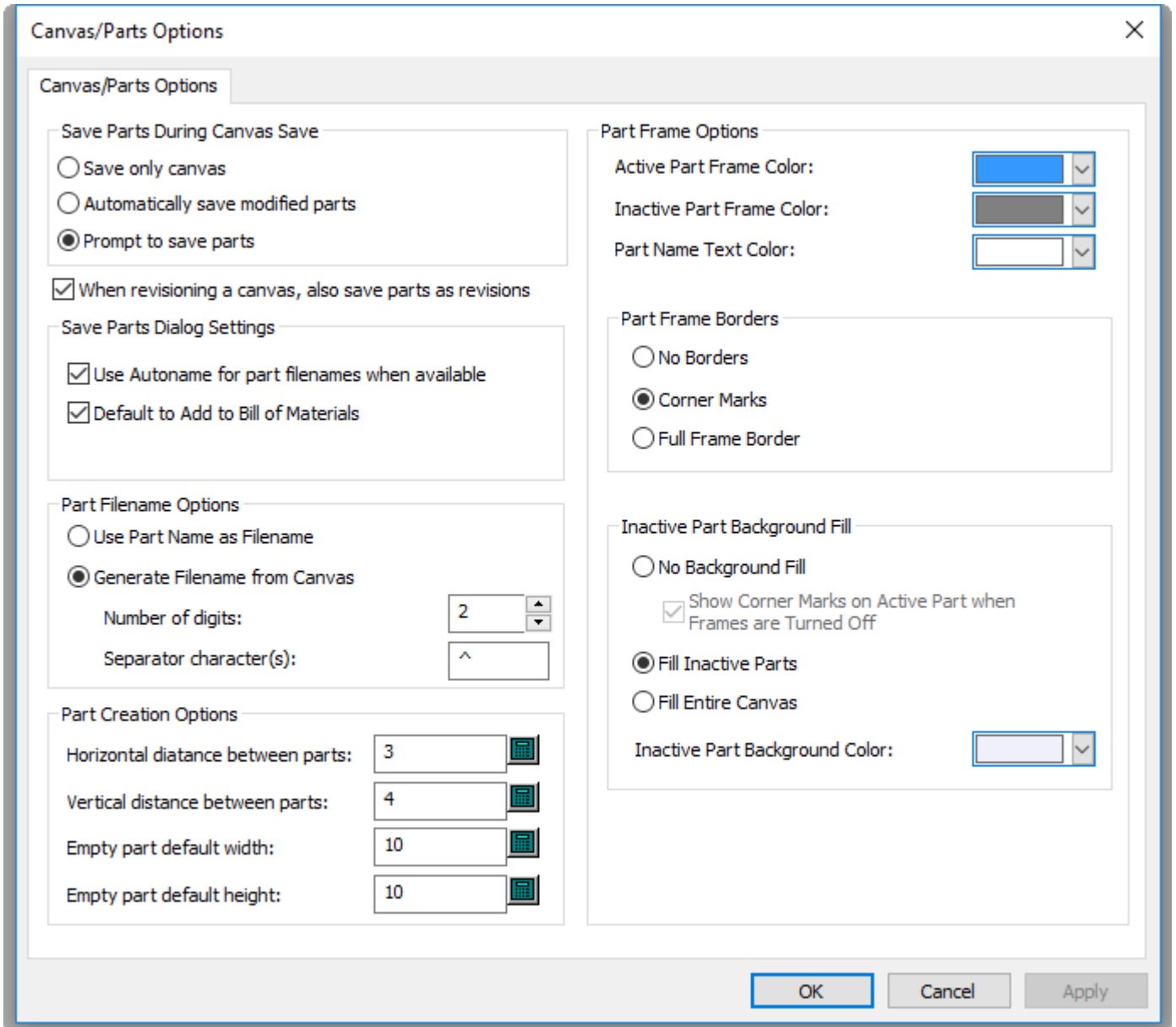

The options in the Save Parts During Canvas Save group control what happens when you save a canvas. You can choose to save only the canvas itself with **Save only canvas**, to **Automatically save modified parts**, or **Prompt to save parts**, the default.

When revisoning a canvas, also save parts as revisions keeps parts revised to the same level as their parent canvas. This is enabled by default.

In the Save Parts Dialog Settings group, choose what happens in the Save Parts dialog box. **Use Autaname for part filenames when available** will automatically assign filenames to parts when you have configured the Project or folder for autonaming. **Default to Add to Bill of Materials** controls the state of the checkbox when saving a design, or publishing a new revision or version if you're using ArtiosCAD Enterprise.

In the Part Filename Options group, choose how ArtiosCAD automatically names parts, either based on the part name, or on the name of the canvas. **Use Part Name as Filename** sets the filename to that of the part. **Generate Filename from Canvas** sets the root of the part name to the canvas name, followed by the **Separator character(s)** and a number that is the **Number of digits**.

In the Part Creations options group, **Horizontal distance between parts** and **Vertical distance between parts** control the gutter between parts when converting to a canvas and using **Auto Space Parts**. This gutter applies to outermost design lines in the part, not the part frames. **Empty part default width** and **Empty part default height** control the size of new parts.

The right half of the dialog box controls how parts appear in the canvas.

Part Frame Options

Active Part Frame Color: ▼

Inactive Part Frame Color: ▼

Part Name Text Color: ▼

Part Frame Borders

No Borders

Corner Marks

Full Frame Border

Inactive Part Background Fill

No Background Fill

Show Corner Marks on Active Part when Frames are Turned Off

Fill Inactive Parts

Fill Entire Canvas

Inactive Part Background Color: ▼

Set the colors for the **Active Part Frame Color**, **Inactive Part Frame Color**, and **Part Name Text Color** using the choosers. You can choose from a group of common colors, or click **Other** to access more advanced color-setting options. Click **OK** when done.

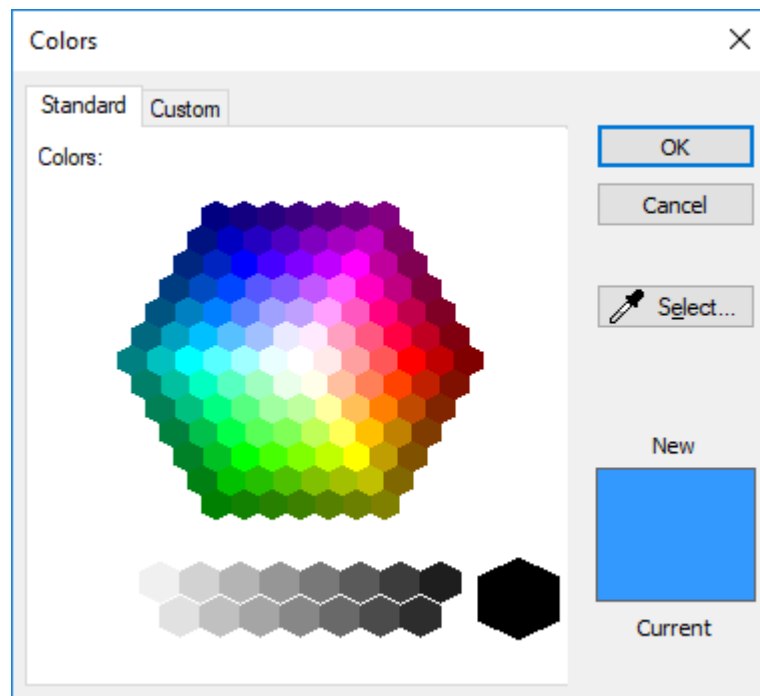

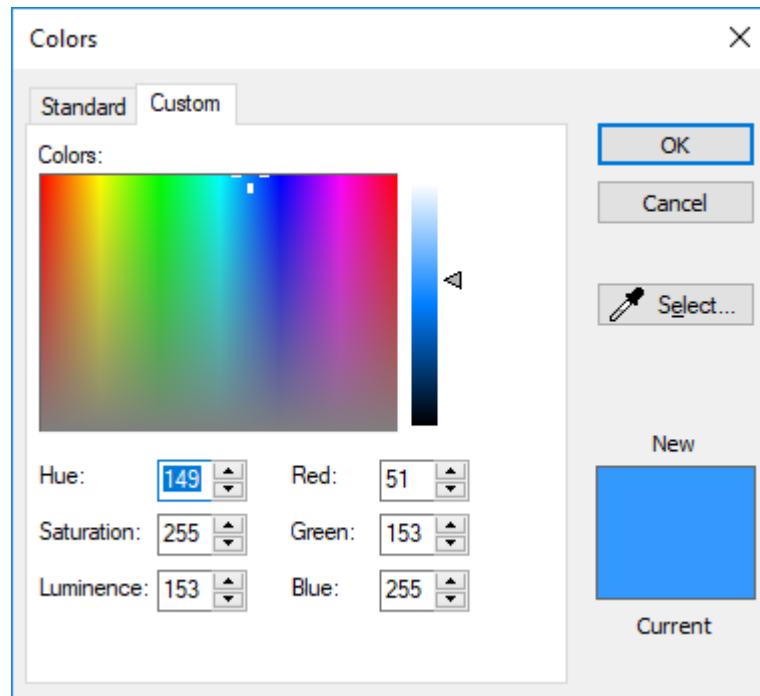

The options in the Part Frame Borders group control how ArtiosCAD shows part frame borders. **No Borders** displays no frame and just the name of the part in its title bar. **Corner Marks** places small angle brackets around each corner of the frame. **Full Frame Border** draws the entire frame around the part.

In the Inactive Part Background Fill group, choose how ArtiosCAD draws the screen behind inactive parts. **No Background Fill** keeps just the normal drawing area color behind inactive parts. When you choose this option, you may turn on **Show Corner Marks on Active Part when Frames are Turned Off** if desired. **Fill Inactive Parts** shades inactive parts with the color specified in **Inactive Part Background Color**. **Fill Entire Canvas** uses the Inactive Part Background Color to fill in the whole canvas except for the active part.

Note:

ArtiosCAD draws no frames, borders, or shading when in Isolation mode.

When you select a layout part in a job, the other layout parts in that job use the same active part frame highlight and border color.

The Production part frame highlight color is orange for production parts and gray for all other parts.

Canvas Layout Options

To set default options for canvas layouts, click **Startup defaults > Canvas Layout Options**.

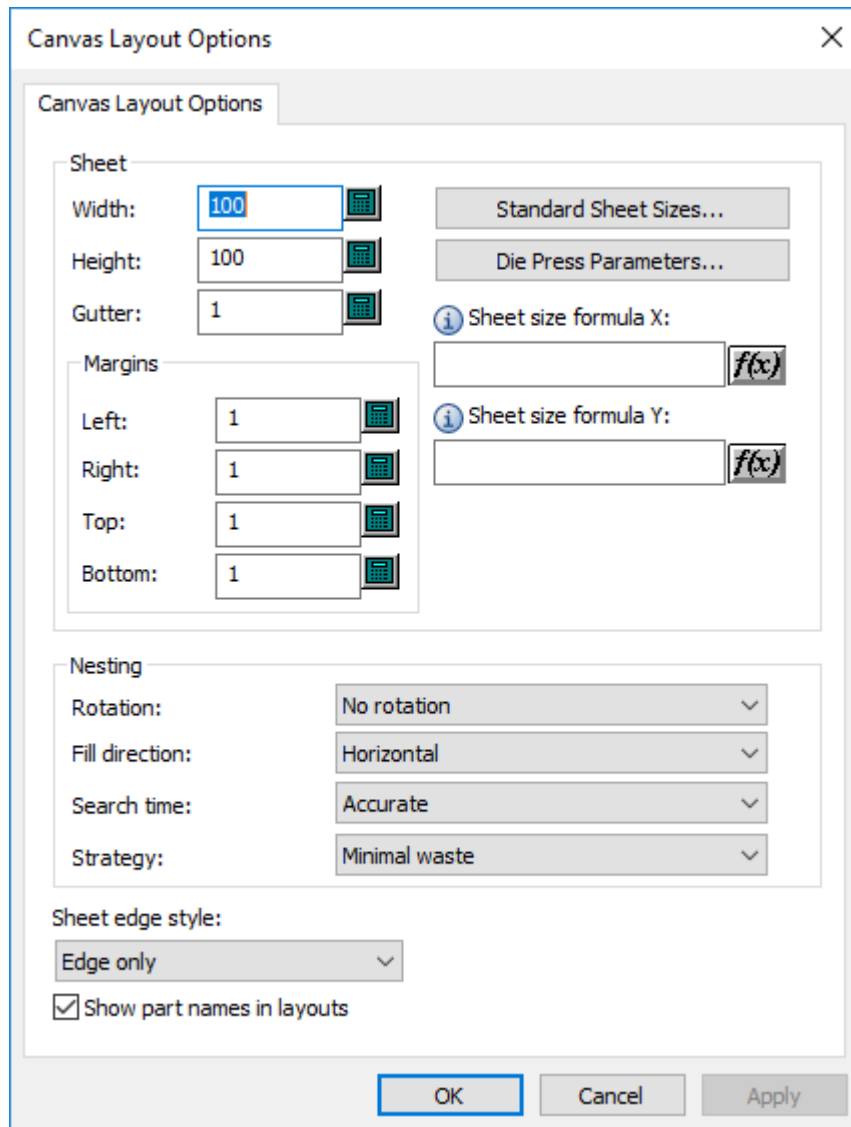

In the Sheet group, set the values for the sheet size, margins, gutter, nesting choices, and quantities. The width and height must be greater than zero. The gutter and margins must be greater than or equal to zero. Alternately, you can choose a standard sheet size or a die press by clicking **Standard Sheet Sizes** or **Die Press Parameters**, and use the values from those sources.

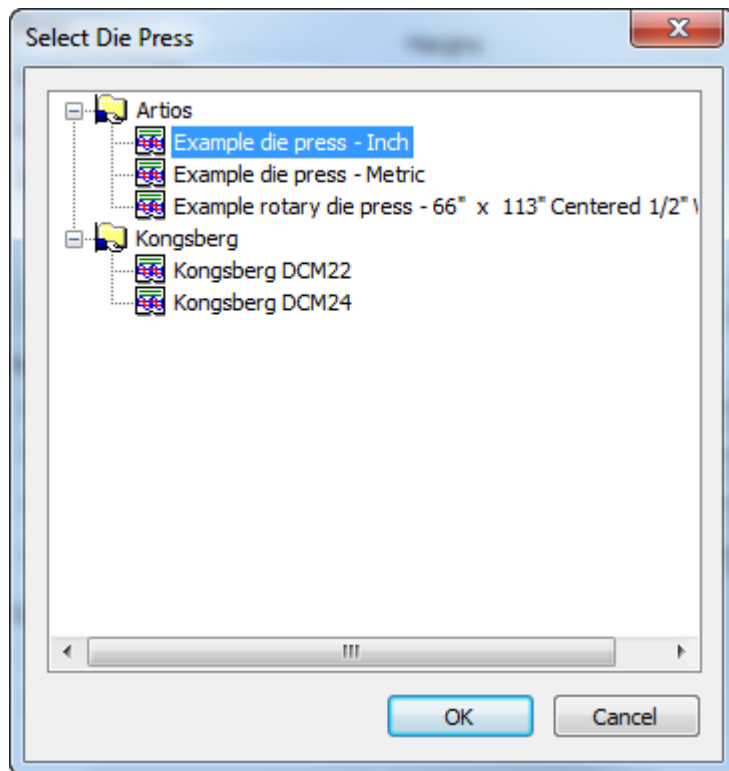
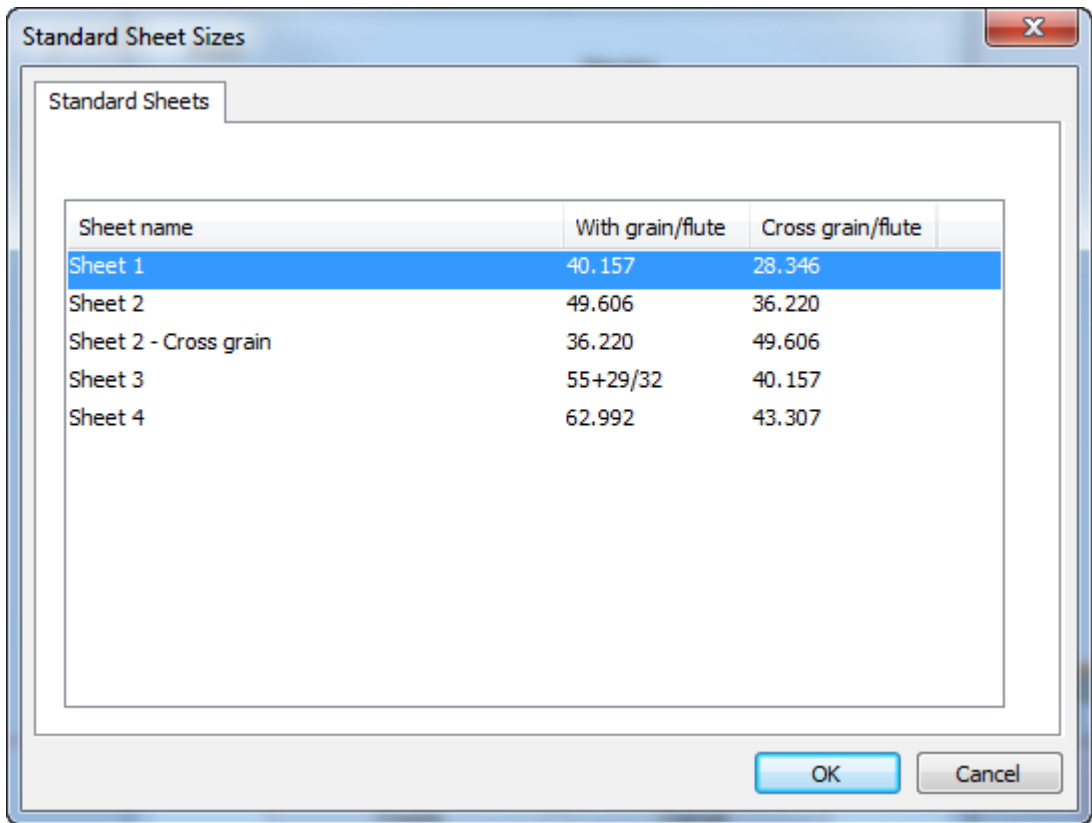

To use formulas to set the sheet size, enter them in **Sheet size formula X** and **Sheet size formula Y**. Hover over the information icon to display examples of suggested formulas and syntax. You may also use a library function.

In the Nesting group, set the options for computing the nest as desired. Rotation can be **No rotation**, **180 rotation**, **90 rotation** or **Any rotation**. This applies to all parts in the layout. Fill direction can be **Horizontal** or **Vertical**. This specifies the basic shape of the layout. If you set this to Horizontal, any unused space in the layout is horizontal. Search time can be **Very fast**, **Fast**, **Accurate**, or **Very accurate**. The faster the search, the less accurate the nest. For the strategy, **Minimal waste** creates the layout with the least amount of waste. **Minimal layout** creates the layout with the least overrun for the parts with a greater job quantity. **Priority by size** places the emphasis on making the closest number of larger parts to the job quantity.

Choose the **Sheet edge style** from the drop-down list. It can be **Edge only**, **Edge and margin**, **Edge and corner**, or **Corner only**.

Show part names in layouts controls if ArtiosCAD shows the names of parts in layouts or not. The default setting is enabled.

Tool Layer Options

The Tool Layer Options dialog box in Startup defaults controls how ArtiosCAD automatically switches in and out of layers in designs and canvases.

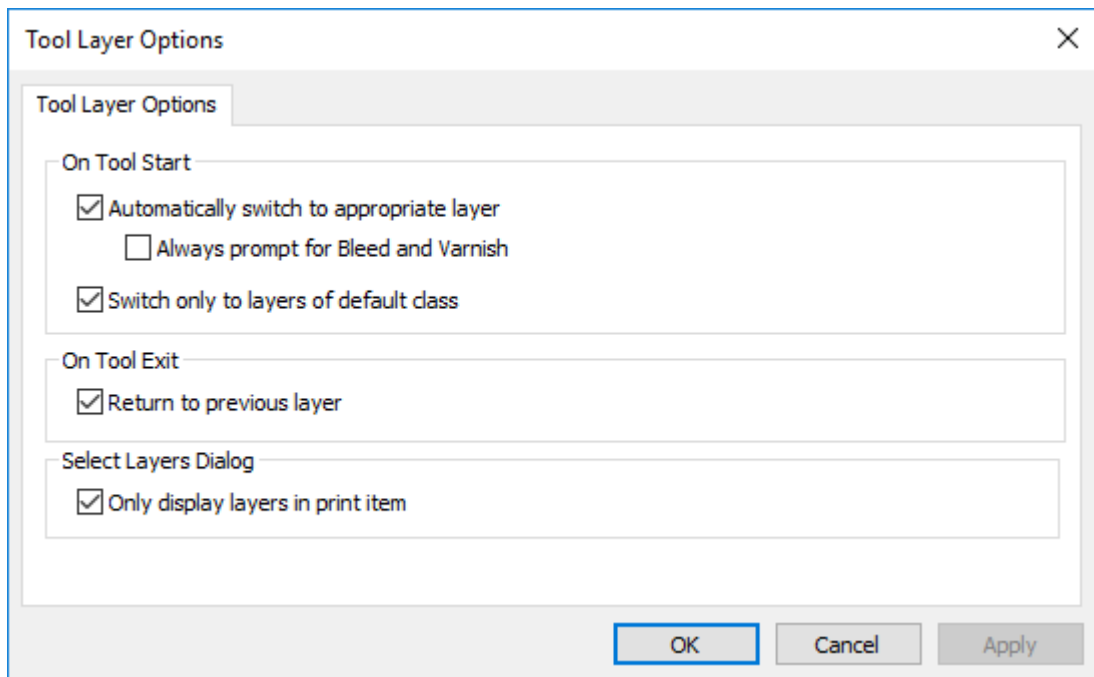

Automatically switch to appropriate layer turns this feature on and off.

Always prompt for Bleed and Varnish causes ArtiosCAD to always prompt for tools that would switch to those layers.

Switch only to layers of default class causes ArtiosCAD to only switch to layers whose classes match their names. For example, if this option were enabled and you had a layer

called Dimensions but it was class Windows and Cutouts, ArtiosCAD would not switch to that Dimensions layer automatically when you started a Dimensions tool.

Return to previous layer controls how ArtiosCAD behaves when you finish using the tool that changed layers and activate a different tool.

Only display layers in print item constrains the list of layers ArtiosCAD shows when listing valid layers to those in the current print item. If there is no print item defined, ArtiosCAD shows all layers.

Default Side for Geometry Macros

You can control if ArtiosCAD mirrors a geometry macro on placement with **Mirror the result if needed to match the design side** in its entry in the Geometry Macro catalog in Defaults. This option is not available for geometry macros used in Manufacturing.

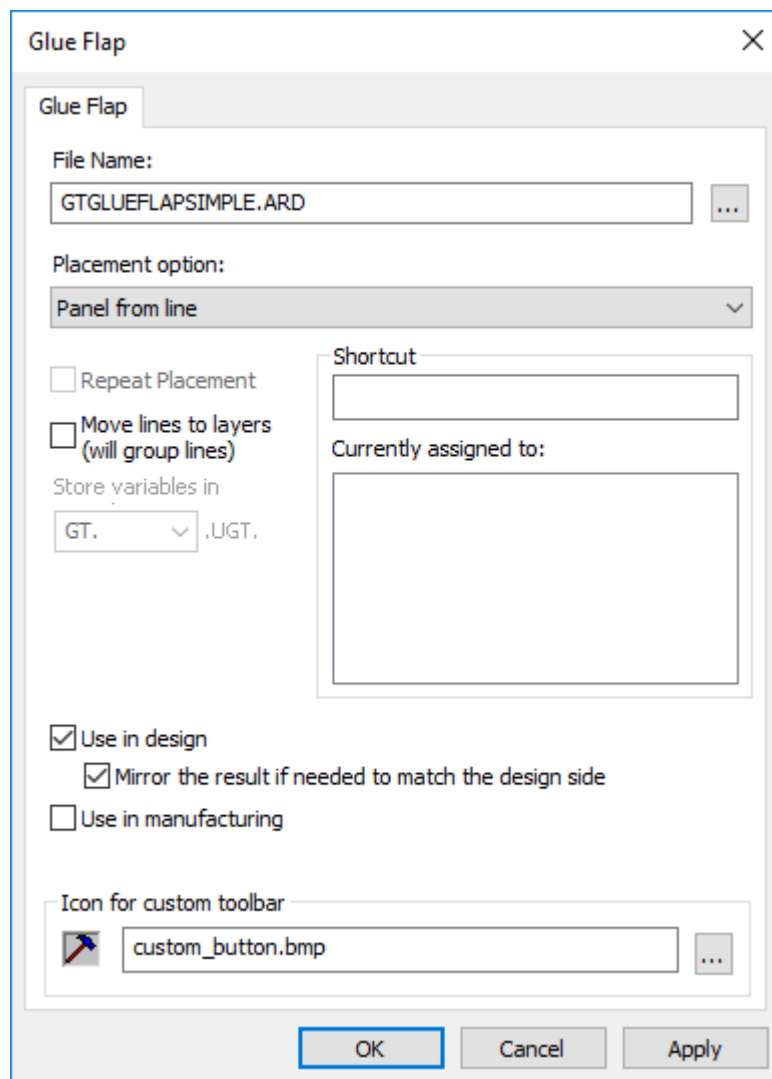

Rectangle from Line Options

In Startup defaults, the **Rectangle from Line** settings control if **Panel from Line** replaces the line you click with a crease line, and if so, what type of crease line.

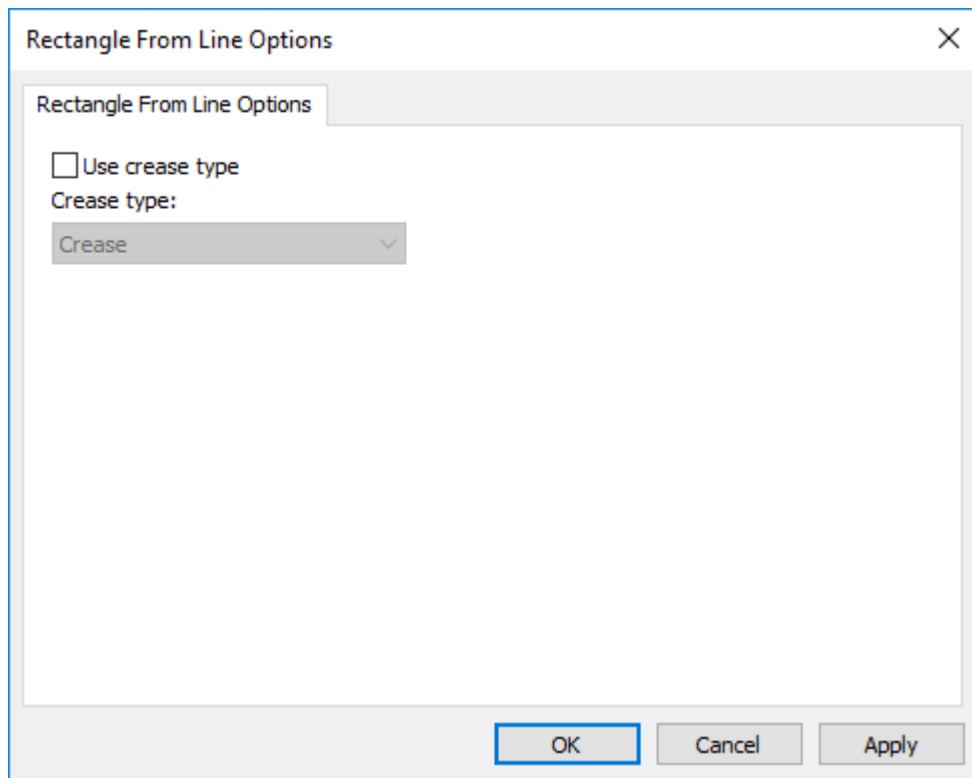

9. Getting started with ArtiosCAD

Welcome to ArtiosCAD

The fundamental purpose of ArtiosCAD is to turn your creative thoughts into business for your company. Speed, efficiency, and accuracy are all essential to providing the best product to your customers.

This book is intended for people with experience using the Microsoft Windows family of operating systems who are just starting to use ArtiosCAD.

For the latest information on system requirements, please go to the Esko website and search for system requirements.

Your system may not have all of the features described in this publication. Contact your Esko salesperson for information about purchasing features not installed on your system. Also refer to <http://www.esko.com> for more information.

You must have local administrative privileges to fully configure ArtiosCAD.

Changing the ArtiosCAD language

You can change the language of ArtiosCAD and its associated programs run in as desired.

This change affects all users on a computer.

1. Click **Esko > ArtiosCAD > Switch ArtiosCAD Language**.
2. In the ArtiosCAD Language Selection Tool dialog box, select the new language from the drop-down list box and click **OK**. Language names are always shown as they appear natively.

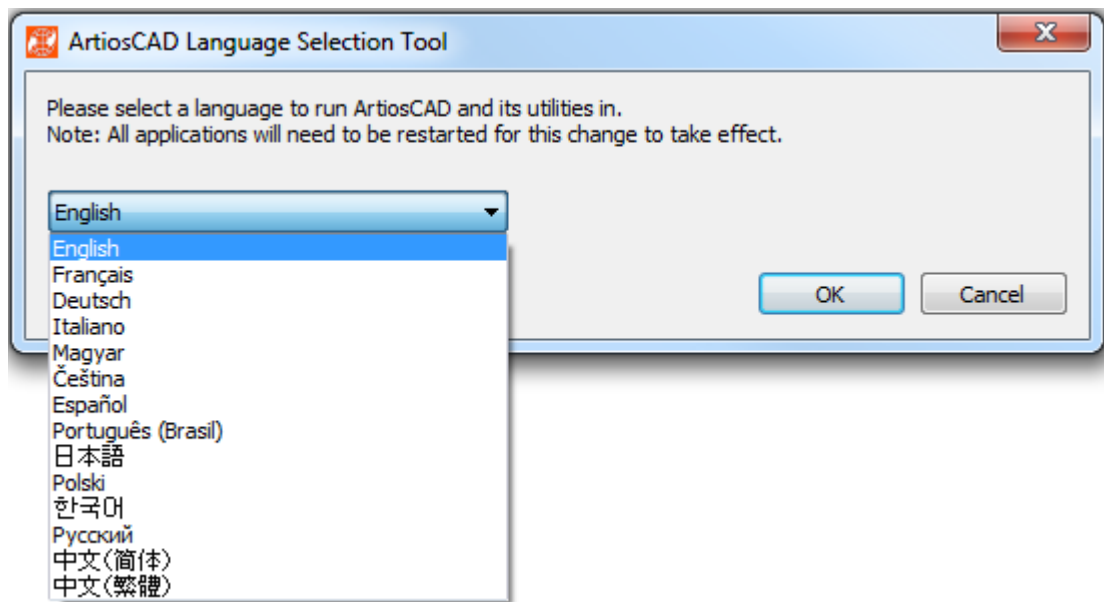

3. The language selection tool will change the name of the default shortcuts (the ones in the Start menu in the ArtiosCAD program folder and on the desktop) as appropriate.
4. Restart ArtiosCAD to run in the new language.

This tool changes the following:

- ArtiosCAD (both Standard Edition and Enterprise)
- DataCenter Admin
- Configure Floating Licenses (only changes the name)
- Migration Tools folder name
- ArtiosCAD Enterprise <Version> Migration
- Defaults Migration
- DWB DataLoader
- DWB Export
- Esko ArtiosCAD Database Export
- Esko ArtiosCAD Database Loader
- Esko ArtiosCAD Database Migration Export
- Esko ArtiosCAD Database Migration Import

Starting ArtiosCAD

To start ArtiosCAD, log on to your system if necessary and then do the following:

1. Click **Start**, then point to **All Programs**.
2. Point to the **Esko > ArtiosCAD** folder in the Start menu, and then click the version of ArtiosCAD you have installed.
3. If this is the first time you are starting ArtiosCAD after installing it, it will prompt you for licensing information. Please refer to the next section for more information.
4. The ArtiosCAD startup screen will appear.



5. The ArtiosCAD main window will replace the startup screen.

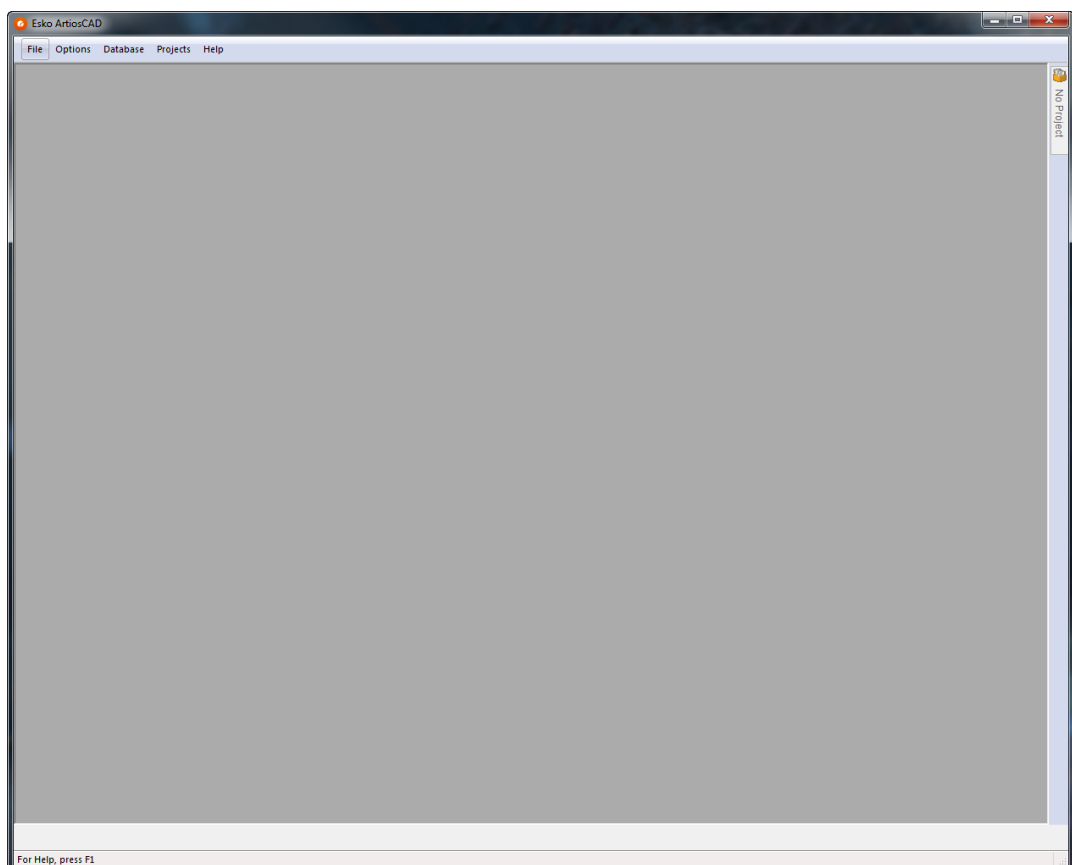

ArtiosCAD is now ready for use – you can create or open a single design, fold a design in three dimensions, create a set of manufacturing tools, set system defaults, or use database functions.

Entering Licensing Information

The first time you start ArtiosCAD, it will prompt you to enter licensing information before the splash screen appears for ArtiosCAD Standard Edition and after the login dialog box for ArtiosCAD Enterprise.

1. In the Welcome to ArtiosCAD dialog box, click the licensing method to use: **I received an HTML file with a Product Key, I know the name of my License Server, or I have an Esko ID to sign in and to use my Subscription.**

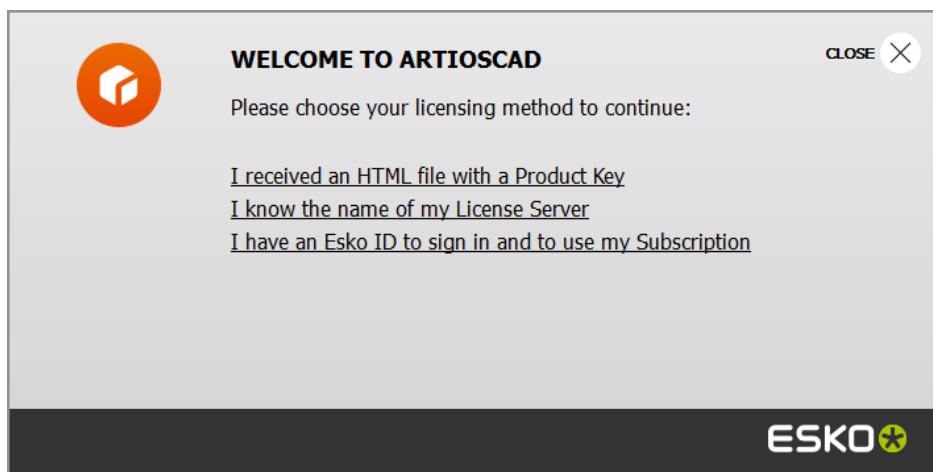

2. If you chose the HTML file with product key option, the normal Esko Activate Local License wizard starts. Proceed as instructed on the screen.

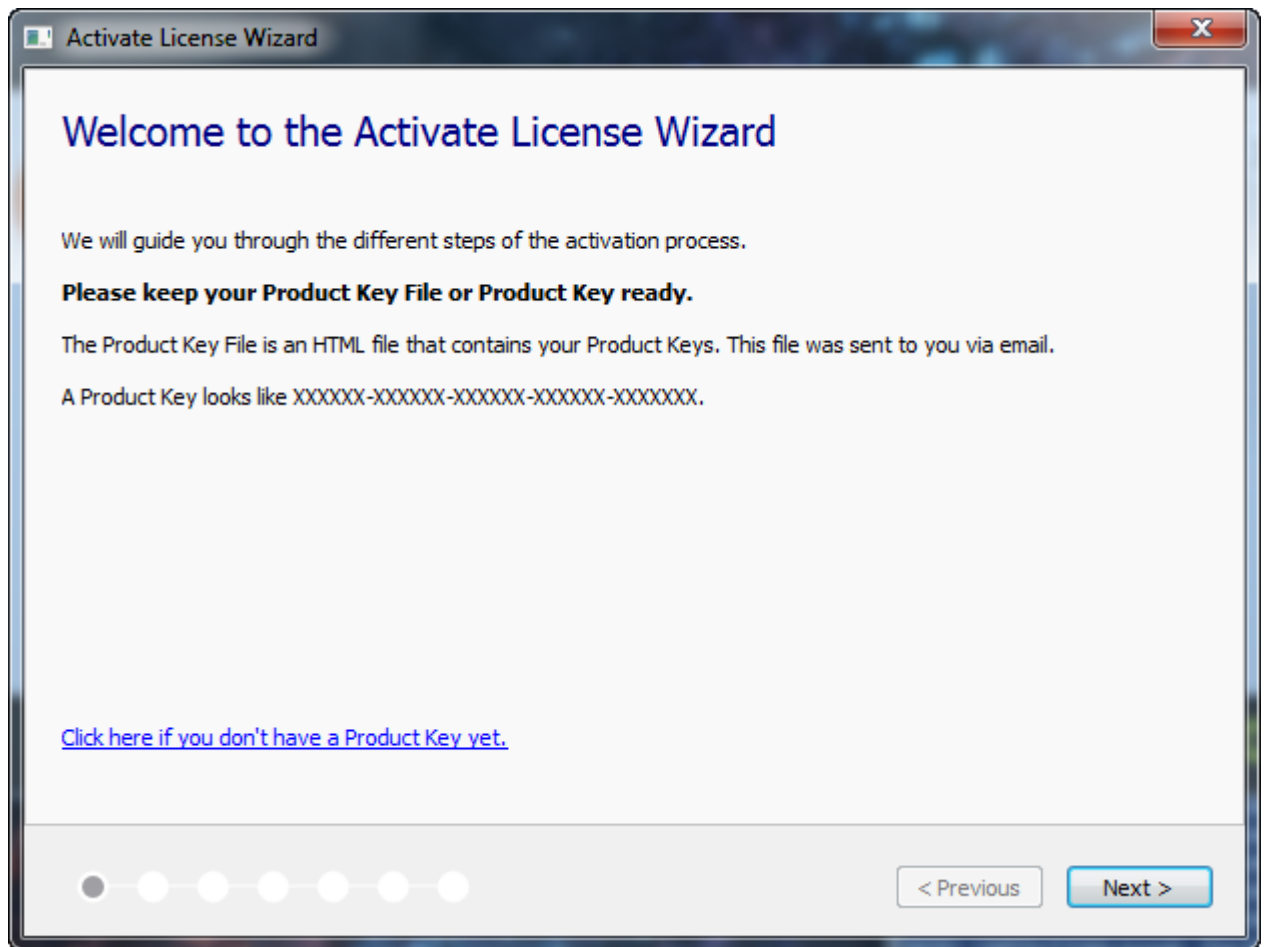

For more information, please refer to the Local License Manager documentation available at <http://www.esko.com/support>.

3. If you chose the license server option, enter the name of your license server and click **Connect**.

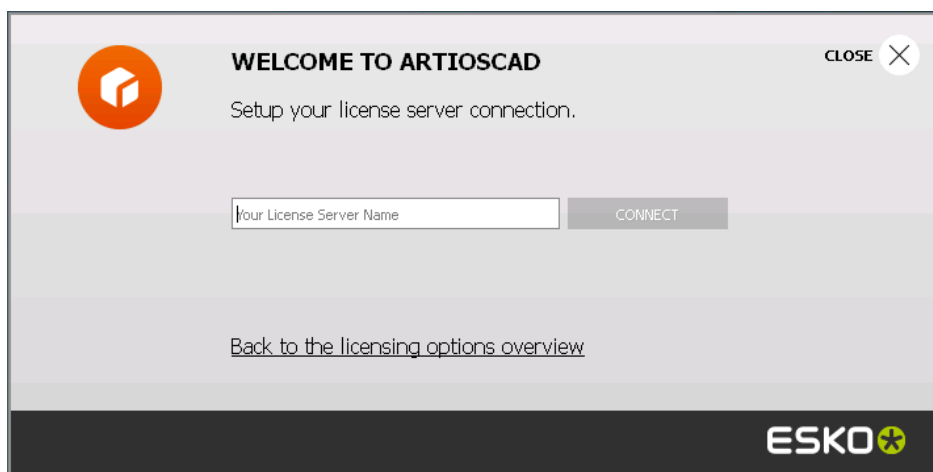

If all network licenses are in use, ArtiosCAD displays an error message. Click **Show licenses currently in use** to see a list of who is using a license so you can ask another user to release a license. For more information, please refer to the Network License Manager documentation available at <http://www.esko.com/support>.

4. If you chose the Esko ID and subscription option:
 - a) Enter your email address and password for your Esko ID and click **Sign In**.

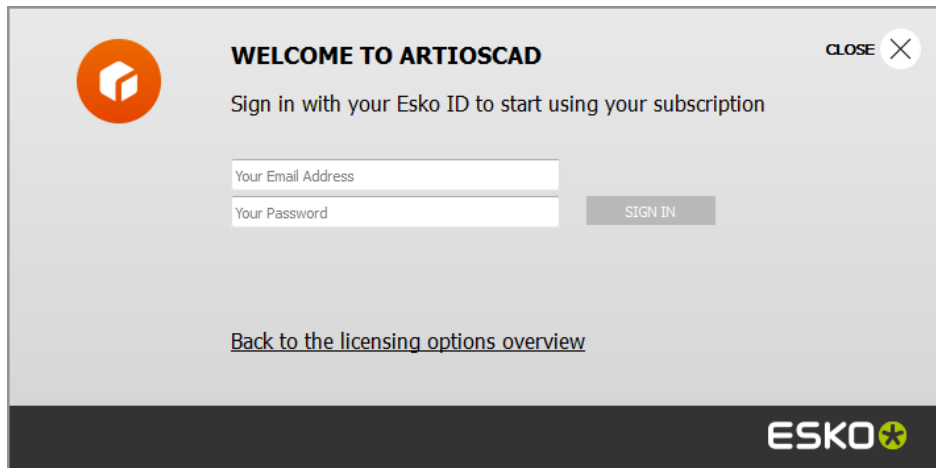

- b) Once the license is initialized successfully, click anywhere in the dialog box to continue starting ArtiosCAD.

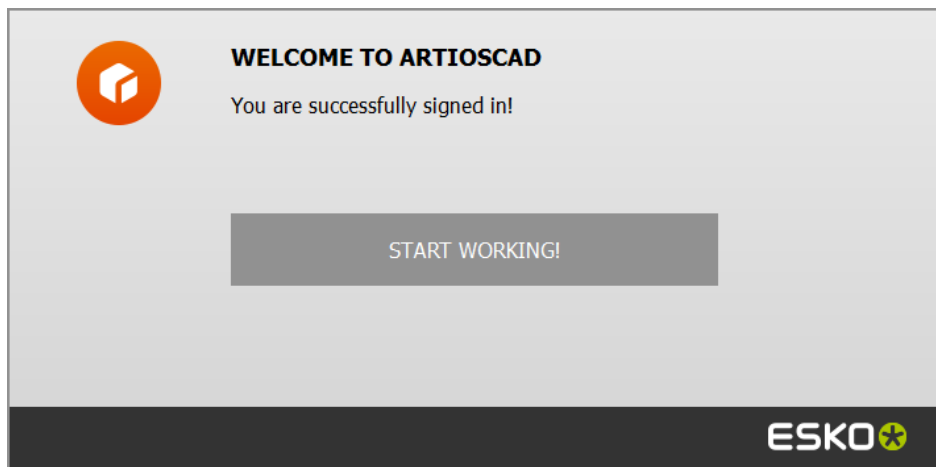

For more information, please refer to the Local License Manager documentation available at <http://www.esko.com/support>.

Changing the License Location

If you need to change the ArtiosCAD license location and your current license still works, close all documents and click **Help > License Location**.

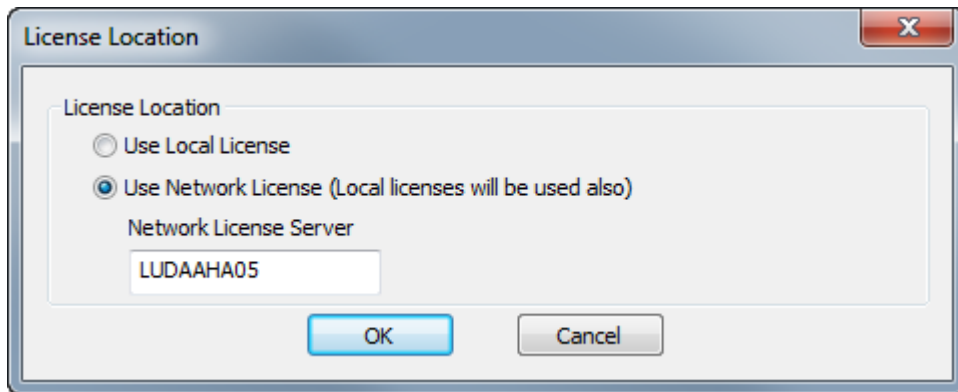

Choose **Use Local License** to use either a local or a subscription license.

Choose **Use Network License** to use a network license provided by a license server. ArtiosCAD will also use any available local or subscription licenses in addition to the network one.

Click **OK** to apply the change and return to ArtiosCAD.

If your current license no longer works, ArtiosCAD will prompt you to choose a license method when it starts.

Signing Out of Your Subscription

Note: You only need to sign out if you want to release your license. You do not need to sign out just to exit ArtiosCAD.

To sign out of your subscription license and quit ArtiosCAD, do the following:

1. Close all open ArtiosCAD documents.
2. Click **Help > Sign Out**.
3. In the ArtiosCAD Sign Out dialog box, click **Sign Out & Quit**.

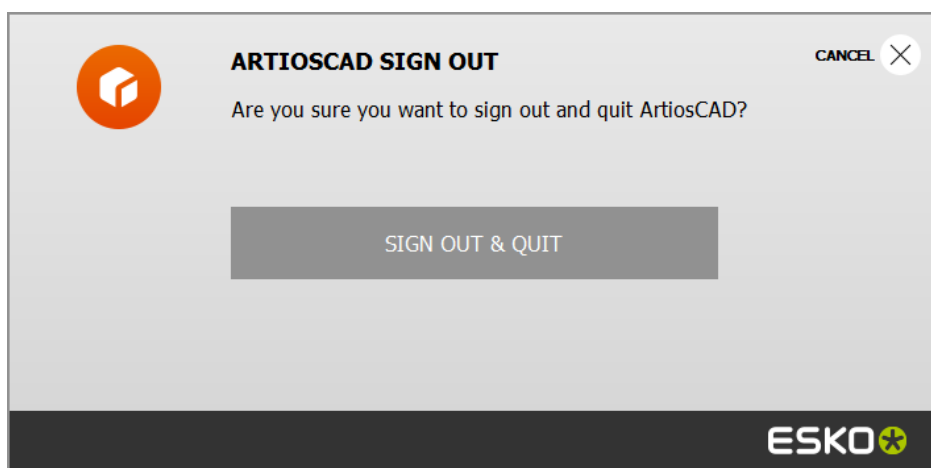

4. ArtiosCAD releases your subscription license and closes. The next time you start it, ArtiosCAD will prompt you for license information.

Using a Subscription License in Addition to Another License

To use a subscription license in addition to another local or network license, use **Sign in** on the Help menu of ArtiosCAD with no documents open.

To stop using it, close all open documents and click **Sign Out** on the Help menu, then click **Sign Out & Quit**.

Note:

A subscription license is considered a local license and will not work if you are using Remote Desktop or another terminal emulator.

Concepts and Ideas in ArtiosCAD

A typical workflow

The process of creating boxes, either folding carton or corrugated, is usually a logical progression. First you design the box and embellish it with graphics from your art department, from the customer, or graphics that you designed yourself. Then you print it on a desktop printer for review. At this point, you may export it to a different format for use by others. You could also fold the box in 3D to make sure all the dimensions work together. Sometimes a specification sheet of the folded design is created to send to the customer for approval. If approved, samples are made. If the samples work and are approved, manufacturing tools for the box are made. These manufacturing tools then are used in production of the box, and the box is shipped to the customer.

Tools

Work in ArtiosCAD is completed using tools found on toolbars. Select a tool by clicking it with the mouse cursor. The selected tool will prompt for information in the Status bar and guide you using graphical feedback (drag). The toolbar master controls determine which toolbars are visible.

Changing the view

The way a design is viewed in ArtiosCAD can be customized to show different information. The structural properties of the design remain the same throughout - only the presentation changes. Three elements control the display - the **Zoom** and **Pan** commands, the *View mode*, and the *plotting style*.

Zooming in and out

ArtiosCAD lets you view your design from different distances. This distance is set using the **Zoom** tools. You can zoom in on a particular area so that you can see minute tolerances, or you can zoom back so far that the design becomes a dot on the screen.

 Zooming in with the **Zoom Rectangle** tool means the design is displayed in more detail. Either click and drag a rectangle to indicate an area to zoom into, or click a coordinate to zoom in on that coordinate.

 Zooming out with the **Zoom Out** tool means the design is viewed in less detail.

 The **Center-Point Zoom** tool, when clicked, prompts you to click the center of an area to be zoomed in upon, and then to drag to the corner of that same area. Release the mouse button to perform the zoom.

If you zoom in on an imported Adobe Acrobat PDF graphic and you have purchased the PDF option, **High graphics mode** in the View Mode dialog box enables sharper resolution as you zoom in. High graphics mode is covered in depth later in this manual.

Scale to fit tools

 The **Scale to Fit** command on the View menu (and on the View toolbar) zooms in as close as possible without having any edge of the design outside of the window. This is especially useful when you are either zoomed way in or zoomed way out and want to see the complete design quickly.

When held down, it activates the Scale to Fit tools flyout toolbar.



 Click the **Scale to Fit with Border** tool to put a border around the scaled-to-fit view. The size of the border is configured in **Options > Defaults > Startup defaults > View Tools options**.

Pan/Zoom tool

 The **Pan/Zoom** tool lets you grab a location on the screen and drag it as desired in Pan mode, or zooms in and out according to the direction you drag (up or down) when in Zoom mode. To use it in Pan mode, click it, click and hold a location on the screen, and drag to the new location. Click the right mouse button or press ESC to exit the tool and return to the previous tool used. The cursor looks like a clenched hand while dragging.

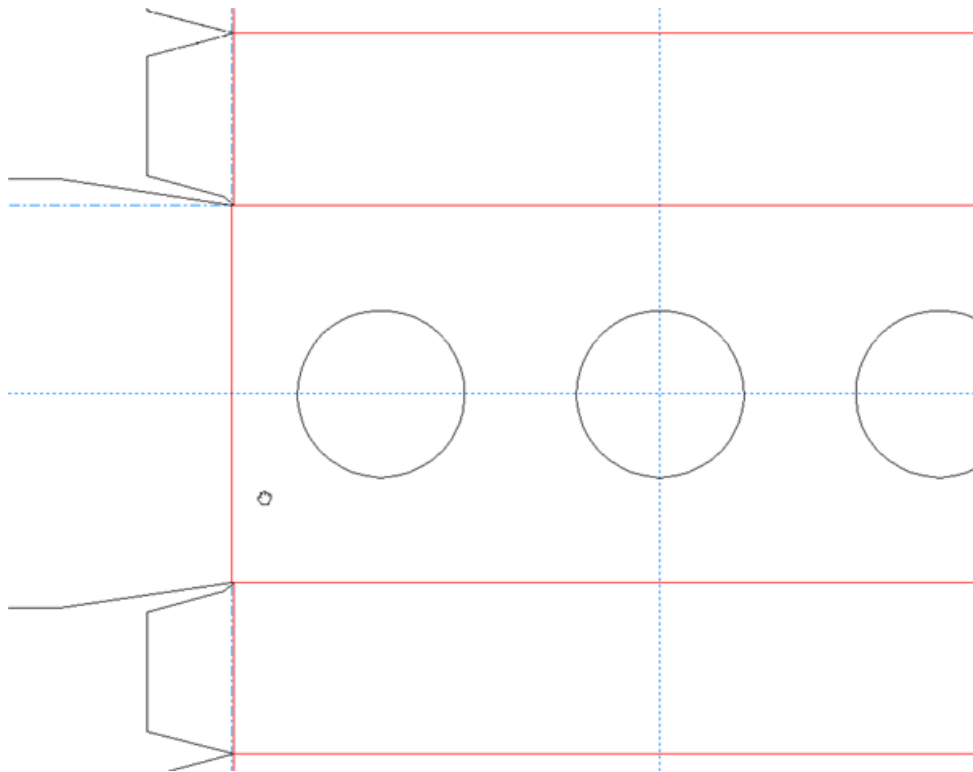

Note: If you use the Pan/Zoom tool in high graphics mode, you must refresh the screen by pressing F2 to re-render the graphics.

To use the Pan/Zoom tool in Zoom mode, click it, click **Zoom** on the Status bar, position the cursor in the desired area, and then drag the cursor up to zoom in or down to zoom out. Click the right mouse button or press ESC to exit the tool and return to the previous tool used. Shown below is a design in process of being zoomed in upon.

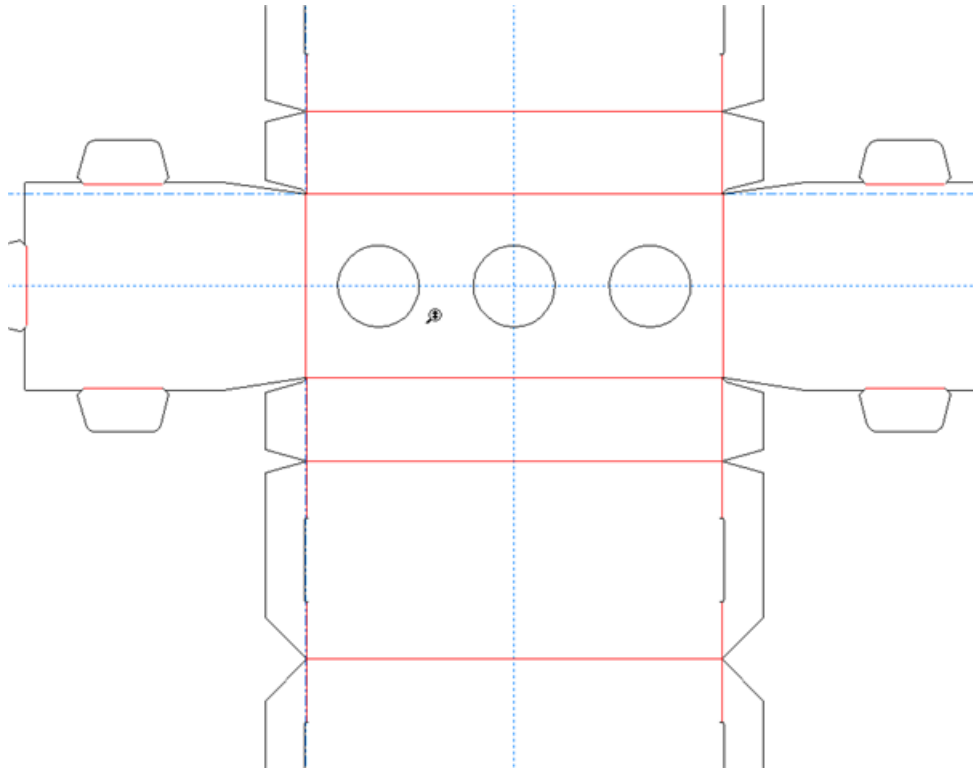

Press tab on the keyboard to change between Pan and Zoom modes without clicking their respective option buttons.

To exit the Pan/Zoom tool in either mode, either click the mouse button, press ESC on the keyboard, or activate another tool. The previously-used tool will resume operation.

If you have a three-button USB mouse with a scroll wheel, using the scroll wheel at any time zooms in or zooms out as if you were using the Pan/Zoom tool in Zoom mode. Holding the middle mouse button down and dragging the cursor pans the view as if you were using the Pan/Zoom tool in Pan mode.

The amount of zoom controlled by the scroll wheel is configured in **Options > Defaults > Startup defaults > View tools options**.

View mode



The **View mode** command on the View menu (and on the View toolbar) lets you choose the types of geometry and graphics ArtiosCAD displays.

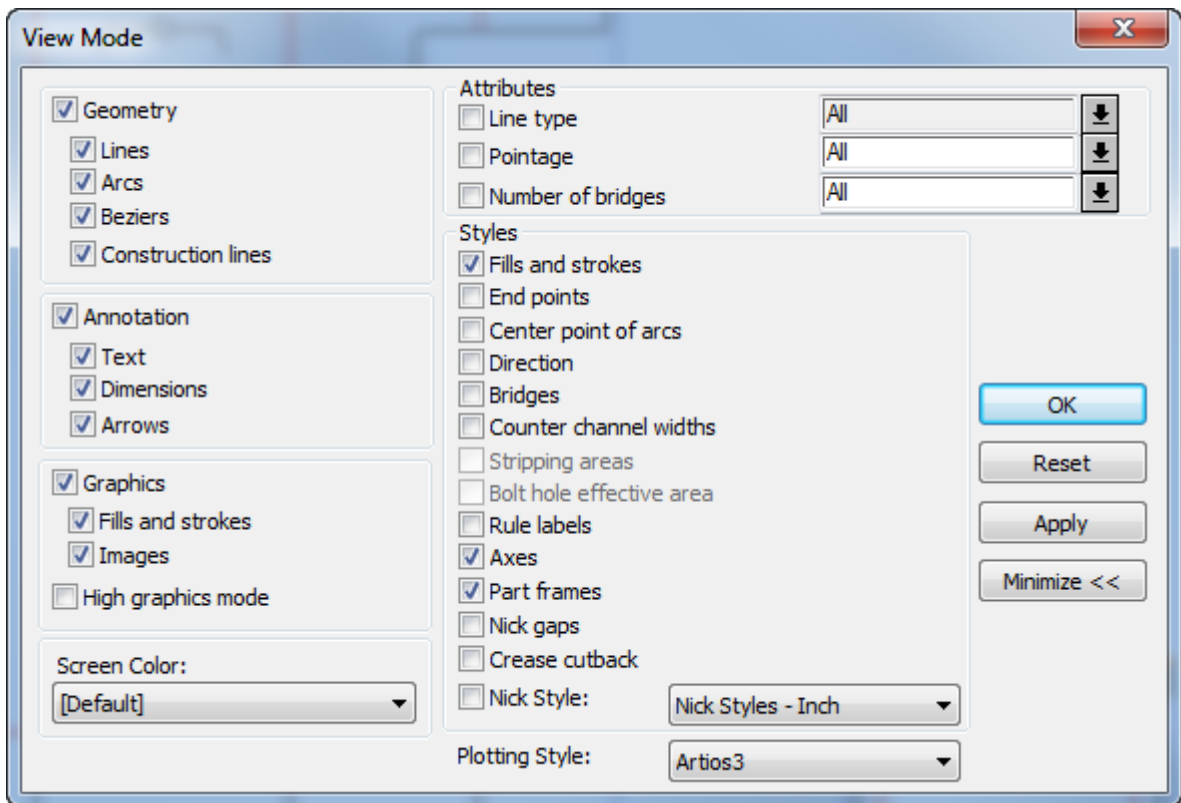

Check or clear the checkboxes as desired. Click the arrow at the end of the **Plotting Style** field to select a new plotting style from the drop-down list.

The arrows at the ends of the items in the **Attributes** group let you choose predefined values from a drop-down list. You can type your own values (or a range of values by typing **starting value .. ending value**) in the **Pointage** and **Number of bridges** fields but not in the **Line type** field.

Part frames only appear in canvases, so the control is available only when a canvas is open. There is also a toggle for them on the View bar above the Parts List, as well as being on the **View > View Options** menu.

Nick gaps are gaps in cut lines showing where nicks are positioned. **Crease cutbacks** are nicks at the ends of crease lines. ArtiosCAD cannot show bridges and nick gaps simultaneously, so when you turn **Bridges** on, ArtiosCAD turns off **Nick gaps** and **Crease cutback**. Conversely, turning on **Nick gaps** or **Crease Cutback** turns off **Bridges**. ArtiosCAD can show bridges and nick styles simultaneously. Crease cutbacks are at the top of the rule and bridges are at the bottom of the rule. If you turn both on, ArtiosCAD shows the original crease with no shortening.

The default view mode styles can be set by clicking **Options > Defaults > Design Defaults > Default View Mode**. The default screen color is set in the **Screen color** element of the Design Defaults catalog.

Plotting styles

Plotting styles control the display attributes of all objects on the screen. Using plotting styles, you can control the width, color, and pattern of design lines, and the tools a samplemaker or

other machine uses to cut, burn, or otherwise create the lines. The current plotting style can be changed in the View Mode menu, and plotting styles in general are configured in Defaults.

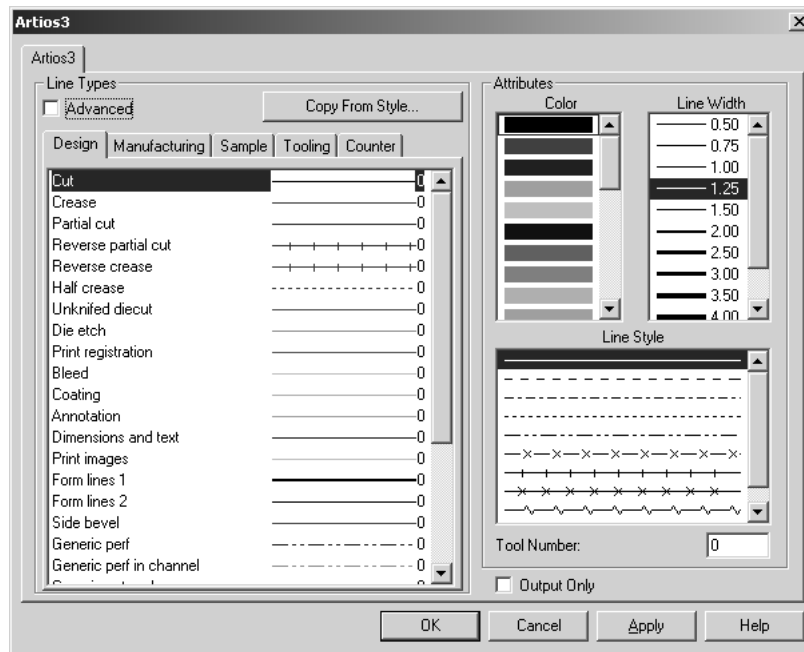

Construction lines

Construction lines are special guide lines used as drafting aids only. They aid in the construction of geometry that relies on points not in the actual design. Construction lines are not manufactured, and are not exported to different formats.

Layers

ArtiosCAD uses the concept of layers to build a complete design. Layers are used in single design and manufacturing. Think of a piece of paper with a drawing of a basic container. Then on top of that, add transparencies. One transparency could contain dimensions, another could contain art, and yet another could contain additional design geometry such as a window or an optional flap. A design may have up to 100 layers.

ArtiosCAD works with the layers that are turned on. Only layers that are visible are printed or exported to a file. However, all layers are saved when the design is saved regardless of their viewing status.

Properties

Most objects in ArtiosCAD have properties associated with them, such as line type, pointage, font, color, and so forth that can be changed by double-clicking the object(s) with the Select tool. This invokes the Properties dialog box. If more than one type of object is selected, for instance a line and some text, the Properties dialog box will have tabs across the top that allow

you to change the properties of each type of item selected. Close the dialog box to apply the changes to the properties.

Transformations

Transformations such as moving, copying, or rotating design elements are two-step processes. The first step is to select the item(s) to be transformed; selected items turn magenta. The second step is to select a tool on the Edit toolbar. The Edit tools (other than Select) are available only when something is selected.

Current position

The current position is the point in a workspace where creation tools start creating. When a new blank design is created, the current position defaults to the intersection of the construction line axes. When the first line is drawn from the current position, the current position then moves to the end of that line. Whatever is created next will begin at the end of the first line. Then when the second object is created, the current position will make the third object start from the end of the second object.

The current position can be moved by using the  **Move to Point** tool (CTRL-W) on the

Geometry Tools toolbar or  **Move By** (CTRL-Q) on the **Tools > Current Point** menu. **Move to Point** moves the current position to an established point. **Move by** prompts for an angle and offset at which to move the current position.

Entering information in ArtiosCAD

There are three ways to enter information in response to a prompt. The first way is to move the pointer until the desired value is displayed on the screen (called *drag*). The second way is to type information on the keyboard into fields on the Status bar. The third way is to use the keypad on the screen in conjunction with the mouse.

Using drag

Drag is a basic concept of ArtiosCAD. Drag is an image and numbers that appear when ArtiosCAD prompts for a physical dimension, such as specifying the angle at which to move an object. Moving the pointer changes this image and numbers. Drag can be tuned to use the increments you want in the Snap Options dialog box on the Options menu.

Freehand drag allows you to move objects by clicking and dragging them. By default, this behavior is enabled only for text, dimensions, and annotations; however, it can apply to lines, arcs, and beziers by clicking that option in the Snap dialog box in Options.

You must select a line, arc, or bezier by one of its endpoints in order to use it with freehand drag. This reduces the potential for accidental moves.

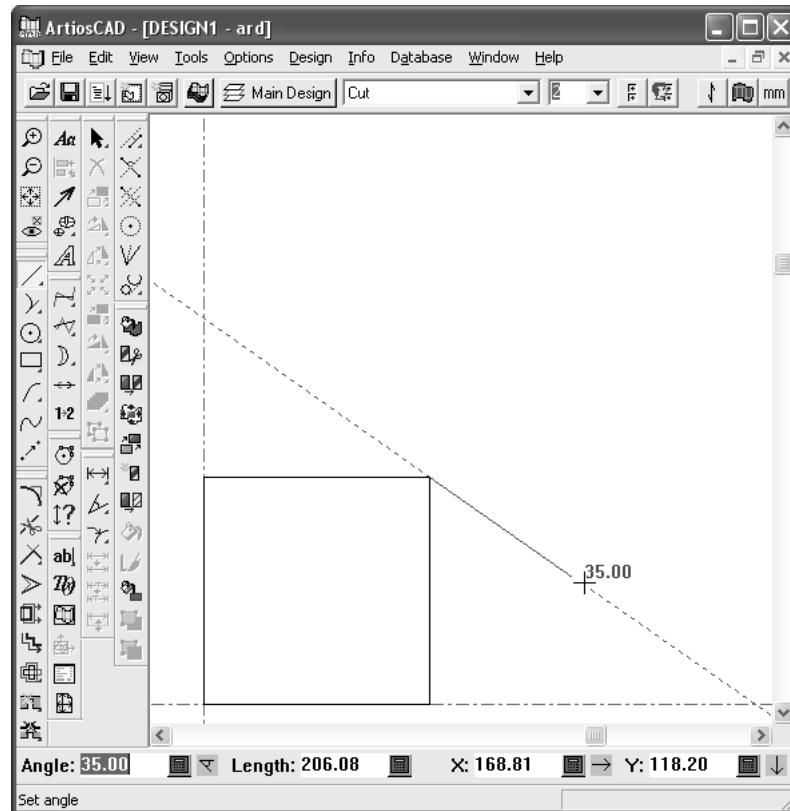

A small circle appears when you have created an object by aligning it with an established point (called snapping to a point). If the circle does not appear around the point you think you snapped to, then you did not snap to that point.

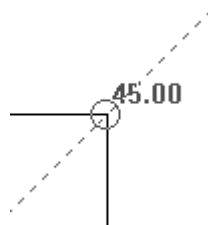

When using the following tools, holding down SHIFT while using drag to set an angle adds perpendicular and tangential angles to the snap.

- **Line Angle/Offset**
- **Line Horiz/Vert**
- **Line Angle/Length**
- **Arc Start Angle**
- **Arc End Point**
- **Straight Curve**
- **Curve Straight**
- **Conline Offset/Angle**

In the examples below, the end of the arc is the point against which the perpendicular and tangential angles are measured.

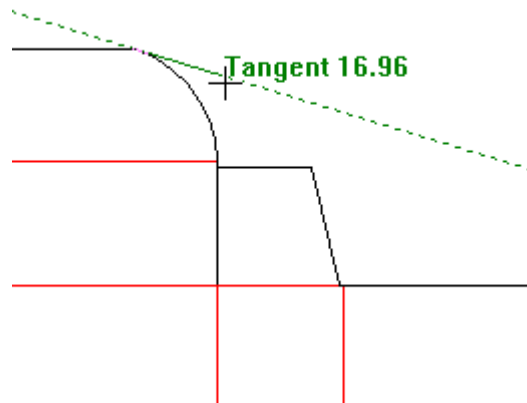
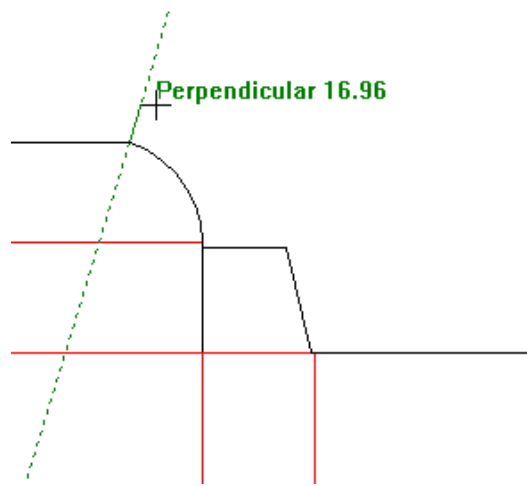

However, since the endpoint is shared, ArtiosCAD also shows the perpendicular and tangential angles for the line as shown below.

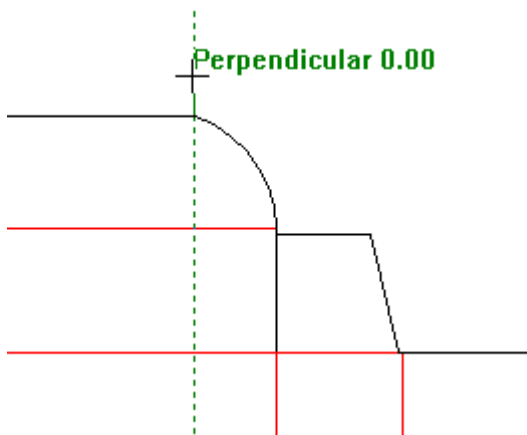

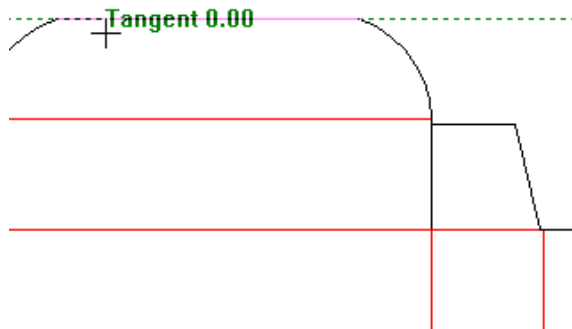

Dynamic Drafting overview

Dynamic Drafting enhances drag so that you get more feedback about aligning to points related to the cursor's location. As you move the cursor around with Dynamic Drafting enabled, ArtiosCAD displays horizontal and vertical alignment lines to points on the screen.

If ArtiosCAD can make an alignment with a point that satisfies the current prompt on the Status bar, it shows a solid line to that point. If it finds an alignment with a point but that alignment does not satisfy the current prompt on the Status bar, it shows a dotted line to that point. Shown below is setting the Angle prompt for a line using drag. Aligning with the midpoint of either the cut or crease line can satisfy the Angle prompt for the Line tool.

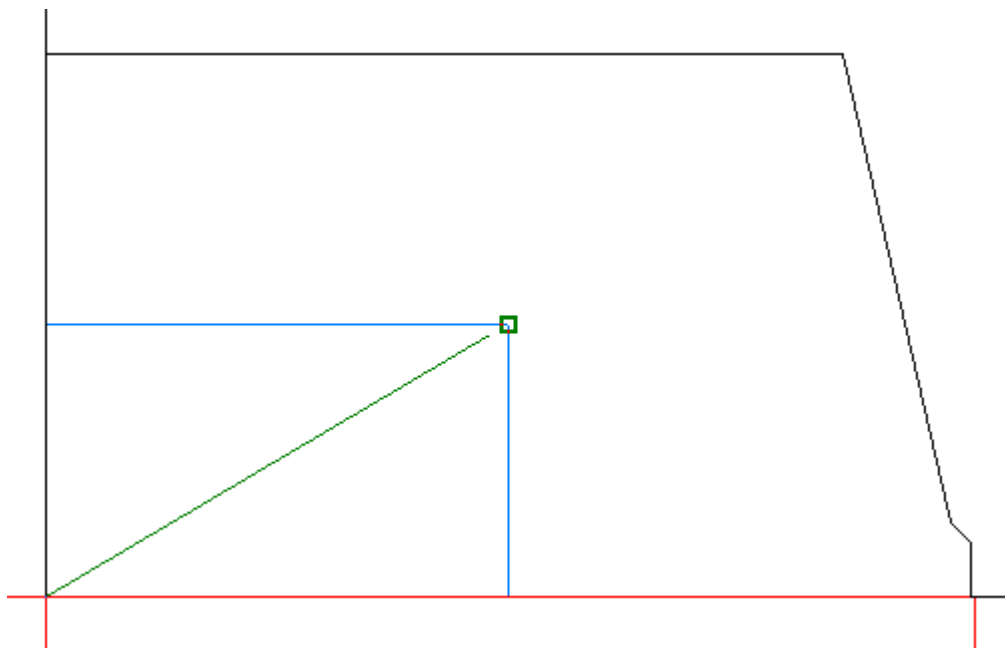

In the example above, ArtiosCAD displayed the alignment point (the green square) because the cursor was within the snap tolerance to that point.

In the example below, aligning to the midpoint of the line does not satisfy the Radius prompt of the Circle tool because the horizontal location of the proposed point is not aligned, so ArtiosCAD shows a dotted line.

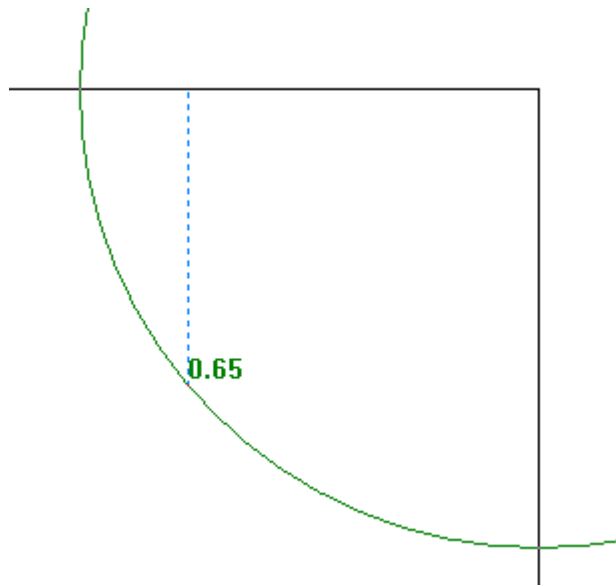

However, in the different example below, because Dynamic Drafting could align the Radius prompt of the Circle tool to the point defined by the midpoints of both lines, it shows an alignment point.



Dynamic Drafting:

- works with tools that accept points in Single Design only, not in 3D or Manufacturing
- is enabled by default.

If you have already set a value in a Status bar field, ArtiosCAD does not show alignments for those fields.

Dynamic Drafting also:

- works only with layers that are turned on
- ignores geometry that is completely outside of the current view
- ignores construction lines, file windows, and details

- ignores lines created by the Hatch tool
- chooses the point that is closest to the cursor if the cursor is within 1/4 the snap tolerance distance to multiple points.

There are some restrictions to using Dynamic Drafting:

- works even if **Use Drag Snap** is turned off in the Snap Options dialog box.
- works with the center points of arcs if **Center points of arcs** is turned on in the View mode, even if **Extend Points of Arcs** is turned off in the Snap options dialog box
- If **Extend Points of Arcs** is turned on in the Snap options dialog box, ArtiosCAD considers them even if they do not appear in the current view
- does not recognize intersections with beziers
- does not recognize points created purely by tool drag, such as bezier start and end points or drag for **Create Rectangle From Line**
- does not work with any of the tools on the Advanced Standards toolbar.

Note: if you have difficulty setting the prompts to a value because of ArtiosCAD's create-a-line-with-one-click behavior, press ENTER to set the value in the highlighted prompt, and press TAB to move between the prompts.

Turning dynamic drafting on and off

ArtiosCAD has four ways to turn dynamic drafting on and off:

1.  Click the toggle button on the View bar.
2. Press SHIFT-D. ArtiosCAD will update the toggle button on the View bar accordingly.
3. Click **Options > Snap** and select or deselect **Horizontal/Vertical Alignments** in the Dynamic Drafting group.

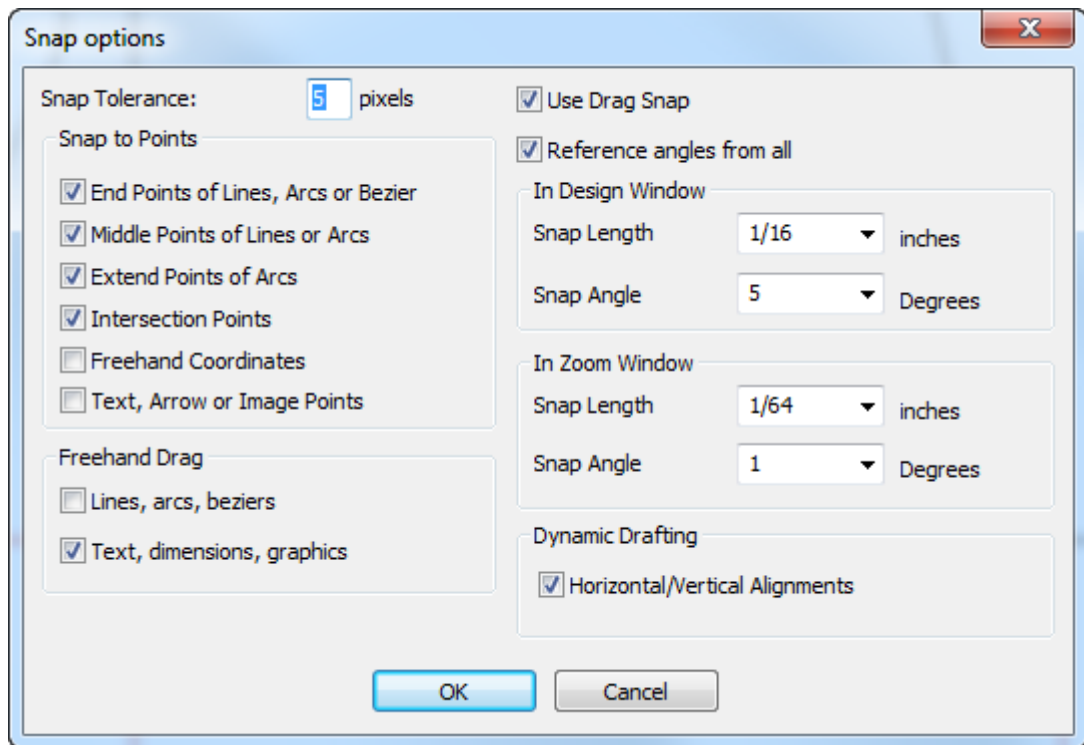

4. On the **View > Snap Options** menu, click **Dynamic Drafting**.

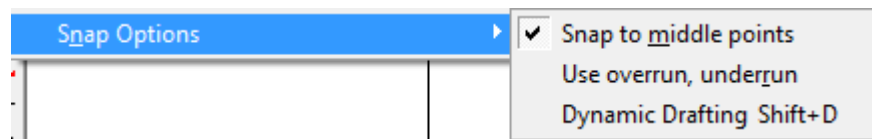

To turn Dynamic Drafting on or off permanently, click **Options > Defaults > Startup defaults > Snap options** and select or deselect **Horizontal/Vertical Alignments** in the Dynamic Drafting group.

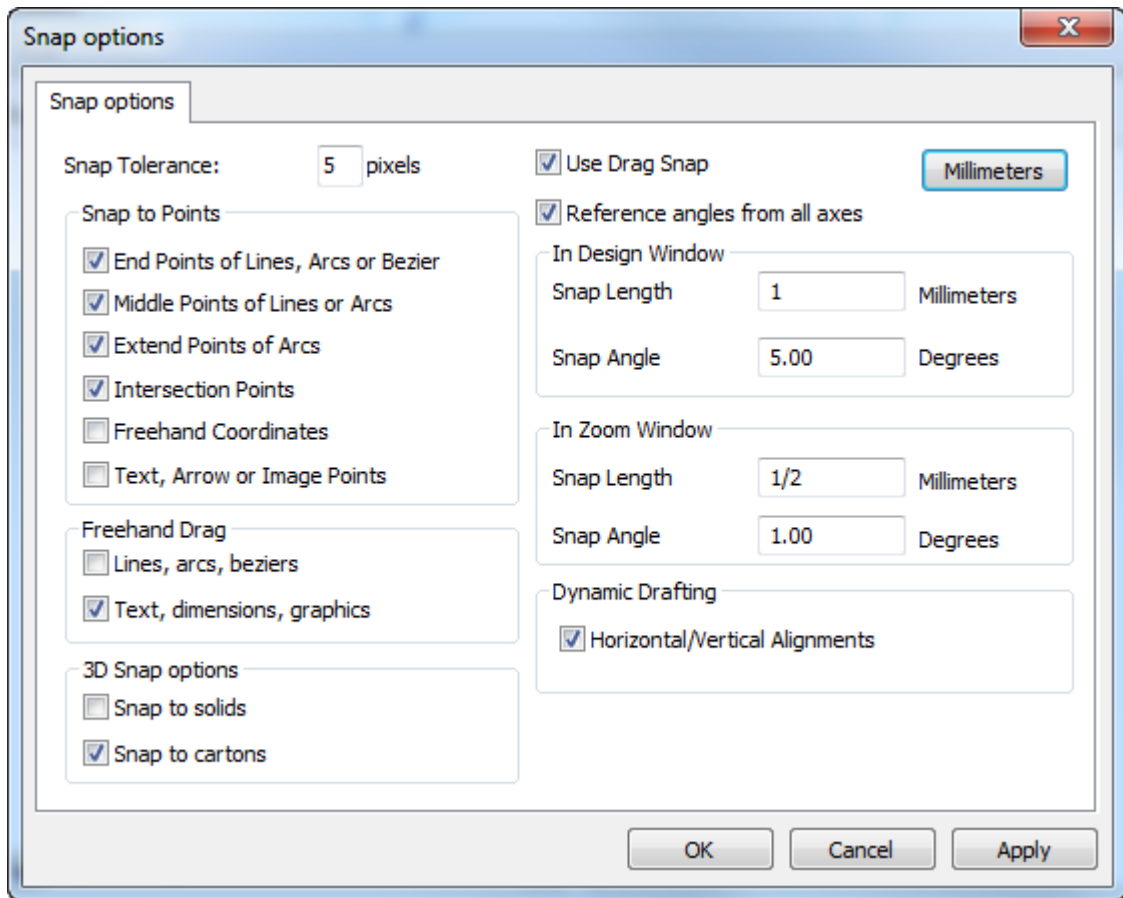

Keyboard Shortcuts in ArtiosCAD

You can press the keys in the Shortcut columns in the table below to perform the commands in the Function columns. Not all commands are available at all times; for example, if you have not cut or copied anything, you can not paste anything. You can change Shortcuts in Defaults.

Table: Keyboard Shortcuts

Function	Shortcut	Function	Shortcut
New Design	CTRL + N	Zoom Rectangle	CTRL + R
Run a Standard	CTRL + 2	Zoom Out	CTRL + A
Convert to 3D	CTRL + 3	CloseUp Window	CTRL + Space
New Layout	CTRL + L	Extend	ALT + X
Open	CTRL + O	Clear Extend	CTRL + ALT + X
Save	CTRL + S	Move to Point	CTRL + W

Function	Shortcut	Function	Shortcut
Print	CTRL + P	Move By	CTRL + Q
Undo	CTRL + Z	Line Angle/Offset	CTRL + 1
Redo	ALT + Z	Conline Offset/Angle	CTRL + F
Cut	CTRL + X	Keypad	CTRL + 4
Copy	CTRL + C	Rebuild	F5
Paste	CTRL + V	Measure Tool	CTRL + G
Select	CTRL + E	Copy Mode	CTRL + INSERT
Move	CTRL + M	Move Mode	CTRL + M
Properties	ALT + Enter	Split Line	CTRL + L
Refresh	F2	Toggle Dynamic Drafting	SHIFT + D
Scale to Fit	CTRL + D	Select All (in the Project Bar)	CTRL + A

Snap

Snap accommodates non-precision when selecting points. If you click close enough to a point, ArtiosCAD interprets your click as selecting that point, even if you are a few pixels off. The area around a point that you can click in and still select it is called **Snap Tolerance**.

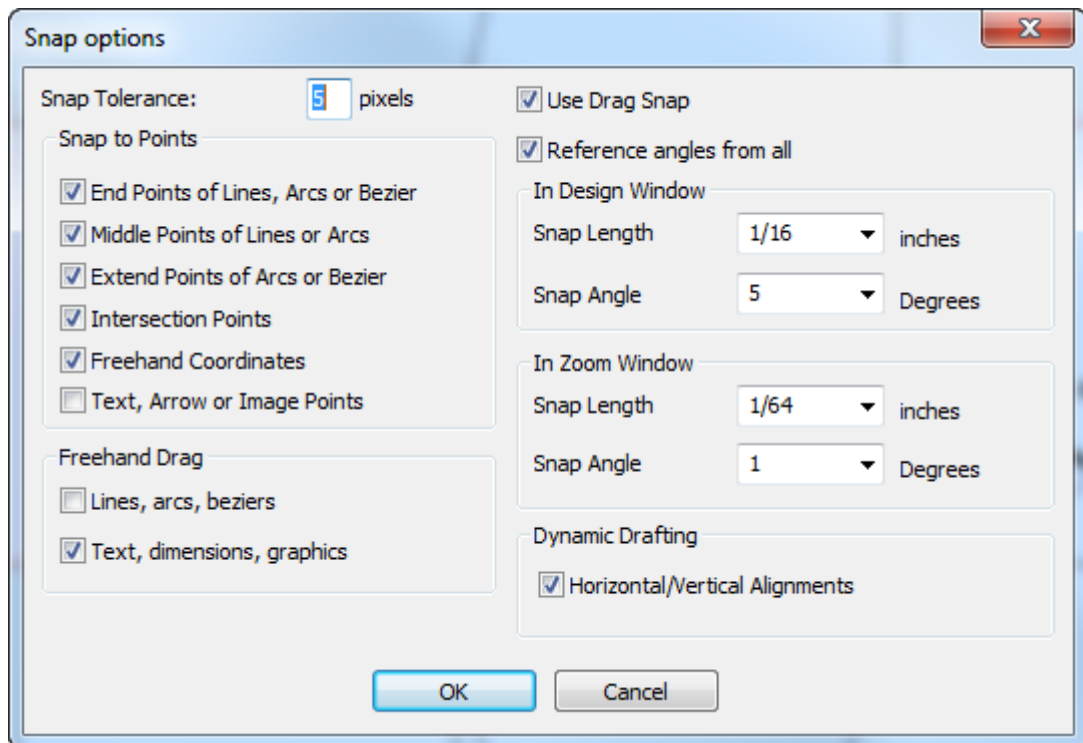

Some tools, such as the Bezier tool, require **Freehand Coordinates** to be turned on. If you try to click a point and **Cannot select coord** appears in the Status bar, make sure Freehand Coordinates is turned on.

If **Middle Points of Lines and Arcs** is enabled, once you are within the snap tolerance of a line or arc, the endpoints and midpoint appear.

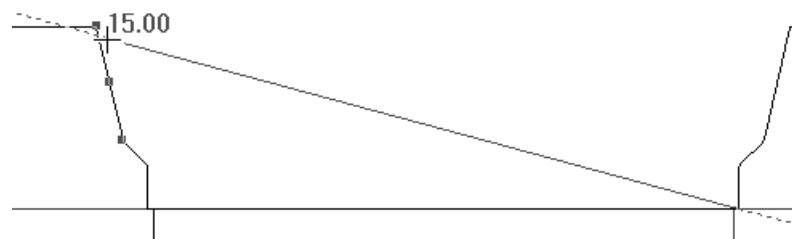

Highlighting appears around such a point when the cursor is over it.

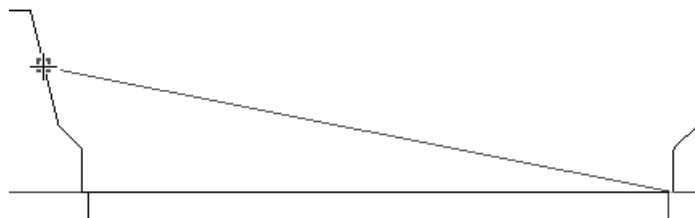

Extend Points of Arcs or Bezier causes blue squares to appear around center, corner, and quadrant points of arcs, and green squares to highlight the start, end, and midpoints of arcs. Blue squares also appear for the center and quadrant points of a circle. Green squares indicate the ends of beziers while blue squares indicate their extents. When this checkbox is cleared,

only the start, end, and midpoints of arcs appear. Zoom in on small geometry, else you will see overlapping squares. There are no snap points on construction line circles.

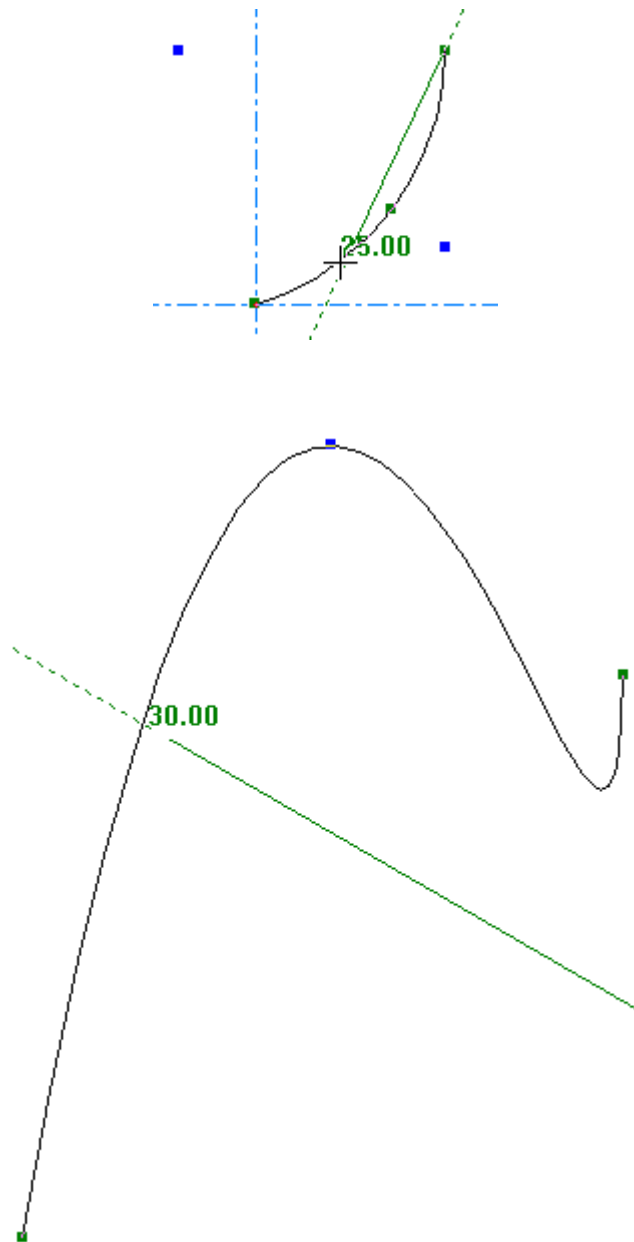

Text, Arrow or Image Points lets you snap to the edge and center points of those objects. Shown below is snapping to the top center handle point of a piece of text.



On the View menu, the **Snap Options** submenu lets you quickly turn on snapping to middle points, using overrun/underrun, and Dynamic Drafting. You can also assign these to shortcuts if desired.



Overrun/Underrun

Also on the **View > Snap Options** menu is **Use overrun, underrun** which extends, shortens, or does both to every line by a set amount and is configured in **Options > Over/Underrun**.

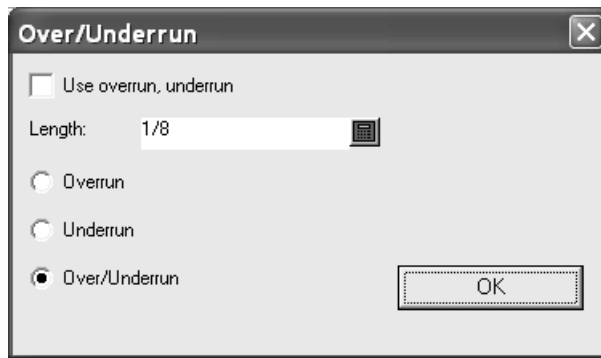

Design window elements

The ArtiosCAD Design window contains four functional areas:

1. The menu bar, the view bar, and the toolbar master controls
2. The toolbars
3. The status bar
4. The drawing area
5. The Project bar (shown collapsed)

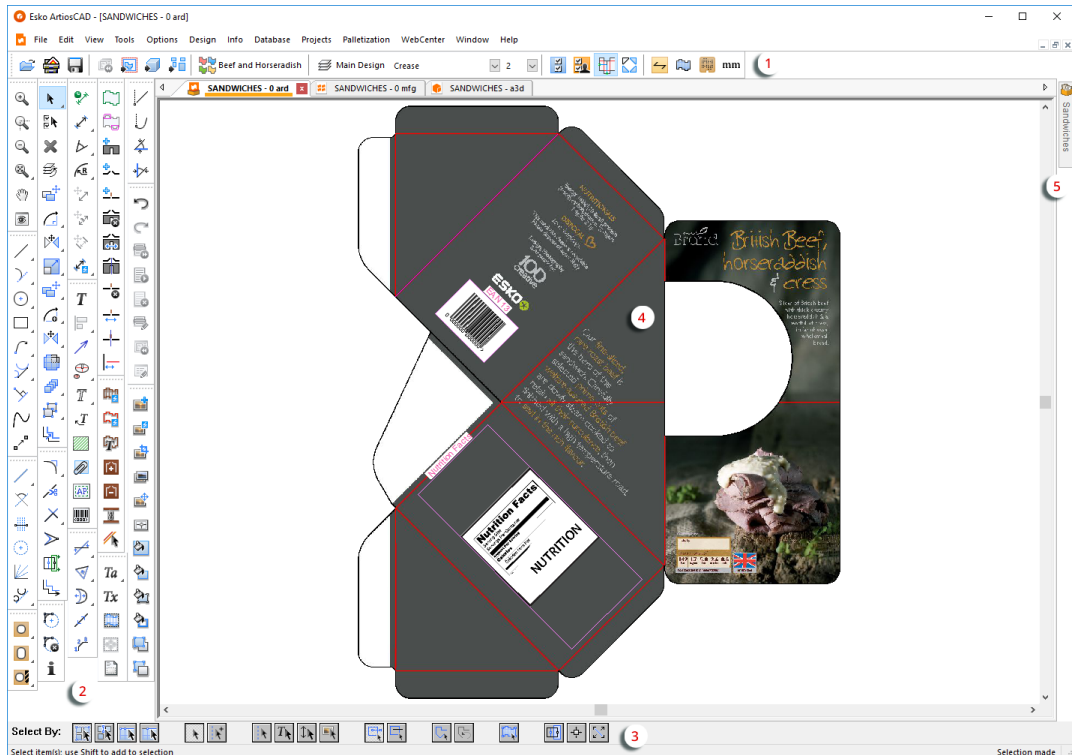

The menu bar, view bar, and toolbars all control the action in the drawing area. The status bar displays information about the tool being used, and if applicable, prompts for specific information.

You can reposition the View bar and toolbars as desired by clicking and dragging their handles. They can all float or be docked as you prefer. To make a toolbar float, click its handle and drag it out of the window. To dock it again, drag it back into the window and stick it to one of the window edges.

The menu bar

The menu bar contains commands available in the current module. Not all commands on all menus may be available; availability depends on the options purchased and the active tool.

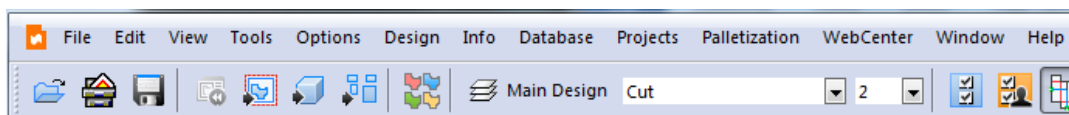

The View bar

The View bar provides one-click access to commonly used features.

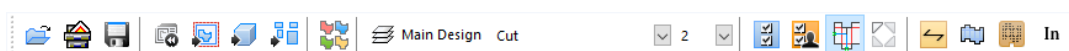

Each button on the View bar displays a ToolTip if the pointer hovers over it for a few seconds.

In the first group of controls on the View bar, the first button opens the Open dialog box. The second button opens the Design browser. The third button saves the current design.

In the second group, the first button rebuilds the current design. The second converts the current design to a Manufacturing file. The third button converts the current design to a 3D file. The fourth button converts a single design to a canvas.

The button in the third group creates a print item.

The first button in the fourth group adds, deletes, and modifies layers.



The next group of controls on the View bar controls line type and pointage. They are described in the next section.



The fifth group of buttons on the View bar are the toolbar master control buttons. They are described after line types. After them comes the Dynamic Drafting mode toggle and the Show Auto-Repeat Areas toggle, which are described in the Designer chapter.



In the sixth group of buttons on the View bar, the first button displays the Structural Orientation dialog box.

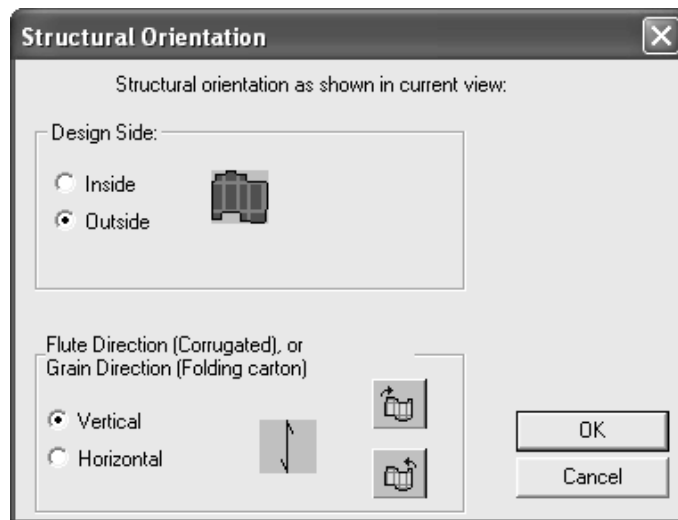



The **Inside** and **Outside** option buttons in the **Design Side** group show the current side up of the design. Change which side is up by choosing the other option button and clicking **OK** to perform the change.

In the **Flute Direction/Grain Direction** group, the **Vertical** and **Horizontal** option buttons show the current fiber orientation. Change the current direction by choosing the other option button and clicking **OK** to perform the change.

The two buttons labeled with a carton and an arrow change the physical orientation of the current design. Clicking the top button rotates the design 90 degrees to the right and changes the grain/corrugation direction. Clicking the bottom button rotates the design 90 degrees to the left and changes the grain/corrugation direction. Clicking **OK** accepts these changes; clicking **Cancel** undoes them.

 The second button displays the current side up (printed or unprinted), and changes it when clicked.

  The third button toggles between Die Back side or Die Knife side. This is most useful when designing for thick boards with V-notch cuts and creases. For Die Back side, ArtiosCAD cuts the design as viewed from the top as viewed from the current side. For Die Knife side, ArtiosCAD cuts the design from underneath as viewed from the current side. This setting is synchronized with 3D, but it is not synchronized with Manufacturing as that setting is controlled by the manufacturing parameter set. In a canvas, it applies to the active part, not the entire canvas.

mm The fourth button displays the units of the current design - In for imperial format and mm for metric format.

Changing the line type and pointage

The fifth group of controls on the View bar controls the line type and pointage. With nothing selected, they show the line type and pointage used to create new lines. If any lines are selected and the controls are changed, the lines change accordingly. If lines of differing attributes are selected, the respective drop-down list boxes are empty. If nothing is selected and these controls are changed, then any lines made from that point forward will reflect the changes made in the controls.

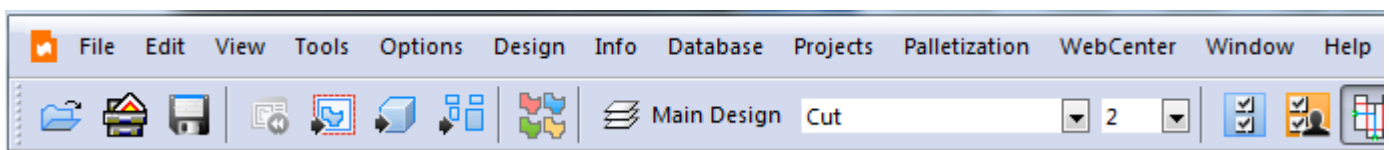

Each control is a drop-down list box. The **Line Type** drop-down list box displays all line types currently in the workspace and an **Others** entry which opens the Set Current Line Type dialog box when clicked.

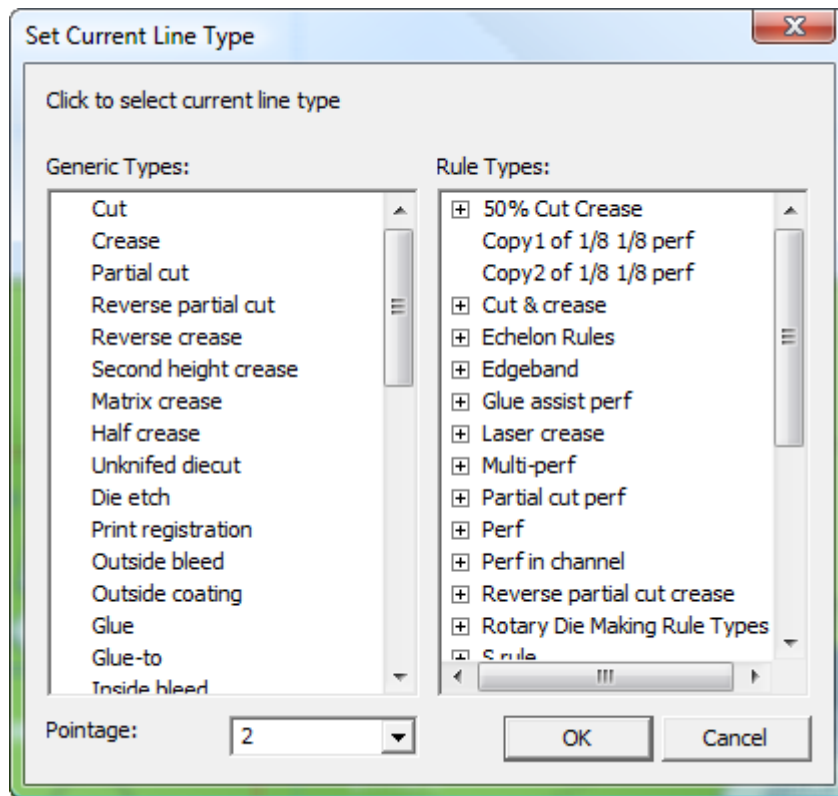

Select the type of line to create and click **OK** to continue.

When selecting special rules to use for manufacturing, make sure to select the special rule from the **Rule Types** group, and not the **Generic Types** group. If you select a special rule type, the special rule type will use its default pointage and the Pointage drop-down list box will be disabled.

The **Pointage** drop down list box displays a list of the most commonly-used pointages.

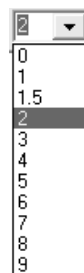

Select the new pointage from the list. It will affect new lines created that are of a generic line type.

When you change the line type and then make a line, ArtiosCAD checks to make sure that the line type is appropriate for the current layer. Listed below is a list of line types and their appropriate layers.

Table: Line types and appropriate layers

Line type	Appropriate layer classes
Annotation, print image, dimensions and text, form windows, construction lines, Tooling line types	Any (no warning)
Tear	3D Assist
Print registration	Print registration, Horizontal cross section
Outside bleed	Outside bleed
Inside bleed	Inside bleed
Outside coating	Outside coating (1-3)
Inside coating	Inside coating
Cut	Main, Manufacturing, Windows and cutouts, Horizontal cross section
Crease, Glue assist	Main, Manufacturing, Windows and cutouts
Side bevel, generic perf, all special and generic rules	Main, Manufacturing, Windows and cutouts
Unknifed diecut, Die etch, Die registration hole, Laser position hole, Die bolt holes	Main, Manufacturing, Windows and cutouts
Counter line types	Counter
Stripping boards, other manufacturing	Main, Manufacturing
Dynamic Art	Dynamic Art
Copy area, Copy free	Artwork Panels

The default line types for layer classes are listed below.

Table: Default line types for layer classes

Layer class(es)	Default line type
Main, Manufacturing, Windows and cutouts, Horizontal cross section	Cut, or last valid line type used
Counter	Counter periphery tool, or last valid line type used

Layer class(es)	Default line type
Print registration	Print registration
Outside bleed	Outside bleed
Outside coating (1-3)	Outside coating
Inside bleed	Inside bleed
Inside coating	Inside coating
Dimensions, Overall dimensions, Annotation	Annotation
Dynamic Art	Dynamic Art
Artwork Panels	Copy area
3D Assist	Tear
Graphics, Outside graphics, Inside graphics, Label graphics, Shrink-wrap graphics	Print image
All others	None; any type is appropriate

The Toolbar Master Controls and toolbars



The Toolbar Master Controls let you turn toolbars on and off in Designer and Manufacturing. The first button controls which standard toolbars are shown. The second button controls which customized toolbars are shown.

Initially the toolbars appear to the left of the drawing area, but each toolbar can be independently detached, or docked in a different position if desired.

Note: When a toolbar is activated for the first time, it will appear undocked outside the ArtiosCAD window. Drag it to the desired position inside ArtiosCAD.

Sixteen predefined toolbars are controlled by the Toolbar Master Control for standard toolbars in Designer. Up to 10 customized toolbars are controlled by the Customized Toolbar Master Control; it depends how many are defined in Defaults.

To turn a toolbar on or off, click the button preceding the name of the toolbar. Each button depresses when clicked for the first time to indicate the toolbar is on. Click the button again to return it to its raised position, indicating the toolbar is turned off.

Availability of toolbars controlled by the Toolbar Master Controls depends on the options purchased. If you cannot click a toolbar activation button, the tools or features controlled by that toolbar have not been purchased.

Designer toolbars

Shown below is the Toolbar Master Control for standard toolbars in Design.

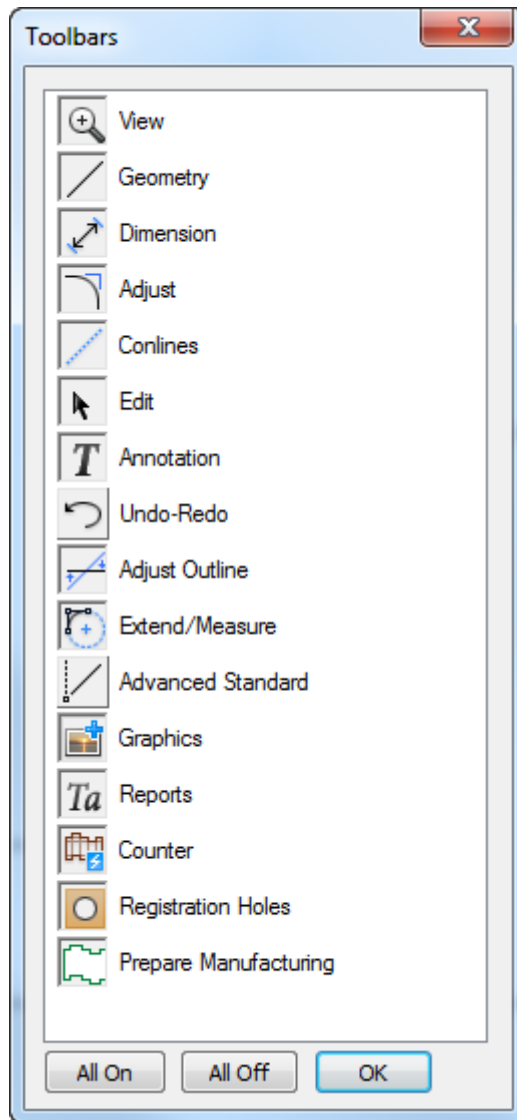

The first button turns the View toolbar on and off. The tools on the View toolbar are used to change the view of the current window.

The second button turns the Geometry toolbar on and off. The tools on the Geometry toolbar construct lines and shapes.

The third button turns the Dimension toolbar on and off. The tools on the Dimension toolbar construct and modify dimensional annotations of lines, angles, and arcs.

The fourth button turns the Adjust toolbar on and off. The tools on the Adjust toolbar change the linear attributes of existing lines.

The fifth button turns the Construction Lines toolbar on and off. Construction lines are drawing aids that are not plotted or manufactured. The tools on the Construction Lines toolbar manipulate construction lines.

The sixth button turns the Edit toolbar on and off. The tools on the Edit toolbar perform physical transformations on items such as moving or copying them.

The seventh button turns the Annotations toolbar on and off. The tools on the Annotations toolbar add text, legends, and details to the current design.

The eighth button turns the Undo-Redo toolbar on and off. Tools on the Undo-Redo toolbar undo and redo actions, and manipulate the list of already-executed actions which can be undone and redone.

The ninth button turns the Adjust Outline toolbar on and off. The tools on the Adjust Outline toolbar adjust the non-linear physical properties of lines such as parallelism with an axis and direction.

The tenth button turns the Extend toolbar on and off. Tools on this toolbar create construction line extensions that extend lines into infinity and arcs into circles. These extensions contain points on which you can reference new geometry.

The eleventh button turns the Advanced Standard toolbar on and off. These tools create geometry based on other points in the design and are intended for use by the most advanced users.

The twelfth button turns the Graphics toolbar on and off. The tools on the Graphics toolbar manipulate pasted images from outside sources, the stock color, fills, strokes, and graphic placement.

The thirteenth button turns the Reports toolbar on and off. The tools on the Reports toolbar convert the current design into a report.

The fourteenth button turns the Counters toolbar on and off. The tools on the Counters toolbar operate the Intelligent Counters module. This module must be purchased in order for the Toolbar Master Control button to work.

The fifteenth button turns the Registration Holes toolbar on and off. Registration holes are used by the DieSaw and other die-making machines to manufacture dies.

The sixteenth button turns the Prepare for Manufacturing toolbar on and off. This toolbar has tools for working with bleeds, coating-free areas, bridges, nicks, and shortening creases for steel counters.

The **All On** and **All Off** buttons turn on or turn off all the toolbars, respectively.

Manufacturing toolbars

The standard Toolbar Master Control in Manufacturing works similarly to the one in Designer, but it has additional controls for the Manufacturing toolbars.

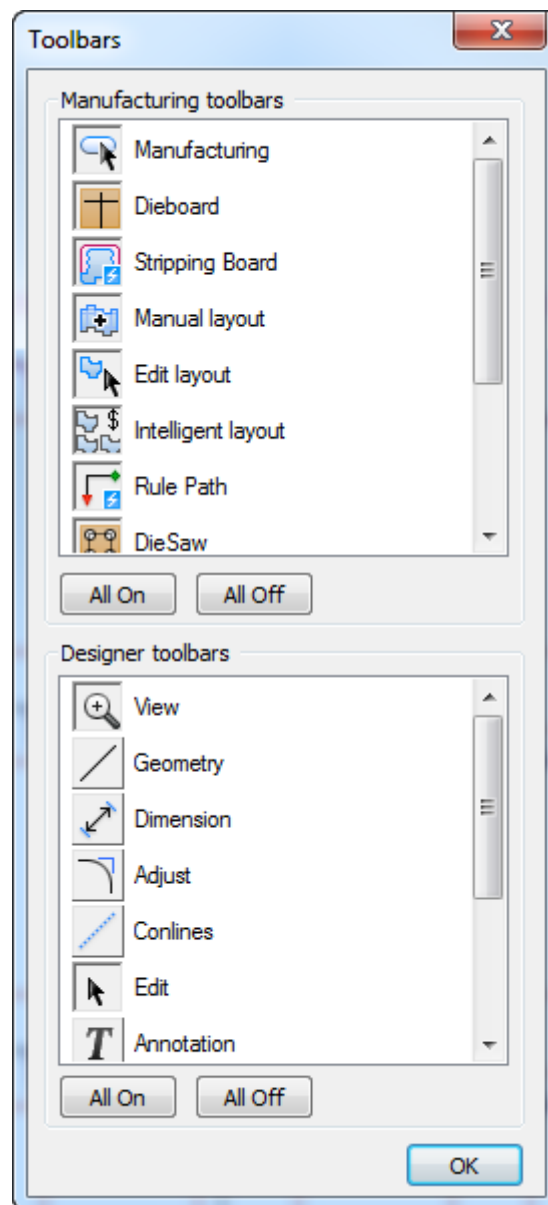

The first button in the Manufacturing Toolbars group controls the appearance of the **Manufacturing** toolbar. The tools on this toolbar select, delete, and repeat elements, as well as creating the dieboard edge, adding a burn name, and working with bridges and nicks.

The second button controls the **Dieboard** toolbar. Tools on the Dieboard toolbar make stripping rules, evenly spaced scrap knives, balance knives, dieboard splits, and so on.

The third button controls the **Stripping Board** toolbar. Tools on the Stripping Board toolbar make automatic area stripping, alignment holes, air holes, interference, and so on.

The fourth button controls the **Manual Layout** toolbar. Tools on this toolbar control which single designs are used in the layout, the gutter distance between designs, and the position of the layout on the sheet.

The fifth button controls the **Edit Layout** toolbar. Tools on this toolbar manipulate single designs and their position on the sheet.

The sixth button turns the **Intelligent Layout** toolbar on and off. Tools on this toolbar let you use and configure Intelligent Layout and Costing/Estimating.

The seventh button controls the **Rule Path** toolbar. Tools on this toolbar create, manipulate, and delete rule paths.

The eighth button controls the **DieSaw** toolbar. Tools on this toolbar control drill holes and other DieSaw-specific features.

The ninth and tenth buttons control the **Rubbering** and **Rubbering View** toolbars respectively. These tools let you build rubber along the lines in a layout, nest it, and lay it out in sheets for production, as well as letting you view different aspects of the rubber easily.

The eleventh button controls the **Blanking** toolbar. Tools on this toolbar create upper and lower blanking boards.

Availability of toolbars controlled by the Toolbar Master Controls depends on the options purchased. If you cannot click a toolbar activation button, the tools or features controlled by that toolbar have not been purchased.

Customized toolbars

The Customized Toolbar Master Control works the same way as the standard Master Toolbar Control. It will be empty until customized toolbars are created in Defaults. Once customized toolbars are created, use this control to turn them on and off like standard toolbars.

Toolbar positions

ArtiosCAD toolbar positions are saved automatically when ArtiosCAD is exited, but you can save them manually by clicking **View > Save Toolbar configuration**. You can then click **View > Restore Toolbar configuration** if they ever appear in the wrong place. Toolbar positions are stored in the Registry on a per-user basis.

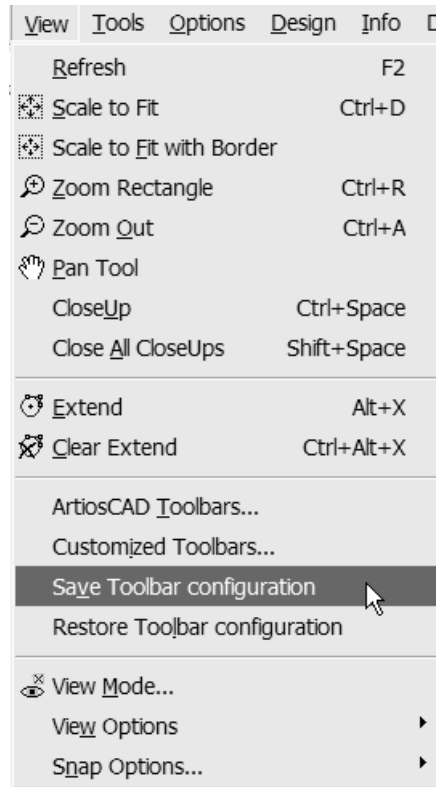

Flyout toolbars

Some tool icons have small black triangles in the lower right corner.



This indicates that there are related tools available on a flyout toolbar. Clicking and holding the mouse button will make the flyout toolbar appear, and dragging and releasing over a tool will select it. Hovering over a tool on a flyout toolbar displays a ToolTip for that tool.

Shown below is the **Line** tool with its flyout toolbar activated.

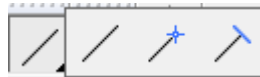

When a tool on a flyout toolbar is selected, it becomes the tool shown on the regular toolbar.

Changing the Toolbar Appearance

You can change the appearance of the toolbars if desired. **This is unsupported and may cause unpredictable results at any point; proceed with caution and save any work beforehand and afterward.**

To change the appearance of the toolbars, click **Help > Diagnostics > Toolbar Appearance**. The Toolbar Appearance dialog box opens.

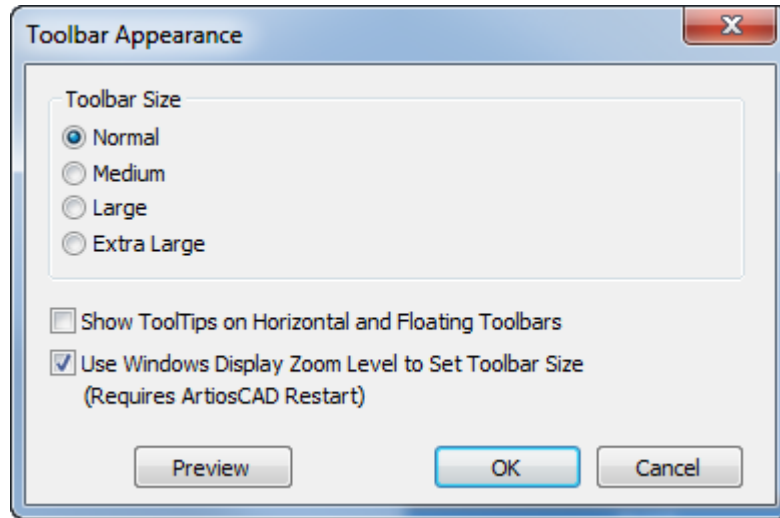

Set the size of the toolbars by choosing one of the options in the Toolbar Size group.

Show ToolTips on Horizontal and Floating Toolbars adds a label to each button on those types of toolbars. Enabling this option will significantly increase the size of the toolbars.

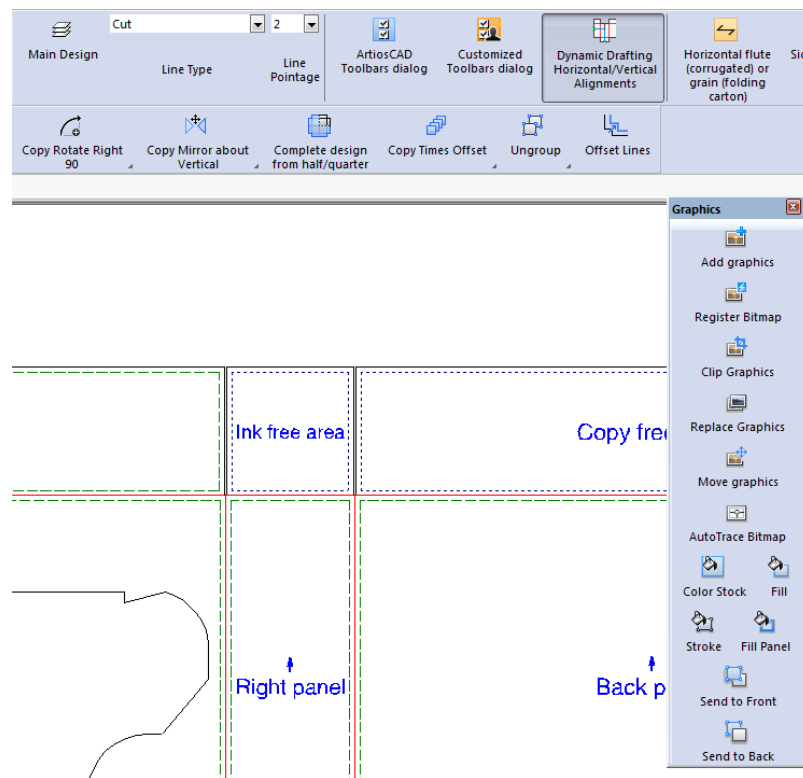

Use Windows Display Zoom Level to Set Toolbar Size links the size of the toolbars to the zoom level set in the *Make it easier to read what's on your screen* area of the Display control panel applet.

These settings are stored in the Windows Registry on a per-user, per-machine basis. These are not configured in Defaults.

The drawing area

The drawing area is where the work is done. Think of it as a piece of paper onto which you are drawing a design. The **View Mode** command on the View menu (and on the Zoom toolbar) controls what objects are displayed and how they are displayed in the drawing area. Shown below is a picture of a design in the drawing area.

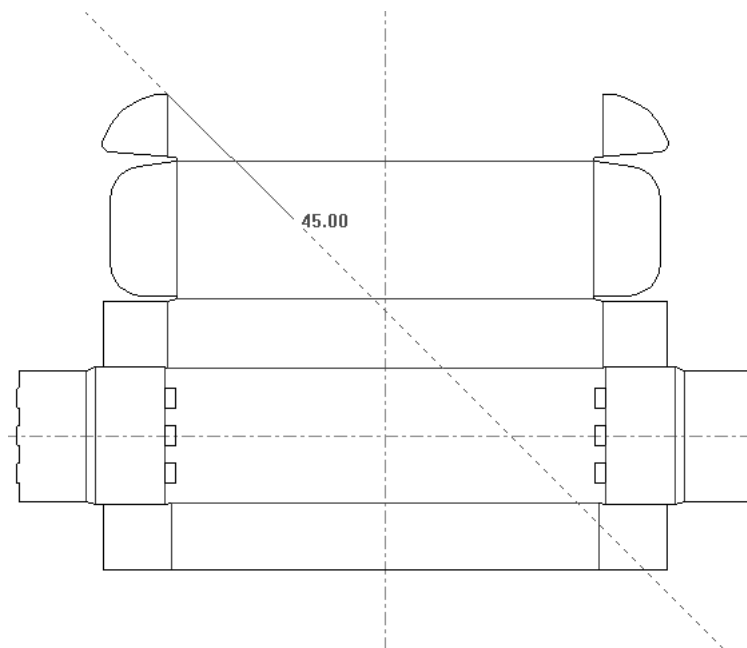

The Status bar

The fields and messages on the Status bar are the primary ways ArtiosCAD prompts for information needed to complete a task.



The picture of the Status bar above shows the prompts for a Line tool. The angle of the line, the length of the line, and the X and Y offsets of the endpoint from the current position can all be used to construct the geometry.

Move among the fields using the arrow keys on the keyboard, or click in them with the mouse. Next to each field is a symbol showing the direction in which the object being prompted for will be constructed.

Also next to each field is a keypad icon . Clicking the keypad displays an angle or length keypad and the variable keypad. Keypads are further described in the next section.

The Status bar also gives instructions. For example, when the Select tool is active, the Status bar tells you to hold down shift to add items to the current selection.

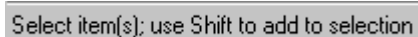

ArtiosCAD also uses a combination of prompts and instructions to gather information.



When using drag, the Status bar indicates what the drag will set. In the picture below, the drag is setting the value for an angle, and the Status bar indicates that by highlighting the field being set and by telling you what to do – set the angle.



Keypads

In addition to typing values directly into fields on the Status bar, you can use a keypad to click number buttons or use the field to enter expressions longer than the short fields on the Status bar. ArtiosCAD uses one keypad for angles and another for lengths, radii, and so on.

The keypads follow the order of operations; expressions are evaluated from left to right, in this order: items in parentheses, powers, multiplication and division, and then addition and subtraction being computed last.

When entering information in the calculation field by clicking buttons or variables, ArtiosCAD adds the plus sign automatically if the cursor is at the end of the calculation field. When starting the field or operator by clicking a denominator button, ArtiosCAD automatically inserts 1 before the slash to act as a numerator.

Shown below is the angle keypad, with a list of current workspace variables and their values in a separate but attached dialog box to its right.

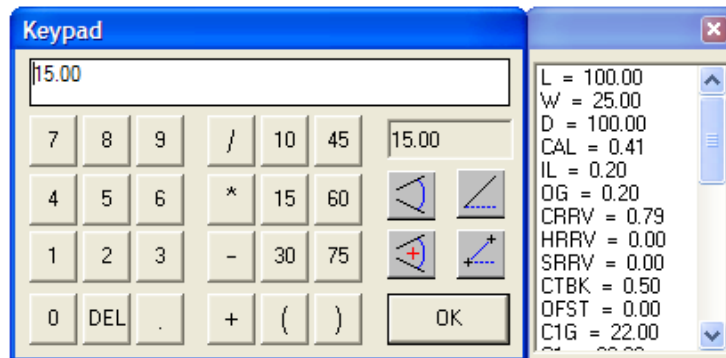

Common to both keypads, the number keys on the left side of the dialog box enter their numbers in the calculation field running across the top of the dialog box. Click inside the calculation field to type numbers, letters, and expressions. del deletes the last number, letter, or operator entered.

In the center group of buttons are the operators and common angle measurements.

Along the right side of the angle keypad are the results field and the special angle measurement buttons. The result field displays the current results of the expression in the calculation field. If the expression cannot be evaluated (for example, if it ends with an operator), ArtiosCAD displays err in the results field.

In the following feature descriptions, **absolute** means measured from the positive X axis in a counterclockwise direction. Also, using these four buttons replaces any values in the calculation field.



Angle between two lines prompts you to select two lines and then inserts the resulting angle between them into the calculation field.



Absolute angle between two lines with reference prompts you to select an initial line or point for reference, and then two lines. The angle of those two lines is either added or subtracted to the reference line's angle depending on which side of the reference point or line was clicked. The concept is that you click a line and then add the angle of two other lines to it. This added angle is what appears in the calculation field. Note that the new angle is not absolute to the reference line; it was absolute when it was measured between the two other lines.



Absolute angle of a line sets the value in the calculation field to the absolute angle of the line or endpoint clicked.



Absolute angle between two points sets the value in the calculation field to the absolute angle of the selected two points.

Shown below is the length keypad, with a list of current workspace variables and their values in a separate but attached dialog box to its right.

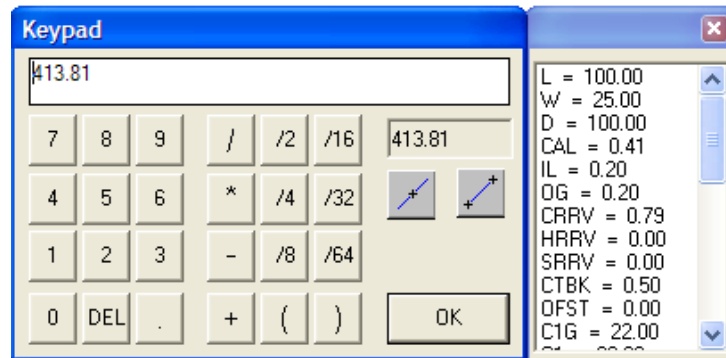

As on the angle keypad, the left portion of the keypad has buttons for each numeral and del. The center of the keypad contains the operators plus commonly-used denominators for fractions. Along the right side of the length keypad are the results field and the special line measurement buttons. The result field displays the current results of the expression in the calculation field. If the expression cannot be evaluated (for example, if it ends with an operator), ArtiosCAD displays err in the results field.



The **Absolute length of a line** button prompts you to click a line and then enters the expression for its length in the calculation field. The actual length is shown in the results field.



The **Distance between two points** button in uses dimensions of existing geometry to set the value of a new piece of geometry. This is useful when the distance between two points is unknown, or if you want to make a rebuildable design.

Parameter sets

Parameter sets are collections of settings that govern aspects of the current design or manufacturing file. The collection can be based on anything – by customers, by machines, or however else you want to group information.

Single design parameter sets allow you to assign different values to different sets for the following entries:

- Default bridging formulae to use
- Flute/grain setting
- Side up
- Bleed and Varnish offsets

Manufacturing parameter sets, in conjunction with machine parameters, allow you to customize various settings per set or per machine. A partial list of the values you can set are:

- Die board size
- Default bridging formulae
- Settings for chop knives
- Mounting hole parameters

Many more options can be set using parameter sets.

Rule Length Dialog Box

The Rule Length dialog box (**Info > Rule Length**) shows information similar to what is available in the line type legend. Additionally, it can show information for the current print item, as well as differentiate between specific and generic rule using **Show generic types**.

Rule Length [X]

Rule Totals

Cuts: 4500.12

Creases: 2751.14

Other rules: 903.29

Total rule length: 8154.55

Length of selected lines: 0.00

Line Types

Name	Length
Cut	4500.12
Crease	2751.14
Partial cut	450.85
5 5 Perf	452.44

Show generic types

Rule Length [X]

Rule Totals

Cuts: 4500.12

Creases: 2751.14

Other rules: 1777.29

Total rule length: 9028.54

Length of selected lines: 874.00

Line Types in Current Print Item

Name	Length
Cut	4500.12
Crease	2751.14
Generic perf	1326.44
Partial cut	450.85

Show generic types

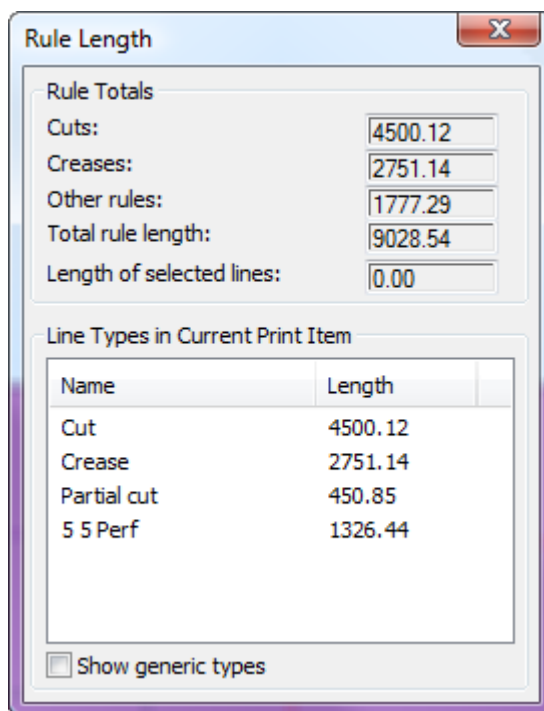

Working with design files

Although ArtiosCAD has different modules, they manipulate design files in the same way.

How to view revision history

To view the revision history of a file, click **Info > Revision History**. The History dialog box will open and show the revision history.

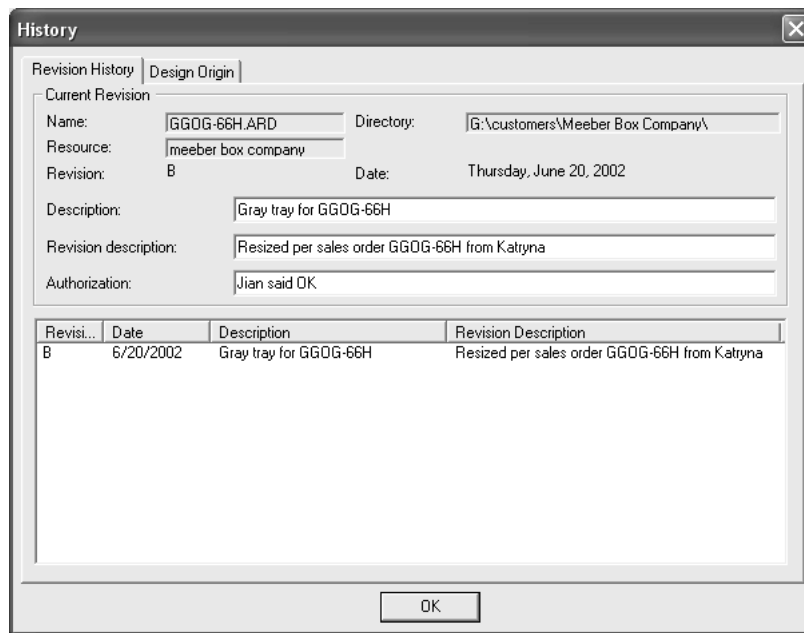

How to view the design origin

The **Design Origin** tab in the Revision History dialog box shows the name of the standard used to create a new design, if the design was made from a standard.

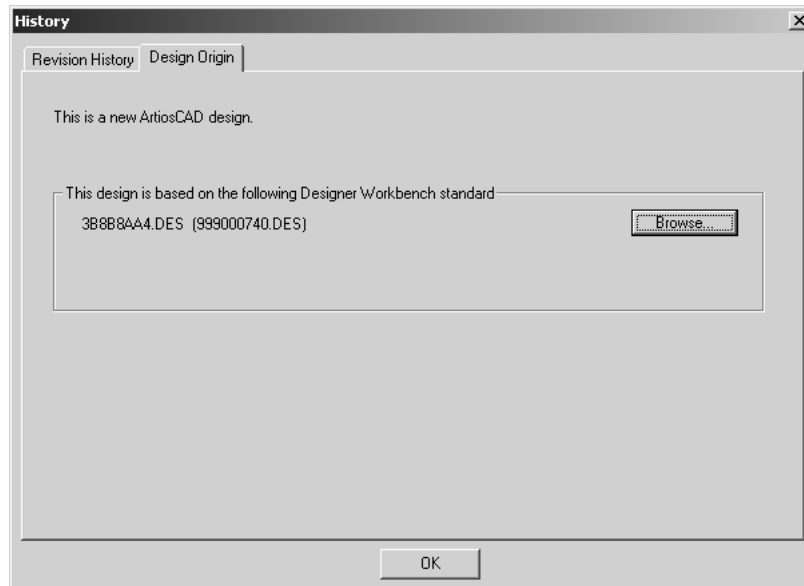

File views

ArtiosCAD's tight integration with DataCenter lets you open or save files in file system directories or database resources. There are two tabs in each dialog box that control where the file is saved to or opened from.

Directory view lets you navigate among the directories, hard drives, and network connections to choose the location for the file.

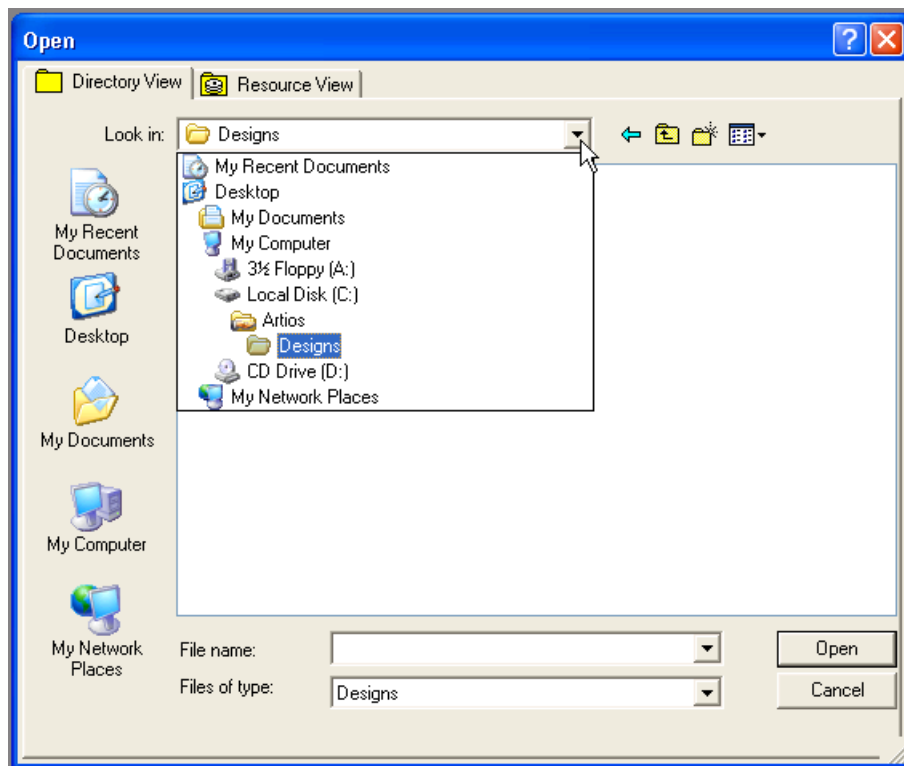

Resource view lets you navigate among database resources to choose the location for the file. Configure resources using DataCenter Admin; see the DataCenter chapter for more information.

Resource view also allows you to view all revisions of a file, or only the most recent version of the file.

Click  to view all versions of a design.

Click  to view only the most recent revision.

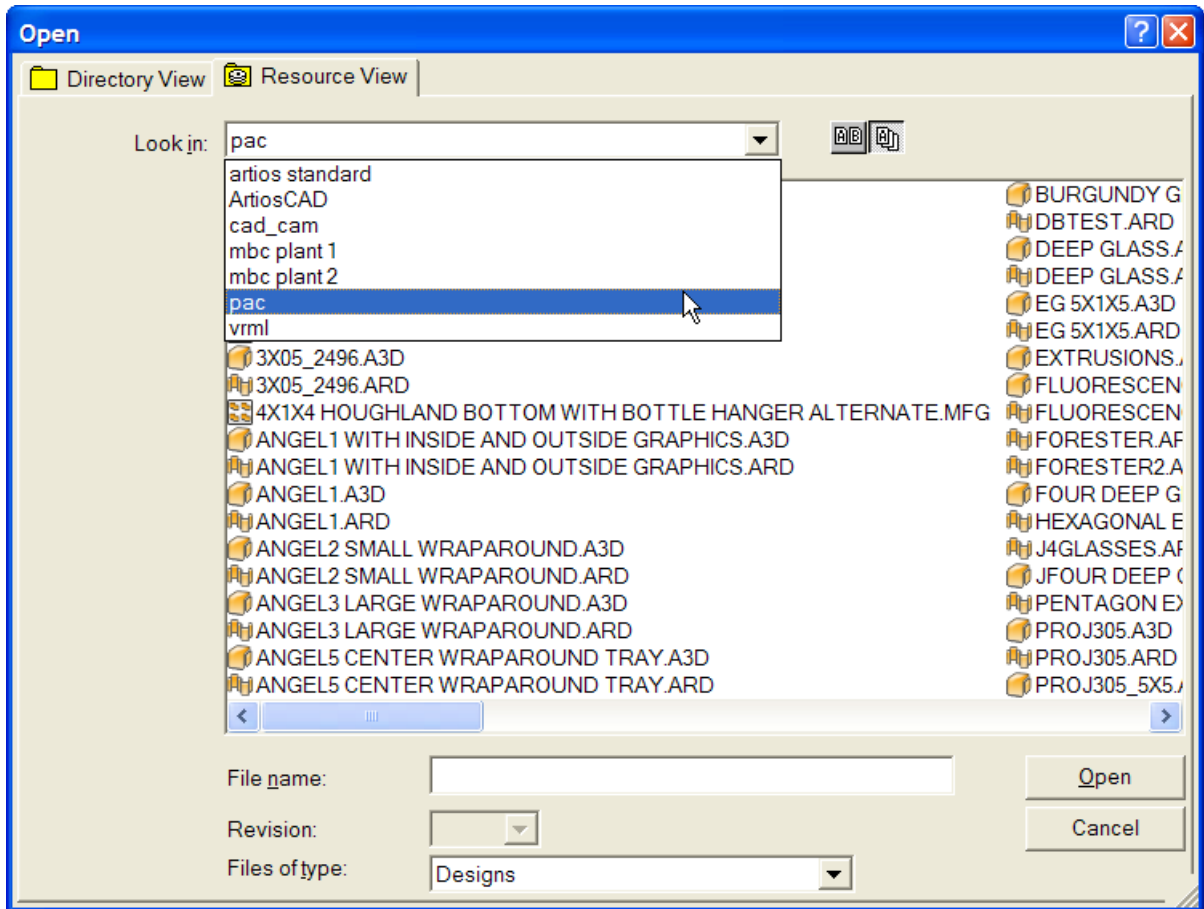

It may take some time for all filenames to display in resource view, particularly if there are Designer WorkBench files in that resource. If you know the name of a design, you may type it in the **File name:** field at any point without having to wait for the full list to appear.

Creating, opening, and importing designs

Creating, opening, or importing a design use the creative portions of ArtiosCAD. Running a standard is one way to create a new design. To run a standard, click **File**, then click **Run a standard**. The Standards Catalog will appear from which you may choose the standard on which your new design will be based.

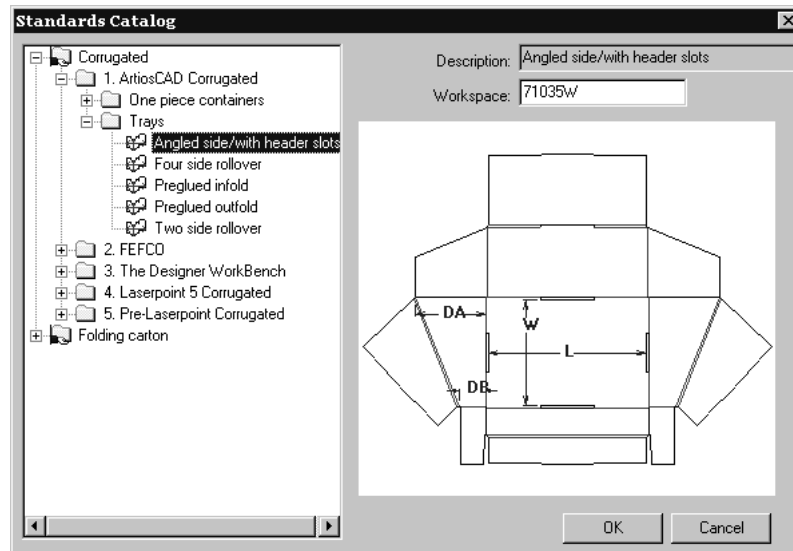

How to create a new blank design

Another way to create a new design is to click **File**, and then click **New** and then **Design**. Choose a parameter set and a board code, and click **OK**. This creates a new blank workspace; use the Designer tools to create geometry.

How to assign a parameter set and board code

Whether creating a design from a standard or from scratch, you must choose a parameter set and a board code. A board code is a group of settings that tells ArtiosCAD various things about the material used to manufacture the design. This can include information such as the thickness of the board, its weight, cost, inside loss, outside gain, scant, and allowance.

Select a board code at the same time you select a parameter set. Select the board code you want to use and then click **OK** (if creating a blank design) or **Next** (if running a standard) to continue creating the design.

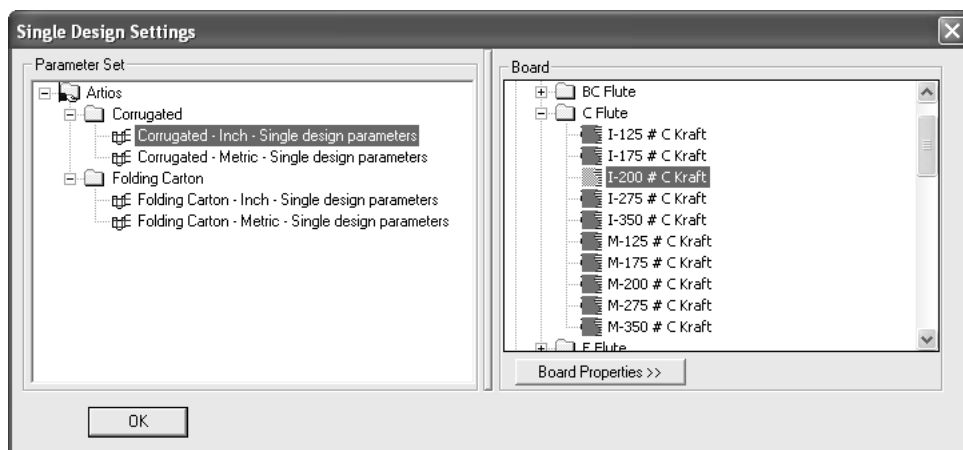

Drag the splitter between panes to adjust their sizes.

Clicking **Board Properties** shows information about the selected board. Board information is extracted from the database and thus cannot be changed in ArtiosCAD if the database is available. Only when the database is unavailable are the fields available for changing. Click **OK** to close the dialog box.

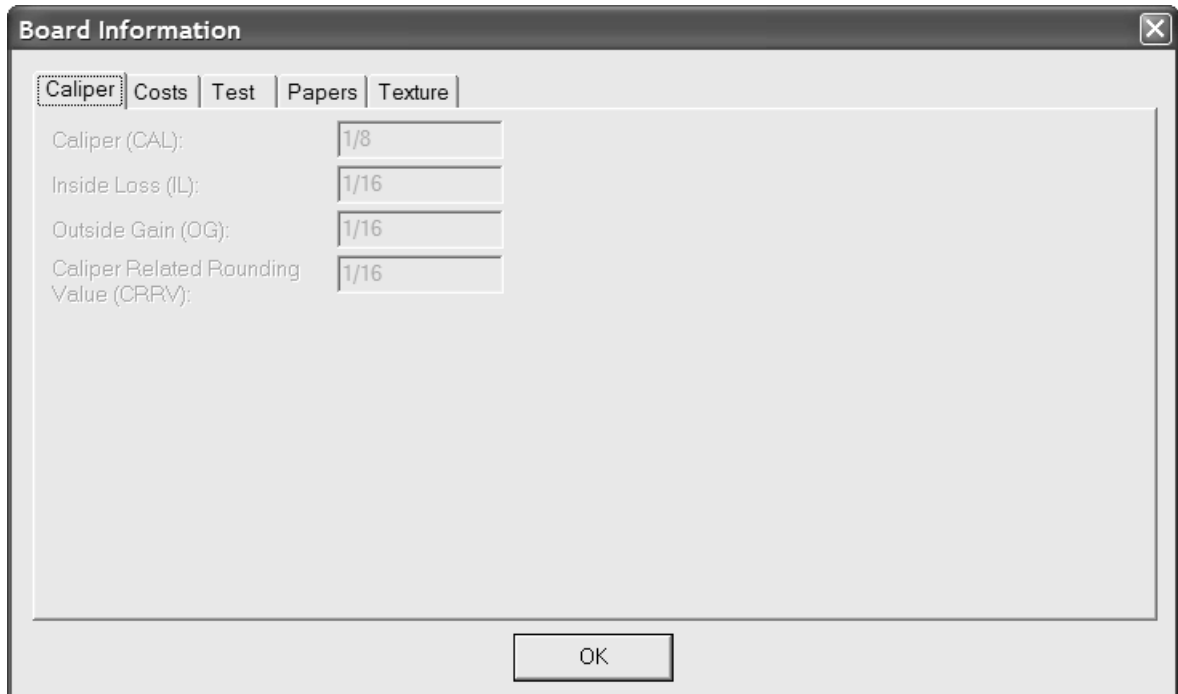

How to open an existing design

To open an existing design, click **File**, and then click **Open**. Use the **Directory View** tab to navigate using directories, or use the **Resource View** tab to navigate using database resources. Click the filename of the design to open, and click **Open**.

To open more than one design at once, use Directory View, click the first design to open, hold down CTRL, click the other files to open, and then click **Open**.

There is a limit of 2562 characters in the **File name:** field when opening designs.

The design preview is shown next to the Open dialog; the **Description:**, **Short Description 1:**, **Short Description 2:**, and **Short Description 3:** fields and the dimensions (if known) are shown beneath the preview. The design preview can be resized as desired, but if it is too small, some of the text shown will be truncated. When selecting multiple designs to open, only the first design selected is previewed.

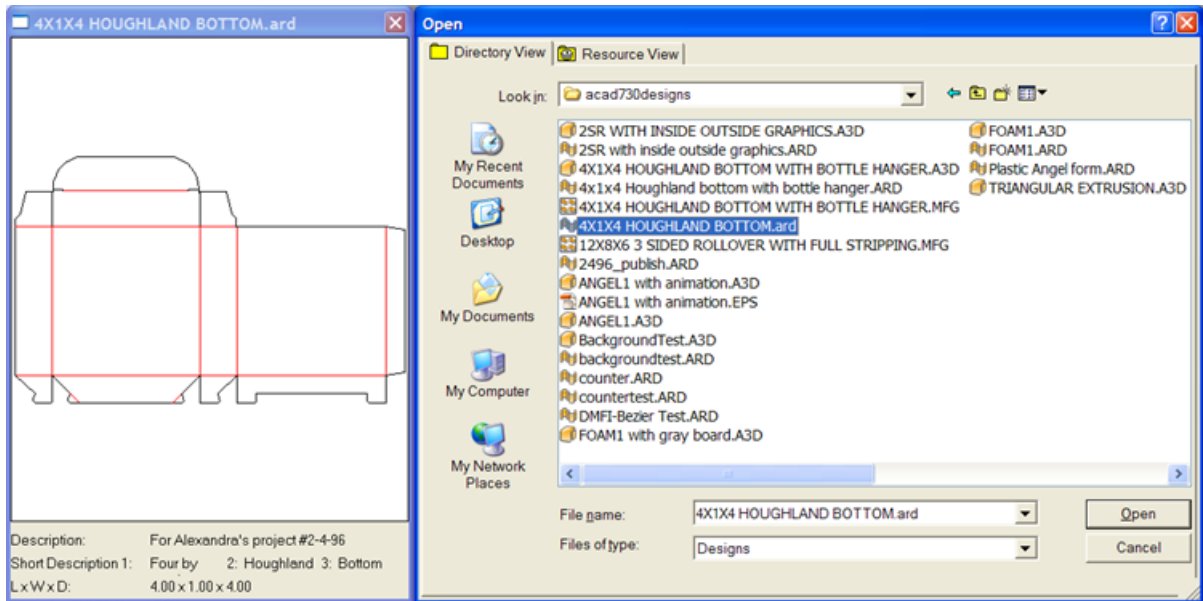

Upon opening, the design is initially displayed according to the View Mode defaults in **Options > Defaults > Design Defaults > Default View Mode**. In that dialog box are settings for line attributes, nick style, high graphics mode, screen background color, plotting style, and whether the layers shown as are saved or the default settings.

It is easiest to open Designer WorkBench designs in Resource View. That way you can navigate to the proper resource and the DWB hexadecimal disc filename will be displayed as the DWB design number.

Designer WorkBench single designs which contain stepping information will use that data to create a layout when the single design is opened and converted to a manufacturing file.

The Scant variable in workspaces originally created in Designer WorkBench is mapped to either the Outside Gain (OG) or Inside Loss (IL) variable via the setting in **Options > Defaults > Design Defaults > DWB Options**.

When you open a single design containing records from another database, the Add Database Entities dialog box appears. In this dialog box, choose which entities to add to your database by checking the checkbox next to each available category. The enabled categories depend on which entities are set in the single design.

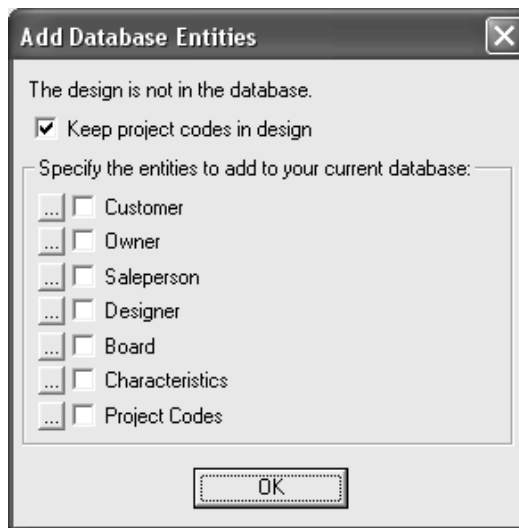

The **Keep project codes in design** checkbox controls whether or not ArtiosCAD leaves the Project codes from the foreign database in the single design or if it strips them out.

To see the specific entities for each category of database entities, click ... next to the checkbox. All entities will be added if you check the checkbox; there is no way to choose which specific entities are added to the database. Specific Project entities are shown below; click **OK** to return to the Add Database Entities dialog box.

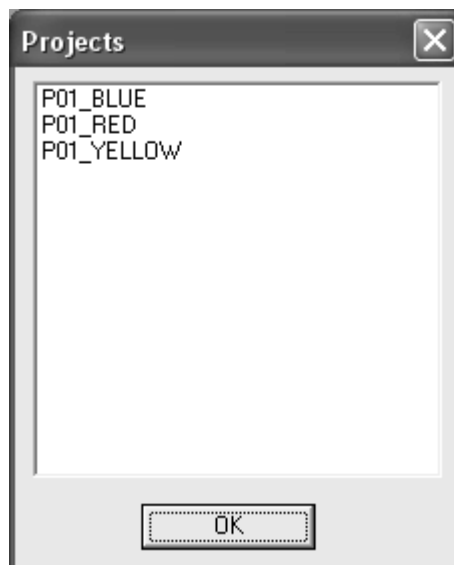

If a later revision of the design exists, you are prompted to choose to open the selected revision, or the latest revision. Choose the desired choice and click **OK**.

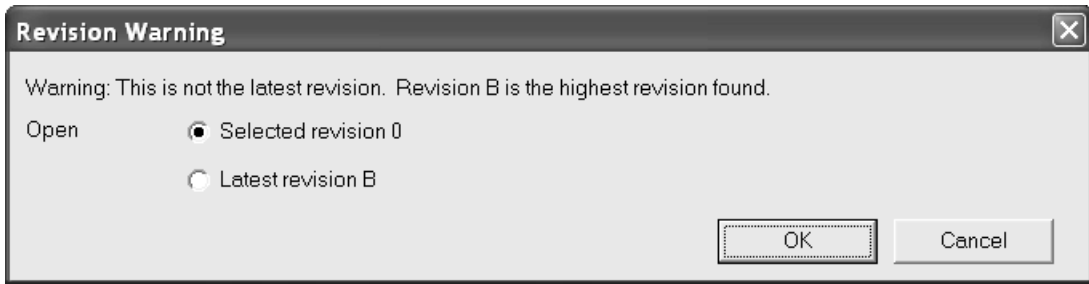

If the design you are opening is an exported canvas part containing hardware parts, ArtiosCAD puts images representing the geometry of the hardware parts in the Main Design layer.

Opening a design that is already open

If you open a design that is open in another session of ArtiosCAD, ArtiosCAD warns you that it is already open, and also who opened it and when it was opened.

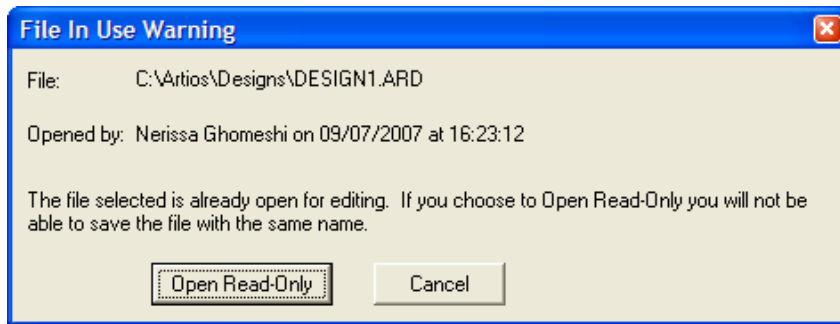

Click **Open Read-Only** to open the file in read-only mode. Using **File > Save** on a read-only file generates a warning message. You must use **Save As** to save the file with a new name.

Click **Cancel** to not open the file.

If you open a file as read-only, the ArtiosCAD window title bar displays (READ_ONLY) as a reminder.

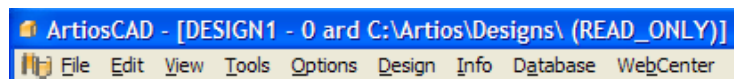

ArtiosCAD tracks open files by creating a hidden **filename.alck** file in the same directory as the open file. If you do not have write permission in the directory, the lock file cannot be created and the file will not be protected against opening by other sessions.

To open a file directly in read-only mode, click **File > Open Read-Only**.

Note: If you choose the original filename when doing a **Save As**, ArtiosCAD will overwrite the original file with the new file if the file is no longer locked. If the file is still locked by another instance of ArtiosCAD, you may not save the file with the same name.

How to open a design on a Web server

To open a design that is saved on a Web server, click **File > Open URL** and enter the URL for that design, e.g. <http://artcad.mycompany.com/myfilename.ARD>.

How to open an existing manufacturing file

To open an existing manufacturing file, do the following:

1. Start ArtiosCAD.
2. Click **File > Open**.
3. Using either Directory view or Resource view, navigate to the location in which the manufacturing file is saved.
4. Click the name of the manufacturing file to select it. A preview of the manufacturing file appears just as it does for a single design.

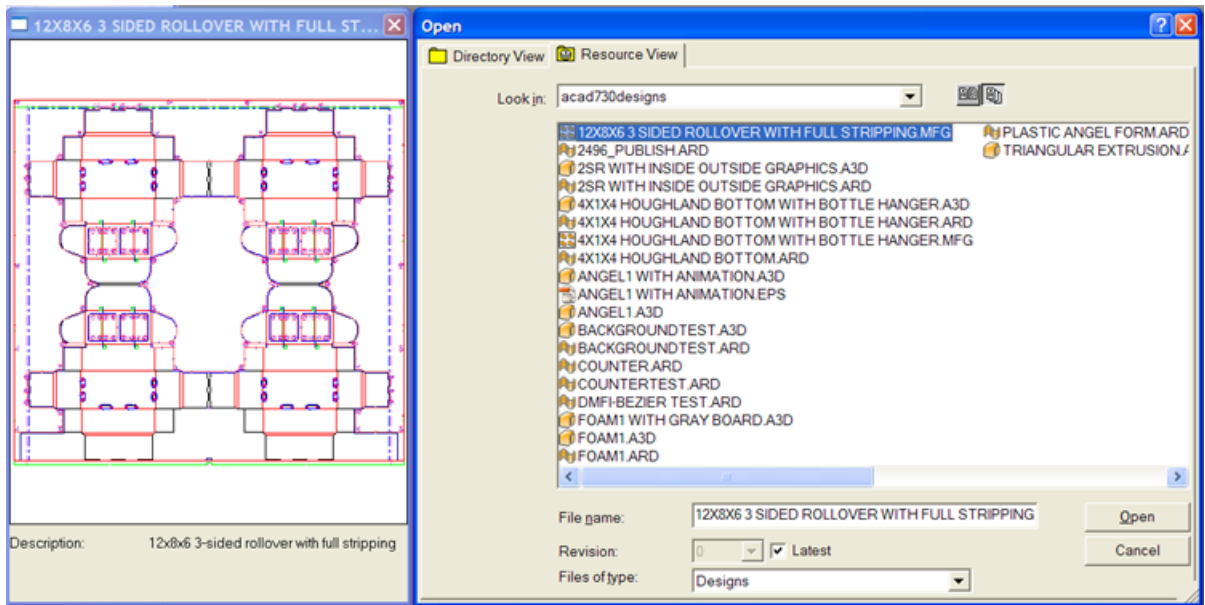

5. Click **Open**. The manufacturing file is opened.

If a later revision of the manufacturing file exists, you are prompted to choose to open the selected revision, or the latest revision. Choose the desired choice and click **OK**.

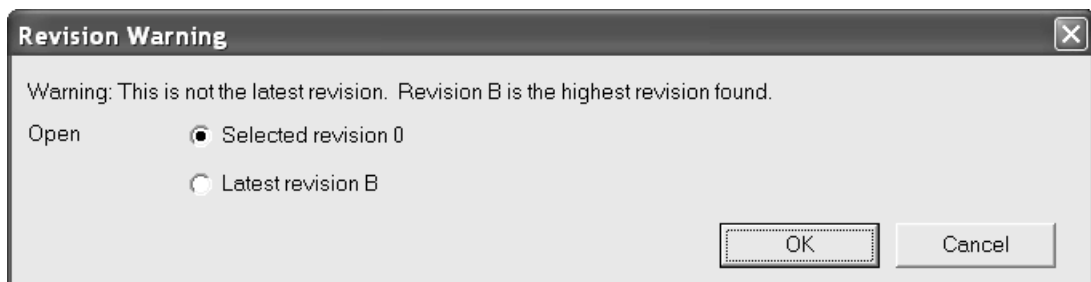

When opening a manufacturing file, ArtiosCAD checks if a disk file exists with the same name as the embedded single design(s). If such a file exists, its creation date and time are compared with the embedded single design(s). If the two are different, ArtiosCAD prompts you to select the one to use.

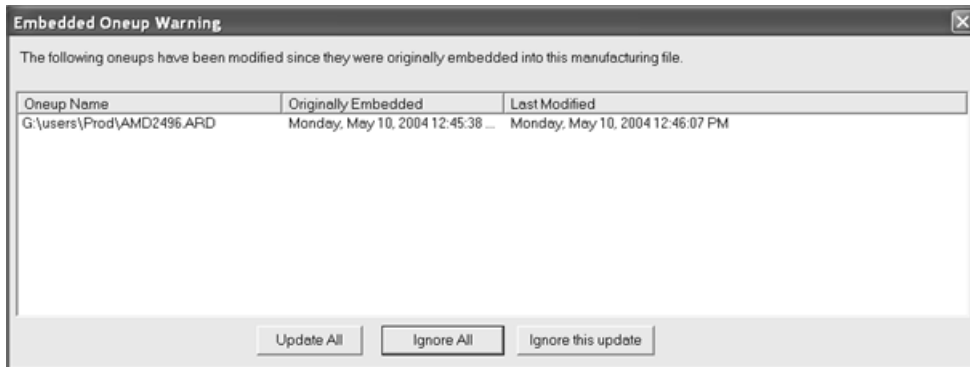

Update all replaces the older embedded single designs with the newer versions. ArtiosCAD checks for double knives in the manufacturing file, double lines in the single designs, and to see if the single designs have different origins, sizes, sides up, or grain directions from those they are replacing.

Ignore all keeps the embedded single designs and ignores the newer versions. The warning will appear again the next time the manufacturing file is opened.

Ignore this update keeps the embedded single designs and saves the new modification date in the manufacturing file so no warning occurs the next time the manufacturing file is opened.

How to import an existing ArtiosCAD design into another

To import an existing ArtiosCAD design into another, do the following:

1. Start ArtiosCAD and open the design into which the other design will be imported.
2. Click **File > Import > Import File**.
3. Select the file to import and click **Open**.

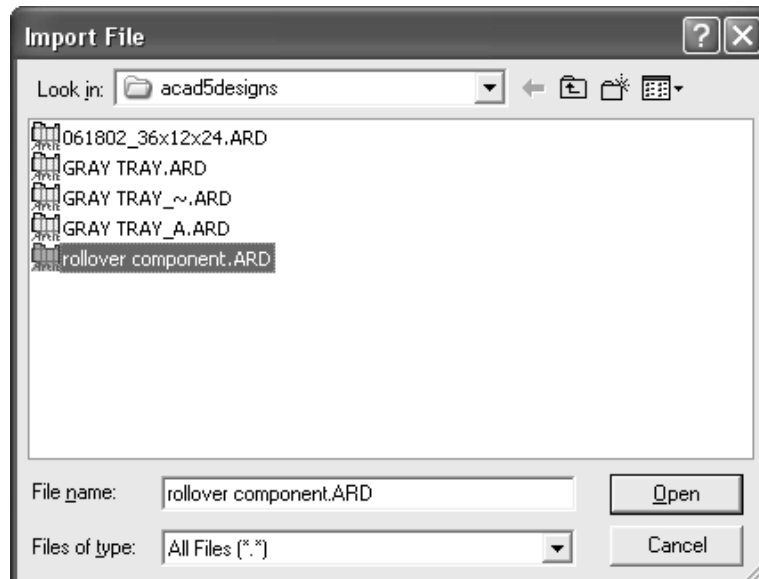

4. In the Select Layers dialog box, select the layers to import into the design by checking or clearing the checkboxes next to the layer names as appropriate. Click **OK** when you have chosen the layers of the design to import.

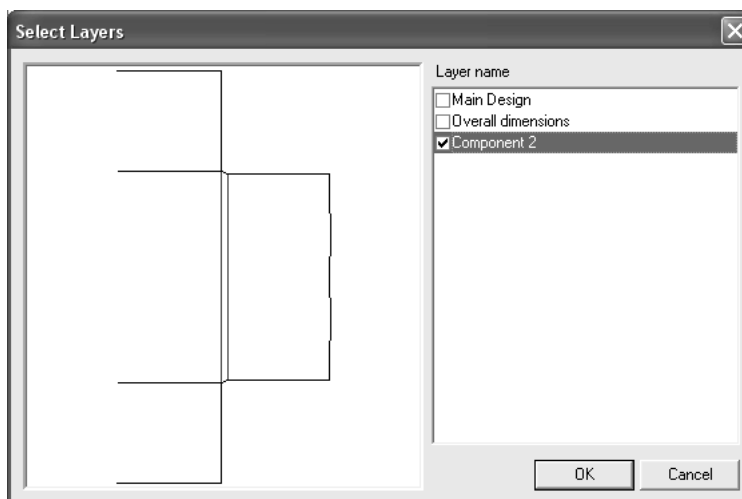

5. The selected layers of the design will be imported into the current workspace. All of the imported objects will be selected and the **Move** tool will be active. Click to set a pick-up point and click again to set a put-down point. To cancel the move, select another tool.

How to import a design in a different format

Opening a design in a different format, such as DDES, DXF, EPSF, or CFF2, is done in the same way as opening a native ArtiosCAD design file. Click **File**, and then click **Open**. Navigate to the proper directory using the standard controls, click the filename of the design to open, and click **OK**.

If your filename does not have one of the standard extensions (.DS2, .DXF, .EPS, .CFF, .N, etc.), then you must change the entry in the **Files of type** list box to **All files** in the Open dialog box. If your file does not have one of the standard extensions, it will not appear in the list of files available unless you change the listing to **All files**.

Line type mappings and other translations for each file type are configured in **Defaults Shared defaults Import Tuning Table**.

A preview of the file selected for import appears next to the File Open dialog box.

Importing a DDES file

When you open a DDES2 or DDES3 file, the Importing DDES File dialog box (or Importing DDES3 file dialog box) appears as shown below. Set the option buttons as desired, click **OK**, and choose the desired parameter set and board code to import the file.

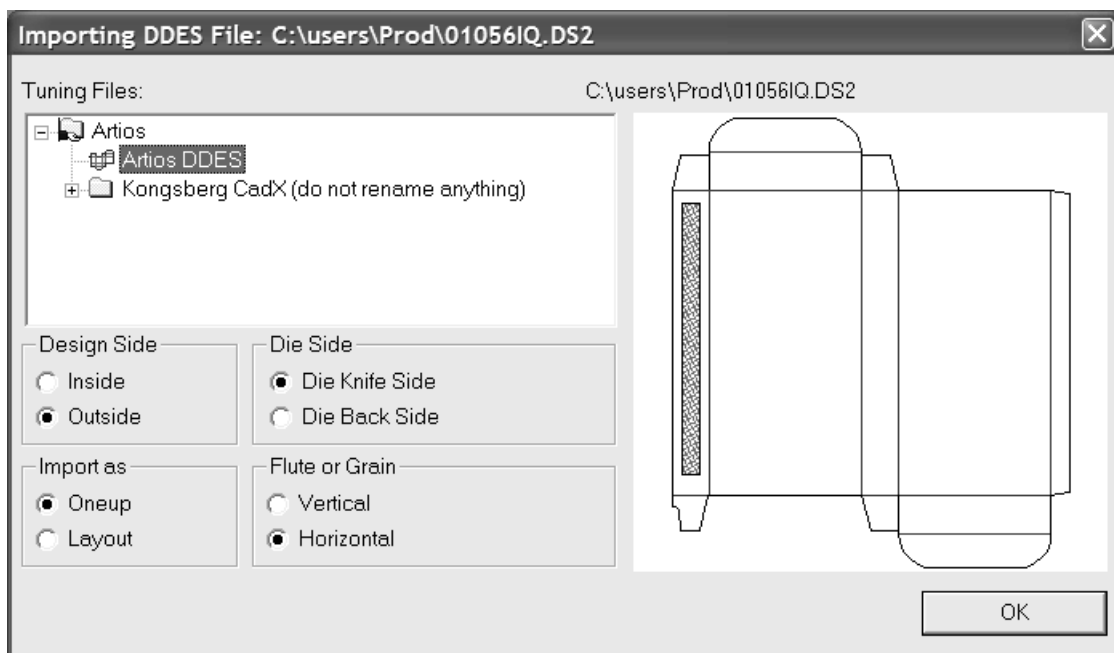

Importing a DWG file

When you open a DWG file, the Importing DWG/DXF File dialog box appears. Set the option buttons as desired and click **OK** to import the file.

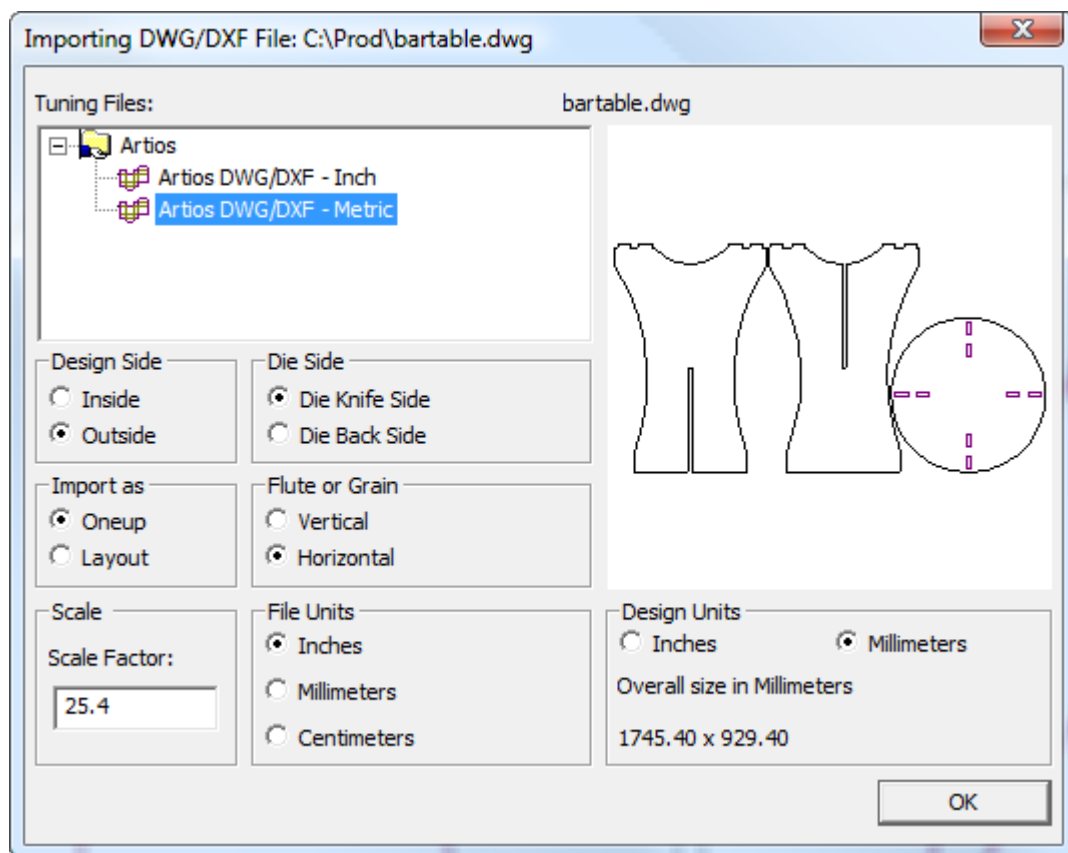

Note: ArtiosCAD ignores any 3D data in the file.

If fills do not look correct, click **Options > Defaults > Import Tuning Table > Tuning entry > Options** and in the DWG/DXF Import Options dialog box, select or deselect **Skip Solid/Gradient Fills**.

Importing a DXF file

When you open a DXF file, the Importing DWG/DXF File dialog box appears.

Set the option buttons as desired and click **OK** to import the file.

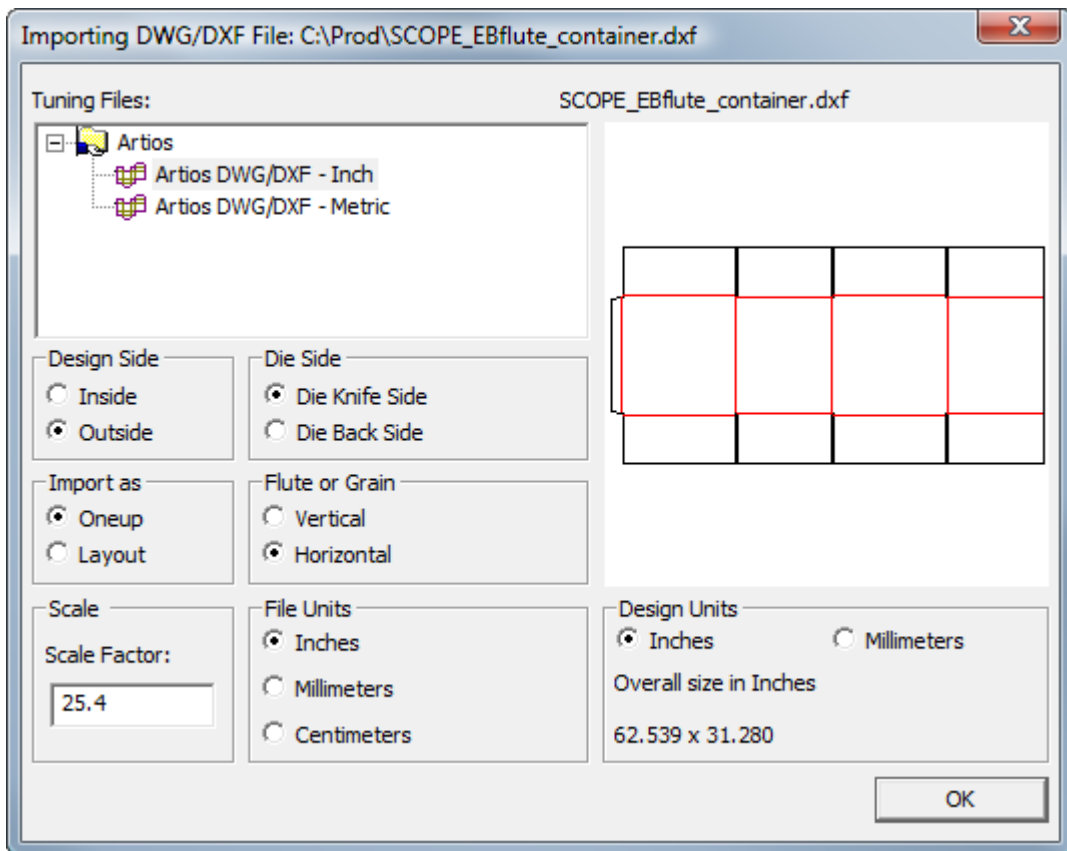

Note: ArtiosCAD ignores any 3D data in the file.

Note: If you have trouble importing a DXF file, try clearing **Import DXF files using third party libraries** in **DWG/DXF Options** in Startup defaults.

When importing a DXF file, ArtiosCAD can import C2 and C3 curves, and degree 4 to 7 splines.

Spline degrees	ArtiosCAD imports as
2, 3	Beziers

Spline degrees	ArtiosCAD imports as
4-7	Arcs with accuracy to 0.02mm
8-10	Incorrect beziers with a message they are not supported

If fills do not look correct, click **Options > Defaults > Import Tuning Table > Tuning entry > Options** and in the DWG/DXF Import Options dialog box, select or deselect **Skip Solid/Gradient Fills**.

Importing a CFF2 file

When you open a CFF2 file, the Import CFF2 File dialog box appears. Set the option buttons as desired and click **OK** to import the file.

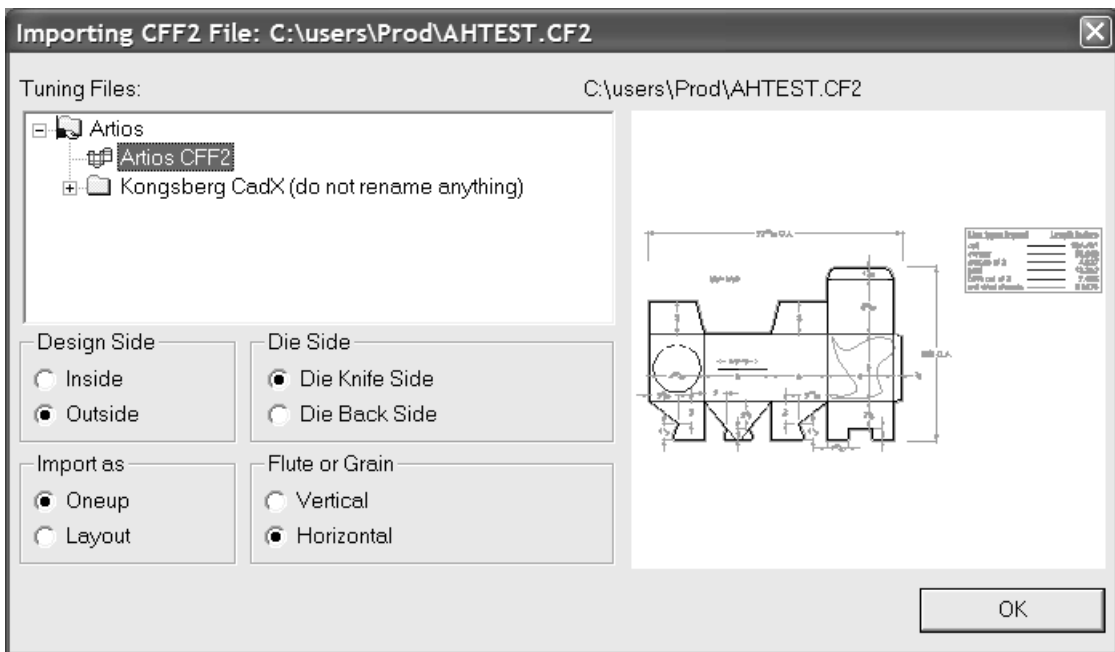

When opening a CFF2 layout, ArtiosCAD can base the size of the sheet on the lower left and upper right values contained within the file. This is configured by the **LL/UR values to contribute to sheet size** checkbox in **Defaults > Shared defaults > Import Tuning Table > Artios CFF2 > Options**. Rotation and mirroring options are also set in this dialog box, as is the transformation order and the minimum blank area needed to consider the CFF2 file a layout. The default standard transformation is to rotate and then negate, but you can choose to negate then rotate in the Elcede style.

Importing an EPSF/AI file

When you open an .EPSF or .AI file, the Import EPSF Options dialog box appears.

Import as Graphics imports strokes and fills unchanged. **Convert Strokes to Lines** and **Convert Fills to Lines** change fills and strokes to print image lines and places them into overlays whose names are the color of the fills/stroke and the thickness of the strokes in points.

Set the checkboxes as desired and click **OK** to import the file.

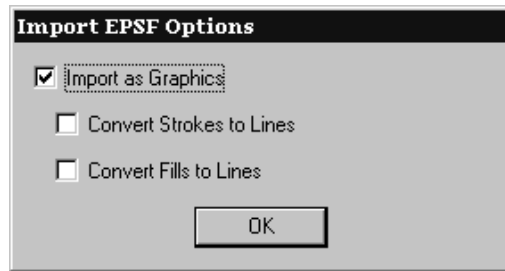

You can import only Illustrator 3.2 and Illustrator 8.0 EPSF files. TIFF previews are ignored. Other EPSF file types are not supported. Some .AI files are supported using EPSF import functionality while others require the PDF option to open. If you receive a Feature not available message while trying to open an .AI file, the file is likely in the format that needs the PDF option.

If the EPS file has more than 8 MB of vector data, it will be lost when the design is converted to 3D. Use the JPEG format or PDF instead of EPS if working with large files.

Data Exchange Plug-In

The free Data Exchange plug-in lets Adobe Illustrator users place ArtiosCAD single design workspaces in Illustrator documents. It does not include placed EPS objects or other pixel-based objects. The plug-in can be downloaded from Esko's Web site at <http://www.esko.com>.

For more information on the plug-in, refer to the Data Exchange help on the Help menu in Illustrator (**Help > Esko > Help > Esko Data Exchange**).

Importing Elcede .N files

When you open an Elcede Diecad .N file, the Import Elcede File dialog box appears. Set the option buttons as desired and click **OK** to import the file.

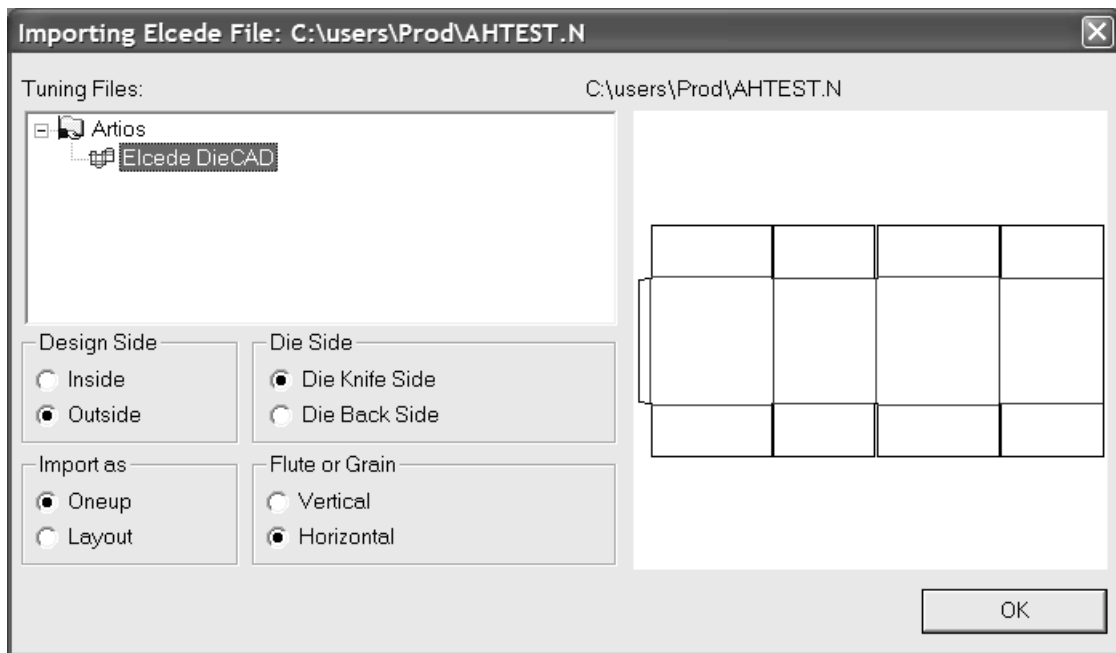

Note: ArtiosCAD can not open Diecad files with more than approximately 1000 lines in a section. If you encounter such a file, export the file from Diecad in CFF2 format, and read the CFF2 file into ArtiosCAD.

Working with other NC files

If you have Numeric Control files for which there are no native ArtiosCAD import filters, such as Elcede IBH/Vectocut files or Kongsberg MAP and ACM files, you can try using the **Open NC file** command on the Diagnostics menu in Single Design. This command is not supported; use it at your own risk. For help importing files of these types, contact Professional Services.

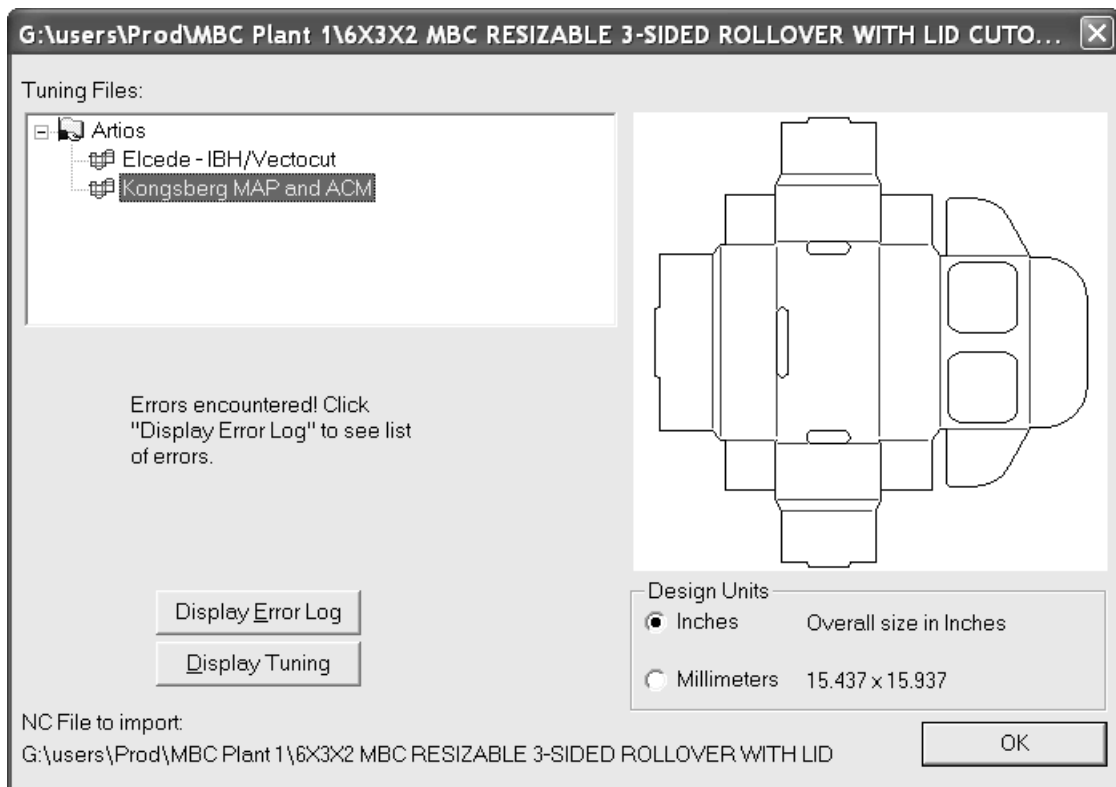

Opening a PDF file as lines

ArtiosCAD can now import the lines (also called *vectors*) in a PDF file. Previous versions could only import a PDF file as a graphic entity. Once the PDF file is opened, you can then work on the lines as you would any other structural workspace.

Before you can import a PDF file as lines, you must make sure there is at least one tuning catalog entry set up in Defaults to process PDF files. ArtiosCAD comes with two different tuning catalog entries as examples, but it is likely you will need to make a tuning catalog entry for each supplier of PDF files based on how they create the files.

Opening the PDF file

To open the PDF file, do the following:

1. Start ArtiosCAD.
2. Click **File > Open**.
3. Navigate to the directory or resource containing the PDF file.
4. Select the desired file.

A preview of the file will appear.

5. Click **Open**.

The **Importing PDF File** dialog box appears.

Choosing Import Options

In the **Importing PDF File** dialog box, do the following:

1. In the **Tuning Files** group, select the tuning file to use for this PDF file. The preview of the design may change depending on the tuning file you choose.
2. In the **Design Side** group, choose whether the side up is the **Inside** or **Outside**.
3. Set the options similarly in the **Die Side**, **Import as**, **Flute or Grain**, and **Design Units** groups.
4. Click **OK**.

Choosing Single Design Settings

In the **Single Design Settings** dialog box, do the following:

1. Select a parameter set and board to use in the new workspace.
2. Click **OK**.

The PDF file opens in ArtiosCAD according to the tuning you selected. You can work on it as you would any other single design.

PDF vector import notes and warnings

Please consider the following notes and warnings when importing PDF files as lines.

- Bitmaps in PDF objects come in as their net shape of their clip path (the outline of the part of the image that is rendered) and have graphic type **bitmap**. To preserve the bitmap image, import the PDF file as graphics rather than lines. The actual pixels of the image are not imported. Note: some bitmaps in PDF are not defined with a clipping path that is the shape of the thing in the bitmap. An example is the bitmap for the shadow in an ArtiosCAD Plot to PDF with shadows turned on. In these cases, the bitmap outline comes in as a rectangle.
- ArtiosCAD has a 99 layer limit. Therefore, complicated PDF files (those with more than 99 unique sets of import attributes) will typically reach this limit if they use a tuning that maps "any any any" to New Layer.
- When **Unfiltered items to graphics layer** in the **PDF Import Options** dialog box is enabled, a stroke's cap style, miter style, and miter limit are not preserved. All strokes in this situation appear with rounded join style and square cap style.
- When **Unfiltered items to graphics layer** in the **PDF Import Options** dialog box is enabled, the strokes and fills may appear underneath things (masked) even though they are visible in the original PDF file.
- When **Unfiltered items to graphics layer** in the **PDF Import Options** dialog box is enabled, objects with any coloration other than a single color (such as gradient fills, mesh objects, and so forth) appear as a solid color fill which depends on how the file was created. Gradient fills from Adobe Illustrator-created files generally come in as black fills.

How to open a Score! file

To open a Score! or Vellum file in ArtiosCAD, do the following:

1. Start ArtiosCAD.
2. Click **File > Open**.
3. Using either **Directory view** or **Resource view**, navigate to where the Score! file is saved.
4. **Files of type** should be set to **Designs**. If it is not, click the drop-down arrow and set it to either **Designs** or **Score!**.
5. Click the name of the Score! file to select it.

A preview of the Score! file appears.

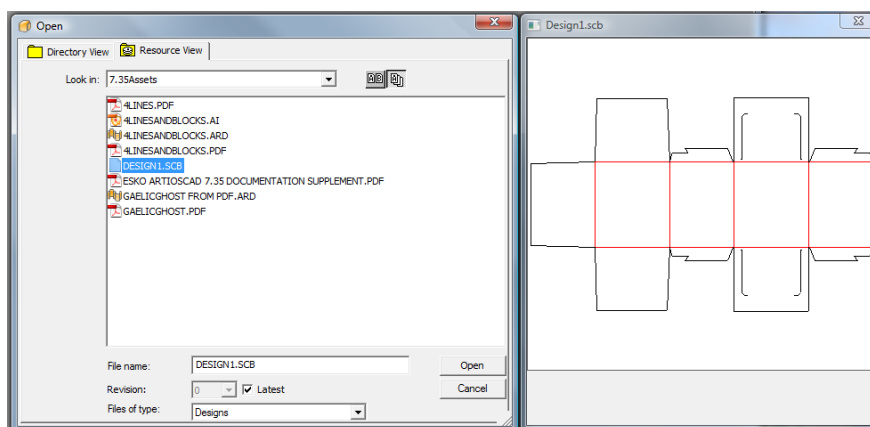

6. Click **Open**.
7. In the **Single Design Settings** dialog box, select the desired parameter set and board code, then click **OK**.

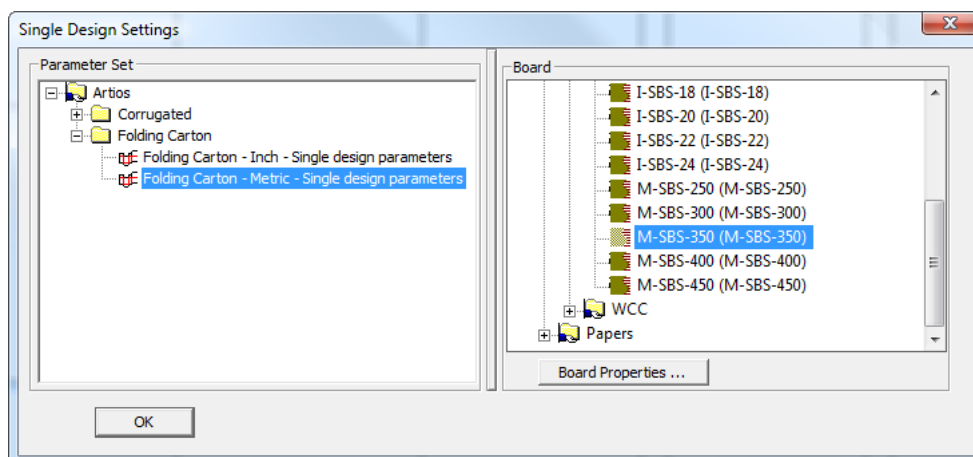

ArtiosCAD opens the file and you can work on the file as you would any other design.

More information about opening a Score! file

The following sections contain reference information to consider when opening a Score! or Vellum file in ArtiosCAD.

Score! file import restrictions

ArtiosCAD can open Score! and Vellum files with the following restrictions:

- ArtiosCAD does not import data from the Score! database about the file being opened.
- ArtiosCAD maps bridges on ellipses onto the arcs as closely as possible to the original file, but ArtiosCAD tries to keep the count and position of the bridges even across the series of arcs forming an ellipse.

Score! file model structure

A Score! file generally contains at least two models: Model 1 for the flat design and Foldup for the folded design. The contents of Layer1 in Model 1 go into the Main Design layer of the single design. All other layers in the Score! file go into layers of the same name in ArtiosCAD of layer class Annotation. If there is a layer named Dimensions in the Score! file, ArtiosCAD makes a Dimensions layer of class Dimensions in the ArtiosCAD workspace.

When ArtiosCAD opens a Vellum (.vlm) file containing multiple models, those models are imported into separate layers.

Score! line type mapping

ArtiosCAD automatically converts Score! line types to native linetypes per the entries in the following table.

Score! line type and name	ArtiosCAD line type and name
0, Annotation 10, Crosses 113, Chopper 115, Tester	0, Annotation
101, Knife	1, Cut
102, Crease	2, Crease
103, Perforation	3, Perf
104, Cutscore	4, Cut-Score
105, Cutcrease	5, Cut-Crease
106, Cutscore_Crease	15, Partial cut and crease
107, Reverse Cutscore	9, Reverse partial cut
108, Emboss	16, Half crease
109, Zipper 110, Wave	13, Generic special rule
112, Stripping	93, Stripping rule
80, Construction	34, Construction line
All others	0, Annotation

Score! bridging

A Score! file may have one of two different types of bridging: simple or complex.

For a file with simple bridging, ArtiosCAD takes the number of bridges specified and their width and uses those as the parameters for applying its Evenly spaced bridging formula.

For a file with complex bridging, ArtiosCAD uses the Specify bridge positions bridging formula. The first bridge width defined in the Score! file sets the width for all the bridges in the ArtiosCAD workspace. If the Score! file contains any double-width bridges, they are converted to two bridges separated by a slight gap.

Score! text

ArtiosCAD imports text from Score! files as text with the following limitations:

- Line wrap is ignored; a line will be extended as long as necessary.
- Text color is ignored.
- Line spacing is ignored.
- Underlined text is not supported.

Score! dimensions

ArtiosCAD imports the following types of basic dimensions from Score! files: Horizontal, Vertical, Parallel, Radial, Diameter, and Angle. Arc Length dimensions will be ignored.

Score! uses # to represent the real value of a dimension; ArtiosCAD changes this to {V} (also the real value of the dimension) except in the following cases:

- For a Distance or Angle dimension with just # in the dimension text.
- For a Radius dimension with exactly R # in the dimension text, ArtiosCAD will not show any dimension text, but the format will be set to **R50**.
- For a Diameter dimension with exactly 0 # in the dimension text, ArtiosCAD will not show any dimension text, but the format will be set to **Ø50**.

The table below shows how ArtiosCAD imports other aspects of Score! dimensions.

Score! dimensional element	How ArtiosCAD imports it
Text positioning	Uses closest matching positioning options
Arrowhead style	Uses closest matching
Arrowhead thickness	Imported
Dimension font and size	Imported
Dimension color	Ignored and set by the plotting style
Extension length and gap	Calculated from Score! settings
Units and formatting	Set by ArtiosCAD property defaults
Internal dimension extension lines	Not drawn when dimension text is outside the measured object

Score! fold angles

Most Score! standards are saved with a flattened Foldup model and with fold angles assigned to the creases.

During the import, ArtiosCAD copies fold angles and the base face from either the Foldup model or the **Foldup** layer from Model 1, to the creases in the **Main Design** layer.

The import of fold angles will not work if the Foldup model or layer does not exist or if the Foldup model has been folded up in 3D space.

Note:

if there are gaps in the design perimeter, ArtiosCAD cannot automatically convert the design to 3D.

Saving and exporting designs

Saving a design means that the work you have done in ArtiosCAD is written to a file on the hard drive for future use in ArtiosCAD. ArtiosCAD files are binary files that can be read only by computers running select Esko applications.

Exporting a design means that you are essentially taking a snapshot of the design and converting it to a different format for use by someone who does not have ArtiosCAD. Most common export formats are text formats.

How to save a design

To save a design, click **File**, and then click **Save**. If you are saving the design for the first time, ArtiosCAD will prompt you for the name of the file by displaying the Save As dialog box (see the next section). Do not use an underscore (_) as the last character of the filename, for that is used to determine revision history. If you have already saved the file, ArtiosCAD will save the design using the name shown in the title bar of the window.

If **Design check before Save, Save as** is checked in **Options > Defaults > Shared Defaults > Design Defaults > Save Options**, the design is checked for double lines and gaps in the perimeter of the design when it is saved. This option is off by default.

You will also be prompted to enter database information for this design. When you save a design, ArtiosCAD automatically supplies DataCenter with some information about the design, but you must specify other information such as the customer name and the designer. Your system administrator may choose to customize the information requested when saving a design. If the design is not rebuildable, specify the length, width, and depth if desired. When you are done specifying information, click **OK** to save the database information and the design.

If you have opened an existing file, when you save it, ArtiosCAD checks to see if the original file has been modified before it overwrites it. This will warn you if another user has been working on the same file at the same time to prevent accidental loss of work.

How to save a design with a different name

Click **Save As** on the **File** menu to save the current design with a new name and start working with the new workspace. Navigate to the desired folder or resource, type the new name in the **File name:** field (do not use an underscore as the last character) and click **Save**.

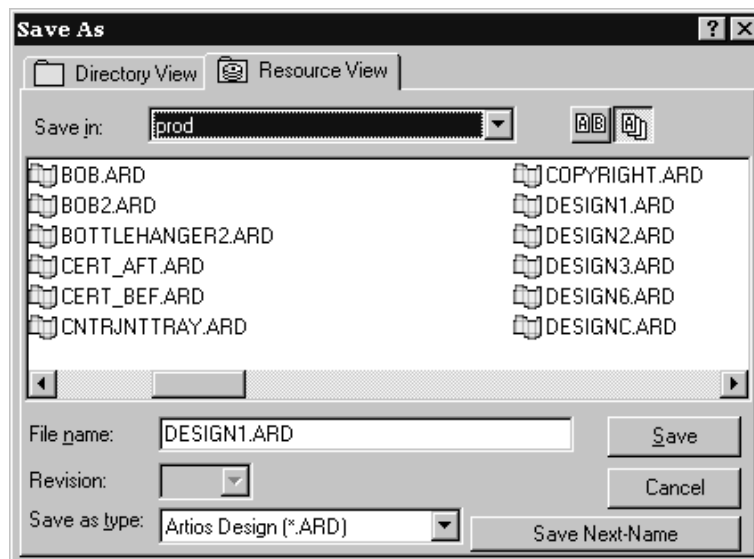

Files saved using **Save As** use the date and time at save for the creation date and revision date in the database record, regardless of the date and time at which the original file was created.

How to save a copy of a design

To save a copy of the current workspace with a new name but continue working with the current design, click **File > Save Copy As**. The Save As dialog box will appear. Navigate to the desired folder or resource, type the name for the copy, and click **Save**. ArtiosCAD will save the copy and you may resume working on the current workspace.

How to save a design using automatic numbering

To save a design using automatic numbering, you must have configured automatic numbering as described in the *DataCenter* chapter. You must also be saving the design (or manufacturing file) in a resource for which automatic numbering is configured.

Once that is set up, the **Save Next Name** button in the Save dialog box is available as shown a few sections previously. It is unavailable for resources which do not have Automatic Numbering configured. When you click **Save Next Name**, ArtiosCAD will automatically save the file with the next available number according to the configuration in DataCenter.

How to save a revision of a design

Use the **Save As Revision** command on the File menu to save different versions of the same design. Each revision of the design file shares the same basic name, but there is a progress indicator at the end of the filename before the .ARD extension. How the file name is changed

is controlled by **Options > Defaults > Startup defaults > Revision Disk File Format**; see the Defaults chapter for more information.

For example, the first time you save design REVTEST, it is saved as REVTEST.ARD. The next revision of the same design would be saved automatically as REVTEST_~.ARD, and then REVTEST_A.ARD, REVTEST_B.ARD, and so forth.

If you change the file somewhat, but still want to keep the original for reference, click **Save As Revision** on the File menu. The Save As Revision dialog box will appear.

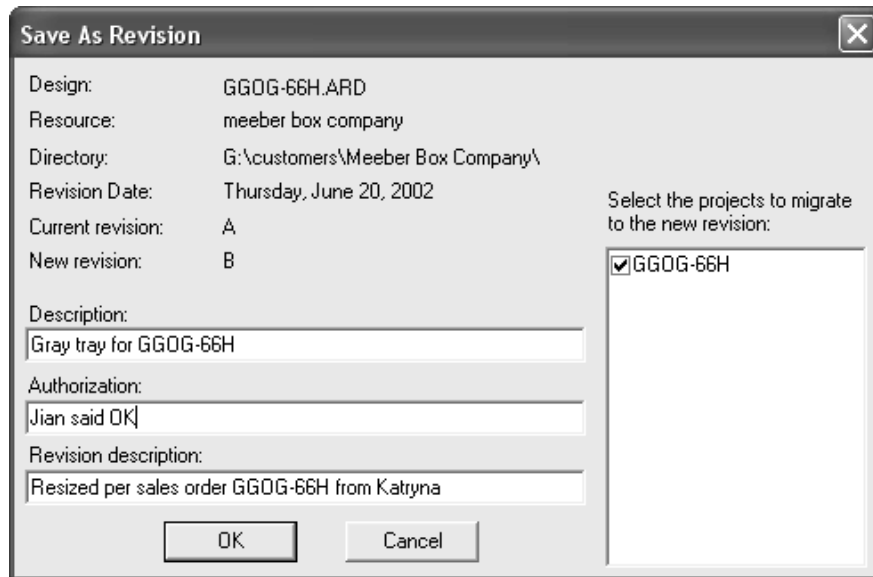

Enter a description of the file, and enter any authorization message, such as Approved by Mike or OK per JG. If desired, enter a revision description indicating what changed from the previous revision. Migrate the Projects information to the new revision by selecting the checkbox next to the Project name. To keep the Project information in the old revision, clear the checkbox next to the Project name. Click **OK** to save the file.

When it is time to open the design again, use Resource view. Resource view also allows you to view all revisions of a file, or only the most recent.

Click  to view all versions of a design.

Click  to view only the most recent revision in the list of files.

How to save a self-contained parametric design

Rebuildable ArtiosCAD designs can be made of many components. To save a rebuildable design with everything comprising it saved in the same workspace, define an Output in Defaults that has **Embed dependent files** checked on the Information Filter tab. Then use that Output to create the self-contained parametric file.

To find out which files will be included, click **Design > View Parametric Dependencies**. This menu option is available only for rebuildable designs. The View Parametric Dependencies dialog box will open and show the included components, if any, of the current rebuildable workspace. Files that are not currently marked as embedded will be automatically embedded in the workspace when the Output is run.

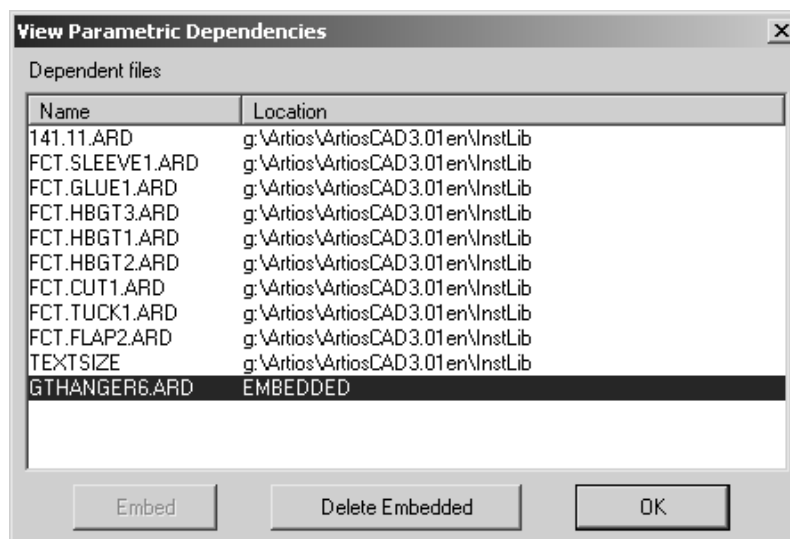

When the parametric design is rebuilt by the recipient, embedded components take precedence over local files with the same name as the embedded component.

To delete an embedded component and use the local version (if one exists - it must have the same name as the embedded component), select it and click **Delete Embedded**. You can only delete an embedded component if there is a workspace with the same name in the ArtiosCAD program directories. When you delete an embedded component, the EMBEDDED designation is replaced by the location of the component on the local system.

Self-contained parametric designs may be added to a Style Catalog and run as a standard. Any embedded components in the standard will be embedded in the resulting single design.

How to export a design to a different format

To export a design to a different file format, click **File > Export**, and then click the format in which to export the design.

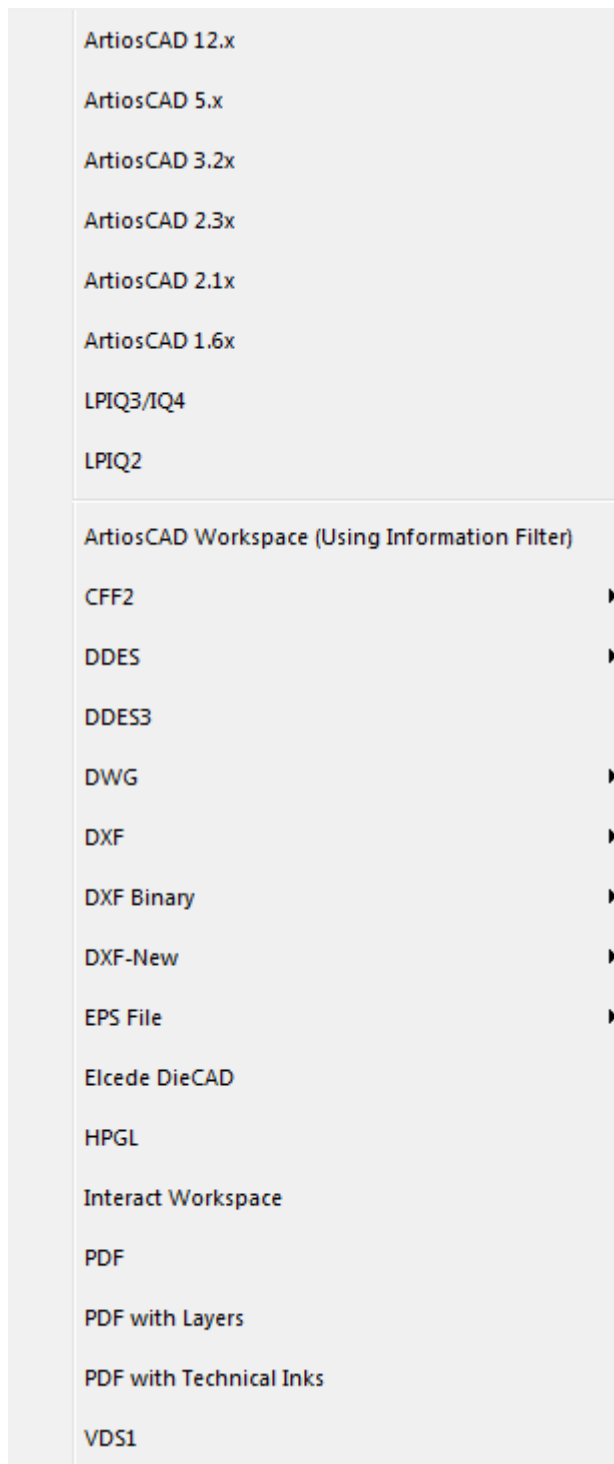

VDS1 stands for **Verein Deutsches Stanzformbauer**, a format used in Europe.

Once you have chosen a format, an Exports dialog box will appear allowing you to specify the directory/resource and filename.

All files are exported to the current directory by default. This is usually \Esko\Artios\Designs.

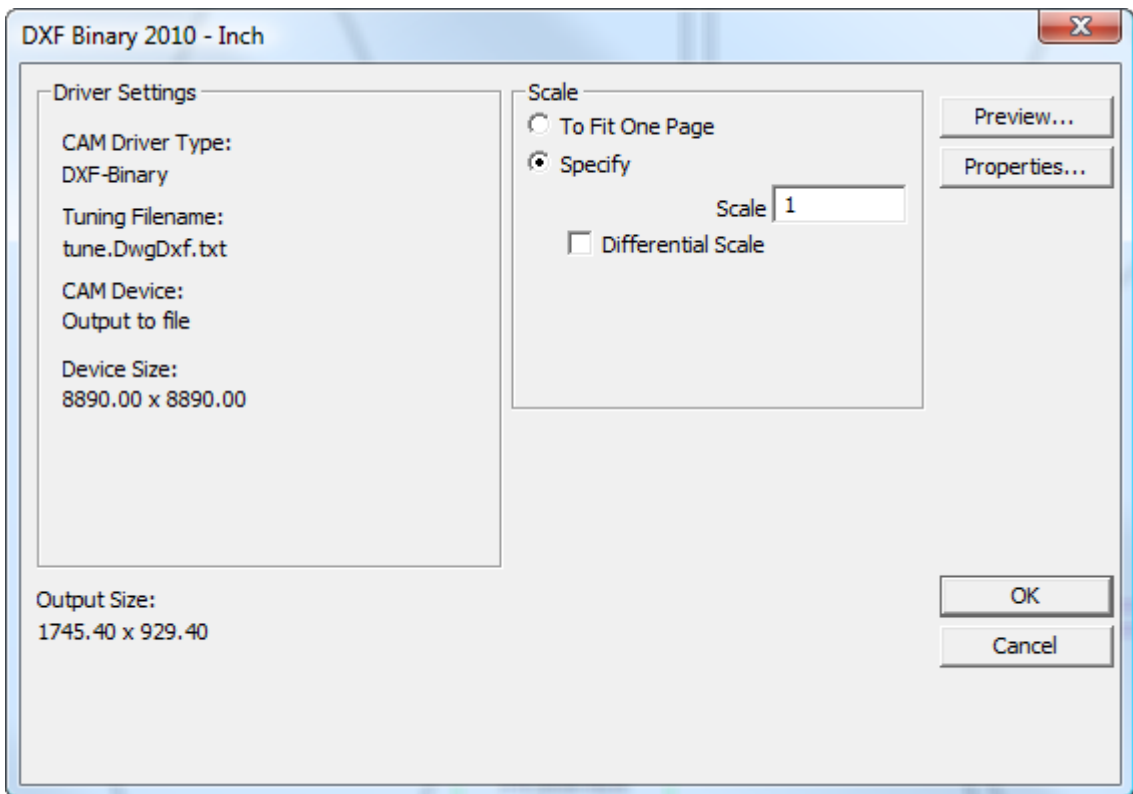

Click **OK** if the settings are correct. You may want to go through all the property sheets (by clicking **Properties**) to make sure the settings are appropriate for your needs.

After you have clicked **OK**, you will be prompted for a name for the file in the Save As dialog box. Enter a name without spaces and click **Save**. The file will be created according to the settings in the Outputs dialog box.

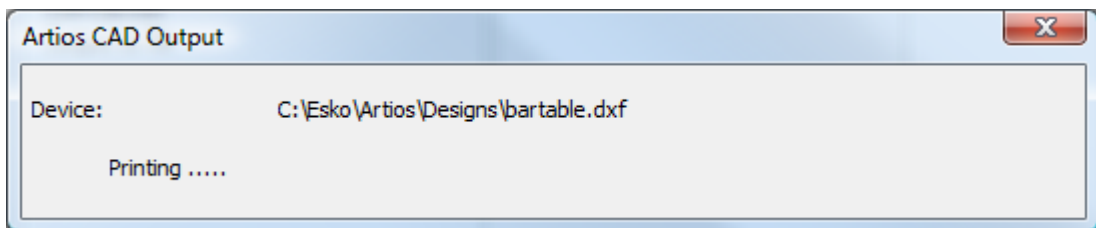

When exporting a DDES file, the Job Name is set to the first 7 characters of the file name, and A for the first subroutine, B for the second, and so on. When exporting a DDES3 file, print items are not supported, and decimal places should be set to 4 or less to ensure accuracy.

ArtiosCAD can output DXF files in different ways:

- **DXF**. This option uses the built-in method to create a DXF file.
- **DXF Binary**. This option creates a binary DXF file using a third-party library that has more features than the built-in method.
- **DXF-New**. This option creates a text DXF file using the third-party library.

When exporting an EPSF file, you can either export it as an Illustrator 3-compatible file or an Illustrator 8-compatible file. Exporting it as version 3 or 8 makes those respective versions of Illustrator treat it as a native file.

To lock a layer in EPSF files when they are output, copy `..\InstLib\tune.epsf.txt` to `..\ServerLib` and change the ninth parameter of each group of lines to 1. The tuning file may not have a ninth parameter; in that case, simply add the numeral 1 to the end of each layer's line pair if necessary. Other values such as the line color, layer name, stroke width, and so forth are controlled by the EPSF tuning file, not by the plotting style. The plotting style affects only the Output preview.

To export an EPSF file with all elements colored black, on the Device tab of the Properties dialog box of the Output, browse for the `\Esko\Artios\ArtiosCADn.nn\InstLib\TUNE.EPSF.BLACK.TXT` tuning file in the **Tuning Filename:** field.

When exporting a 3D workspace to Illustrator 8, and there are imported PDF graphics on the design, and you have the PDF option, you can set the resolution of the bitmaps in the **High graphics memory use** drop-down list box on the Device tab of the Properties dialog box for the Illustrator export.

Font notes and warnings when exporting as PDF

Only TrueType fonts are exported to PDF. TrueType fonts have this symbol  before their names. If text uses a non-TrueType font, the default font from Property Defaults is used. If the default font cannot be found, ArtiosCAD will use Arial. The output preview will show non-TrueType fonts correctly but they will be replaced in the actual PDF file.

Graphic fonts such as Symbol and WingDings are not supported.

Fonts defined in .ttc files are not supported.

Fonts with vertical text (those with @ preceding their names) are not supported.

Data Exchange Plug-In

The Data Exchange Plug-In lets Adobe Illustrator users open or place native ArtiosCAD single design workspaces without the need for the ArtiosCAD user to convert to EPSF. There also are dedicated tools for moving the entire CAD structure within Illustrator and aligning graphic elements to it. The plug-in can be downloaded from Esko's Web site at <http://www.esko.com>.

The plug-in works with structural data only. It does not read bitmap images, fills, or manufacturing line types into the Illustrator workspace.

For more information on the plug-in, refer to the documentation that is included in its installation package.

How to export files to the ArtiosCAD Viewer

No special export is needed for the ArtiosCAD Viewer. It can open native .ARD and .A3D files.

ArtiosCAD workspaces are binary, not text.

How to export files to previous versions of ArtiosCAD

If you need to send designs to people using earlier versions of ArtiosCAD, you need to export them so that their versions will read your files properly. In some cases, information like manufacturing parameter sets will have to be reselected by the recipients.

To export the file, click **File > Export**, and choose the software version that is less than or equal to the recipient's software.

If you need to strip information out of the files, use the Information Filter.

Exporting Splines to a DXF/DWG File

If you have imported a DXF/DWG file containing splines of degree 4 to 7, ArtiosCAD can export them to a new DWG/DXF file. There are a few things you need to do for this to work.

1. In the workspace you are exporting, if arcs were originally splines, they export as splines if the original spline had a single segment and the number of control points equaled the degree plus 1, AND the arcs are intact and not split by nicks or bridges.
2. Modify the DXF tuning file, tune.DwgDxf.txt. It is prudent to save a backup copy of the original. It lives in ..\Esko\Artios\ArtiosCAD_version\InstLib if you use Standard Edition or in the **InstLib** folder of the Shared Defaults Project of the version of ArtiosCAD Enterprise you are using (don't forget to change the **Files of type** drop-down list box to all files so it appears in the file list). Add a space and the number 1 to the end of the first uncommented line of the file. Change this:

```
#ExportTuning V2.0 DXF          Version header
# Comments start with #
# placesinch placesmm icorner rotnegtrans round64ths centerorigin offsetedgetypes
5 3 0 0 1 1 0
```

to this:

```
#ExportTuning V2.0 DXF          Version header
# Comments start with #
# placesinch placesmm icorner rotnegtrans round64ths centerorigin offsetedgetypes
5 3 0 0 1 1 0 1
```

3. Check the driver for the DXF or DWG output you are using. On the **Device** tab, **CAM Driver** in the Tuning Entry group must be set to **DXF-New** or **DWG**.

You only need to check items 2 and 3 once.

If all the conditions are met, you should have a successful spline output.

Right mouse button functionality

Clicking the right mouse button activates a context menu from which you can perform common tasks.

Single Design

In Single Design, the first click of the right mouse button ends the current tool and activates the Select tool. If there is an object under the cursor, the second click of the right mouse button selects the object and opens a context menu as shown below.

<u>D</u> delete	Delete
Cu <u>t</u>	Ctrl+X
<u>C</u> opy	Ctrl+C
<u>P</u> aste	Ctrl+V
Properties...	Alt+Enter
Property Defaults...	

The **Paste** command appears only if something has been previously cut or copied.

If there is nothing under the mouse cursor when the right mouse button is clicked, and nothing is selected, a general context menu is opened similar to the one shown below.

Plotting styles	▶
Turn On/Off Designs	
High graphics mode	
Bridges	
Nick gaps	
Crease cutback	
<input checked="" type="checkbox"/> Construction Lines	
Refresh	F2
Apply Defaults	▶
Rule Length	
Blank Size	
Area	
Board Information	

Plotting styles which have the **Output only** checkbox selected in their definition in Defaults will not appear in this context menu.

Canvases

Canvases have four context menus whose contents depend on the location of the mouse cursor. Commands on these menus act on what is beneath the cursor.

When it is in the canvas, not over any part:

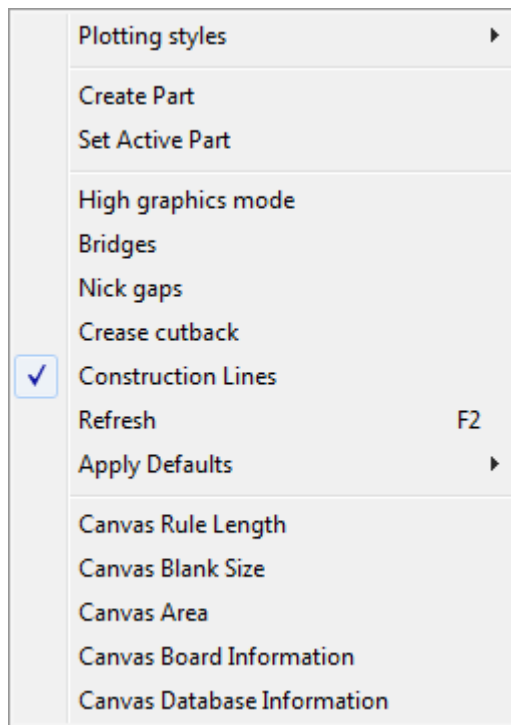

When it is in the active part, but not over a line:

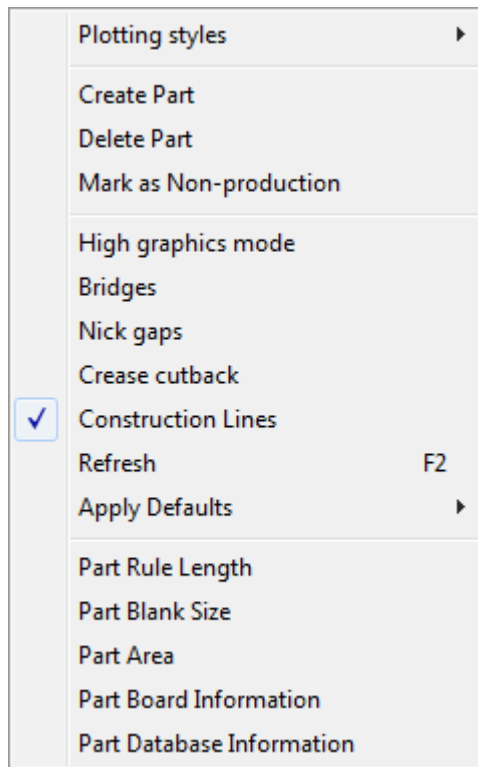

When it is in the active part, over a line:

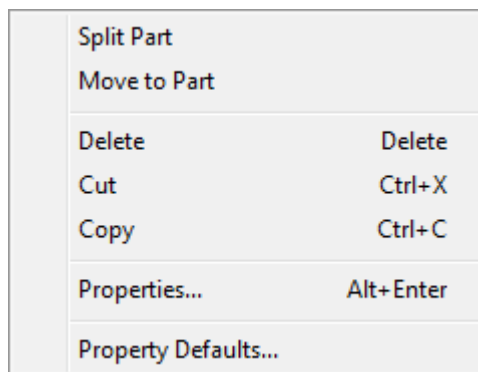

When it is in a non-active part:

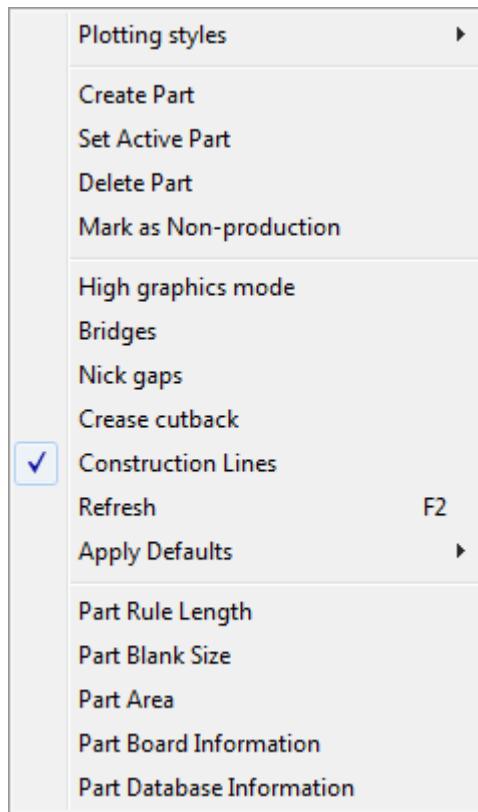

Anywhere over a layout part:

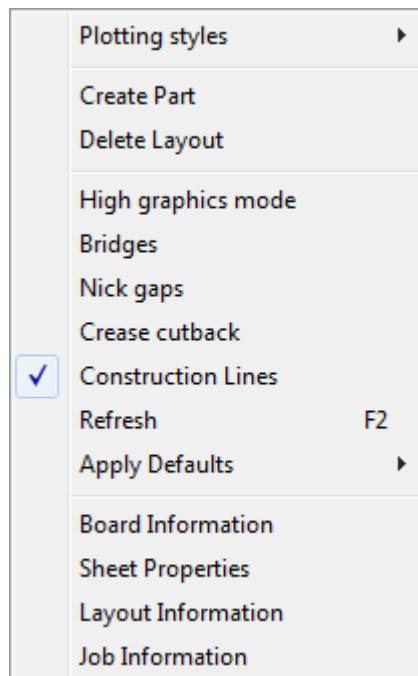

Manufacturing

Clicking the right mouse button in Manufacturing stops the current tool but does not automatically start the **Select** tool.

When the **Select** tool is active in Manufacturing, clicking the right mouse button has the same functionality as it does in Single Design.

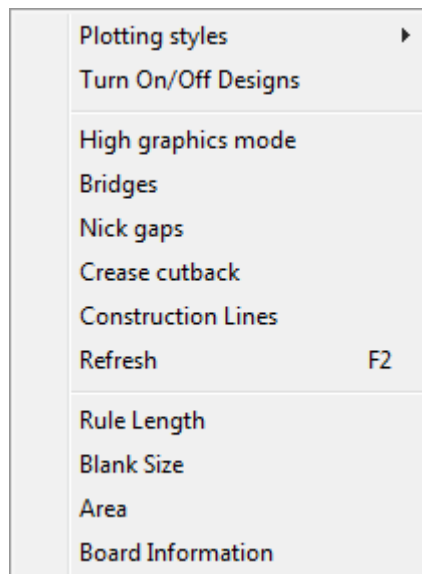

3D

Clicking the right mouse button in 3D when the cursor is over a design line stops the current tool, selects the object under the cursor, and opens the context menu shown below.



When there is no current selection and the cursor is not over a design line, a context menu for accessing common commands appears as shown below.

Refresh	F2
Zoom in/out	
Scale to Fit	Ctrl+D
Pan	
View Angle	
Rotate Right	
Rotate Down	
Orthogonal view	
Light source	
✓ Solid	
Solid with edges	
Lighter color with edges	
Hidden lines removed	
Wire frame	
✓ Perspective	
✓ Board thickness	
✓ Graphics	
Transparent	
Creases pink	
Bounding Box	

Using the spell checker

If you have Microsoft Word 2000 or later installed on your system, ArtiosCAD can use its spell checking functionality in Single Design and Manufacturing in most places where you enter text using a field in a dialog box. As you type, specific keystrokes trigger the spell check: Backspace, Enter, Space, exclamation point, close parenthesis, comma, period, semicolon, question mark, and close brace.

There are three ways to use the spell checker. The first is by using the Paragraph Text tool. The second is by entering text in fields in the Database Information dialog boxes, both default and custom, and other text-entry field such as those in the Properties dialog boxes for text and dimensions. The third is by executing a document-wide spell check by clicking **Tools > Check spelling**.

To learn more about using the spell checker in the Paragraph Text tool, see *Spell checking in the Paragraph Text tool* for more information.

Spell checking in fields

Fields that support spell checking have an emphasized border, and any misspelled words within them are underlined and shown in red. Right-click in the field and choose **Spell** from the context menu to open the Spelling dialog box.

Manufacturing Database Information

General
 Name: ANGEL1 WITH INSIDE AND OUTSIDE G Date Saved: Friday, October 07, 2005
 Resource: Revision Date: Friday, October 07, 2005
 Directory: .\ Revision #: 0

Database
 Customer: Plastic Angel Containers, Clairman Town
 Owner: Parrish Studios, Plainfield
 Salesperson: Foster, Katryna
 Designer: Ghomeshi, Nerissa
 Description: Purchase order #2-4-96
 Authorization: Yes
 Rev. Description: Initial revision

Manufacturing
 Sheet Width: 63
 Sheet Length: 43+1/4
 Diecutter: Example die press - l
 Printing Press: Example printing press - Inch

Vertical User Fields
 OK Skip DB Cancel

Context menu: Undo, Cut, Copy, Paste, Delete, Select All, Spell

Properties

Text
 Arial 24.00 A B I

Calculated for report

Expand Kerning: 0
 Horiz. Scaling: 1
 Rotate: 0.00

Text: Glue the **screed** areas only

Context menu: Undo, Cut, Copy, Paste, Delete, Select All, Spell

OK Cancel

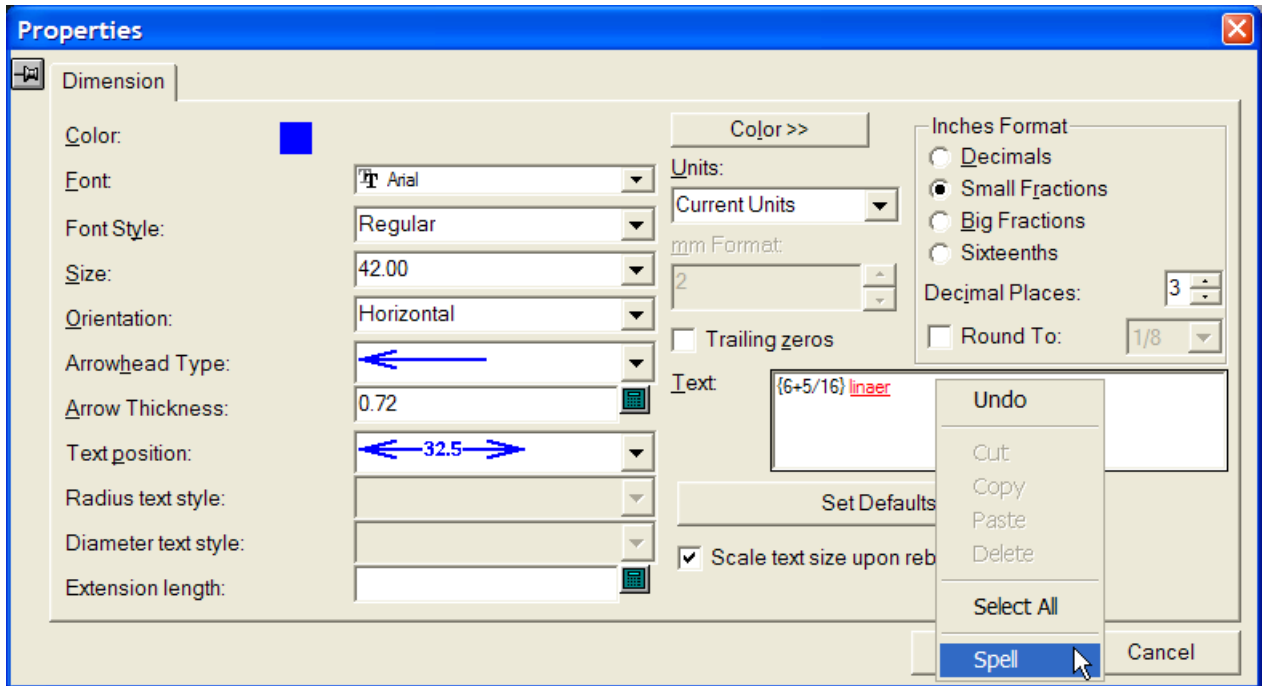

The first time you activate a tool or dialog box in ArtiosCAD that supports spell check, ArtiosCAD launches Microsoft Word in the background and communicates with it as needed during the ArtiosCAD session. This initial launch of Microsoft Word may cause the ArtiosCAD dialog box to take a few extra moments to open, depending on the speed of your system. Once Microsoft Word is running in the background, dialog boxes supporting spell check appear at their usual speed.

When you right-click a field and choose **Spell**, the standard Microsoft Word Spelling dialog box appears as shown below.

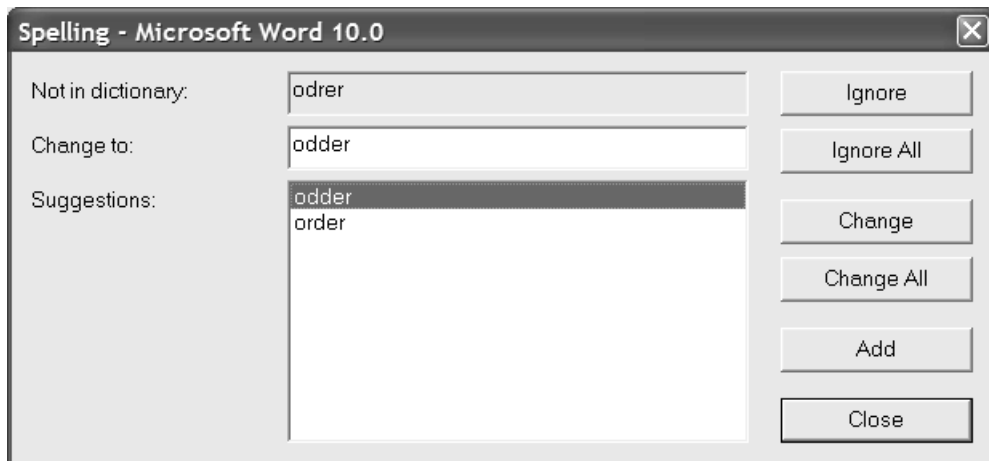

The unrecognized word is shown in the **Not in dictionary:** field. The **Suggestions:** field contains the list of suggested words, and the top one is selected and seeded to the **Change to:** field. If there are no suggestions, the unrecognized word is repeated. You can edit the contents of the **Change to:** field as desired.

Ignore and **Ignore All** respectively ignore this instance and all subsequent instances of the unrecognized word for this invocation of the spell checker. The next unrecognized item is then displayed.

Change changes the unrecognized word to the selected suggestion or the word you entered in the **Change to:** field. **Change All** changes all subsequent instances of the unrecognized word in the workspace to the selected suggestion or the word entered in the **Change to:** field; previously-ignored instances are not changed. The next unrecognized item is then displayed for review.

Add adds the unrecognized word to the ArtiosCAD custom dictionary file so that it will be recognized in the future. The next unrecognized item is then displayed. This command is disabled if the custom dictionary is not installed or is not editable.

Close closes the Spelling dialog box.

Spell checking through the whole workspace

You may also spell check all text items in the workspace by clicking **Tools > Check Spelling**. Note that this method does not check database entries for unrecognized words. This tool is available regardless of the state of the **Enable spell checking** option in Defaults.

When this tool is activated, each text item in the workspace is checked for unrecognized words, including text items in locked layers. If an unrecognized word is found, the entire text item is shown with the unrecognized word underlined and shown in red as shown below.

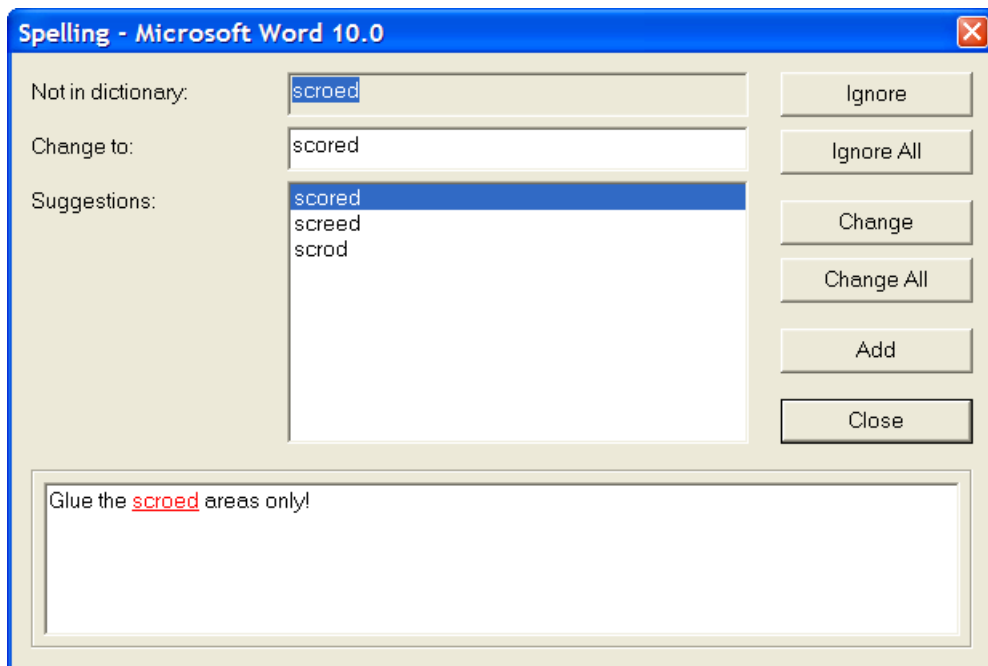

The options in this dialog box work the same way as described in the previous section.

Once you ignore, change, or add an unrecognized word, the next text item is checked. When all text items have been checked, **Close** is the only available option in the Spelling dialog box.

Notes about spell checking

The spell checker does not flag repeated words.

When you exit ArtiosCAD using **File > Exit**, ArtiosCAD terminates the associated Microsoft Word process. If ArtiosCAD terminates abnormally, the Microsoft Word program **WINWORD.EXE** may still be left running; use Task Manager to end it. If you then launch Microsoft Word using the Start menu, it may show ArtiosCAD Spell Check(number).doc as being available for auto-recovery as shown below. No such temporary files need to be recovered or saved, and you may delete them from the hard drive.

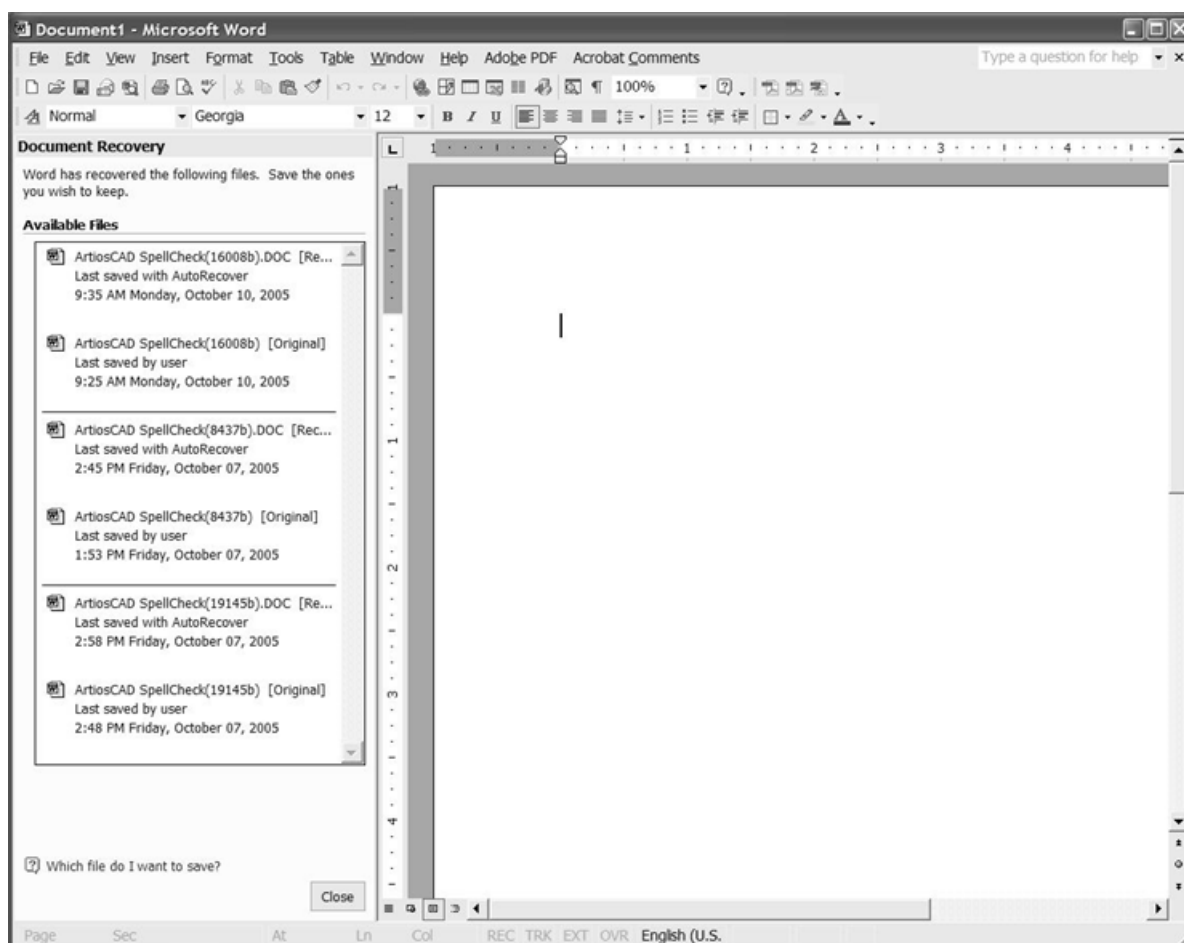

These temporary files are the means by which ArtiosCAD interfaces with Microsoft Word to check spelling. If you are using Microsoft Word at the same time that ArtiosCAD is running, the temporary file may be shown on the Window menu in Microsoft Word. Do not open the temporary file, as this will break the connection between ArtiosCAD and Microsoft Word, and spell checking in ArtiosCAD will be disabled until you reactivate the tool which invoked it.

The custom dictionary file CUSTOM.DIC is stored in \ArtiosCAD installation folder\Common \Proof. To edit it, close ArtiosCAD and use WordPad (not Notepad) to edit it. Put each word on a

separate line and save the file as type **Text Document**. Do not change this file while ArtiosCAD is running, as it will not reflect the changes.

Publishing ArtiosCAD documents to WebCenter

Publish to WebCenter on the **WebCenter** menu allows you to publish a single design, a manufacturing file, or a 3D workspace to WebCenter, Esko's design lifecycle management software. Shown below is the menu in Single Design.

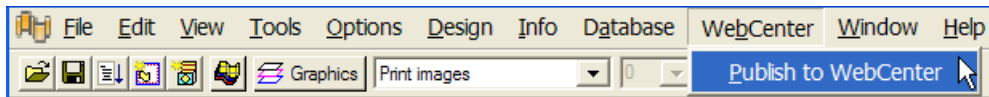

Before you can publish to WebCenter, the ArtiosCAD system administrator must have configured an WebCenter site in the WebCenter catalog in Defaults, and the WebCenter system administrator must have created a user account with sufficient permissions for you to use. When ready, publish to WebCenter by doing the following:

1. Open the desired document in ArtiosCAD.
2. Click **WebCenter > Publish to WebCenter**.
3. If ArtiosCAD is configured to prompt for information, the Publish to WebCenter dialog box appears. If prompted, enter the WebCenter username and password supplied to you by the WebCenter system administrator. The **Document**, **Project**, and **Folder** fields are completed by default to be based on the name and type of the ArtiosCAD document.

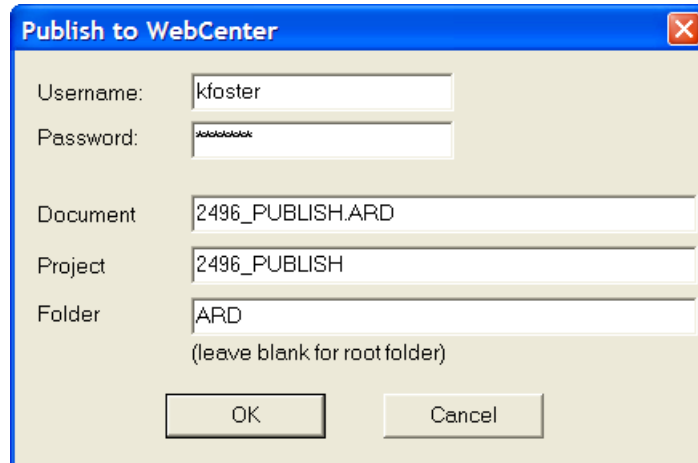

The ArtiosCAD system administrator can define the **Publish to WebCenter** entry in Defaults so that all, some, or none of these fields are pre-completed.

Click **OK** to publish the document to WebCenter once all the fields are completed.

4. If the document already exists in the specified Project, you will be prompted to enter a comment about the new version as shown below. Enter a comment and click **OK**.

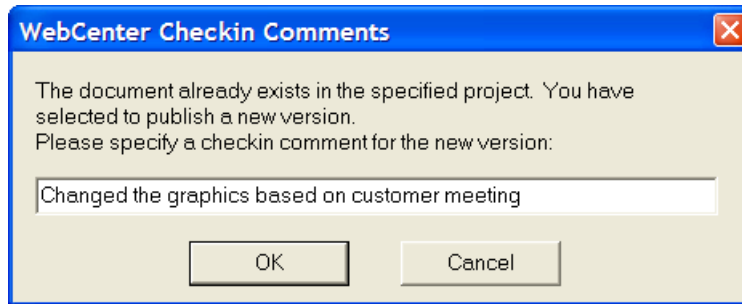

5. The Publish to WebCenter dialog box should change to match the one below.

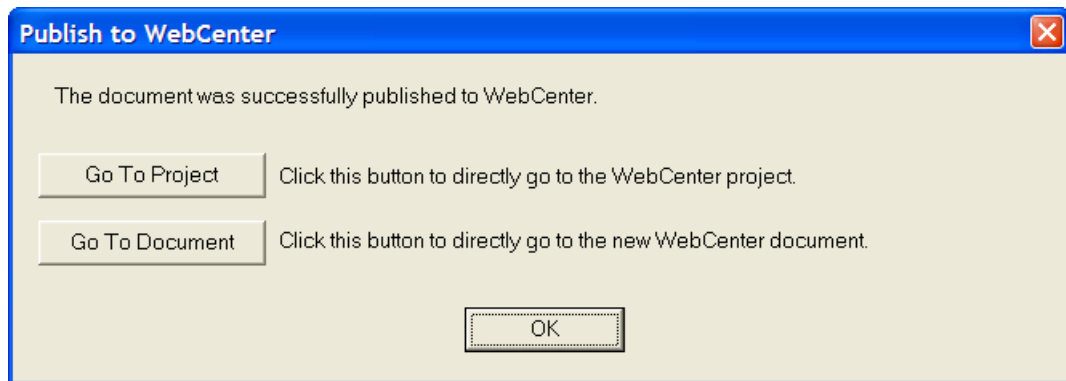

Clicking **Go To Project** opens the Project in WebCenter. You must log in to WebCenter if you are not already logged in.



Welcome Artios!

[Home](#)
[Contact](#)
[Log Off](#)

WebCenter

[My Work](#)
[Projects](#)
[Search](#)
[My WebCenter](#)

Project - 2496_PUBLISH
[Create a new project](#)



Project: [2496_PUBLISH](#)

Description:

Project Actions

[Add to Cart](#)

[Mail To...](#)

[Add to Favorites](#)

[Update](#)

[Documents](#) |
 [General Information](#) |
 [Approval Settings](#) |
 [Characteristics](#)
[Attributes](#) |
 [Tasks](#) |
 [Discussions](#) |
 [Members](#) |
 [Security](#)

Total Documents 1
[Hide Thumbnails](#)
Page 1 of 1

Folders (2)	<input type="checkbox"/>	Documents (0)	Upload Document	Version	Approval	Locked by
<div style="background-color: #e0e0e0; padding: 2px; margin-bottom: 5px;">Project Documents (0)</div> <div style="margin-left: 20px;"> <div style="background-color: #e0e0e0; padding: 2px; margin-bottom: 5px;">ARD (1)</div> </div>						

Total Documents 1
[Hide Thumbnails](#)
Page 1 of 1

WebCenter by [Esko](#) - Version 6.01 - Build 249

Clicking **Go To Document** opens the document. You must log in to WebCenter if you are not already logged in.

The screenshot shows the WebCenter interface. At the top, there is a green header bar with the 'WebCenter' logo. Below it, a navigation bar contains 'Welcome Artios!', a shopping cart icon, and links for 'Home', 'Contact', and 'Log Off'. A secondary navigation bar includes 'WebCenter', 'My Work', 'Projects', 'Search', and 'My WebCenter'. The main content area is titled 'Document - 2496_PUBLISH.ARD'. On the left, there is a 3D wireframe model of a box. To the right, the document details are listed: Document: 2496_PUBLISH.ARD, Version: 1, Description: (empty), Project: 2496_PUBLISH, and Approval: No Approval Required. A 'Document Actions' menu is visible with options: Open, View and Annotate, Mail To..., Add to Cart, Download, and Lock. Below the details, there are navigation links: Design Information | General Information | Approval Settings | Action History | **Projects** | Attributes | Discussions. At the bottom, a table lists project information:

Project Name	Description	Manager	Customer
 2496_PUBLISH		CAD, Artios	

At the very bottom of the page, a footer bar reads: 'WebCenter by Esko - Version 6.01 - Build 249'.

Click **OK** to stay in ArtiosCAD.

In the rare event that the document does not appear in WebCenter and no error is shown, check that the **WebCenter address** field in the **Publish to WebCenter** entry of the WebCenter catalog in Defaults is correct.

Portable Workstation mode

Portable Workstation mode lets an ArtiosCAD system using shared network resources such as the database or Shared Defaults detach from the network and operate as if it were standalone with no database. When you enter Portable Workstation mode, ArtiosCAD copies

necessary elements from the network servers to the local machine (called **synchronizing**) and disables the database.

Note: Detaching ArtiosCAD from the network servers does not actually break the network connection for other applications in the operating system.

There are important restrictions when using Portable Workstation mode:

- Using Portable Workstation mode requires local licensing; that is, a License Manager client may not use Portable Workstation mode. Upon attempting to enter Portable Workstation mode, the licensing will be checked and you will be prevented from entering it if the licensing method does not support it.
- Any workspaces needed that normally reside on network resources must be manually copied to the local system. Likewise, anything extra data needed (symbols, graphics, Reports, and so forth) that are not in ServerLib or Common must also be copied manually. Subdirectories of ServerLib and Common are copied (except for Common\Program).
- If you changed the search list in the Windows Registry, the changes are ignored.
- When reconnected to the network, you must resave any workspaces created while in Portable Workstation mode in resources to put them into the database.
- Detaching from the network is done on a per-user and per-ArtiosCAD-version basis. For example, if you plan to use more than one version of ArtiosCAD while disconnected from the network, you must synchronize and detach each version before disconnecting from the network. Likewise, each user on the machine must detach each version of ArtiosCAD that he or she will use while detached.
- If the **Start in** property for any ArtiosCAD icon is set to a network location, it must be changed to a local drive. Right-click the icon, click **Properties** on the context menu, examine the contents of the **Start in** field, and change it to a directory on the portable workstation's drive (such as C:\temp) if it points to a network drive (S:\users\wmeeber\CAD) or a UNC location (\\mbcfileserv\users\wmeeber\CAD).
- DataCenter Admin uses the database specified by the System DSN ODBC data source regardless of the state of Portable Workstation mode. If you use a network database and detach from the network, DataCenter Admin will continue to function until the network is disconnected. If you detach and disconnect from the network and use a local database, DataCenter Admin will continue to function using your local database if you change the System DSN to point to your local database. If you do not use a local database after detaching and disconnecting from the network, DataCenter Admin will not function correctly as it will be searching for the networked database. Do not start DataCenter Admin if you will not be using a local database when disconnected from the network.

Using Portable Workstation mode for the first time

Using Portable Workstation mode for the first time involves performing required tasks that are not required with subsequent uses.

Detaching from the network

To use Portable Workstation mode and detach from the network for the first time, do the following:

1. Make sure the network is connected to the computer.

2. If necessary, change the **Start in** property for the ArtiosCAD icon.
3. Start ArtiosCAD.
4. Click **Options > Portable Workstation > Detach from Network**.
5. The Portable Workstation Tasks dialog box will open as shown below.

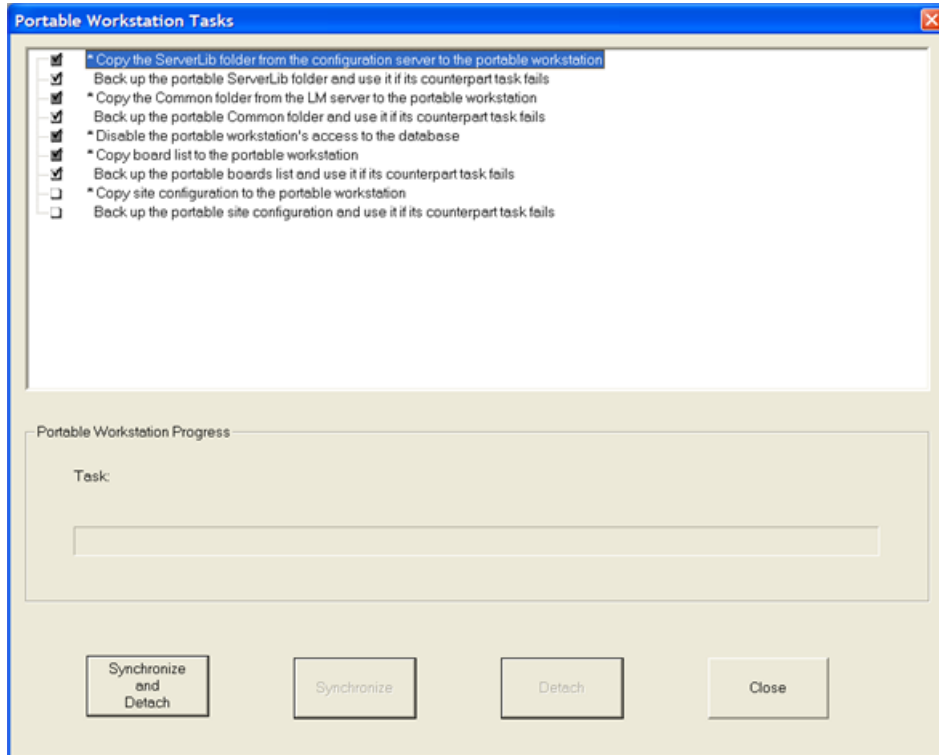

6. A list of tasks is displayed.
 - Selected tasks have checks in their associated checkboxes.
 - Grey checkboxes may not have their state changed.
 - White checkboxes may be changed as desired.
 - Tasks with an asterisk (*) before their names must complete successfully for the workstation to enter portable mode.
 - Tasks have different default states for the first time they are run versus being run after a successful detach.

In general, there are two kinds of tasks, **copy** tasks and **back up** tasks. Copy tasks copy data from the network servers to the local machine. Back up tasks make backups of the copied data on the portable workstation in case it becomes corrupted and unusable. Each copy task has a corresponding backup task. The **Disable the portable workstation's access to the database** task neither copies nor backs up.

Table: Tasks and Their Actions

Task	Action	Can be skipped if
Copy the ServerLib folder from the configuration server to the portable workstation	Copies the Shared Defaults and shared files (such as custom Reports) from the Configuration server. If the portable workstation is configured as its own standalone Configuration server, the information and files are copied to another location on the portable workstation.	<p>You have recently synchronized and you are confident it meets your needs.</p> <p>ArtiosCAD is installed as standalone or as a Configuration server and thus uses its own set of Defaults and shared files.</p>
Copy the Common folder from the LM server to the portable workstation	<p>Copies the files from ..\Artios\Common on the License server to the portable workstation. This copies licensing information and board textures. This task must be selected if the workstation is not its own License server and uses a security key. No subdirectories are copied. Previous copies are deleted each time this task runs.</p> <p>Note: The only kind of licensing that will work with Portable Workstation mode and a networked License server is when there is a hardware key physically attached to the portable workstation and the TUNEOPT7.TXT is stored on the License server. If you are in this mode, you must run this task.</p>	<p>You have recently synchronized and you are confident it meets your needs.</p> <p>ArtiosCAD is installed as standalone or as a License server and thus uses its own set of Common files.</p>
Disable the portable workstation's access to the database	Ensures no database connection is attempted when opening or saving a workspace, and disables all database-related fields and dialog boxes except for boards. This includes the Database dialog box in Defaults, the Database Information dialog box in Single Design, Layout, and Manufacturing modules, AutoLoad, the three database browsers, Projects, Search on the File menu, and the Resource View tab in the Open dialog box.	You have a local database you want to use after detaching from the network, which would require changing the ArtiosCAD System DSN ODBC entry.

Task	Action	Can be skipped if
Copy board list to the portable workstation	Copies the boards, board hierarchy, mediums, and flutes from the Database and License servers to the portable workstation.	You have recently synchronized and you are confident it meets your needs. ArtiosCAD is installed as standalone or as a License server and a Database server.
Copy site configuration to the portable workstation	Copies custom User Defaults used for "site" defaults that are stored in a network location to the portable workstation.	You do not use networked User Defaults in such a manner.
Back up...	Makes a backup copy of the information being copied from the network. These backups can then be used in the event of a failure of a future synchronization. Each time there is successful synchronization, the previous backups are deleted if the corresponding backup task was selected.	You have previously successfully synchronized and backed up the copy tasks.

Beneath the list of tasks is a progress indicator for the current task.

Beneath the task progress indicator are four buttons.

- **Synchronize and Detach** performs the selected tasks and prepares ArtiosCAD for the network to be disconnected. Note that the actual network connection is not changed; that you must do outside of ArtiosCAD. We strongly recommend running all the selected tasks the first time you enter Portable Workstation.
 - **Synchronize** performs the selected tasks but does not prepare ArtiosCAD for the network to be disconnected. This command is available only after the first Synchronization and Detach.
 - **Detach** detaches the computer from the network. You must perform a Synchronize before using Detach.
 - **Close** closes the dialog box. Close changes to **Cancel** when a task is running. If you click Cancel, all tasks are cancelled and the state of ArtiosCAD is rolled back to how it was when the dialog box opened.
7. Click **Synchronize and Detach** once you have reviewed the tasks to run. The selected tasks will run and result indicators will appear next to each task similar to those shown below.

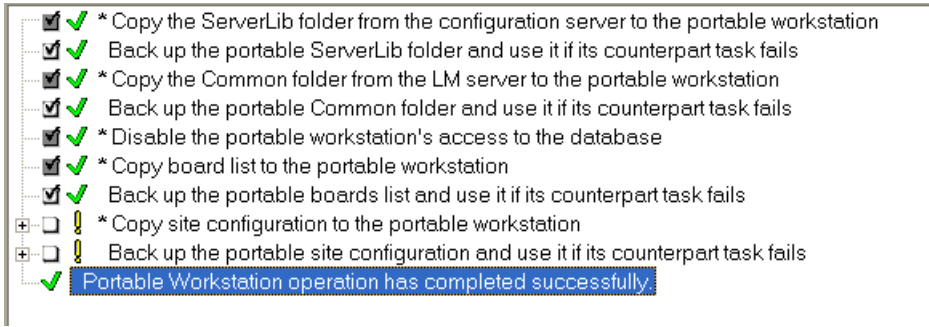

8. ArtiosCAD is now running in Portable Workstation mode. Use it as desired. To use a local database, change the ArtiosCAD ODBC entry and restart ArtiosCAD.

Some tasks may have different result indicators than those shown in the preceding example.

Table: Task Result Indicators

Icon	Meaning
	A green arrow means the task is running.
	A green checkmark means the task succeeded.
	A red X means the required task failed and the workstation cannot enter Portable Workstation mode.
	A red exclamation mark means a non-required task failed, but the workstation can enter Portable Workstation mode. This is mostly used for back up tasks.
	A yellow exclamation mark means a task succeeded, but there is a note. Click the plus sign (+) next to the task to see what happened. This is mostly used when a task is not selected.
	A green exclamation mark means a non-required task succeeded, but there is a note. Click the plus sign (+) next to the task to see what happened. This is mostly used when a back up task has succeeded.
	A yellow question mark means the task is in an unknown state. This is mostly used when a task is not selected for synchronization.

If a task was successfully synchronized for a Detach, it will always succeed for subsequent Detaches.

Backup tasks that fail synchronization do not prevent the workstation from entering Portable Workstation mode.

If a required task fails, the workstation can still enter Portable Workstation mode provided its corresponding backup task has been synchronized in a prior Detach.

If a task fails to synchronize, a future Detach will not allow it to Detach until it is successfully synchronized.

Attaching to the network

When you no longer need to use Portable Workstation mode and want to set ArtiosCAD back to its networked state, do the following.

1. Reconnect the physical network connection.
2. Start ArtiosCAD.
3. Click **Options > Portable Workstation > Attach to Network**.
4. The Portable Workstation Tasks dialog box appears similar to the one shown below.

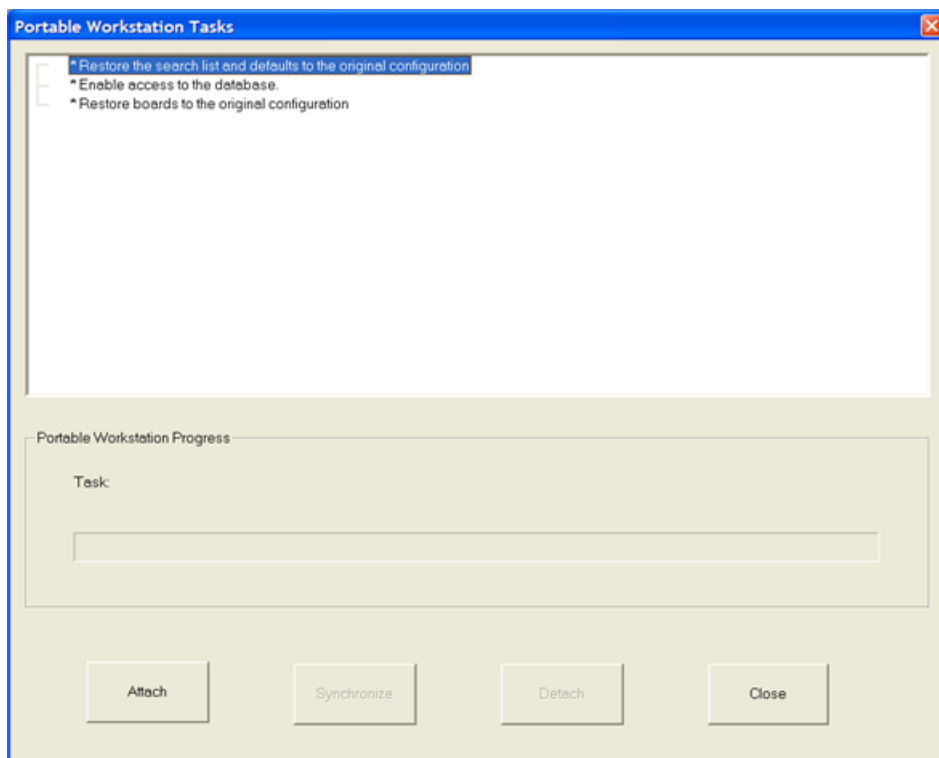

5. Click **Attach** to reconnect ArtiosCAD to its networked resources. The tasks will run and result indicators will appear next to the tasks similar to those shown below.

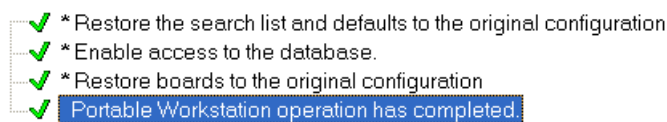

6. Click **Close** to close the Portable Workstation Tasks dialog box.
7. Open any workspaces you made while in Portable Workstation mode and resave them into resources, entering database information as necessary.

8. Resume working with ArtiosCAD as desired.

Subsequent uses of Portable Workstation mode

After you have used it once, on subsequent uses of Portable Workstation mode, you can choose the tasks to perform when detaching. Most of them are still selected by default. **Synchronize** and **Detach** are both independently available.

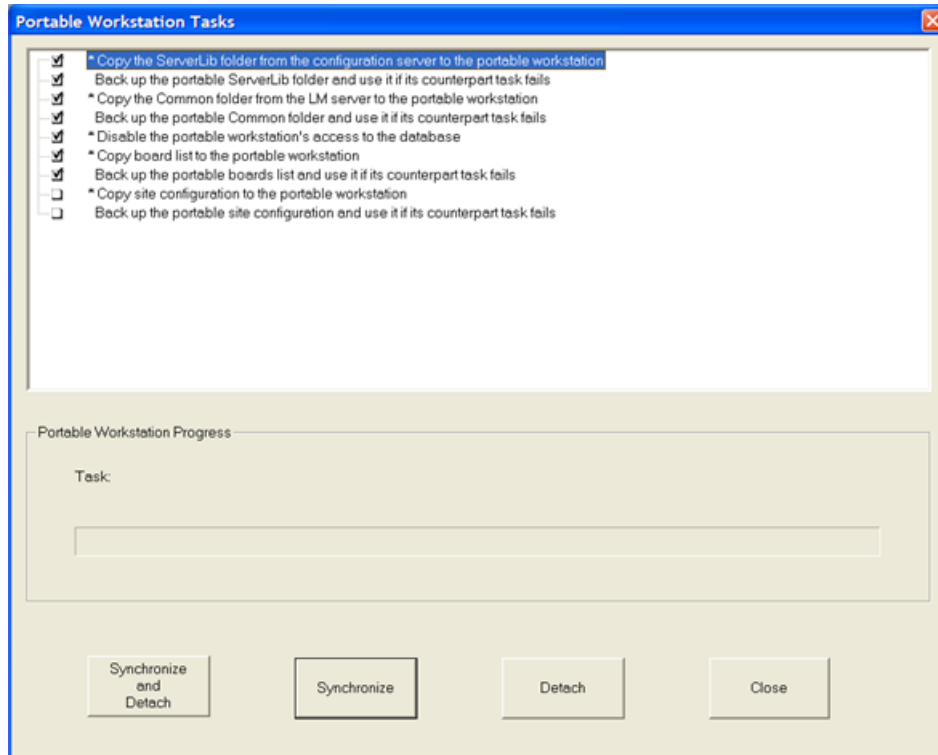

If you are confident that no network information has changed since you last Synchronized, you can Detach without performing a Synchronize first. Correspondingly, if you want to update the local copies of the network information, you can Synchronize without performing a Detach. Shown below are the results of Detach without a Synchronize with all the information shown.

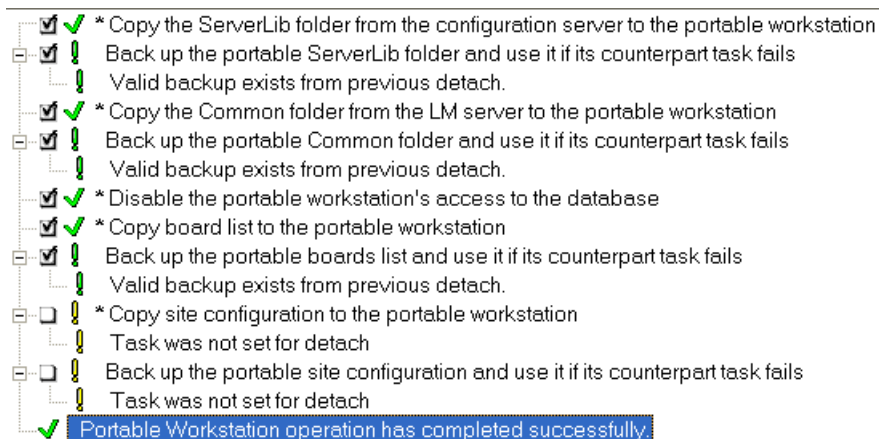

Attaching to the network in subsequent uses of Portable Workstation mode is the same as it was the first time. To attach to the network, do the following:

1. Reconnect the physical network connection.
2. Start ArtiosCAD.
3. Click **Options > Portable Workstation > Attach to Network**.
4. In the Portable Workstation Tasks dialog box, click **Attach** to reconnect ArtiosCAD to its networked resources. The tasks will run and result indicators will appear next to the tasks.
5. In the Portable Workstation Tasks dialog box, click **Close**.
6. Open any workspaces you made while in Portable Workstation mode and resave them into resources, entering database information as necessary.
7. Resume working with ArtiosCAD as desired.

Limits in ArtiosCAD

ArtiosCAD has the following overall limits:

Item	Limit
Number of layers in designs	251 (including Main Design)
Number of layers in manufacturing workspaces	100
Number of parts in canvases	250 (149 when using Convert to Canvas)
Number of unique parts per layout sheet	99
Copies per production part in a canvas (note that this is independent of all other functions and is meant only to facilitate faster layout-making)	250
Copies of a layout part (more sheets)	unlimited
Layouts per job in a canvas	20
Items per layout in a canvas	300
Print items per workspace	250
Special rules per workspace	39
Colors per workspace	999
Fonts per workspace	39
Number of variables per workspace	260,000
Field variables per workspace	200,000
Number of duplicated designs to which you can add holes using Add Hardware in 3D	40 or fewer
Number of holes per panel Add Hardware can create in 3D	500

Item	Limit
Total number of holes per design created by Add Hardware	1,000
Cumulative hardware part counts per canvas	250,000,000

10. Introduction to ArtiosCAD Enterprise

ArtiosCAD Enterprise continues its history of providing robust project management features to the world's best-selling, most popular structural design software for packaging.

Before you can start using ArtiosCAD Enterprise, your system administrator must provide you with a username and password. These are only for ArtiosCAD Enterprise; they are not your operating system or network login credentials.

Concepts

For Project and file management, ArtiosCAD Enterprise works with *managed* files, which are stored in Projects in WebCenter. Managing your design files with ArtiosCAD Enterprise helps you to reach your business goals faster with less error.

Note:

You can also work with unmanaged files that are saved directly on a hard drive instead of through the managed file interface.

Logging In For The First Time

Logging in for the first time is a straightforward process but can take a few minutes to configure a license and if you set up your system to work with Defaults.

1. Launch ArtiosCAD Enterprise.

The ArtiosCAD Enterprise login dialog box appears.

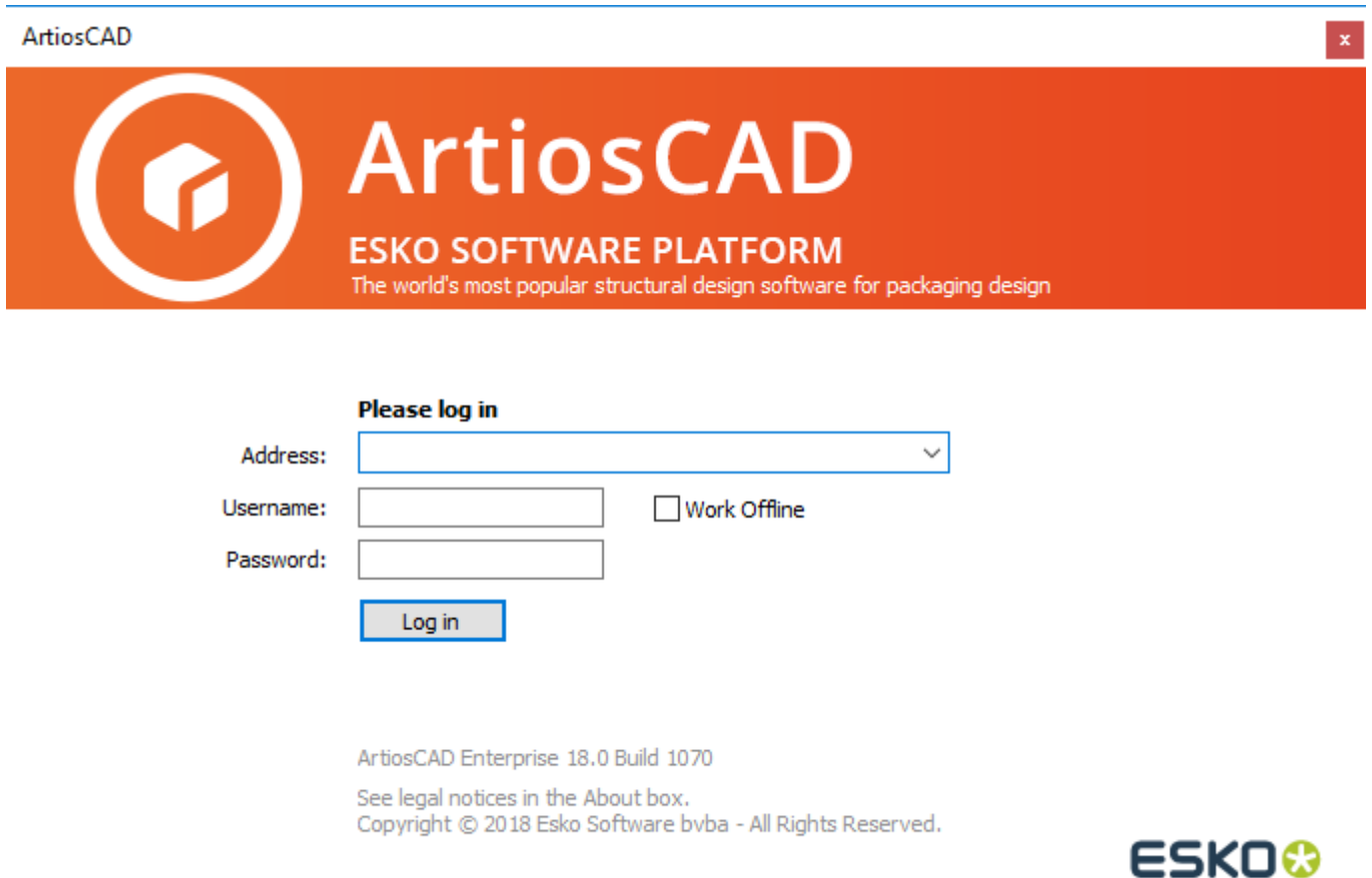

- Using the information given to you by your system administrator, enter the address of the server, your username, and your password as shown below. Click **Log in**.

ArtiosCAD
×



ArtiosCAD

ESKO SOFTWARE PLATFORM
The world's most popular structural design software for packaging design

Please log in

Address: [Remove](#)

Username: Work Offline

Password:

ArtiosCAD Enterprise 18.0 Build 1070
 See legal notices in the About box.
 Copyright © 2018 Esko Software bvba - All Rights Reserved.



3. ArtiosCAD Enterprise prompts you to select a license method. See the next section for more information.

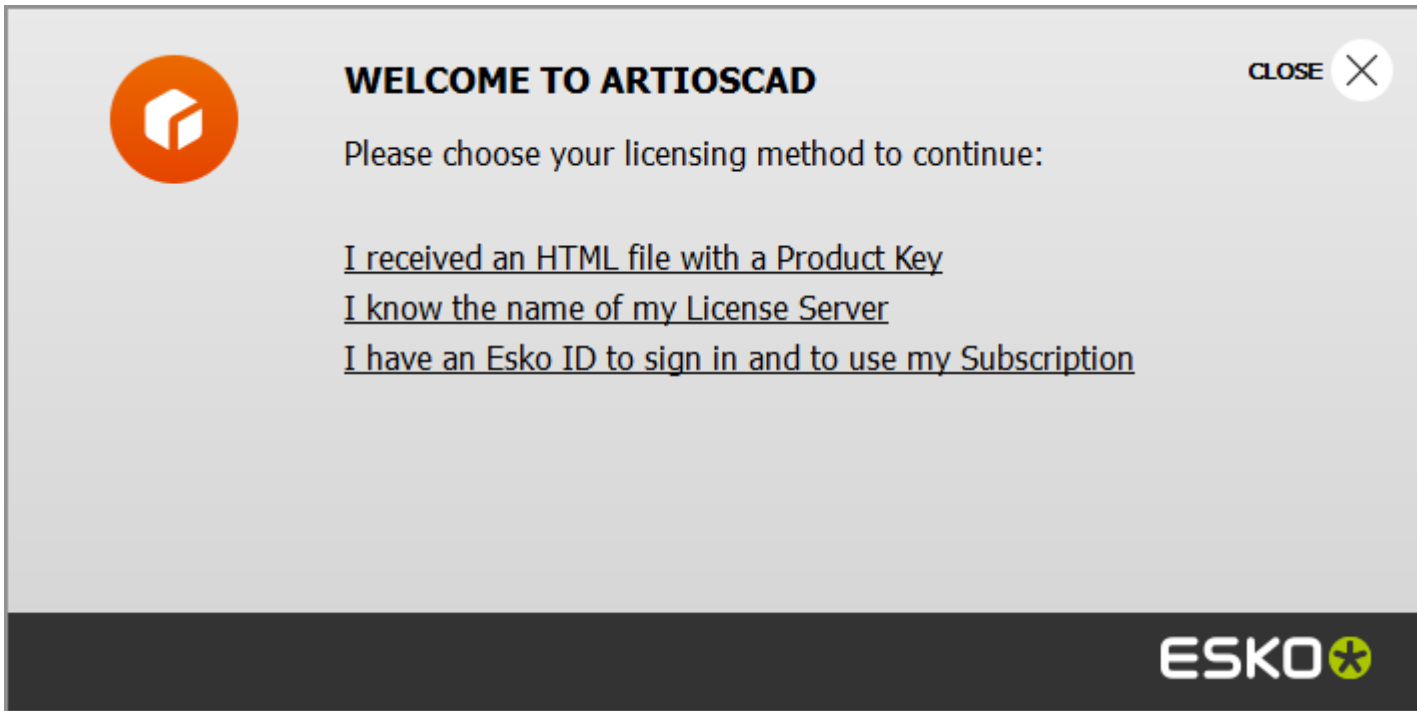

4. Since this is your first login, ArtiosCAD Enterprise prompts you to build your local Defaults cache for faster performance. Click **Yes**.

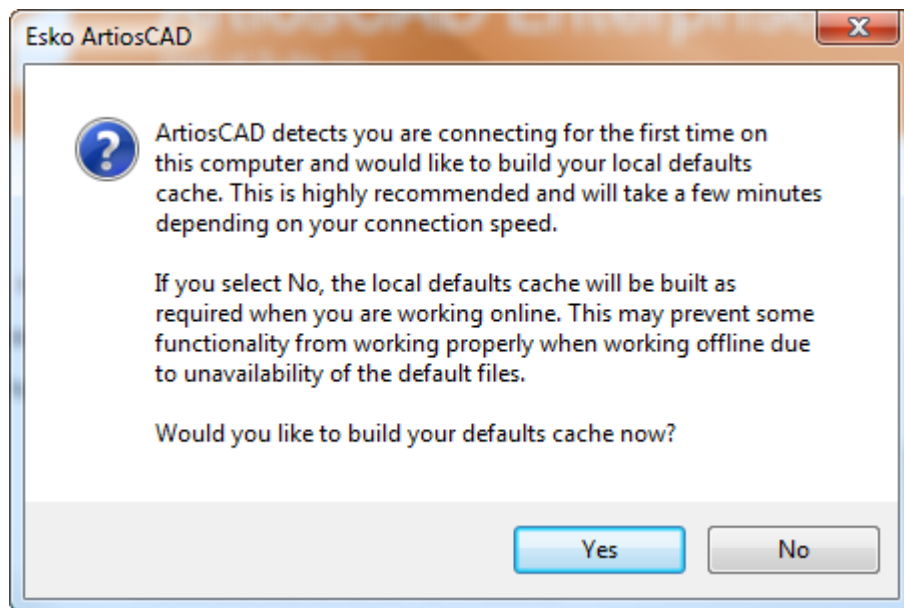

ArtiosCAD Enterprise builds the Defaults cache. This process only takes a few minutes depending on your connection speed. If your system administrator did not invite you to the Shared Defaults project, you will get a permission denied error message.

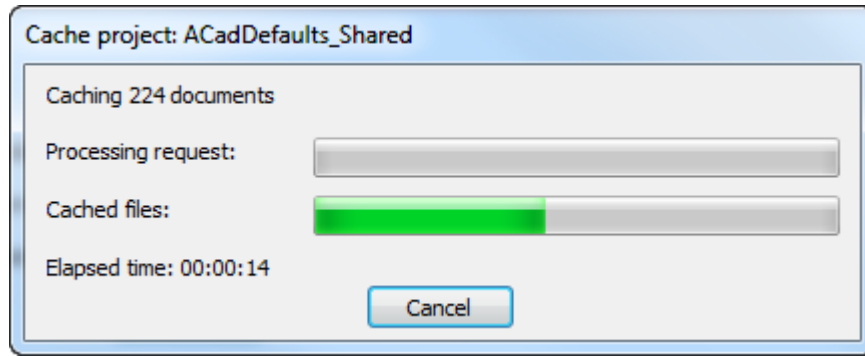

5. If you have a previous version of ArtiosCAD loaded on this machine, and you are a Project Manager, ArtiosCAD may ask if you want to migrate the User Defaults of a previous Standard Edition version loaded on this machine into this Enterprise version.

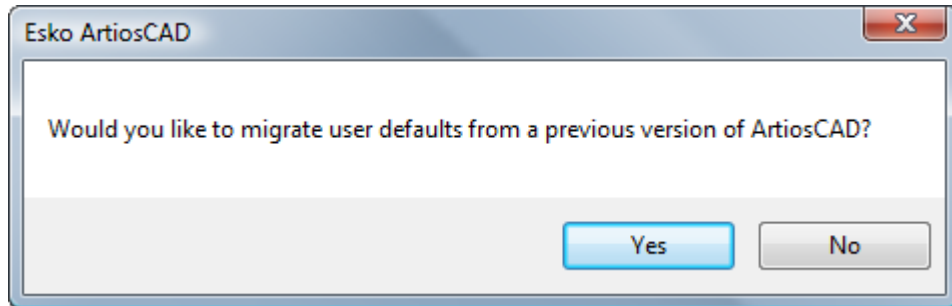

- a) If you click **Yes**, select the version's User Defaults to migrate and click **OK**. Clicking **No** will skip copying any User Defaults from ArtiosCAD

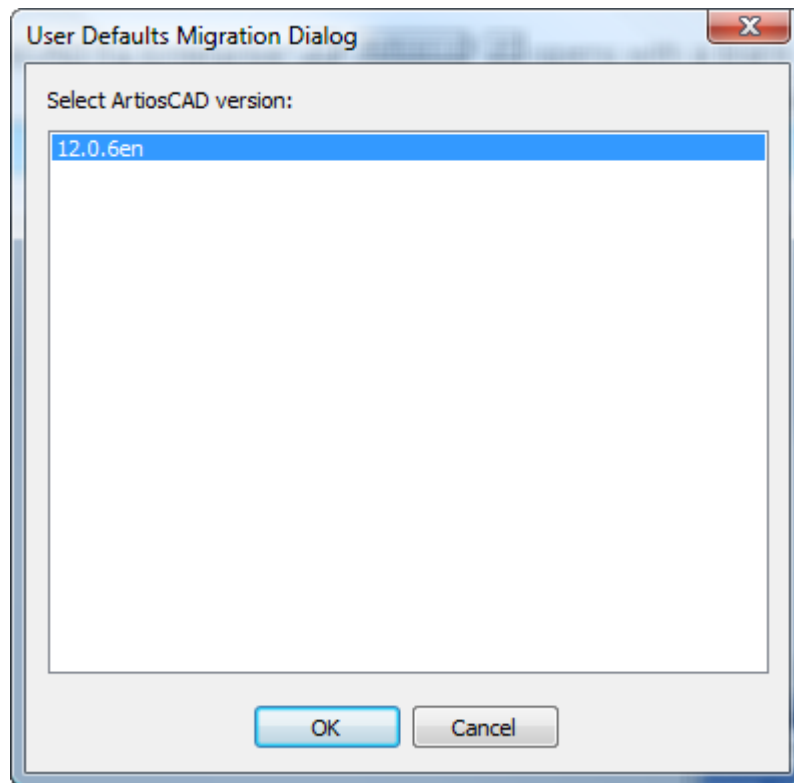

b) ArtiosCAD shows a progress indicator during the migration.

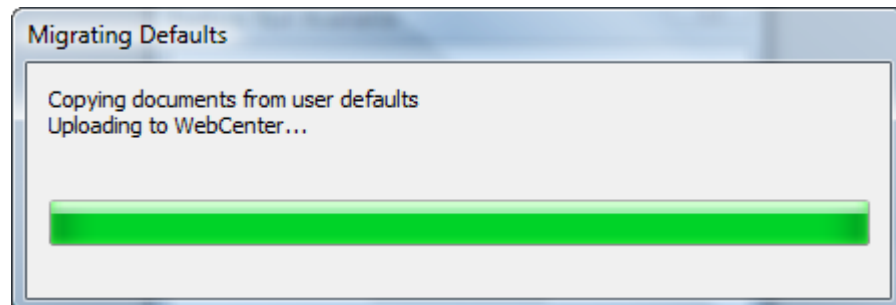

6. ArtiosCAD Enterprise opens with a blank screen.

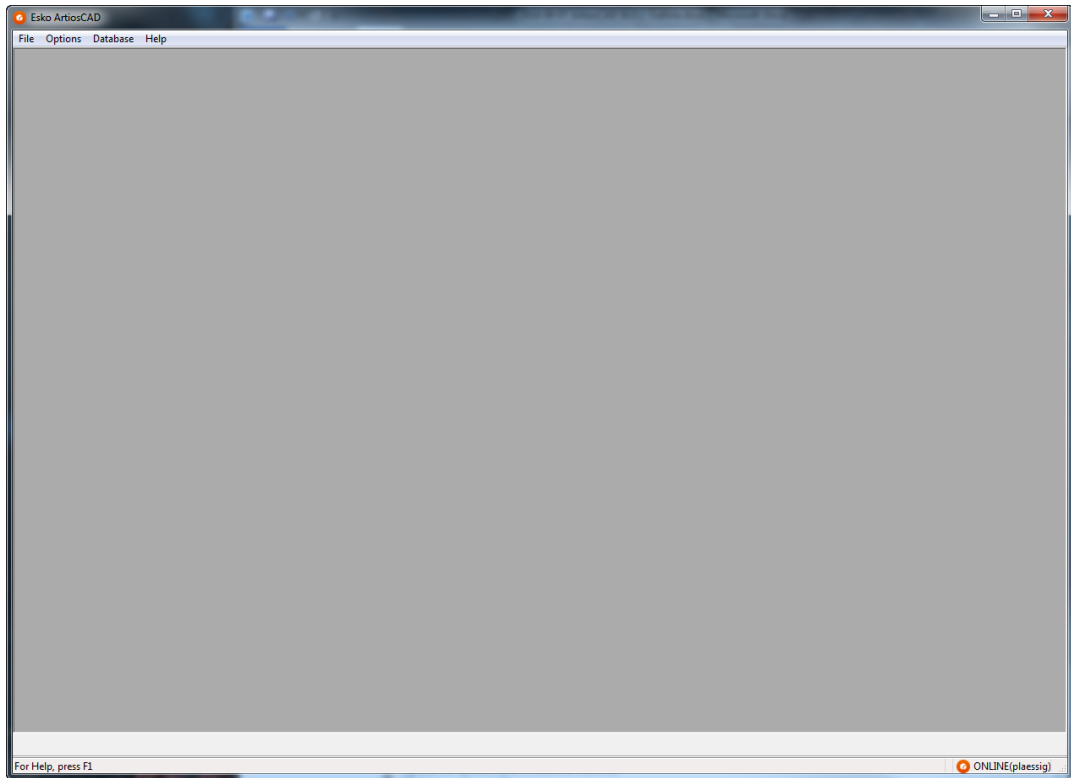

Entering Licensing Information

The first time you start ArtiosCAD, it will prompt you to enter licensing information before the splash screen appears for ArtiosCAD Standard Edition and after the login dialog box for ArtiosCAD Enterprise.

1. In the Welcome to ArtiosCAD dialog box, click the licensing method to use: **I received an HTML file with a Product Key, I know the name of my License Server, or I have an Esko ID to sign in and to use my Subscription.**

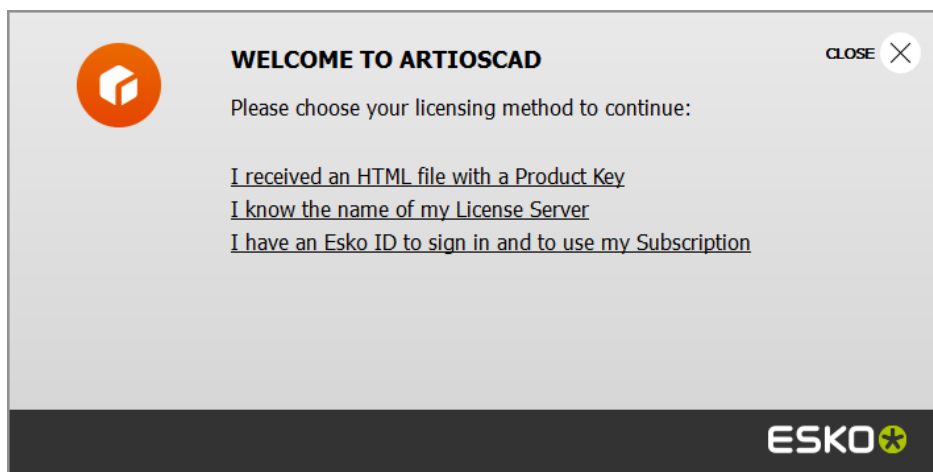

2. If you chose the HTML file with product key option, the normal Esko Activate Local License wizard starts. Proceed as instructed on the screen.

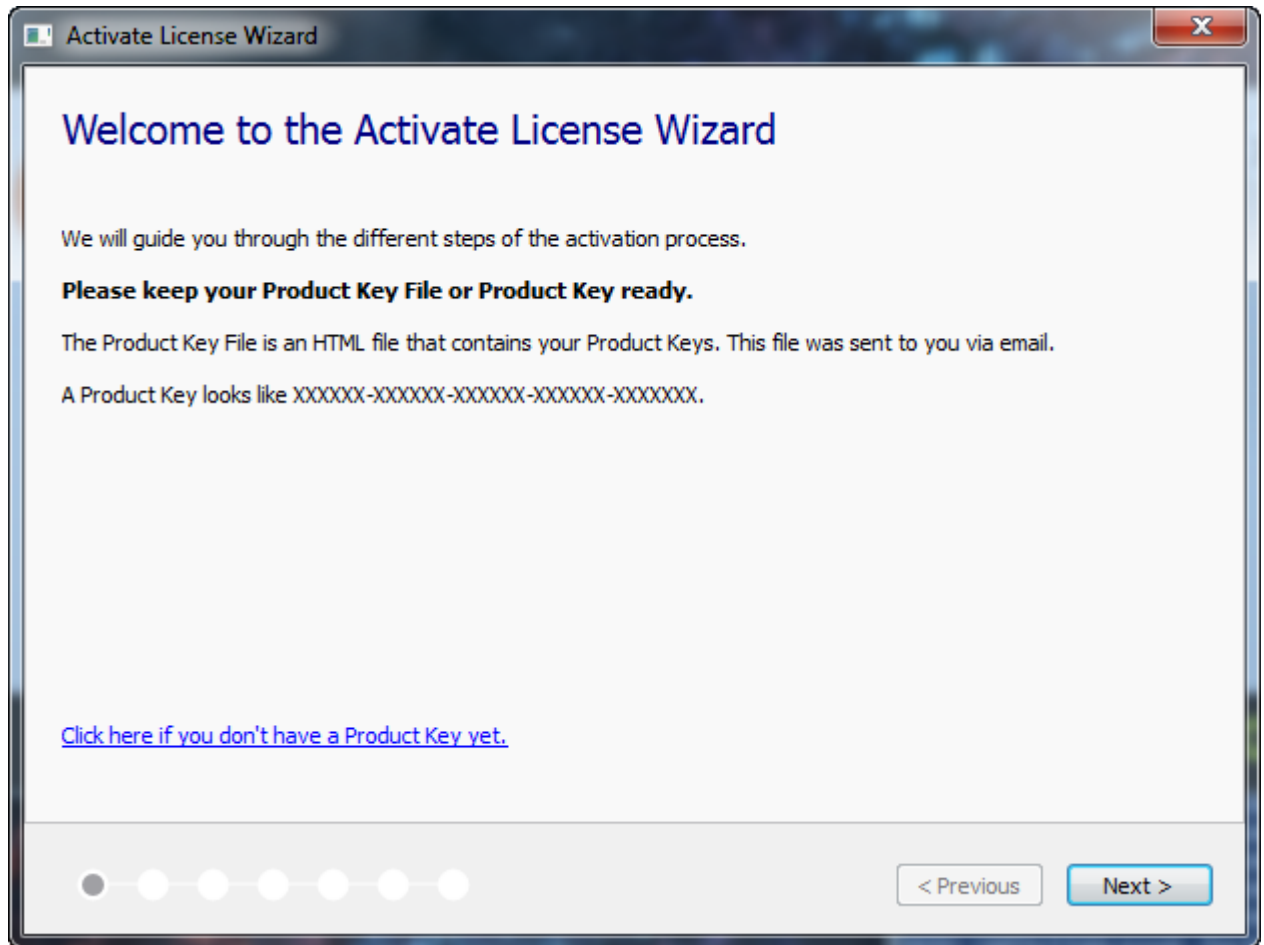

For more information, please refer to the Local License Manager documentation available at <http://www.esko.com/support>.

3. If you chose the license server option, enter the name of your license server and click **Connect**.

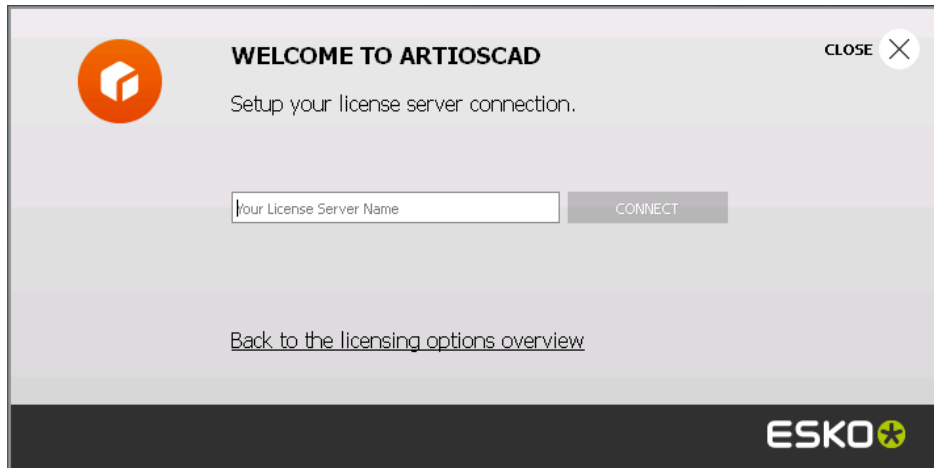

If all network licenses are in use, ArtiosCAD displays an error message. Click **Show licenses currently in use** to see a list of who is using a license so you can ask another user to release a license. For more information, please refer to the Network License Manager documentation available at <http://www.esko.com/support>.

4. If you chose the Esko ID and subscription option:
 - a) Enter your email address and password for your Esko ID and click **Sign In**.

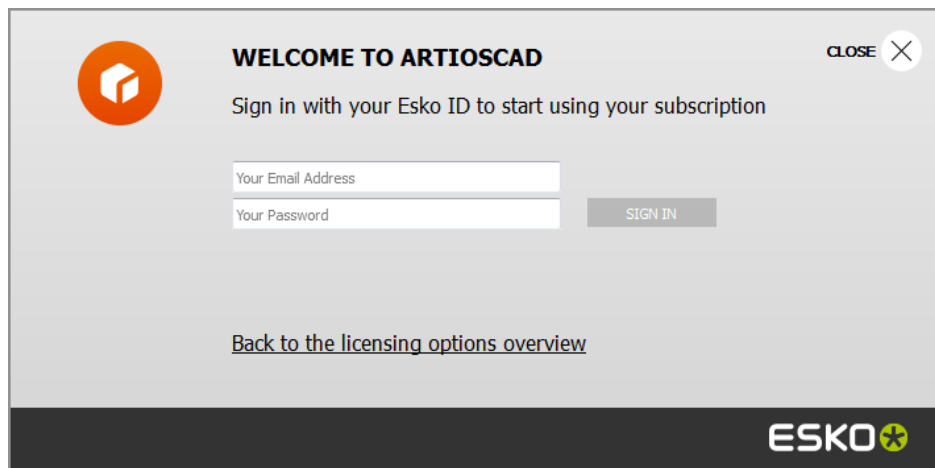

- b) Once the license is initialized successfully, click anywhere in the dialog box to continue starting ArtiosCAD.

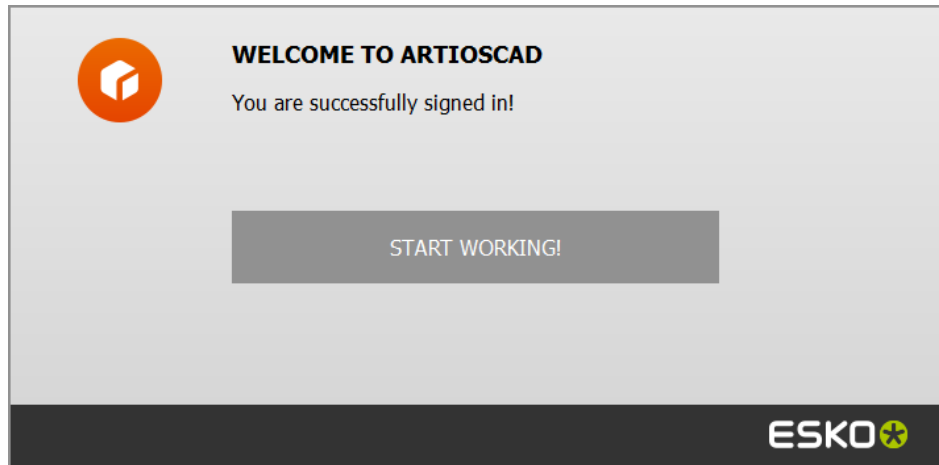

For more information, please refer to the Local License Manager documentation available at <http://www.esko.com/support>.

Changing the License Location

If you need to change the ArtiosCAD license location and your current license still works, close all documents and click **Help > License Location**.

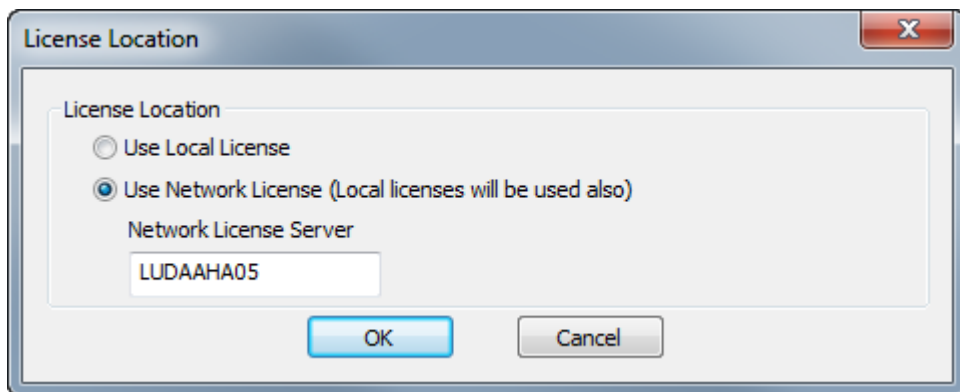

Choose **Use Local License** to use either a local or a subscription license.

Choose **Use Network License** to use a network license provided by a license server. ArtiosCAD will also use any available local or subscription licenses in addition to the network one.

Click **OK** to apply the change and return to ArtiosCAD.

If your current license no longer works, ArtiosCAD will prompt you to choose a license method when it starts.

Signing Out of Your Subscription

Note: You only need to sign out if you want to release your license. You do not need to sign out just to exit ArtiosCAD.

To sign out of your subscription license and quit ArtiosCAD, do the following:

1. Close all open ArtiosCAD documents.
2. Click **Help > Sign Out**.
3. In the ArtiosCAD Sign Out dialog box, click **Sign Out & Quit**.



4. ArtiosCAD releases your subscription license and closes. The next time you start it, ArtiosCAD will prompt you for license information.

Adding and Removing Server Locations

When you log in, the Address field in the Login dialog box can be a drop-down list box if you add different addresses. Note that these address entries are saved only on your computer and are not replicated on other user's computers.

To add an address to the drop-down list box, do the following:

1. Launch ArtiosCAD Enterprise.
2. In the Login dialog box, enter a server's address in the Name field.
3. Click **Add** at the end of the Address field.
4. In the Add Location dialog box, enter the server's name in the Name field and click **OK** (the Address field is copied from the Login dialog box).

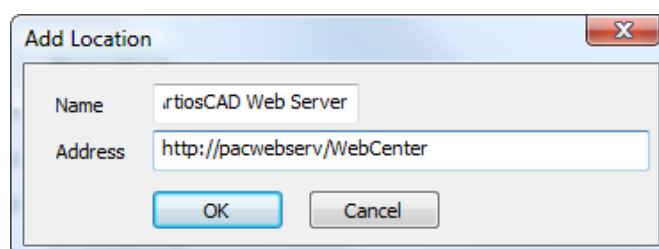

The location is now available in the Address drop-down list box.

Address: Remove

Username:

Password:

To add another location to the list, clear the Address field, enter a new address, and click **Add**. To remove a location from the list, select it from the Address drop-down list box and click **Remove**.

Mode and Status Indicators

ArtiosCAD Enterprise shows the name of the active file in the title bar of the window. If the file is managed, the draft status or the revision number or letter is shown after the filename.

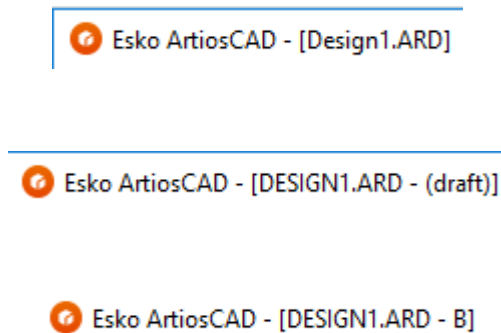

ArtiosCAD Enterprise is in online mode when it can connect to WebCenter, and is in offline mode when it cannot connect to WebCenter. You can use offline mode with few differences from online mode; your work will be synchronized with the server the next time you enter online mode. The Status bar indicates which mode you are in.

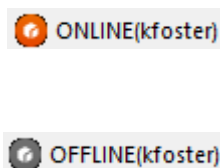

Changing the Logged-In User or Server

To change the server you are using or the user you are logged in as, do the following:

1. Close any open ArtiosCAD Enterprise documents.
2. Click **Database > Change Login**.
The Login dialog box appears.
3. Enter new information in the Address, Username, and Password fields, and click **Login**.

If you entered valid connection information, the name of the logged-in user changes on the Status bar of the blank ArtiosCAD Enterprise window.

Changing Location

To change your location for the current session of ArtiosCAD Enterprise, do the following:

1. With no documents open, click **Database > Change Location**.
2. The contents of the Change Location dialog box depends on your privilege level as defined in WebCenter. If you are a member of ADMINS, you automatically see all companies and locations, as shown below. If you are a Project Manager with Full Visibility, you will initially see only your company, but **Show All Companies/Locations** will be available for you to select. If you are a Project Manager with Limited Visibility or a normal user, you will only see your location.

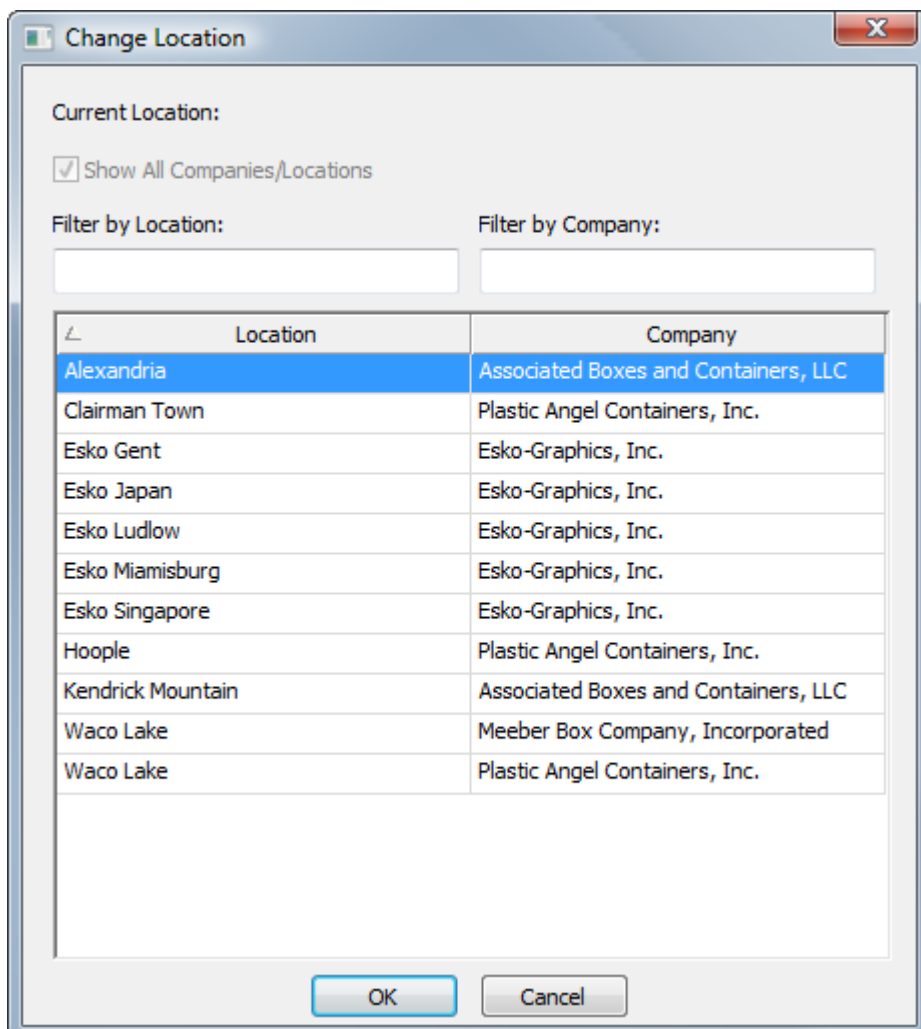

3. To filter the results, enter a filter term in either filter field. ArtiosCAD updates the results as you type.

4. Click the desired location.
5. Click **OK** to return to ArtiosCAD

An Example of Using Change Location

An example of using Change Location would be when you had to use Defaults (like a Report or a geometry macro) from another location of your company, but with your own machinery at your location. This example assumes you are at least a Project Manager with Full Visibility.

1. Launch ArtiosCAD Enterprise and log in as yourself.
2. Click **Database > Change Location**.
3. In the Change Location dialog box, select the location that has the Defaults you need to use and click **OK**. You must be either a member of ADMINS or be a member of that location's Location Defaults Project.
4. Click **Options > Defaults** to open Defaults.
 - a) Drag and drop the needed Defaults from the Location Defaults pane to your User Defaults.
 - b) Click **File > Exit** and click **Yes** to overwrite the User Defaults.
5. Click **Database > Change Location**.
6. In the Change Location dialog box, select your location and click **OK**.

You will now have the Defaults you need from the other location combined with your own so you can complete your work.

Introduction to Offline Mode

When you want to disconnect your computer from the network, use offline mode. ArtiosCAD Enterprise copies the necessary database information of Projects you have downloaded to your computer so that you can continue working normally, and then synchronizes it with the server when you reconnect to the network.

See the section about Offline Mode for more information.

Using the Browser

The browser is the main way to use the Project management features of ArtiosCAD Enterprise. To open the browser, you can:

- Click **File > Browser**.
- Press CTRL-B.
-  If a design or manufacturing document is already open, click the Browser button on the toolbar.

Browser Window Elements

The browser has 3 or 4 main areas depending on which panels you have open.

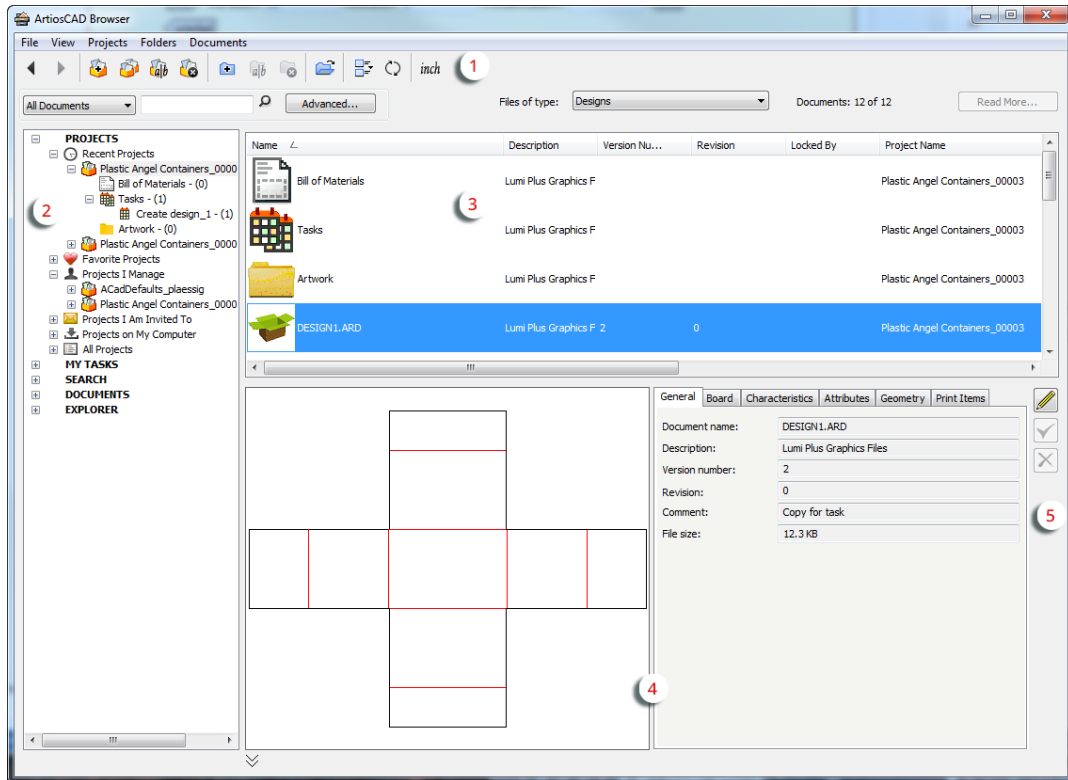

Area

Function

- 1 The menu bar, toolbar, and display bar, where you use commands and tools, search for Projects and documents, and control what is shown in the document list.
- 2 Tree control where you select which Project or folder to view, either managed or unmanaged. ArtiosCAD also shows search results and Tasks here. Drag the bar between the tree and the document list to adjust the size as desired.

Note: In order to see Tasks, your WebCenter system must be licensed appropriately, and you must have the appropriate permissions to use them.

- 3 List of documents and folders in the selected Project or folder, or search results, recent Projects, or Tasks depending on the node you select in the tree. If you have the document preview and properties pane turned on, drag the horizontal bar between the document list and the preview and properties pane to adjust the size as desired. The sort order is the BOM, then Tasks (if available), then folders, then documents.
- 4 Preview and properties pane which you hide or show by clicking the chevron button. The contents of the properties pane depend on what you select in the tree - when you select a Project, ArtiosCAD shows Project-related information, when you select a document, ArtiosCAD shows

Area	Function
	design-related information, and when you select a Task (if available), ArtiosCAD shows Task-related information. The properties pane is blank when you select multiple items.

Note: To see a preview of Collada files, either in the preview pane or as an icon in the document list, you must save the Collada file through ArtiosCAD Enterprise so that it generates a preview and includes it as part of the .ZAE file. For existing Collada files, open and resave them.

5	Information edit controls.
---	----------------------------







To save your browser configuration (such as which panes are visible and their sizes), click **View > Save Browser Configuration**. To restore it, click **View > Load Browser Configuration**.

The Browser Toolbar

The browser toolbar, shown below, lets you move between Project views and create, copy, rename, and delete Projects and folders easily. Depending on what you select and your permissions, tools are available or unavailable.



Button	Tool	Active When
	Back	You have viewed at least two Projects or folders and have a previous view
	Forward	You are seeing a previous view and can go forward to another view
	Create Project	A Project or folder is selected and you are a Project manager
	Copy Project	A Project or managed document is selected, you are a Project manager, and you have sufficient permission
	Rename Project	A Project is selected and you have sufficient permission
	Delete Project	A Project is selected and you have sufficient permission

Button	Tool	Active When
	Create Folder	A Project or folder is selected and you have sufficient permission. This is also available in the Explorer node for unmanaged documents.
	Rename Folder	A folder is selected and you have sufficient permission. This is also available in the Explorer node for unmanaged documents.
	Delete Folder	A folder is selected and you have sufficient permission. This is also available in the Explorer node for unmanaged documents, in which case deleting a folder also deletes its contents; ArtiosCAD moves deleted unmanaged documents to the Recycle Bin.
	Open Document	You have a document selected
	List Style	Always active. Uses the Windows Explorer settings for hidden and system files.
	Refresh	A Project is selected. This requires the database for updated information about the Project. This is also available for unmanaged folders in the Explorer node.
	Units. Click it to change the units system the browser displays. Inch is Imperial and mm is metric.	Always available.

Search Controls

Use the search controls to search for Projects and documents.



Area	Function
1	Search Type drop-down list box with which you choose what to search for
2	Keyword entry field where you enter the terms to search for
3	Search button that starts the keyword search
4	Opens the Advanced Search dialog box

Performing searches is covered later in this chapter.

Document Display Control

The document display control filters the list of shown documents. Choose the type of documents listed from the drop-down list.

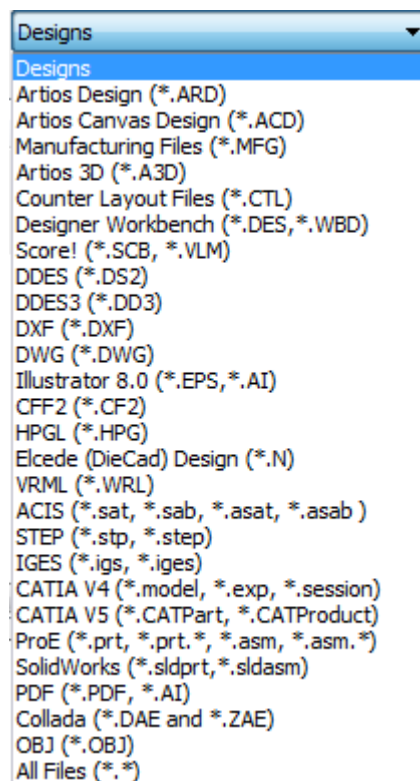

This control is available when you:

- have a Project selected in the tree control
- are using the Explorer node of the tree control.

Folders in the Project are unaffected by filtering and always appear in the document list.

Note:

THIS CONTROL DETERMINES THE DOCUMENTS YOU SEE IN THE DOCUMENT LIST. IF YOU ARE LOOKING FOR A DOCUMENT AND CANNOT FIND IT, MAKE SURE THIS CONTROL IS SET PROPERLY.

Paging Controls

The paging controls let you navigate search results. The browser displays 25 documents per page of search results.

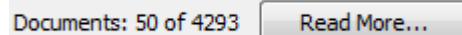

Documents: 50 of 4293 [Read More...](#)

ArtiosCAD Enterprise shows 25 lines of results at a time by default. Click **Read More** to show more lines.

You can change the number of default lines shown by clicking **Options > Defaults > Browser settings > General Information > Search options** and changing the number to your preference.

Tree Control

The tree control lets you work with Projects, folders, searches, documents (both managed and unmanaged), and Tasks (if your WebCenter system has that option).

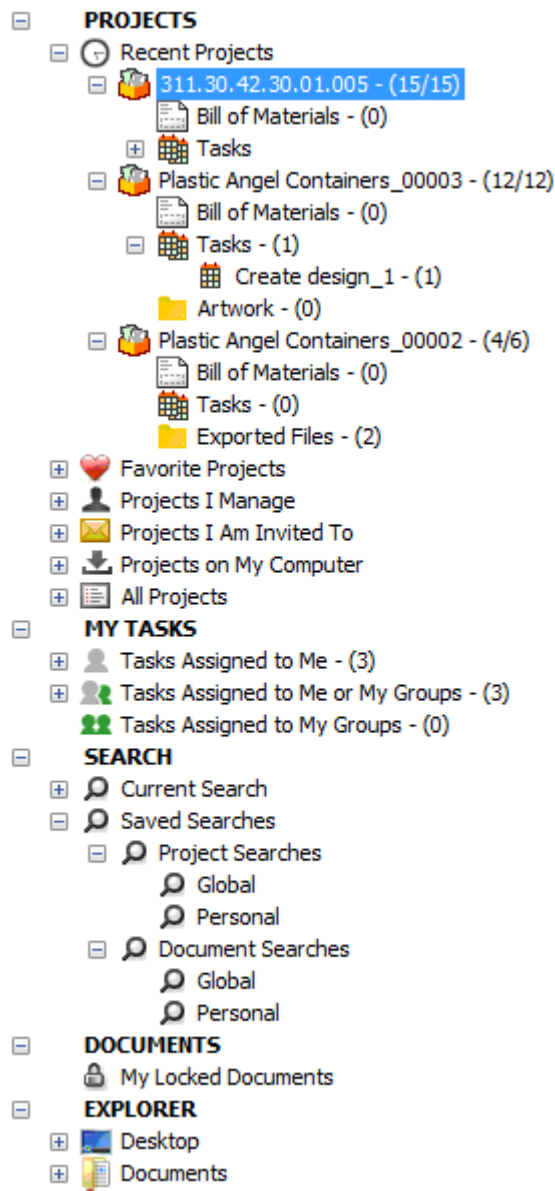

The tree has five top-level nodes:

- Projects
- My Tasks (optional)
- Search
- Documents
- Explorer

Note:

ArtiosCAD displays the **My Tasks** node only when both of these are true:

- Your WebCenter system has task management (either a pre-2017 task management license or at least WebCenter Essentials)
- ArtiosCAD is in online mode.

Projects Node

The Projects node of the tree control contains several nodes itself.

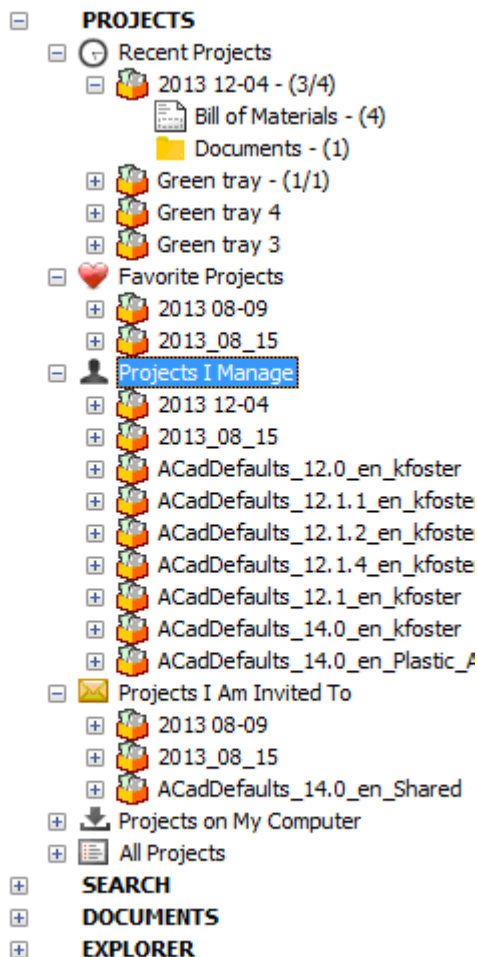

Recent Projects shows the four most recent Projects you have modified. You can change this number in Defaults.

Favorite Projects shows those Projects you have designed as favorites. One way to designate a Project as a favorite is to right-click it and click **Add to Favorite Projects**. Another way is to drag it into Favorite Projects.

Projects I Manage shows Projects you manage. ArtiosCAD Enterprise does not show this node if you are not a Project Manager.

Projects I Am Invited To shows those Projects of which you are a member.

Projects on My Computer shows Projects whose database and design information you have copied to your computer for use in offline mode. When you reconnect to the database, the database information and files are updated. These Projects are not truly stored on your computer. There is more information about offline mode later in this chapter.

All Projects shows all Projects you have permission to see.

As you click items in the tree and load them into the browser, ArtiosCAD Enterprise displays a count after them. For Projects, the count is the number of documents in the root level of the Project followed by the total number of documents in the Project. For a BOM, the count is the number of documents in the BOM. For Tasks, it is the number of tasks assigned to the Project. For a folder, the count is the number of documents in the folder.

Note: The numbers in the counts reflect the documents you have permission to see. If there are items in the Project for which you do not have View permission, those items are excluded from the counts.

When you right-click a Project, the context menu shows items appropriate for the object in the node in which you clicked it. For example, when you right-click a Project in Recent Projects that also is in Projects on My Computer, the context menu does not show the commands it would show if you clicked the Project instance in Projects on My Computer. Shown below is the context menu for a Project in Recent Projects.

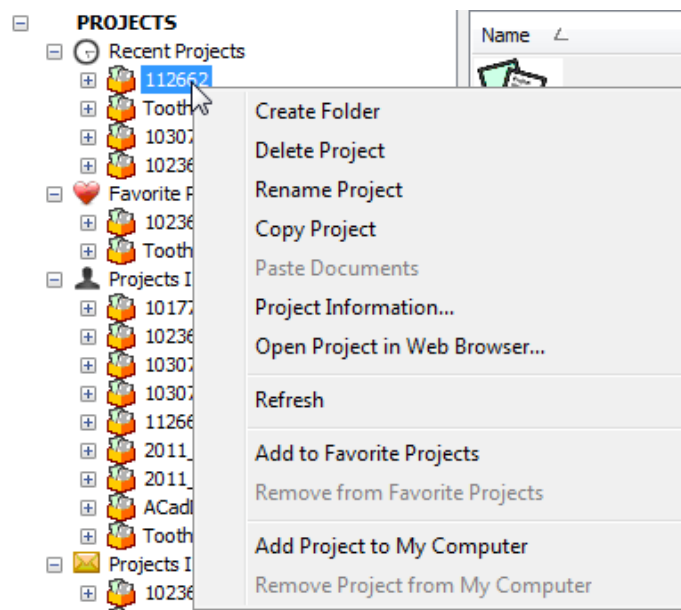

Shown below is the different context menu for a Project in Projects on My Computer.

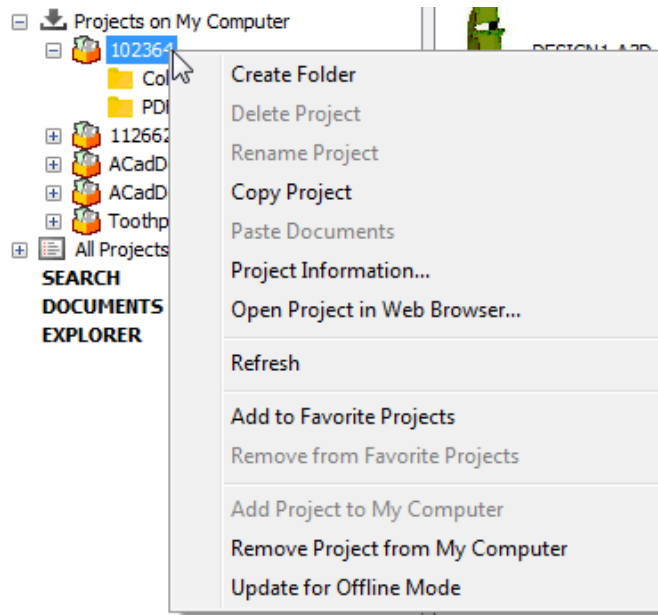

BOM Node

The browser shows the Bill of Materials node inside every Project when you expand it or click it to provide easy access to the BOM. ArtiosCAD Enterprise shows the BOM node regardless of the BOM's existence. This is configurable in Defaults (**Options > Defaults > Browser Settings > General Information**).

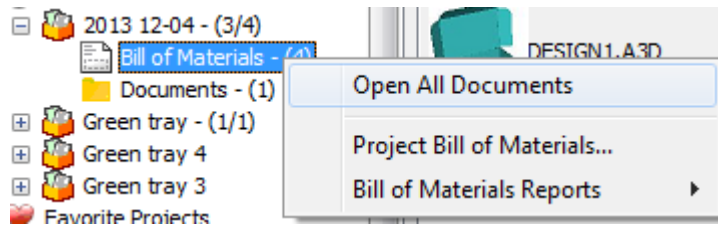

On the context menu, you can open all the documents in the BOM, go to the Project Bill of Materials to configure it, or output a Report.

Likewise, when you highlight the Project in the tree, the Bill of Materials is the first item in the document list (provided it is sorted by name). If you right-click it there, the same context menu appears.

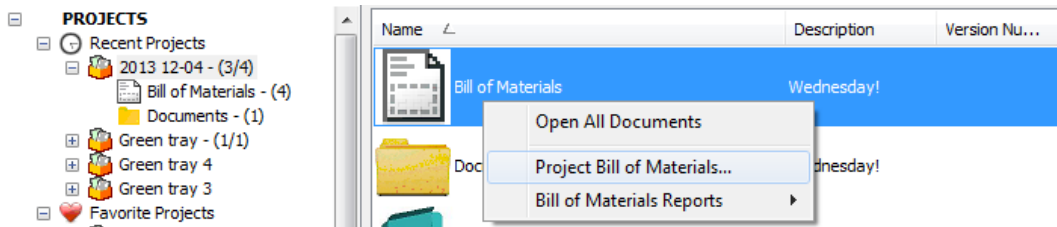

Open All Documents opens all the documents in the BOM in ArtiosCAD Enterprise if it can open them. It is also on the Project drop-down list box at the end of the document tab bar in ArtiosCAD Enterprise

Project Bill of Materials leads to the Project Bill of Materials Documents dialog box where you configure the BOM.

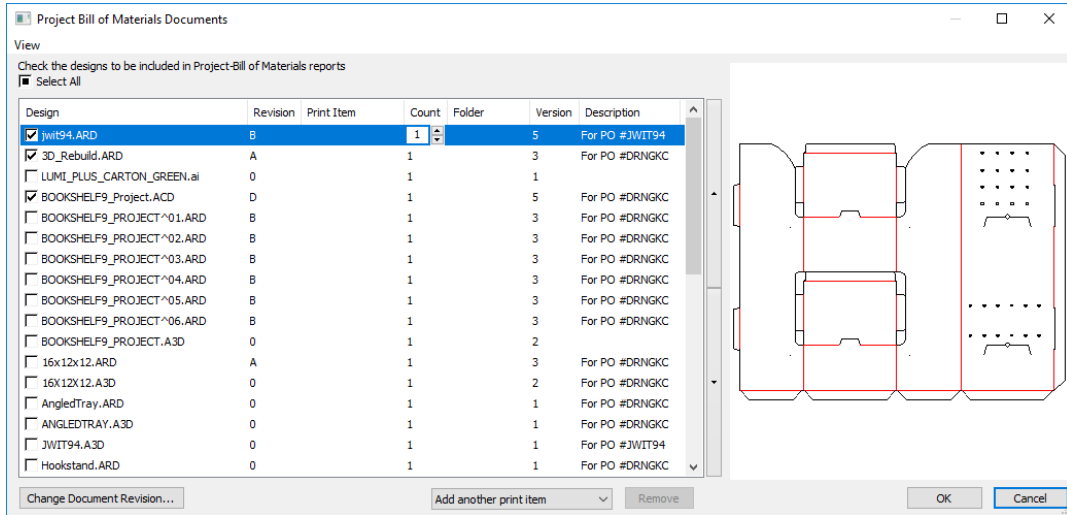

Bill of Materials Reports runs a Report against the BOM.

ArtiosCAD BOM						06/27/2014 13:30:57
Project: 2013 12-04			Manager: Katryna Foster			
Customer: Esko Ludlow			Salesperson: Katryna Foster			
Name	Print Item	Cnt	Weight	Area	Rule	Comments
1. DESIGN1	Black	2000	1.35	1781.04	444.83	
2. DESIGN1	Green	4000	1.35	1781.04	444.83	
3. DESIGN1	DESIGN1.A3D	1	0	0.00	0.00	
4. DESIGN1	DESIGN1.WFG	8000	0	0.00	0.00	
5. Green Tray	Green Tray	2	0	0.00	0.00	
Total Count:		3000	32347.6	422849	108716	

Tasks Node

Within each Project is a Tasks node, similar to the Bill of Materials. When you click it, the browser displays the documents assigned to tasks in the Project. Note that you still do most task configuration and management actions themselves in WebCenter; the interface in ArtiosCAD is designed to provide easier access to tasks from a structural design perspective. In ArtiosCAD, you can mark task checklist items as completed.

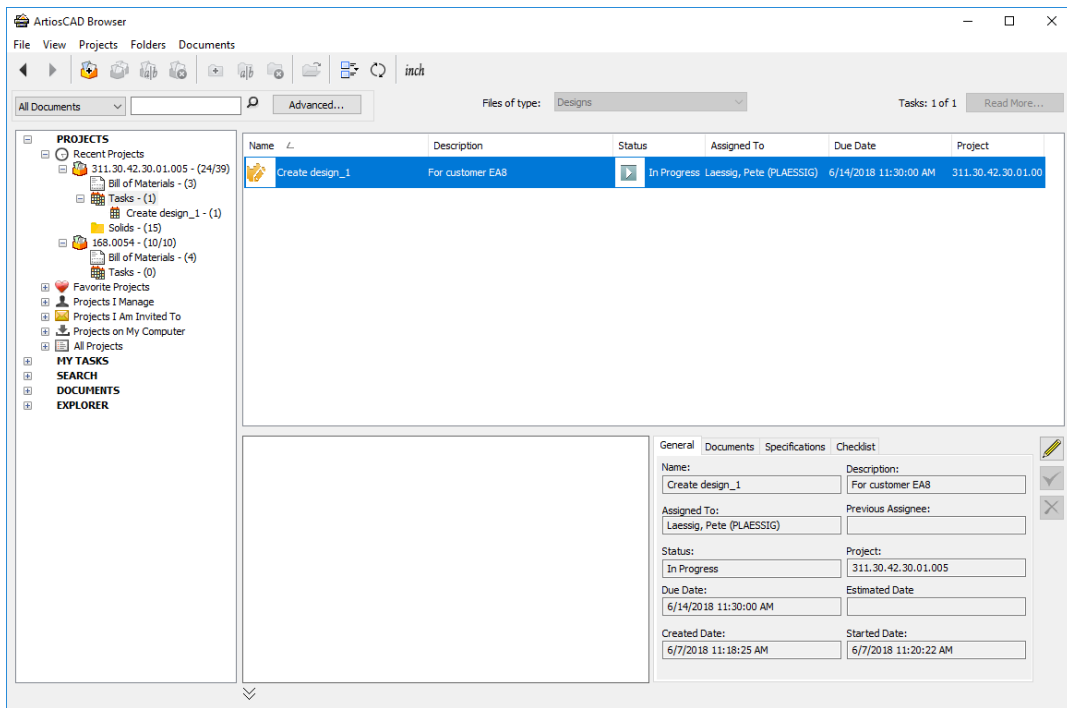

As with other nodes, control the size of the icons in the list using **List Style** on the toolbar. You can customize the columns by right-clicking on the head of the list control.

The Details pane shows general information about the selected task, its documents, its specifications, and its checklist. Select a document on the Documents tab to see its preview.

If you select a specific task in the tree control, the documents list shows the documents assigned to that task. Select a document in the document list to show its details in the Details pane.

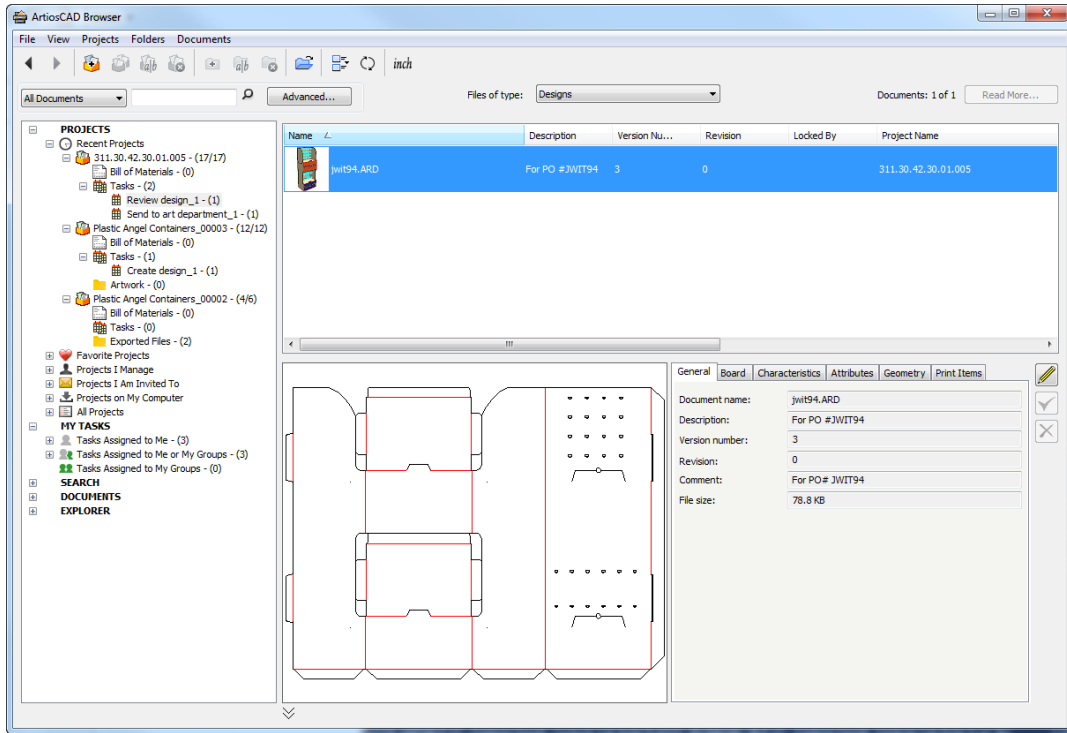

ArtiosCAD shows due dates for on-time tasks in green, due dates for tasks with a close due date in orange, and due dates for tasks past their due date in red.

If there is a view in the Attribute category of the document that has the same name as the task type of the task with which this document is associated, the Attributes tab heading changes to Specifications, and ArtiosCAD shows only those Attributes that are part of that view.

My Tasks Node

Note:
 This node is optional and appears only if your WebCenter system has a task management license and ArtiosCAD is in Online mode.

The My Tasks node of the tree control contains several nodes itself.

- [-] **MY TASKS**
 - [-] Tasks Assigned to Me - (3)
 - Create design_1 - (1)
 - Review design_1 - (1)
 - Send to art department_1 - (1)
 - [-] Tasks Assigned to Me or My Groups - (4)
 - Create design_1 - (0)
 - Create design_1 - (1)
 - Review design_1 - (1)
 - Send to art department_1 - (1)
 - [-] Tasks Assigned to My Groups - (1)
 - Create design_1 - (0)

Tasks Assigned to Me shows the tasks assigned to you.

Tasks Assigned to Me or My Groups shows tasks assigned to you or any group of which you are a member.

Tasks Assigned to My Groups shows tasks assigned to any group of which you are a member.

ArtiosCAD updates the task count shown after each node as you expand them. It also updates the three lists automatically once a minute when the browser is active (except when it is showing the Save As dialog box).

When you select a main node in the tree and then a task in the Document pane, ArtiosCAD shows the details about the selected task itself on the General, Documents, Specifications, and Checklist tabs in the Details pane.

Search Node

The Search node shows the results of the current search and also shows saved searches you can run when desired.

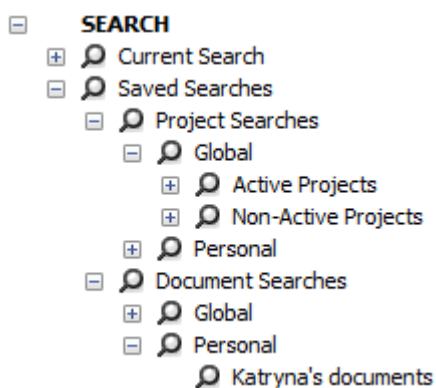

Searching is covered later in this chapter.

Documents Node

The Documents node contains My Locked Documents, which shows the managed documents you currently have open in ArtiosCAD Enterprise based on the same server.

In the example below, **My Locked Documents** was selected in the tree control. Note that DESIGN2.ARD, the tray, is not open in this session of ArtiosCAD Enterprise; rather, it is open on another workstation.

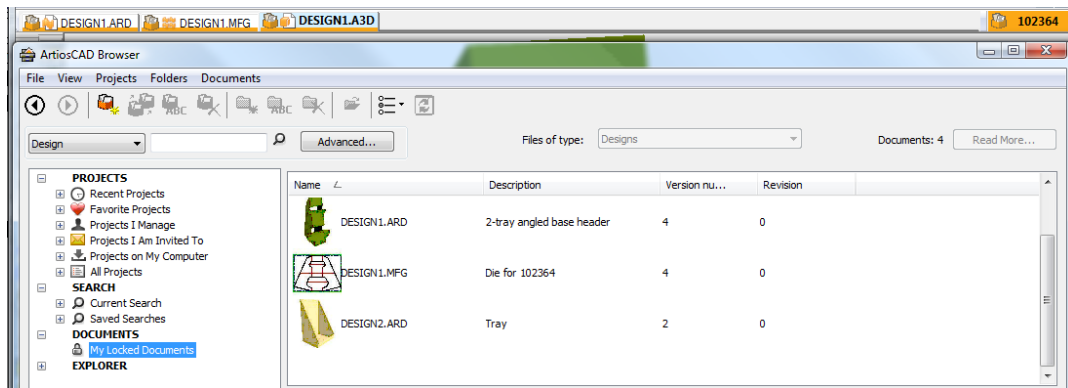

Explorer Node

The Explorer node of the Project tree shows drives and folders on the current workstation (including networked drives), allowing you to open and save unmanaged files.

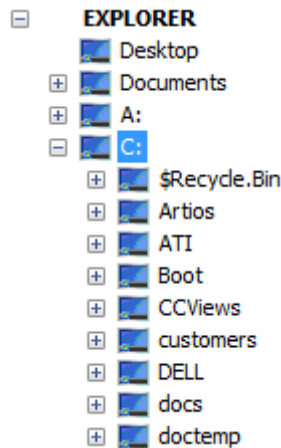

When you select a folder in the Explorer node, the document list shows the contents of that folder using the Windows Explorer settings for hidden and system files. Use **List Style** on the toolbar to change how the contents are shown. You can also change the contents of the list with the **Files of type** drop-down list box.

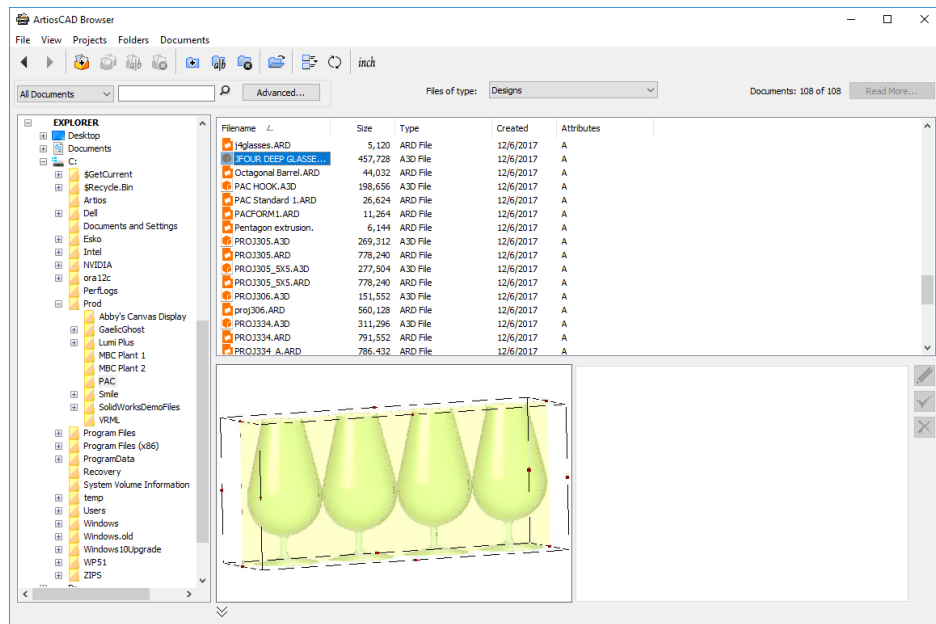

Note:

Since the designs are unmanaged, there is no database information for ArtiosCAD Enterprise to display on the information tabs next to the preview.

You can create, rename, and delete documents and folders in the Explorer node using the tools on the toolbar and the commands on the context menu (when you select an object and right-click the mouse). When you delete a folder, ArtiosCAD moves its contents to the Recycle Bin.

Customizing the Document List

When the document list shows Projects, folders, managed files or search results, by default it shows the name, description, and version number. To customize what information is shown for this session, do the following:

1. Select an entry in the tree control in the Projects, My Tasks, Search, or Documents node.
2. Right-click one of the headers in the document list and click **Customize**.
3. In the Column Customization dialog box, select or deselect items for the document list to display or hide.

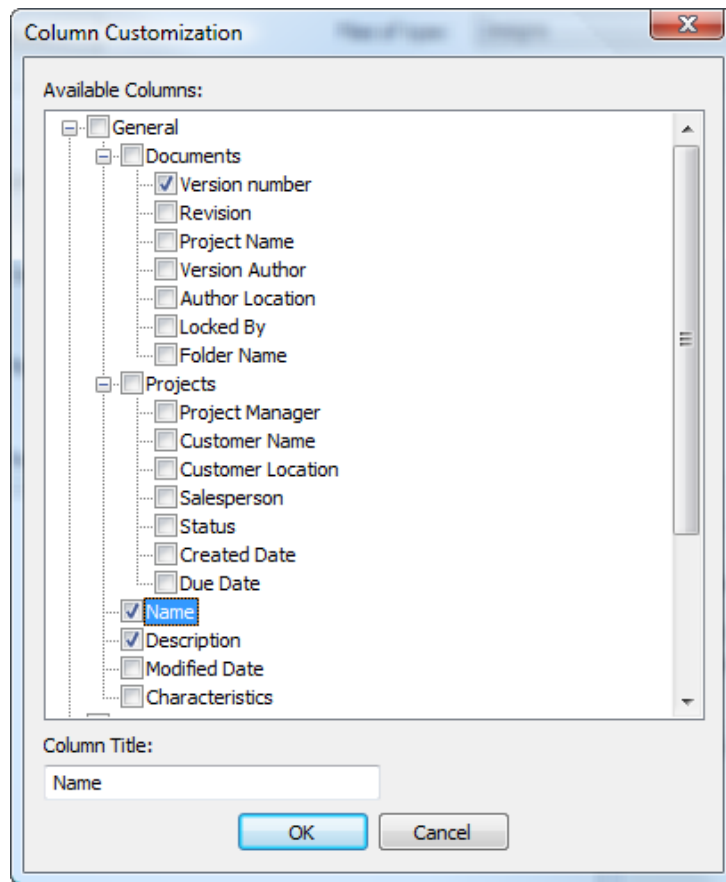

4. To change the displayed column label, select it and enter the new title in the **Column Title** field.
5. Click **OK** when done to return to the browser.

List Style controls the appearance of icons to the left of the name.

All columns are sortable. Drag the column headers to arrange them in the desired order.

You can make these changes permanent by saving the browser configuration as described in *Browser Window Elements*.

Edit Controls

The **Edit** controls to the right of the information fields let you edit certain items about the selected object in the tree control or document list.



Click the pencil **Edit** icon to enter Edit mode. Fields that you can change become available for editing. Once you have made a change, the check mark turns green to show you have made a

change. Click different tabs to edit the available fields on them. Some fields are not available and must be changed in other places such as the Database Information dialog box when saving or publishing a new version or revision.

Some considerations for Edit mode are:

- You can only edit a single managed item at a time. The controls are unavailable when you have multiple items selected.
- You can only edit managed items. Unmanaged items (such as those in the Explorer node) are not editable.
- The selected item must not be open in ArtiosCAD Enterprise.
- If you select a Project, you must be its manager to edit it.
- If you select a document, it must not be linked.
- If you select a document, it must not be locked, even by yourself.
- If the document you are viewing in the browser has an attribute category other than the one assigned in Defaults, the browser will display the list of attributes for the category that is actually assigned to the document. They will be editable in the browser.

The green **Save** icon and red **Cancel** icon become available after you have made a change.



Save saves the changes and exits edit mode. If you try to exit edit mode without saving, ArtiosCAD Enterprise prompts you to save the changes.

Cancel exits edit mode without saving changes.

There are a few restrictions to working in Edit mode:

- Changes to mandatory fields in Defaults while you are in Edit mode will take effect only when you select something else.
- Other users can change the same data at the same time.
- The current selection in the Attributes or characteristics list changes when switching between Edit mode and View mode.

Projects

Creating a Project

Note:

You may only create a Project if you are a Project manager.

To create a Project using the browser, do the following:

1.  On the browser toolbar, click **Create Project**.

2. Enter the name of the Project in the **Name** field, or if you are using automatic naming, click **Use Automatic Naming**. Depending on the options set in the Project Autaname Generation group on the General Preferences page in WebCenter, such as those for a prefix, suffix, or counter length, certain options in this dialog box may not be available. Autonaming is not available in offline mode, but you can use it when you synchronize returning online.
3. Optionally, you can:
 - a) enter a description for the Project in the **Description** field.
 - b) select a Template on which to base the Project from the **Template** drop-down list box.
 - a) Set the customer **Name** and **Location**. The Template can set these if they are defined.
4. Click **OK** to create the Project.
 ArtiosCAD Enterprise opens the **Project information** dialog box.
5. In the **Project information** dialog box, set the properties of the Project as desired.

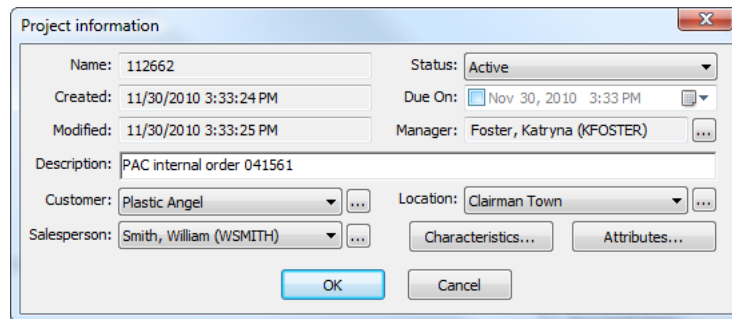

6. Click **OK** to create the Project.

After you create a Project, it appears in the Recent Projects and Projects I Manage nodes of the browser.

You are the only member of this new Project unless you based it on a Template containing more members. To add more members, see the section on inviting members to a Project.

Opening a Project

To open a Project in the browser, simply select it in any of the nodes in the Projects tree. Its top-level documents will appear in the document list and its list of folders (if any) will be expanded in the Project tree.

Opening a Project in WebCenter

From time to time you may want to open a Project in WebCenter to add or remove members, set permissions, and so forth. You can do so directly in WebCenter, but you can also do it from the browser in ArtiosCAD Enterprise.

1. Navigate to the desired Project.
2. Right-click it and click **Open Project in Web Browser**.

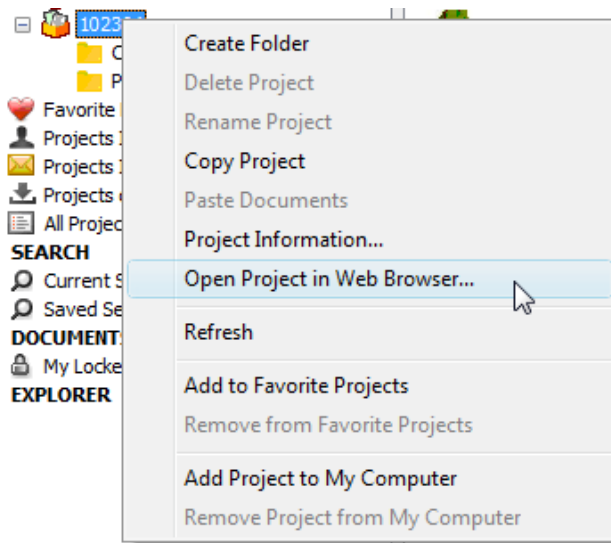

ArtiosCAD Enterprise will launch your default Web browser, automatically log you into WebCenter using your ArtiosCAD Enterprise username and password, and show the Project.

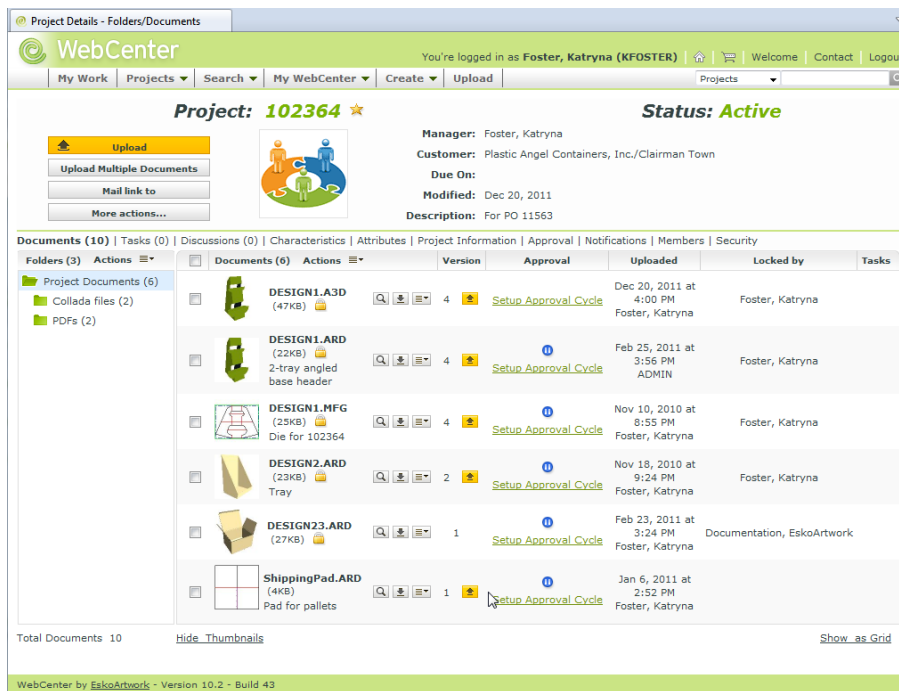

Renaming a Project

You can only rename a Project if:

- you are a member of the ADMINS group or you manage that Project, and
- no documents in that Project are open.

To rename a Project, do the following:

1. Select the desired Project.

2.  Click **Rename Project** on the toolbar.

The **Rename Project** dialog box opens.

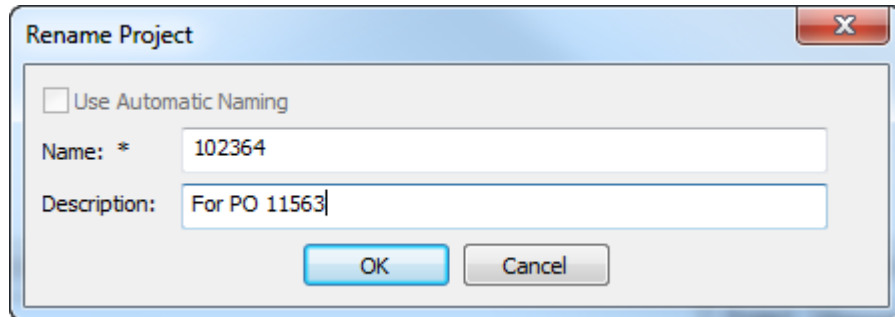

3. In the Rename Project dialog box:
 - a) in the **Name** field, replace the current Project name with a new one. Autonoming is unavailable when renaming a Project.
 - b) if desired, enter a new description in the **Description** field.
4. Click **OK** to rename the Project.

Deleting a Project

You can only delete a Project if:

- you are a member of the ADMINS group or you manage that Project, and
- no documents in that Project are open.

Note:

When you delete a Project, all documents within that Project are also deleted with no recovery method. Copy documents to other Projects if needed before you delete a Project. Use this command with caution!

To delete a Project, do the following:

1. Select the Project to delete.
2.  Click **Delete Project** on the toolbar.
3. Click **Yes** to confirm deleting the Project.

Copying a Project

If you are a Project manager, copy a Project by using either the button on the toolbar or the command on the context menu.

To copy a Project, do the following:

1.  Select a folder or document in the desired Project and click **Copy Project** on the toolbar. Alternately, right-click the Project and click **Copy Project** on the context menu.

2. Enter a name and description for the new Project in the **Create New Project** dialog box. The name and description of the existing Project pre-fill the fields already. You must change the name for the new Project. If you use autonaming, ArtiosCAD Enterprise uses the autoname settings of the original Project.

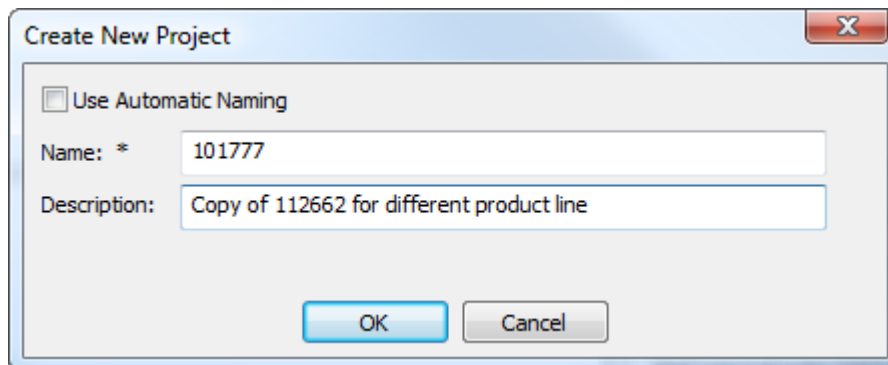

3. Click **OK**.
4. In the **Project Information** dialog box, set the fields as desired.

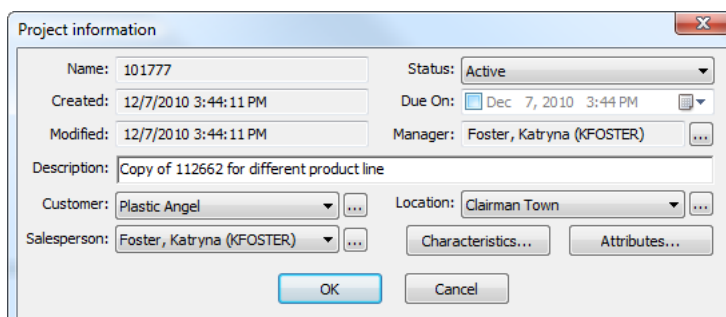

5. Click **OK** to create the new Project.

The new Project appears in **Recent Projects** and **Projects I Manage**.

Copying a Project to My Computer

When you want to work on a Project when you know you will be in offline mode later, you must first copy that Project to your computer while still in online mode.

To copy a Project to your computer, do the following:

1. Select the desired Project in any of the nodes of the Project tree in the browser.
2. You can either:
 - a) drag it from its location into the **Projects on My Computer** node
 - b) right-click it and then click **Add to My Computer** on the context menu.

ArtiosCAD Enterprise will copy the necessary information to your computer for you to work on this Project in Offline mode. When you go back into online mode, ArtiosCAD Enterprise will synchronize the changes with the online version.

Note:

You will not be able to perform certain functions while working on this Project in offline mode.

Inviting Members to a Project

If you do not make all ArtiosCAD Enterprise either Project managers with full visibility, or members of the ADMINS group, you must use WebCenter to invite users and groups to Projects you create. If you create Projects based on Templates, you still must first invite members to the Project that will become a Template.

To invite members to a Project, do the following:

1. Start a Web browser and log in to WebCenter using your ArtiosCAD Enterprise username and password.
2. Open the Project to which you want to invite members.
3. Click **Members**.
A list of the current members is shown.
4. Click **Add Members** in the column header.
5. Either filter or click **Go** to show all the users and groups available.
6. Select the users or groups to add and click **Continue**.
7. Set the folder permissions as desired; these permissions apply to all members being added in this step. Then click **Finish**.

A successful status message appears along with a list of suggested subsequent tasks.

Removing Members from a Project

To remove members from a Project so that they may no longer access it, do the following:

1. Start a Web browser and log in to WebCenter using your ArtiosCAD Enterprise username and password.
2. Open the Project from which you want to remove members.
3. Click **Members**.
A list of the current members is shown. If desired, use the filter to refine the list.
4. Select the users and groups to uninvite from the Project.
5. Hover over the menu symbol and click **Remove** on the hover menu.
6. Click **OK** to confirm the removal.

The member(s) are removed from the Project.

Viewing and Setting Project Properties

When you first create a Project you set its properties. To view or change those properties, do the following:

1. Select the Project whose properties you want to view or change.
2. Either:
 - a) click **Projects > Project Properties**

- b) Right-click the Project and click **Project Properties** on the context menu. ArtiosCAD Enterprise opens the Project Information dialog box.

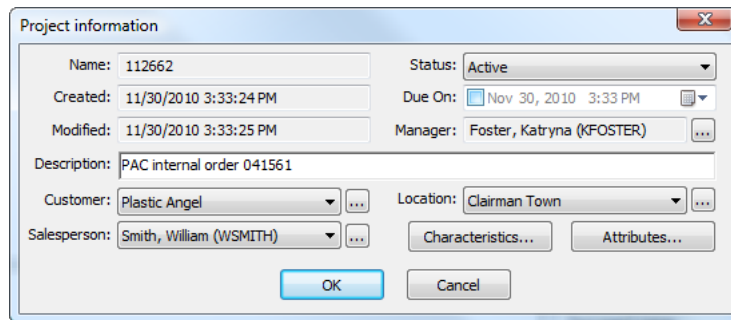

3. Change the fields as desired and click **OK** when done.

Folders

Folders let you store documents in different places within a Project. If desired, you can set individual or group permissions on folders through WebCenter.

Creating a Folder

To create a folder in a Project, do the following:

1. Select the Project in which you want to create the folder.
2.  Click **Create Folder** on the toolbar.
3. Enter a name for the new folder and press Enter.

ArtiosCAD Enterprise creates the folder in the Project.

Note:

As of this writing, a Project can have only one level of folders.

Renaming a Folder

You can only rename a folder when no documents in the Project are open.

To rename a folder, do the following:

1. Ensure all documents in the Project are closed.
2. Select the folder to rename.
3.  Click **Rename Folder** on the toolbar.
4. Type the new name of the folder and press Enter.

ArtiosCAD Enterprise renames the folder.

Deleting a Folder

You can only delete a folder when no documents in the Project are open.

Note:

Deleting a folder also deletes all the documents in it with no way to recover them. Use this procedure with caution.

To delete a folder, do the following:

1. Ensure all documents in the Project are closed.
2. Select the folder to delete.

3.  Click **Delete Folder** on the toolbar.

4. Click **Yes** when ArtiosCAD Enterprise asks you to confirm deleting the folder.

ArtiosCAD Enterprise deletes the folder.

Templates

Templates are Projects upon which you can base other Projects. You can define the members, security settings, folder structure, and Project properties once and then base future Projects on the same Template. You save them as Templates in WebCenter.

Note:

Templates may only be created by members of the ADMINS group. However, as an admin can open any Project to save it as a Template, an admin does not have to create the Project upon which a Template is based.

Creating a Template

To create a template, do the following:

1. Create the Project as desired in either ArtiosCAD Enterprise or WebCenter, inviting members, setting permissions (WebCenter only), and creating any folders as desired. Any documents in the Project will be copied into the Template as well.
2. Log in to WebCenter as a member of the ADMINS group.
3. Open the Project created in step 1.
4. Click **Save as Template** in the Project Actions menu.
5. Enter the name of the template and a description in the appropriate fields.

To use a custom thumbnail for use in WebCenter, click **Specify New Thumbnail** and enter the complete path and filename in the associated field or **Browse** for it. To use the default thumbnail, leave that choice selected.

6. Click **Finish**.

The Template is created.

Deleting a Template

To delete a template, do the following:

1. Log in to WebCenter as a member of the ADMINS group.
2. Click **Admin > Project Management > Templates**.
3. Click the checkbox next to the name(s) of the Template(s) to delete.
4. Hover over the menu symbol and click **Delete** from the pop-up menu.
5. Click **OK** to confirm the deletion(s).

WebCenter deletes the template(s).

Changing a Template

To change a template, do the following:

1. Log in to WebCenter as a member of the ADMINS group.
2. Click **Admin > Project Management > Templates**.
3. Click the name of the Template to change.
4. Change any of the Template properties as desired.

Changing documents in a Template, other than deleting them or moving them between folders, is not possible and is best accomplished by creating a new Project based on the original Template, adding the desired documents, and saving the Project as a new Template.

Tasks

You can perform basic task-related functions in ArtiosCAD that are relevant for a structural designer. Use WebCenter for most task configuration and administration.

Linking a Managed Document to a Task

To link a managed document to a task, do the following:

1. Make it so you can see the desired task in the tree control - in a Project or one of the My Tasks nodes. Note that the task must be configured in WebCenter to allow attachments.
2. Navigate to the document.
3. Do one of two things:
 - a) Drag the document and drop it onto the task. As you drag, a ghost image of the document thumbnail appears, and the cursor shows a task if the document is already in the same Project as the task.

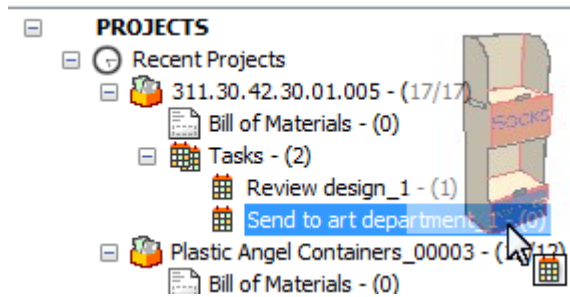

If you are dropping the document onto a task in a different Project, the default action is to move the document to the new Project. To copy the document instead into the Project containing the target task, hold down either SHIFT or CTRL. To link it, hold down ALT. The drag cursor changes to a plus sign, a move arrow, or a link arrow to indicate the action ArtiosCAD takes.

- b) Right-click the document and click **Copy Documents** on the context menu. Then right-click the task and click **Link Documents to Task**. If the target task is not in the same Project, you can either **Link Documents to Task as Copy** or **Link Documents to Task as Link**. In either case, that document you assign to a task in a different Project now appears in that different Project as well.

Linking an Unmanaged Document to a Task

To link an unmanaged document to a task, do the following:

1. Make it so you can see the desired task in the tree control - in a Project or one of the My Tasks nodes. Note that the task must be configured in WebCenter to allow attachments.
2. Navigate to the document.
3. Do one of two things:
 - a) Drag the document and drop it onto the task.

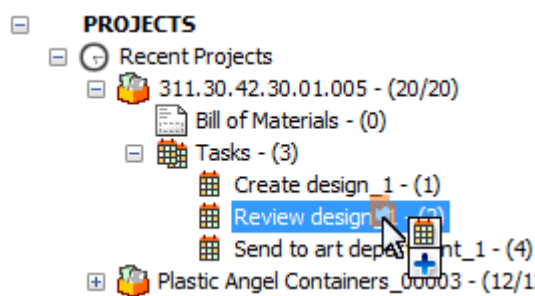

ArtiosCAD copies the document to the Project containing the task and makes it a managed document.

- b) Right-click the document and click **Copy Documents** on the context menu. Then right-click the task and click **Link Documents to Task as Copy**. ArtiosCAD copies the document to the Project containing the task and makes it a managed document.

Starting a Task

There are three ways to start a task which has not yet been started.

1. To start a task from the tree control, do the following:
 - a) Select the task in the tree.
 - b) Right-click the task and click **Start Task**.

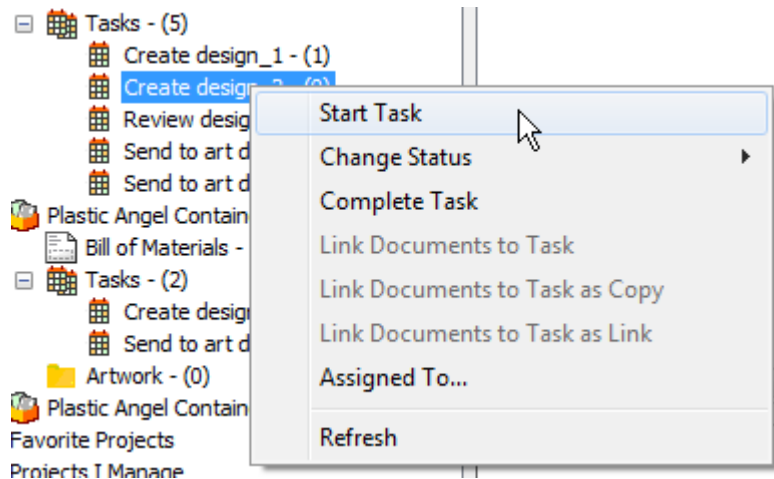

- c) ArtiosCAD starts the task.
2. To start a task from the list in the document list, do the following:
 - a) Select a Tasks node in the tree control so its tasks appear in the document list.
 - b) Right-click the task and click **Start Task**.

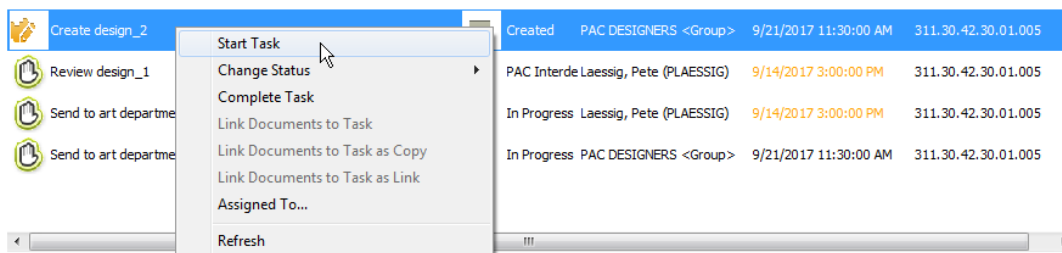

- c) ArtiosCAD starts the task.
3. Change the status of a task, which automatically starts it. Changing a task status is covered in the next section.

Changing the Status of a Task

There are three ways to change the status of a task in the browser.

Note:

Changing the status of a task starts a task if it is not already started.

1. Right-click the task on the tree control and click **Change Status** on the context menu. Choose the new status from the resulting context menu. ArtiosCAD shows the current task in bold.

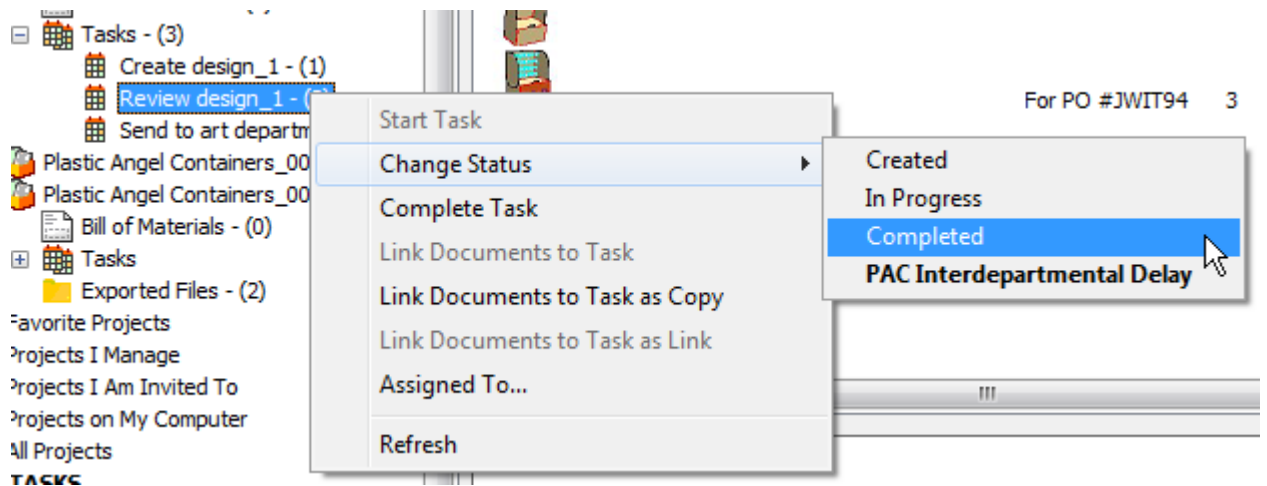

2. Select the task in the documents list, right-click it, and click **Change Status** on the context menu. ArtiosCAD shows the current task in bold.

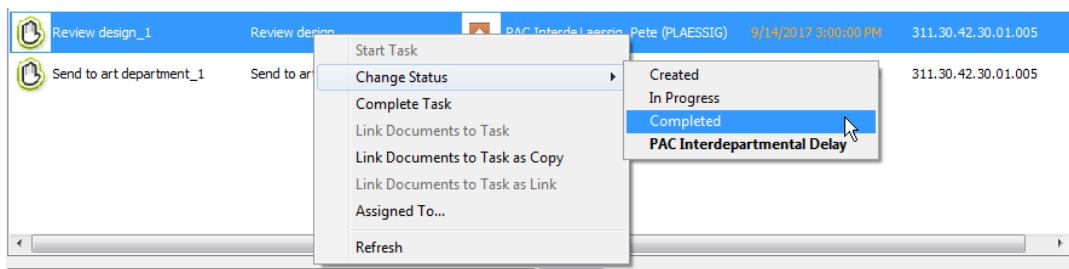

3. Select the task in the documents list and edit the Status field on the General tab in the Details pane. Make sure to save the changes after you have changed the status.

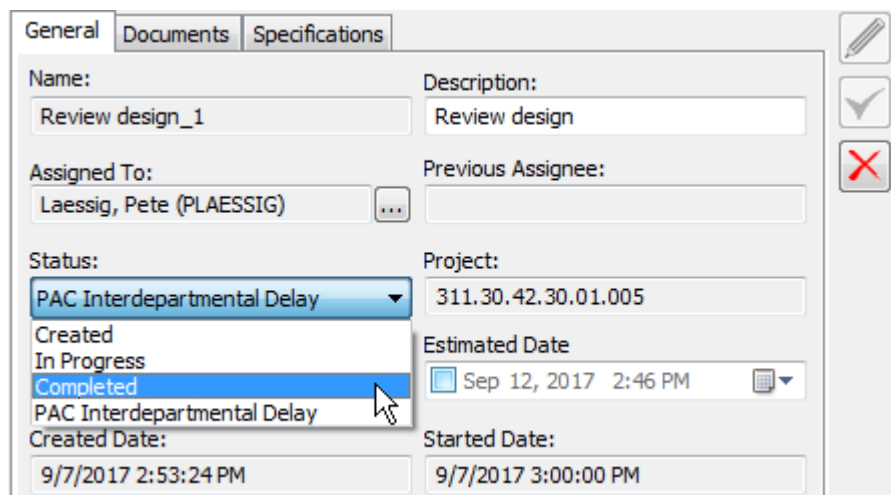

Note:

For either of the context menu methods, you can also click **Complete Task** to more directly mark the task complete.

Changing the Assignee of a Task to Someone Else

There are three ways to change the assignee of a task to someone else in the browser.

1. Right-click the task in the tree control.
 - a) Click **Assign To** on the context menu.

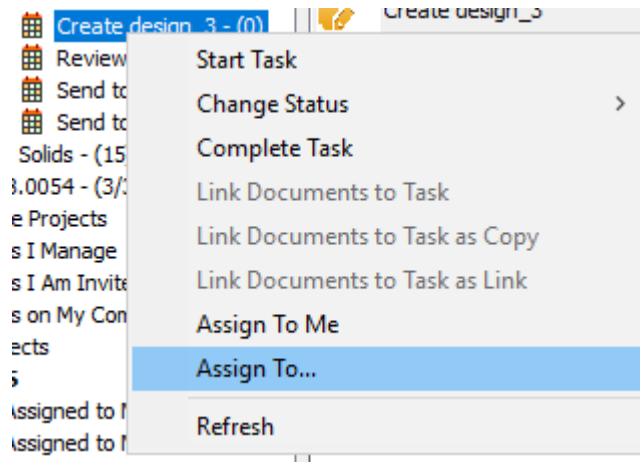

- b) In the Task Assignee dialog box, choose the new assignee. You can select either a person or a group. ArtiosCAD shows the entries in the same order as WebCenter.

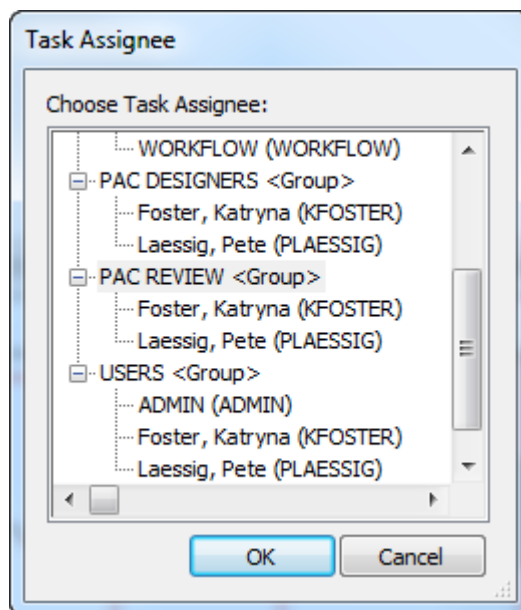

- c) Click **OK**.

2. Select the task in the documents list and right-click it.
 - a) On the context menu, click **Assign To**.

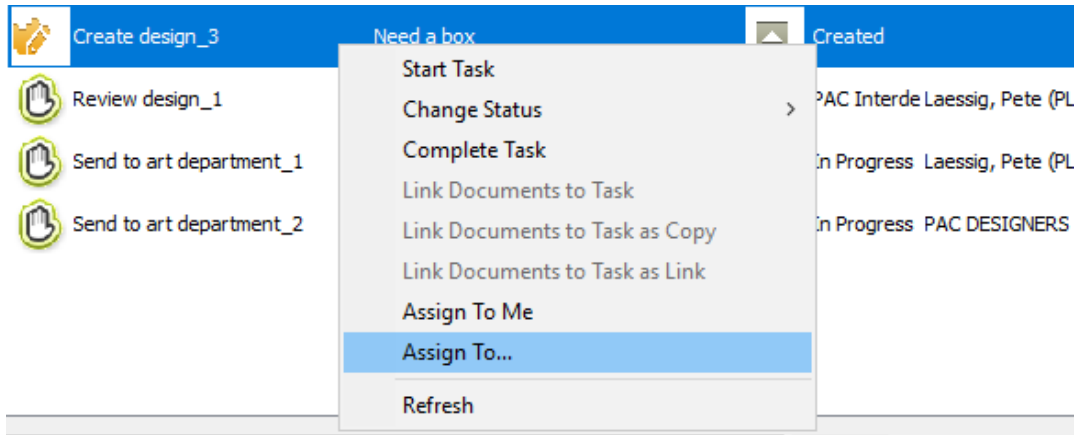

- b) In the Task Assignee dialog box, choose the new assignee. You can select either a person or a group. ArtiosCAD shows the entries in the same order as WebCenter.

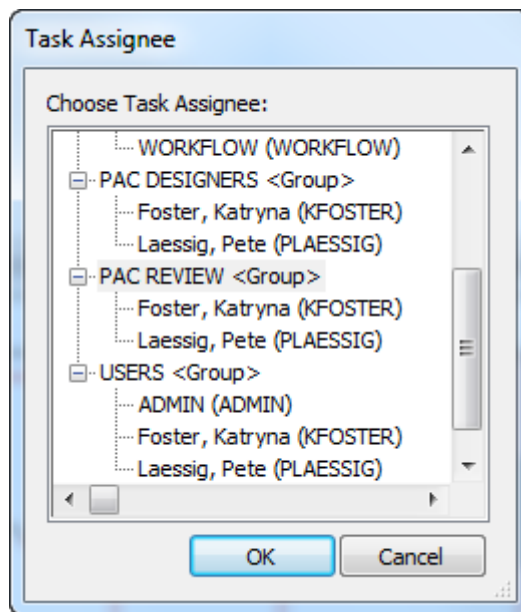

- c) Click **OK**.
3. Select the task in the documents list, and edit the fields on the General tab.
 - a) Click the More Options button at the end of the Assigned To field.

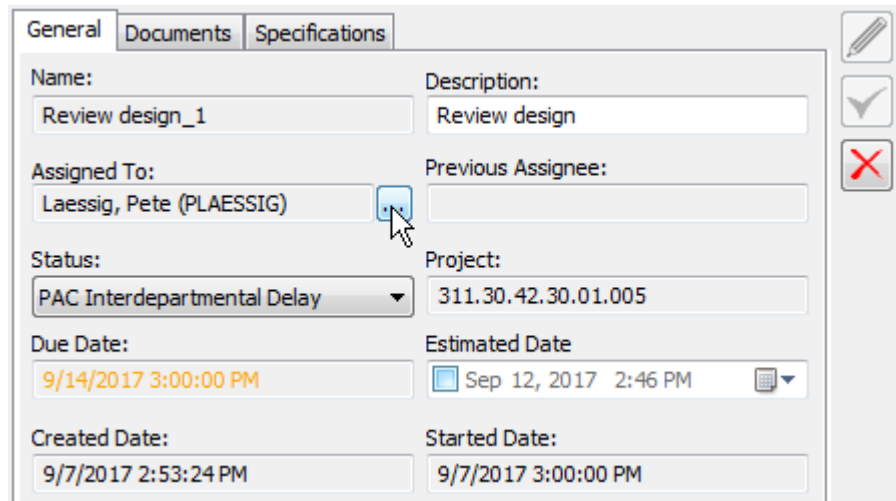

b) In the Task Assignee dialog box, choose the new assignee. You can select either a person or a group. ArtiosCAD shows the entries in the same order as WebCenter.

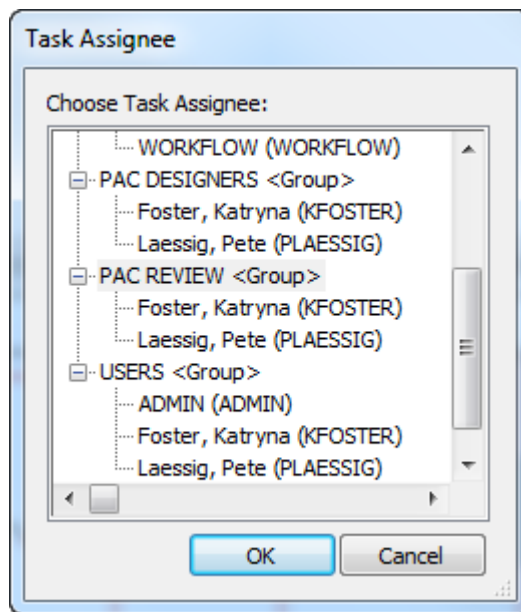

c) Click **OK**.

Note:

Even though you can reassign a task to someone else, if the document in that task is open, it will need to be manually unlocked by an administrator or the Project manager before the new assignee can work on it.

Changing the Assignee of a Task to Yourself

You can quickly take ownership of a task in a Project of which you are a member.

1. Right-click the task in the tree control.

- a) Click **Assign To Me** on the context menu.

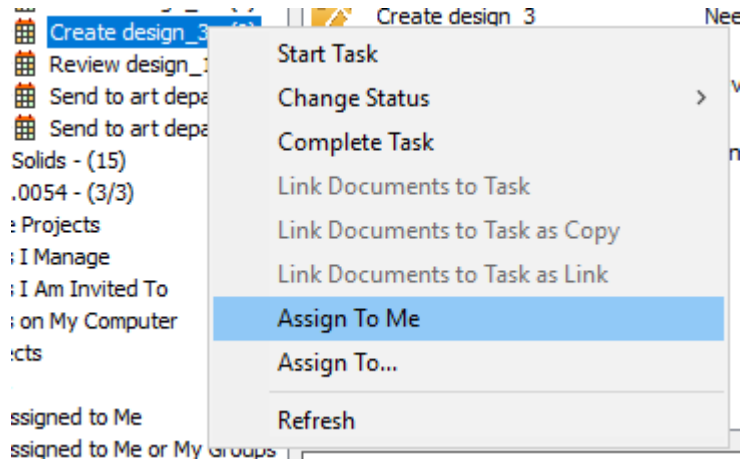

- 2. Select the task in the documents list and right-click it.

- a) On the context menu, click **Assign To Me**.

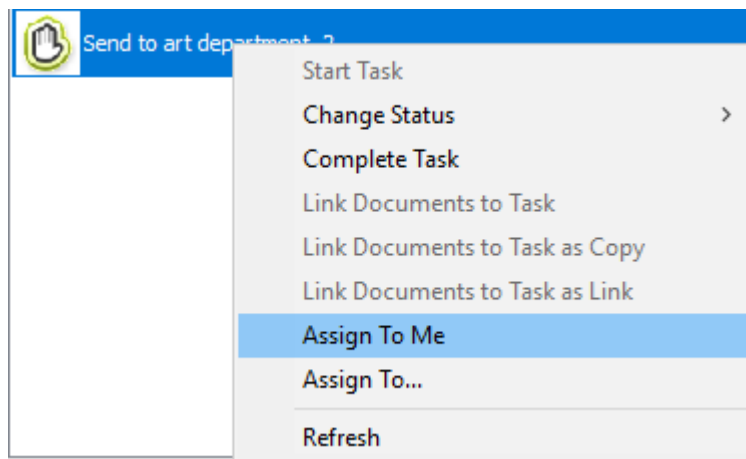

Removing a Document from a Task

To remove a document from a task, do the following:

1. Select a task in the tree so that its documents appear in the documents list.
2. Select the document(s) to remove from the task.
3. Right-click and click **Remove Documents from Task**.

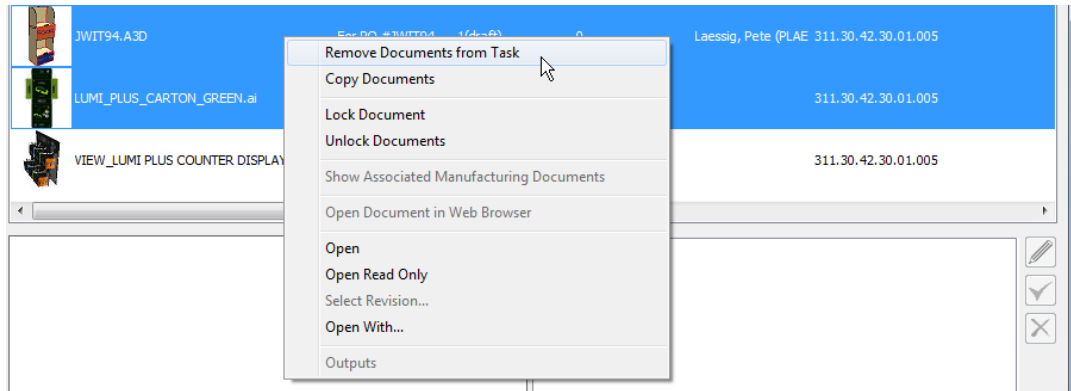

4. ArtiosCAD removes the selected document(s) from the task.

Changing the Checklist of a Task

When you have a task selected in the Documents pane, a tab for its checklist appears in the Details pane of the browser.

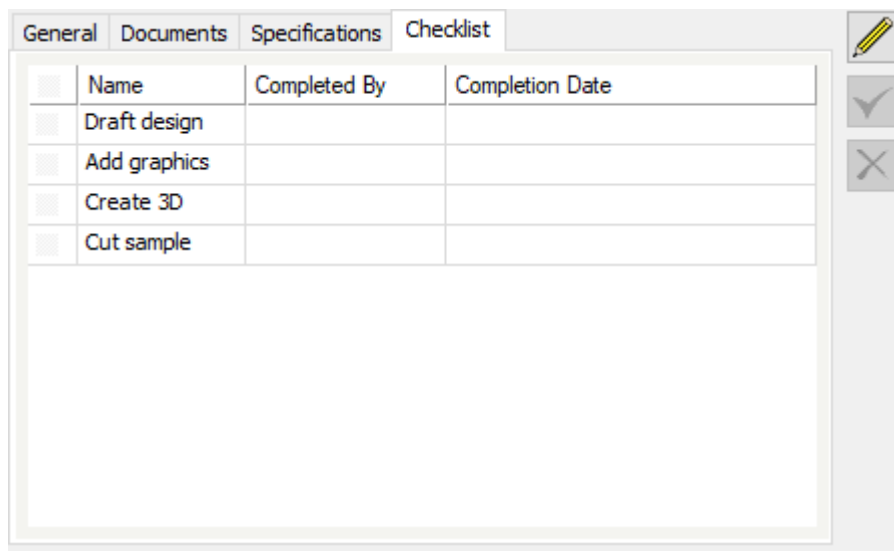

1. Select the desired task to change in the Documents pane.
2. Click the Checklist tab in the Details pane.
3.  Click **Edit**.
4. Click the checkboxes for the steps to mark complete.

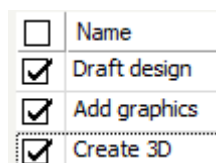

5. Click **Save** to submit the changes to WebCenter, or click Cancel to cancel your changes.
6. ArtiosCAD submits the changes to WebCenter and updates the checklist.

<input type="checkbox"/>	Name	Completed By	Completion Date
<input checked="" type="checkbox"/>	Draft design	Laessig, Pete (PLAE)	6/8/2018 1:17:31 PM
<input checked="" type="checkbox"/>	Add graphics	Laessig, Pete (PLAE)	6/8/2018 1:17:31 PM
<input checked="" type="checkbox"/>	Create 3D	Laessig, Pete (PLAE)	6/8/2018 1:17:31 PM
<input type="checkbox"/>	Cut sample		

ArtiosCAD respects two options in the task definition in WebCenter:

- **Finish Task if all steps from checklist are completed**
- **Only a Task Assignee can check off checklist items**

The screenshot shows the 'Task Type: Create design' configuration page in WebCenter. The page has a dark header with navigation options: 'My Work', 'Projects', 'Task Types', and 'Search'. Below the header, the task title 'Task Type: Create design' is displayed, along with a description 'Description: Create design' and 'Created by: ADMIN (ADMIN)'. There are four tabs: 'General Info', 'Specifications', 'Checklist', and 'Status', with 'Checklist' being the active tab. Under the 'Checklist' tab, there are two checkboxes: 'Finish Task if all steps from checklist are completed' and 'Only a Task Assignee can check off checklist items'. Below these are two buttons: '+ Add more steps' and 'Delete Section(s)'. At the bottom, there is a table for defining checklist items:

<input type="checkbox"/>	Display Order	Checklist Item
<input type="checkbox"/>	1	Draft design
<input type="checkbox"/>	2	Add graphics
<input type="checkbox"/>	3	Create 3D
<input type="checkbox"/>	4	Cut sample

This means that if these items are checked in WebCenter, if you mark all the checklist items as completed, WebCenter will complete the task, and that you will not be able to edit the checklist if you are not the Task Assignee.

Opening a Task in WebCenter

1. Right-click a Task in either the My Tasks node or in the Document list and click **Open Task in Web Browser**.

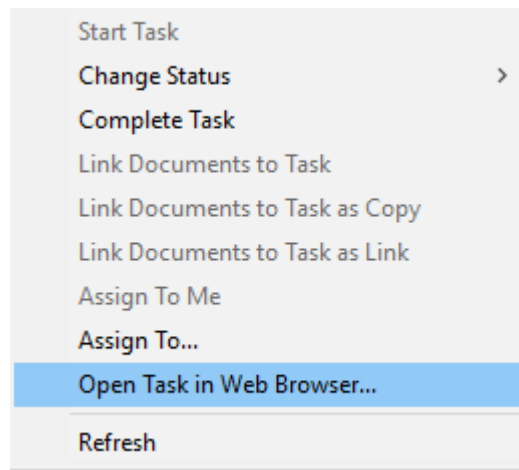

2. The Task definition appears in WebCenter.

Task: Create design_1 Project: 311.30.42.30.01.005

Return Complete Task

Description For customer EAB

Status In Progress

Assigned to Me

Due Jun 14, 2018 at 11:30 AM

Estimated

Task Documents

+ Upload + Link Download

Thumbnail	Name	Version	Approval Status
	jwtr94.ARD	5(B)	

Name	Value
CAD_OFFSET_X	in.
PAC Location for Storage	Warehouse 2 Text

Checklist

Name	Completed by	Completion date
<input type="checkbox"/> Draft design		
<input type="checkbox"/> Add graphics		
<input type="checkbox"/> Create 3D		
<input type="checkbox"/> Cut sample		

Return Complete Task

Completing a Task

There are four ways to complete a task. A task does not have to be started in order to be completed.

1. To complete a task from the tree control, do the following:
 - a) Select the task in the tree.
 - b) Right-click the task and click **Complete Task**.

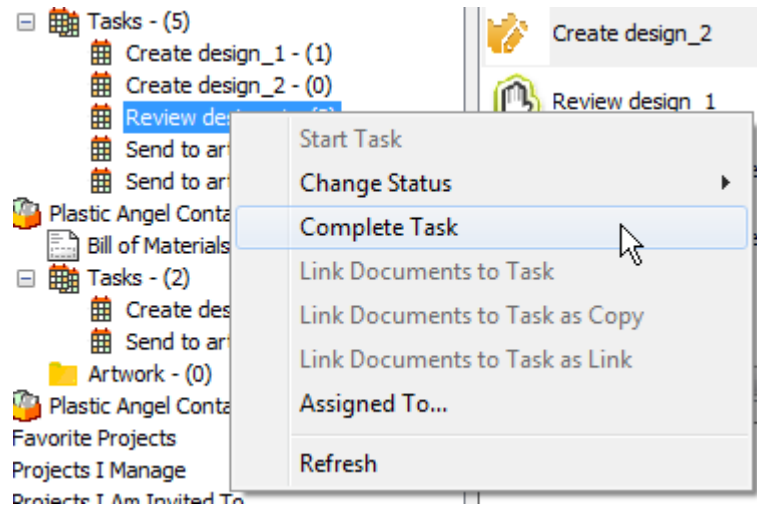

- c) Alternately, click **Change Status** and then click **Completed**.

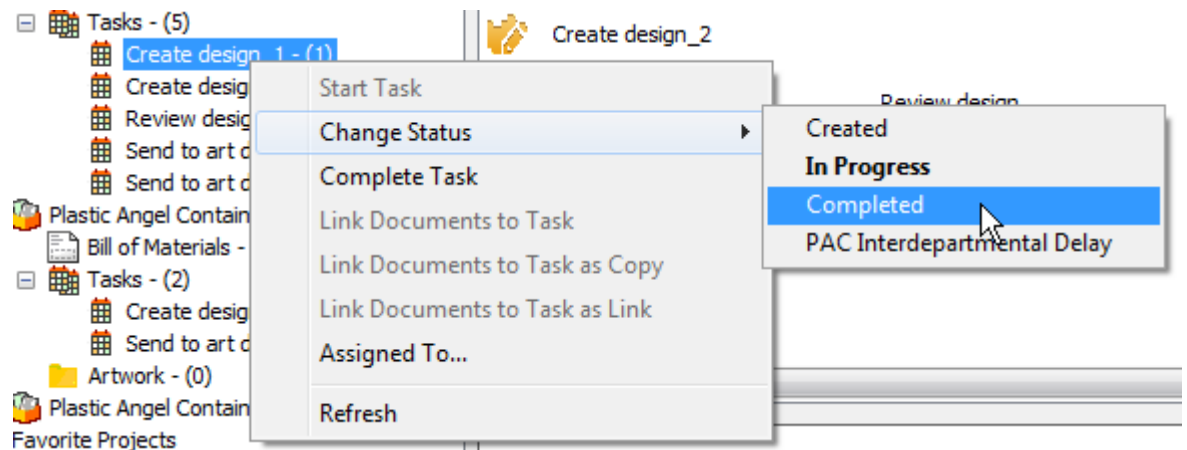

- d) ArtiosCAD completes the task.
2. To complete a task from the list in the document list, do the following:
 - a) Select a Tasks node in the tree control so its tasks appear in the document list.
 - b) Right-click the task and click **Complete Task**.

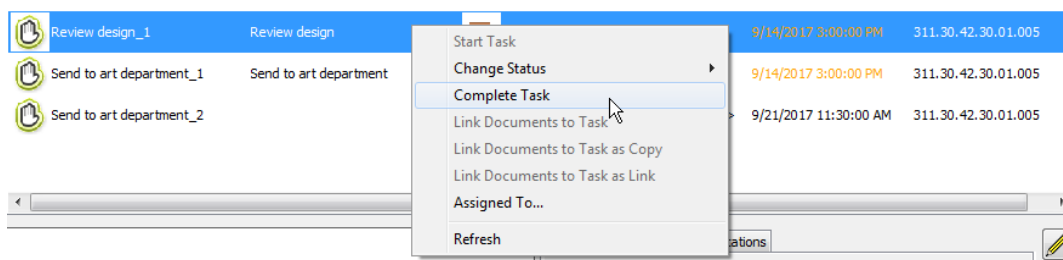

c) Alternately, click **Change Status** and then click **Completed**.

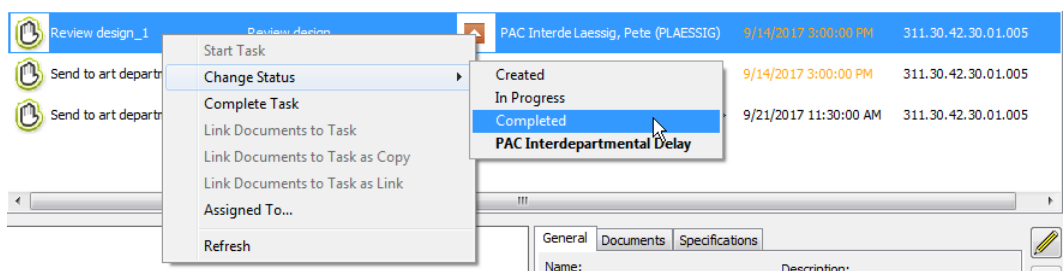

d) ArtiosCAD completes the task.

Documents

Saving a Managed Document

Saving a document is the point at which you can choose to make it managed by saving it as part of a Project.

Note:

You can also save it as an unmanaged document by using the Explorer node in the browser.

Note:

When you decide a filename for a managed document, do not use any of these characters: \ / : * ? " < > .

To save a managed document, do the following:

1. Create the document - a single design, a manufacturing file, or a 3D workspace - as desired.
2. Click **Save** on the toolbar.
3. Select the Project and folder (optional) in which to save this document. If the desired Project or folder does not exist, create it using the buttons on the toolbar.
4. Enter the filename and click **Save**. Comments are unavailable for the first version of a managed document.

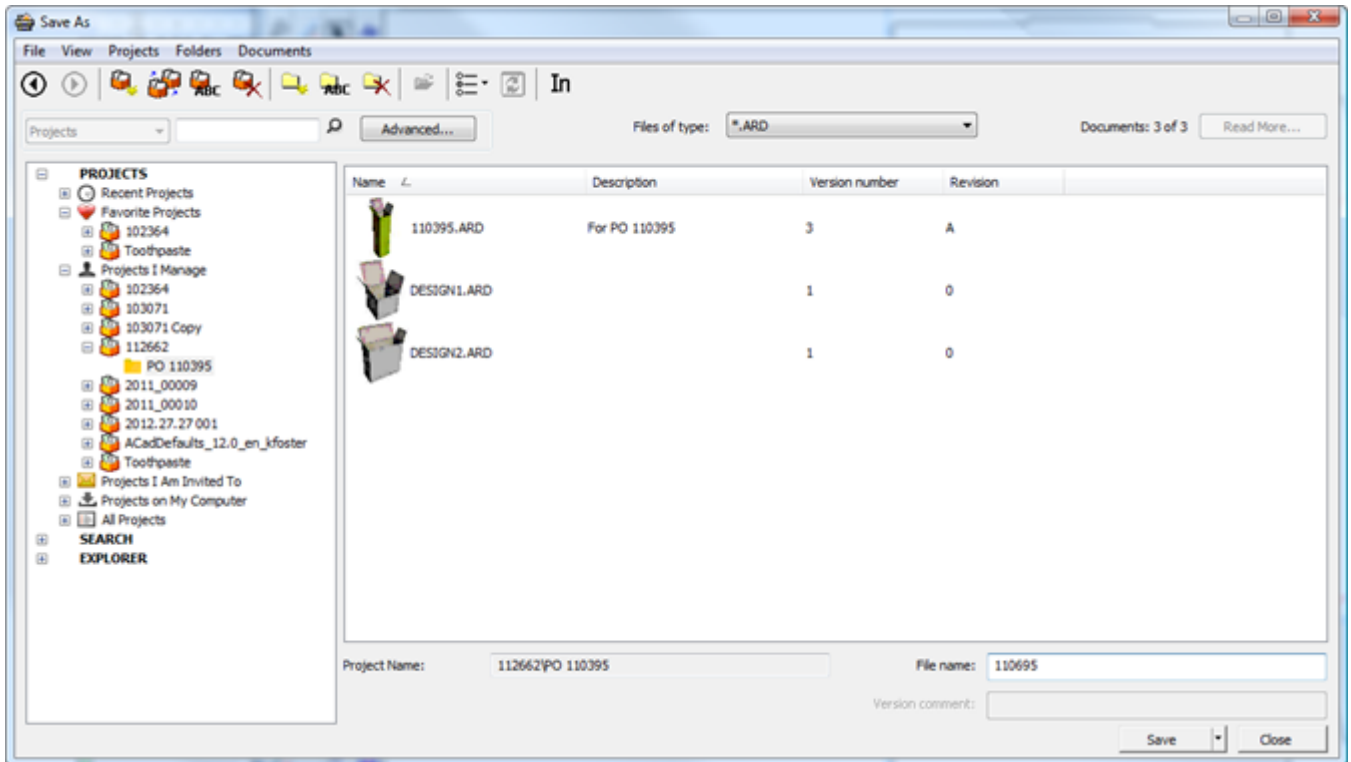

5. In the **Database Information** dialog box, fill in the fields as appropriate and click **OK**.

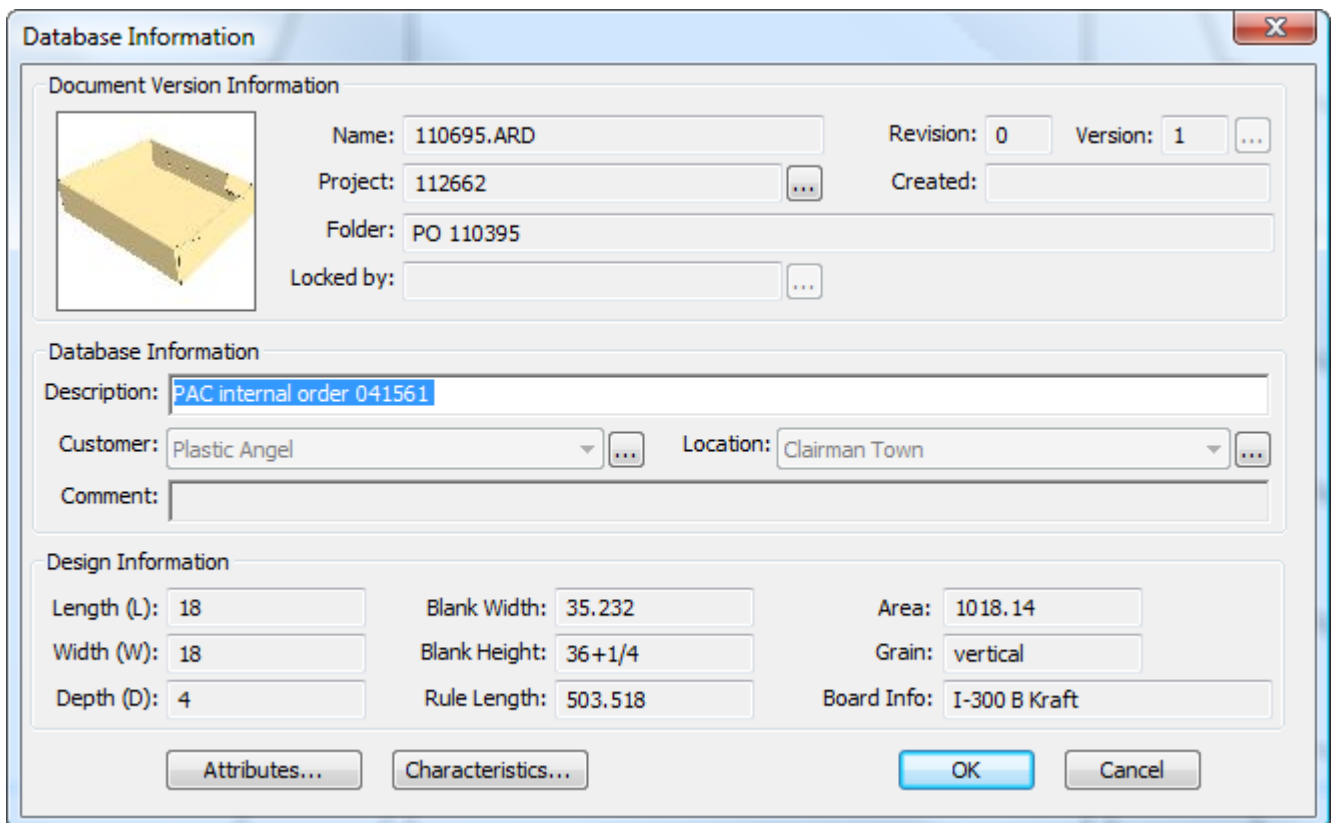

If your WebCenter administrator has configured multi-value prompted Attributes and you have made customized Database Information dialog boxes containing them, check their values as desired.

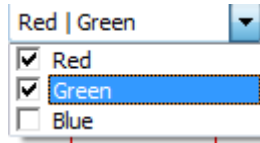

If your WebCenter administrator has configured cascading Attributes based on a list and you have made customized Database Information dialog boxes containing them, the values of the child Attributes depend on the parent Attributes you select. In the examples below, the Attributes chosen for the Type control what you can choose for the Name.

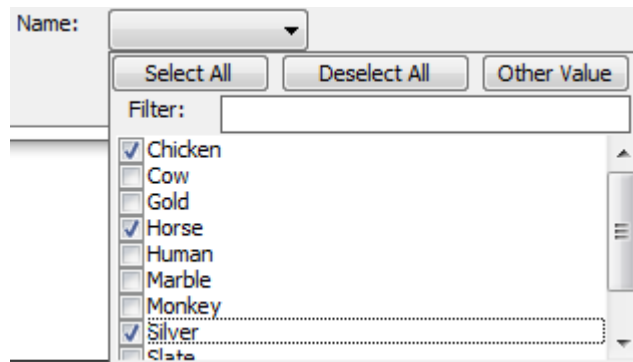
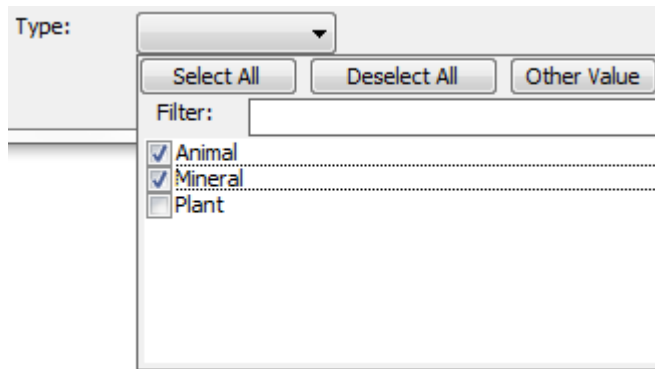

Select All and **Deselect All** select and deselect all the Attributes. Click **Other Value** to specify a value that is not in the list. Set a Filter to reduce the number of Attributes available to select; the comparison is case-sensitive.

After you have saved a managed document, by default when you click **Save** again, ArtiosCAD saves a draft. This behavior is customizable in **Defaults > Startup defaults > Save Options**.

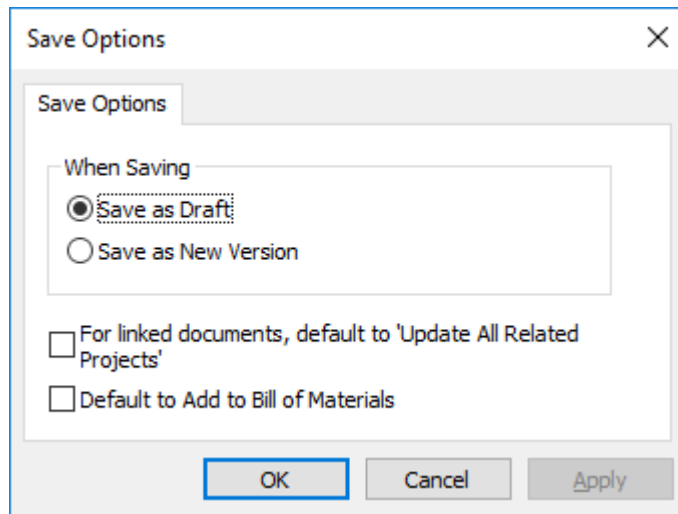

If you select **Save as New Version**, the **Save Draft** command appears on the File menu so that you can still save drafts, and **Publish Version** disappears since it is replaced by **Save**.

You can also set shortcuts to the different save and publish commands in the Shortcuts catalogs in Defaults.

Note:

ArtiosCAD Enterprise uses the Default Attribute category view from WebCenter Also, cascading Attributes are not supported in Offline mode.

Additional commands on the Save button

The Save button in the browser has a drop-down menu containing three commands: **Save**, **Save Next Document**, and **Save Next Document into New Project**.

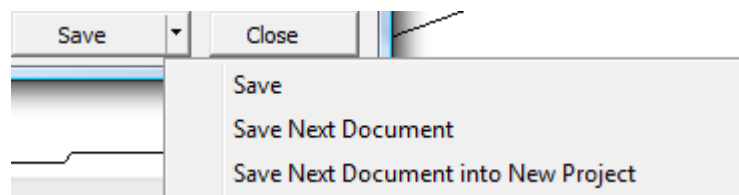

Save Next Document uses the automatic name generation feature configured in WebCenter to assign the next available name to the document and save it in the selected folder and Project. It is available only when you have selected a managed path in the browser. If the autonaming is configured to prompt you for a suffix, the Suffix field appears in the Database Information dialog box.

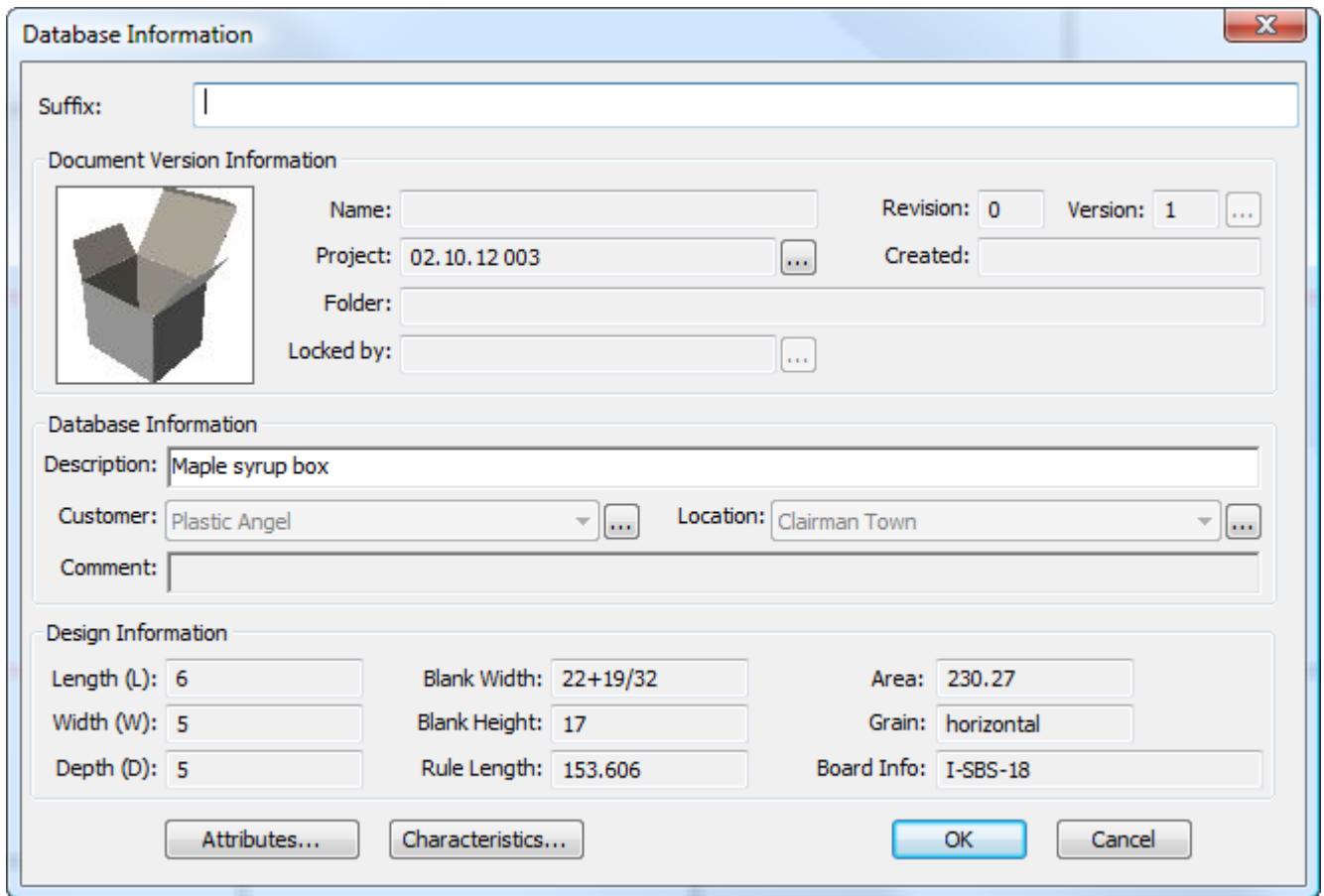

Save Next Document into New Project prompts you to create a new Project before saving the document with the next available name into it. If automatic naming is available, use it by checking **Use Automatic Naming**. Enter the name (if you are not using automatic naming) and a description in the fields provided. Choose a Template if desired and click **OK** to continue saving the document.

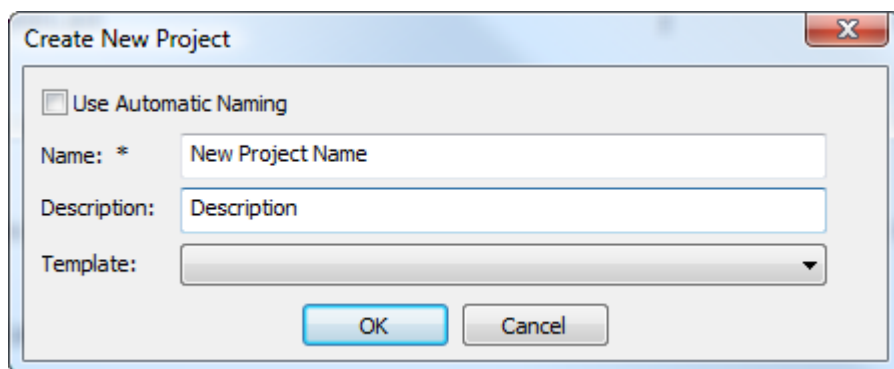

ArtiosCAD will prompt you for information about the new Project.

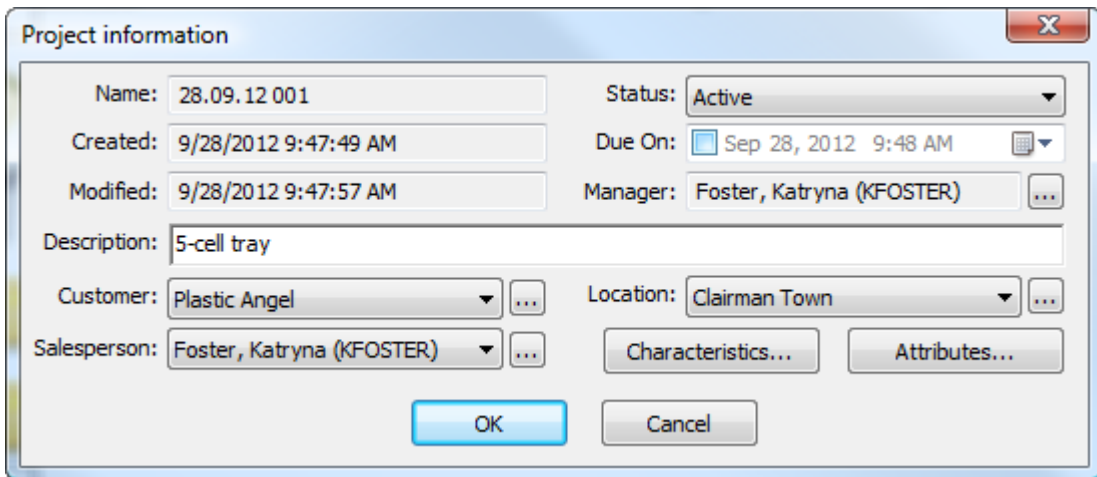

Click **OK** to finish saving the document into a new Project.

The browser remembers the last Save command used and changes the button accordingly.

Saving an Unmanaged Document

Saving an unmanaged document is like saving a managed document, except you either navigate to a location in the Explorer node, or you type that location directly in the Filename field in the Save As dialog box as part of the filename (such as C:\TEMP\TEST.ARD).

Unmanaged documents have no database information and no security beyond that of the file system. Use caution when saving unmanaged documents.

Publishing a New Version of a Managed Document

The first time you save a managed document, you enter all its database information. The next time you work on that document, you can:

- save it as a draft, meaning it is a work-in-progress and not a new revision or version
- publish it as a new revision
- publish it as a new version

It is up to you to decide if it is a draft, revision, or version according to your company's best practices. Some people publish minor changes as revisions and major changes as versions; others do the opposite, and yet others just save drafts.

Note:

New versions of documents do not affect Bills of Materials. To have your changes reflected in Bills of Materials, publish a new revision instead.

To publish a new version of a managed document, do the following:

1. Work on the document as desired and click **File > Publish Version**. If **Publish Version** is not on the File menu, click **Save**.

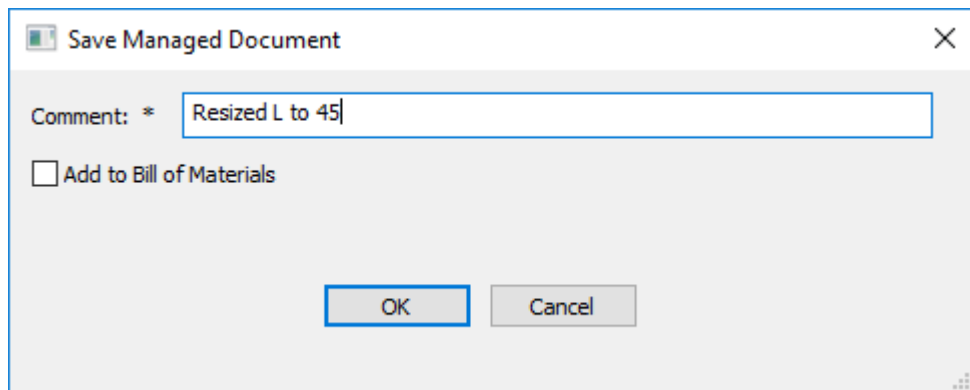

- a) If the document is in more than one Project, you can choose the checkbox of each Project to update with this new version. Use the checkboxes at the top of each column to toggle all the checkboxes in the column.

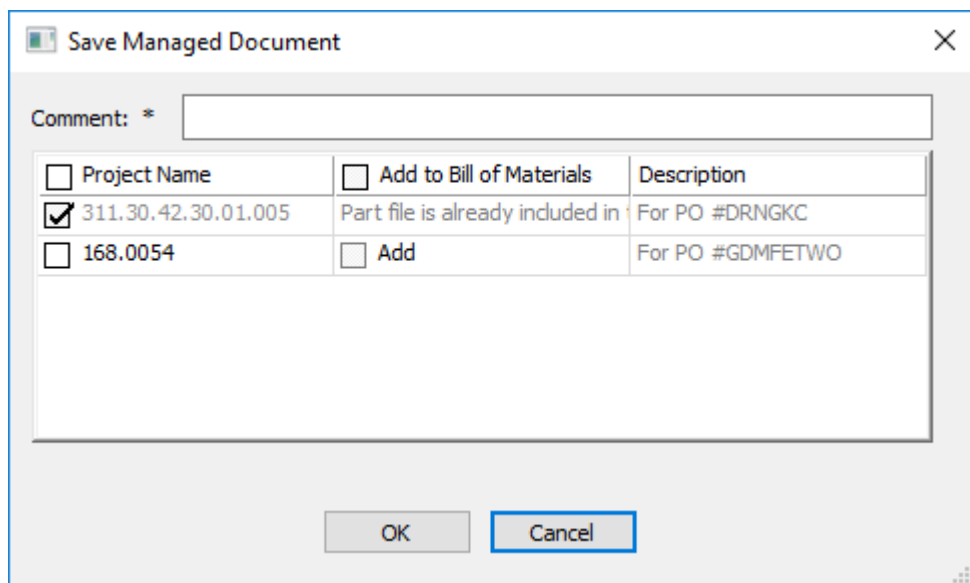

- 2. Enter a comment if that field is blank and click **OK** to continue the process of publishing the managed document.
 - a) For a single design, the Database Information dialog box appears similar to the one shown below. Enter information in the fields as desired and click **OK** to complete the publishing process.

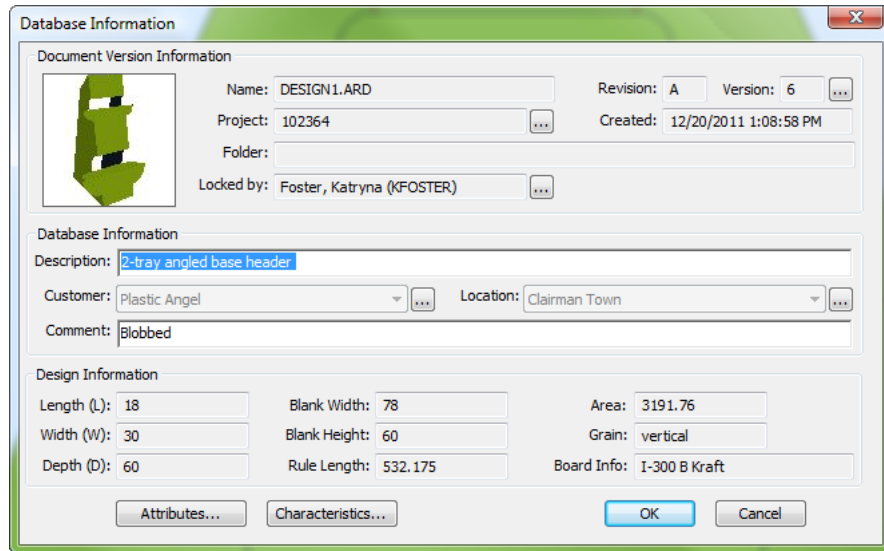

b) For a manufacturing document, the Database Information dialog box appears similar to the one shown below. Enter information in the fields as desired and click **OK** to complete the publishing process.

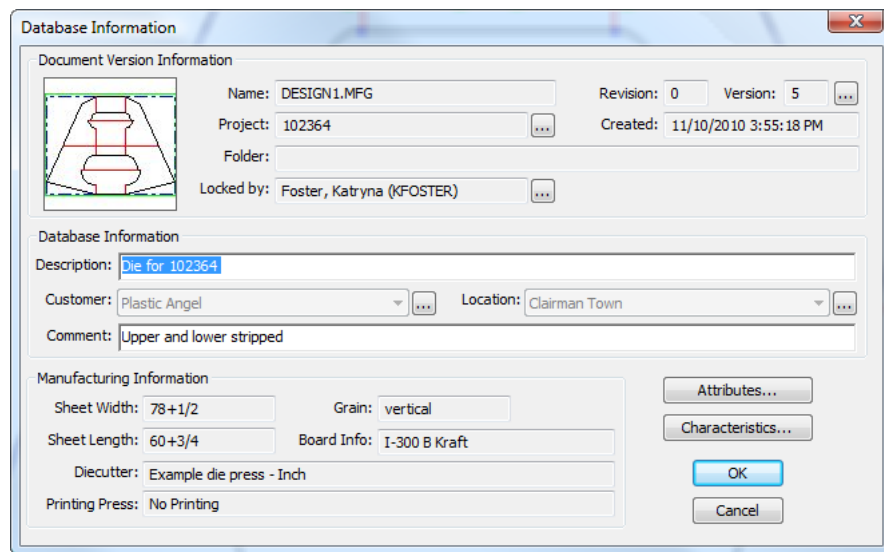

c) For a 3D design, the Database Information dialog box appears similar to the one shown below. Enter information in the fields as desired and click **OK** to complete the publishing process.

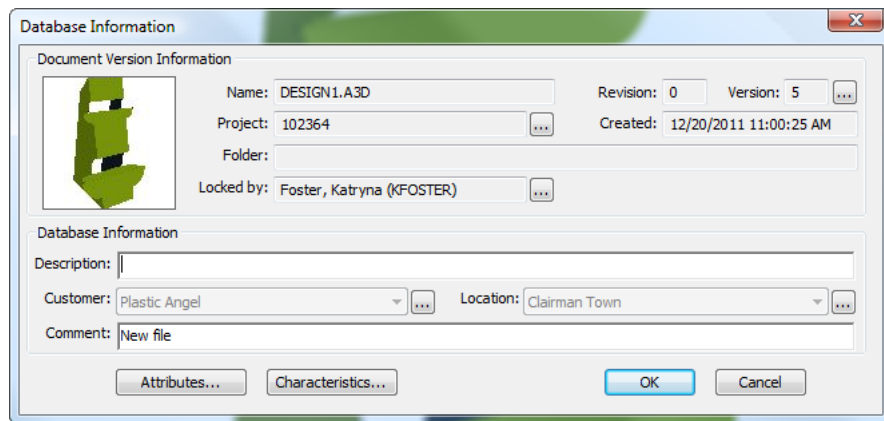

Publishing a New Revision of a Managed Document

Publishing a new revision of a document is similar to publishing a new version. Unlike a new version, however, a new revision can also optionally update any Bills of Materials in the Project(s) to which the document belongs. To publish a new revision of a managed document, do the following:

1. Click **File > Publish Revision**.
2. In the Save Managed Document dialog box, enter a comment for the revision. This dialog box has a different appearance depending on if this document exists in more than one Project and/or is in the BOM.

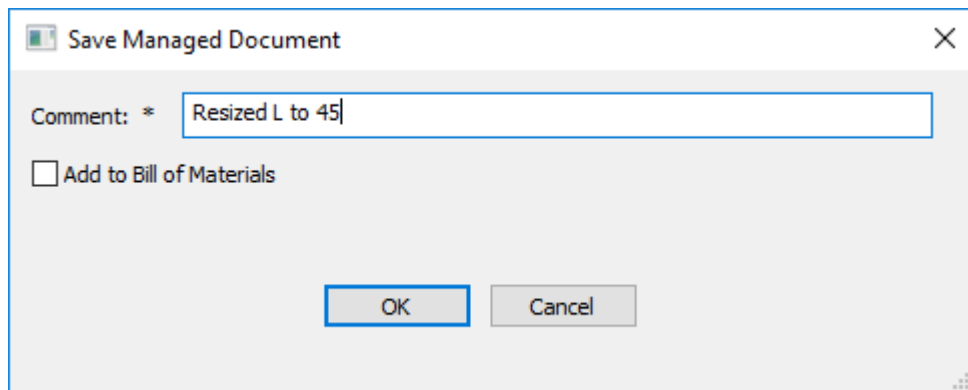

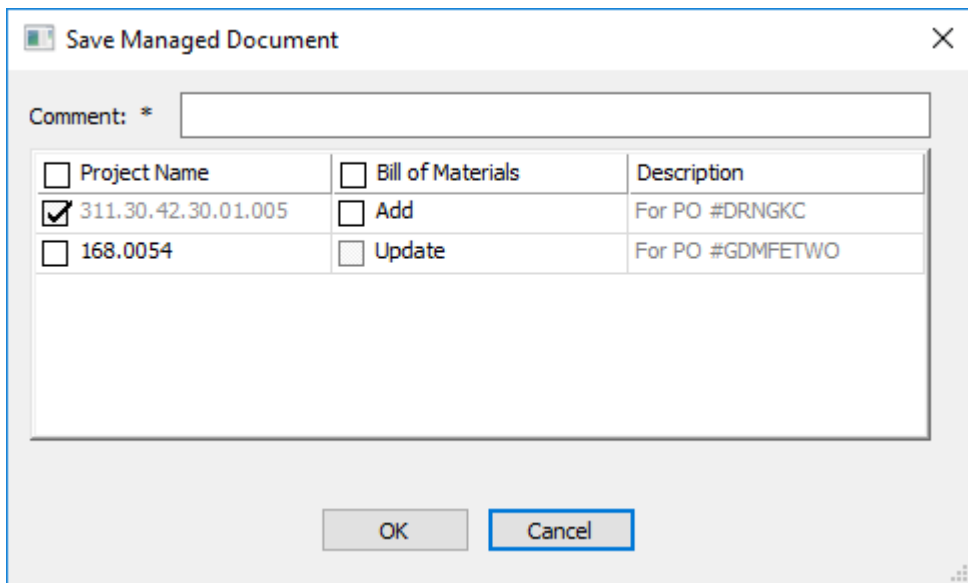
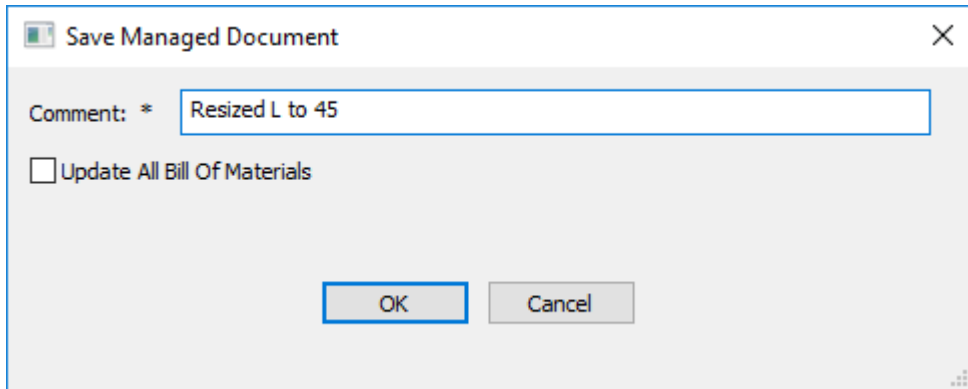

- a) If you select it, **Update all Bill of Materials** updates all Bills of Materials containing this document.
 - b) If the document is in more than one Project, you can choose which Projects to update and to either **Add** or **Update** Bills of Materials as appropriate. Use the checkboxes at the top of each column to toggle all the checkboxes in the column.
3. Click **OK** to continue the process of saving the managed document.
- a) For a single design, the Database Information dialog box appears similar to the one shown below. Enter information in the fields as desired and click **OK** to complete the publishing process.

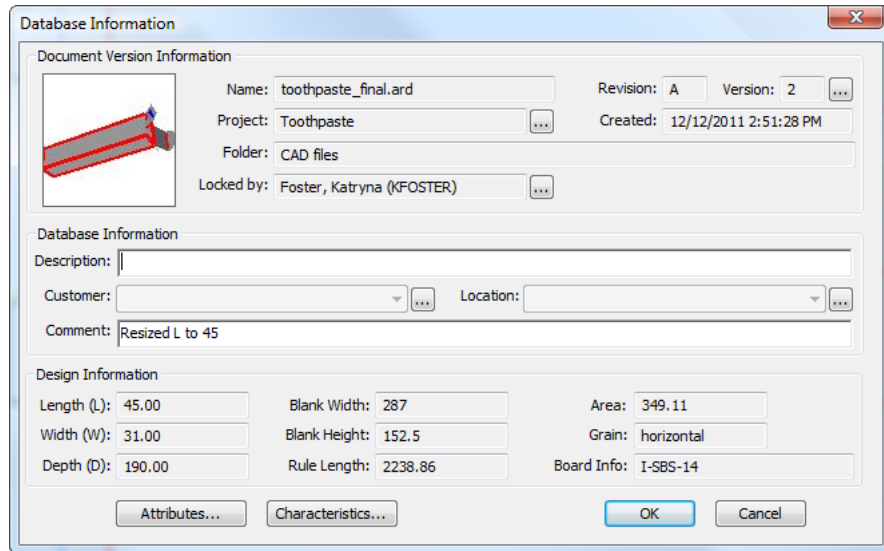

b) For a manufacturing document, the Database Information dialog box appears similar to the one shown below. Enter information in the fields as desired and click **OK** to complete the publishing process.

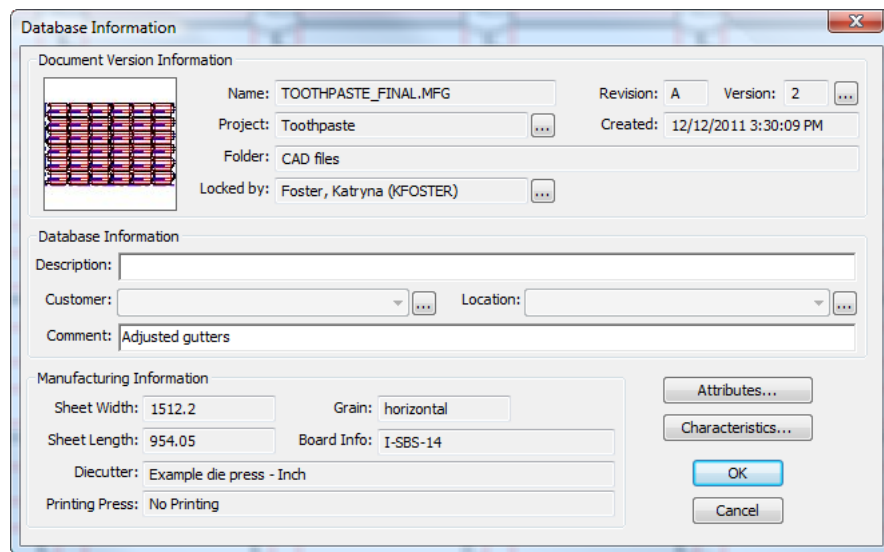

c) For a 3D design, the Database Information dialog box appears similar to the one shown below. Enter information in the fields as desired and click **OK** to complete the publishing process.

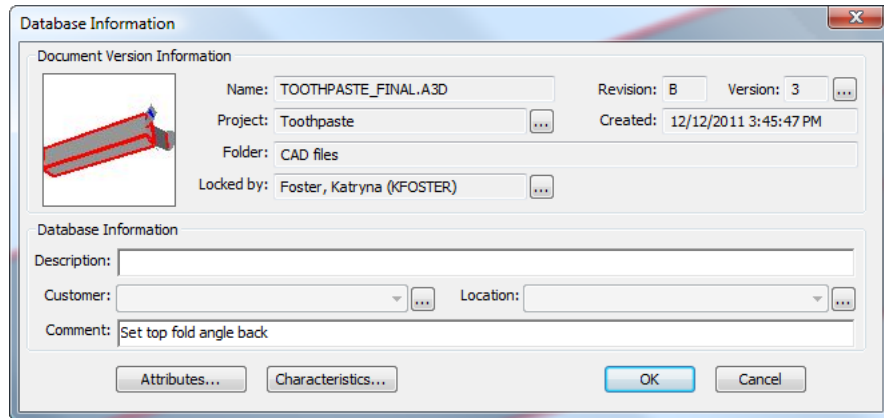

Opening a Document

To open a document in ArtiosCAD Enterprise, do the following:

1. If the browser is not already open, open it by:
 - a) clicking its button on the toolbar



- b) clicking **File > Browser**
 - c) pressing CTRL-B.
2. In the browser, navigate to the Project and folder containing the desired document. If the desired document is unmanaged, use the Explorer node to open the drive and folder containing it.
3. Select the desired document in the document list.

4.  Either double-click the document to open it, or click **Open** on the toolbar.

ArtiosCAD Enterprise opens the document for editing.

Additional Methods for Opening Documents

When you right-click a document in the document list, the context menu shows additional methods to open it.

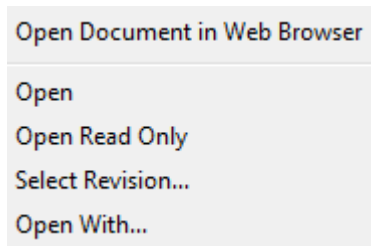

Open Document in Web Browser opens the document in WebCenter using your system's default Web browser and your current login credentials.

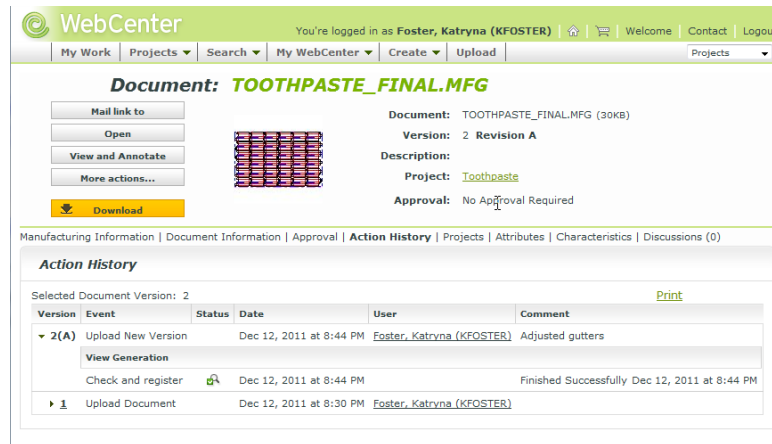

Open opens the selected document(s) for editing.

Open Read Only opens the selected document(s) for viewing.

Use **Select Revision** to open a specific version of the selected document. Click the desired version in the Version History dialog box and then click **Open**.

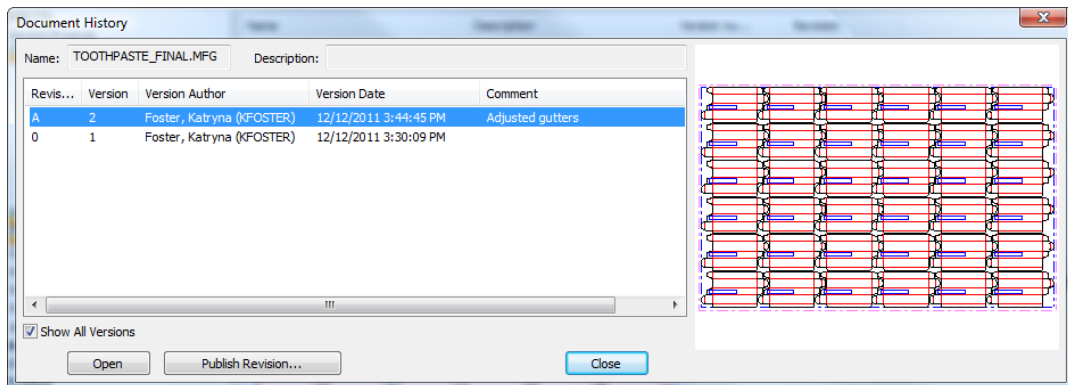

Open With lets you choose the program to edit an unmanaged temporarily downloaded version of the selected document(s). Choose the desired program and click **OK** to launch it and open the document(s).

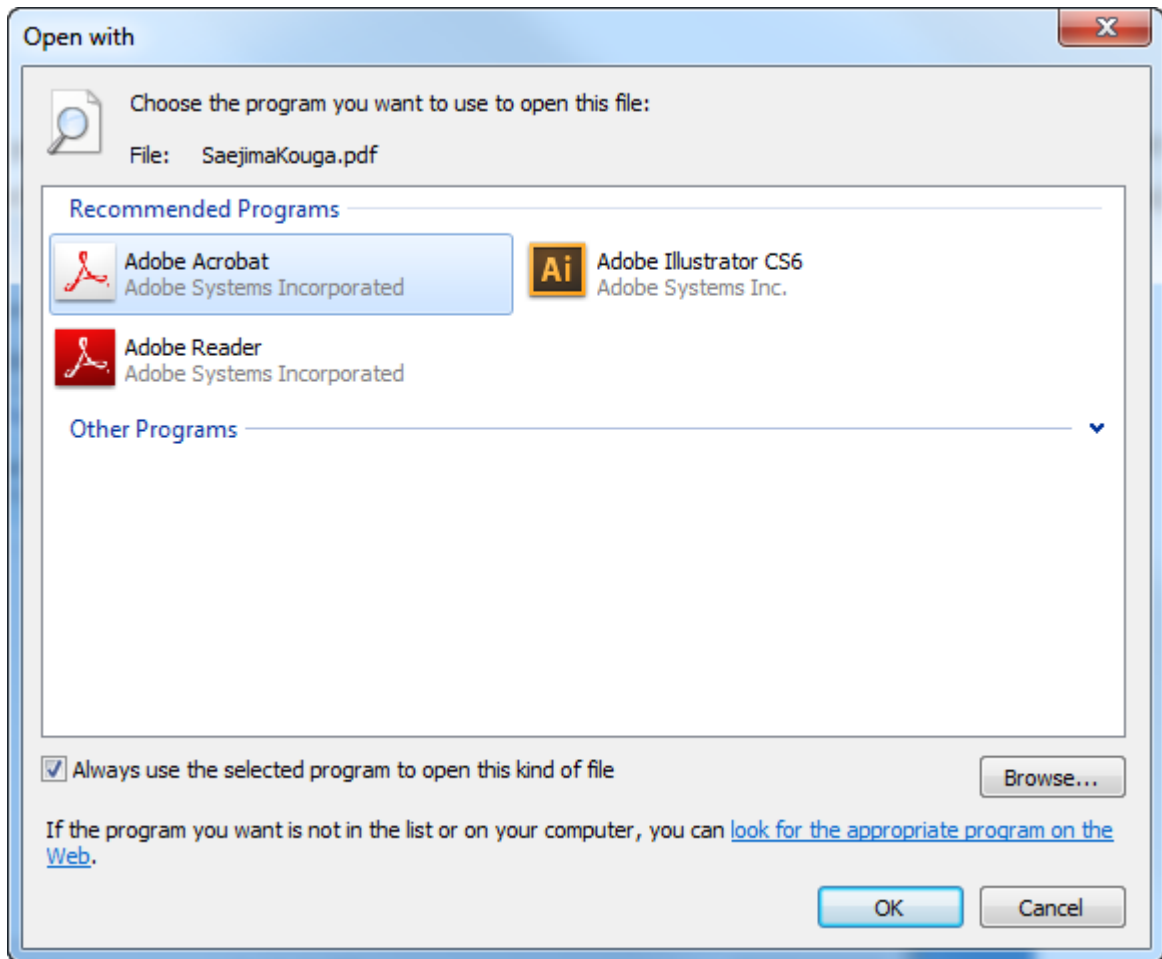

To actually edit a non-native document in another application and have it be a managed document, do the following:

1. Use **Open With** to open the document in another application as described previously.
2. Edit the document as desired.
3. Save it to a local folder in the filesystem.
4. To save it as the same managed document, delete the managed document, and either copy and paste or drag and drop the unmanaged document from the Explorer node of the browser into the Project.
5. To save it as a new version of the managed document, in the ArtiosCAD Enterprise browser, right-click the managed document and select **Open in Web Browser**. In WebCenter, select **Upload New Version** and follow the instructions, clicking **Finish** when done. Refresh the ArtiosCAD Enterprise browser to see the changes.

Opening a Document with a Foreign Board Definition

If you open a document that uses a board code that is not in your database, ArtiosCAD tries to find a board code with the same values for the caliper, inside loss, outside gain, caliper-related rounding value, and flute. If it cannot find a board code with the same values, it tries to find one with values within a 20% tolerance. If it does not find any close matches, you will have to select a board from the list.

1. When you open a document that does not contain a recognized board code, ArtiosCAD tells you so.

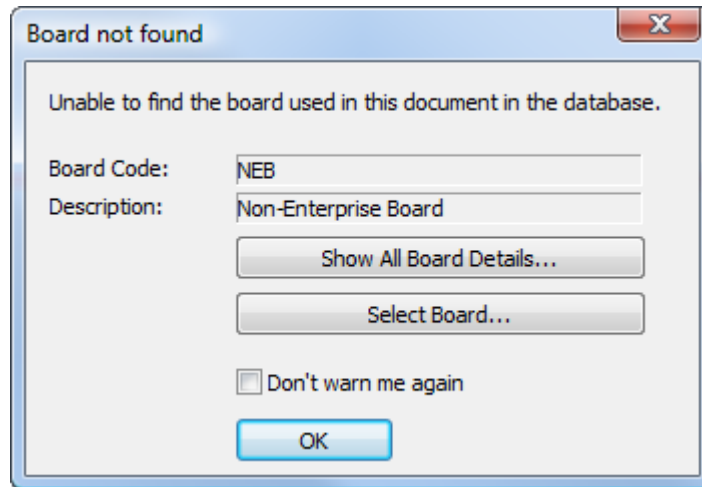

2. To use the board anyway, click **OK**. Otherwise, click **Show All Board Details** to see the information about the board, or click **Select Board** to open the Board Information dialog box. If ArtiosCAD found a board to suggest, it pre-selects the board in the dialog box. If it does not find a match, open the board tree and select a new board to use. The Current Board Definitions pane shows the board information saved in the document, and the Suggested Board Definitions pane likewise shows the information about the board you selected in the tree.

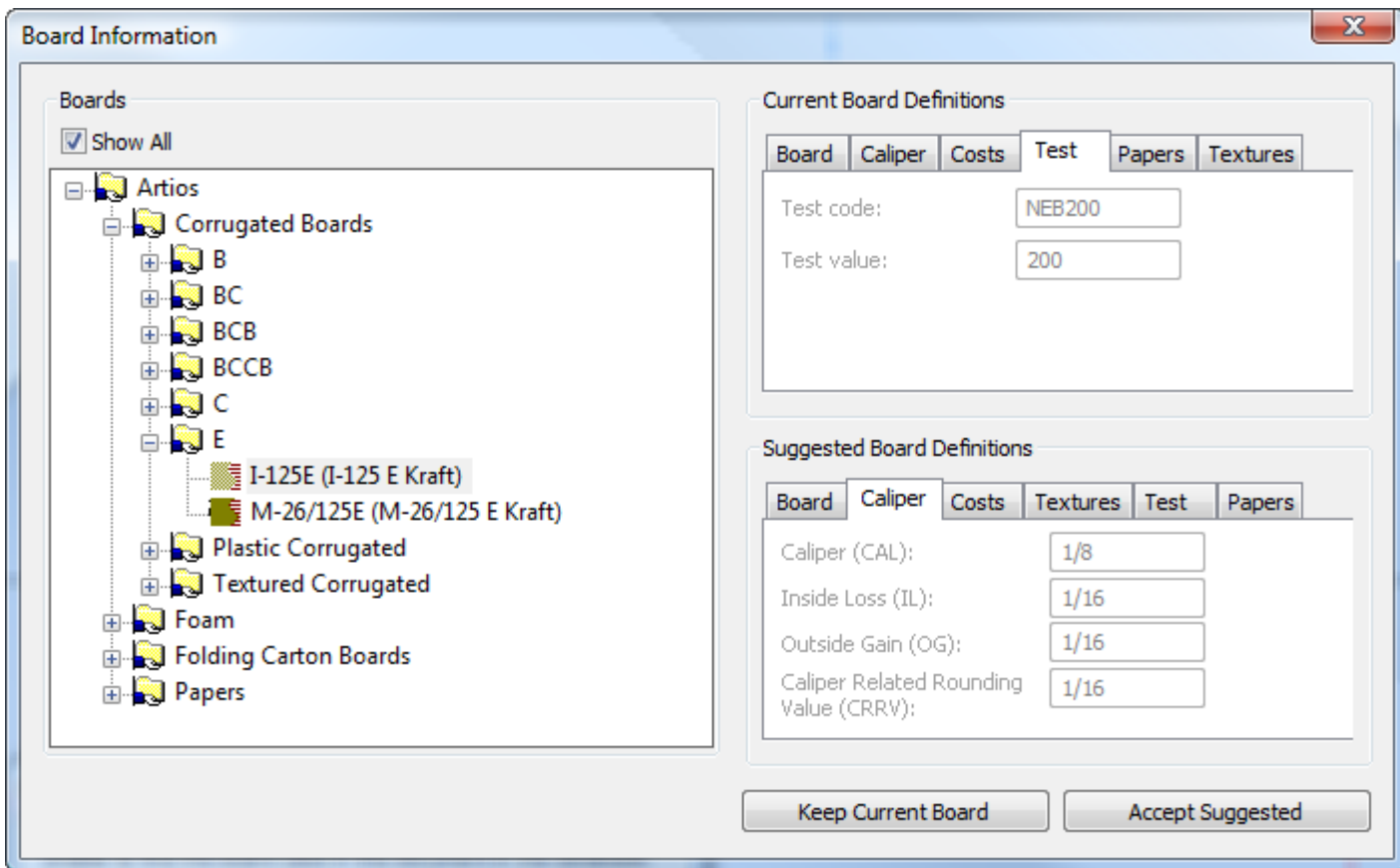

3. To edit the board information saved in the document, click **Edit Board Definition Locally** on the Board tab in the Current Board Definitions pane. To use this changed information, click **Keep Current Board**. Note that since this board still does not exist in the database, ArtiosCAD will continue to warn you when you open it.
4. To replace the board information saved in the document with a board definition from your database, select the board entry from the tree, click **Accept Suggested**, and save the document.

Opening All Documents in the Document List

To open all documents in the currently shown page of the document list, do the following:

1. Arrange the list of documents as desired - open a Project or folder, or do a search.
2. Click **Documents > Select All**.
3. In the document list, right-click a document and click **Open** on the context menu.
4. If there are any linked documents in the list, choose the Project containing the linked document and click **OK**.
5. ArtiosCAD Enterprise opens the documents.

How to Distinguish a Linked Document

ArtiosCAD provides multiple ways to show a document in a list is a link to another document.

1. The browser shows a link symbol before the filename of a linked document.

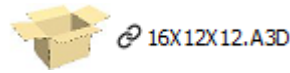

2. More than one Project name is in the Project Name column.

Project Name
168.0054
168.0054
168.0054
168.0054 (311.30.42.30.01.005)
168.0054 (311.30.42.30.01.005)

3. More than one Project name is returned in search results.

Project Name
311.30.42.30.01.005; Plastic Angel Containers_00002
311.30.42.30.01.005
311.30.42.30.01.005; Plastic Angel Containers_00002

4. More than one Project name appears when you hover over a document.



Renaming a Document

To rename a document, do the following:

1. Make sure the document is closed, as you cannot rename an open document.
2. In the browser, navigate to the Project and folder containing the document and select it.
3. Right-click the document and click **Rename** on the context menu.

4. In the Rename Document dialog box, enter a new unique name for the document in the **Name** field. Autonaming is unavailable when renaming a document.

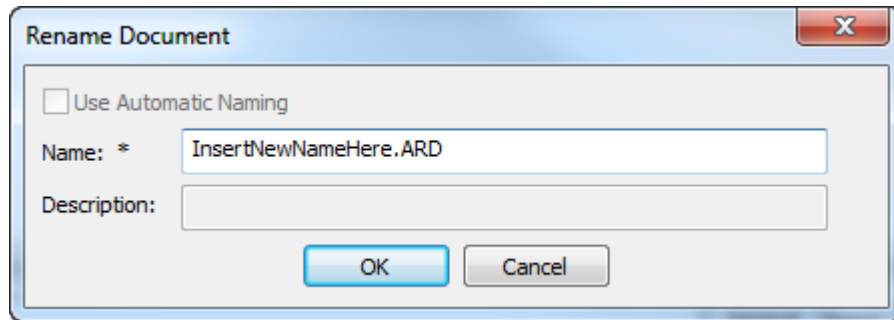

5. Click **OK**.

ArtiosCAD Enterprise renames the file.

Deleting a Document

To delete a document, do the following:

1. Make sure the document is closed, as you cannot delete an open document.
2. In the browser, navigate to the Project and folder containing the document and select it.
3. Right-click the document and click **Delete** on the context menu.
4. Click **Yes** to confirm deleting the document.

Use this command with caution, as there is no way to restore a deleted document.

Moving and Copying Documents

Moving Documents

To move a document to another folder or another Project, do the following:

1. Make sure the document is closed, as you cannot move an open document.
2. In the browser, navigate to the Project and folder containing the document and select it.
3. Drag it from its current location and drop it in the new folder or Project.

You may also drag a managed document from the root level of a Project to a folder or BOM node in the Document pane. If a BOM, you must have the Change BOM permission, and ArtiosCAD sets the initial count to 1, specifies no print item, and replicates the version/revision of the document to the BOM.

You can drag to copy or copy and paste managed documents to unmanaged locations. ArtiosCAD includes the revision letter and version number based on the setting in **Options > Defaults > Startup Defaults > Export Document Name Format**.

Copying Documents

To copy documents between folders and Projects, do the following:

1. In the browser, navigate to the Project and folder containing the document(s) and select it/ them.
2. Next:

Method	Action
Keyboard	Press CTRL-C to copy the documents, then select the destination Project, folder, BOM, or task and press CTRL-V to paste them.
Mouse 1	Drag and drop managed documents to unmanaged locations. You can also drag and drop unmanaged documents between unmanaged locations.
	Additionally, you can drag unmanaged documents into managed locations; ArtiosCAD assigns the document the appropriate Attribute Category.
	You can copy managed documents into folders or Projects in the tree by dragging them while holding down SHIFT.
Mouse 2	Right-click the selected document(s) and click Copy Documents on the context menu, then right-click the destination Project, folder, BOM, or task and click Paste Documents . You can also do this with unmanaged documents between unmanaged locations.
Mouse 3	Hold down SHIFT or CTRL as you drag the document(s) from the source folder and drop it/them on the destination Project, folder, BOM, or task.

Note:

Document names in Projects must be unique, even if the documents are in different folders.

You can copy unmanaged documents from the Explorer node into the Projects or My Tasks nodes to make them managed documents.

You can also drag a document from the Documents pane into a Project or folder in the Projects I Manage, Projects I Am Invited To, and Favorite Projects nodes in the tree.

Copying a Document as a Link

You can share documents across many Projects by copying them as links. When you modify a linked document and save it, you can choose which Projects get the updated version by selecting or deselecting **Update All Related Projects** in the Save Managed Document dialog box.

To copy documents as links, do the following:

1. In the browser, navigate to the Project and folder containing the documents and select them.
2. To copy them as links using the context menu:
 - a) Right-click the documents and click **Copy Documents** on the context menu.
 - b) Right-click a destination folder or Project and click **Paste Documents as Links** on the context menu.

3. To use drag and drop, hold down ALT and drag them to the destination Project, folder, BOM node, or task node. The drag cursor should have a link arrow on it.
4. Repeat steps 2 or 3 as desired.

Adding Other Types of Documents to Projects

You can add other types of documents (for example, Adobe Acrobat or Microsoft Word documents) to Projects by dragging them from the Explorer node of the tree control into the desired Projects.

You can also add them to Projects by uploading them through WebCenter.

Embedded designs

Single designs saved inside of manufacturing documents are called *embedded designs*. When you have a manufacturing file selected in the browser, you can see which single designs are embedded in it on the Embedded Designs tab in the Properties pane.

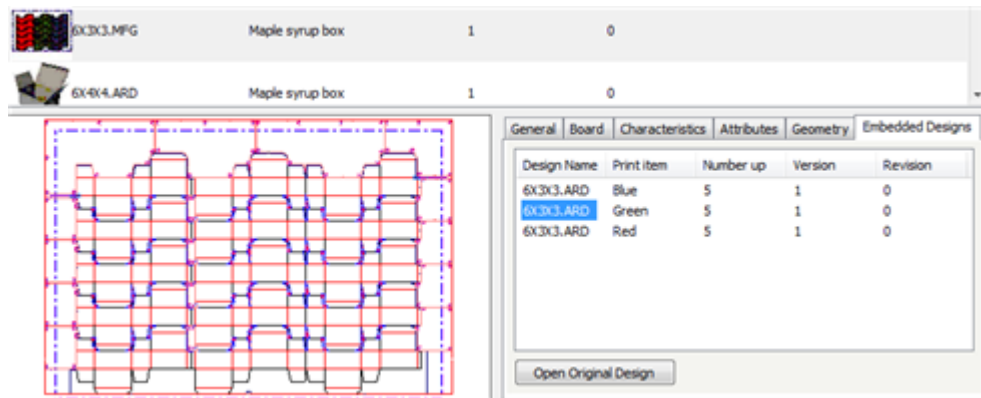

To open an original design document to make changes, select the desired document and click **Open Original Design**.

Conversely, when you have a single design selected in the browser, you can see which manufacturing documents use it by right-clicking it and then clicking **Show Associated Manufacturing Documents**, or by selecting the same command on the Documents menu of the browser.

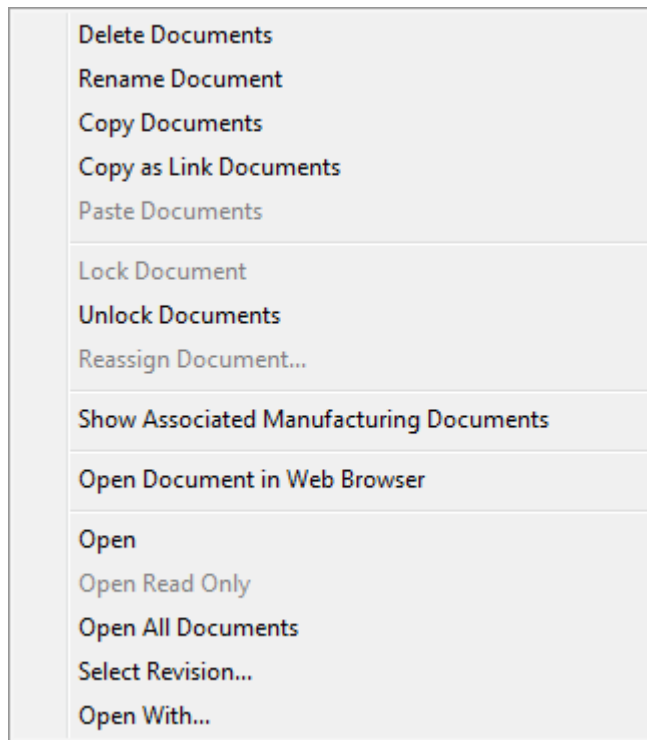

When you are viewing the Print Items tab of a design document in the browser, you can select a print item and click **Show Layouts Using This Print Item**.

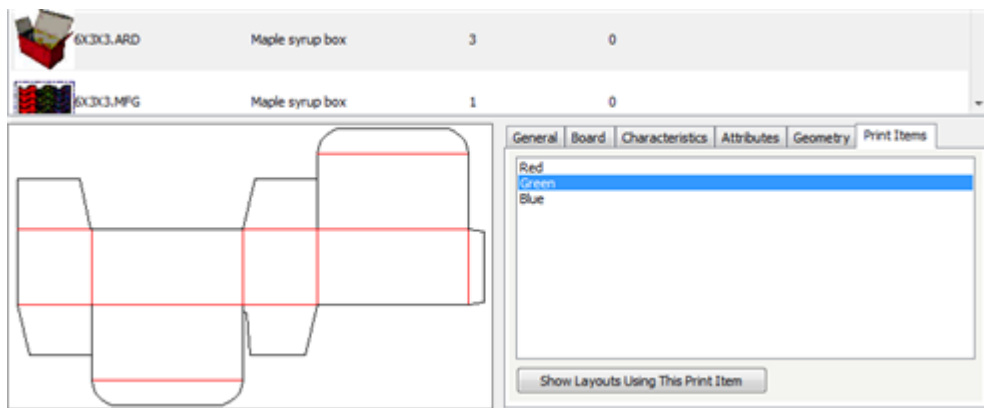

Canvases

Canvases contain parts that can exist solely in canvases or can be saved as independent workspaces. When you select a canvas in the browser, a Parts tab appears in the information pane.

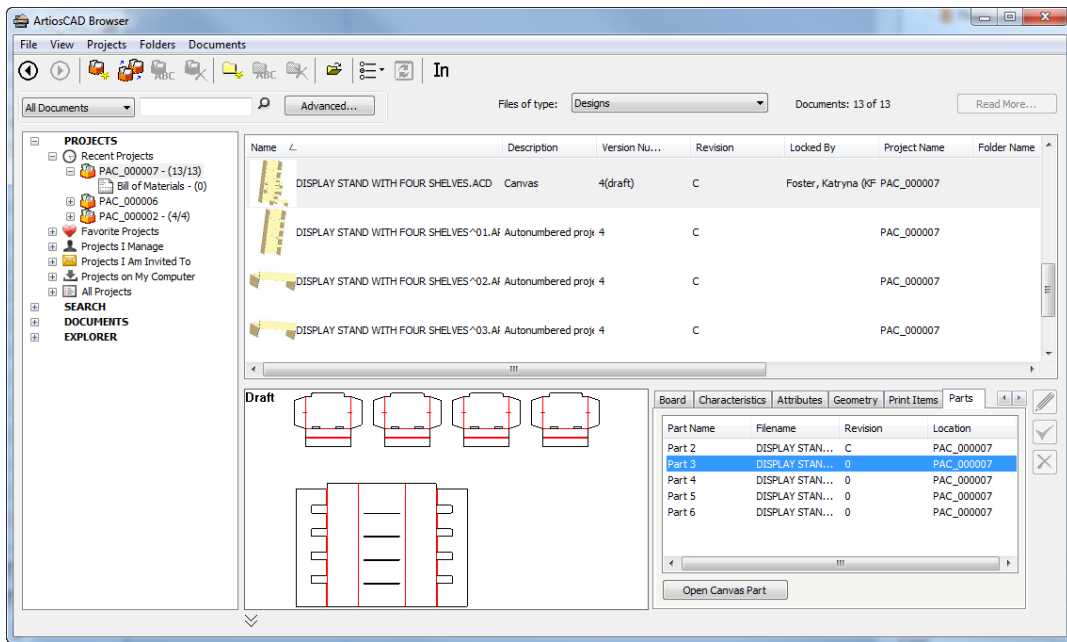

The tab lists the parts in the selected canvas. It lists the part name, filename, revision, and location in which the part is saved. If only the Part Name column has information in it, that means the parts exist only within the canvas.

Open Canvas Part opens the selected part workspace, if you have saved parts to independent workspaces for that canvas.

Searching

There are two ways to search in the browser. The first is to use the keyword search field above the tree control. The second is to use the **Advanced** button to search for more specific items.

Keyword Searching

Keyword searching lets you search the names of Projects and documents for a specific word or part of a word.

Refer to the *Search Controls* topic for a picture of the keyword search controls in the browser and an explanation of what they do.

To perform a keyword search, do the following:

1. Click the **Search Type** drop down-list box and choose the type of object to search for: **Projects, All Documents, Designs, Manufacturing, ArtiosCAD 3D, or Canvas.**
2. In the keyword entry field, enter the word to search for. To search on part of a word, use an asterisk to replace the other part(s) of the word.
3. Click the magnifying glass button to start the search.
4. Depending on what you searched for, results will appear in the node tree, the document list, or both.

If you open a linked document from the document list of a search result, ArtiosCAD Enterprise will prompt you to select the Project containing the linked document.

Advanced Searching

Using the **Advanced** button to search lets you search many more fields than keyword searching.

Note:

All of the advanced search dialog boxes are customizable in **Options > Defaults > Browser Settings > Advanced Search Dialogs** in the same way as the Database Information dialog boxes, including aligning objects to a grid. For instructions on using the Control Layout Manager, please see *Designing a custom Database Information dialog box* in the *Defaults* chapter.

To perform an advanced search, do the following:

1. Click the **Search Type** drop down-list box and choose the type of object to search for: **Projects, All Documents, Designs, Manufacturing, ArtiosCAD 3D, or Canvas.**
2. Click **Advanced** next to the magnifying glass icon.

A dialog box customized for the type of object you chose in step 1 appears.

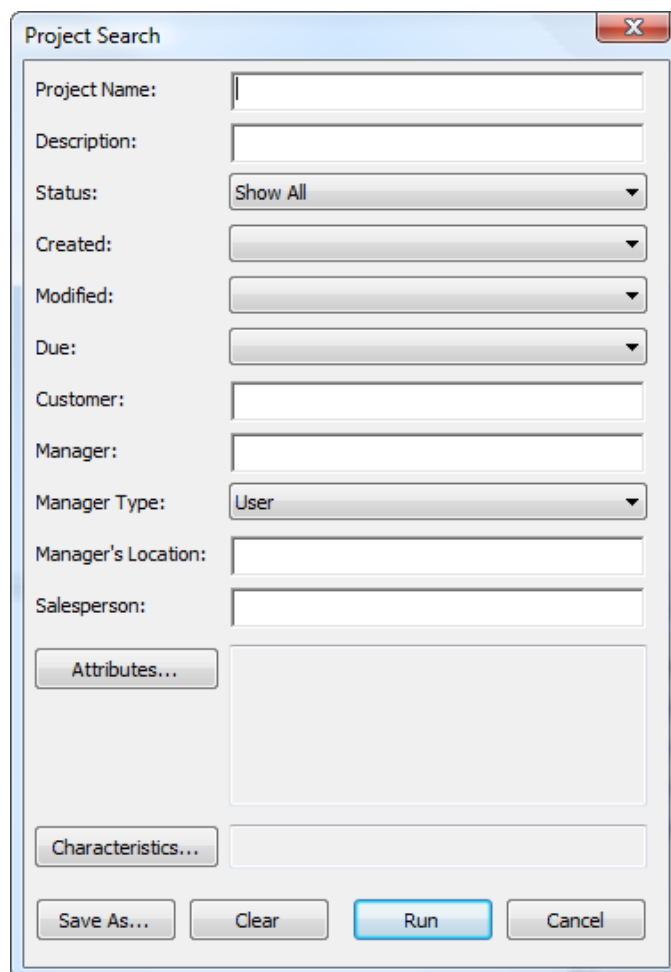

Document Search - All Documents X

Document Name:

Version Author:

Location of the Author:

Project:

Customer/Location:

Description:

Modified:

Document Search - Design

Document Name:

Version Author:

Location of the Author:

Project:

Customer/Location:

Description:

Modified:

Revision Options

Letter:

Search For:

Comment:

Attributes...

Characteristics...

Length: +/- in

Width: +/- in

Depth: +/- in

Board Code or Description:

Save As... Clear Run Cancel

Document Search - Manufacturing X

Document Name:

Version Author:

Location of the Author:

Project:

Customer/Location:

Description:

Modified:

Revision Options

Letter:

Search For:

Comment:

Sheet Width: +/- in

Sheet Length: +/- in

Run Length: +/-

Board Code or Description:

Print Items:

Machines:

Document Search - ArtiosCAD 3D

Document Name:

Version Author:

Location of the Author:

Project:

Customer/Location:

Description:

Modified:

Attributes...

Characteristics...

Save As... Clear Run Cancel

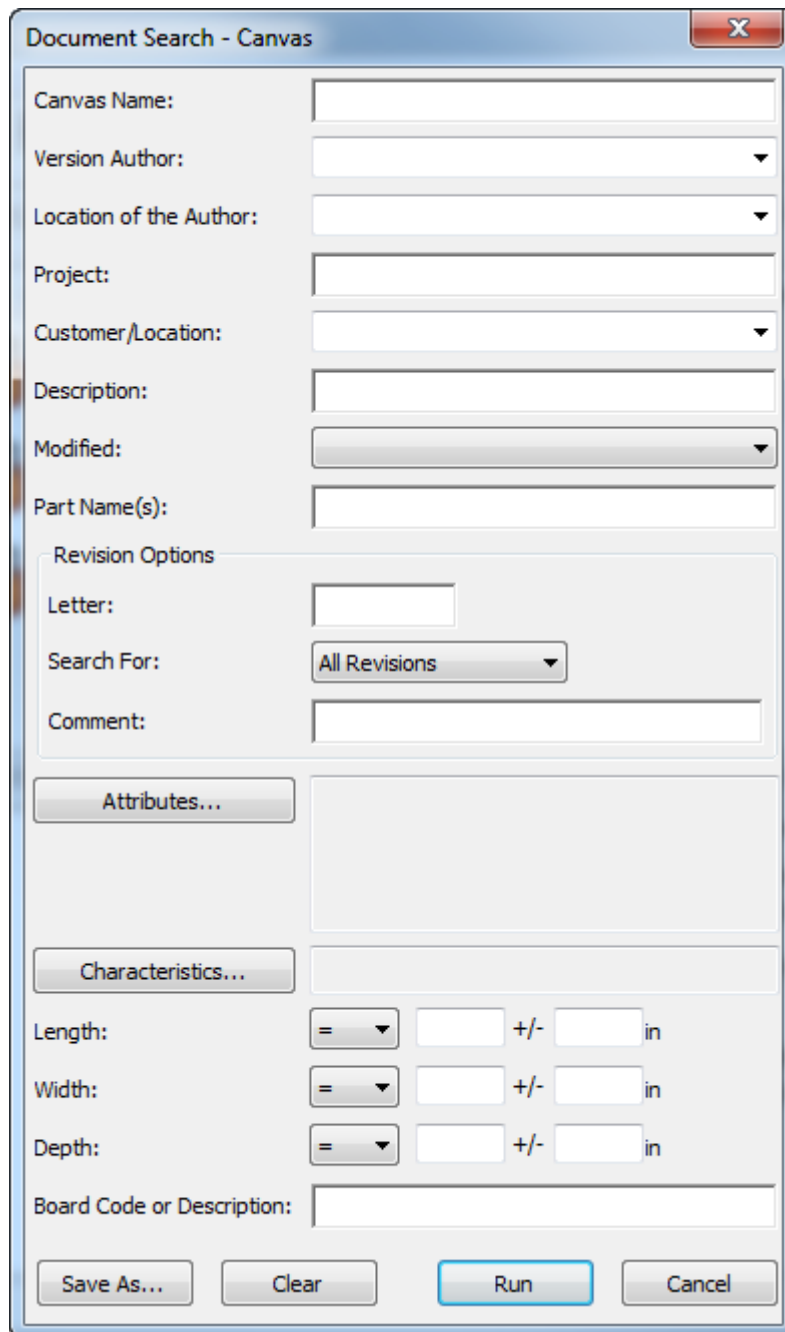

3. Enter the desired information to search for and click **Run**.
4. Depending on what you searched for, results will appear in the node tree, the document list, or both.

If you open a linked document from the document list of a search result, ArtiosCAD Enterprise will prompt you to select the Project containing the linked document.

Note: To be able to search for revisions, your WebCenter system administrator must enable **Index Document Revisions** in **Admin > Configuration > Search Crawler Setup**. If that option is not enabled, the Revision Options are unavailable in the Advanced Search dialog boxes.

Searching Syntax

Use the syntax described below to compose effective search queries. An example of the syntax is at the end of the section.

Terms

A search query is broken up into terms and operators. There are two types of terms: single terms and phrases.

A single term is a single word such as `box` or `corrugated`.

A phrase is a group of words surrounded by double quotes such as `"corrugated box"`. Multiple terms can be combined together with Boolean operators to form a more complex query (see below).

Wildcard Searches

ArtiosCAD Enterprise supports single and multiple character wildcard searches. ArtiosCAD Enterprise supports modifying query terms to provide a wide range of searching options.

To perform a single character wildcard search, use the `?` symbol.

To perform a multiple character wildcard search, use the `*` symbol.

The single character wildcard search looks for terms that match the single character replaced. For example, to search for `text` or `test` you can use the search:

```
te?t
```

Multiple character wildcard searches look for 0 or more characters. For example, to search for `test`, `tests` or `tester`, you can use the search:

```
test*
```

You can also use wildcards in the middle of a term:

```
te*t
```

Boolean Operators

Boolean operators allow terms to be combined through logical operators. ArtiosCAD Enterprise supports `AND`, `+`, `OR`, `NOT` and `-` as Boolean operators.

Note:

Boolean operators must be ALL CAPS.

OR. The `OR` operator is the default conjunction operator. This means that if there is no Boolean operator between two terms, the `OR` operator is used. The `OR` operator links two terms and finds a matching Project/document if either of the terms exist in a Project/document. The symbol `||` can be used instead of `OR`.

To search for Projects/documents that contain either `box company` or just `box`, use the query:

```
"box company" box
```

```
or
```

```
"box company" OR box
```

AND. The AND operator matches Projects/documents where both terms exist anywhere in the text of a single Project/document. The symbol && can be used instead of AND.

To search for Projects/documents that contain box company and box products, use the query:

"box company" AND "box products"

+ The +, or required operator, requires that the term after the + symbol exists somewhere in a field of a single Project/document.

To search for Projects/documents that must contain box and may contain products, use the query:

+box products

NOT. The NOT operator excludes Projects/documents that contain the term after NOT. The symbol ! can be used instead of NOT.

To search for Projects/documents that contain box company but not box products, use the query:

"box company" NOT "box products"

Note:

Note: The NOT operator cannot be used with just one term. For example, the search terms used below will return no results:

NOT "box company"

-. The -, or prohibit operator, excludes Projects/documents that contain the term after the - symbol.

To search for Projects/documents that contain box company but not box products, use the query:

"box company" -"box products"

Grouping

ArtiosCAD Enterprise supports using parentheses to group clauses to form sub-queries. This can be very useful if you want to control the Boolean logic for a query.

To search for either company or products and box, use the query:

(company OR products) AND box

This eliminates any confusion and makes sure that box must exist and either term company or products may exist.

Shown below are different search phrases and their results.

Sample search string	Results	What it does not find
box	box products box company box co. inc.	bottle holders
bo*	box products	

Sample search string	Results	What it does not find
	box company box co. inc. bottle holders	
box NOT "box company"	box products box co. inc.	box company bottle holders
box AND company	box company	box co. inc. box products bottle holders
"box company" OR "box co."	box company box co. inc.	box products bottle holders
box AND (products OR company)	box company box products	box co. inc. bottle holders
* NOT *company*	box products box co. inc.	box company

Saving Searches

You can save search queries for your own future use as personal searches. If you are a member of the ADMINS group, you can also save searches globally for anyone to use.

To save a search, do the following:

1. Compose a search query using one of the advanced search dialog boxes.
2. In the advanced search dialog box, click **Save As**.

The **Save Search** dialog box appears.

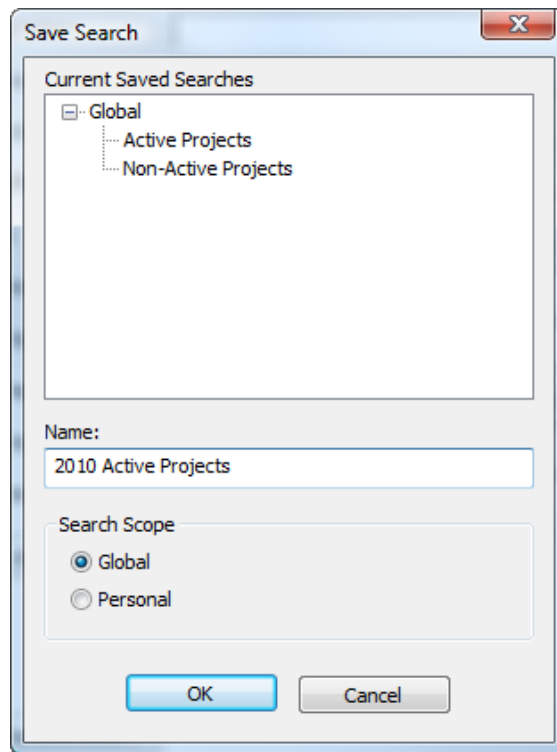

3. In the Name field, enter a name for the search. You can replace an existing search with this one by using the same name.
4. Set the search scope. **Global** is available only for members of the ADMINS group, while **Personal** is available for all users.
5. Click **OK** to save the search.
6. Click **OK** when ArtiosCAD Enterprise successfully saves the search.

Once the search is saved, click **Run** to run it or **Cancel** to close the dialog box.

Using a Saved Search

To use a saved search, do the following:

1. In the tree control of the browser, expand the Search node.
2. Expand the **Saved Searches** catalog.
3. Expand either **Project Searches** or **Document Searches**.
4. Expand either **Global** or **Personal**.
5. Click the desired saved search. It will run automatically.

Depending on what you searched for, results will appear in the node tree, the document list, or both.

Modifying a Saved Search

To modify a saved search, do the following:

1. In the tree control of the browser, expand the Search node.
2. Expand the **Saved Searches** catalog.

3. Expand either **Project Searches** or **Document Searches**.
4. Expand either **Global** or **Personal**.
5. Right-click the desired saved search and click **Properties** on the context menu. Only members of the ADMINS group may modify global saved searches.
6. Modify the search parameters as desired.
7. Click **Save As**.
8. Select the search you are modifying and click **OK**.
9. Click **Yes** to confirm overwriting the existing saved search.
10. Click **OK** when ArtiosCAD Enterprise successfully saves the search.

You can now either run the modified search by clicking **Run** or close the dialog box.

Deleting a Saved Search

To delete a saved search, do the following:

1. Start a Web browser and log in to the WebCenter site associated with ArtiosCAD Enterprise. If you want to delete a global saved search, you must log in as a member of ADMINS group.
2. Click **Search > Saved Searches**.
3. Check the checkbox for each saved search to delete.
4. Click **Delete checked items**.
5. Click **OK** to confirm the deletion.

WebCenter deletes the selected items.

Outputting Documents from the Browser

You can Output documents from the browser without opening them first. For a regular Output, its definition in Defaults must have **Browser** selected in the Show In group on the Output Type tab. All 3D Outputs are available with nothing further required.

ArtiosCAD Enterprise performs 2D Outputs silently.

For a silent 3D Output to a file in an unmanaged directory, check **Omit Save-As Filename** on the Destination tab of the Output definition.

For a silent 3D Output to a file in a Project, clear **Prompt for Project/Document Name** on the Destination tab of the Output definition, and set the other options in the group to either use the current name or a fixed name.

1. To Output single designs or manufacturing documents:
 - a) Select the documents or folder containing only these document types to Output.
 - b) Right click one of the selections and click **Outputs** on the context menu.

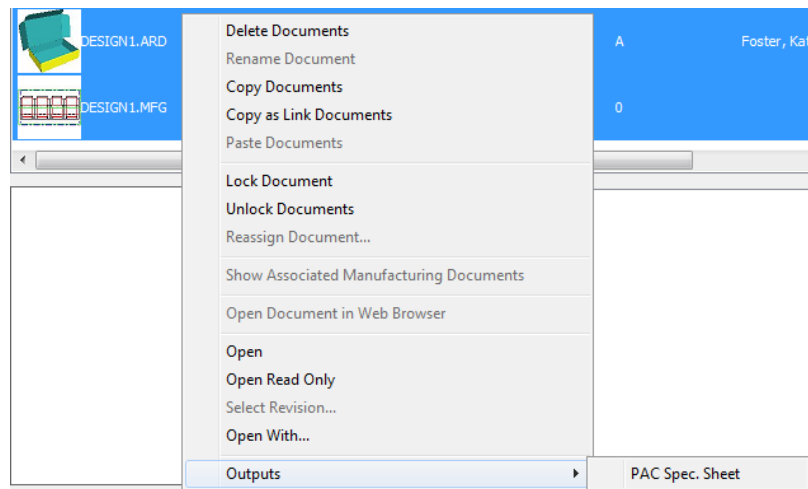

- c) Select an Output and run it normally.
- 2. To Output 3D documents:
 - a) Select the 3D documents or folder containing only this document type to Output.
 - b) Right click one of the selections and click **Outputs-3D** on the context menu.

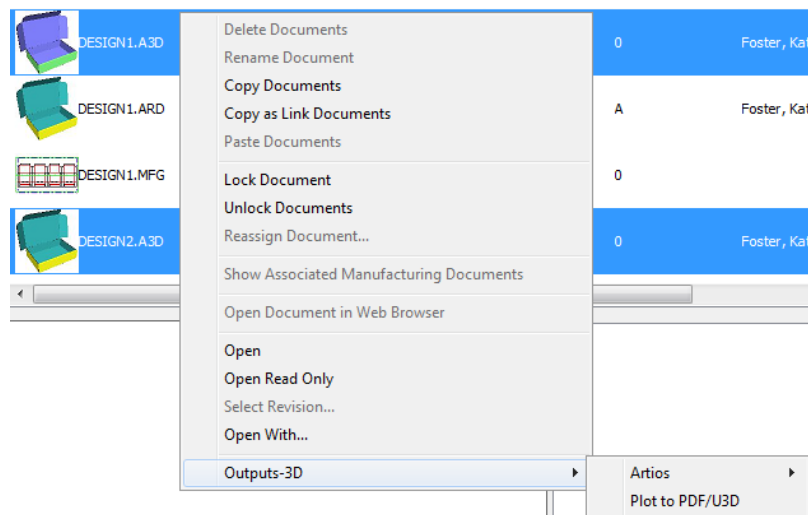

- c) Select a 3D Output and run it normally.

There are a few considerations for these Outputs:

- ArtiosCAD Enterprise acquires licenses as needed during each Output.
- These Outputs are available only for managed documents.
- When you Output from a BOM node, ArtiosCAD Enterprise uses the default print item.
- When you Output to a Project, you must refresh that Project manually to see the Output.

Project Bill of Materials (BOM)

A Project Bill of Materials (BOM) is a list of everything needed in the same Project to complete an order. ArtiosCAD Enterprise has BOM Reports you can Output. Click **Projects > Project Bill**

of Materials to open the Project Bill of Materials dialog box, or right-click a BOM node and click **Project Bill of Materials**.

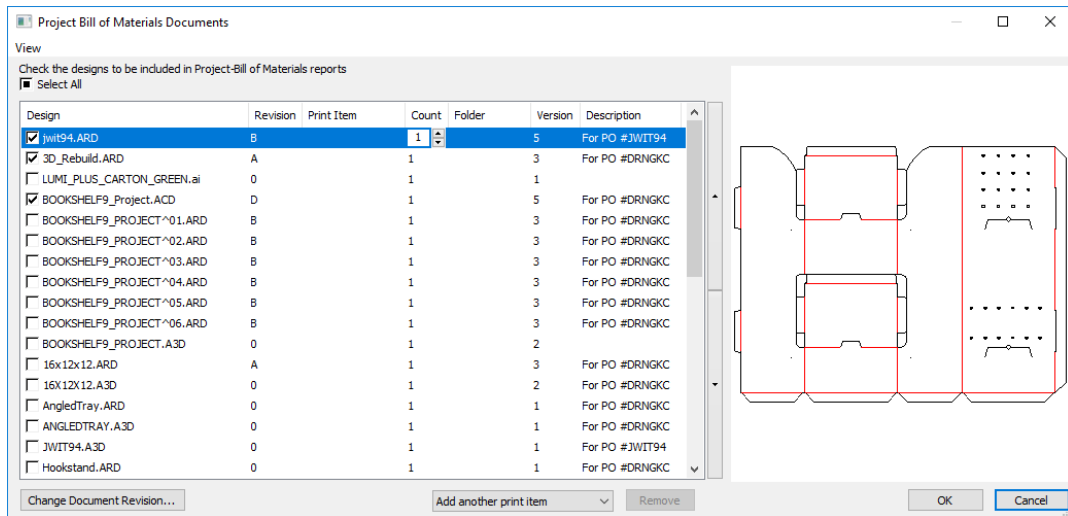

When you first open the BOM Documents dialog box, it displays all of the documents in the Project with nothing selected.

To add an item to the list that will appear on the BOM Report, click the checkbox at the beginning of its row. Enter the number of items required in the Count field.

To add a print item for the selected design, change **Add another print item** to the desired print item, which then appears in the list of documents. To add the document to the BOM with no print item, select **<none>** from the drop-down list box. To remove the current print item from the list, select it and click **Remove**.

To change the order of how items list on the BOM Report, select an item and use the up and down arrows to the right of the item list.

To change the revision of a document, select it and click **Change Document Revision**. Next, choose the new revision in the Document History dialog box and click **OK**.

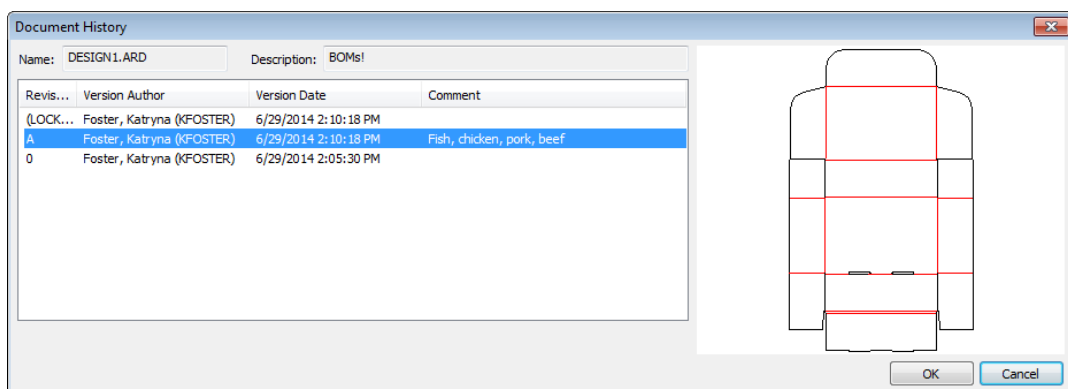

To change the relative sizes of the document list and the preview pane, click to the right of the ordering arrows and drag the separator bar.

To customize the columns shown in the document list, right-click one of the column headers and click **Customize**. Use the checkboxes to turn columns on and off. To rename a column,

select it, then enter a new value in the Column Title field. Click **OK** to return to the BOM Documents dialog box.

Use **Save Dialog Configuration** and **Load Dialog Configuration** on the View menu to save aspects of the dialog box such as size, position, and customized columns and then restore them as the same user on another computer.

To Output a BOM Report, right-click a BOM node and click **Bill of Materials Reports**, and then choose the Report.

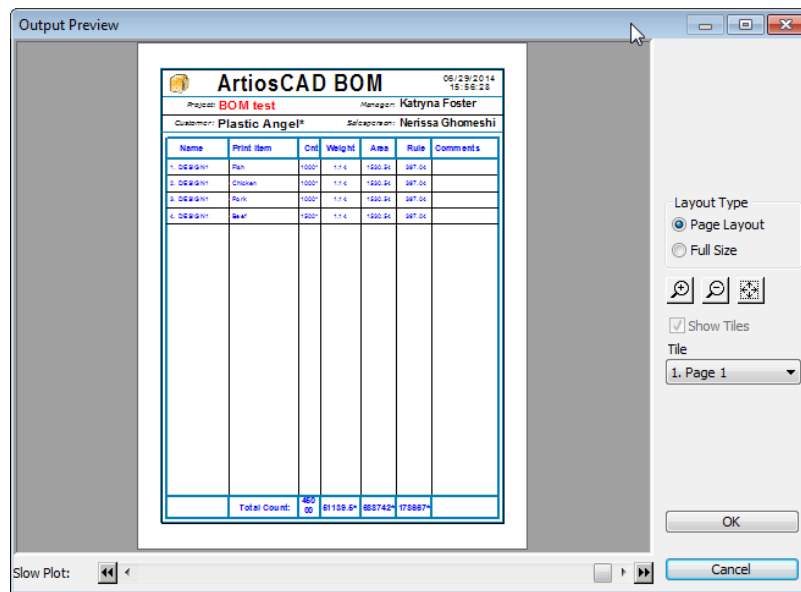
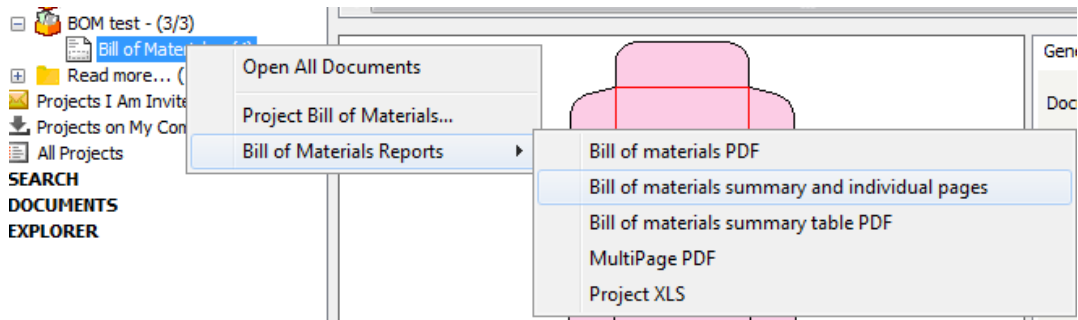

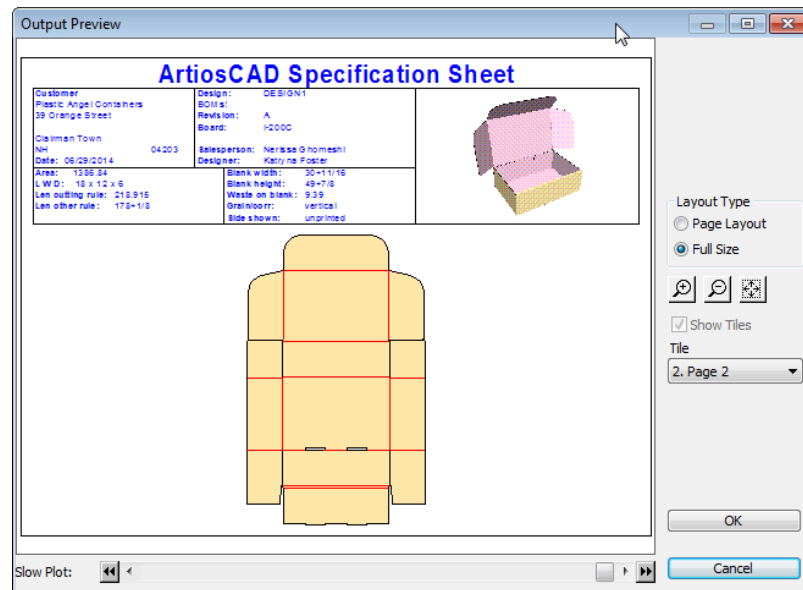

Offline Mode

Offline mode lets you perform certain database-related activities in ArtiosCAD Enterprise when you are not connected to the database either accidentally or on purpose. Offline mode uses the cache, which is a per-user, per-server, per-version invisible database that sits between ArtiosCAD Enterprise and WebCenter.

When you are in offline mode, the status indicator at the bottom right of the ArtiosCAD Enterprise will show it, as will the title bar of the browser.

Note:

You must log in at least once in online mode for the cache to be created. At the time of the login, click Yes to have ArtiosCAD Enterprise create the cache.

When ArtiosCAD Enterprise can connect to the database, it will give you a choice of what information to synchronize from the cache during your time in offline mode.

Note:

Structural tools work normally in offline mode.

Copying a Project to My Computer

You must copy a Project to your computer before you can work on it in offline mode.

To copy a Project to your computer, either:

- Drag and drop it into the Projects on My Computer node in the tree control.
- Copy and paste it into the Projects on My Computer node in the tree control.

A progress bar will briefly appear showing the progress of the copy.

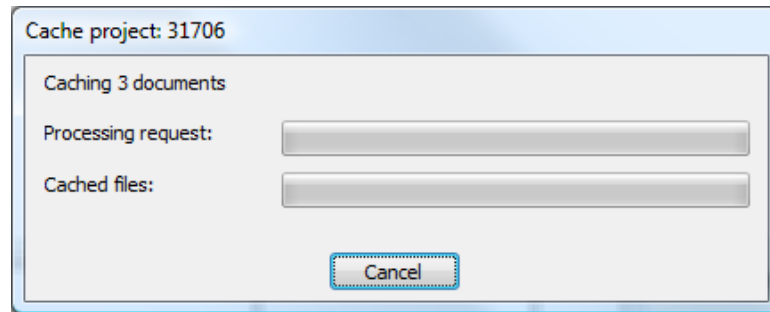

Entering Offline Mode

There are three ways to enter offline mode. To enter offline mode, choose one of the following:

1. Check the **Work Offline** checkbox in the login dialog box when you are logging in.
2. Once you are logged in, click **Database > Work offline**.
3. Disconnect your network connection. When no dialog boxes are open, ArtiosCAD Enterprise monitors the status of the network connection and will switch to offline mode when the database is unavailable.

Limitations of Offline Mode

Offline mode has the following limitations:

- When you create a new Project, you cannot use a Template, and **Generate Next Name/Save as Next Name** is unavailable (but you can generate it when you synchronize upon returning to online mode).
- When you save a document, you may only save it as a draft, not a new revision, and **Generate Next Name/Save as Next Name** is unavailable (but you can generate it when you synchronize upon returning to online mode).
- You can create and rename new folders only. You cannot rename or delete existing folders.
- You can copy documents between Projects, but you cannot copy them as links.
- You can perform simple searches without wildcards on Project and document names and comments.
- You may not have one instance of ArtiosCAD Enterprise running in online mode and another running in offline mode. If you are running two instances of ArtiosCAD Enterprise in online mode and lose your network connection, you will not be able to enter offline mode in those instances, as one instance being in online mode will prevent the other from changing to offline mode.
- You cannot edit Defaults in offline mode.
- in 3D, if you change the 3D rendering mode (**Options > 3D Rendering Options**) while in offline mode, you will have to reapply the change after you return to online mode and restart ArtiosCAD Enterprise.

Returning to Online Mode and Synchronizing

1. When you are ready to return to online mode, you can do it in two ways:
 - a) Re-establish your network connection. ArtiosCAD Enterprise periodically checks to see if it can connect to the database and will display the following dialog box when it can do so. Leave **Yes** selected and click **OK** to return to online mode.

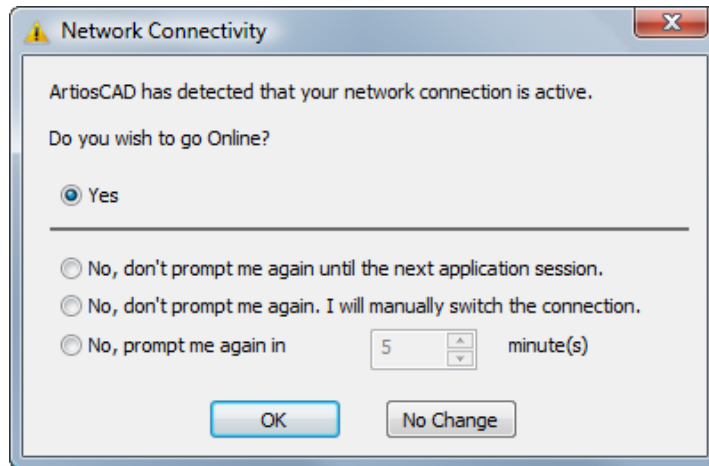

- b) Click **Database > Work Online**.
2. ArtiosCAD Enterprise will present all the Projects and documents needing synchronization.

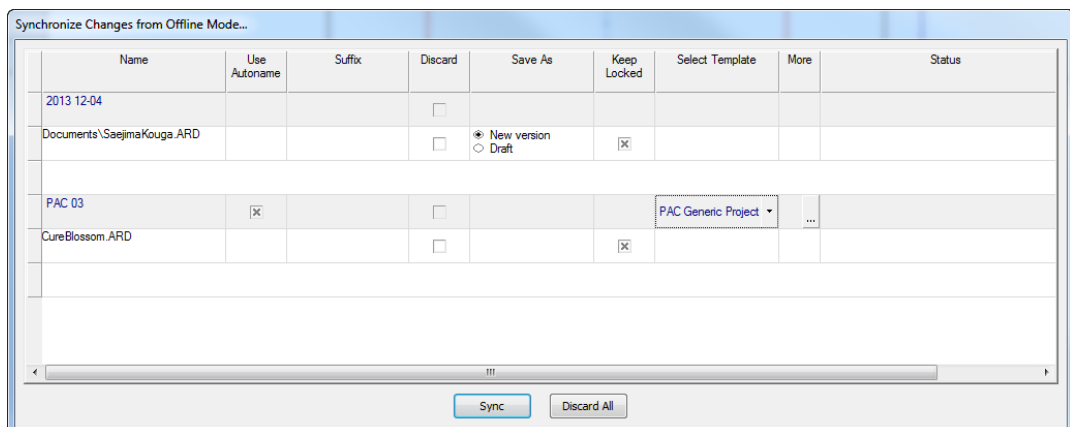

- a) The **Name** column shows the names of Projects and documents you created in offline mode.
 - b) The **Use Autoname** column lets you choose which Projects and documents get automatically-generated names (if available) as they are uploaded to the WebCenter database when you exit offline mode. Clear the checkbox to use the original Project name you specified while offline. You can only change the state of this checkbox if automatic naming is turned on and you have not selected a Template. Make sure that you do not select this option for linked documents, as that will break the link.

- c) The **Suffix** field appears only if automatic naming is available for Projects and documents, and if a user-entered suffix is required, double-click the field to enter one.
 - d) The **Discard** columns lets you choose individual Projects or documents to not upload to the database and thus delete them. You will have to individually confirm each discard when you click **Sync**.
 - e) If you worked on an existing document in offline mode, **Save As** lets you choose between saving a draft or a new revision.
 - f) If you want to show other users that you are still working on a document, **Keep Locked** lets you lock the document so that they get a warning if they try to work on it.
 - g) **Select Template** is a drop-down list box of available Templates you can apply to the Project.
 - h) If the Template has a customer and/or location set, click the More (...) button to set them.
 - i) **Status** shows the status of each item in the list as the cache synchronizes with the main database.
 - j) For those columns containing checkboxes, you can right-click the column header and click **Check All** or **Check None** on the context menu.
3. Click either **Sync** to accept and upload all changes you made in offline mode or **Discard All** to lose them.

If you encounter errors while synchronizing (for example, you lose your network connection), ArtiosCAD Enterprise will revert to offline mode, and unsynchronized changes are left to be synchronized again. If the synchronization fails for some other reason, the reason will be displayed in the **Status** column and you will need to manually upload any new files to WebCenter. The files to synchronize are in %LocalAppData%\Esko\Offline_Online_Recovery\%Sync_Date_Time% where %Sync_Date_Time% is the timestamp from when you attempted to synchronize.

Purging the local database cache

As time passes and you save Projects to your computer for use in offline mode, the local database cache grows. To recover space and remove local copies of Projects you no longer need, do the following:

1. In the browser, right-click Projects on My Computer and click **Purge Cache** on the context menu.
2. The Purge Cache dialog box appears.

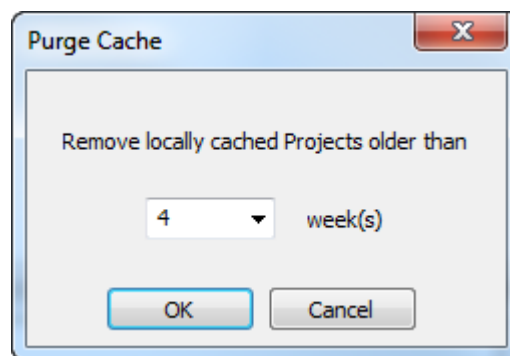

3. Choose the number of weeks to delete Projects older than, meaning that ArtiosCAD will keep Projects saved to your computer within the interval. The default is 4 weeks. You can either type a number (less than or up to 1000) in the field, or choose a number from the drop-down list box. Set the number to **0** to delete all locally cached Projects except Defaults Projects.
4. Click **OK** to purge the Projects and compress the local cache. ArtiosCAD displays a progress bar.

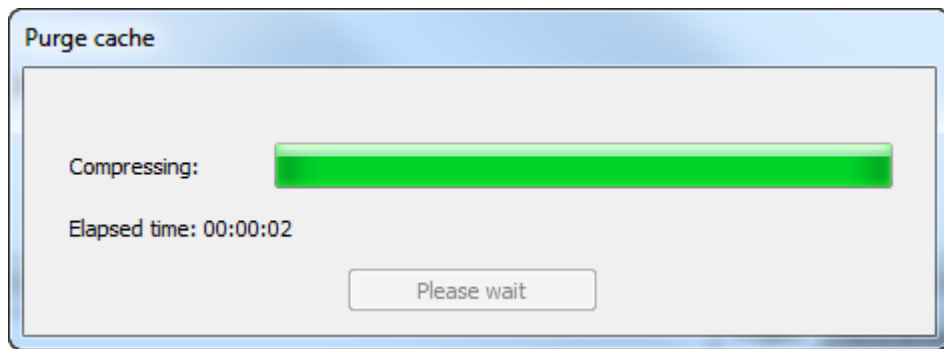

5. Click **OK** in the results dialog box to return to the browser.

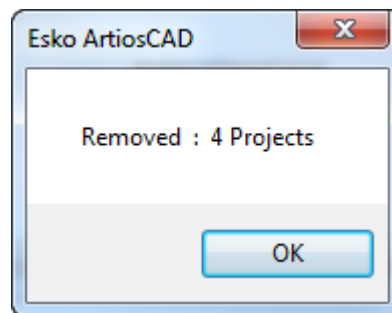

Note that this procedure only removes Projects from your local database cache used for offline mode. It does not remove them from the main database.

Other Features

Locking and Unlocking Documents

When you open a document, ArtiosCAD Enterprise marks it as locked and displays a warning to any other user who subsequently opens it.

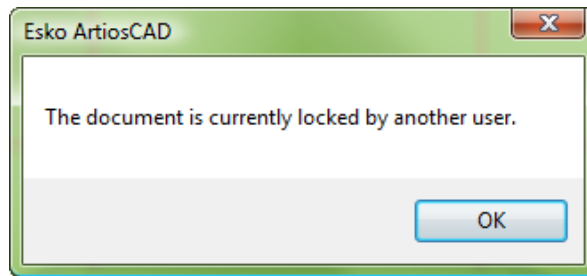

After the other user clicks **OK**, the document is opened as read-only. Additionally, the title bar of the other user's ArtiosCAD Enterprise session shows the file as being locked and the user who has it locked.

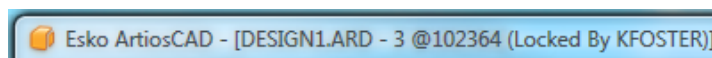

Locking a document also gives you the exclusive right to create a new version of the document.

Unlocking a document that has a draft saved will remove the draft. ArtiosCAD Enterprise will ask you to confirm removing the draft before unlocking the document.

When you unlock an open document, it becomes read-only until you re-lock it or save it as a new document.

To lock or unlock a document, do the following:

1. To lock a document, open it. If it has been unlocked, click **Database > Lock Document**.
2. To unlock a document that you have opened, either close it or click **Database > Unlock Document**.

Forcibly Unlocking Documents

If the user who locked a document is unavailable to unlock it, it can be forcibly unlocked in WebCenter by a member of the ADMINS group.

To forcibly unlock a document, do the following:

1. Start a Web browser and log in to WebCenter as a member of the ADMINS group.
2. Click **Admin > Project Management > Find Locked Documents**.
3. Select the checkbox of the document(s) to unlock.
4. Click **Unlock**.

The document(s) is unlocked.

If the document owner had it open in ArtiosCAD Enterprise, it becomes read-only in that instance.

To unlock the document from the ArtiosCAD browser if you are a member of ADMINS, reassign the document to yourself, wait for the draft to become visible, and then unlock the document.

Reassigning a Document to Another Designer

Members of the ADMINS group can reassign a locked document to another designer, provided that the target designer is a member of ADMINS or:

- is a member of the Project
- has View, Download, and Lock permissions on the document to view it
- has View, Download, Lock, and Update permissions on the document to save or publish it.

To reassign a document to another designer, do the following:

1. Launch ArtiosCAD and log in as a member of ADMINS.
2. Open the browser and navigate to the folder containing the locked document.
3. Right-click the locked document and click **Reassign Document** on the context menu. Alternately, select the document and click **Documents > Reassign Document**.
4. In the Select designer dialog box, select the last name of the new designer and click **OK**. You can sort each column by clicking its header.

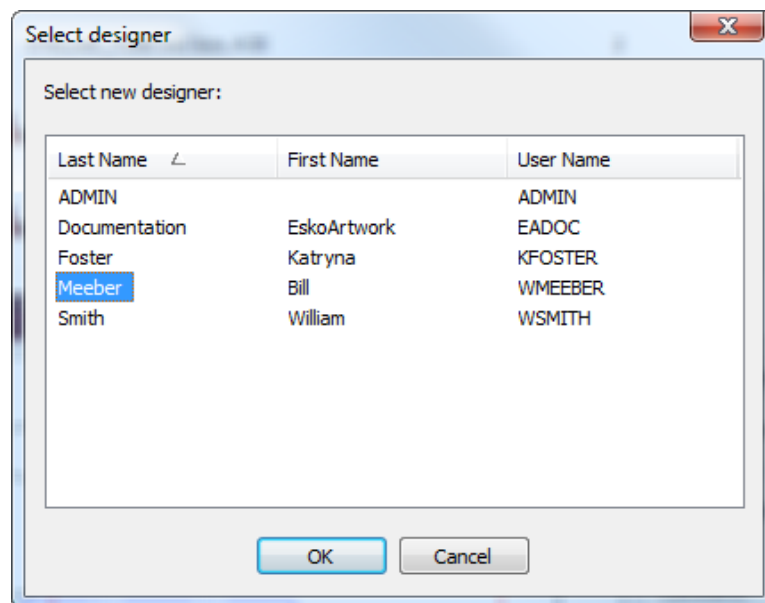

ArtiosCAD reassigns the document.

This command is available only in online mode, only when you are logged in as a member of ADMINS, and only for a locked or draft document.

Revision History

To view the history of a document, right-click it in the document list and click **Select Revision** on the context menu.

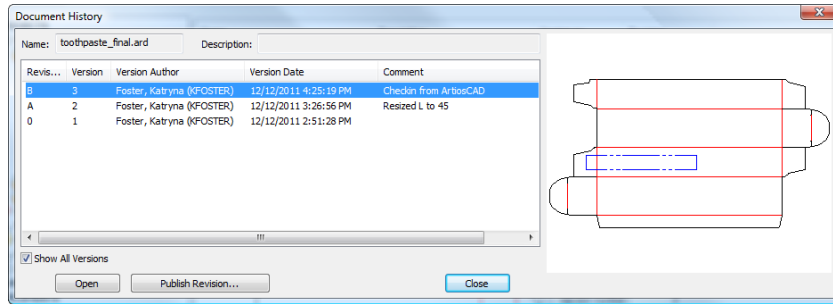

When selected, **Show All Versions** shows the Version column.

The versions are listed in reverse order with a preview shown for the selected version.

If a document is not locked, you can select a version or revision and click **Publish Revision** to save it as a new revision of the same document.

To open a previous version of the document, select it and click **Open**.

Enhancements to Customized Database Information Dialog Boxes

The Database Information dialog boxes that appear when you create Projects and save documents are customized from the standard versions that are part of the non-enterprise version of ArtiosCAD. ArtiosCAD Enterprise adds two enhancements to the Control Layout Manager in Defaults for these dialog boxes.

The first enhancement is the **Right Justify** checkbox for labels. Use it to control a label's position in its allotted space.

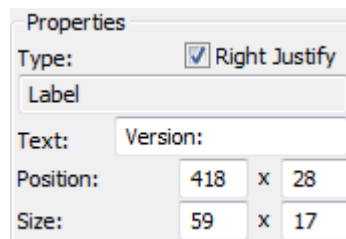

The second enhancement is the **Required** field for Attributes. Use this to force a user to set an Attribute when setting database information.

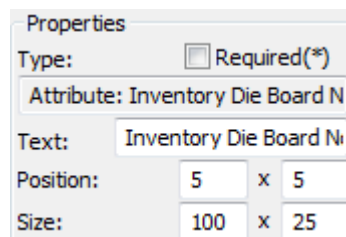

Note:

You must have Attributes defined in WebCenter in order to be able to add them to a Database Information dialog box in ArtiosCAD Enterprise.

Note:

The ability to launch custom external applications from Database Information dialog boxes does not exist in ArtiosCAD Enterprise.

Using the Cache Manager

ArtiosCAD Enterprise automatically maintains the cache on your computer so that you can use offline mode. However, to manually manage the cache, for example compressing it after removing Projects from your computer, click **Database > Cache Manager** to open the cache manager.

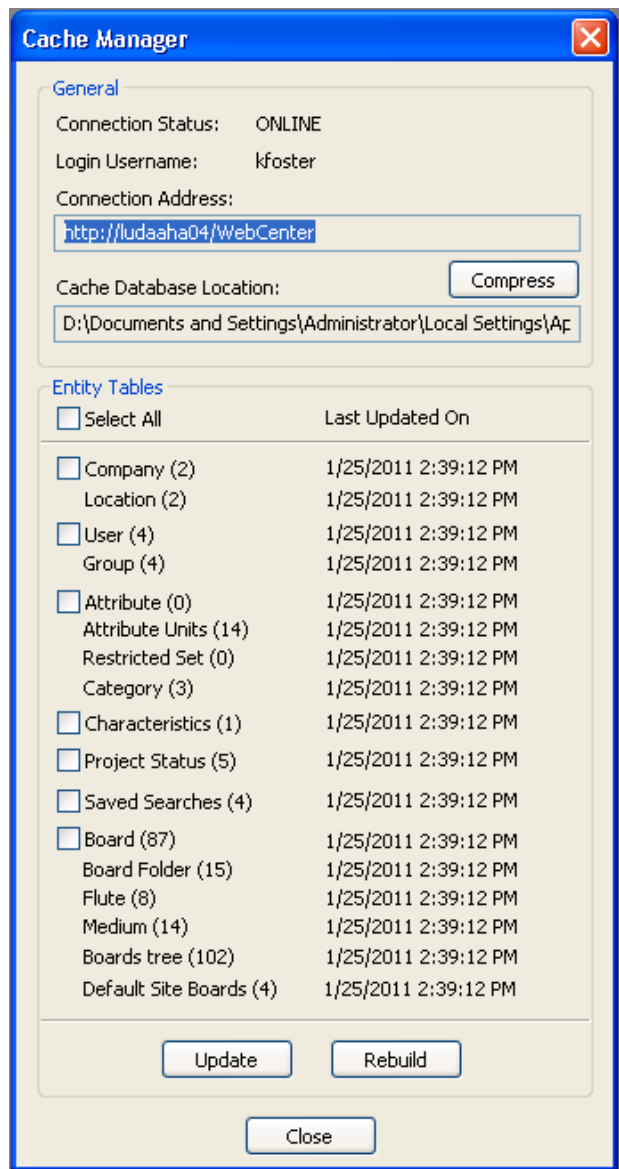

The checkboxes to the left of the table names control which tables are affected by clicking **Update** or **Rebuild**. **Update** requests only new or changed entities from the database since the timestamp in the **Last Updated On** column. **Rebuild** clears the cached entities and retrieves the complete tables.

Note:

You can only use **Update** and **Rebuild** when you are in online mode.

After you use **Remove from My Computer** on many Projects in the browser, click **Compress** to compress the cache and improve performance.

Permissions Required for Common Activities

It is intended that, for ease of use, ArtiosCAD Enterprise users all be members of groups that have full permissions on the Projects to which they are invited. However, if you choose to not follow this model, you can set permissions for each Project and folder in WebCenter per user and per group. Project managers can set permissions on the Projects they manage; members of the ADMINS group can set permissions on any Project and folder.

Common tasks, commands, features, and functions and the permissions required are listed in the table below.

Action	Permissions Needed	Dialog box controls and menu items affected
Open document	View, Download	File menu - Open, Open Read Only, Open All Documents, Select version, Open with. Open button in browser Open With on context menu.
Save new document	View, Add, Change	File menu - Save, Save as Next Name if Project or folder selected Save, Save as Next Name buttons in browser Save when an Output goes to a Project
Save new version of document	View, Change, Lock	File menu - Save if document selected Typing the document name in the Name field when saving
Save draft	View, Change, Lock	
Change document properties	View, Update	
Delete document	View, Delete	Delete on browser's Document menu and context menu
Rename document	View, Change	Rename on browser's Document menu and context menu

Action	Permissions Needed	Dialog box controls and menu items affected
Lock/Unlock document	View, Lock	Lock and Unlock on browser's Document menu and context menu
Move document from source Project or folder	View, Delete	Drag and drop document from folder to folder or Project to Project. Permissions checked when dropped.
Move document to destination Project or folder	View, Add, Change	Drag and drop document from folder to folder or Project to Project. Permissions checked when dropped.
Copy document from source Project or folder	View, Download	Document menu - Copy Documents. Context menu - Copy. CTRL-C
Copy document to destination Project or folder	View, Add, Change	Document menu - Paste Documents. Context menu - Paste. CTRL-V Dragging and dropping document from Project to Project while holding down CTRL or SHIFT. Permissions checked when dropped.
Copy document as link from source Project or folder	View, Add, Download	Document menu - Copy as Link Documents. Context menu - Copy as Link.
Copy document as link to destination Project or folder	View, Add, Download	Document menu - Paste Documents. Context menu - Paste. CTRL-V
Open Project in Web browser	View	Project Menu - Open in Web Browser. Context menu - Open Project in Web browser

Action	Permissions Needed	Dialog box controls and menu items affected
Open document in Web browser	View	Document and context menus - Open in Web browser

Note:
ArtiosCAD download format permissions set in WebCenter have no effect in ArtiosCAD Enterprise; they only affect what users can download from WebCenter.

Setting the Title Bar Display Options

You can choose which revision and version information ArtiosCAD shows in the title bar. The Title Bar Options dialog box in **Options > Defaults > Startup defaults** presents different formatting options. Choose the preferred option and click **OK**.

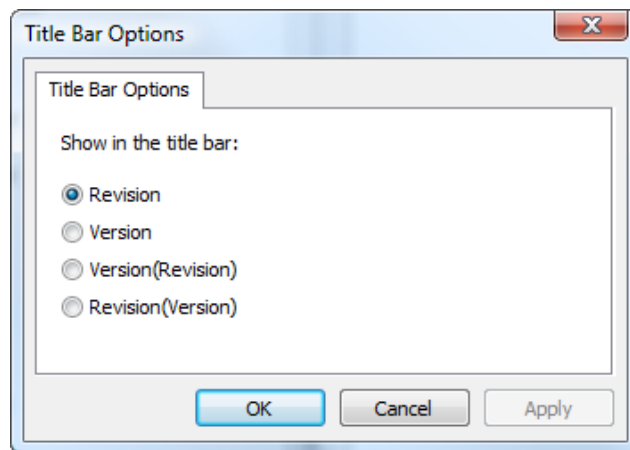

Pre-seeding comments when saving a document

When you save a new version or revision of a managed document, you must enter a comment. To streamline the comment-entry procedure, you can configure ArtiosCAD Defaults to pre-seed the comment with a default comment you have defined in Defaults or the Project/document description.

In **Database Defaults > General Options**, the settings in the Comment Options group control how ArtiosCAD manages comments.

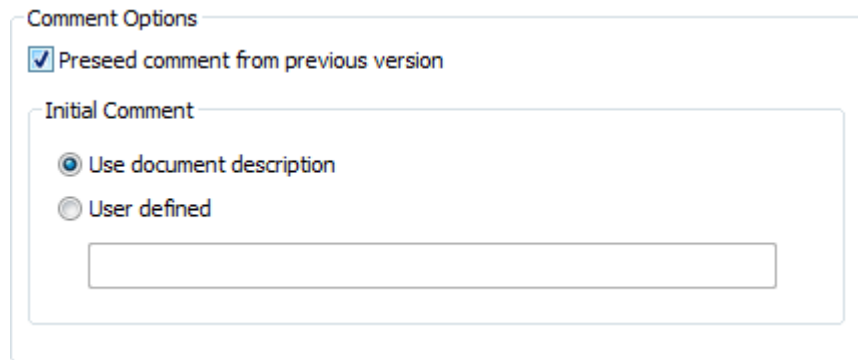

Comment Options

Preseed comment from previous version

Initial Comment

Use document description

User defined

To turn on the automatic commenting, check **Preseed comment from previous version**. This also enables the options in the Initial Comment group.

Use document description copies the document description to the comment field. If there is no document description, ArtiosCAD will prompt you for a comment. This will also cause the Project description to seed the document description when you save a managed document for the first time so that on the next save, the comment will be able to be seeded from the description.

User defined lets you enter a custom string that ArtiosCAD will use for the first comment.

When automatic commenting is enabled and you save a managed document without a description for the first time, ArtiosCAD copies the Project description to the managed document's Description field to seed future comments. You can change this field in the Database Information dialog box as you save the document if you have Show database information dialog on save enabled in the same General Options dialog box in Database Defaults.

Note:

If you are working on an unsaved new document, and a document of the same name (usually DESIGN1) exists in the managed location you select when you save it, ArtiosCAD will consider the new document to be version 2 of the existing document and thus seed the version comment from the existing document, rather than using a user-defined comment from Defaults or the Project/document description.

11. Builder

What is Builder?

Builder is the component of ArtiosCAD which allows you to create new designs based on standards. By itself, Builder does not allow you to modify the geometry of the created design by changing existing lines or creating new lines.

Running a standard

Use these steps to create a design from a standard style. A more detailed example follows.

1. Start ArtiosCAD.
2. Click **Run a Standard** on the **File** menu.
3. Choose a style from the Standards Catalog. Click **OK**.
4. Select a parameter set and board code. Click **OK**.
5. Enter the inside dimensions of the new design. Click **Next**.

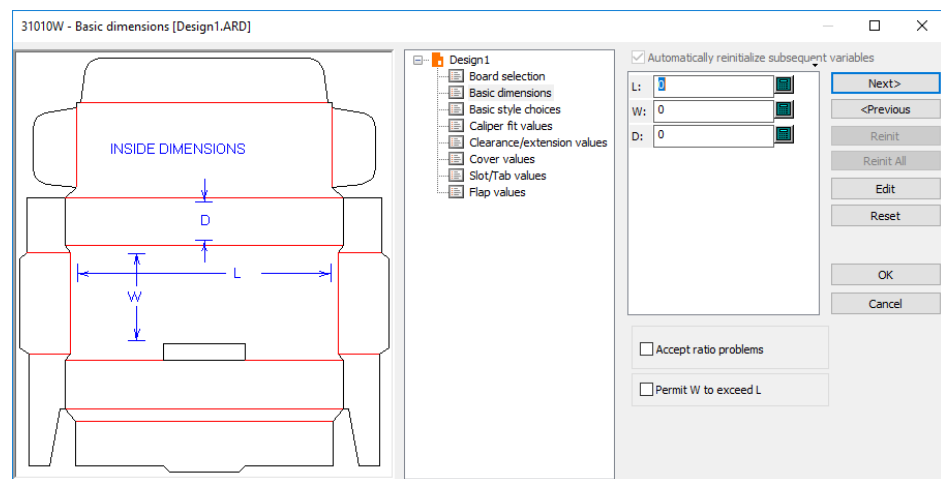

6. At this point, each standard is different. Choose style options and enter values for variables if appropriate. A variable is a way to store a value so it can be changed in the future. Click the **Next** and **Previous** buttons to move between menus, or click the title of the desired menu to move to in the tree control. If you know that the options and variables in future menus are set correctly, click **OK** to view the completed design.
7. Usually there is a diagram displayed to the left of the tree control to show where the variables in the current menu are used in the design.
8. Position the mouse cursor over the name of a variable and wait a moment. A ToolTip will appear showing the description of the variable.

9. If you try to enter a value that does not meet a variable's check condition, you will be prompted to enter a more reasonable value. A check condition limits the values that can be assigned to a variable.
10. The **Next** button is unavailable when the current menu is the final menu of a style. Click **OK** to view the completed design.
11. The basic design is now structurally complete.

Two options in Defaults control the orientation of the design you just created based on a standard. They are both in **Options > Defaults > Single design parameter sets > <parameter set> > Startup defaults**. The first is in the **Flute/grain** catalog. **For designs based on standards, rotate the result if needed to match your default flute/grain** causes the designs created from standards to be rotated to respect the default flute/grain direction. A similar option in the **Side** catalog, **For designs based on standards, mirror the result if needed to match your default side**, flips the design if needed to respect the default side.

An example of using the Standards Catalog

Here is how to create a design using the FEFCO 200 standard style.

1. Start ArtiosCAD.
2. Click **Run a Standard** on the **File** menu. The Standards Catalog will appear.

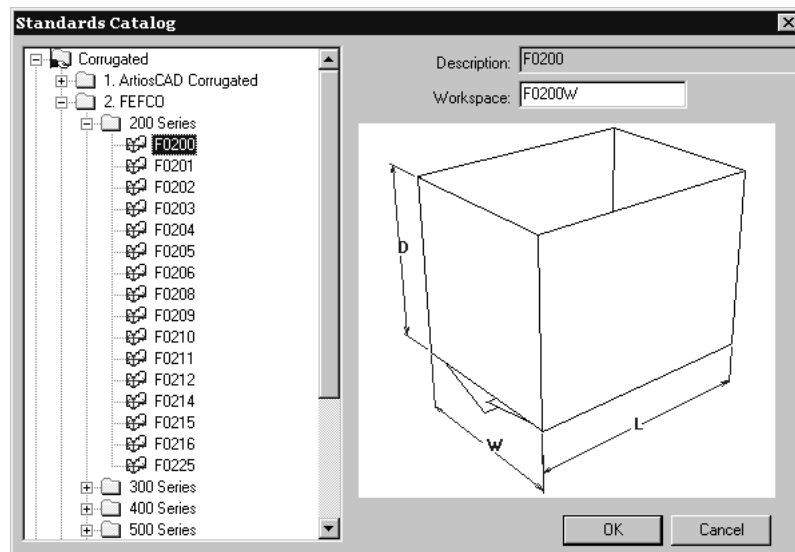

3. Click the plus sign (+) next to the FEFCO Catalog to show its contents, then click the plus sign next to the 200 Series folder to show its contents. Click the **F0200** style and then click **OK**.
4. In the Single Design Settings dialog box, choose the parameter set to use and board which will be used to make the carton. Click **OK** to continue.

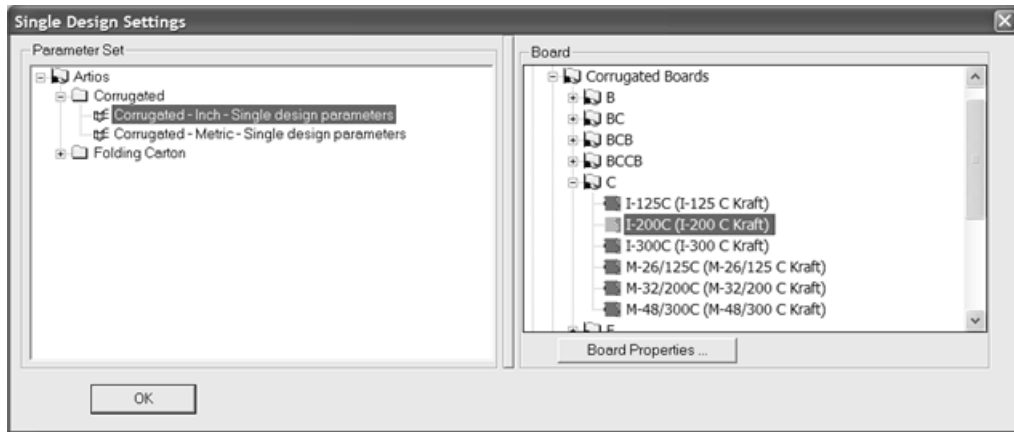

5. In the Inside Dimensions dialog box, enter the inside dimensions of the design. Click **OK** to complete the design using default values. Clicking **Next** takes you through menus of additional choices and values so you can review or alter the defaults of the standard, or you can progress by clicking the next menu lower in the tree control. In the last menu for a standard, the **Next** button is unavailable and you must click **OK** to complete the standard.

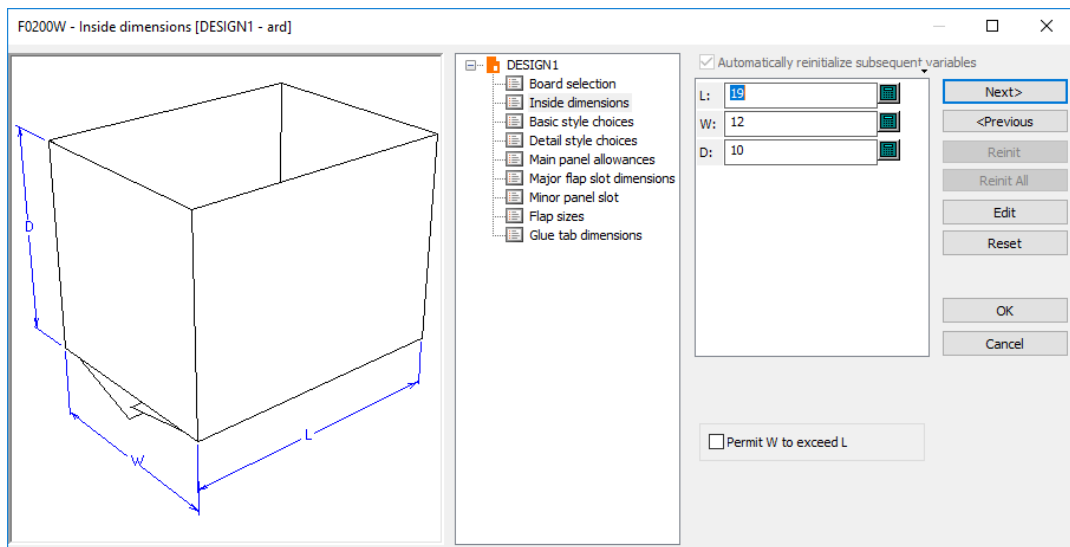

To change the display format of the variable labels, click the tiny triangle above the list of variables and select a different option. These options may be set in **Options > Defaults > Design Defaults > Rebuild Options**.

Running a new standard

To run a new standard in the current workspace, click **Design > Run new standard**. You will be asked to confirm erasing all elements and variables in the current workspace. Click **OK** to run a new standard, or **Cancel** to return to the workspace without making any changes. After clicking **OK**, choose the new parameter set and board code, choose the standard from a catalog, set

the dimensions, and so forth to create the new design. Values in the L, W, and D variables in the old design will be carried into the new design.

This option is also available on the Board selection menu when rebuilding a design based on a standard.

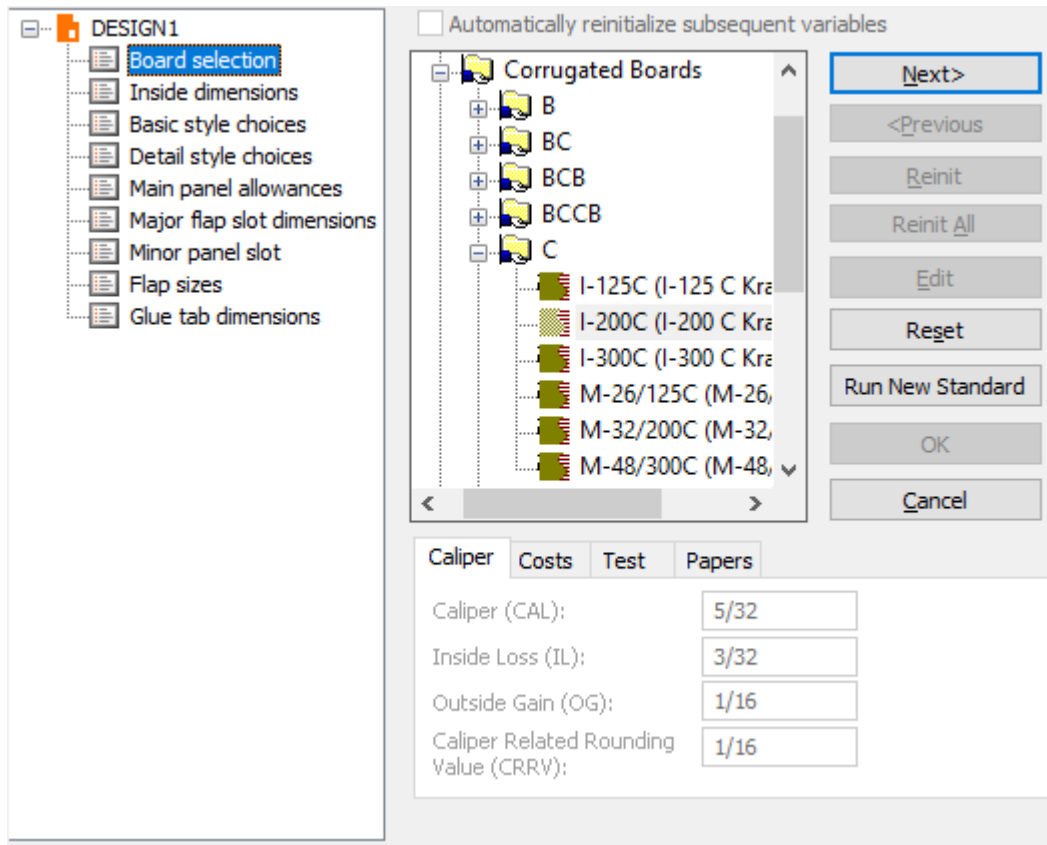

Running non-ArtiosCAD standards

ArtiosCAD can run standards from INTERACT, LASERPOINT, LASERPOINT IQ 1, LASERPOINT IQ 2-4, and The Designer WorkBench.

The standard libraries from INTERACT, LASERPOINT, LASERPOINT IQ (all versions), and The Designer WorkBench standards are optionally loaded when ArtiosCAD is installed.

Designer WorkBench and LASERPOINT IQ 2-4 Standards

The Designer WorkBench and LASERPOINT IQ 2-4 standards run as if they were native ArtiosCAD standards.

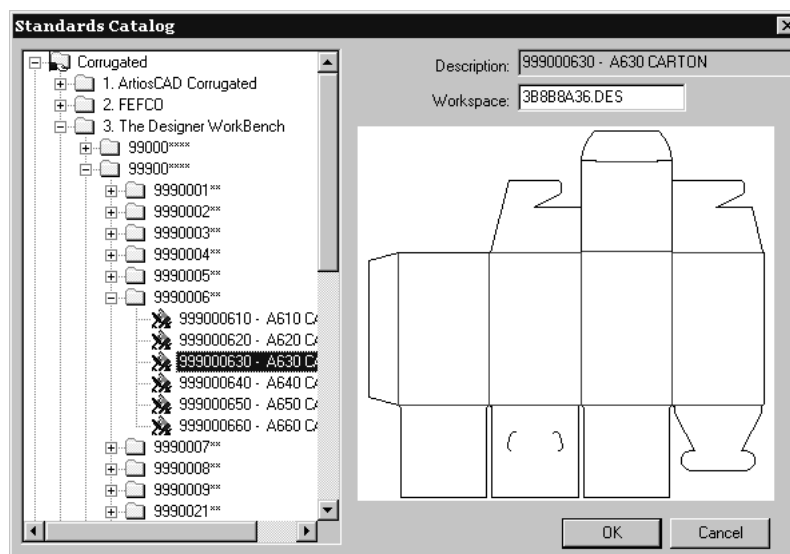

Variables and style choice menus work the same way for these standards as they do for native ArtiosCAD standards. Run them as you would normally run any other ArtiosCAD standard.

Designer WorkBench standards run with the same default values for variables that they had when they were run in Designer WorkBench. However, the # in the name of the variable in DWB is converted to **DWB** when the standard is run in ArtiosCAD.

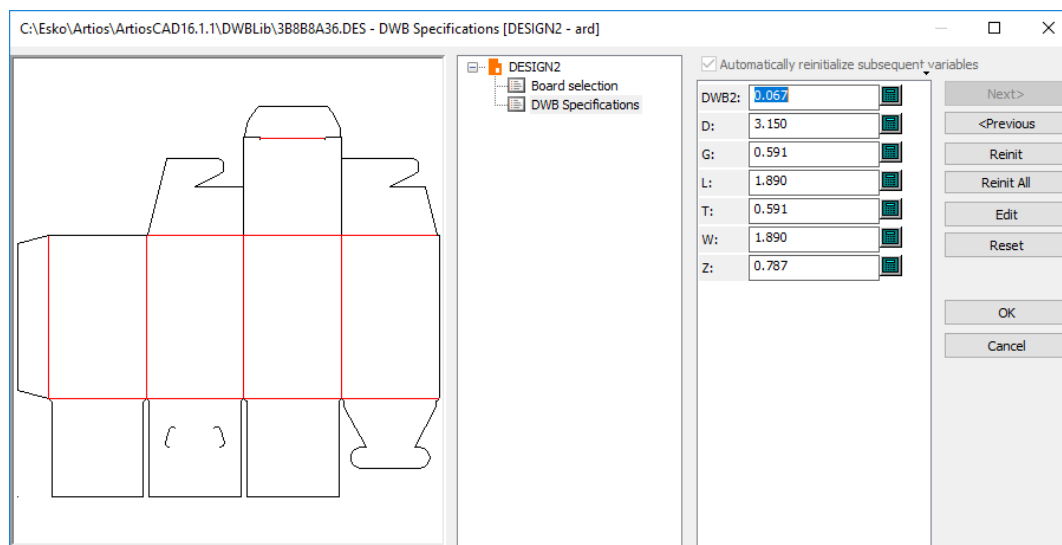

INTERACT, LASERPOINT, and LASERPOINT IQ 1 standards

Standards made using INTERACT, LASERPOINT, and LASERPOINT IQ 1 are run using a separate data-entry window.

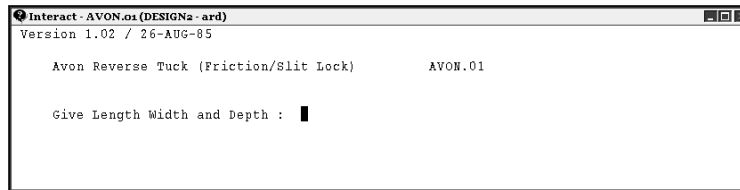

To run INTERACT standards, you must enter information in the same format as the prompt used to request it. In the picture shown above, you are prompted to Give Length Width and Depth. This means you must enter the dimensions on the same line with nothing but spaces between them – e.g. 5 2 5. When you have finished entering data, press Enter.

Note:

When running an INTERACT standard, do not click inside the black-background window. This will be interpreted as an Enter keystroke and the window will close. ArtiosCAD will issue an error message and you will have to start over.

LASERPOINT and LASERPOINT IQ 1 standards also run using a black window for data input. Enter a value in each field underlined with a yellow line. Click **ACCEPT** to proceed through the menus. Click **OVERVIEW** to go to a menu of all menus. Click **REINIT** to reset the variables in the current menu to their default values.

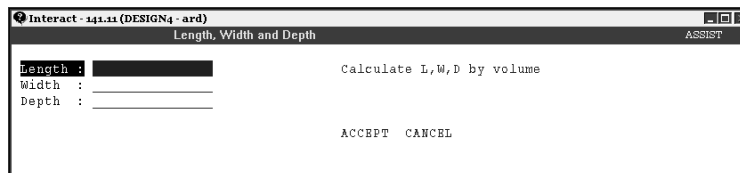

Rebuilding any of these standards will bring up the appropriate black-background window.

Rebuilding designs



To rebuild a design, click the **Rebuild** button on the Toolbar. The same dialog boxes which appeared when you built the design will reappear. Change the values to change the dimensions of the final design.

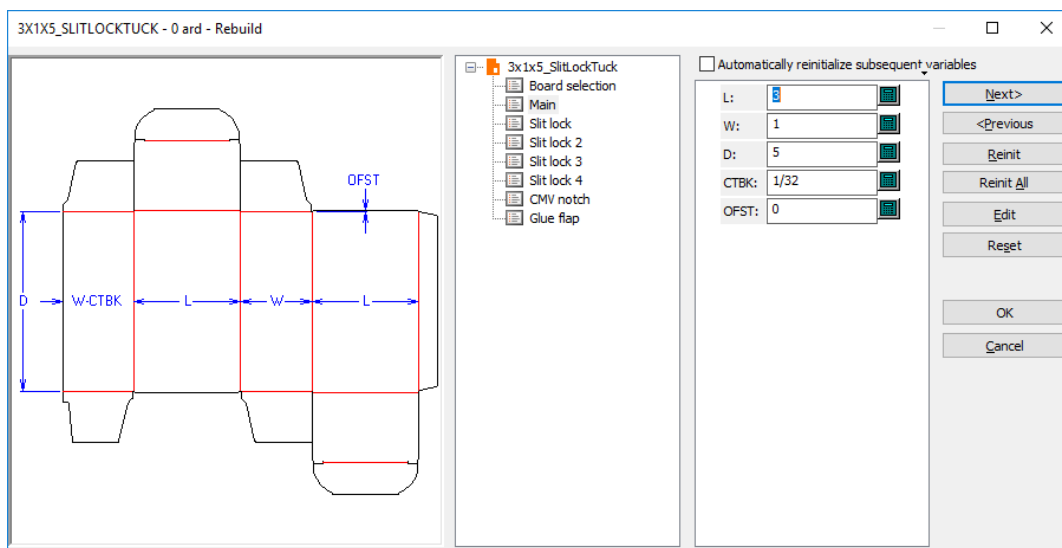

Most variables you change from their default values are flagged with yellow triangles as soon as you click something else. Variables which have both a default formula and a default value that fails a check condition (such as W with a default formula of 0 and the check condition being $W > 0$) are not flagged with yellow triangles. Style choice variables with default formulae are also not flagged.

Four buttons and one option in the Rebuild dialog box change the values of the variables as you rebuild the design:



Reinit reinitializes the currently-selected variable to its default value as defined in StyleMaker.

Reinit all reinitializes all variables in the current menu to their default values as defined in StyleMaker.

Edit opens the Edit Variable dialog box where you can edit the formula used by the variable, the variable's check condition, the description of the variable, the variable type, the current value of the variable, and the rounding method and amount.

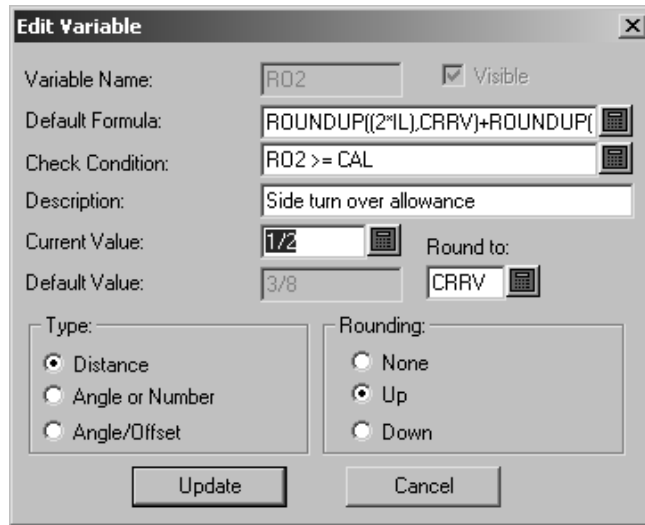

Reset resets the variable to the value it had when the menu was accessed last. For example, if you change a variable from 5 mm to 10 mm, go to the next menu, realize you made a mistake and go back, change the variable to 7 mm and click **Reset**, the variable will change to 10 mm, which is what it was when you entered the menu. If you wanted to change it back to 5, click **Reinit** instead of **Reset**.

Automatically reinitialize subsequent variables reinitializes variables in subsequent menus which currently match their default values. When this option is selected and you change a variable, any subsequent variable depending on that variable which matched its default value before the rebuild started will get updated with the new value. For example, with this option selected, if you change L, any variable in any subsequent menu which depends on L gets automatically updated with the new value for L.

When this option is off, dependent variables are not automatically updated and are flagged for review in the Rebuild Conflicts dialog box.

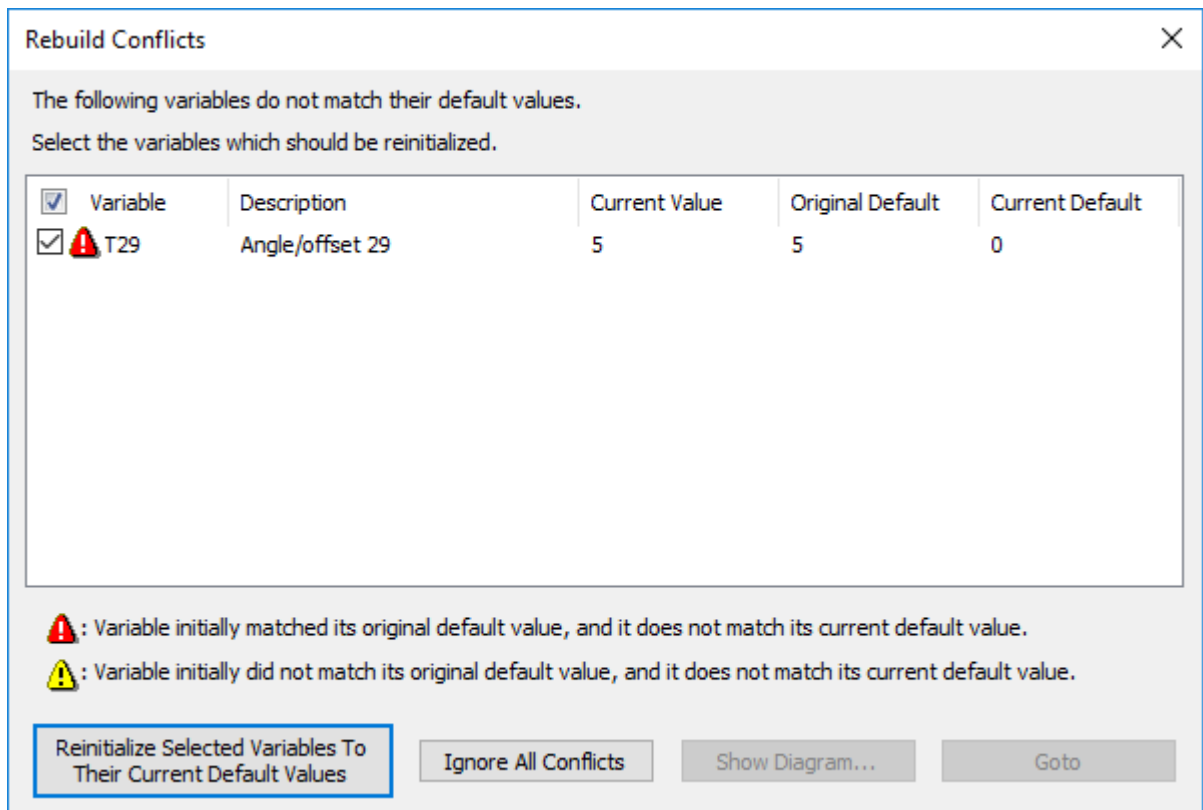

The checkbox to the left of the variable name controls if the variable is reinitialized to its current default value when you click **Reinitialize Selected Variables To Their Current Default Values**. Variables with yellow triangles are not automatically selected, while those with red triangles are automatically selected for reinitialization.

Variables with yellow triangles are those which did not initially match their default values at the start of the rebuild. Variables with red triangles did match their default values, but currently do not.

Click **Reinitialize Selected Variables To Their Current Default Values** to reinitialize the checked variables and continue the rebuild. Clicking **Ignore All Conflicts** ignores the conflicts and continues the rebuild process.

Note: This value-checking procedure only works for variables which have default values set. There is no checking for variables which have no default set but instead depend on other variables.

Annotations and Dimensions

Builder allows you to add dimensions and annotations to your designs.

Dimensions are measurements showing the length of lines, the sweep of angles, the radii of arcs, and so forth. The tools on the Dimension toolbar control the creation, placement, and properties of dimensions.

Details are magnifications of a user-defined area of the design that show the construction in detail.

You can also add text and arrows using those buttons on the Annotations toolbar. Both toolbars are shown below.

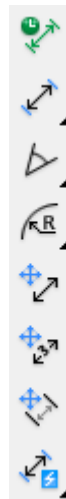
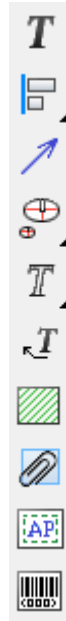

Note: Some of the tools on the Annotation toolbar are only available if you have Designer in addition to Builder.

Paragraph Text tool

T The first button on the Annotation toolbar lets you add a paragraph of text. Click the tool, indicate the position for the text, and enter the desired text in the Paragraph Text dialog box.

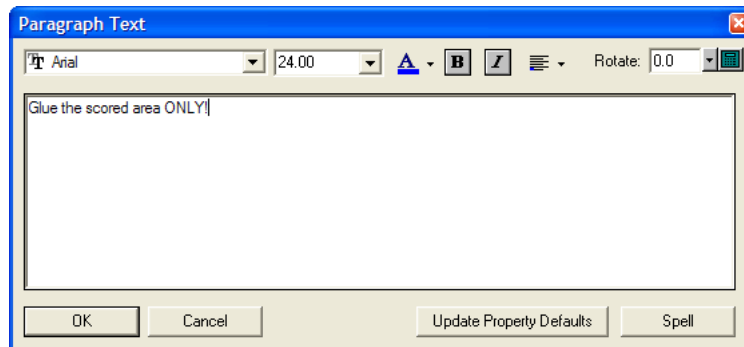

As you enter text in the dialog box, it appears as drag text at the put-down point in ArtiosCAD. Changes are immediately reflected in the drag in the design window, and they apply to all the text entered in the dialog box.

Set the font and font size using the drop-down list boxes at the top of the dialog box. You may also change the font size manually by typing the new size in the drop-down list box field.

Note: PCIQ fonts may appear incorrectly in drag text but should appear correctly when the text is placed.

A The color under the **A** indicates the color of the text. A bright blue indicates that the plotting style color is being used. When you click the button, a control appears. Click the desired color. **Use plotting style** sets the text to the color defined by the plotting style. Below that are standard color swatches. **More Colors** lets you choose a new color from a palette or define a new one to use this time.

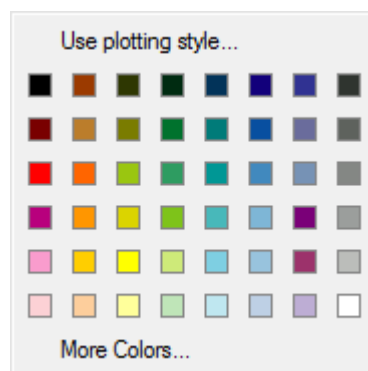

Note: If you assign a color to text, it is considered graphics and will not be output to a CAM device using an internal ArtiosCAD driver. If you need to output text to a CAM device, do not change its color. However, define a color when planning to convert the design to 3D and export it to VRML.

 The **B** and **I** buttons toggle **bold** and *italic*.

 The **Justification** button shows how the text is currently justified to the put-down point. When clicked, it shows 9 buttons corresponding to different placement options; click the desired button to change the justification.



Rotate:  The controls in the **Rotate:** field let you rotate the text as desired. Either select the desired degree of rotation from the drop-down list box, enter it in the field manually, or click the keypad icon and use the keypad to input the degree.

While the Paragraph Text dialog box is open, reposition the text as desired by clicking in different places.

Update Property Defaults sets the current font and size values in the dialog box for use in future instances of this dialog box in the same ArtiosCAD session.

Once you have entered the text in the Paragraph Text dialog box, click **OK** to place it.

After you have added text, double-click it with the **Select** tool to access its Properties dialog box. Use the commands in the Properties dialog box to change the attributes of the text, such as font, color, size, rotation, kerning, etc. Click **OK** to make the changes, or click **Cancel** to discard them.

Note: Note: ArtiosCAD supports up to 38 fonts in a workspace.

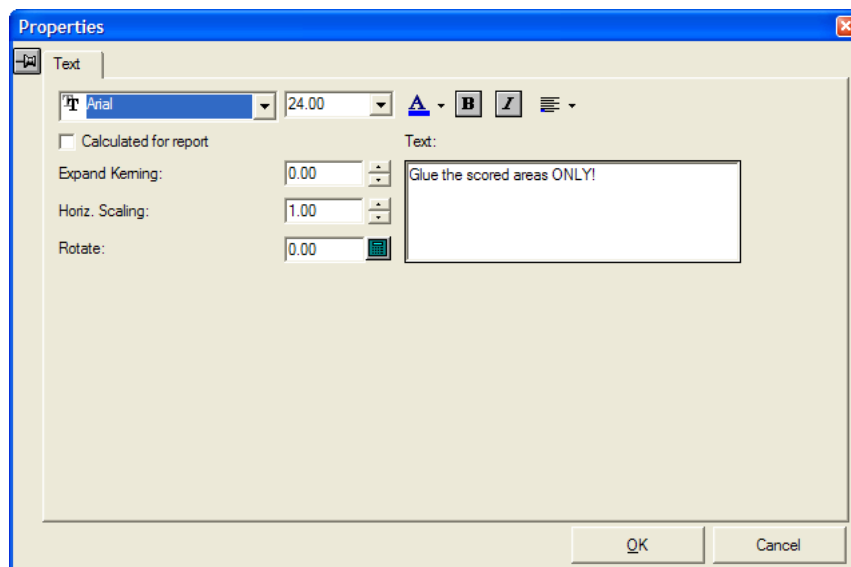

The controls in the Properties dialog box are the same as the controls in the Paragraph Text dialog box, except **Calculated for report** lets you modify the properties of calculated text on Reports.

Spell checking in the Paragraph Text tool

If you have Microsoft Word installed on your system, ArtiosCAD can use its spell checking functionality if it is enabled in Defaults (**Options > Defaults > Shared Defaults > Startup defaults > Spelling**). It is enabled by default. The Paragraph Text dialog box may take a few moments to appear after the tool is clicked for the first time.

As you enter text in the **Paragraph Text** tool, ArtiosCAD communicates with the spell checker in Microsoft Word, and any unrecognized words are underlined and shown in red.

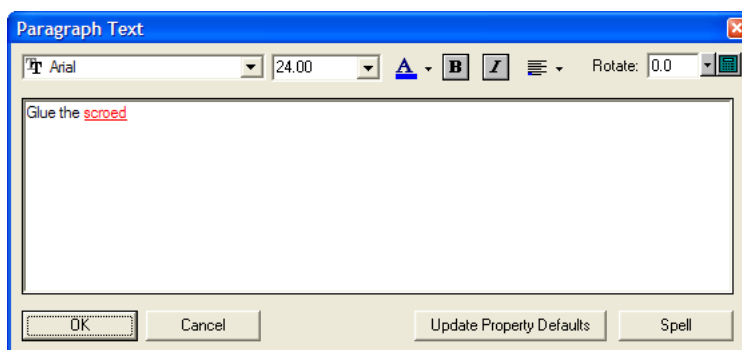

To spell check the unrecognized word(s), either right-click and click **Spell** on the context menu, or click **Spell**. The standard Microsoft Word Spelling dialog box appears similar to the one shown below.

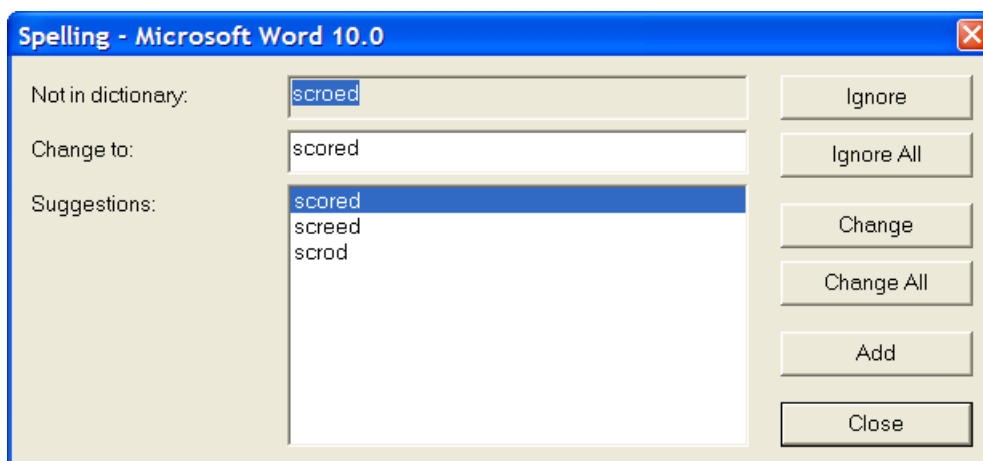

The unrecognized word is shown in the **Not in dictionary:** field. The **Suggestions:** field contains the list of suggested words, and the top one is selected and seeded to the **Change to:** field. You may edit the word in the **Change to:** field as desired.

Ignore and **Ignore All** respectively ignore this instance and all subsequent instances of the unrecognized word for this invocation of the spell checker. The next unrecognized item is then displayed.

Change changes the current instance of the unrecognized word to the contents of the **Change to:** field. **Change All** changes all subsequent instances of the unrecognized word in the

workspace to the contents of the **Change to:** field; previously-ignored instances are not changed. The next unrecognized item is then displayed.

Add adds the unrecognized word to the custom ArtiosCAD dictionary file so that it will be recognized in the future. The next unrecognized item is then displayed.

Close closes the Spelling dialog box and returns to the Paragraph Text tool.

Align Text tools

The second button on the Annotation toolbar activates the **Align Left** tool, and when held down, activates the Align Text tools flyout toolbar.



The **Align Left** tool aligns the selected items along their left edge.



The **Align Horizontal Centers** tool aligns the selected items along their horizontal centers.



The **Align Right** tool aligns the selected items along their right edge.



The **Align Bottom** tool aligns the selected items along their bottom edges.



The **Align Vertical Centers** tool aligns the selected items along their vertical centers.



The **Align Top** tool aligns the selected items along their top edges.

To use these tools, do the following:

1. Select one or more items of text, and click the desired Align Text tool. The drag will show a common alignment line.
2. Indicate a pick-up point, and then use the drag to set the put-down point. Shown below is the drag for the **Align Left** tool.



3. The text will be aligned in the manner consistent with the tool chosen.

Artios CAD

Arrow tool

 The third button on the Annotation toolbar activates the **Arrow** tool. To make an arrow, click the Arrow tool, click the start point of the arrow, and then click the end point of the arrow. The head of the arrow will be drawn at the end point of the arrow.

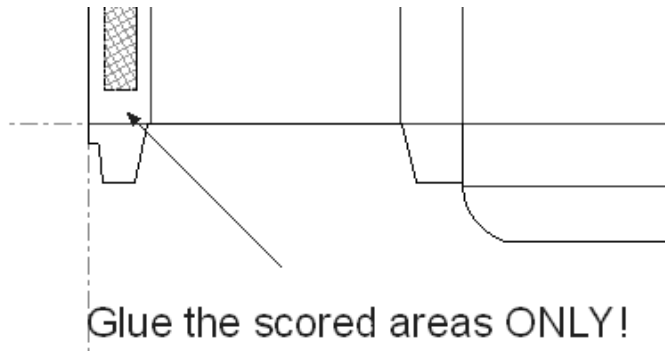

Once you have added an arrow, double-click it to change its properties.

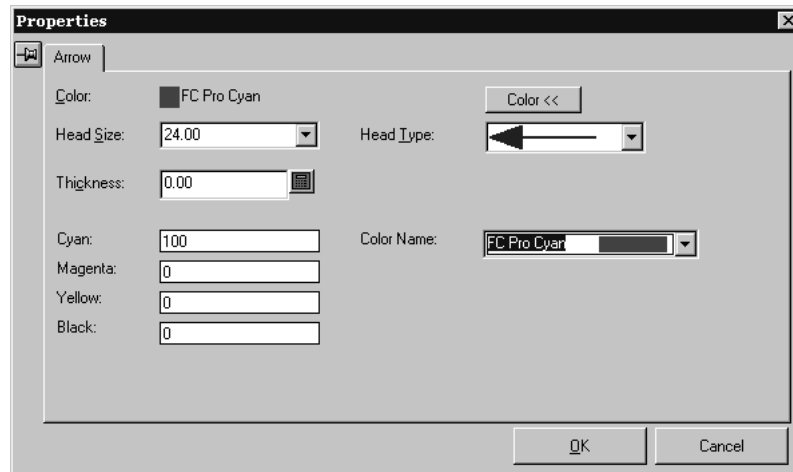

Detail tool

 The fourth button on the Annotation toolbar activates the **Details** flyout toolbar. Details are magnifications of a designated area of the design.



The first button on the Detail toolbar, and the default Detail tool shown on the Annotation toolbar, is the **Detail** tool. The Detail tool, when clicked, prompts for the first corner of the clipping window. The clipping window (window 1 below) defines the area of the design to magnify. Indicate the corner, keep depressing the mouse button, and indicate the second corner of the clipping window. ArtiosCAD then prompts for the first corner of the detail window. The detail window (window 2 below) is where the magnified view appears. Click the mouse button at the first corner, and drag the mouse to the diagonally opposite corner of the detail window.

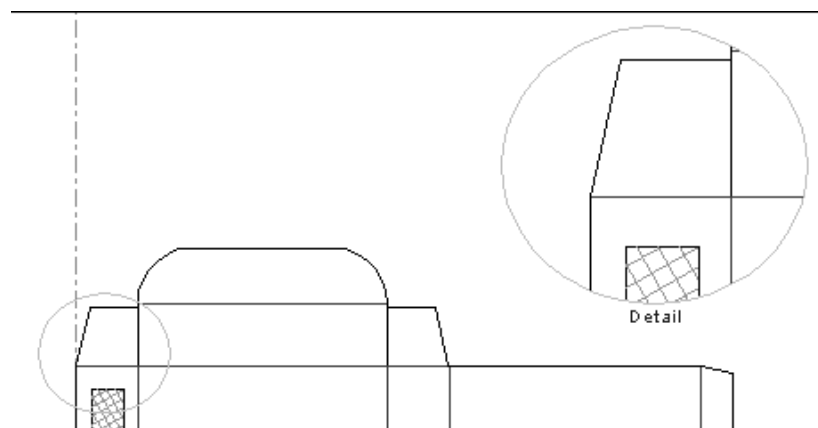

Double-click any item inside the detail window to change the properties of that detail. Click the **Detail** tab in the Properties dialog box to view the properties of the detail.

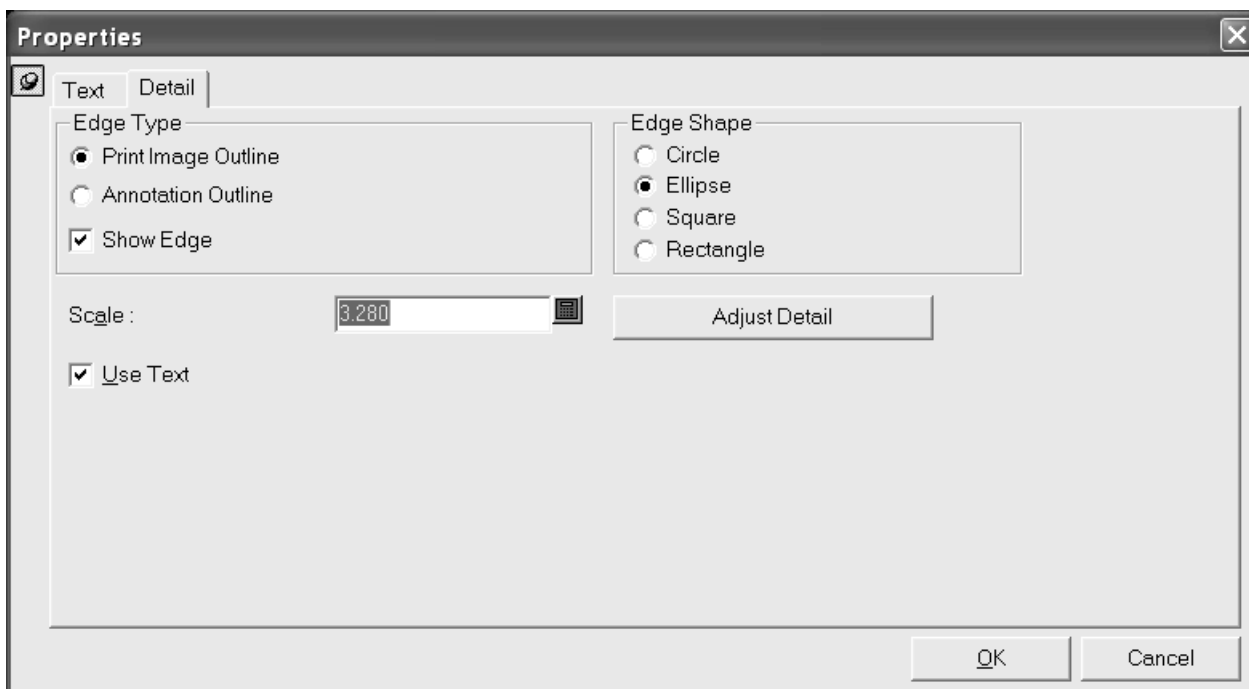

The clipping and detail windows will update as their properties are changed. The **Adjust Detail** button closes the Properties dialog box and starts the **Adjust Detail** tool.

When you Output a design with a detail, sometimes the design may flip depending on the settings of the Output, which can cause confusing behavior for details. Starting with version 16.1.1, the following rules apply to details when you Output them:

- If a piece of text or a dimension is entirely within the clip outline, ArtiosCAD copies it whole so it will match the Output.
- If the dimension text is outside the clip outline, ArtiosCAD does not copy the dimension.
- If the dimension text is inside the clip outline, but some of its lines are clipped, ArtiosCAD copies the text from the dimension as a text item and clips the lines of the dimension, making it all the same copy as the original item. This will not mirror if the design flips on Output.
- If a text item is partially inside the clip outline, ArtiosCAD converts it to outlines and clips it. These outlines will mirror if the design flips on Output.
- ArtiosCAD clips strokes and fills.
- ArtiosCAD does not copy images.

Regarding these rules, when you open a design created in an earlier version of ArtiosCAD, ArtiosCAD will behave as it always has. However, if you rebuild the design or create a new detail, the above rules will apply.

Adjust Detail tool



The second button on the Detail flyout toolbar activates the **Adjust Detail** tool. The Adjust Detail tool modifies the size and position of the clipping window and the detail window.

The Adjust Detail tool has three modes: **Move Clip**, **Move Detail**, and **Move Side**. **Move Clip** lets you move the clipping window to another location. Use this option by selecting the **Move Clip** option button, clicking inside the clipping window, and clicking at the new location of the clipping window.

Move Detail lets you move the detail window to another location. This option works the same way as **Move Clip**, except click in the detail window instead of the clipping window.

Move Side lets you drag a side of either the clipping window or the detail window to a new location, thereby changing the size of the window.



Outline text tools

T The **Outline Text** tool, which is the fifth button on the Annotation toolbar, activates the **Outline Text** tool when clicked, and when held down, activates the Outline Text Tools flyout toolbar.



This tool converts text into print image lines. The lines comprising letters or numbers are placed in separate groups. Shown below is text before and after being converted to outlines.



Use this tool by selecting the text to convert and then click the button on the toolbar.

Line text tool

T The second button on the Outline Text tools flyout toolbar activates the **Line Text** tool.

This tool converts text into geometric lines which can be manufactured. To use this tool, click it, and then click the block of text to change. The text will change to lines with the closest possible

appearance to the original font. Shown below is a block of text in the Georgia TrueType font before using the Line Text tool:

Meeber
Box Company

After the tool is used, the text appears like this:

Meeber
Box Company

Line type label tool

 The sixth button on the Annotation toolbar activates the **Line Type Label** tool. This tool creates a piece of text and an arrow pointing to a particular line.

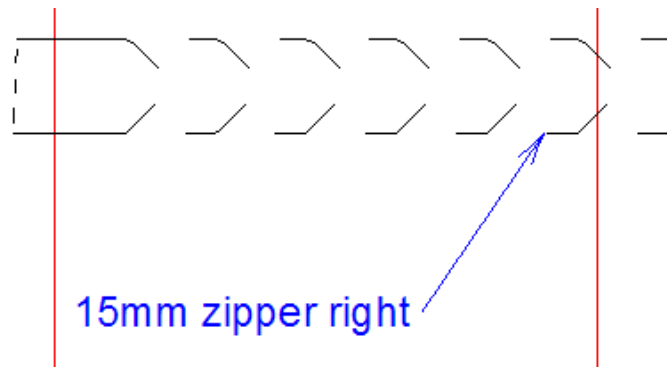

The following controls appear on the Status bar when this tool is active:



The **Size**: drop-down list box changes the size of the line type label you are about to make.

More Options (...) opens the Line Type Label Properties dialog box as shown below.

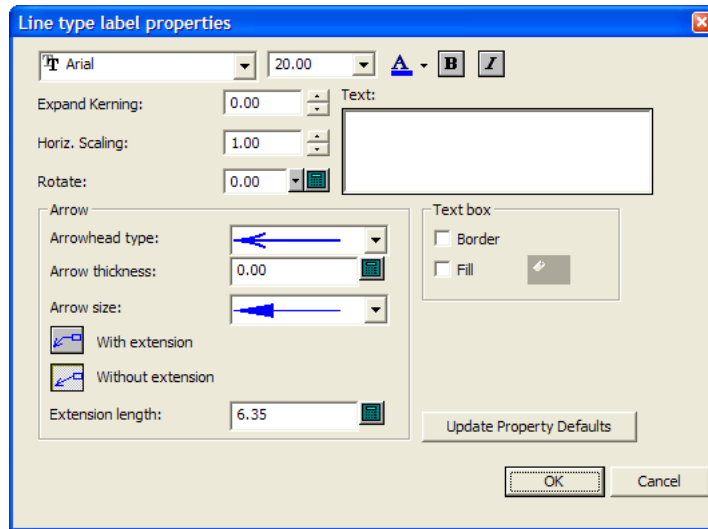

Standard font controls are arranged along the top of the dialog box. **Expand Kerning:** increases or decreases the space between letters. **Horiz. Scaling:** increases or decreases the overall width of the text. **Rotate** allows you to place the text at an angle.

In the **Arrow** group, choose an **Arrowhead type:** and overall **Arrow size:** from their respective drop-down list boxes. **Arrow thickness:** adjusts the arrow thickness in points.

With extension creates a short horizontal line out from the label text using the value in the **Extension length:** field before the start of the arrow. **Without extension** places the end of the arrow directly next to the label text.

In the **Text box** group, **Border** and **Fill** each create their namesakes around the label text. The border has the same color as the label text, but the fill color is set using the button that becomes available when **Fill** is checked.

Update Property Defaults makes subsequent line type labels made in this session of ArtiosCAD use the same Properties as those set in the current dialog box.

Returning to the Status bar, **Update Property Defaults** sets the size of the current line type label to be the default for the session.

Text: is the text that will become the line type label. If this field is blank, ArtiosCAD will automatically fill it in with the selection in the **Initial text:** field as you drag across lines.

The **Initial text:** drop-down list box lets you choose what ArtiosCAD automatically inserts in the **Text:** field as you drag. You can choose the **Line type name**, the **Line type name and label**, and the **Line type label**. The **Line type label** only applies for special rules, and is defined in the **Rule label:** field on the Manufacturing tab of the Properties dialog box for a special rule; rule labels may also be defined for special rules in Defaults.

To make a line type label, do the following:

1.  Click the **Line Type Label** tool.
2. If automatic layer switching is on, ArtiosCAD moves to a valid layer or creates one. If it is off, and the current layer is not appropriate for a line type label, ArtiosCAD prompts you to change to an appropriate layer or confirm using the current layer.
3. As you drag, the cursor will show the name of the nearest rule or special rule. If you do not click close enough to a rule, enter the text for the label in the **Text:** field on the Status bar;

the input focus is set to that field if ArtiosCAD does not fill it in automatically and the drag will show the text you entered. Click at the point or coordinate which will be the end of the arrow.

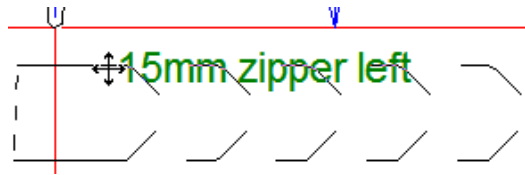

4. Use the drag to set the position of the label.

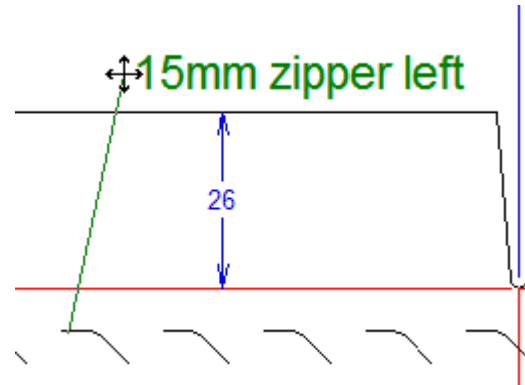

5. If desired, change the options on the Status bar. The drag will remain active.
6. Click to set the final position of the label.

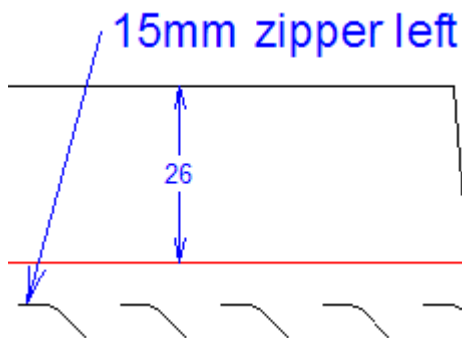

7. The tool remains active in order to add more line type labels. Either make more line type labels or activate another tool.

You can use drag to move the line type label (or elements of it) after it is created. If you use the Select tool and click near the text box, you can move the text box.

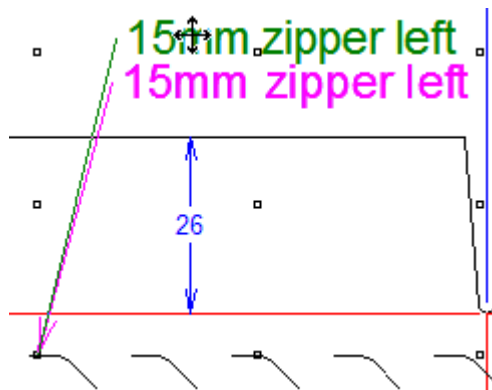

Click near the end of the arrow to move the end of the arrow.

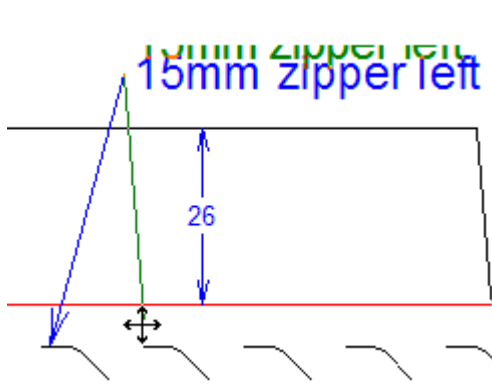

To move the entire label, click somewhere else nearby.

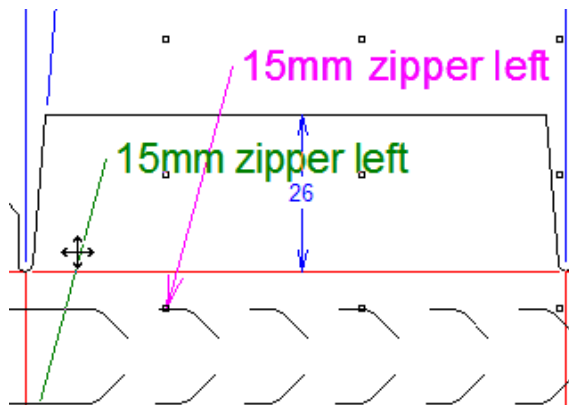

The default initial text option can be changed in **Options > Defaults > Startup defaults > Line type label options**. Text defaults for this tool are in **Options > Defaults > Property defaults > Line type label**.

Note: Avoid using the Select tool in **Selection ignoring groups** mode to delete individual parts of a line type label, as this will lead to unpredictable results.

If you change the line type of a line which has a line type label associated with it, ArtiosCAD now automatically updates the line type label to match the new line type according to the table of conditions below.

Condition for the existing line type label	Result after changing the line type
Line type label has custom text entered in the Text field.	No result; the label is not changed.
Label initial text is set to Line type label .	Changed to match new line type.
Label initial text is set to Line type label (defined on the Manufacturing tab of the properties of a special rule type).	Changed to match the new Manufacturing name if one is defined for that special rule, else changed to match new line type.
Label initial text is set to Line type name and label .	Both are changed.
Line type label is in a turned-off layer.	The line type label is changed and the layer is turned on.
Line type label is in a locked layer.	The line type label is not updated and a warning appears.
Line type label is in a single design embedded in a manufacturing document.	The undo history is cleared and a warning appears that this action cannot be undone.

Hatch tool

 The **Hatch** tool fills an area of the design with either a pattern of lines or a custom pattern you have designed and added to the Hatch Catalog.

- It uses a catalog of entries to use different hatches. ArtiosCAD displays a catalog control on the Status bar when the Hatch tool is active.
- You can design custom hatch patterns, including those that do not use lines, to form any fill pattern desired.
- You can Output a Hatch Legend, which shows up to 7 hatches used in the current single design.

Hatch Status bar

When you click the **Hatch** tool, the following controls appear on the Status bar:



 The first control on the Status bar is the toggle for **Select a Panel** mode. When the tool is in this mode, ArtiosCAD hatches the panel you click inside.

 The second control on the Status bar is the toggle for **Select Lines** mode. When the tool is in this mode, ArtiosCAD prompts you to select the lines forming a loop that, when complete, will be hatched.

Hatch Lines, the third control, is available only when a complete loop of lines is selected when the tool is in Select Lines mode. It hatches the area within the loop.

Use the fourth control on the Status bar to select an entry from the Hatch catalog. Click the drop-down list activator and click the desired entry.

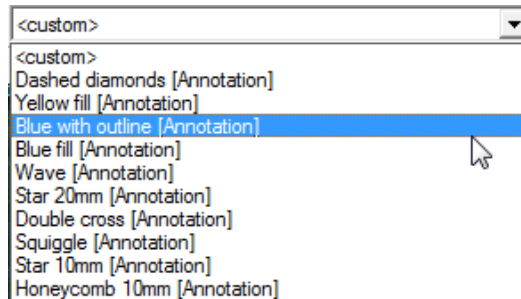

The fifth control on the status bar, ..., opens the **Hatch Properties** dialog box. If the catalog selection is set to a specific selection, the Hatch Properties dialog box for that selection opens showing the entry selected in the catalog. Click a different catalog entry to change the hatch style.

Clicking the **Custom** option button with a catalog entry selected changes the dialog box to show the properties for the selected entry. This same dialog box appears when **<custom>** is selected in the drop-down list box on the Status bar and you open the Hatch Properties dialog box, except the properties for the selected entry are shown, not the default non-cataloged hatch of green lines at 45 and 135 degrees. Refer to the next section for more information about this dialog box.

The values in **Offset from cuts** and **Offset from creases**, the sixth and seventh controls on the Status bar, both control how far away the hatch stays from the lines defining the panel or area being hatched.

Hatch Properties dialog box

The **Hatch Properties** dialog box has two variants - **Catalog** mode and **Custom** mode. In Catalog mode, the currently-selected catalog entry is highlighted and you can select a different catalog entry if desired.

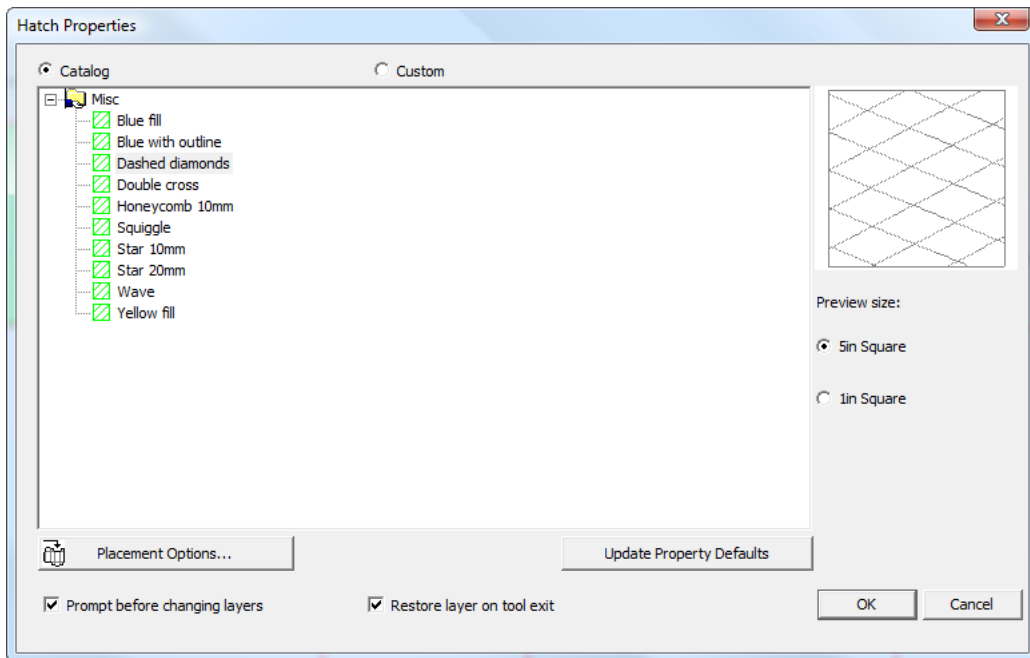

When you start in Catalog mode and click **Custom**, the properties of the catalog entry appear.

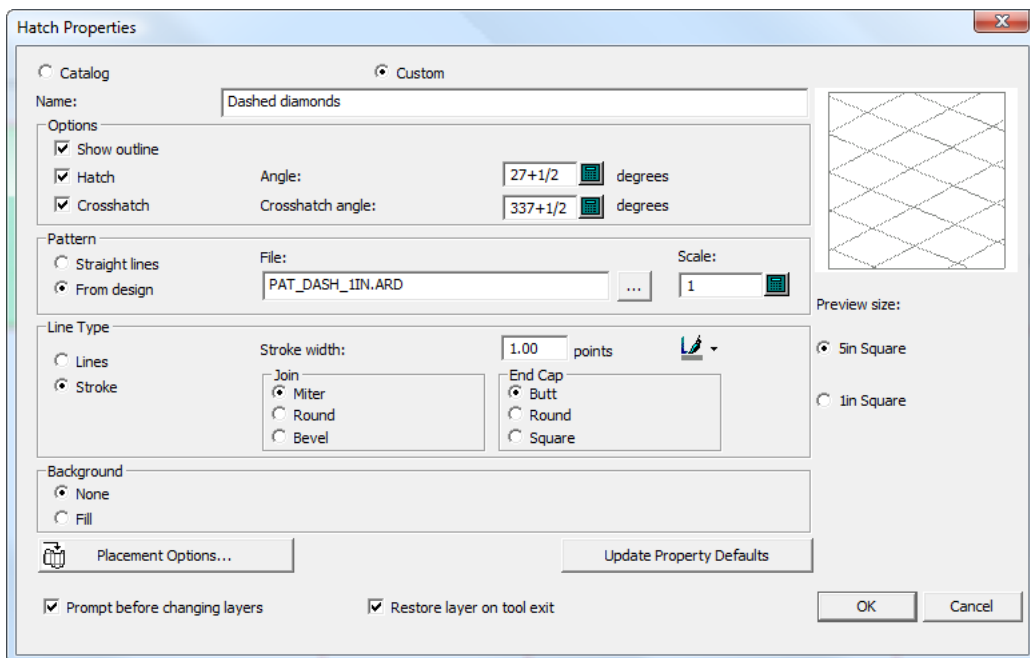

In Custom mode with no catalog entry selected, you can specify a pattern workspace or line style to use, along with other properties such as line type and background fill.

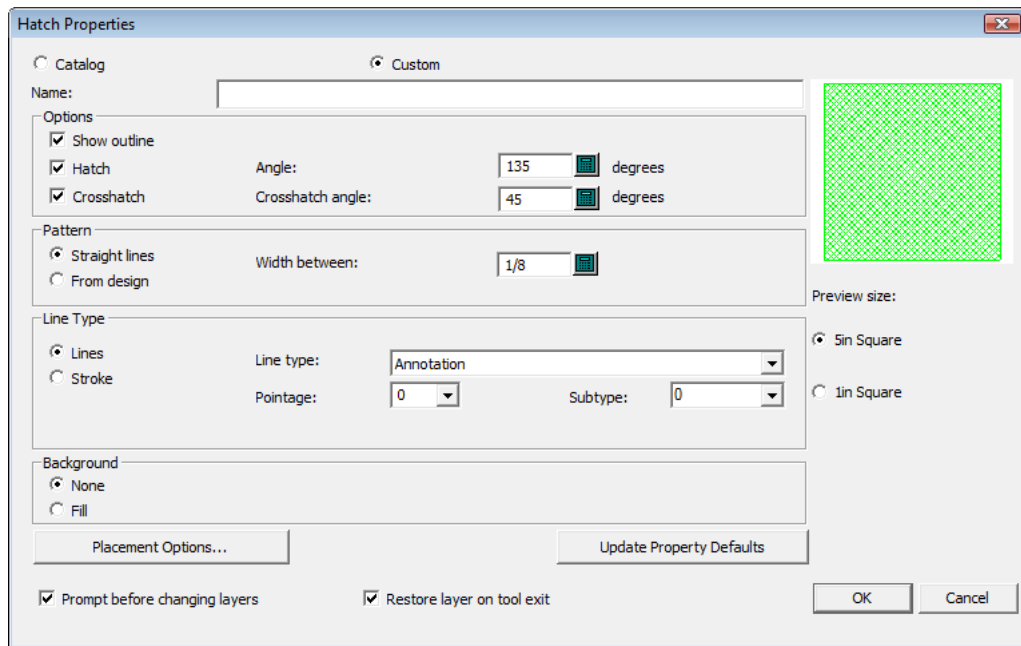

When you view the properties for an existing hatch by double-clicking its edge with a Select tool, the Properties dialog box does not display a preview of the hatch, because the hatch in the workspace is updated as you change values in the dialog box. In addition, the placement options and related fields are hidden when viewing the properties of an existing hatch.

Enter a name for these hatch properties, if desired, in the **Name** field.

The controls in the **Options** group define the construction of the hatch. If **Show outline** is checked, a border is drawn around the hatch that is a scaled-down copy of the lines defining the hatch area. **Hatch** controls the construction of the hatch lines made at the value specified in the **Angle** field. **Crosshatch** makes a second set of lines at the angle defined in **Crosshatch angle**. Deselecting **Hatch** turns off the crosshatch and makes its checkbox unavailable.

The **Pattern** group controls determine if the hatch is made of **Straight lines** or is based on a design file you specify by choosing **From design** and then browsing for the design in the **File** field. If you choose straight lines, set the distance between them using the **Width between** field. If you choose a design file, set the scale of the pattern using **Scale**.

In the **Line Type** group, to use just structural lines, choose **Lines** and set the **Line type**, **Pointage**, and **Subtype** fields appropriately. To use stroked structural lines, choose **Stroke** and set the **Stroke Width**, **Join**, and **End Cap** as desired.



To set the color of the stroke, click the paintbrush and then choose the desired color from the pop-up dialog box. Change the palette by clicking **More Colors**.

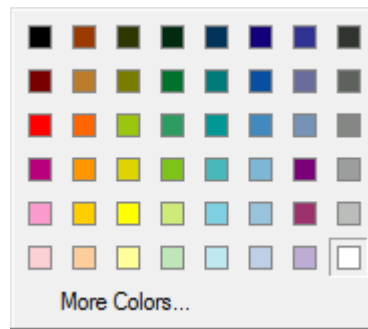

In the **Background** group, to have a fill behind the hatch, choose **Fill** and set the color with the standard Windows color control. To have no fill, choose **None**. Fill will cover the background regardless of the layer it is in.

Placement Options is described in the next section.

Update Property Defaults updates the current design's Defaults so that future hatches you make in this design will use these same properties. Clicking this button does not affect hatches you have already made.

Prompt before changing layers controls whether ArtiosCAD asks you to confirm changing layers if you are in a different layer than the one specified in the Placement Options dialog box. If you do change layers for hatch, **Restore layer on tool exit**, when checked, returns you to the layer that you were in before you started the Hatch tool.

Choose the larger **Preview size** option to see the preview from further away; choose the smaller option to see the preview more closely.

Hatch placement options

Clicking **Placement Options** in the **Hatch Properties** dialog box opens the **Hatch Placement Options** dialog box.

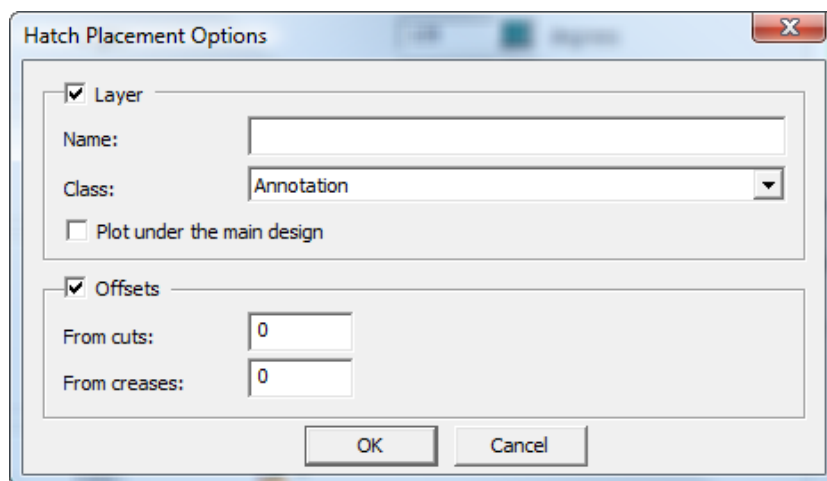

To create the hatch in a specific layer other than the current one, check the **Layer** checkbox, enter a name for the layer in the **Name** field, and choose the layer class in the **Class** drop-down list box. **Plot under the main design** draws the hatch and fill (if any) beneath the structure.

To create a gap between the hatch and any cuts or creases in the design, check **Offsets** and enter the offset values in the fields.

When either checkbox is checked, the **Placement Options** button in the Hatch Properties dialog box changes to include the icon as shown below.

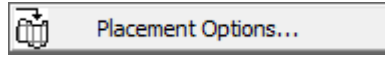

Using a hatch pattern file

To design custom hatch patterns, make single design workspaces with the desired geometry following the guidelines in this section. Custom hatch patterns may function as both hatches and crosshatches.

If you have StyleMaker, you can make the workspaces resizable, but note that they will not resize when you resize the design - you must create different versions of the pattern workspace at the desired sizes, save those files in ServerLib or ClientLib, and add Hatch Catalog entries that use those workspaces.

Shown below is the PAT_CIRCLEWAVE.ARD pattern workspace.

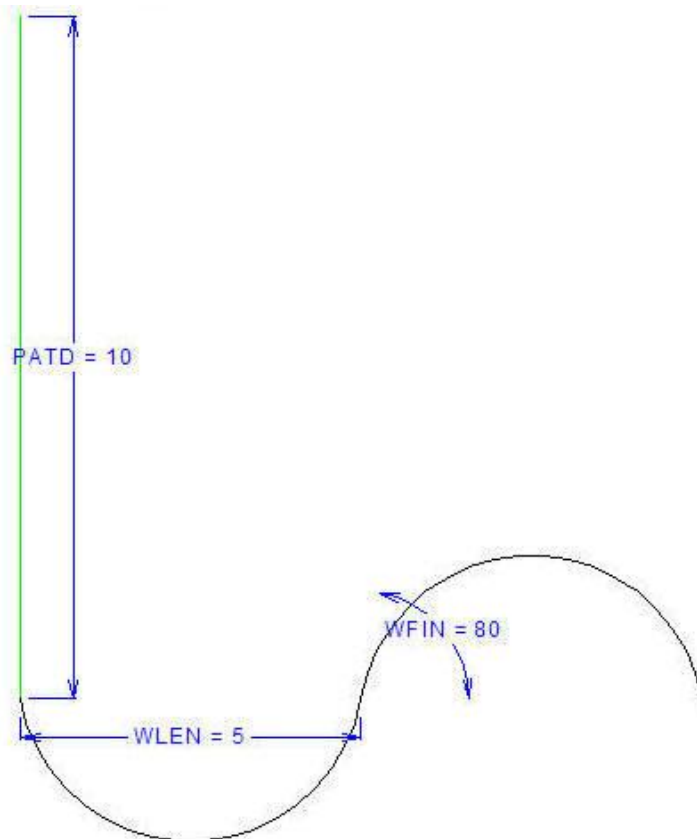

The length of the vertical annotation line is defined by variable PATD. The annotation line sets the distance between the wavy lines when the pattern is stepped and repeated at 45 degrees as shown below.

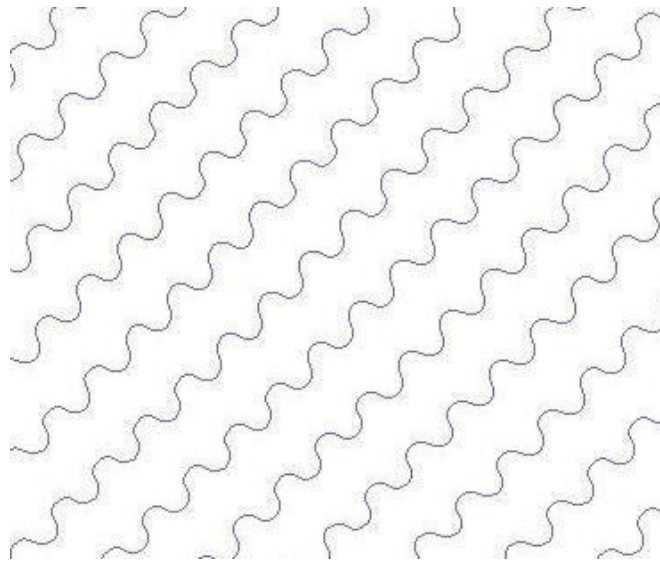

In the example workspace, variable WLEN sets the horizontal distance for each arc and variable WFIN sets the start angle of the arcs.

To make a custom hatch pattern workspace, do the following:

1. Start ArtiosCAD and create a new single design.
2. To make the pattern resizable, you must have StyleMaker. If so, define the variables you will need to construct the geometry.
3. Draw the desired pattern at 0 degrees horizontally. Use an Annotation line connected to the start of the pattern to define the distance between the pattern repetitions.
4. Save the workspace to ServerLib or ClientLib.
5. Add an entry to the Hatch Catalog in Defaults that uses this pattern workspace.
6. Use the catalog entry as desired.

To make different versions of the same resizable pattern, do the following:

1. Resize the pattern workspace as desired.
2. Save each version to ServerLib or ClientLib with a unique name.
3. in Defaults, create a Hatch Catalog entry for each iteration of the pattern workspace.
4. Use the new Hatch Catalog entries as desired.

Dimensions

Dimensions are measurements added to the design so that someone looking at the design knows the length, angle, and radii of the geometric elements of the design. Shown below is the Dimensions toolbar.

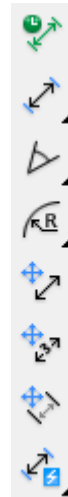

Before creating dimensions, ensure there are design lines in the **Main Design, Windows and Cutouts, or Manufacturing** layer of the design. If there are no design lines in any of those layers, you will get a warning dialog box when attempting to add dimensions. To work around this warning, move design lines to the appropriate layers and either change the dimension size or toggle **Scale size upon rebuild** in **Edit > Property Defaults** for Dimensions.

If you are not in a layer with class **Dimensions** or **Overall Dimensions**, the first time you click a dimension-creation tool you are asked if you want to create such a layer.

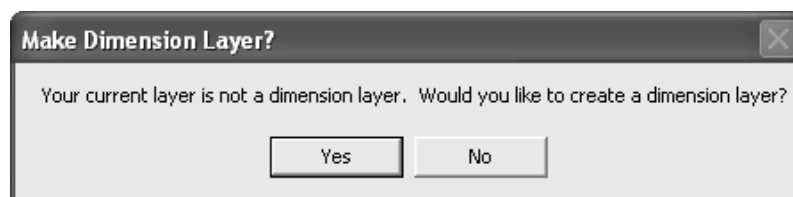

Click **Yes** to create a Dimension layer or **No** to keep working in the current layer. If you click **No**, and then proceed to make dimensions, you are not asked this question again. If you click **No** and do not make any dimensions, you are asked the question again the next time a dimension-creating tool is clicked.

If you click **Yes**, and there is no layer of class **Dimensions** or **Overall Dimensions** already in the design, the Use Dimension Layer dialog box appears.

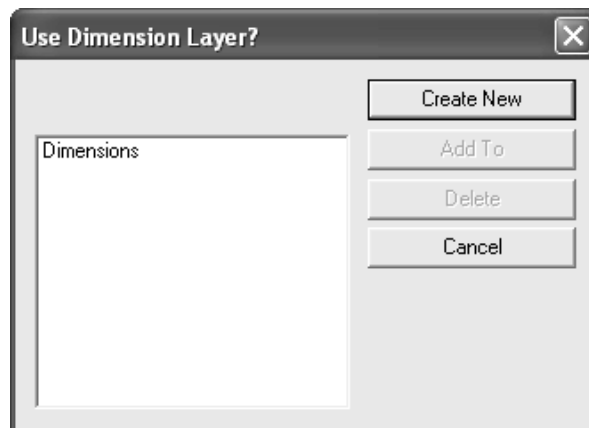

To create a layer with a custom name, click **Create New**, enter the layer name, choose its class, and click **OK**.

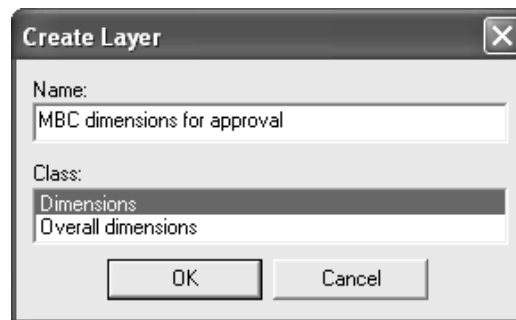

Or, to use a **Dimensions** layer, select it and click **Add To**. You can also use **Add To** to add to selected already-existing layers shown in the list.

Use **Delete** to delete the selected layer. Clicking **Cancel** completely stops the tool.



The first button on the Dimensions toolbar activates **Temporary Dimensions** mode. Dimensions made in this mode:

- Are not subject to any layer creation issues.
- Are made with light green extension lines to distinguish them from regular dimensions.
- Are not selectable, and thus may not be changed or deleted.
- Are not affected by a **Select** tool's Nudge by Stretch mode or by the **Stretch Point** tool.
- May be moved or stretched by the **Stretch by Polygon** tool. If only one of the end-points of a temporary dimension is within the selection polygon, the dimension is stretched instead of moved.
- Are shown only on the screen, and are not printed, Output, or exported to other file formats.
- Are deleted on Rebuild.
- Are in existence only until **Temporary Dimensions** mode is turned off by clicking the **Temporary Dimensions** button again.
- Are not saved when the single design is saved.

If **Temporary Dimensions** mode is active while in a **Dimensions** or **Overall Dimensions** class layer, when the Layers dialog box is opened, the pencil icon is dimmed to indicate **Temporary Dimensions** mode. It returns to normal when **Temporary Dimensions** mode is turned off.



The second button on the Dimension toolbar, and the default tool on the Distance Dimension flyout toolbar, activates the Distance Dimension tool. This tool measures the distance between two lines or points. To use this tool, do the following:

1. Click  to activate the tool.
2. To adjust the text position of the dimension after setting the line or point to measure to, select **Adjust text position** on the Status bar.
3. Click the line or point to measure from.
4. Click the line or point to measure to.
5. Click the extend position (where the measurement is to be placed).

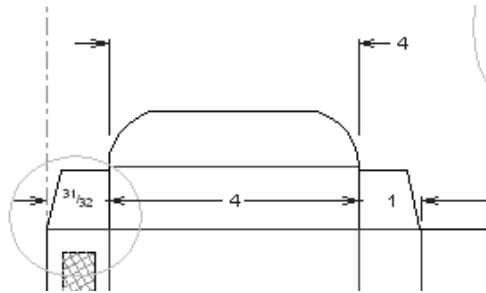

6. If you selected **Adjust text position** on the Status bar previously, click to set the desired position of the text.

If, when making dimensions next to each other, the arrows overlap the text, the overlapping arrows are replaced by a diamond.



 The second tool on the Distance Dimension flyout toolbar is the **Auto-Aligned Distance Dimension** tool. This tool constructs a series of distance dimensions between consecutive lines and then prompts for a common extension point. To construct auto-aligned distance dimensions, do the following.

1. Click the tool.
2. Click the line to measure from.
3. Drag across the line(s) to include in the aligned dimensions.
4. When you have made as many measurements as desired, indicate the extension point for the dimensions by using the drag and clicking.
5. All the dimensions will then have the same extension point.

 The third tool on the Distance Dimension flyout toolbar is the **Aligned Distance Dimension** tool. Use this tool to construct consecutive dimensions whose extend positions are collinear. Click the first line to measure, then the second line to measure, and so forth, and then click to set the extension point for all the dimensions.

 The fourth tool on the Distance Dimension flyout toolbar is the **Cumulative Distance Dimension** tool. This tool creates cumulative dimensions from a start point along a straight line, measuring the distance from the start point at each intersection. To use it, do the following:

1. Click the tool.
2. Click the point or line to start measuring from.
3. Set the angle at which to measure.
4. Use the drag to intersect all the lines and points to measure.

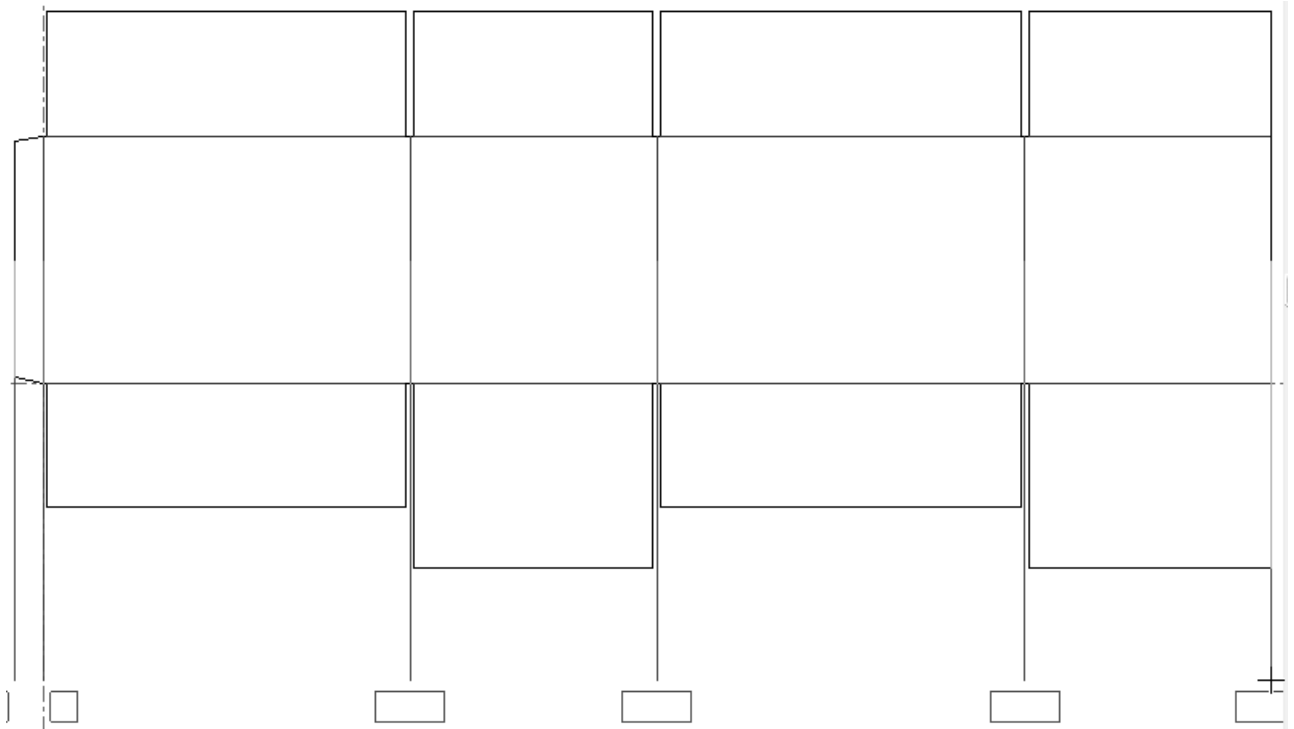

5. Click to set the number of dimensions; the dimensions are inserted. You may need to adjust their positions to aid clarity.

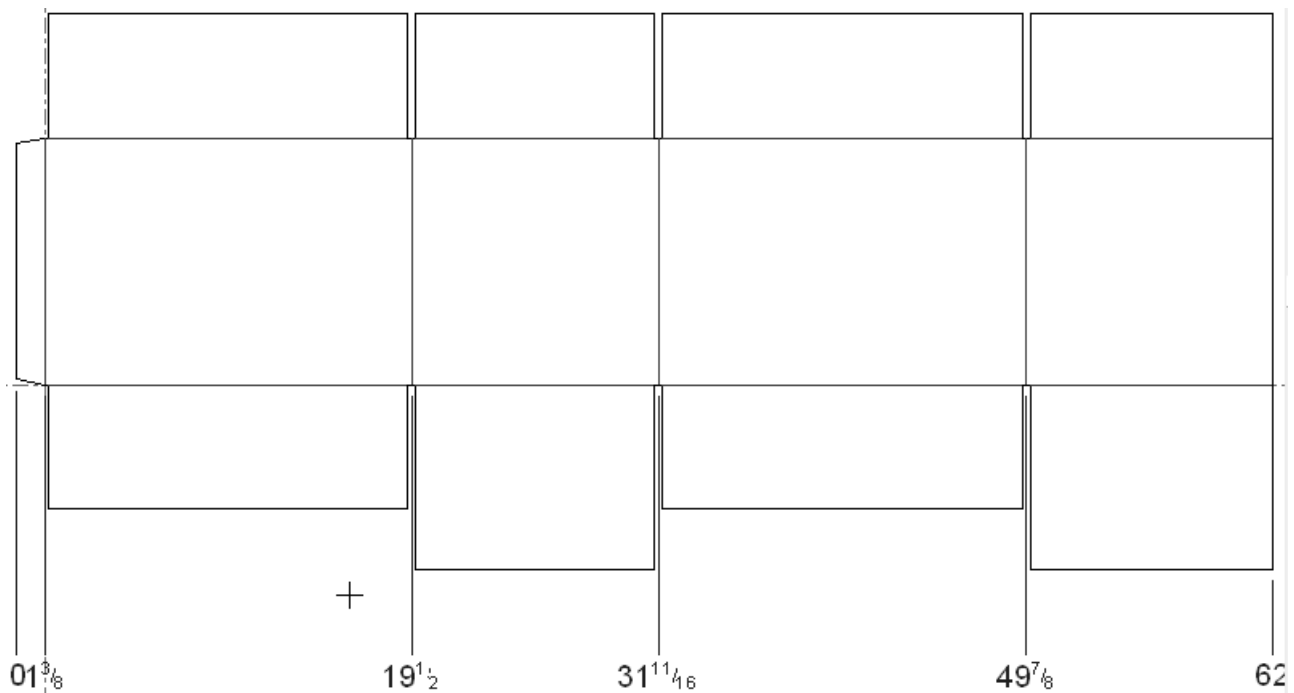

▶ The third tool on the Dimensions toolbar, and the default button on the Angle Dimension flyout toolbar, is the **Angle Dimension** tool. This tool measures the angle between two lines. Click this tool, indicate the first leg of the angle, then indicate the second leg of the angle, and

then indicate the position of the measurement. The format of the measurement depends on where you position it.

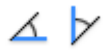

The other tools on the Angle Dimension flyout toolbar are the **Angle From Horizontal** tool and **Angle From Vertical** tool.

The **Angle From Horizontal** tool measures the angle at which a line is offset from the horizontal axis. To use this tool, click it, indicate the line to measure, indicate the point on the line to measure, and then set the position of the measurement.

The **Angle From Vertical** tool measures the angle at which a line is offset from the vertical axis. This tool works the same way as the Angle From Horizontal tool except that it measures from the vertical axis.



The fourth button on the Dimensions toolbar, and the default button on the Radius Dimension flyout toolbar, activates the **Radius Dimension** tool. This tool measures the radii of arcs and circles. To use this tool, click it, indicate the arc or circle to measure, and then indicate the location of the measurement.



The second tool on the Radius Dimension flyout toolbar is the **Radius To Circle Dimension** tool. This tool measures the distance from an arc or circle to its center. To use this tool, click it, indicate the arc or circle to measure, and then indicate the location of the measurement.



The third tool on the Radius Dimension flyout toolbar is the **Diameter Dimension** tool. This tool measures the diameter of a circle or arc. To use it, click it, then click the circle or arc to measure, and then click the extension point for the measurement.



The fourth tool on the Radius Dimension flyout toolbar is the **Diameter to Circle Dimension** tool. This tool measures the diameter of a circle or arc through the center so that the arrows on the extension lines are on the circumference of the arc or circle. To use this tool, click it, then click the circle or arc to measure, and then click the extension point for the measurement.



The fifth button on the Dimensions toolbar activates the **Change Dimension Alignment** tool. This tool lets you align dimensions with each other. This tool is available only when one or more dimensions are selected. To use this tool, select the dimensions to align, click the tool, and indicate the new alignment point. A drag image of the selected dimensions will appear to guide you in selecting the new alignment point.

You can align parallel dimensions by selecting them with the **Select** tool. When you use the drag to move them, they will all change to have the same extension point. You cannot use freehand drag to align non-parallel dimensions. When freehand dragging a single dimension, press the SHIFT key to keep the text position in line with its original position.

You can align the selected dimensions with an existing dimension by clicking the existing dimension to snap to.

A snap circle will appear around the dimension text used to align the dimensions.

Shown below are dimensions before they are aligned and after they are aligned.

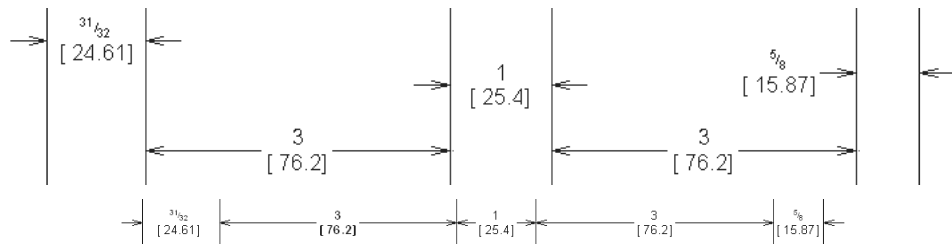

 The sixth button on the Dimensions toolbar activates the **Change Text Position** tool. This tool lets you move the position of text in a dimension. To use it, select the dimension whose text position you want to change, click the tool, and indicate the new text position. If you try to use this tool with more than one dimension selected, all the text will be moved together and the results will not be what you had anticipated.

 The seventh button on the Dimensions toolbar activates the **Change Extension Line Length** tool. Use this tool to move the end of the selected extension lines for a dimension, or for a series of parallel dimensions.

Shown below is a series of parallel dimensions whose extension lines all come close to touching the panels of the box.

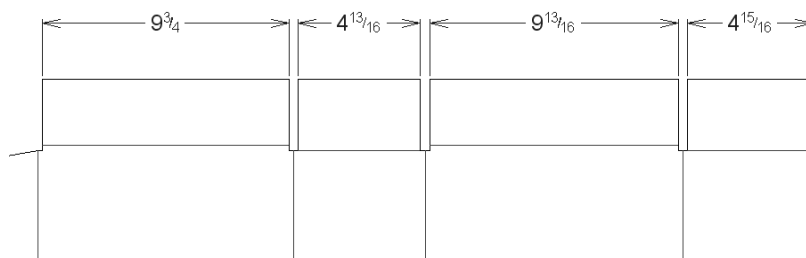

To move them away from the panels, do the following.

1. Select the dimensions with the **Select** tool, holding down **SHIFT** to select more than one item at once.
2.  Click the **Change Extension Line Length** tool. Drag will appear, enabling you to change the length of the extension lines.

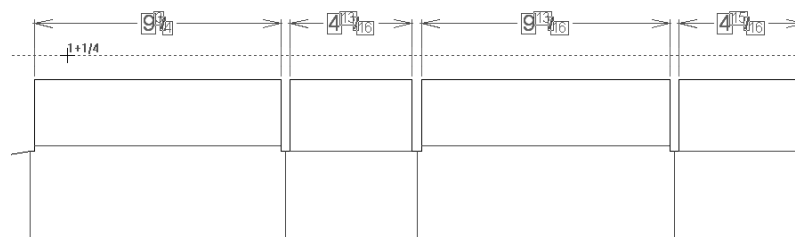

3. Release the mouse button and the lines' length will be changed to meet the point where you set the drag.

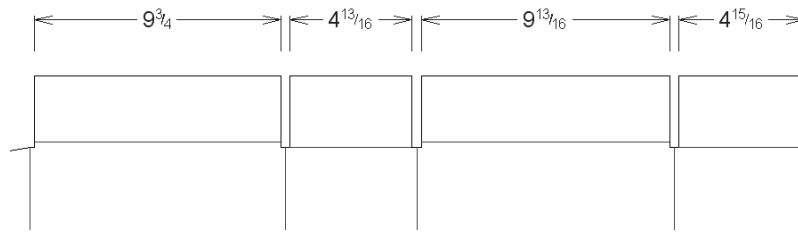

To reset extension lines to their default positions, drag the extend point back toward the design, or set the **Extension length:** field in the Properties dialog box to a large value. The extension lines will stop short of intersecting any design lines.

 The eighth button on the Dimensions toolbar, and the default button on the Automatic Dimensions flyout toolbar, is the **Auto Dimension** tool. As the name implies, this tool creates automatic dimensions. It finds the longest horizontal and vertical lines and uses those to define the main panels. Dimensions for the main panels are aligned with the extension point you specify. Other dimensions are then added for the rest of the geometry, avoiding dimensioning identical flaps. The tool avoids making overlapping dimensions as much as possible, but in some cases dimensions may require manual adjustment.

Note: If the dimension property default for text position is set so the number is at the end of the line, the Automatic Dimensioning tools will put the numbers in the middle of the lines instead.

To use this tool, do the following:

1. Construct the desired geometry.
2.  Click **Auto Dimension**. If you are not in a dimension layer, ArtiosCAD prompts you to create one or stay in the current layer.
3. Indicate the extension point to use for aligning the dimensions.
4. The dimensions are drawn. To produce the example below, the extension point is above and to the right of the design.

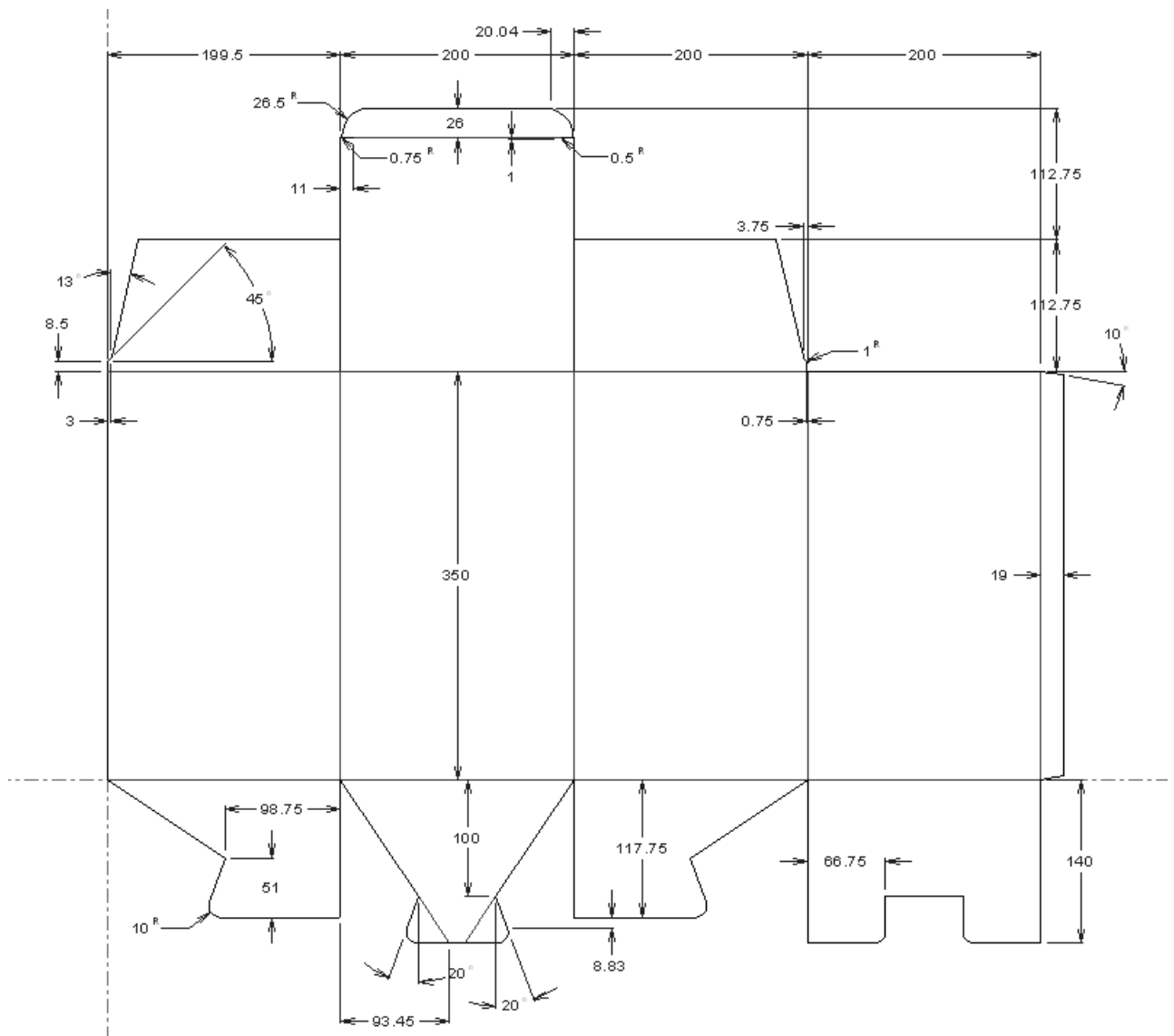

 The second tool on the Automatic Dimensions flyout toolbar is the **Auto Dimension Window** tool. It works similarly as the Auto Dimension tool, but only on the portion of a design you indicate.

To use this tool, do the following:

1. Construct the desired geometry.
2.  Click **Auto Dimension Window**. If you are not in a dimension layer, ArtiosCAD prompts you to create one or stay in the current layer.
3. Click and drag to indicate the portion of the design to auto dimension.

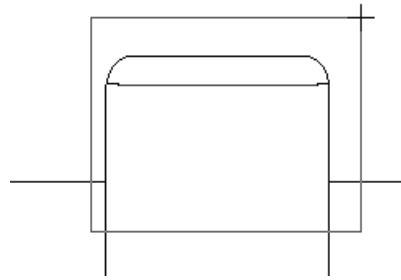

4. Dimensions are created for every point in the window and every line crossing the window boundary.

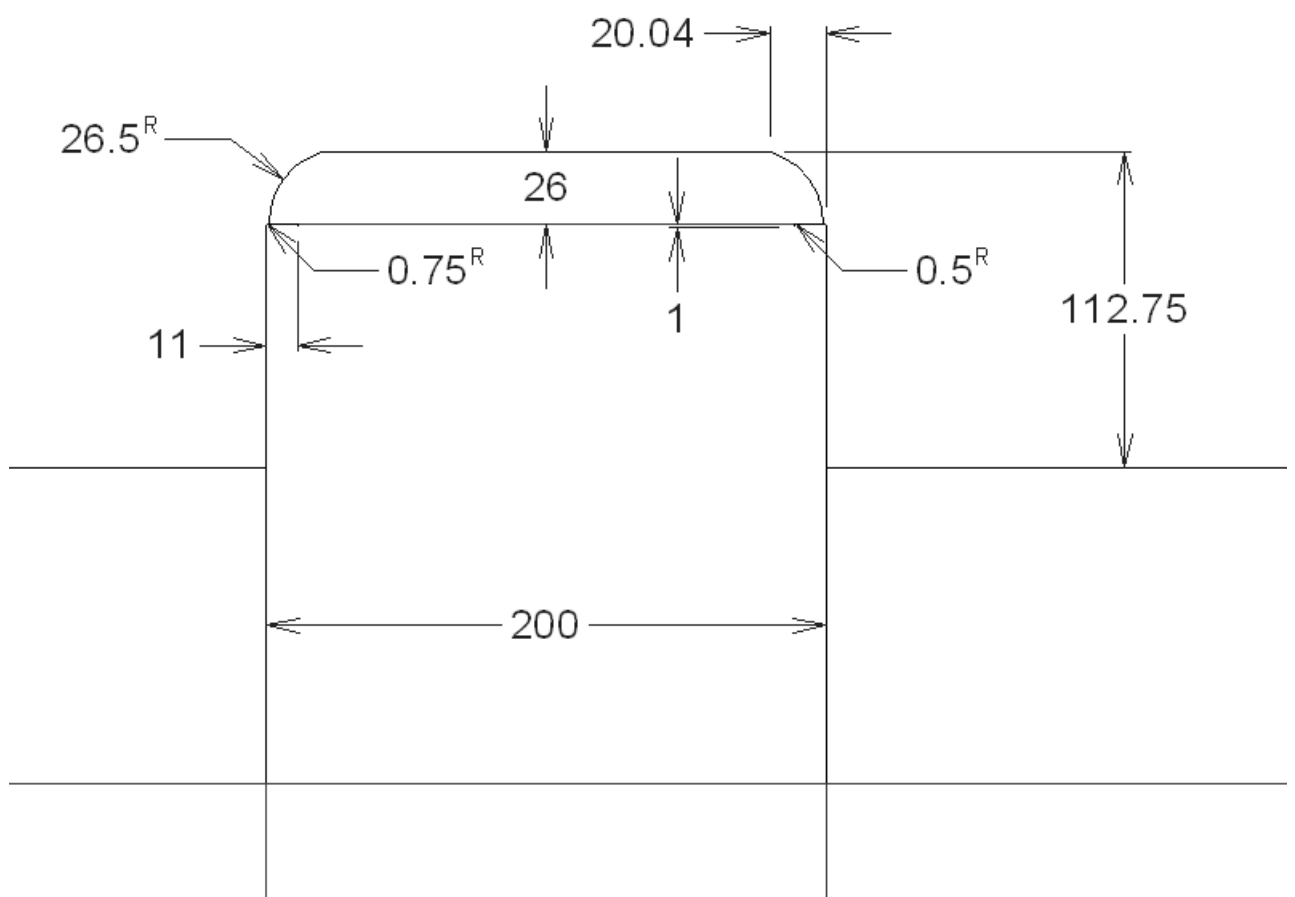

Notes and warnings about automatic dimensioning tools

Diagonal lines at a whole number of degrees are dimensioned with an angle and a horizontal or vertical dimension, whichever is longer.

Blends are dimensioned from their corners, not from the ends of the arcs.

The automatic dimensioning tools measure all structural lines except for zero-length lines. Avoid using them with Auto-Trace or digitized shapes with many short lines.

The automatic dimensioning tools are unavailable in Manufacturing.

Dimension properties

You can change the properties of dimensions, as with other ArtiosCAD entities, by double-clicking them.

In addition to being able to change the standard text attributes (text size, color, bold, and italic), you can also set these attributes:

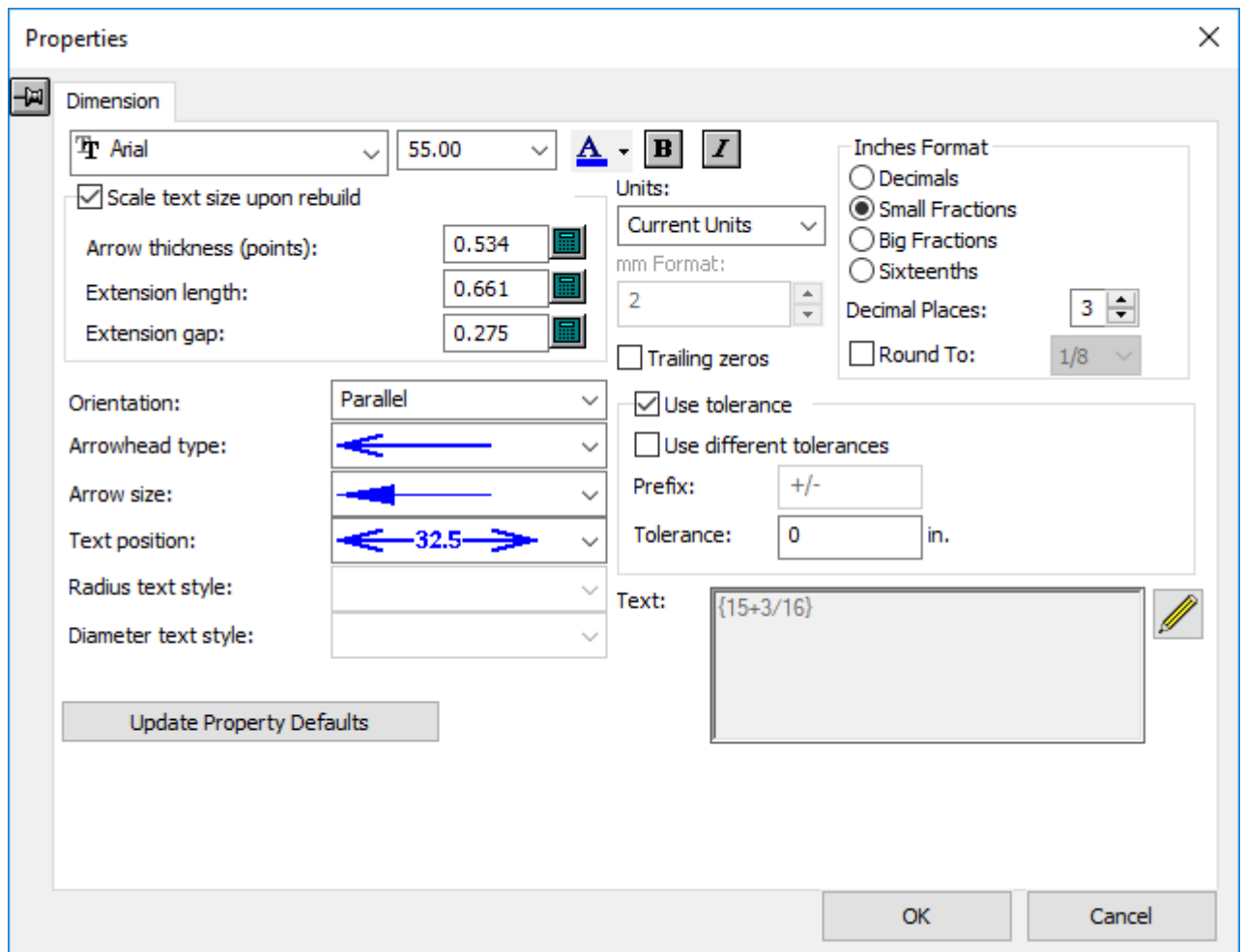

- The kind of units displayed (imperial, metric, or a combination) and the format in which they are displayed.

If you show Imperial dimensions in sixteenths, you can choose between ` and : as the separator character in **Options > Defaults > Shared defaults > Startup defaults > Units and formatting > Sixteenths format character**.

- The value by which to round the dimension.
- The number of decimal places.
- The inclusion of trailing zeros.
- The orientation of the text relative to the extension lines.
- The type of the arrowhead and size of the arrow.
- The format for the radius and diameter text styles (if a radius or diameter dimension is selected).
- The length of the extension lines (if a dimension with extension lines is selected).
- The length of the gap between the extension lines and the design edge. If the extension line ends at an angle or close to an arc, ArtiosCAD measures the gap from the nearest perpendicular line.
- The position of the dimension text between the extension lines.
- Whether or not to add a tolerance to the text of the dimension, as controlled by **Use tolerance**. Enter the desired tolerance in the Tolerance field. Select **Use different tolerances** to specify two tolerances. You can also change the separator between them if desired.

Tolerances are available for regular distance dimensions. They are not available for angle dimensions, dimensions in 3D, or dimensions using format overrides.

- The text actually shown as the dimension in the **Text:** field. To create a dimension including the distance that changes automatically as the design is rebuilt, enter **{V} desired text**, such as {V} typ. 4 places. If tolerances are enabled, they are included with {V}.

Update Property Defaults sets all dimensions created after this one in the current ArtiosCAD session to use the values you specify in this dialog box before clicking it. **Extension Length** is included in this setting only if you changed the entry in the field manually.

When the **Scale text size upon rebuild** checkbox is checked, the dimensions you selected when you opened the Properties dialog box will change size relative to the overall size of the design when it is rebuilt. Their position relative to the edge of the design will also be maintained. Turn this option off to create dimensions and avoid warnings when there are no design lines in the **Main Design, Windows and Cutouts**, and **Manufacturing** layers.

The **Extension length:** field allows you to set the length of the extension lines for all selected dimensions at once. The length is measured from the dimension toward the design.

All these properties can be set for the current ArtiosCAD session by clicking **Edit > Property Defaults** and then clicking the **Dimensions** tab.

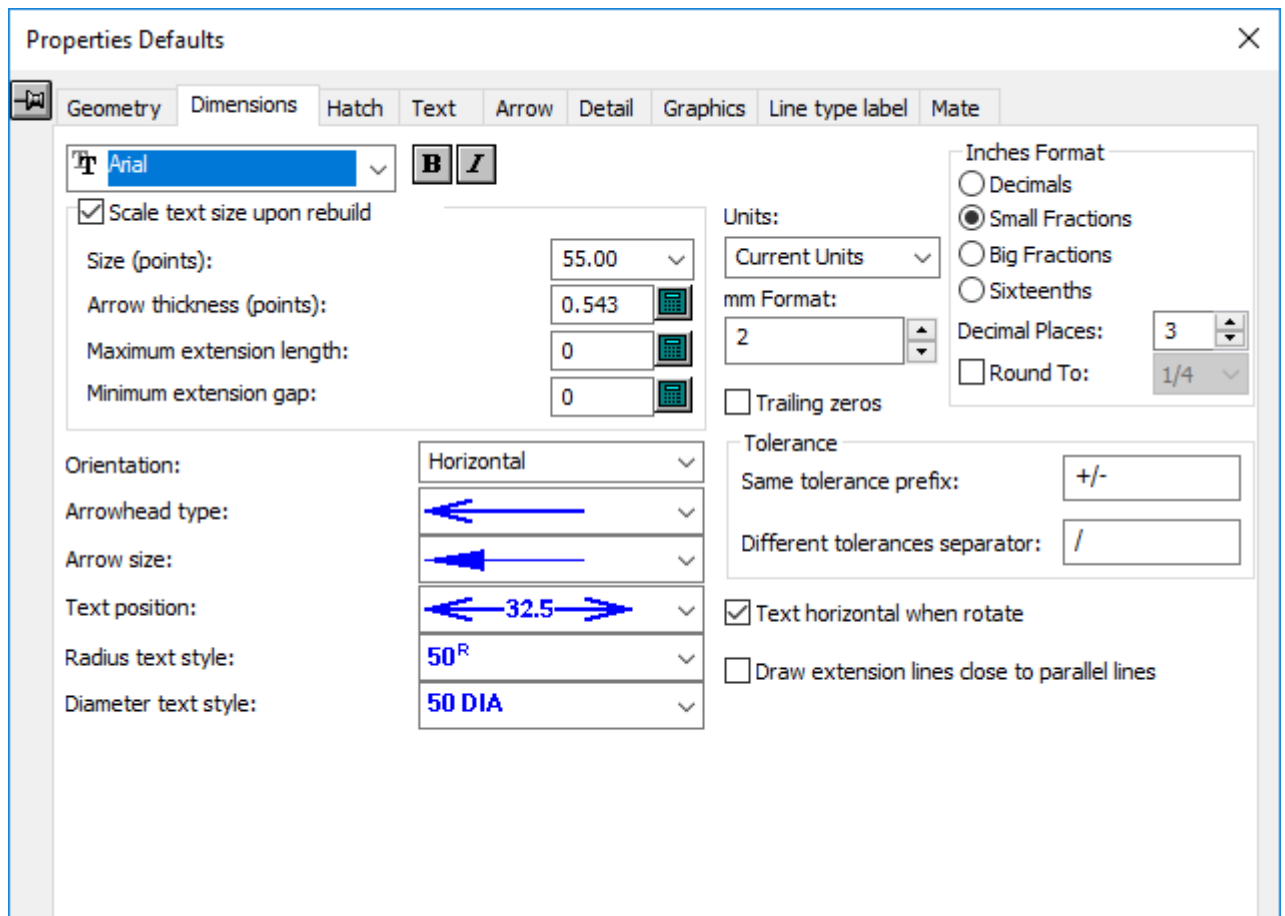

Text horizontal when rotate is an additional property for Dimensions in the Properties Defaults dialog box that is not available in the usual Properties dialog box when a dimension is selected. When enabled, this option keeps the text of the dimensions horizontal when the design is rotated using the rotate and mirror tools in Designer and Manufacturing.

This option is enabled by default. To set the default, click **Options > Defaults > Property Defaults > Dimensions** and change it there. You may also change the other defaults as desired. When in Defaults, you can set the size of the design on which dimension size is calculated in the **Scale text size upon rebuild** group; the default design size used for this calculation is 40 inches or 1000 mm.

Note: Dimensions created by the **Copy Times** and **Copy Times Rotate** tools are not affected by this option.

Draw extension lines close to parallel lines helps keep dimensions tidy.

Note: If you change the color of a dimension from the default, it is considered graphics when changing the View Mode.

Rounded dimensions

Use the **Round to** checkbox in the **Inches format:** group with caution. It will cause the selected dimension to round up or round down as appropriate and not match its actual value.

If there are rounded dimensions in the design, or the dimensions are rounded by a dimension format override, and there are smaller dimensions that add up to larger dimensions, the values of the larger dimensions will be adjusted to match the sum of the rounded values of the smaller dimensions.

The default for rounding is in **Defaults > Shared Defaults > Startup defaults > Dimension Format Override**.

If you use overall dimensions, they may not match the sum of individual rounded dimensions. You can ensure that they match for the current design by checking the **Consistent overall rounded dimensions** checkbox in **Options Dimension Formatting**. This can also be set in Defaults in **Defaults > Shared Defaults > Startup defaults > Dimension Format Override**. It affects horizontal and vertical dimensions only; it does not affect diagonal dimensions.

If you set **Consistent overall rounded dimensions**, it affects all aspects of ArtiosCAD, not just the viewing of dimensions in Builder, Designer, and Manufacturing. It affects dimensions in outputs (regardless if it uses a Report), blank size on Reports, and the Blank Size dialog box on the Info menu.

If you want to use rounded dimensions with a report made in a pre-5.x version of ArtiosCAD, and have blank sizes defined on the report, delete and re-add the blank size variables from the Calculated Expressions Catalog.

You can check for rounded dimensions when a single design or an embedded single design is opened by checking the **Warning if design contains rounded dimensions** checkbox in **Defaults > Shared Defaults > Startup defaults > Dimension Format Override**.

When that checkbox is checked, the Rounded Dimensions Warning dialog box appears as shown below.

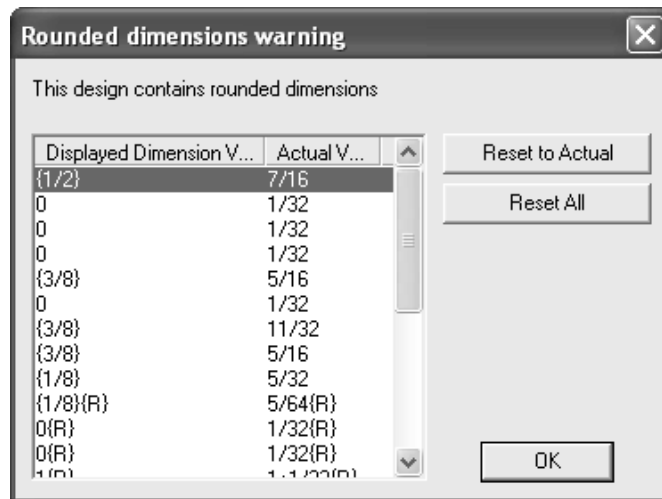

Reset to Actual un-rounds the selected dimensions. Select more than one dimension in the list by holding down ctrl and clicking the desired entries.

Reset All un-rounds them all.

Easily resetting and applying Property Defaults

The commands on the **Apply Defaults** sub-menu on the Edit menu and context menu (the menu that appears when you right-click the mouse) change the format of dimensions, text, or both dimensions and text with one click.

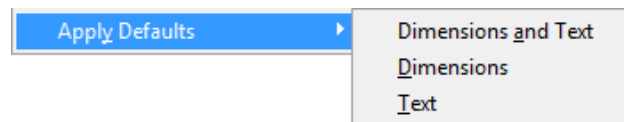

These commands change the current Property Defaults of the workspace to the Property Defaults specified in Defaults, and then apply the new Property Defaults to all the dimensions and/or text in visible, unlocked layers of the workspace depending on the menu item you clicked. Elements in turned-off layers and/or locked layers are not changed by this command.

To use these tools, do the following:

1. Click **Edit > Apply Defaults** or right-click and click **Apply Defaults** (as shown below).

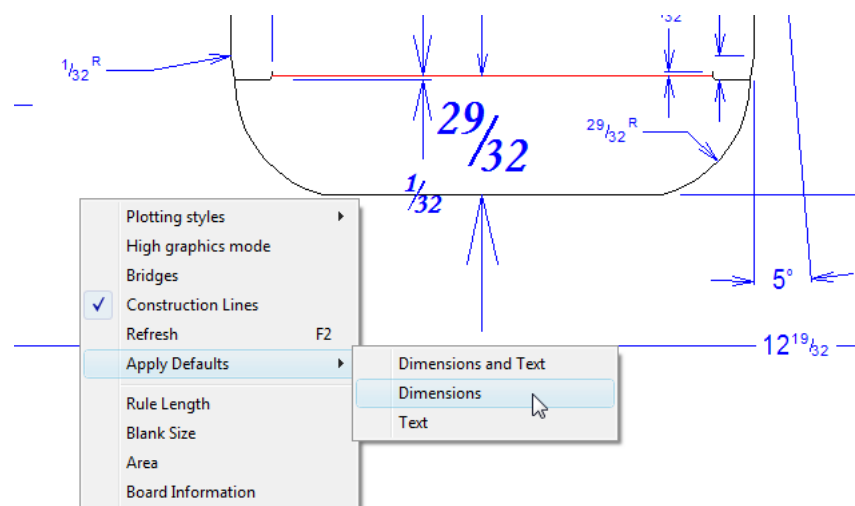

2. Click the desired option for those elements to change: **Dimensions and Text**, **Dimensions**, or **Text**.
3. ArtiosCAD may prompt you to confirm the change. Click **Yes** to confirm.
4. ArtiosCAD applies the settings in Defaults to the current Property Defaults and changes the appropriate workspace elements to match those settings.

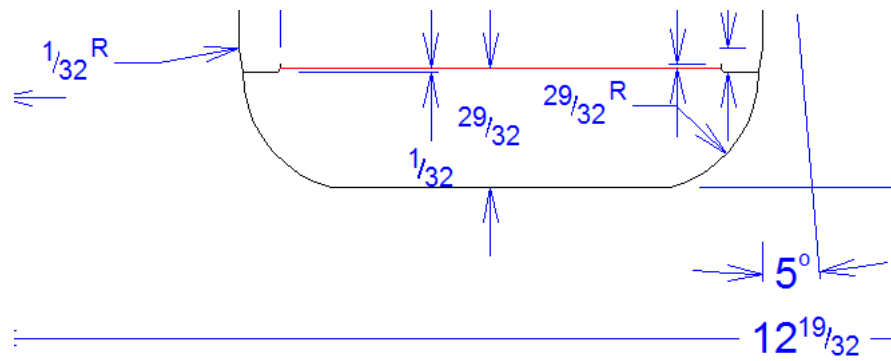

Note:

If you Undo any of these commands, only the workspace elements are changed back to their prior formatting. The Property Defaults of the workspace remain at their current settings.

Palletization in Builder

If you use Cape Pack or TOPS palletization software, you can export data from them and have ArtiosCAD create a package from that data.

You can also create secondary packaging in them from 3D and view pallet loads in 3D from them. See the *3D* chapter for more information.

For answers to some frequently asked questions about palletization, see *Palletization FAQ* in the *Outputs* chapter.

Note:

Before using these features for the first time, make sure you have mapped Cape Pack or TOPS styles and materials to ArtiosCAD standards and boards as described in the *Builder* chapter. You may also want to set Cape Pack or TOPS defaults as described in the *Defaults* chapter.

The workflow for palletization in ArtiosCAD is the same regardless of which palletization application you are using.

Mapping styles

To map the styles between Cape Pack/TOPS and ArtiosCAD, do the following:

1. Launch ArtiosCAD.
2. Click **Options > CAPE/TOPS to ArtiosCAD**.

The **Map CAPE/TOPS to ArtiosCAD** dialog box appears.

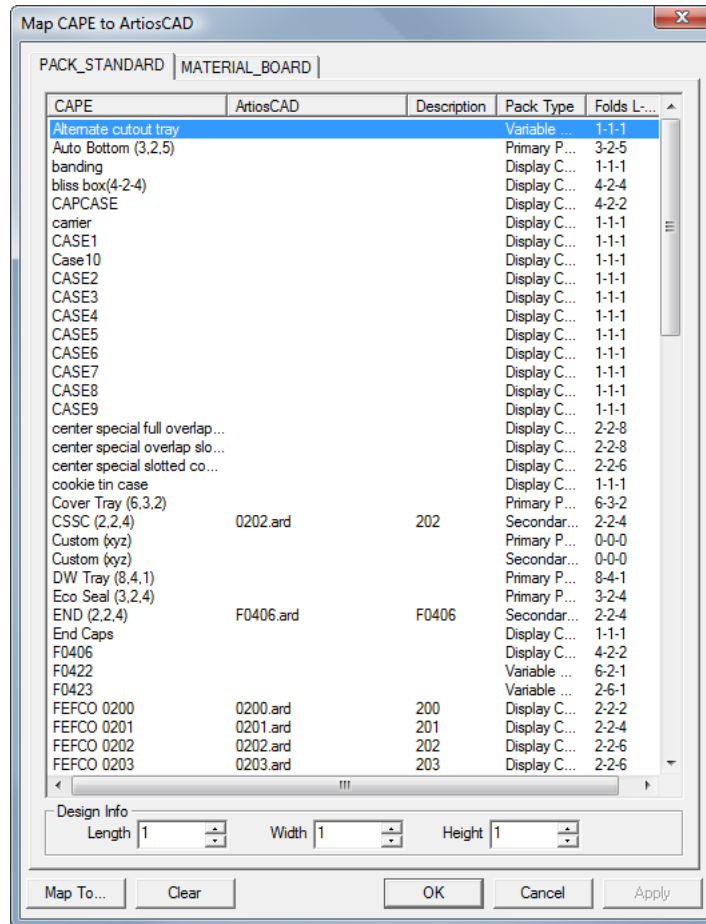

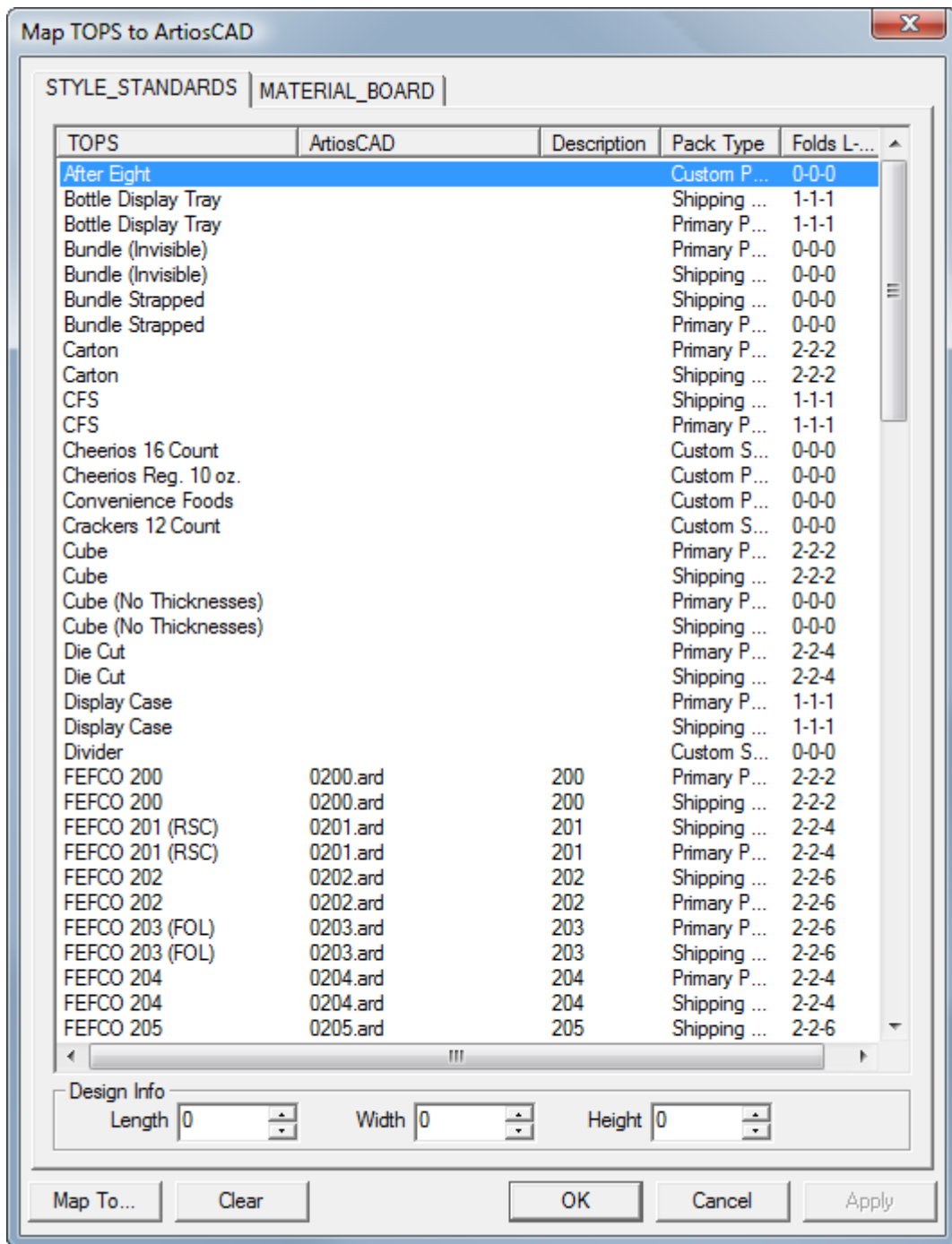

3. Double-click a style to associate with an ArtiosCAD standard.
4. In the **Select ArtiosCAD Standard to use in place of** dialog box, choose the desired ArtiosCAD standard and click **OK**. You may only select ArtiosCAD-format standards.

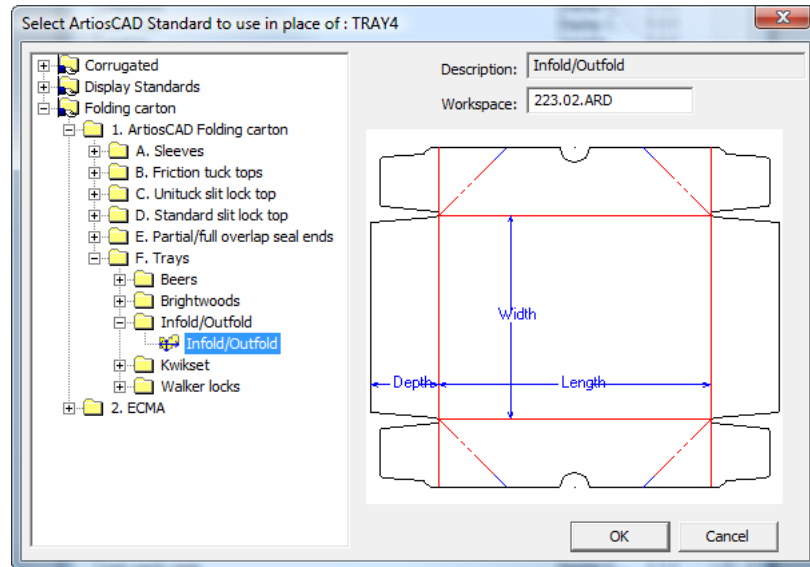

5. In the **Length**, **Width**, and **Height** fields, set the number of folds in each direction.
6. Repeat as desired by double-clicking another style to map.
7. Click **OK** when done.

Mapping boards

To map the boards between Cape Pack/TOPS and ArtiosCAD, do the following:

1. Launch ArtiosCAD.
2. Click **Options > CAPE/TOPS to ArtiosCAD**.

The **Map CAPE/TOPS to ArtiosCAD** dialog box appears.

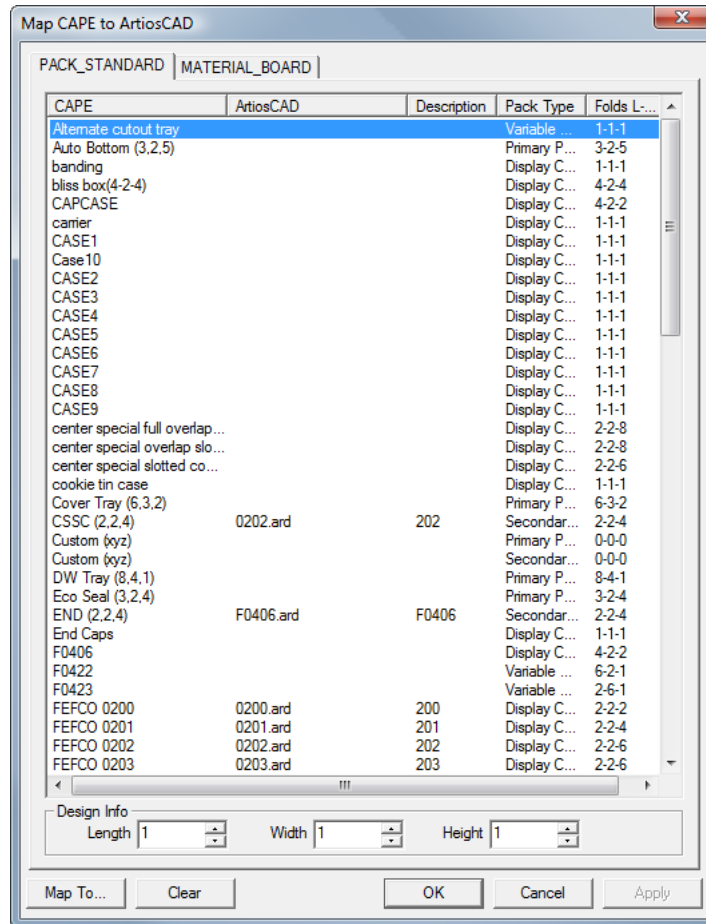

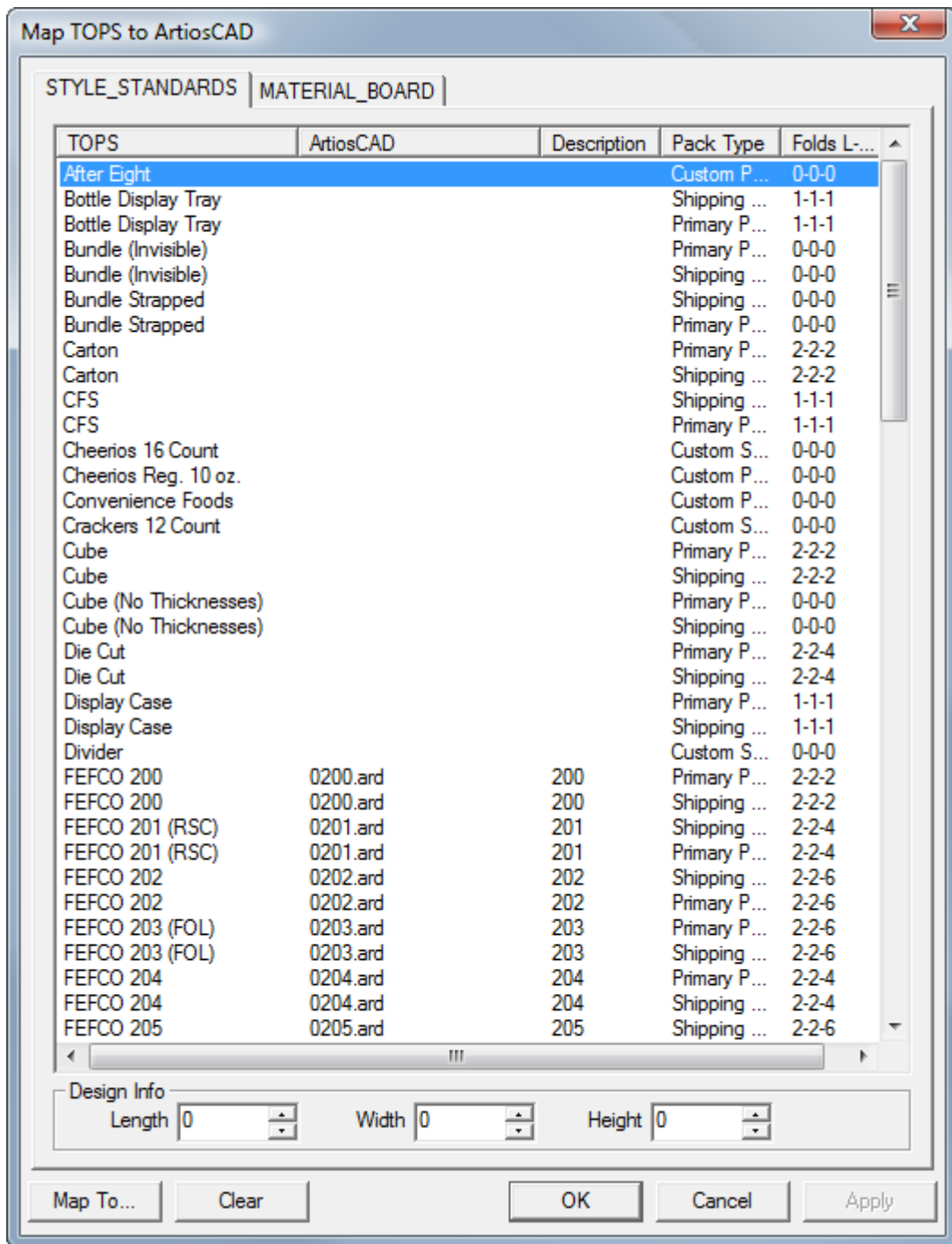

3. In the **Map CAPE/TOPS to ArtiosCAD Standard** dialog box, click the MATERIAL_BOARD tab.

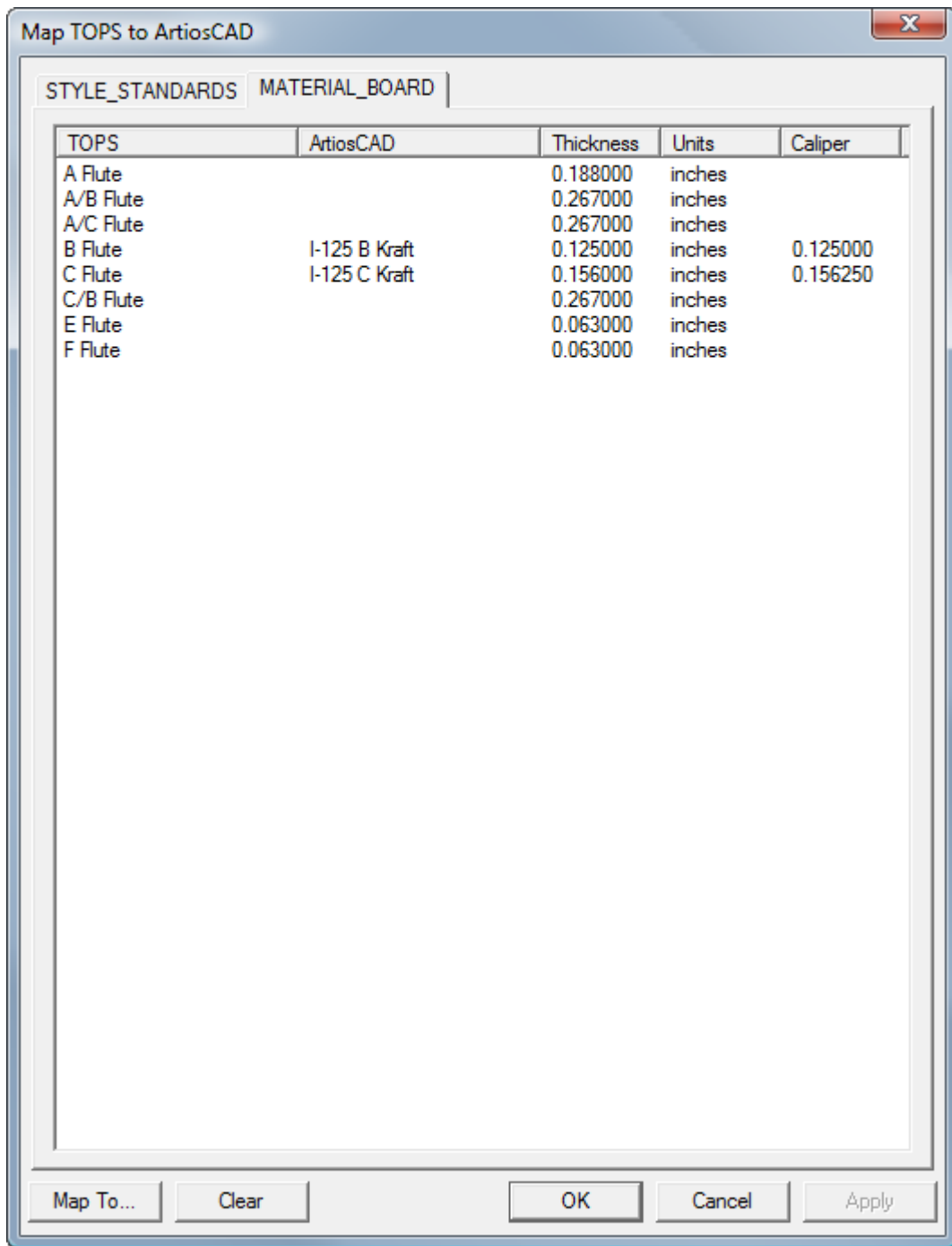

4. Double-click a Cape Pack/TOPS board.
The **Define a corresponding board for** dialog box appears.

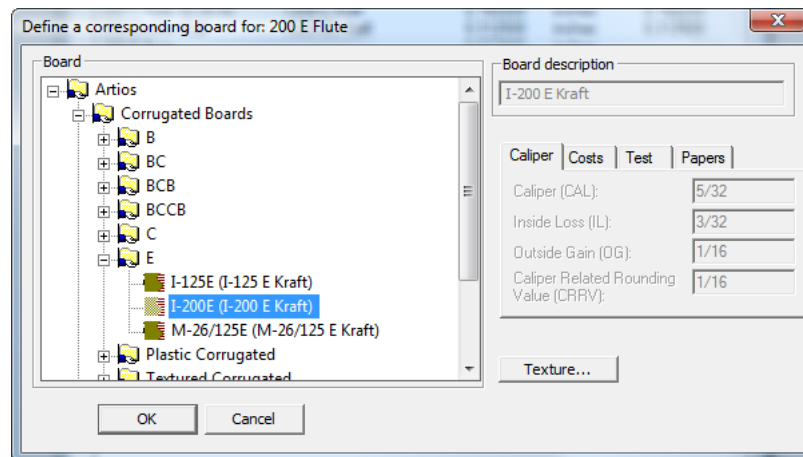

5. Open the **Artios** catalog and select the desired board. Click **OK** when you have selected the desired board. If you cannot find a corresponding definition, open DataCenter Admin and create one, close this dialog box and its parent, and resume at step 2.
6. Repeat as desired by double-clicking another board to map.
7. Click **OK** when done.

Creating a pallet group

To create a pallet group using a combination of Cape Pack/TOPS and ArtiosCAD, do the following:

1. Cape Pack/TOPS will use the last-launched version of ArtiosCAD. If your last-launched version was not 12 or later, launch it and leave it open.
2. Launch Cape Pack/TOPS.
3. In Cape Pack, in the **Pallet Group**, make your selections as desired and click **Go**.

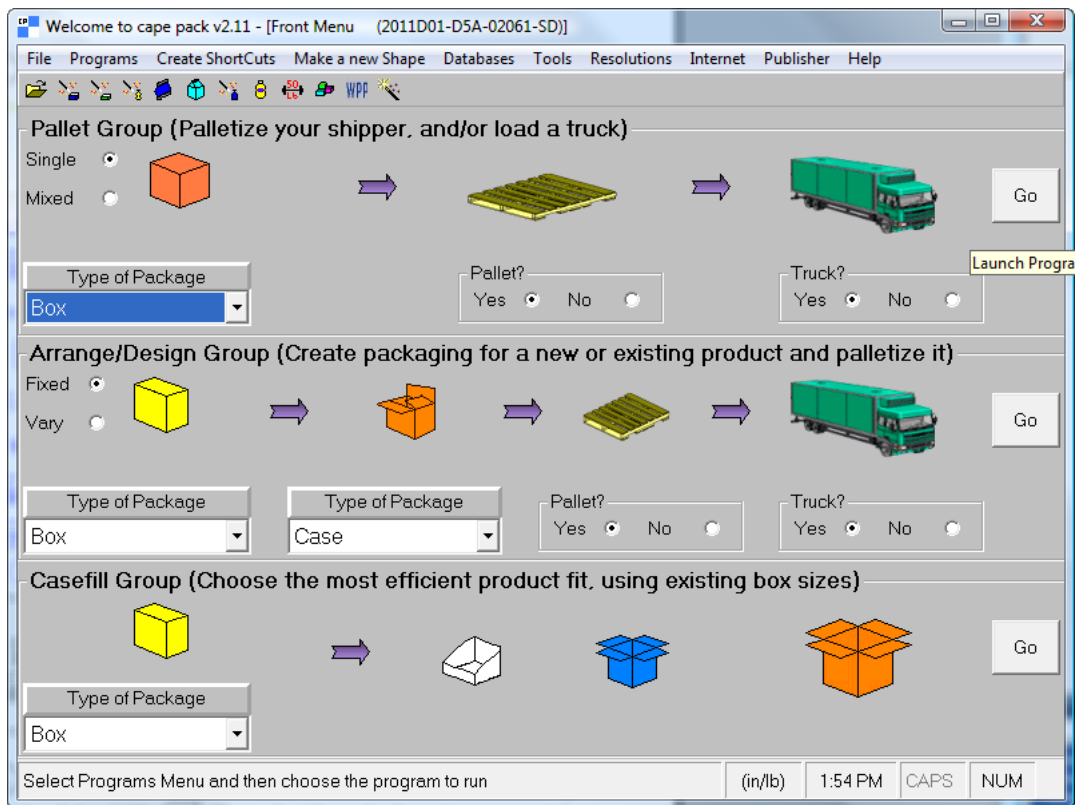

In TOPS, enter your package design sequence and click **Calc**.

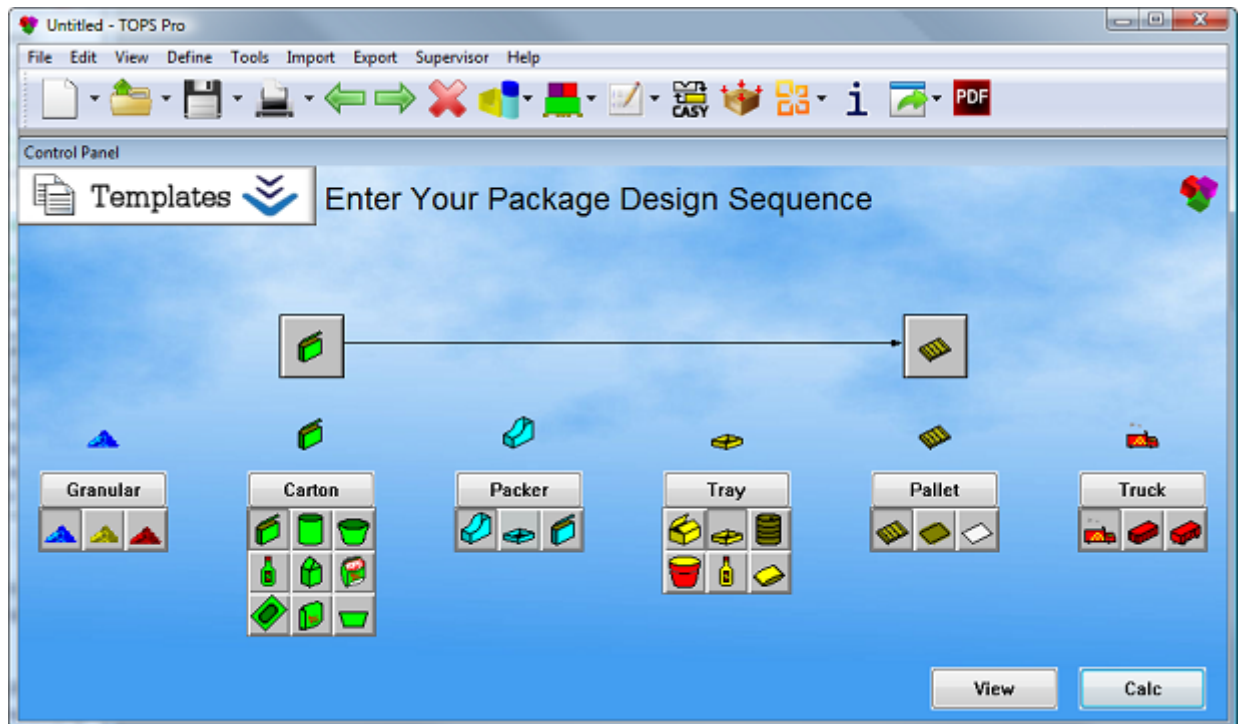

4. Choose the type of package to make and enter the appropriate values for your package.

Pallet - [Data Input]

File Programs Make a new Shape Input Databases Tools Fill Wizard Colors Add Graphics Internet Help

back

Box 48x40 Pallet 2 Pallet 3 53footer

Select Pack Type: RSC (2,2,4) Select Pack Name: Box

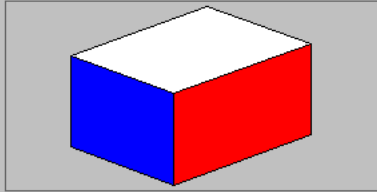

Length Width Height

Enter OD's: 16.0000 12.0000 10.0000

Set Dimensions Vertical:

Enter Pack Weight: Gross Weight: 10.0000 Net Weight: 10.0000

Input Settings Product Name/Product Code

Save/Calc.

Box (in/lb) 1:59 PM CAPS NUM

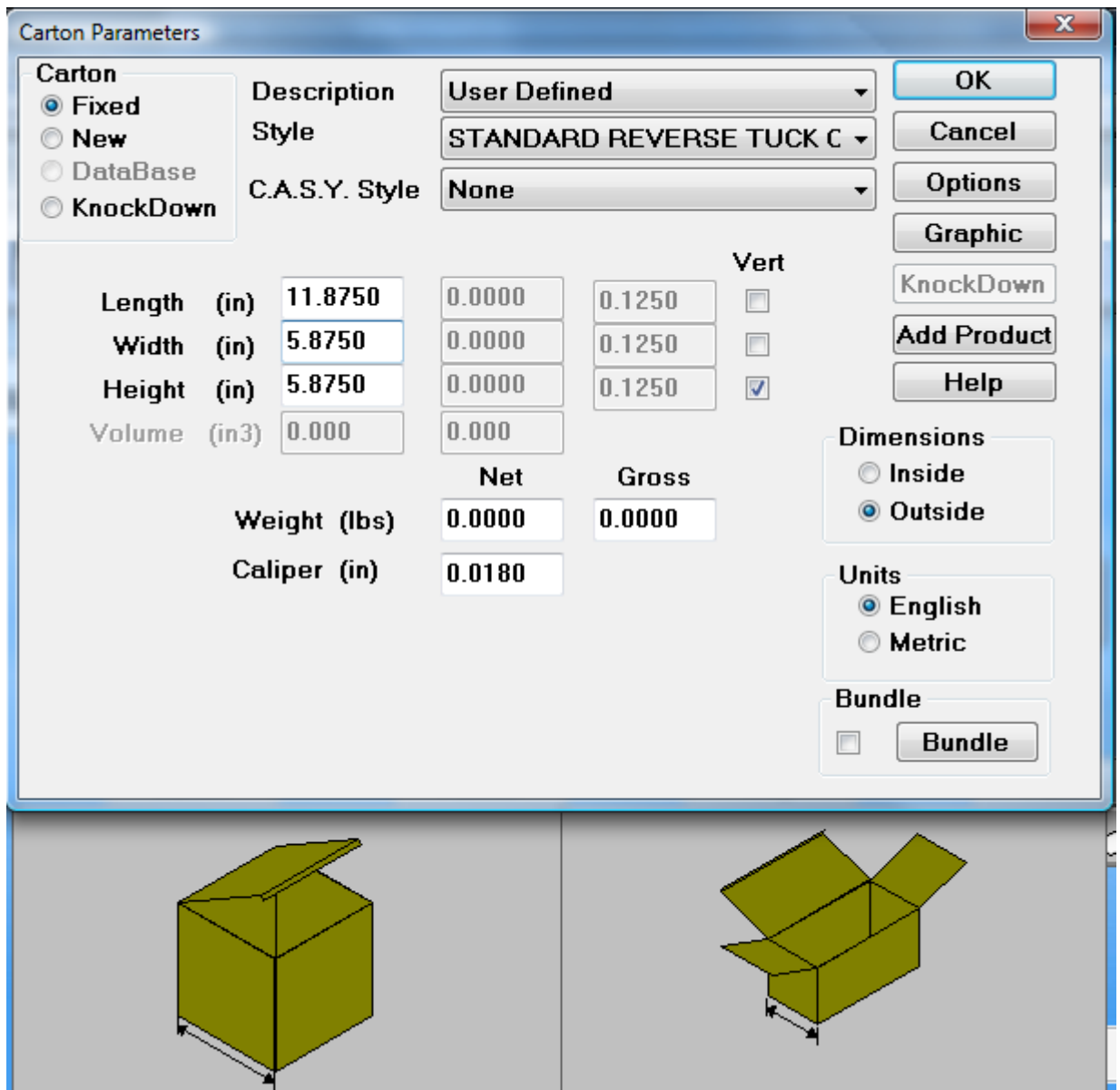

5. Cape Pack/TOPS will use its default pallet. To change it, click the next tab on the screen (in the example above, it is labelled **48x40**) and choose a new one. To not change the pallet, skip to the next step. You can also change the truck size on the last tab but ArtiosCAD does not use that information.

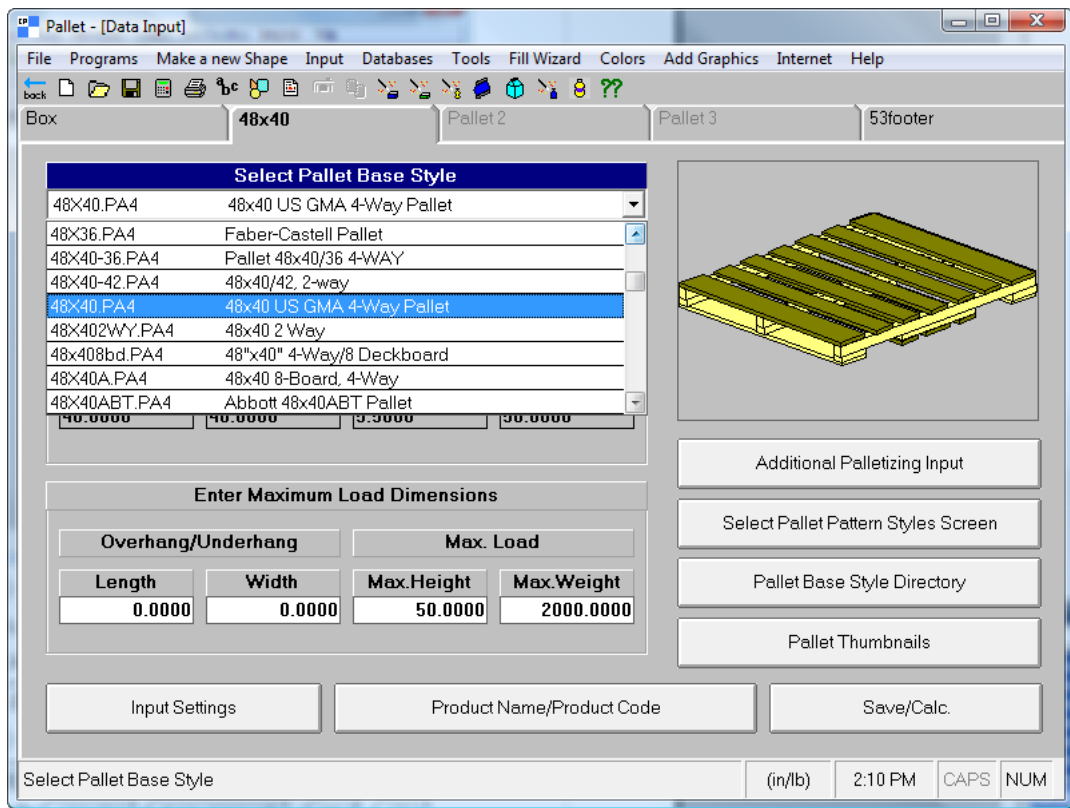

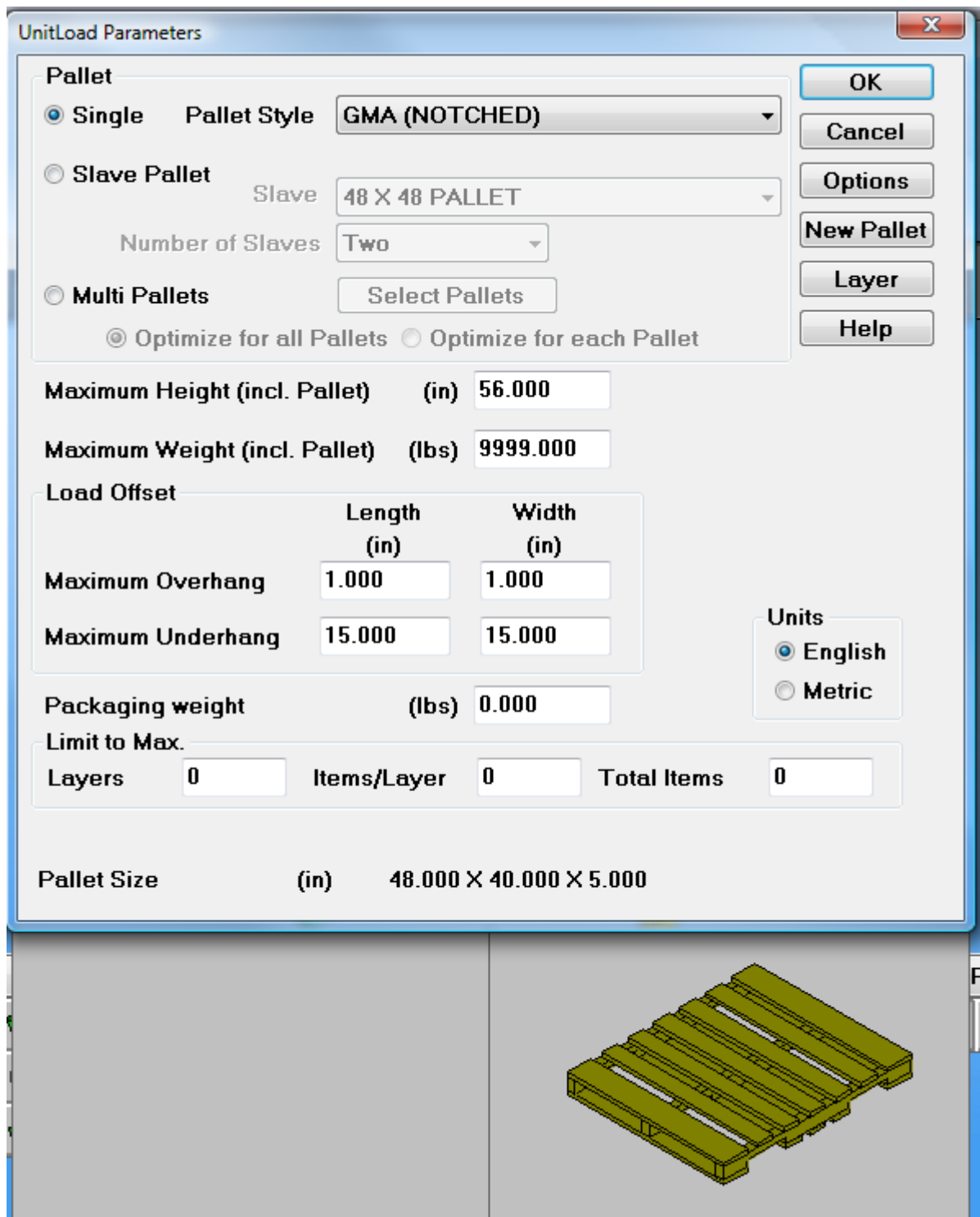

6. For Cape Pack, click **File > Calculate Only**. For TOPS, click **OK**.
Click **Yes** or **No** to any alerts as desired.
7. For Cape Pack, use the **Goto Next Solution** and **Goto Previous Solution** arrows to find the best solution.

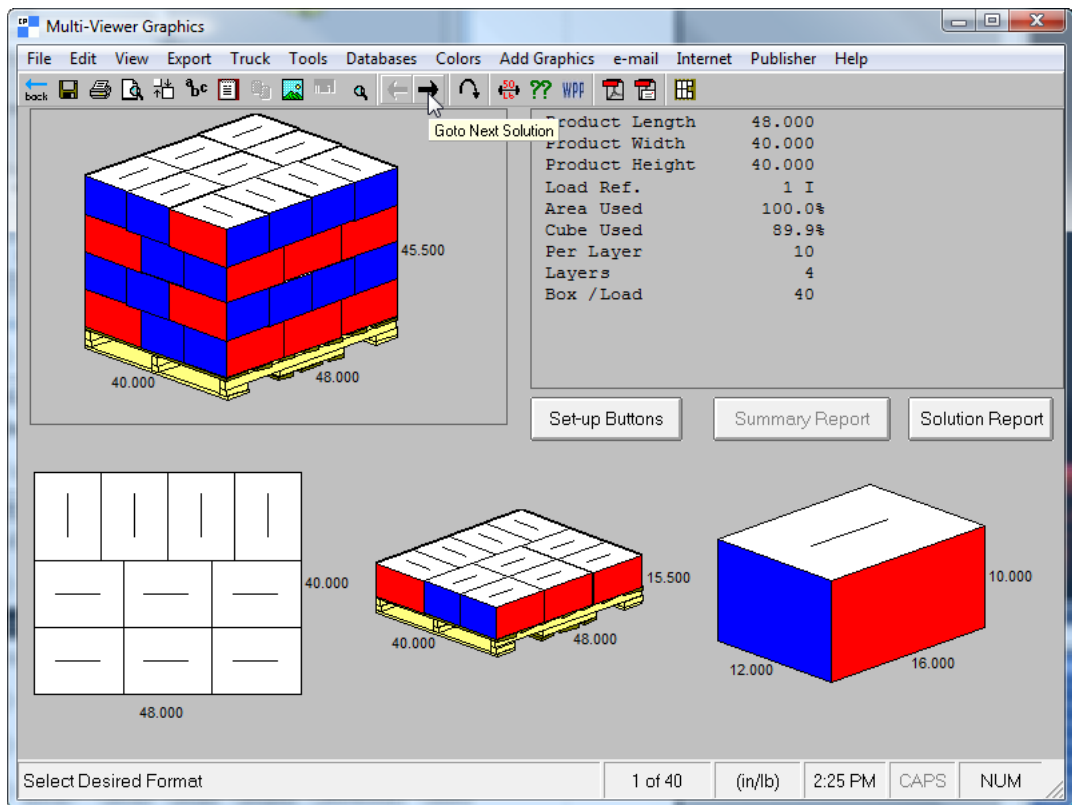

For TOPS, scroll through the list of solutions in the UnitLoad window and click a solution to view it.

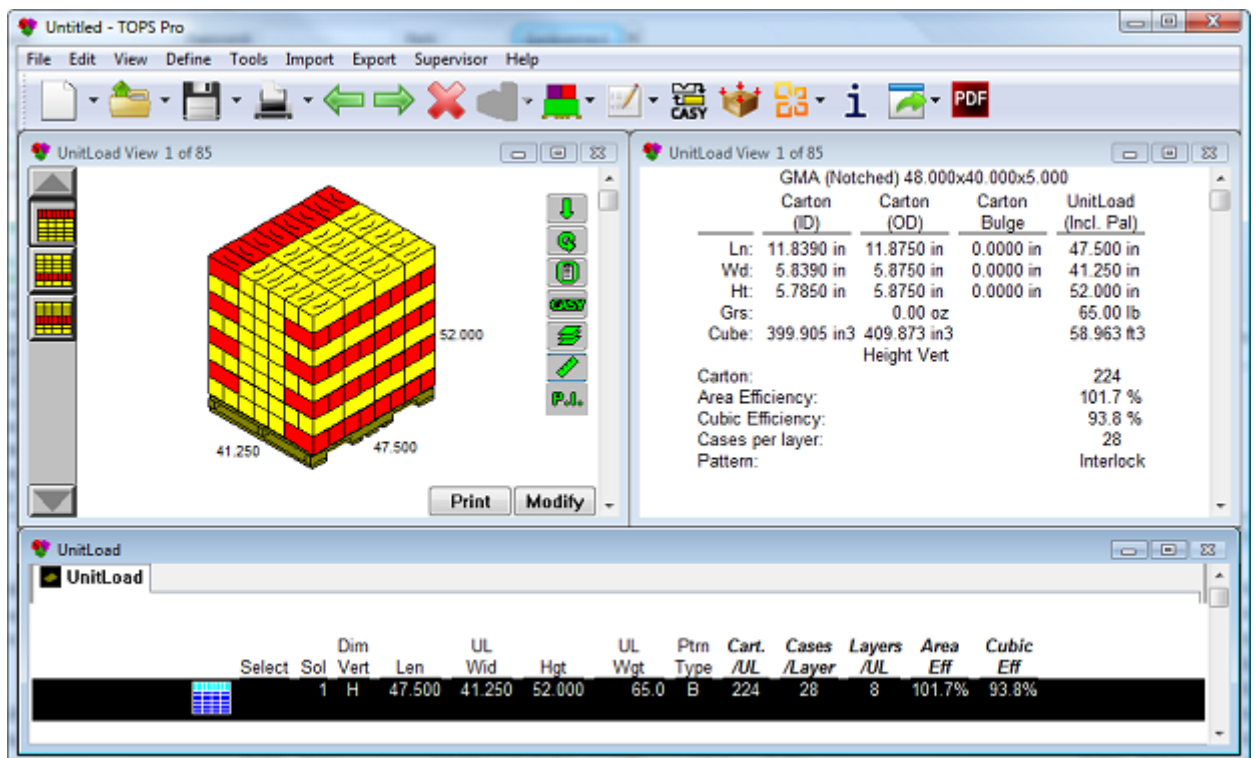

- For Cape Pack, when you have found the best solution, click **Export > Export to ESKO > Send to ArtiosCAD**.

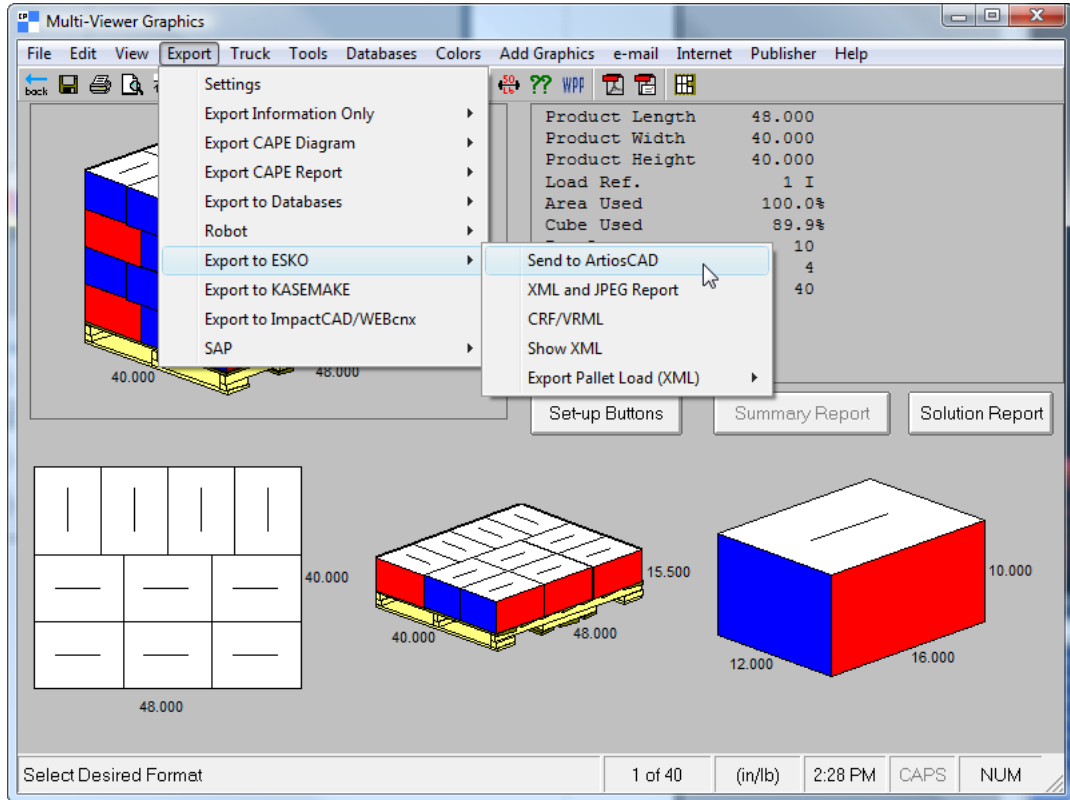

For TOPS, when you have found the best solution, click **Export > Send to ArtiosCAD**. Choose which elements to export and click **Export**, and click **Cancel** in the Analysis Save As dialog box.

If you do not have either the style or board mapped as described previously, ArtiosCAD will prompt you to choose the missing elements.

- ArtiosCAD displays the standard it constructed using the Cape Pack/TOPS data. Work with the single design as you would any other workspace.

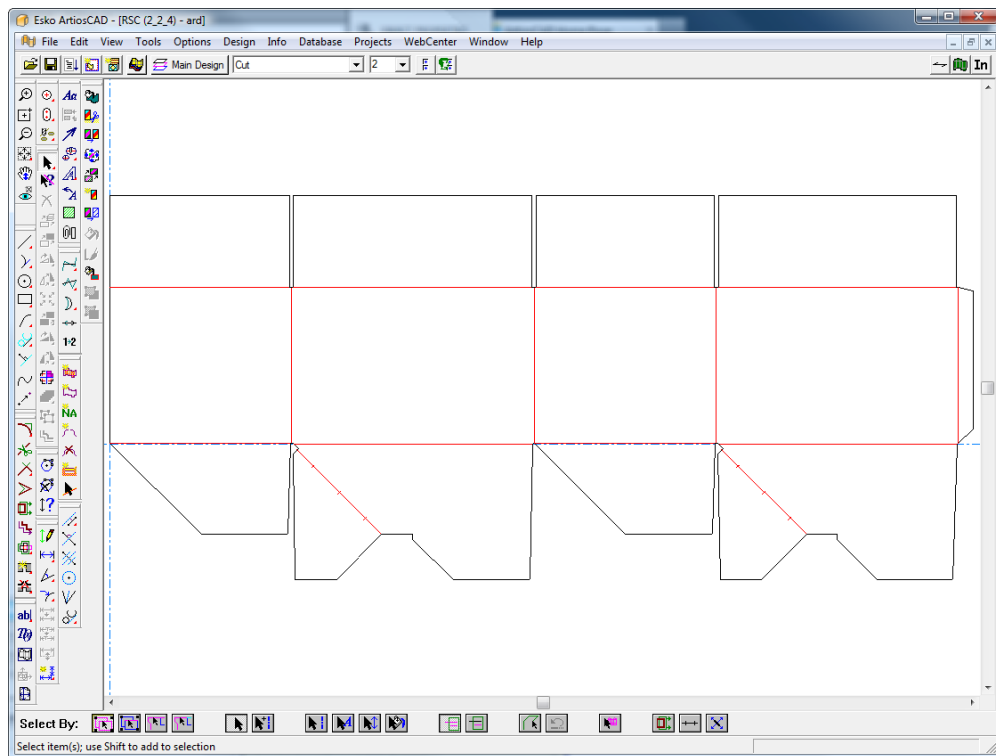

Arranging/Designing a group

The Arranging/Designing a Group workflow between Cape Pack/TOPS and ArtiosCAD is similar to that of creating a shipper for use on a pallet, but at the end there are two designs in ArtiosCAD.

If you are using Cape Pack, follow the instructions below. For TOPS, the workflow is similar in that you select more than one element to create, create them, and then use the **Send to ArtiosCAD** command on the **Export** menu.

1. Cape Pack will use the last-launched version of ArtiosCAD. If your last-launched version was not 12 or later, launch it and leave it open.
2. Launch Cape Pack.
3. In Cape Pack, in the **Arrange/Design Group**, make your selections as desired and click **Go**.

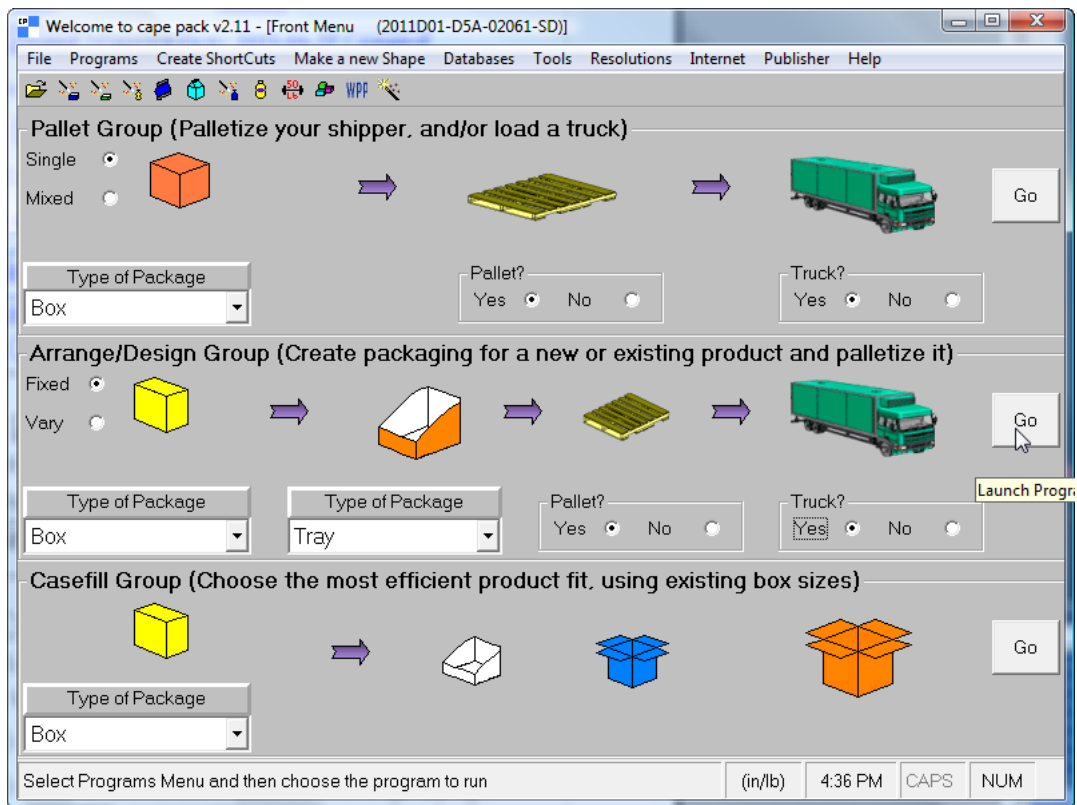

4. In the Data Input window, click the three tabs to choose the packages and pallet and enter values in the fields as appropriate.

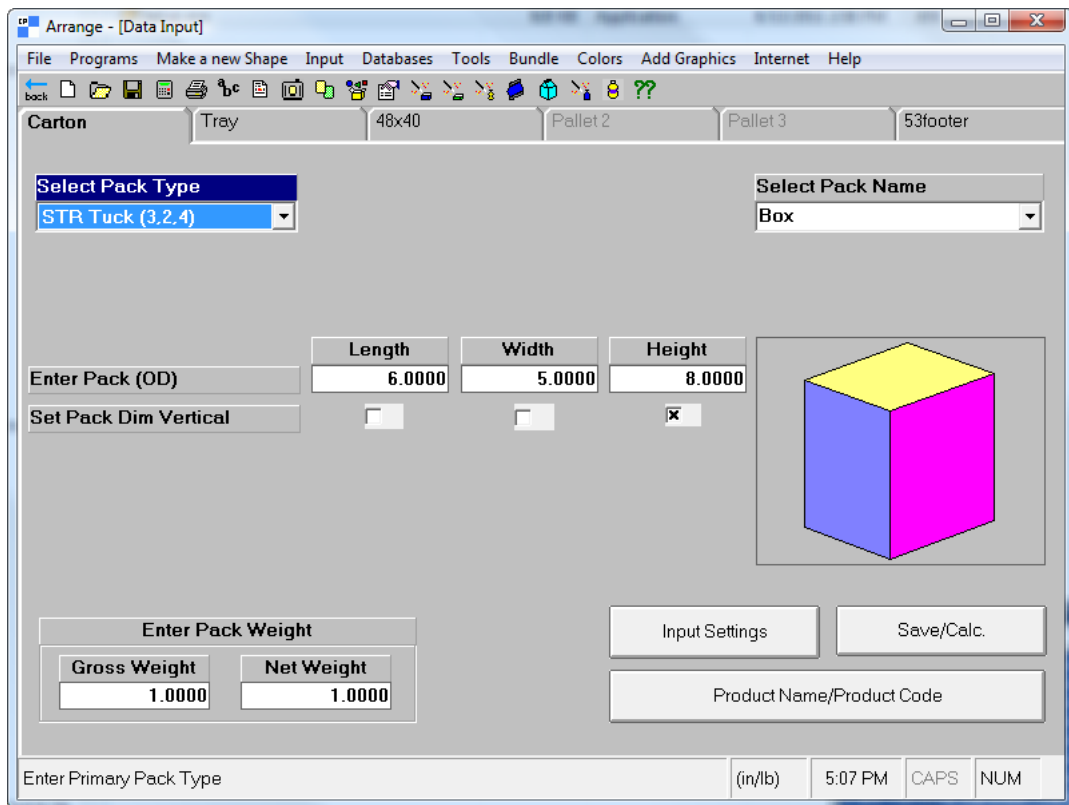

5. Click **File > Calculate Only**.
Click **Yes** or **No** to any alerts as desired.
6. Use the **Goto Next Solution**, **Goto Previous Solution**, **Goto Next Pattern**, and **Goto Previous Pattern** arrows to find the best solution.

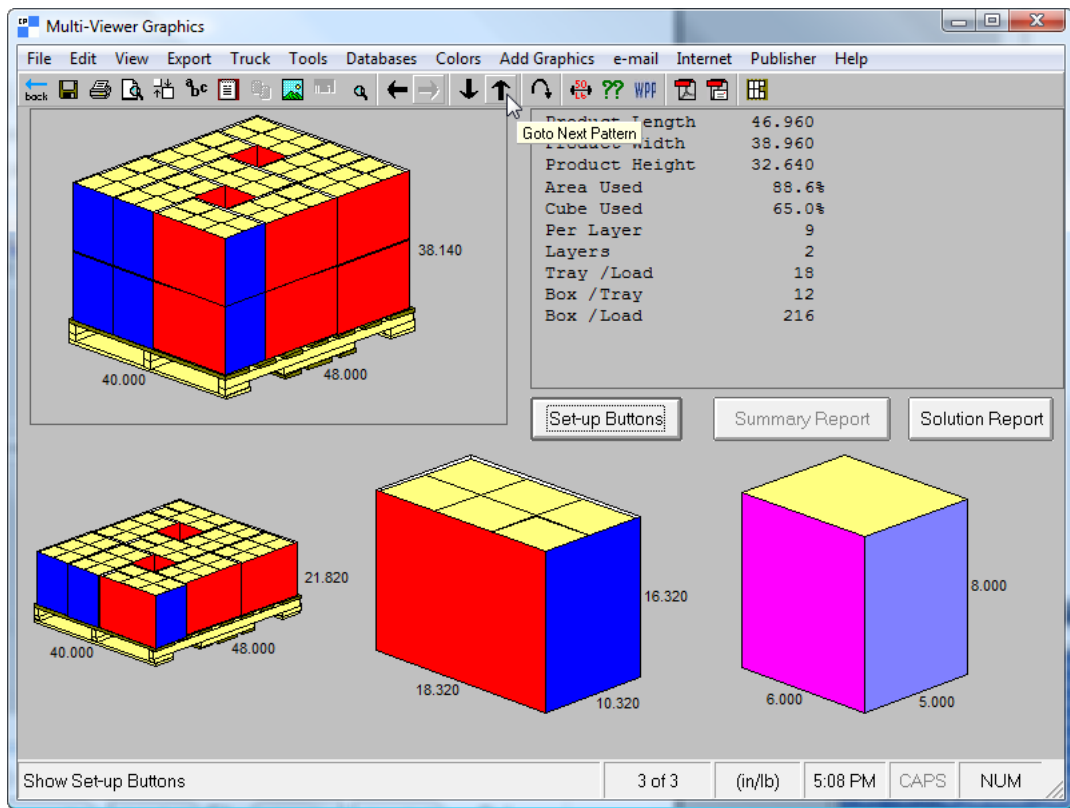

- When you have found the best solution, click **Export > Export to ESKO > Send to ArtiosCAD**.

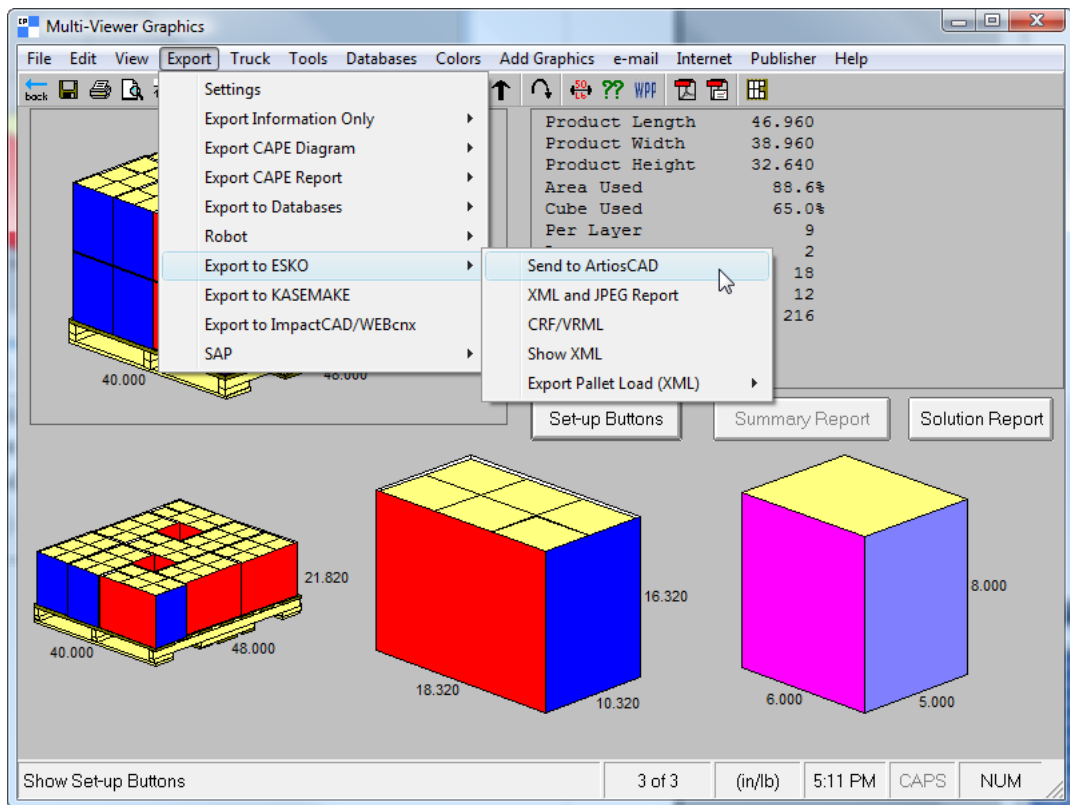

If you do not have either the styles or boards mapped as described previously, ArtiosCAD will prompt you to choose the missing elements.

8. ArtiosCAD displays the standards it constructed using the Cape Pack data in cascaded windows. Work with the single designs as you would any other workspaces.

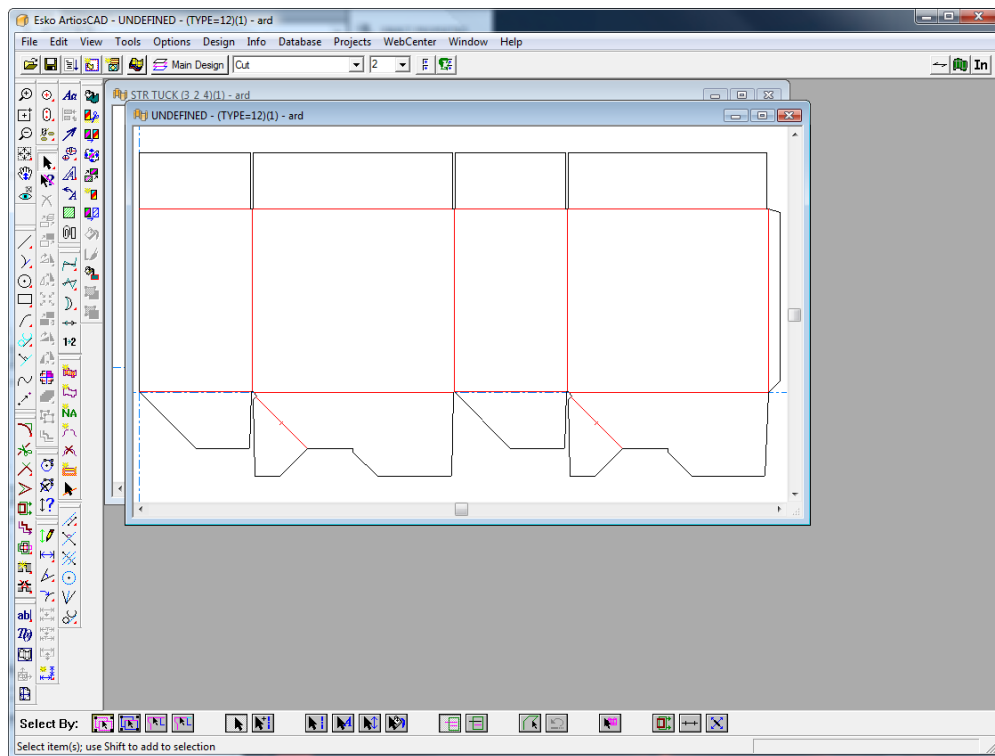

If pallet information exists in the ArtiosCAD session, a pallet appears in the 3D workspace when you convert the design to 3D.

12. Designer

Introduction to Designer

There will be times when you need to create a design from scratch instead of using an entry from a Standards Catalog. ArtiosCAD handles those situations by providing sophisticated design tools that empower you to quickly and easily turn your ideas into reality.

These tools are available on systems with the Designer option. Certain other modules provide access to some of the tools. Systems with only the Builder option cannot use these tools.

Overview of Designer

All the tools work the same way. Click the tool and satisfy the drag prompts by moving the pointer and clicking the mouse button. The geometry is created when enough prompts are satisfied.

Examples of tasks completed using Designer are:

- Creating original designs and modifying existing designs.
- Creating and deleting lines, arcs, circles, rectangles, curves, and beziers.
- Adjusting and transforming the linear and physical properties of elements in the design such as line type, number of bridges, or physical placement in the design.

Creating geometry

What is geometry?

In Designer, *geometry* is any item that is on a die press manufacturing tool. Dimensions, annotations, and graphics are not considered geometry. Create geometry with the tools on the Geometry toolbar.

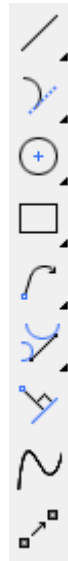

Endpoint Offset Mode



Endpoint offset mode lets you create geometry when you don't know the exact endpoint, but you know that you want it to be offset by a certain distance from an existing line or point. You can offset from a line or a point. The way it works is that you activate it while you are setting a prompt for a tool.

To activate it, either click the toggle button on the Status bar, or hold down ALT and click the line or point from which to start the offset.

You can start an offset from:

- An endpoint
- An extend point
- A dynamic point (one created by Dynamic Drafting)
- An intersection
- A line
- A construction line
- An arc
- A construction arc

You can use Endpoint offset mode in:

- Geometry tools (Line, Arc, Circle Diameter, and so forth)
- Rotate tools
- Copy Rotate tools
- Mirror tools
- Copy Mirror tools
- Move By

Note: The rotate and mirror tools require two Undo commands to return to the previous state.

You can offset from either a line (click the line) or a point as listed above. Offsetting from a line prompts for Offset 1 and Offset 2. Offsetting from a point prompts for Offset X and Offset Y.

Most tools allow either method, but:

- If you set the Length prompt in a tool, you can only use this mode to offset from a line, not from a point.
- **Rectangle Horiz/Vert, Rectangle from Center, Ellipse, and Circle Diameter** only support offsetting from a point, not a line.

When you use the offset from a point method,

- Use the same reference point for each offset
- Set either offset to continue the geometry
- Complete one more field on the Status bar to finish the geometry.

If you do a combination of offset from a line and offset from a point, ArtiosCAD displays the controls on the Status bar in the order in which you chose offsets.

To change the reference point or to start the offset again, click the Endpoint offset mode toggle on the Status bar again or CTRL-click the point or line.

To exit Endpoint offset mode, either click the button on the Status bar to turn it off, or press ESC to restart the tool.

Using Endpoint Offset Mode

Let's say you want to put a window in a panel that's the same distance away from the two far edges of the panel no matter how you rebuild the design.

1. Use **Move To** (CTRL-W) to move the current position to the top left corner of the panel.
2. Start the **Rectangle Horiz/Vert** tool.
3. Use **Move By** (CTRL-Q) to set the point of the upper left corner of the window.
 - a) After you start Move By, ArtiosCAD will prompt for an angle. Hold down ALT and click the crease forming the top of the panel to start the offset for the starting point.
 - b) Drag down to set the direction of the offset. Type D/6 in the Offset 1 field on the Status bar. (This uses Offset from line mode.)

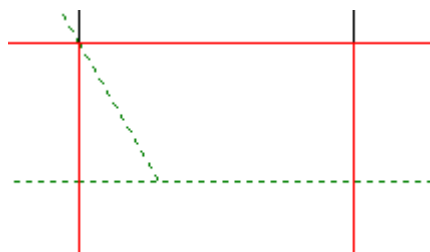

- c) ALT-click the crease forming the left side of the panel and set Offset 2 to W/4. ArtiosCAD now has enough information and moves the current position to the starting point for the window.

4. Set the width of the window as follows:
 - a) Drag toward the crease forming the right side of the panel.
 - b) ALT-click the midpoint of the crease to create an offset from the right side of the panel. You have to click the midpoint because **Rectangle Horiz/Vert** only supports offsetting from a point.
 - c) Drag left and set the offset at $\frac{1}{2}$ inch or 13 mm.

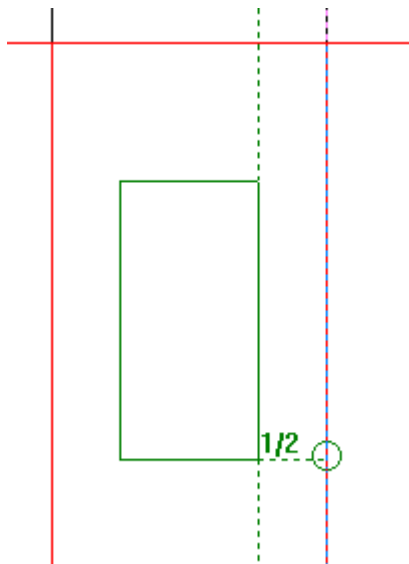

5. Set the height of the window as follows:
 - a) Drag down toward the cut forming the bottom of the panel.
 - b) ALT-click the midpoint of the cut to create an offset from the bottom of the panel.
 - c) Drag up and set the offset at $\frac{1}{2}$ inch or 13 mm.

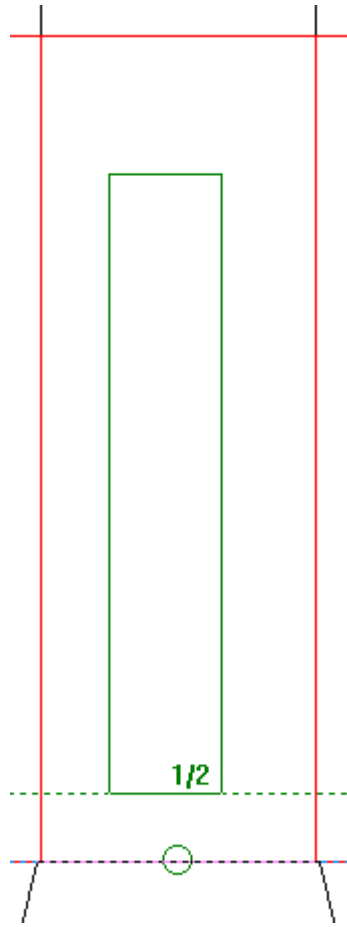

6. ArtiosCAD creates the rectangle.

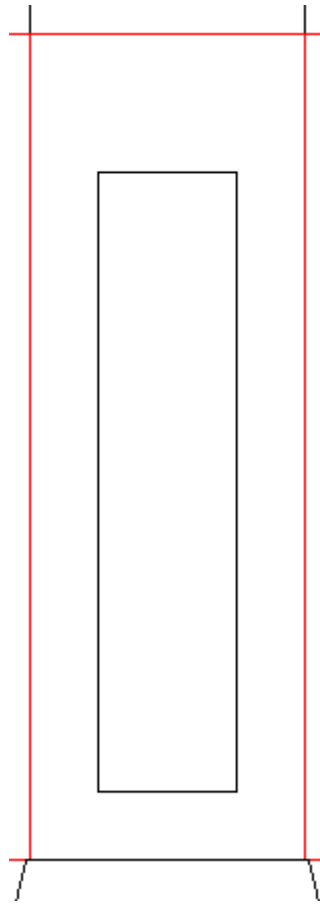

This window will remain in the same distance away from the right edge and bottom of the panel no matter how you rebuild it. No construction lines were needed.

Before resizing, with the carton dimensions of 2" x 2" x 5" or 50 mm x 50 mm x 127 mm:

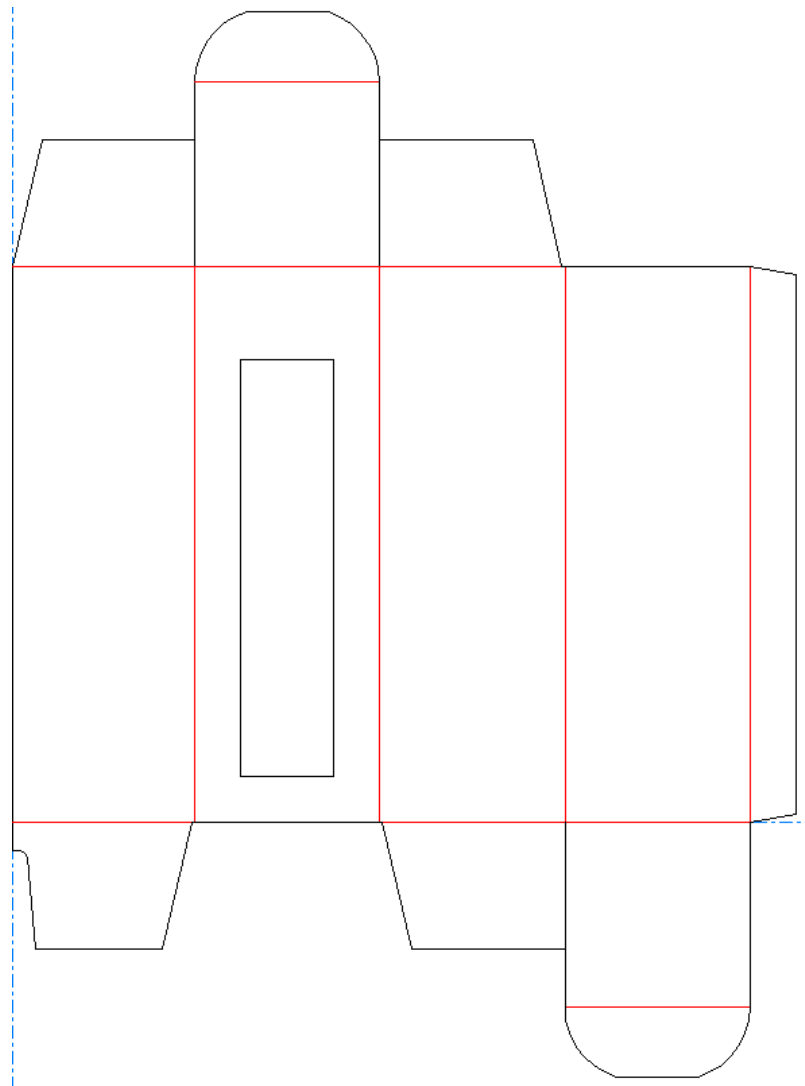

After resizing, at 3" x 3" x 9" or 76 mm x 76 mm x 229 mm. Note how the right side and bottom of the window are the same distance away from the edges of the panel even though the window size has changed dramatically.

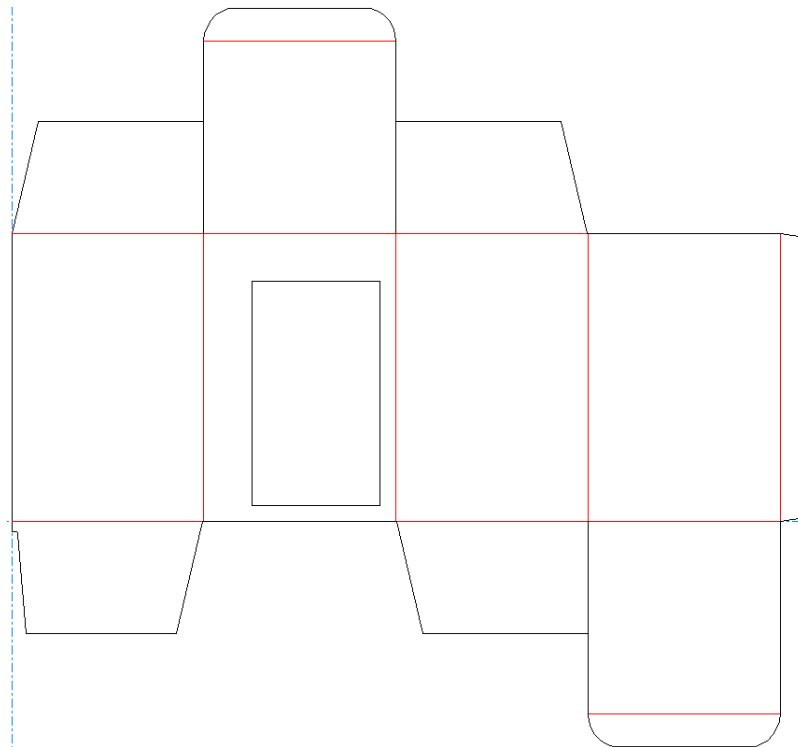

Lines

Lines are one of the basic building blocks of ArtiosCAD. Any shape can be made out of lines and arcs. There are three Designer tools to create lines: the Line Angle/Offset tool, the Line Horiz/Vert tool, and the Line Angle/Length tool.

The first button on the Geometry toolbar activates the **Line** tools. The Line tools are used to make straight lines. When you click and hold a Line tool button on the toolbar, the Line flyout toolbar appears.



Lines at an angle

 To make a line at an angle, click the **Line Angle/Offset** tool. The line will begin at the current position. The Status bar will prompt for the angle of the line and the offset of the endpoint. Set the prompts using drag and the line will be drawn. Use the arrow keys to move among the fields on the Status bar – the highlighted field is the one being set by the drag.

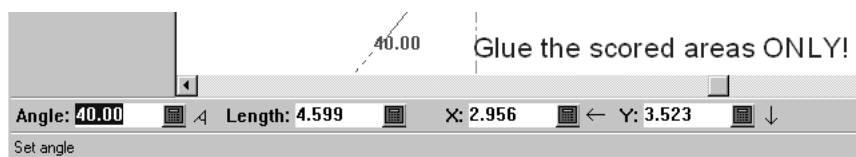

If you click an established point when prompted for the offset, the line being drawn will end at the point you clicked if possible. If the end-point and the point you clicked are not collinear, the endpoint will be aligned with the point you clicked.

You may use any Line tool to construct a line at an angle. Simply change the Status bar prompts being set by the drag. The toolbar buttons only specify which prompts are selected when the tool is activated.

When using this tool, holding down CTRL while clicking performs a **Move By**.

Lines with a known X, Y offset of the end-point

 To make a line from the current position with a known X,Y offset of the end-point, click the **Line Horiz/Vert** tool. Set the prompts. If the end-point is a known point, simply click that point, and the line will be created.

Lines of a specific length

 To make a line at a specific length, use the **Line Angle/Length** tool. Set the angle and length fields using drag, or if you prefer, type the desired values.

Line to a known point

 To make a line from the current position to a known point, click the **Line Angle/Offset** tool, then click the point that is the end-point of the line. The angle and length will be set automatically. A small temporary circle will appear around the point that was snapped to.



Arcs and circles

Arcs and circles are one of the basic building blocks of ArtiosCAD. Any shape can be made out of lines and arcs. There are six Designer tools to create arcs and circles: the **Arc Start Angle** tool, the **Arc End Point** tool, the **Arc Center** tool, the **Arc Through Point** tool, the **Circle** tool, and the **Ellipse** tool.

The second button on the Geometry toolbar activates the Arc tools, and when held down, activates the Arc flyout toolbar. The third button on the Geometry toolbar activates the Circle tools, and when held down activates the Circle flyout toolbar.

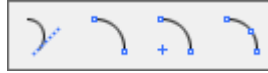

ArtiosCAD prompts for five pieces of information when creating an arc:

- **Start angle.** This is the angle at which the arc projects from the start-point. This is shown as **A1** on the Status bar.
- **Arc radius.** This is the distance from the arc to the center of the circle of which the arc is a piece.
- **X and Y offsets.** These define the position of the arc's end-point in relation to its start-point.
- **End angle.** This is the angle at which the arc ends. This is shown as **A2** on the Status bar.

ArtiosCAD constructs an arc as soon as it knows any 3 of these 5 pieces of information.

Arcs using a start angle, radius, end-point offset

If you know the angle, radius, and location of the end-point of the arc you want to make, use the **Arc Start Angle** tool to construct the arc.

1.  Click the **Arc Start Angle** tool on the Geometry toolbar.
2. Use the mouse to set the drag for the start angle.

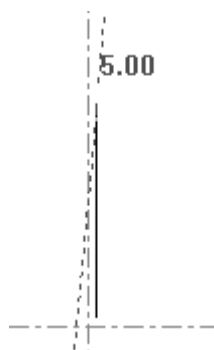

3. Once the start angle is set, use the drag to set the radius of the arc.

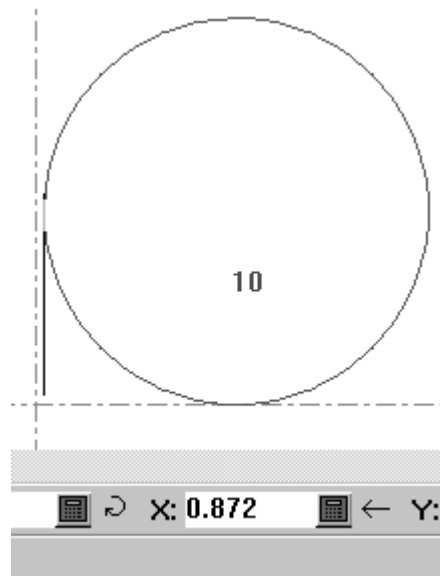

4. Set the Y offset of the end-point using the drag. To set the X offset instead, use the arrow keys to move the highlight to the X offset field.

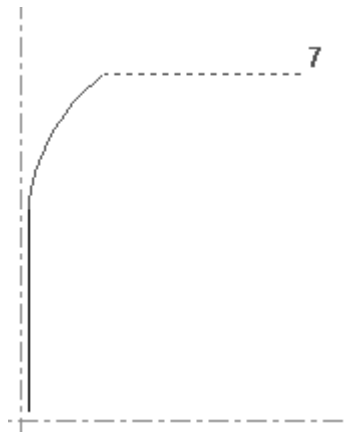

5. As ArtiosCAD now has the pieces of information it needs to construct the arc, the arc is made.



Arcs using an X, Y offset, radius

Use the **Arc End Point** tool to make an arc when you know the radius and the X,Y offsets of the end-point.

1.  Click the **Arc End Point** tool and use the drag to set the X offset of the arc's end-point.
2. ArtiosCAD will then prompt for the Y offset of the arc's end-point.
3. After the Y offset of the arc's end point has been set, ArtiosCAD will prompt for the radius of the arc.
4. The arc is now created and the tool remains active in order to make another arc.

Arc Center

 The third tool on the Arc flyout toolbar is the **Arc Center** tool. This tool makes an arc when any 3 of its 5 data fields are set: the radius, the X value for the center of the arc, the Y value for the center of the arc, the X value for the end-point, or the Y value for the end-point.

Arc Through a Point

 The fourth tool on the Arc flyout toolbar is the **Arc Through Point** tool. The arc starts at the current position. To use this tool, click it, indicate the point the arc will go through, and then click the end-point of the arc.

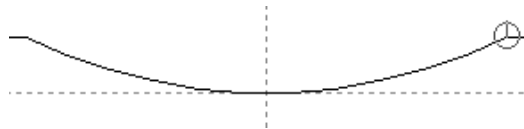

In the picture above, the end-point of the arc has a small snap circle around it.

If the start point is on a construction circle or arc, the drag is constrained to follow the arc.

Note: This tool can only be made using drag. There are no status bar prompts.

Circle

 The **Circle** tool is the third button on the Geometry toolbar, and when held down, activates the Circle flyout toolbar.

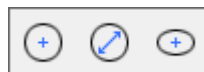

To make a circle, click the **Circle** tool and then set the radius of the circle either by using drag or by typing a value in the prompt on the Status bar.

Once you set the radius, ArtiosCAD constructs the circle using the current position as the center of the circle. As with other tools, you can snap the radius drag to a point; a temporary circle will appear around the snapped-to point.

Circle Diameter

 The **Circle Diameter** tool is the second tool on the Circle flyout toolbar. To make a circle using this tool, do the following:

1.  Click the **Circle Diameter** tool.
2. Drag and click to set the angle from the current position of the line forming the diameter of the circle.
3. Drag and click to set the diameter of the circle. Alternately, press Tab on the keyboard to choose a different field on the Status bar to set with the drag - either the X offset or the Y offset of the end-point of the diameter.
4. Once you have set the end-point of the diameter, ArtiosCAD constructs the circle.

The tool remains active and the current position does not move so that you may continue drawing circles.

Ellipse

 The third tool on the Circle flyout toolbar is the **Ellipse** tool. To make an ellipse, click the **Ellipse** tool and use drag to set the X and Y offsets of the edge of the ellipse from the center point. *Angle* refers to the angle at which the ellipse is viewed. It does not affect the construction of the ellipse. Setting the X and Y offsets are shown below.

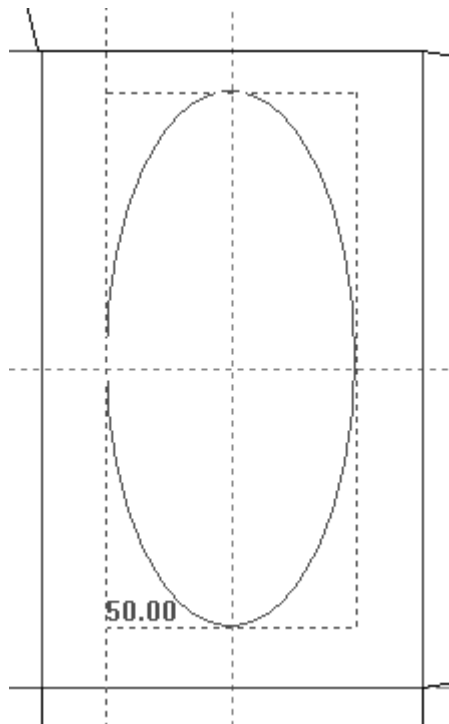

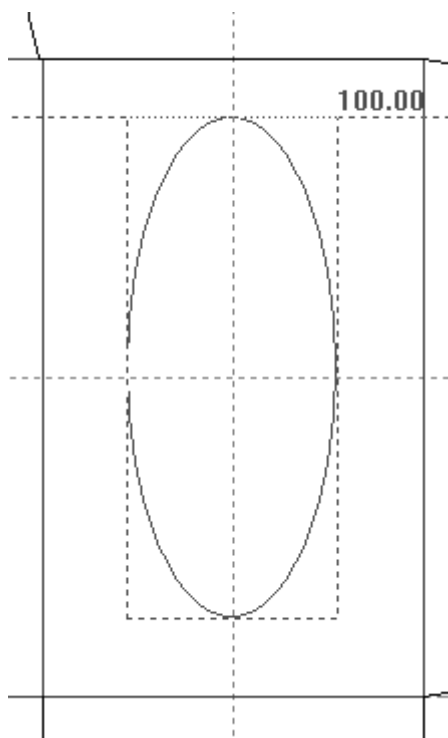

When both the X and Y offsets are set, ArtiosCAD constructs the ellipse.

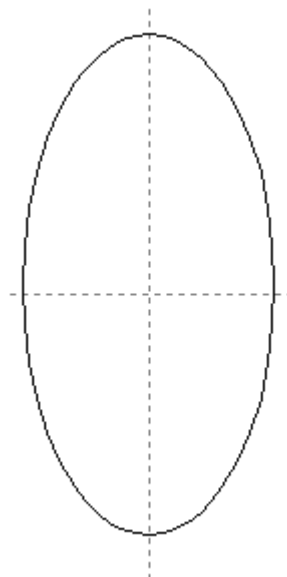

Rectangles

Instead of making you draw four lines to construct a rectangle, ArtiosCAD makes the construction of rectangles easy by providing a tool for that purpose. You can make a rectangle from scratch, or you can expand a line into a rectangle. You can also expand a line into a complete panel using a geometry macro.

The fourth button on the Geometry toolbar activates the **Rectangle** tool, and when held down, activates the Rectangle tools flyout toolbar. The Rectangle tools are used to create rectangles.



Rectangle Horiz/Vert

Use the **Rectangle Horiz/Vert** tool to create rectangles in two easy steps. To make a rectangle, click the **Rectangle Horiz/Vert** tool and indicate the X offset of the point diagonally opposite from the current position as shown in the picture below.

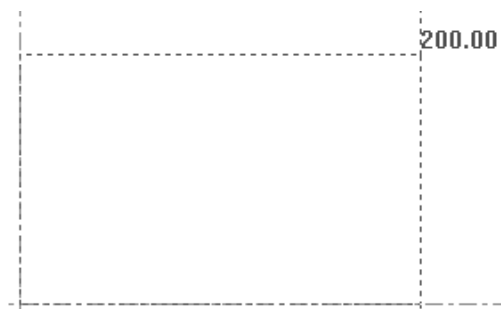

To construct the rectangle with blended corners, enter a value in the **Blend:** field on the Status bar before setting the X offset. Press Enter once you have entered the value to lock it in.

Once the X offset of the corner point is set, set the Y offset using the drag as shown in the picture below.

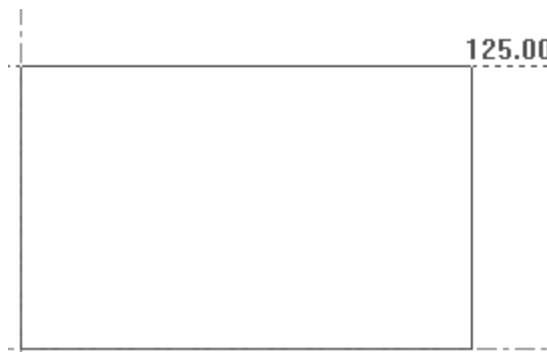

When the X and Y offsets have been set, ArtiosCAD constructs the rectangle and the current position moves to the corner of the rectangle whose offsets were set. Shown below is the completed rectangle.

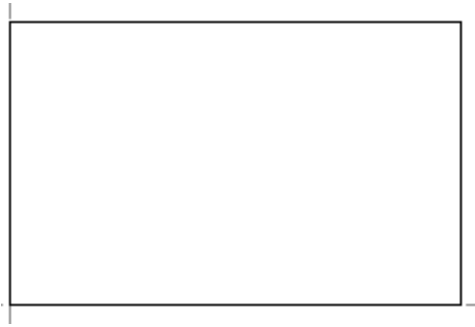

The **Rectangle Horiz/Vert** tool remains active so that another rectangle may be made.

Rectangle from Center

The second button on the Rectangle flyout toolbar activates the **Rectangle from Center** tool. This tool creates a rectangle from its center with an optional blend on the corners. To use it, do the following:

1. Move the current position to the center of the desired rectangle by using CTRL-W, CTRL-Q, or **Tools > Current Point**.
2.  Click **Rectangle from Center**.
3. On the Status bar, enter an optional value in the **Blend:** field and press enter to lock the value in the field.
4. Use drag to set the X and Y coordinates of a corner of the rectangle. The values in the fields on the Status bar are for the entire width and length of the rectangle, not half of it.

Panel from Line

 The third button on the Rectangle flyout toolbar is the **Panel From Line** tool. This tool creates a rectangle using drag from a line you select, or lets you run a geometry macro to replace the line. This tool prompts you to select a line, and then uses the selected line as the base of a rectangle created using drag.

When you use this tool, the following initial controls appear on the Status bar:

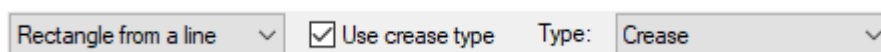

Rectangle from Line mode

To use this tool in Rectangle from Line mode, click it and then select a line. Use the drag to set the size of the rectangle, or type the desired value in the Status bar.

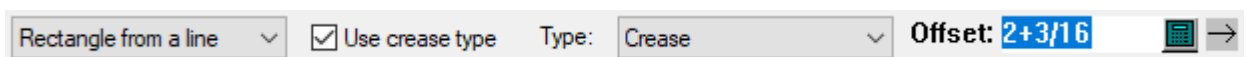

Use crease type, when checked, causes the connecting line to be changed to the crease type you specify in the **Type** drop-down list box. Defaults for these settings are in Startup defaults.

If the opposite line is within the perimeter of the design, it is also changed to a crease; if it is not, the other sides of the rectangle are changed to creases. Be careful of this when using this feature in rectangular holes, as the specified line and the opposite line will both be inside the and thus will both change to creases.

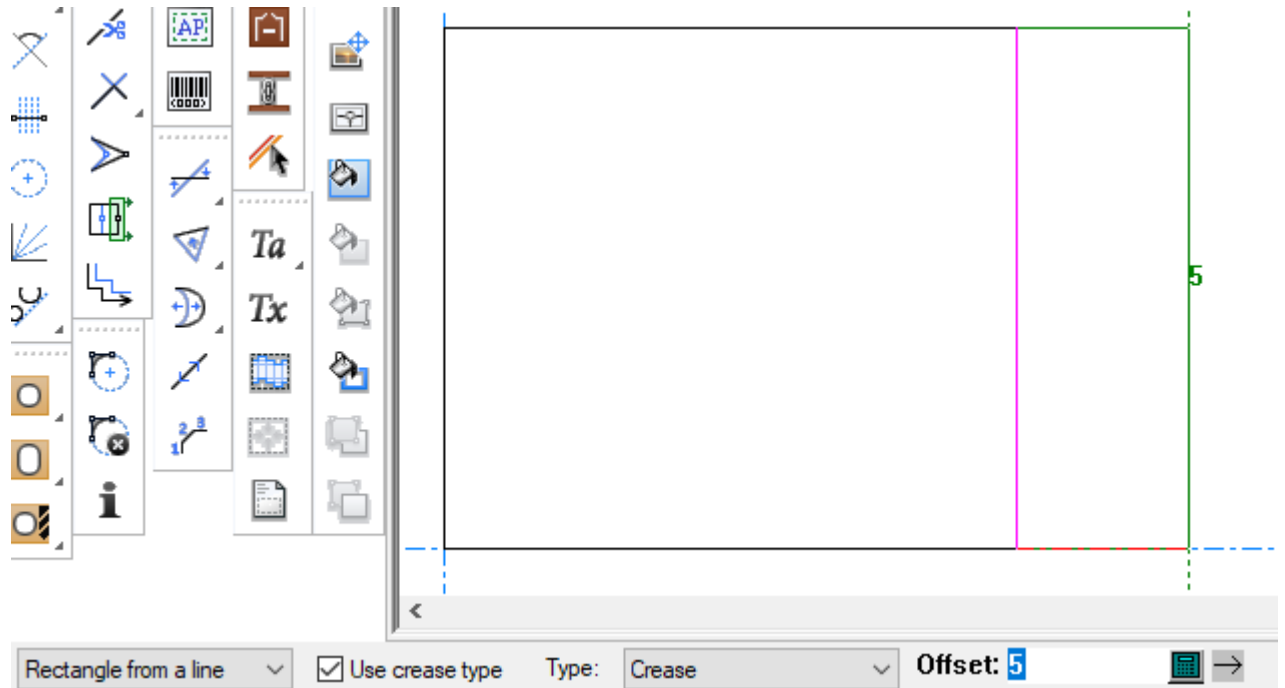

Once the offset of the opposite edge of the rectangle is set, ArtiosCAD constructs the rectangle. The tool remains active to create another rectangle from the one just created.

Note:

The change of the line type depends on whether or not the line is inside the design at the time when the rectangle was created; it will not change depending on the geometry when you rebuild. For example, if you make a flap with offset 4 and the line is changed to crease, if you then rebuild with -4 or 0 the line will still be a crease even though it is no longer supposed to be.

Geometry Macro mode

When you click the drop-down list box that always defaults to **Rectangle from a line**, ArtiosCAD opens a catalog of geometry macros. These geometry macros are all of type Panel from a line. The names are in English only.

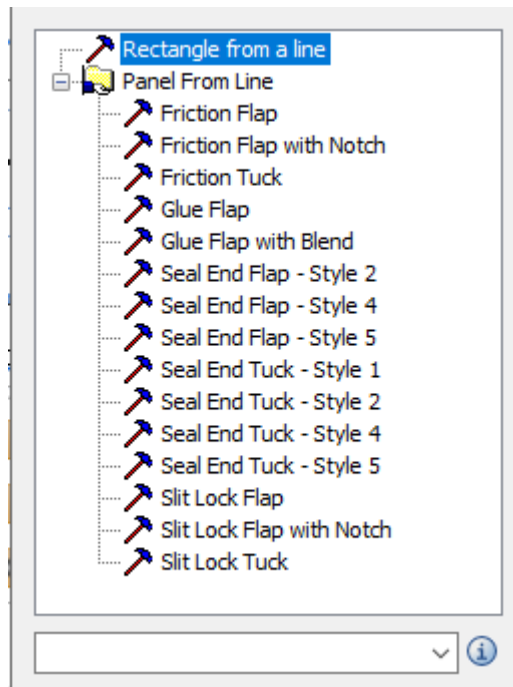

Hover over a catalog entry to see a pop-up preview of the geometry it makes.

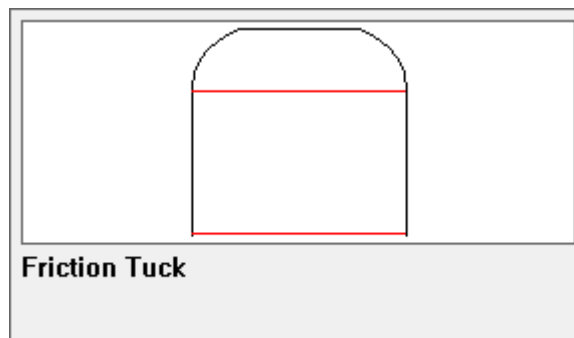

If you choose a geometry macro, ArtiosCAD makes **Use crease type** and the line type selector unavailable.

Using a Geometry Macro

1. Click the geometry macro to use. In this case, use a Friction Flap.
2. Click the line to base it on.

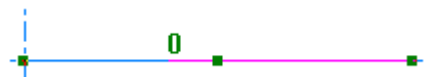

3. Use drag to set its size and click to set the offset. ArtiosCAD determines which orientation to use for the drag by which end of the line you clicked closer to.

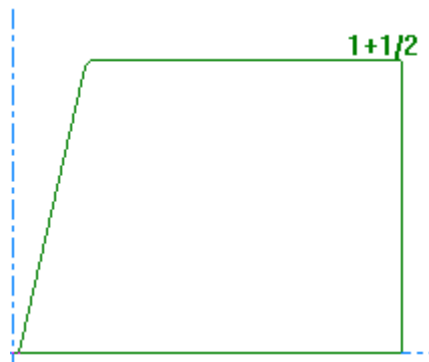

If you move the mouse toward the opposite end, ArtiosCAD flips the drag lines.

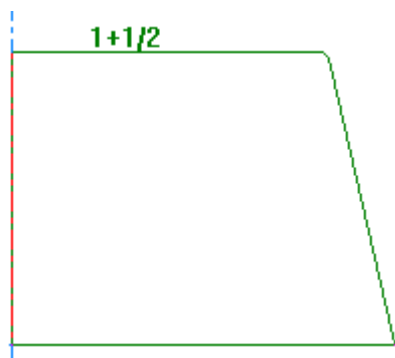

4. The variables for the geometry macro will appear in the Geometry Macro Variables dialog box. If the first menu of variables only contains L and H, ArtiosCAD skips it and starts with the second one. If you do see L and H, L is unavailable and is always the length of the line you clicked, and H is the value you set with drag. Set the variables as desired. ArtiosCAD updates the drag immediately as you change variables. Click **Next>** to go to the next menu, or click **OK** to finish.

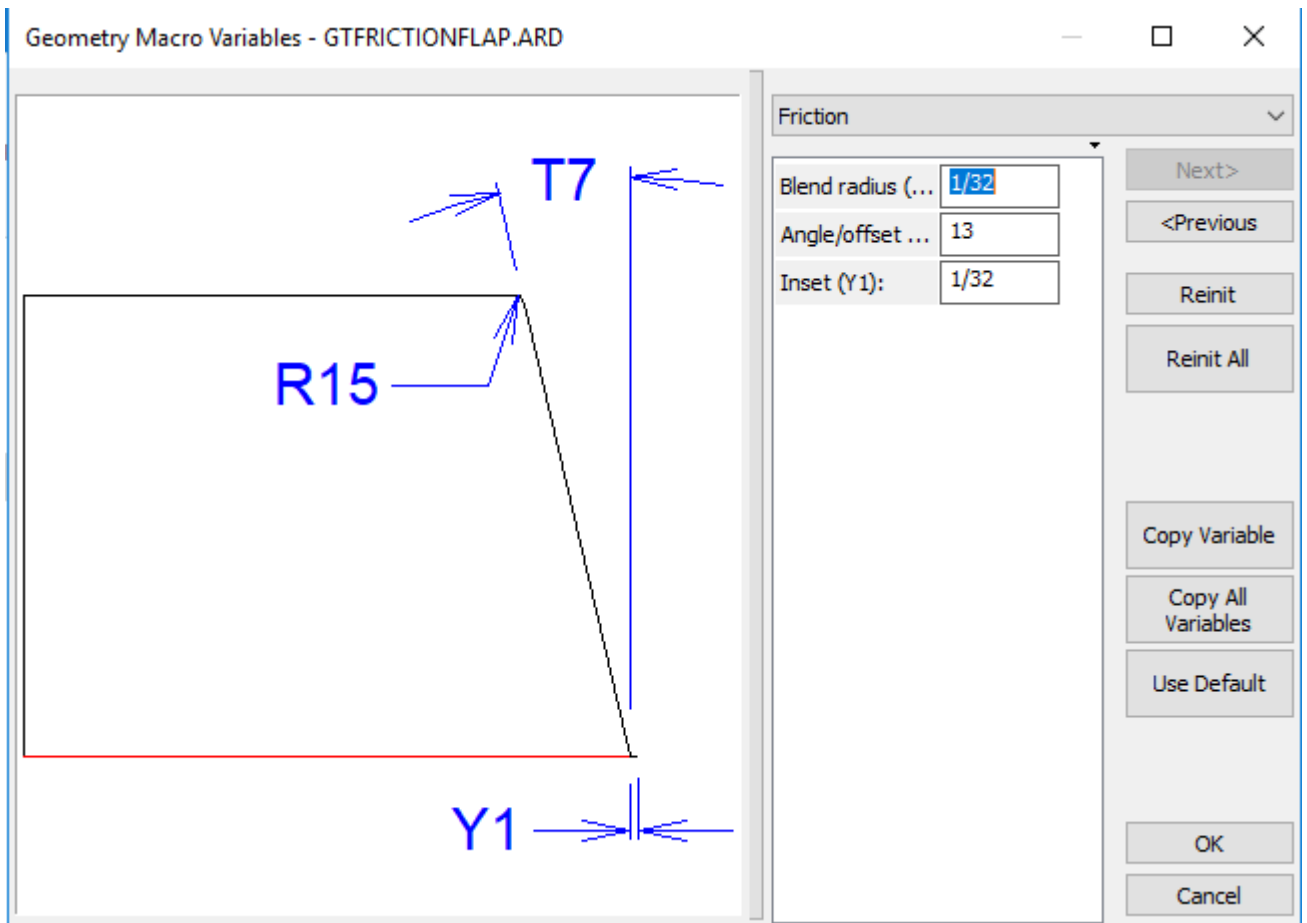

5. ArtiosCAD replaces the line with the result of the geometry macro.

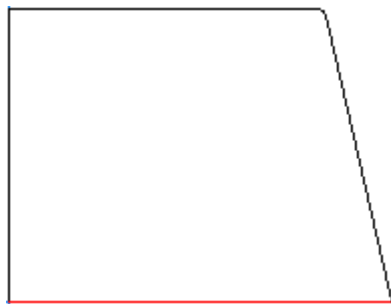

6. The tool remains active with the same geometry macro, prompting you to select another line to extend. If you exit the tool and restart it, ArtiosCAD remembers the last-used geometry macro and selects it.

ArtiosCAD checks the geometry macro before it runs it. L must be defined and L and H must be distance or angle/offset variables. There also must be room in the design for the layers from the geometry macro if **Move lines to layers** is enabled in its catalog entry in Defaults.

If you use the same geometry macro repeatedly and its L and H match the last ones used, ArtiosCAD will use the same variable values for the other variables. If L and H do not match, ArtiosCAD reinitializes all variables to their default values. If ArtiosCAD keeps the variables,

it compares them to the first run's values and records them with the first run's expressions if they match. This allows all copies of this geometry macro to rebuild based upon the same formula.

ArtiosCAD embeds the geometry macro in the workspace for portability between systems.

If you are working with consecutive Seal End 4 and Seal Tuck 4 geometry macros that need to be the same size to align properly, in the first one, copy variable S6, the slit length, using **Copy Variable** in the Geometry Macro Variables dialog box. Then in the next geometry macro, type S6 for the slit length. The same is applicable to the Seal End 5 and Seal Tuck 5 geometry macros with a hairpin curve between them. Copy Hairpin Depth H1 and Hairpin Radius R1 from one to the next so they align properly.

When working with Panel from Line geometry macros, do not do a double line removal until after you are done constructing the design and have added dimensions if desired. This avoids the potential for lines not existing after a rebuild.

Tips for Creating Your Own Panel from Line Geometry Macros

The following guidelines apply when you create your own Panel from Line geometry macros.

- Create L, H, and any other variables before you begin construction. L is always the length of the macro and H is the height.
- Put L and H in the first menu alone so you can reference them in subsequent menus.
- Always start at the origin and design up and to the right. ArtiosCAD will automatically rotate the geometry as needed when running the geometry macro.
- Draw the base line of the geometry using L for the size along the X axis. Design the height to use H along the Y axis.
- The board code you select for the workspace does not matter.
- Use delete under line types to trim nearby lines but use them sparingly if you intend to rebuild the destination design after running the geometry macro.
- Use **Edit Expression** to make a Units branch for static values – such as UNITS(1.5,1/16) so that the geometry macro works well in both systems of measurement.
- In Defaults, add your geometry macro to the Geometry Macro catalog using type **Panel from Line**. Check **Use in design** and deselect **Use in manufacturing**. If your geometry macro has dimensions, check **Move lines to layers** to move them to the Dimensions layer after you run the geometry macro.

Using Panel from Line Geometry Macros to Make a Design

It is possible to construct an entire design using **Panel from Line** geometry macros.

1. Create a new design.
2. Use **Rectangle Horiz/Vert** to make a rectangle with dimensions W and D, defining them on the fly. Start the rectangle at the origin and drag it up and to the right. In this example, W is 2 and D is 6.

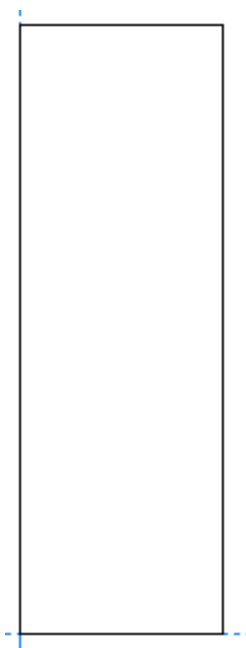

3.  Use **Panel from Line** in **Rectangle from a line** mode to make three additional panels of size L, W, and L. Set L to 2. Check **Use crease type** and set the drop-down list box to **Crease**.

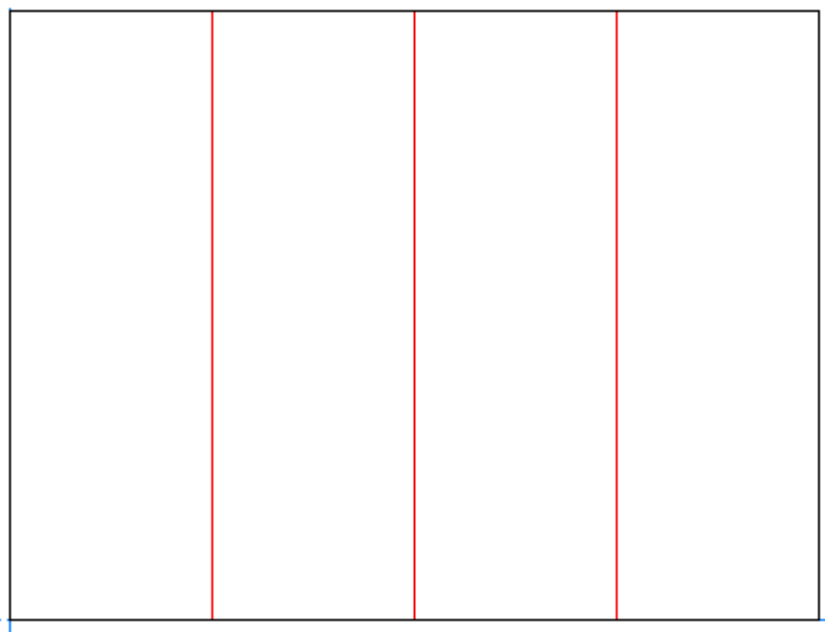

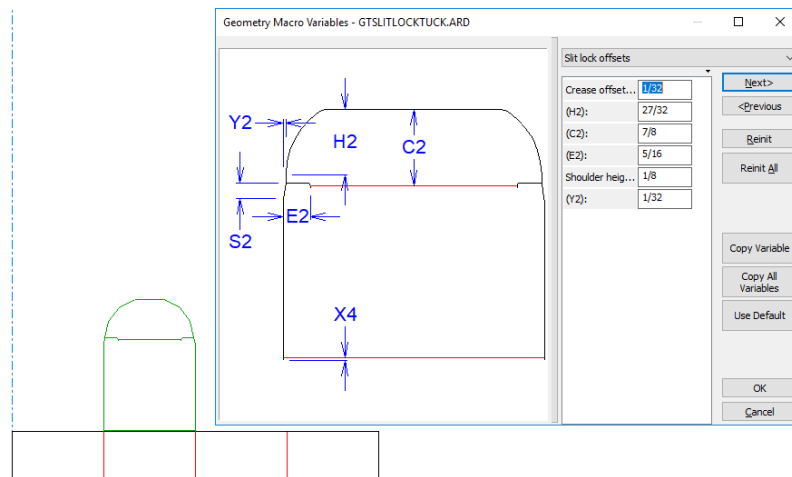

4.  Use **Panel from Line** with the **Slit Lock Tuck** geometry macro to make a tuck from the top of the second panel. Set the **Offset** to W.

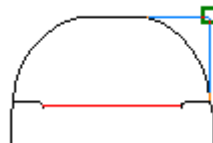

5. Click **OK** to accept its variables.

6.  Use **Conline Division/Midpoint** to make a construction line halfway up the tuck flap, using the Dynamic Drafting point at the corner of the flap blend as one end and the bottom of the flap as the other.



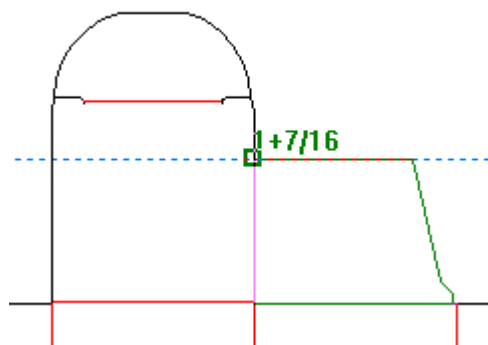

7.  Use **Panel from Line** with the **Slit Lock Side Flap** geometry macro to make the flap, and snap its height to the conline intersection with the side of the tuck. Make sure to drag close to the tuck so that the flap is oriented properly.

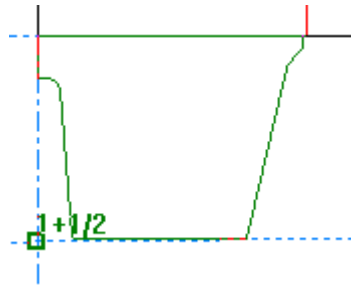

8. Click **OK** to accept its variables.

9. Add the other tuck and flaps in the same way, using the **Slit Lock Side Flap with Notch** for the last one. Pick a point on the left side to have the notch on the left.



10.  Use **Panel from Line** with the **Glue Flap** geometry macro to add the glue flap.
11. Click **OK** to accept its variables.
12.  Use **Stretch by Polygon** to shrink the first panel's size by 1/32" or 1 mm for the glue flap reduction. The design is now complete.

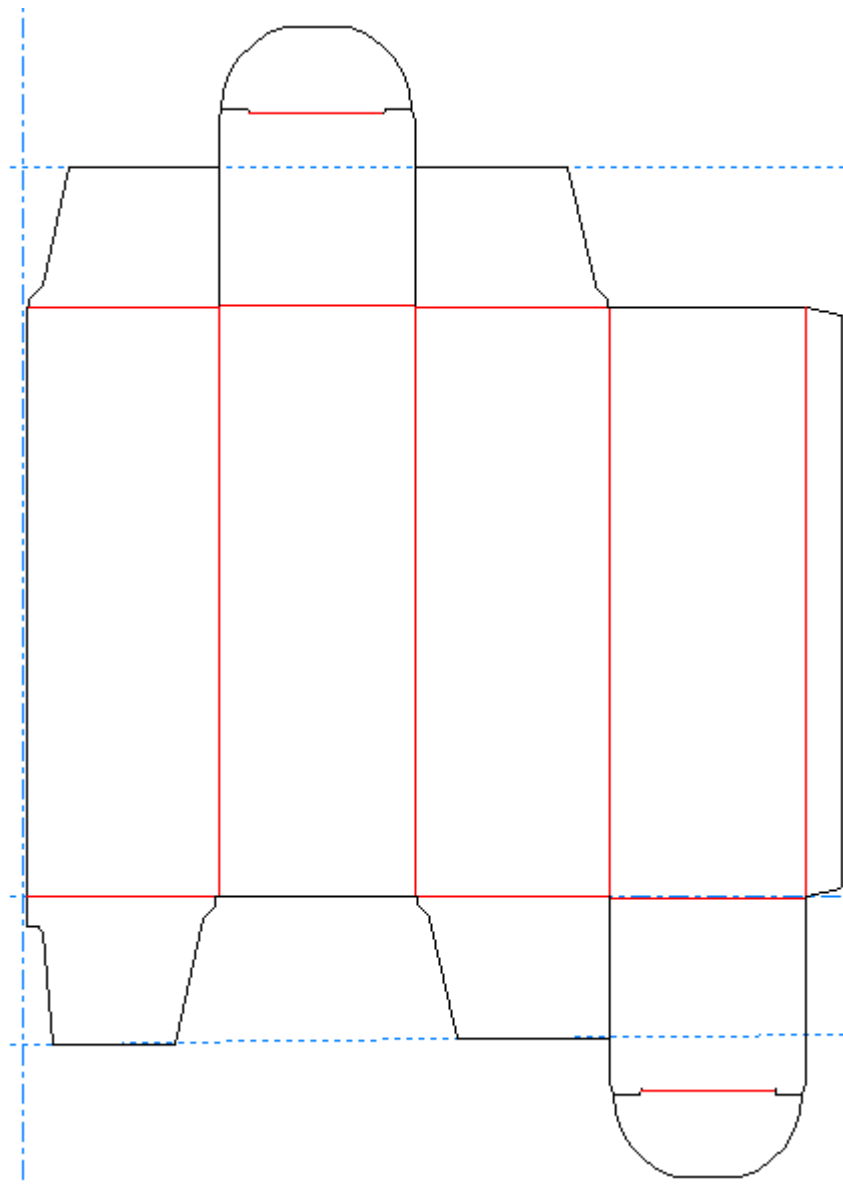

Offset Line

 The fourth button on the Rectangle flyout toolbar activates the **Offset Line** tool. Use this tool to offset a parallel copy of a line from another. To use this tool, click it, click the line to copy, and then indicate the offset using drag.

Straight-curve and Curve-straight

The fifth button on the Geometry toolbar activates the **Straight-Curve** tool, and when held down, activates the Straight-Curve flyout toolbar. A straight curve is a straight line with an arc attached at the end. A curve straight is an arc with a straight line attached at the end.

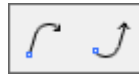

In the picture below, item A is a straight curve. Item 1 indicates the start of the straight curve. Item 2 shows the drawing direction. Item B is a curve straight, and item 3 is the start of the curve straight.

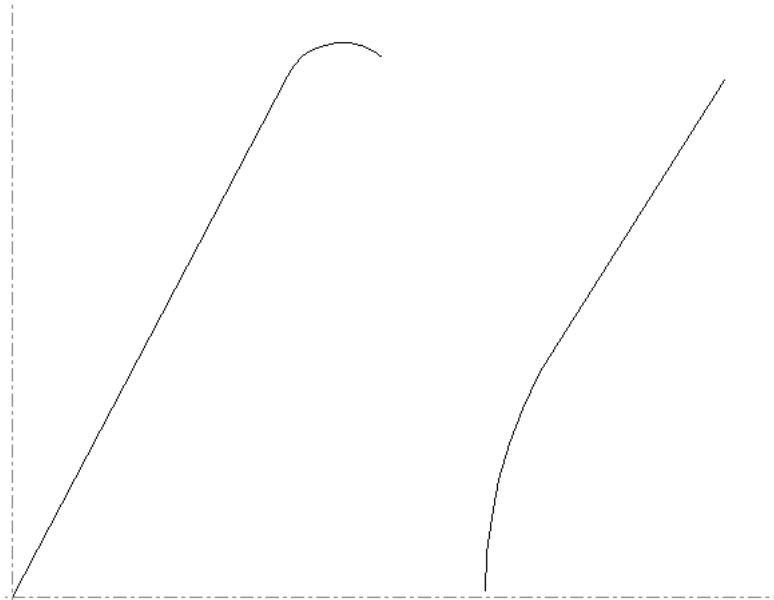

The first button on the Straight-Curve flyout toolbar, and the default Straight-Curve button on the Geometry toolbar, is the Straight-Curve tool. To make a Straight-Curve, do the following:

1. Click the **Straight-Curve** tool on the Geometry toolbar.
2. Set the X and Y offsets of the end-point of the Straight-Curve.



3. Set the Start Angle of the straight portion of the Straight-Curve.

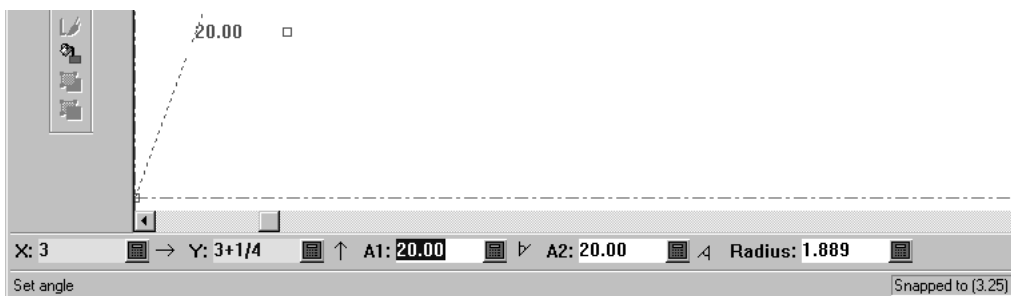

4. Set the radius of the Curve portion of the Straight-Curve with the drag.

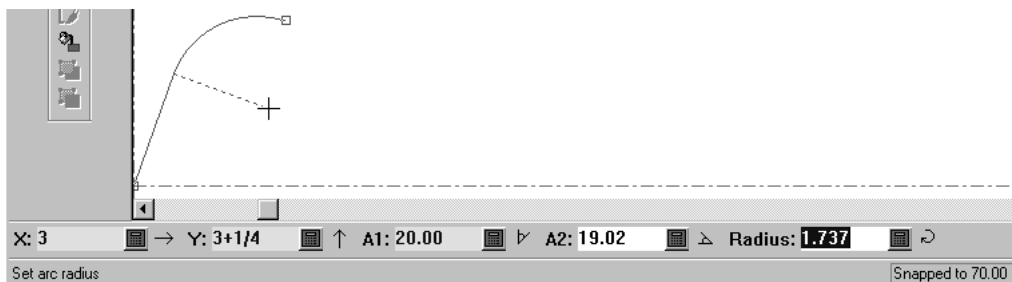

5. Once ArtiosCAD knows 4 of the 5 pieces of information in the Status bar, it constructs the Straight-Curve.

The second button the Straight-Curve flyout toolbar is the **Curve-Straight** tool. It works the same way as the Straight-Curve tool, but the arc is made at the beginning of the line, not the end.

Line Join tools



The sixth button on the Geometry toolbar activates the **Line Join** tool, and when held down, activates the Line Join tools flyout toolbar.

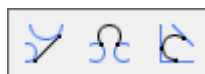

This tool joins two points, two circles, or a point and a circle with a straight line. It also works with construction line circles.

To use this tool, click it, indicate the first point, arc, or circle, and then indicate the second point, arc, or circle. When one of the objects being joined is a circle, the line is made tangent to the circle.

If you click an arc or a circle as the first object, to make a line tangent to that arc or circle, use the drag to set the angle and then either set the length or set the X and Y prompts for the end-point of the line. If you click close enough to a line or arc, it will snap to that line or arc.



The second button on the Line Join tools flyout toolbar activates the **Arc Join** tool. As its name implies, it joins a point, line, arc, or circle to another point, line, arc, or circle with an arc. If two lines are being joined, they cannot be parallel. To use this tool, click it, indicate the first object to join, then the second object to join, and then finally the radius of the arc used to join the two objects. Depending on the points chosen, it is possible that the arc joining the two objects will intersect them.

Depending on how you set the drag, the points at which the arc joins the two objects could be different. The same happens when two circles are joined together with an arc – the points of tangency switch depending on the radius of the arc.

 The third button on the Line Join tools flyout toolbar is the **Tangent Arc** tool. This tool makes an arc tangent to three lines. To use this tool, click it, and then indicate the three lines to which the arc is to be tangent.

Line at Angle to a Line tool

 The seventh button on the Geometry toolbar activates the **Line at Angle to a Line** tool. This tool draws a line at the desired angle from the current position. To use it, click it, select a line or arc to measure the angle from, and then use the drag to make a line at the desired angle.

Beziers

 The eighth button on the Geometry toolbar activates the **Bezier** tool. A bezier, also called a *French curve*, is a curve defined by four points: the start point, the endpoint, and two control points.

Freehand coordinates in the Snap Options dialog box must be checked for this tool to function. Click **Options > Snap** and then look in the **Snap to Point** group. If you see an error message in the Status bar `Cannot select coord` when trying to use this tool, Freehand coordinates is turned off and you must turn it on.

To make a bezier, do the following:

1.  Click the **Bezier** tool on the Geometry toolbar.
2. The bezier will begin at the current position. Click the desired position for the endpoint.
3. Use the drag to set the position of the first control point. In the example below, the first control point is at the top of the left dashed line.

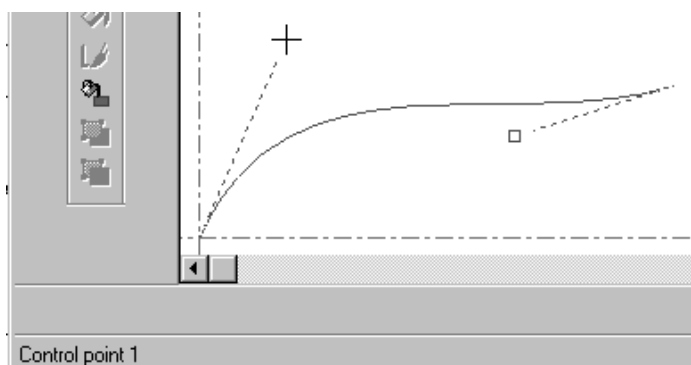

4. Use drag to set the position of the second control point. In the example below, the second control point is at the bottom of the right dashed line.

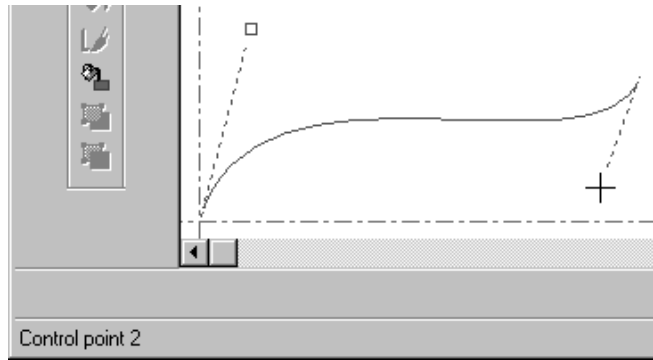

5. ArtiosCAD constructs the bezier once the second control point is set.

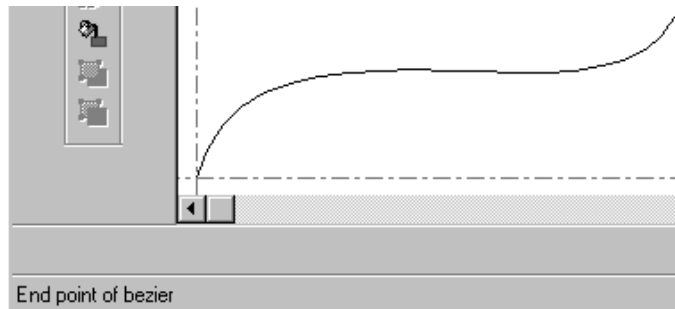

Changing Beziars to Arcs

Use **Change Beziars to Arcs** to change beziars to arcs. This tool uses the current selection if there is one; otherwise, it applies to all beziars in the workspace.

1. Use the **Select** tool to select any particular beziars to change. If you want to change them all, do not select anything. Shown below is a bezier before changing it to arcs with **Direction** turned on in the View Mode.

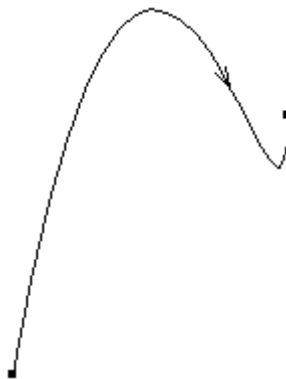

2. Click **Tools > Adjust Outline > Change Beziars to Arcs**.
3. In the Convert Beziars to Arcs dialog box, enter a fit tolerance and click **OK**. A smaller fit tolerance results in more arcs and greater accuracy.

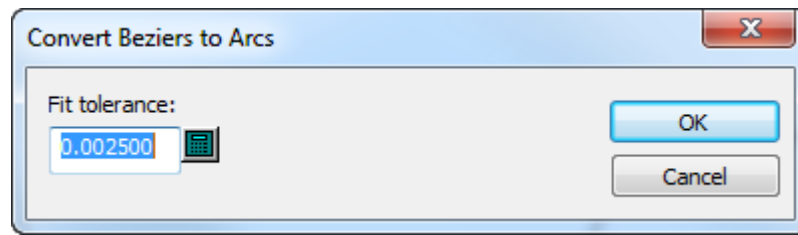

4. ArtiosCAD performs the change. Shown below is the former bezier as a series of arcs.



Drafting aids

ArtiosCAD provides three sets of tools to help create geometry – Dynamic Drafting, construction lines, and extensions. Dynamic Drafting finds alignment points in surrounding geometry; see Chapter 1 for more information. Construction lines create non-manufacturable geometry. Extensions extend existing lines into infinity and existing arcs into circles.

Construction lines

Construction lines are special lines used as drafting aids. They are not considered geometry, but they are used to make geometry.

How and when to use construction lines

Use construction lines when you want to reference points that are not part of the geometry of a design. For example, if you want to go to a point that is a third of the way down a line, an easy way to do this is to divide the line in thirds using the **Conline Division/Midpoint** tool. Once the construction lines intersect with the actual line, you can move the current position to one of those intersections.

Construction lines also help when constructing rebuildable designs by providing points of reference. For instance, suppose you have imported a DDES file and want to make it rebuildable. When building a flap, the angle at which the flap is cut back varies with the width of the flap. You can use a construction line drawn over the side of the flap to “remember” the

angle of the flap line. Then when you move the corner point, you can place it directly on the construction line, and the original angle is duplicated perfectly.

Creating construction lines is accomplished by using the tools on the Conlines toolbar, or the command on the Conlines submenu of the Tools menu.

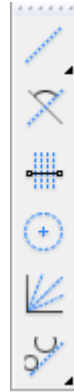

Conline Offset/Angle tool

 The first button on the Conlines toolbar is the **Conline Offset/Angle** tool. When activated, this tool prompts you to select a point or a line. If you select a line, you are then prompted for the offset between the line and the new construction line. If you select a point, you are prompted for the angle at which the construction line will be created.

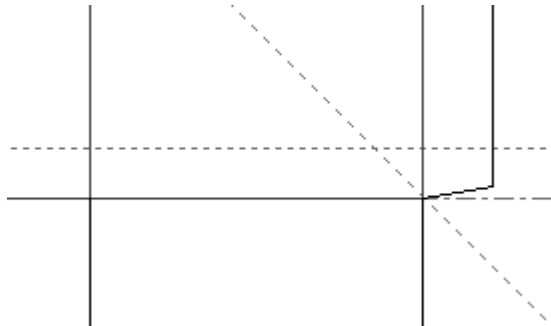

Conline At Angle From Line tool

 The second button on the Conlines toolbar activates the **Conline At Angle From Line** tool. When activated, this tool prompts for a line to measure from and a point that the construction line will pass through.

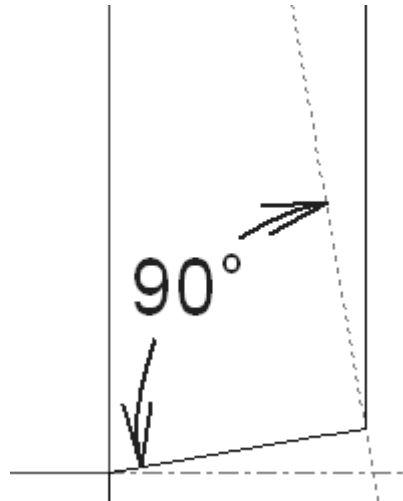

In the picture shown above, the line used to measure from is the line at the bottom of the glue flap, and the point passed through is the intersection of the bottom and side of the glue flap.

Conline Division tool



The third button on the Conlines toolbar activates the **Conline Division/Midpoint** tool. When activated, this tool prompts for the number of divisions and a line or arc to divide. Click the line, first point of the line, or arc to divide, enter the number of divisions to make in the field on the Status bar, and press Enter.

Note: To divide an arc, click the arc itself, not its endpoints, else the arc will be treated as a line and the dividing lines will be parallel instead of meeting at the center of the arc.

The default number of divisions is two. If you activate the tool and click a line or arc, it will automatically be divided in two by a construction line. Note that the object being divided is not split; for that, you must use the **Split Line** tool and click the points created by the construction lines.

The number of construction lines created by this tool will be one less than the number specified in the **Number of Divisions** field.



Shown below is an arc divided into four segments by three divisions.

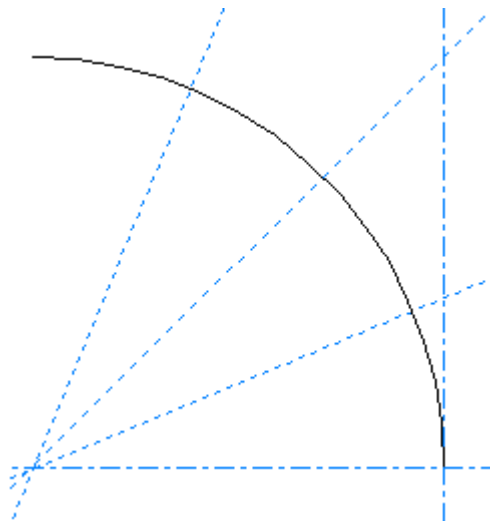

Conline Radius tool

 The fourth button on the Conlines toolbar activates the **Conline Radius** tool. When activated, this tool prompts you to indicate the center of the circle. As long as **Freehand Coordinates** is checked in the Snap options dialog box, the center can be anywhere; it does not have to be on a point. Once you have indicated the center, ArtiosCAD prompts for the radius, which you can set either with drag or by typing in the Status bar. ArtiosCAD constructs a construction line circle once the radius has been entered.

Conline Angle Divide tool

 The fifth button on the Conlines toolbar activates the **Conline Angle Divide** tool. This tool works similarly to the **Conline Division/Midpoint** tool, but instead of dividing a line into line segments, it divides an angle into smaller angles.

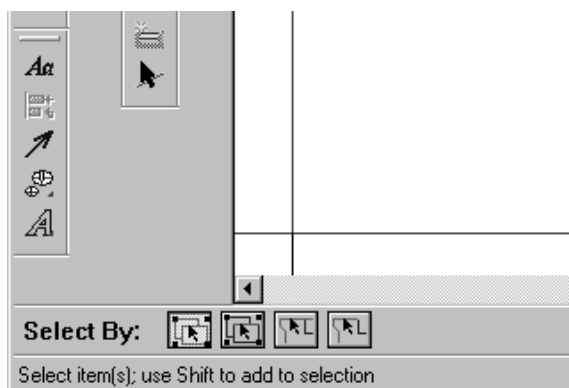

To use this tool, click it, enter the desired number of divisions, indicate one leg of the angle, and then indicate the other leg. The tool will remain active once it has made the divisions.

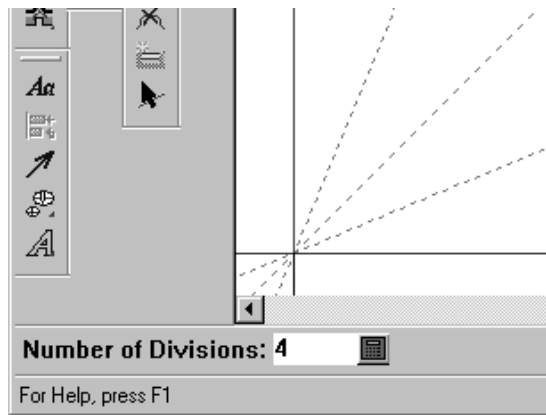

Conline Join tools

 The sixth button on the Conlines toolbar activates the Conline Join flyout toolbar.



 The first button on the Conline Join flyout toolbar, and the default Conline Join button on the Geometry toolbar, is the **Conline Join** tool. This tool joins two points, two circles, or a point and a circle with a straight construction line. To use this tool, click it, indicate the first point, arc, or circle, and then indicate the second point, arc, or circle

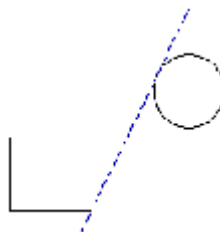

Note: When one of the objects being joined is a circle, the construction line is made tangent to the circle.

 The second button on the Conline Join flyout toolbar activates the **Conline Join With Concircle** tool. As its name implies, it joins a point, line, arc, or circle to another point, line, arc, or circle with a construction line circle. If two lines are being joined, they cannot be parallel. To use this tool, click it, indicate the first object to join, then the second object to join, and then finally the radius of the circle used to join the two objects. Depending on the points chosen, it is possible that the construction line circle joining the two objects will intersect them.

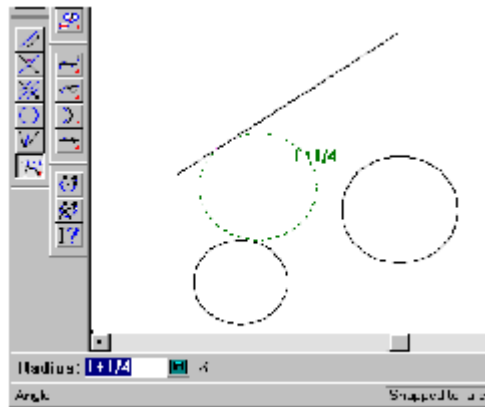

Depending on how you set the drag, the points at which the construction line circle joins the two objects could be different.

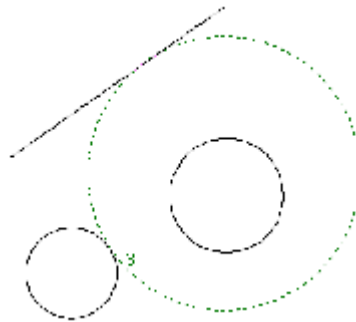

The same happens when two circles are joined together with a construction line circle – the points of tangency switch depending on the radius of the construction line circle.

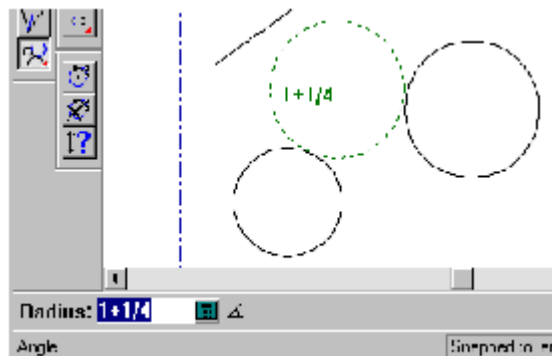

 The third button on the Conline Join flyout toolbar is the **Conline Tangent Concircle** tool. This tool makes a circle tangent to three lines. To use this tool, click it, and then indicate the three lines to which the circle is to be tangent.

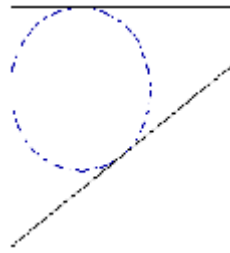

Changing construction lines

You may select construction lines with the **Select Conlines** tool  on the Select tools flyout toolbar, or by using the normal **Select** tool with either of the construction line options on the Status bar.

Each plotting style contains three construction line definitions.

Double-click a construction line with the **Select Conlines** tool to change its type in its Properties dialog box. To change the type of many construction lines at once, select them all and then press ALT-Enter to open the Properties dialog box.

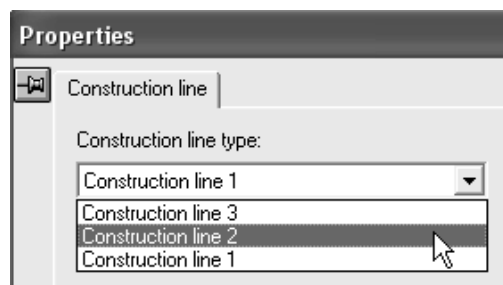

Shown below is a construction line before its type is changed and after its type is changed.

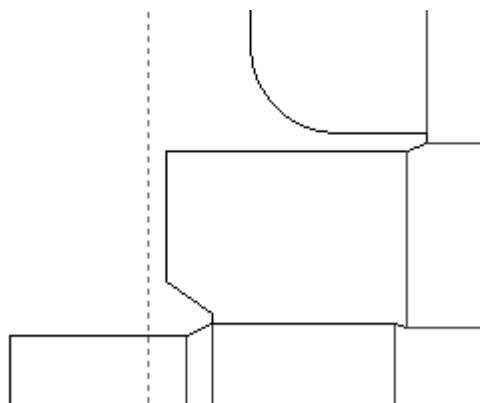

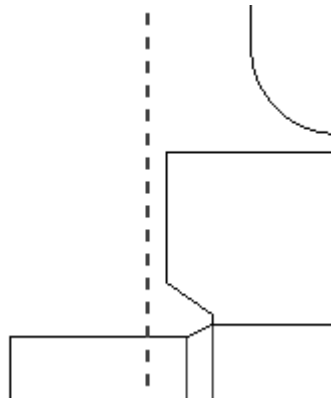

Extend/Measure tools

The tools on the Extend/Measure toolbar work in conjunction with construction lines by making geometry that is not manufactured.



The first button on the Extend/Measure toolbar activates the **Extend** tool. The Extend tool extends lines into infinity and arcs into circles. This is useful when you want to align objects with a line segment or an arc because the extended geometry provides extra points.

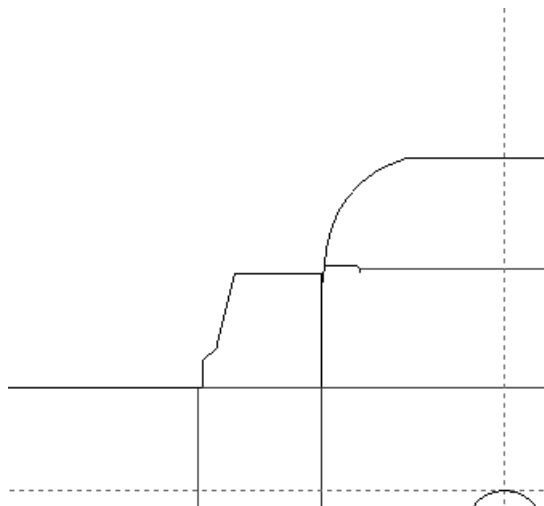

To use the Extend tool, click it, and then indicate a line or an arc to extend. Normally the Extend tool is a one-use tool and does not remain active after it extends the line or arc, but if you hold down SHIFT as you click the first item, the tool remains active and you can click other items to

extend. Make sure to continue holding down SHIFT for the tool to continue. Hold down CTRL to use the Extend tool ignoring groups.

The points displayed using the Extend tool can be used as snap points and measure points.

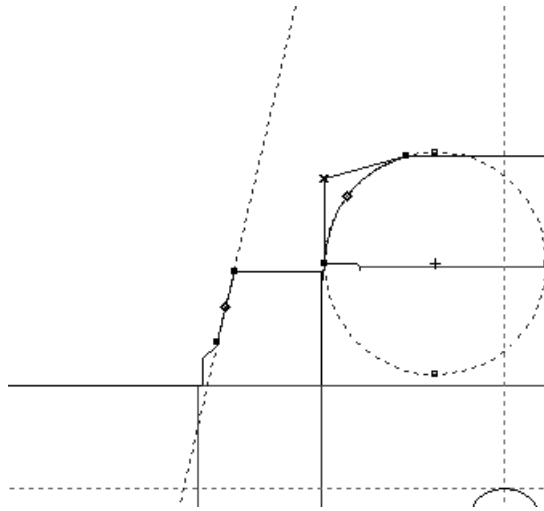

If the cursor is over an item when the Extend tool is started using a keyboard shortcut, the item is extended automatically.

When you use an extended point geometrically, such as creating a line to it or moving it, the extend points are cleared after the tool completes.



The second button on the Extend/Measure toolbar activates the **Clear Extend** tool. The Clear Extend tool deletes all extensions. This is the only way to delete extensions.



The third button on the Extend/Measure toolbar activates the **Measure** tool. In Measure mode, the Measure tool displays pertinent measurements of arcs, lines, and the relationship between two points. In Attributes mode, the Measure tool displays information about the object under the mouse cursor. Change modes by selecting the appropriate button on the status bar, or by pressing Tab, or by using the left and right arrow keys.



To use the Measure tool in measure mode, click it, and then click an arc, line, circle, or set of two points to measure. Shown below are different types of measure tool information dialog boxes. To view just pop-ups, hover over any desired object.



Hold down CTRL while using this tool to measure between pixels. Move the mouse after selecting the second pixel to see the snap. If you measure between pixels, you might have to refresh the view when using high graphics mode.

Attributes mode shows various bits of information about the object under the mouse cursor such as length, line type, pointage, the number and width of bridges and nicks, etc. Only geometric elements can be viewed using the Measure tool.

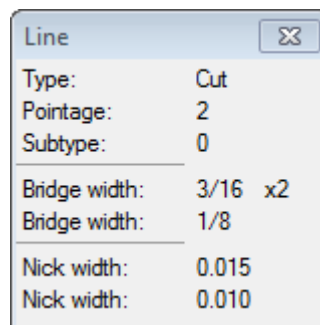

Line		✕
Type:	Crease	
Pointage:	2	
Subtype:	0	
<hr/>		
Bridge width:	0.078	x2
Bridge width:	3/16	
<hr/>		
Crease cutback	0.078	
Crease cutback	0.078	

Click the mouse button to make the measurements remain on the screen. To close a single measurement dialog box, click the **Close** button in its title bar. To delete all the measurement dialog boxes, click **Delete all measures** on the status bar.

The Measure tool also functions as a tape measure. Click a point, and drag to another point; the measurement is displayed. Click the second point to make the measurement stay on the screen.

To exit the Measure tool, click **Exit Measure Tool** on the status bar.

Changing geometry

You can change geometry in many ways once it is created. For instance, you can change the type or thickness of rule used on the die, the location of a piece of geometry, and so forth. There are two ways that geometry can be changed: linearly or physically. To change a piece of geometry's linear properties means you are changing an aspect of the geometry without moving it on the die. Types of linear changes include the line type and pointage. Types of physical changes include moving geometry, copying it, stretching it, rotating it, and mirroring it.

Use the commands on the Edit and Adjust toolbars shown below to change geometry.



Select tools

The first button on the Edit toolbar activates the Select tool, and when held down, activates the Select flyout toolbar.



The Select tools are used to select objects so that they may be changed.

The first button on the Select flyout toolbar, and the default Select button on the Edit toolbar, activates the **Select** tool. Use this tool to select items in the drawing area – lines, text, dimensions, graphics, and anything else.

You can use the Select tool to move items by selecting them and dragging them to the desired position as long as the checkboxes for the objects you select are turned on in the Snap Options dialog box (click **Options > Snap**).

Hold down the CTRL key while using the Select tool to make a copy of the item(s) selected. Release the mouse button to put the copies down.

Hold down the SHIFT key to restrict the Select tool to vertical and/or horizontal movement only.

The **Select** tool has 17 modes of operation. The mode is selected by clicking the appropriate button on the Status bar.



The first button indicates normal selection mode. This mode is the default mode and is how the Select tool has worked in the past. When you select an item which is a member of a group, the entire group is selected.



The second button indicates that the Select tool will ignore groups. In this mode, if you select a member of a group, only it is selected, not all members of the group. Do not use this mode to select fills and strokes.



The third button indicates that the Select tool will select connected lines, even if they pass through intersections.



The fourth button indicates that the Select tool will select connected lines, stopping at the first intersection.

Whichever Select mode is selected in the first group of four buttons is remembered for this document in the current ArtiosCAD session.



The fifth button indicates that the Select tool will select only design lines.



The sixth button indicates that the Select tool will select only design and construction lines.



The seventh button indicates that the Select tool will select only construction lines.



The eighth button indicates that the Select tool will select only text items.



The ninth button indicates that the Select tool will select only dimensions. Note that if you change the color of a dimension, it is considered graphics, not a dimension.



The tenth button indicates that the Select tool will select only graphics.

For any of the above selection modes, if the objects being affected by the mode are turned off in the current view, activating the Select tool in that mode turns the appropriate objects on in the View Mode. For example, if dimensions are turned off in the View Mode, choosing the dimension-selecting mode turns dimensions on in the View Mode.



The eleventh button selects all items that are contained within or cross the selection rectangle or polygon. This is the default mode.



The twelfth button selects only those items with bounding boxes or clipping paths that are completely contained within the selection rectangle or polygon.



The thirteenth button lets you construct an irregularly-shaped polygon to select items. Click to set the start point, and then drag and click to make sides of the polygon. To delete the

last side of the polygon, click **Undo**  next to the tool. To complete the polygon, join the end of the last side to the start point.



The fourteenth button selects all visible objects that would be selected using the current Select mode set by buttons five through ten.



The fifteenth button turns on **Nudge with stretch** mode. More information about using nudge mode appears later in this section.



The sixteenth button turns on **Nudge by a fixed value** mode.



The seventeenth button turns on **Nudge in a direction specified by a line** mode.

You can activate more than one Nudge mode at a time by clicking the mode buttons as desired.

Select Conlines tool



The second button on the Select flyout toolbar activates the **Select Conlines** tool. Use this tool to select construction lines.

Select by Example tool

 The second button on the Edit toolbar activates the **Select by Example** tool. Use this tool to select items with the properties you define in the Select by Example dialog box.

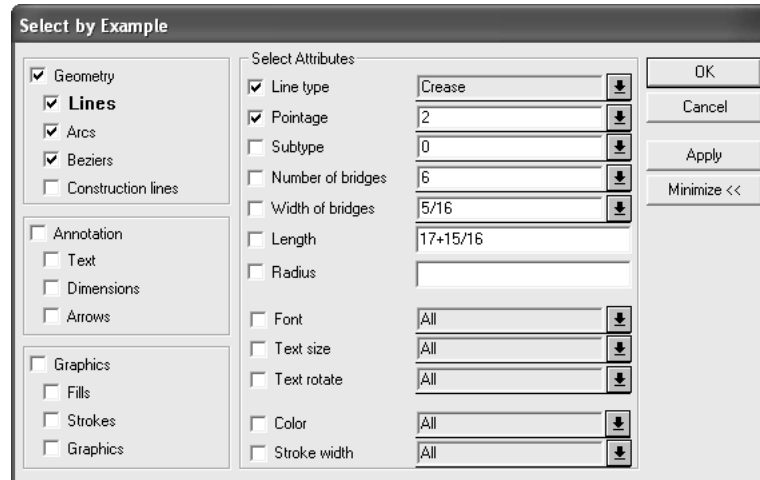

Once you have selected the attributes of the items to be selected, click **Apply** to see the results of your selection, or click **OK** to select the objects and dismiss the dialog box. When the items are selected, double-click them while still holding down SHIFT or CTRL to change their properties (or press ALT-Enter). You can also use any of the Edit tools.

Select All tool

The **Select All** tool is on the Edit menu. It selects everything in all visible layers; the items turn magenta to show they are selected. The **Select All** tool does not select items in layers that are not turned on.

To use this tool, click **Edit > Select All**.

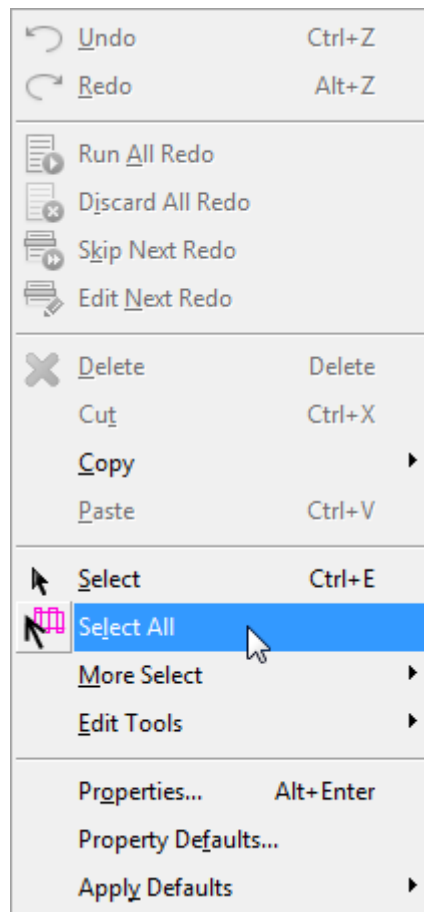

Nudge mode in the Select tool

To *nudge* is to move by a very small distance. Nudging is available in the **Select**, **Select by Example**, **Select Conlines**, **Select Oneups** and **Select Periphery Lines** tools.

There are 3 nudge modes - **Nudge with Stretch**, **Nudge by a Fixed Value**, and **Nudge in Direction Specified by a Line**. These modes allow you to nudge or stretch the selected geometry or text by very small increments using the arrow keys along with **CTRL** and **SHIFT**. ArtiosCAD shows the distance last stretched or nudged as feedback on the Status bar.

The modes may be combined as desired - they are not mutually exclusive. Each mode is explained in further detail in the following sections.

Note:

Regarding Undo and Redo, nudges are consolidated into one action. If you nudge too far, nudge back instead of using Undo. When using Nudge in Direction Specified by a Line, nudges in a direction are grouped together into one Undo action.

Default nudge distances



The table below shows how to move different distances in nudge mode. These are the default distances and can be customized as desired either system-wide in Startup Defaults or on a per-session basis by clicking **Options > Nudge**.

Press	To move in mm	To move in inches
<u>Arrow key</u>	1	1/16
<u>CTRL-arrow key</u>	5	1/2
<u>SHIFT-arrow key</u>	1/2	1/32
<u>CTRL-SHIFT-arrow key</u>	10	1

Nudge with Stretch

 The **Nudge by Stretch** mode works with a rectangle selection window. Items fully inside the selection rectangle are moved, while items crossing the border of the selection rectangle are stretched. Note that other Select tool controls affect what is selected when using a window to select items.

To use this mode, do the following:

1.  Start the **Select** tool in an open single design or manufacturing file.
2.  Click the **Nudge with stretch** button on the Status bar.
3. Click and drag a rectangle selection window around the items to nudge.

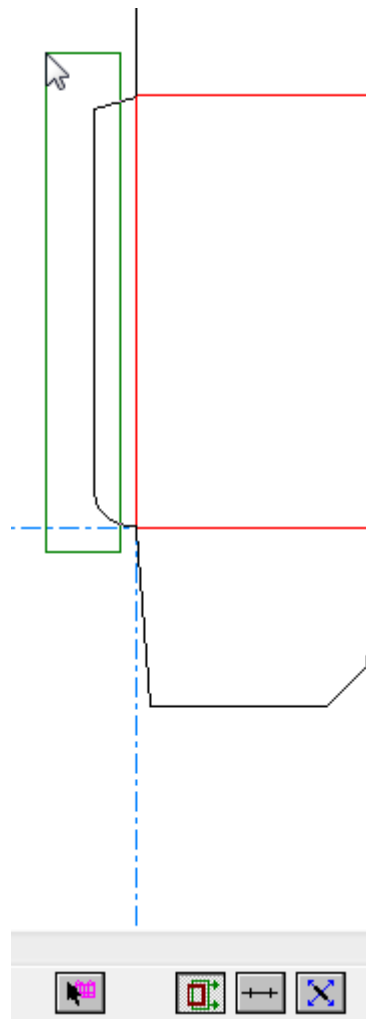

4. Use a combination of **CTRL**, **SHIFT**, and the arrow keys to nudge the selection in the desired direction. Arcs and beziers are always stretched using the distance option (as opposed to angle or radius).
5. The items remain selected for you to continue to adjust.

Shown below is the nudged glue flap with the nudge exaggerated for effect.

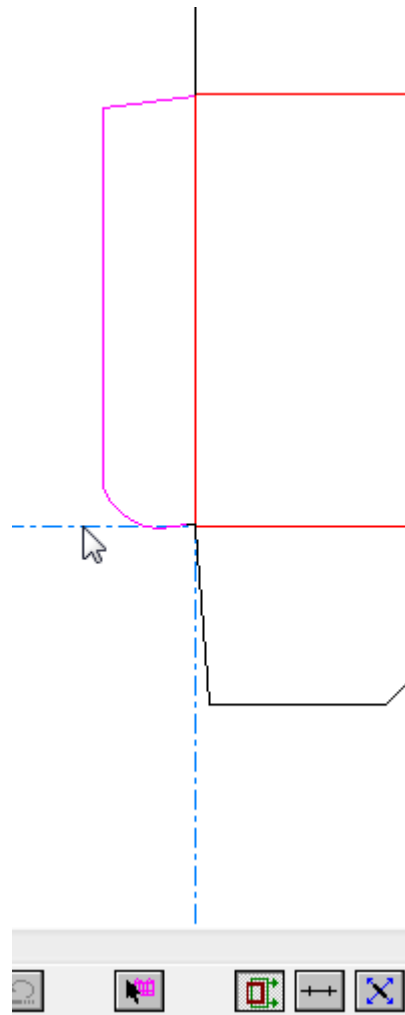

Note:
Nudge with Stretch will not move or stretch images, and will only move (not stretch) text items.

Note:
Nudge with Stretch cannot be used immediately after an Undo or Redo, as Undo and Redo clear the current selection and restart the Select tool.



Note:
 When Nudge with Stretch cannot be used, such as when the Select tool is restarted while there is a current selection, a do-not-use symbol (circle with a slash through it) appears on its button and the nudge will move the selection rather than stretching it.

Note:
This mode is not available in the **Select Online**, **Select by Example**, and **Select Oneup** tools.

Nudge by a Fixed Value

 The **Nudge by a Fixed Value** mode works with the current selection and moves the selected items by a fixed distance depending on the keys you press. It is similar to the nudge functionality in previous versions of ArtiosCAD. Refer to the *Default nudge distances* section for more information on distances and modifier keys.



To use this mode, do the following:

1.  Start the **Select** tool in an open single design or manufacturing file.
2. Select the items to nudge.
3.  Click the **Nudge by a Fixed Value** mode selector on the Status bar. If you hover over the button, ArtiosCAD shows the current nudge distances in a message on the Status bar.
4. Use a combination of **CTRL**, **SHIFT**, and the arrow keys to nudge the selection in the desired direction. Arcs and beziers are always stretched using the distance option (as opposed to angle or radius).
5. The items remain selected for you to continue to adjust.

Nudge in Direction Specified by a Line

 The **Nudge in Direction Specified by a Line** mode nudges the current selection in a direction at 90 degrees (or a multiplier of 90 degrees) to a line. When you hover over a line in this mode, the drag changes to a four-direction display of arrows with a large arrow indicating the nudge direction of the up arrow key.

To use this mode, do the following:

1.  Start the **Select** tool in an open single design or manufacturing file.
2. Select the items to nudge.
3.  Click the **Nudge in Direction Specified by a Line** mode selector on the Status bar.
4. Hover over the line to use to set the direction of the nudge. The drag will change to 4 arrows as shown below.

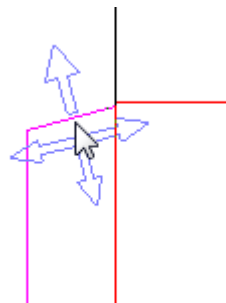

5. Use a combination of **CTRL**, **SHIFT**, and the arrow keys to nudge the selection in the desired direction. Arcs and beziers are always stretched using the distance option (as opposed to angle or radius).

6. The items remain selected for you to continue to adjust.

Note:

This nudge mode always uses the current angle of a line. Unanticipated results might occur when you use this tool on a parametric line in a resizable design.

Nudge Options and Defaults

Click **Options > Nudge** to set the active nudge modes per session and the distances they use. This command is available when a single design or a manufacturing file is open. Essentially the same dialog box is used in Defaults in **Startup defaults > Nudge options**.

Shown below is the **Nudge options** dialog box.

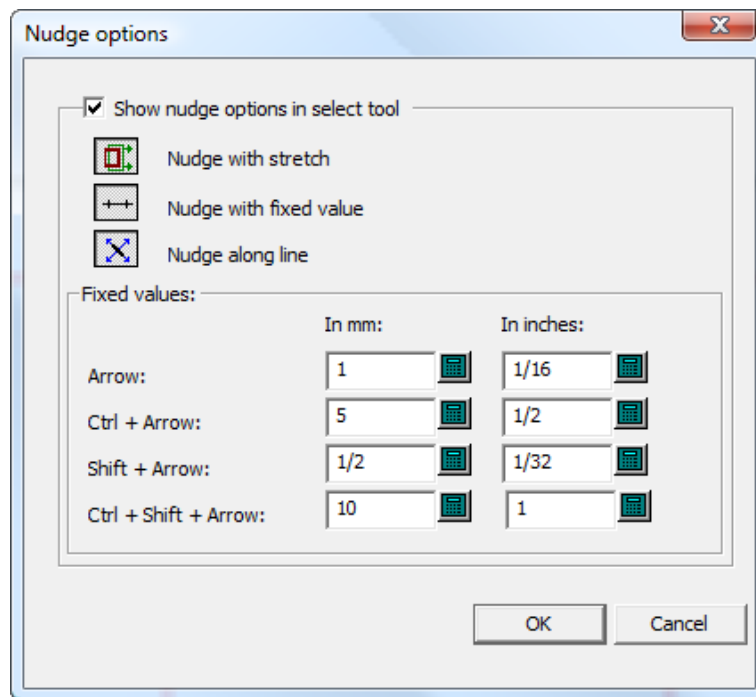

Show nudge options in select tool controls the availability of the nudge modes. When it is selected, they are active. When it is cleared, nudge moves by a pixel.

Set the three mode selectors as desired. They determine which nudge modes are active when a tool which supports nudge is started.

The values in the **Fixed values** group control the distance used by the Nudge by a Fixed Value mode. Set them as desired.

Note:

If you change the nudge options or Defaults while a Select tool is active, the tool will be restarted to update it and the current selection will be lost.

Changing linear properties

Linear properties are those properties of objects that are not related to their physical placement.

Changing line type and pointage

To change the line type and pointage, activate the **Select** tool and double-click the object to change. To select more than one object at a time, hold down SHIFT while selecting objects, and double-click the last object. The Properties dialog box will appear.

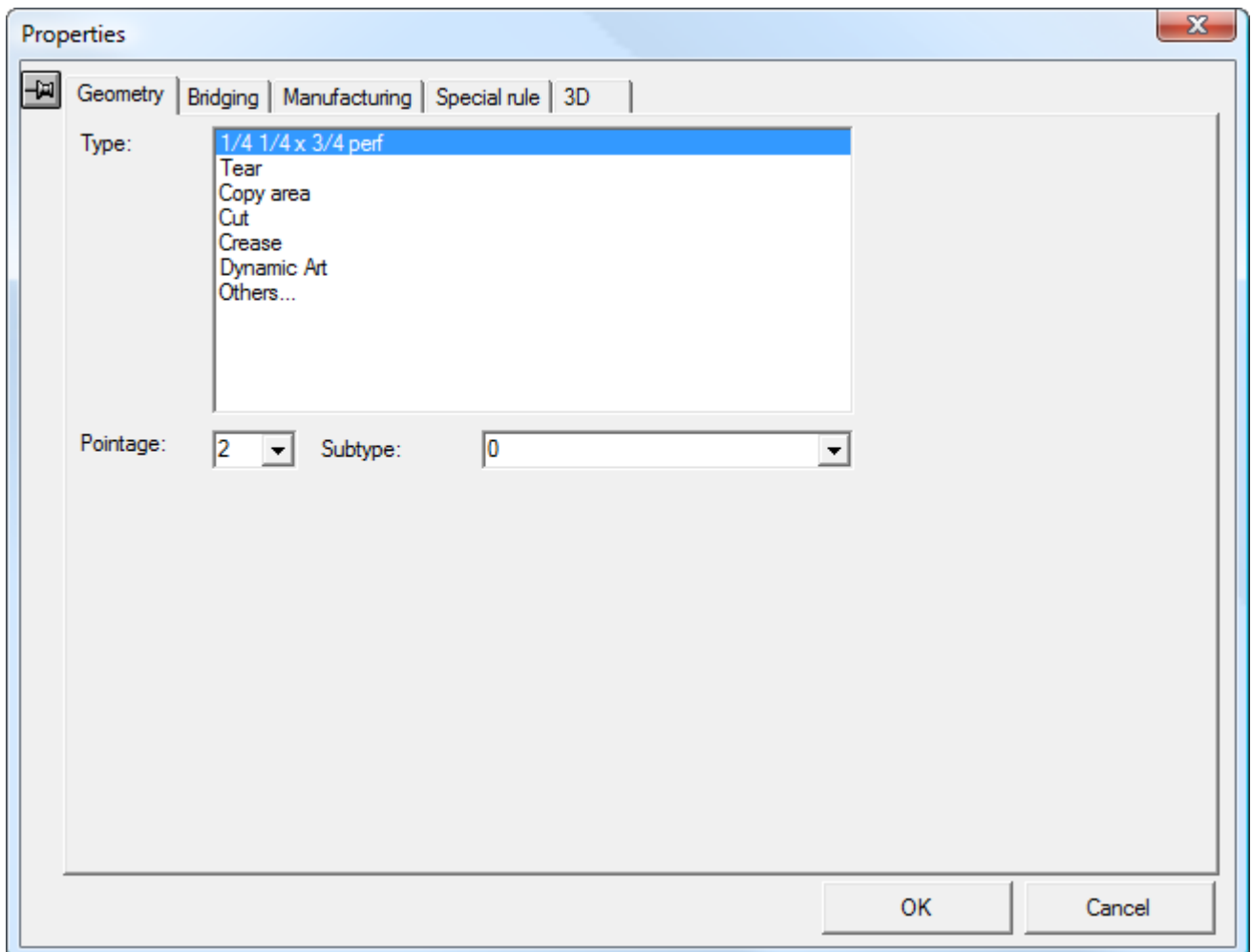

On the Geometry tab of the Properties dialog box, you can change the type of a line, its pointage, and its subtype. You can change other properties on additional tabs if they are available.

Lines which are already used in the workspace are listed in the **Type:** group. Clicking **Others...** in the **Type:** group opens the Set Current Line Type dialog box, which lets you change to a line type which is not listed in the **Type:** group.

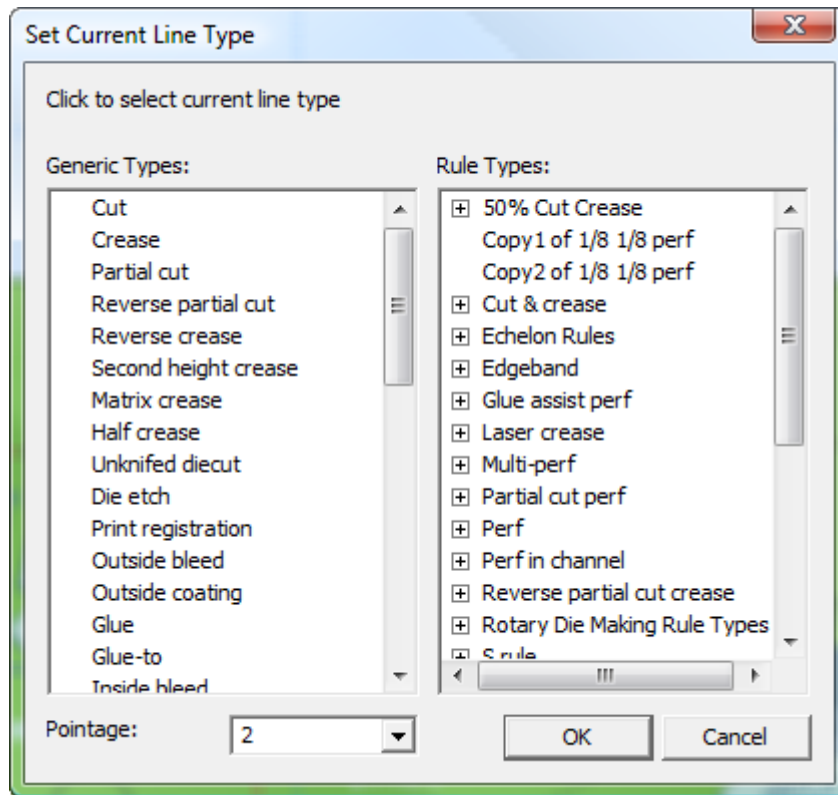

If the name of the line type contains **Inside** or **Outside**, use it in a corresponding **Inside** or **Outside** layer class. **Inside** types and classes are used on the unprinted side of a design, while **Outside** types and classes are used on the printed side.

Once you have chosen a new line type in this dialog box, click **OK** to set it, or **Cancel** to ignore your selection. Either click will return to the Properties dialog box.

After making the desired property changes, click **OK** to apply the changes or **Cancel** to discard them.

Foldable line type properties in Single Design

The 3D tab in the Properties dialog box in Single Design lets you choose how the current selection behaves in 3D. Foldable lines are:

- Crease
- Second-height crease
- Matrix crease
- Reverse crease
- Partial cut
- Reverse partial cut
- Perf
- Cut-crease
- Partial cut-crease.

- Nicked cut lines (that behave like perf).

When you double-click one of these types of lines, set the how the line will behave in 3D on the **3D** tab of the **Properties** dialog box.

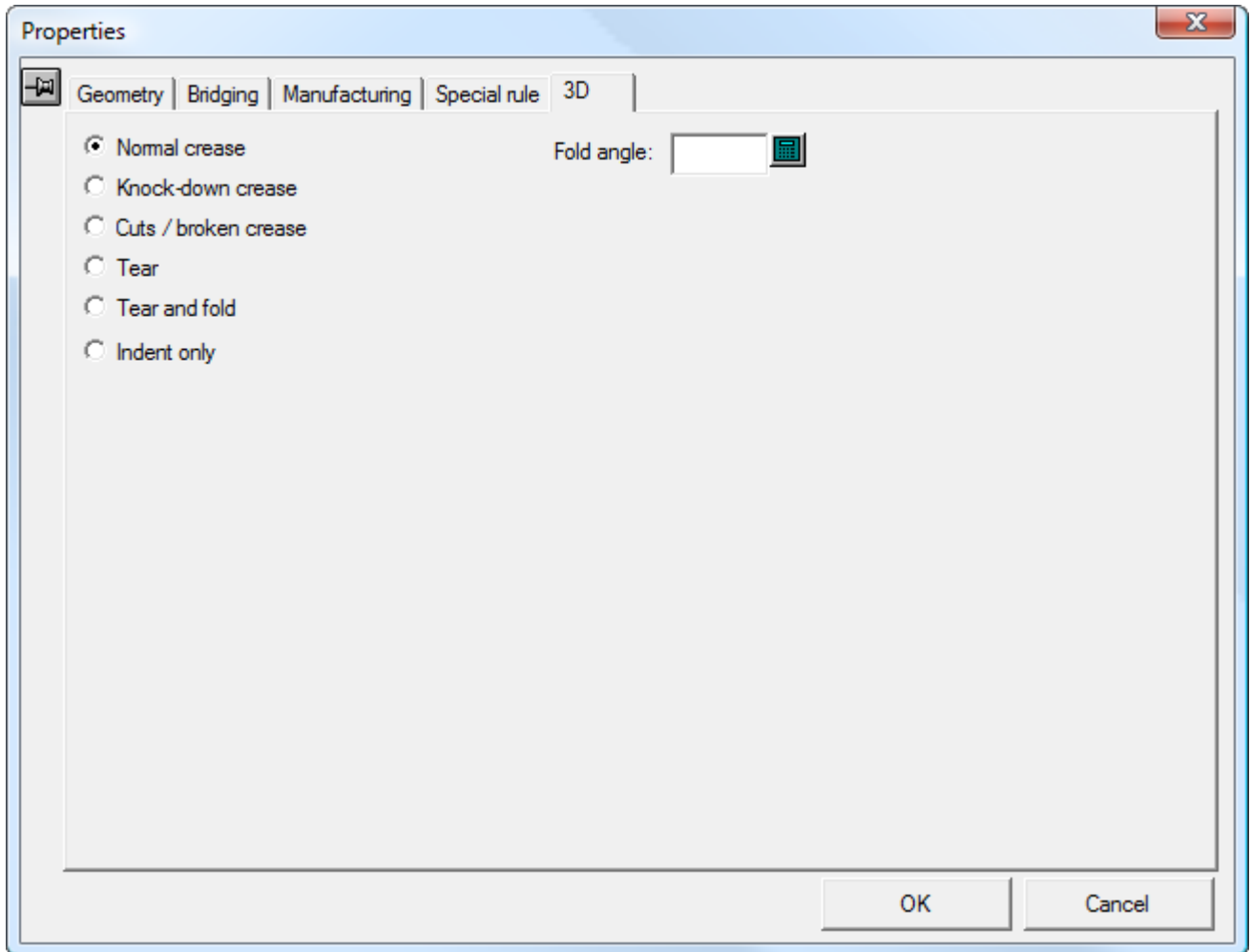

Normal creases fold or bend in 3D as they should.

Knock-down creases are creases that are only used for shipping the carton, and are not part of the structural integrity of the carton. They are shown as indentations in 3D.

Cuts / broken creases appear and function as cuts. These are used where creases meet at a point and ArtiosCAD does not know how to set all the fold angles correctly so that they meet. In the example below, set one of the three creases at the corner to be a broken crease.

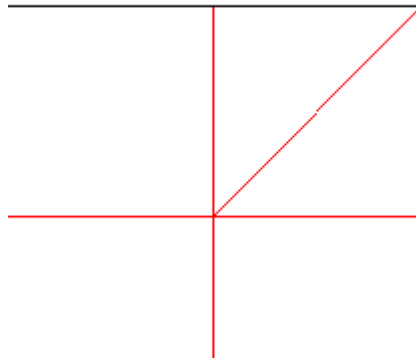

Tears are creases, special rules, or nicked lines that tear. If you have a shape in a panel that is nicked, it shows as indented.

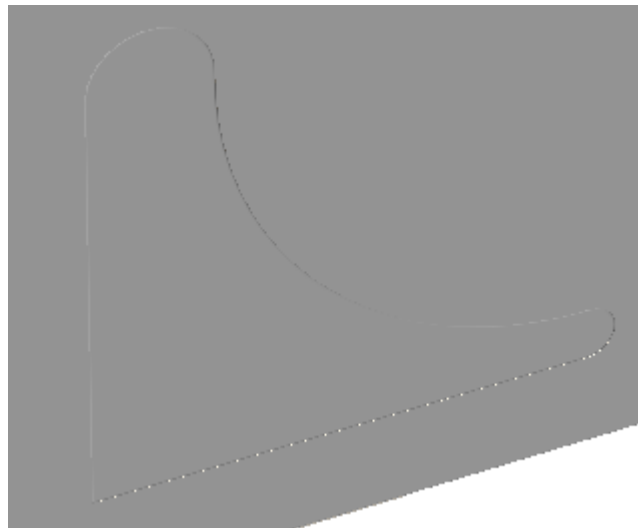

Then use **Select Tear-Away Part** in 3D to select it and **Move Designs** to tear it away.

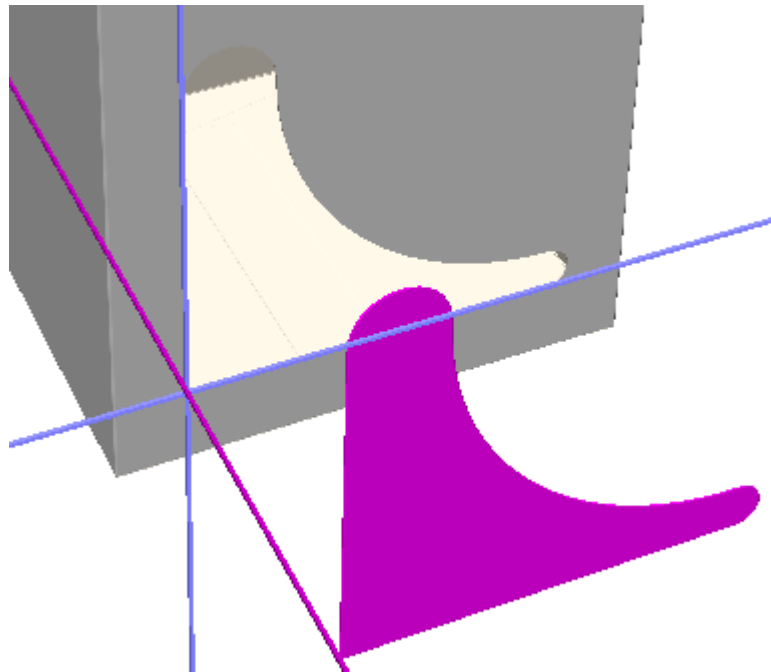

Tear and fold special rules both tear and fold. Note that curved creases can either tear or fold, but not both.

Indent only perms make an indentation on the panel but do not fold or tear.

You may also set or change the **Fold angle** of this line in 3D in this dialog box.

Click **OK** to change the properties of the line and return to ArtiosCAD.

Notes about special rules

Special rules are rules which have specific manufacturing attributes, such as 5mm Zig Zag Left rules or ½ inch Echelon Right rules. Their definition is explained in more detail in the *Defaults* chapter.

Different special rules are treated as one rule on output if they are end to end, and there are no end points of other lines within 1/32 inch of the join, and the lines are within 18 degrees of tangential at the join.

To treat such special rules as separate lines, split any lines that intersect them at the intersection point.

The **Expand Special Rules** command on the **Tools > Adjust** menu separates connected special rules into individual lines and arcs.

You can rename a special rule by clicking **Rename** on the Special rules tab of the Properties dialog box.

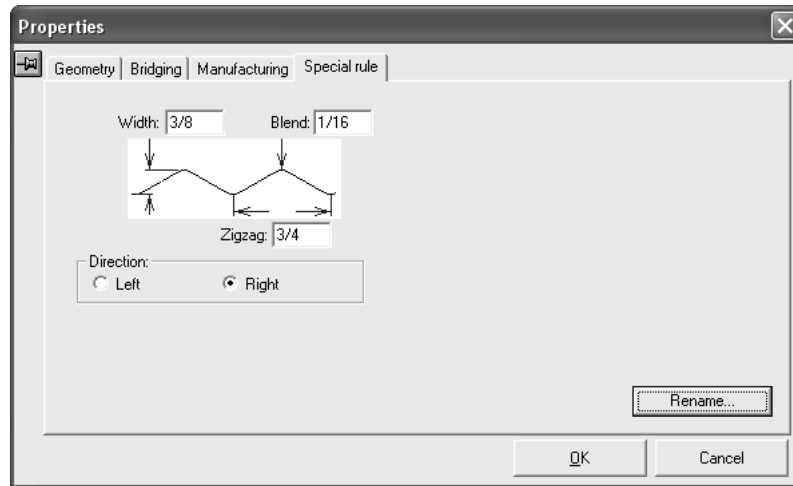

When a design containing the same name for differently-defined special rules is opened, the duplicate special rule name will be changed to COPY<number> of <special rule name>, such as **Copy1 of 3mm x 3mm perf.**

Changing Bridging properties

Shown below is the **Bridging** tab in the Properties dialog box when geometry is selected in Single Design. It shows information not only for bridges, but also for nicks and crease cutbacks. The contents vary depending on the geometry you have selected.

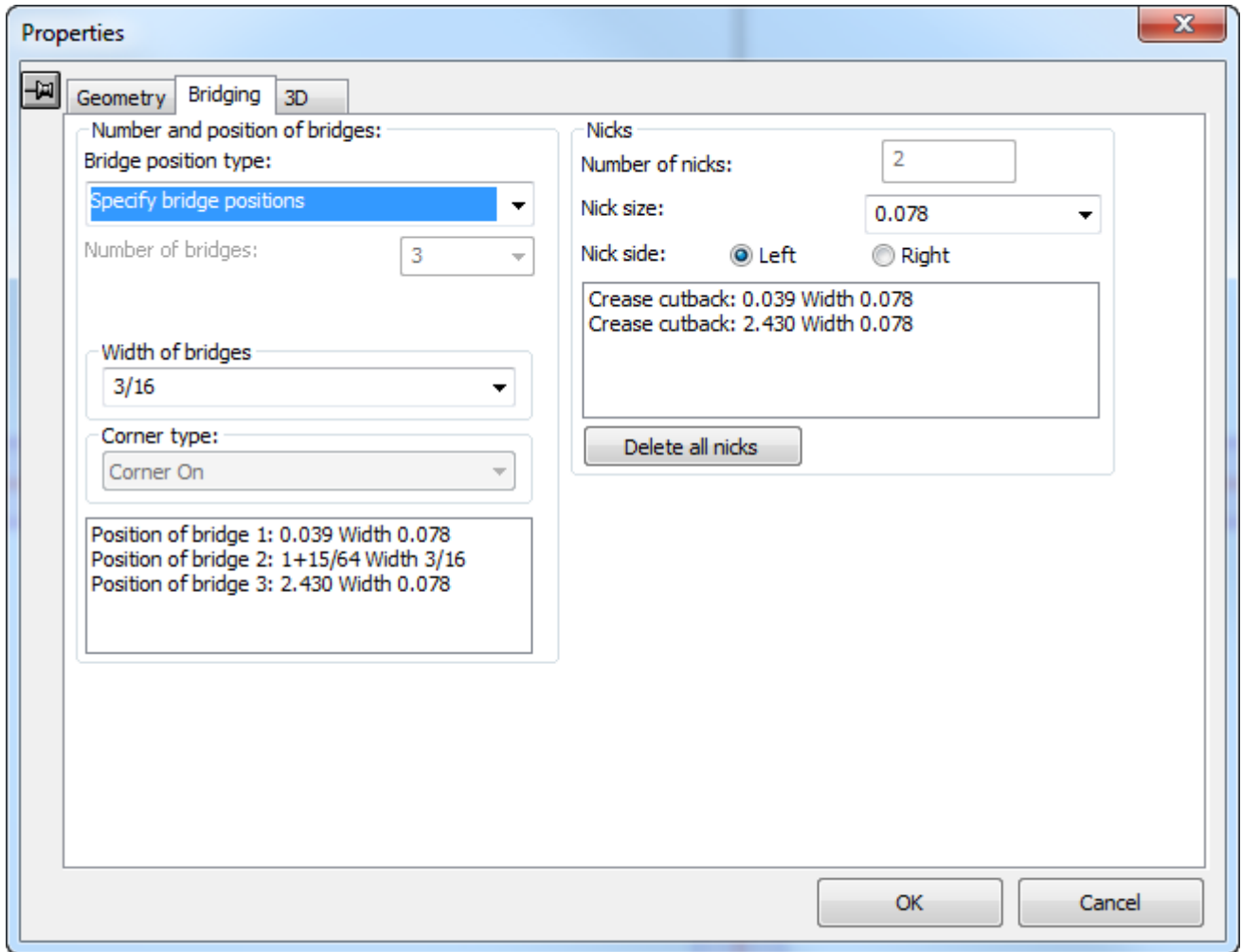

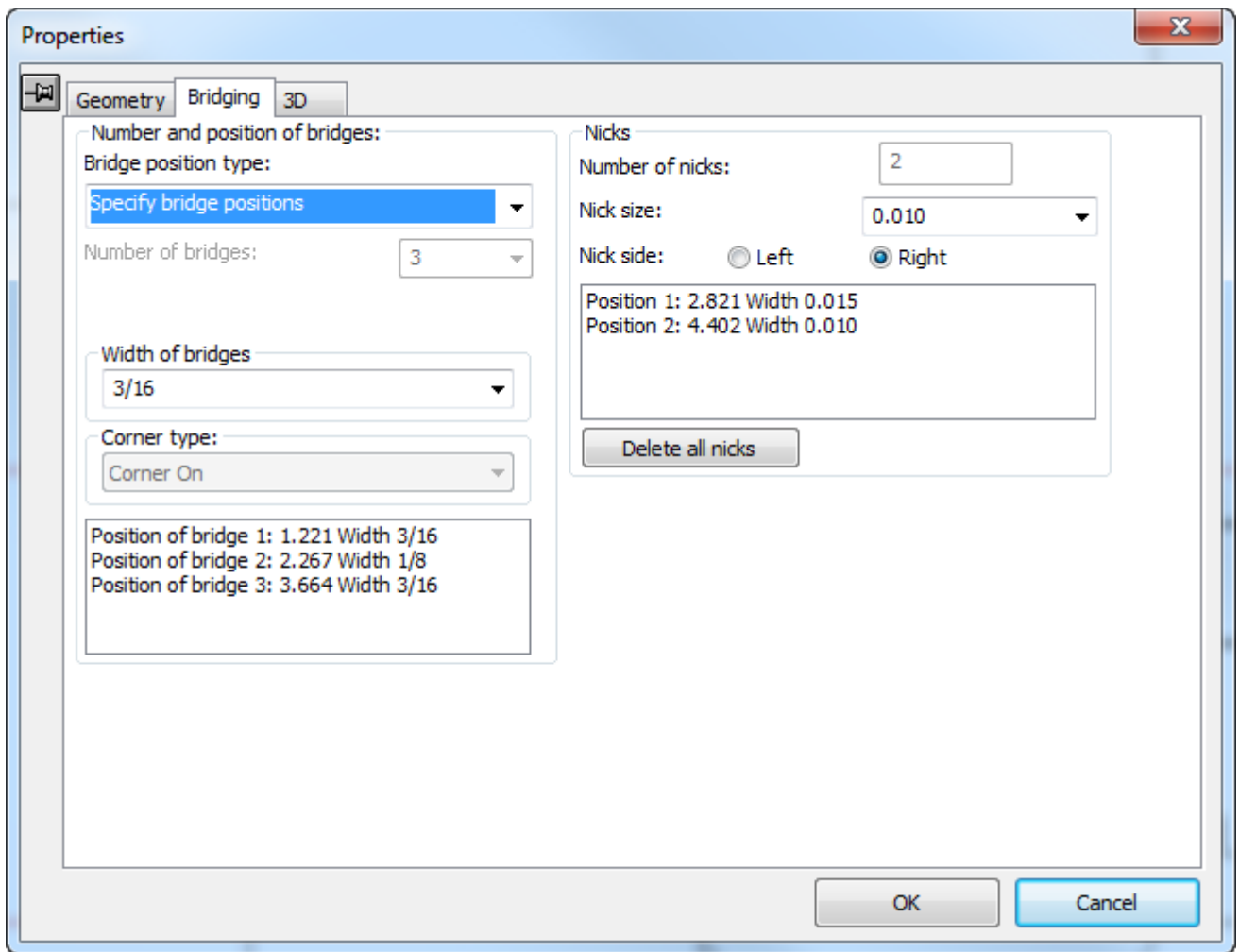

Number and position of bridges

The **Bridge position type** drop down list box displays the following choices for automatic bridging:

- No bridges
- Evenly spaced
- Inset distance from line end
- Specify bridge positions
- Default bridges
- Default with at least 1
- Select bridge formula
- Bridge at rule start
- Bridge at rule end
- Bridge at both ends

No bridges removes all automatically-placed bridges from the selected geometry.

Evenly spaced positions up to 100 bridges evenly along a line.

Inset distance from line end specifies the distance of a pair of bridges from each end of the line. If the line requires more than two bridges, they are evenly spaced between the two inset bridges.

Specify bridge positions shows the position of up to 100 pre-existing bridges on a line.

Default bridges regenerates the bridges of the selected geometry based on the current default bridging formula.

Default with at least 1 is used in the construction of a standard when the size of the line in the final design is not known but requires at least one bridge.

Select bridge formula lets you choose the bridging formula to apply to the selected geometry. The current bridging formula is selected by default.

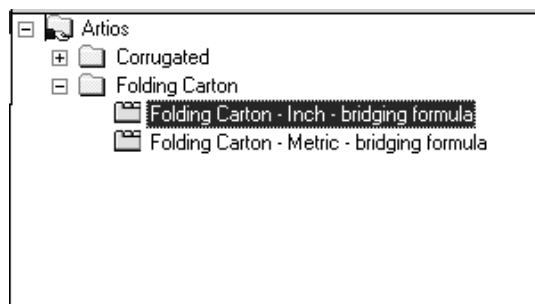

Bridge at rule start adds a bridge at the start of each selected line and removes all other bridges in the selected geometry.

Bridge at rule end adds a bridge at the end of each selected piece of geometry and deletes all the other bridges in the selected geometry.

Bridge at both ends places a bridge at both ends of each line in the selected geometry.

Bridge at rule start, **Bridge at rule end**, and **Bridge at both ends** places one or two bridges at the half bridge with from either end of the line. That is, ArtiosCAD indents a half bridge width from the end of the line and then places the bridge.

Changing the number of bridges

The **Number of bridges:** field and drop-down list box let you manually specify the number of bridges to assign to the selected geometry.

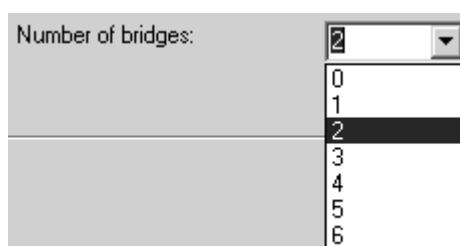

You can also type an integer in the field if the desired value is not shown.

Changing the width of bridges

The **Width of bridges:** field and drop-down list box shows the width of bridges in the currently-selected geometry and allows the selection of a new width.

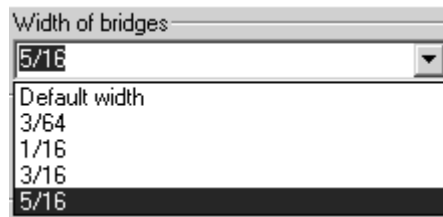

The **Default width** is the width defined by the current bridging formula. The other choices on the list are the widths of other bridges in the design. You may type a new bridge width in the field.

If a line needs to have bridges of different widths on it, simply add bridges of another size.

Note: If you use two or more different bridge sizes on the same line and will be sending this workspace to someone using a pre-12.1 version of ArtiosCAD, you must export it as an ArtiosCAD 12.x workspace using **File > Export > ArtiosCAD 12.x**.

Changing the bridging for arc corners

The **Corner type** drop-down list box controls the behavior of bridging in corners made by an arc. **Corner Off** specifies that the arc is unaffected. **Corner On** specifies that the corner will be squared and cut by an additional line.

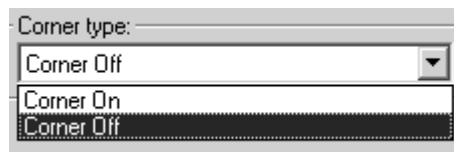

Shown below is an arc with **Corner Off**, and below that is **Corner On**.

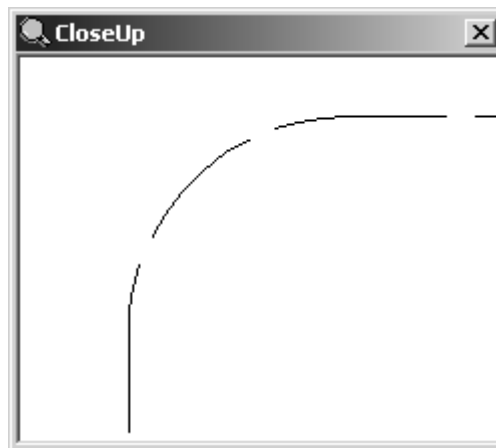

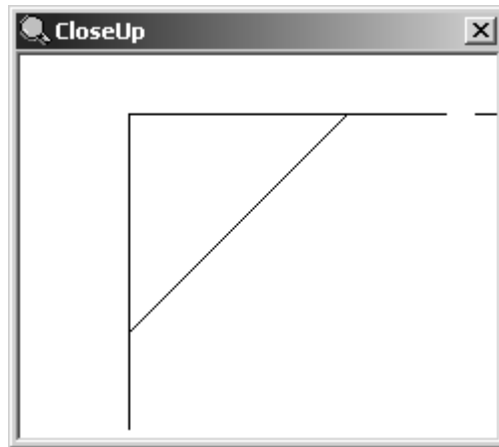



Changing the current bridging formula

To change the current bridging formula, click **Options** > **Change Bridge Formula**.

Blend tool

 A *blend* is an arc connecting two lines. Blends are used to round corners. They can be used on any non-parallel lines - if the lines don't share an endpoint, they will both be extended to a point where they can be blended. The **Blend** tool is the first button on the Adjust toolbar. It prompts for the radius of the blend, and then prompts you to click the two lines forming the corner to be rounded. Corners can be rounded as long as this tool is active.

Chamfer tool

 The **Chamfer** tool is the second button on the Blend tools flyout toolbar. **Chamfers** are bevelled corners. The Blend tools flyout toolbar is shown below.



The Chamfer tool has three modes of operation, each controlled by a button on the Status bar. The availability of the fields on the Status bar is controlled by the current mode selection button.





 The first button on the Status bar turns on **Chamfer Equal Distances** mode. This causes the Chamfer tool to cut each line of the corner back the same distance and then connect them to form the chamfer. To use the Chamfer tool in this mode, do the following:

-  Click the **Chamfer** tool. The Chamfer Equal Distance mode selection button is selected by default.

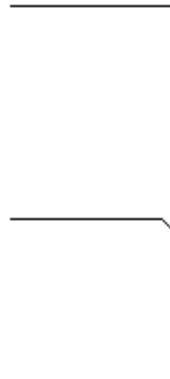
2. Enter the length of the cutback in the **Length along first line:** field, for example ¼ inch or 6 mm.
3. Click the first line that forms the corner to be chamfered. It will turn magenta to indicate it is selected.
4. Click the second line that forms the corner to be chamfered. The chamfer will be made. Shown below is a corner before creating a ¼ inch chamfer and then the same corner after chamfering.



 The second button on the Status bar turns on **Chamfer 2 Distances** mode. This causes the Chamfer tool to cut each line of the corner back a different distance and then connect them to form the chamfer. To use the Chamfer tool in this mode, do the following:

1.   Click the **Chamfer** tool, and then click the **Chamfer 2 Distances** mode selection button on the Status bar
2. Enter the length of the first line's cutback in the **Length along first line:** field, and enter the amount of cutback for the second line in the **Length along second line:** field, for example 12 mm for the first and 9 mm for the second.
3. Click the first line that forms the corner to be chamfered. It will turn magenta to indicate it is selected.
4. Click the second line forming the corner to be chamfered. The chamfer will be made. Shown below is a chamfer 12 mm cut back on the first line and cut back 9 mm on the second.

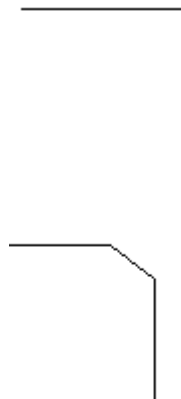

 The third button on the Status bar turns on **Chamfer Distance/Angle** mode. This causes the Chamfer tool to cut back a set distance along the first line of a corner and then make a

line at the specified angle to meet the second line of the corner, thereby creating the bevelled edge. To use the Chamfer tool in this mode, do the following:

1.  Click the **Chamfer** tool, and then click the **Chamfer Distance/Angle** mode selection button on the Status bar.
2. Enter the length of the first line's cutback in the **Length along first line:** field, and enter the angle for the chamfer in the **Angle to first line:** field, for example 12 mm for the cutback and 70 for the angle.
3. Click the first line that forms the corner to be chamfered. It will turn magenta to show it is selected.
4. Click the second line forming the corner to be chamfered. The chamfer will be made. Shown below is a chamfer 12 mm cut back and at 70 degrees.

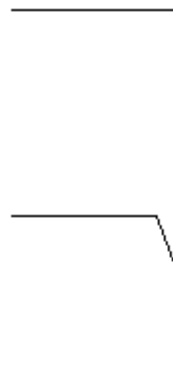

Blend 3 Lines tool

 The **Blend 3 Lines** tool is the third button on the Blend tools flyout toolbar. Use it to blend 3 lines or arcs together; the geometry does not have to touch. The middle line or arc is changed to a blend and the end lines or arcs are shortened to meet the blend. ArtiosCAD determines the needed radii settings automatically. If the lines or arcs are not able to be blended, ArtiosCAD displays a message that line construction is not possible.

Shown below is an example of some geometry before it is blended:

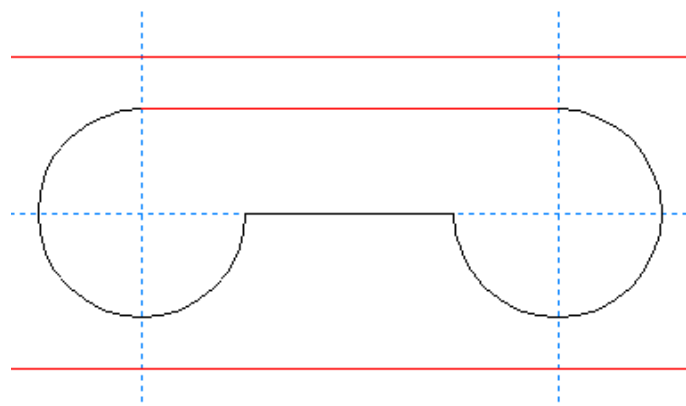

Using the tool to select the arcs and lines to be blended:

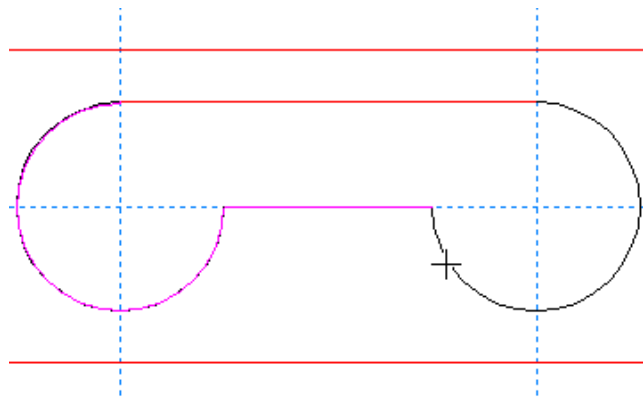

The third click creates the blend:

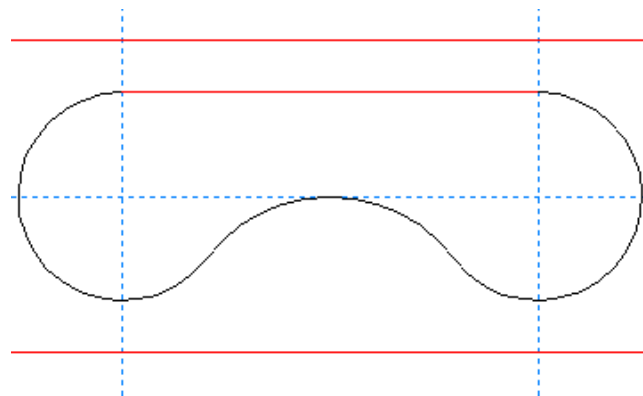

Split line at point

 The second button on the Adjust toolbar activates the **Split Line** tool. This tool divides a line into two lines anywhere along the line where you click the mouse. Activate the tool, click the line to split, and then click the split point. The **Direction** view mode is automatically turned on when you select this tool, and automatically turned off when you select a different tool. This tool behaves as if the **Freehand Coordinates** checkbox in the Snap Options dialog box is turned on.

The picture below shows a circle after being split into 3 arcs. There are now 3 points and 3 direction indicators.

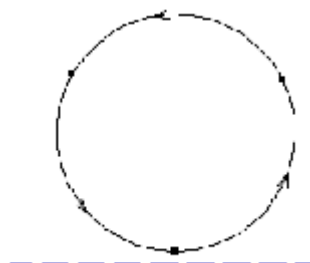

Trim/Extend tools

✕ The third button on the Adjust toolbar activates the Trim/Extend Two Lines tool, and when held down, activates the Trim/Extend flyout toolbar.

✕ The first tool on the Trim/Extend flyout toolbar, and the default Trim/Extend tools button on the Adjust toolbar, is the **Trim/Extend Two Lines** tool. It makes two lines that are not parallel extend to meet each other. It also makes one line that intersects another end at the intersection. When clicked, this tool prompts for the first line to extend, and then prompts for the second line to extend. Arcs may be trimmed against as well.

An example of trimming two lines:

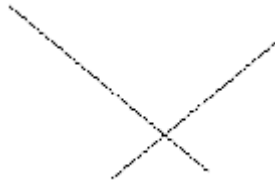

After using the Trim/Extend Two Lines tool:



When trimming two lines against each other, select the portions of the lines to keep.

An example of extending two lines:



After using the Trim/Extend Two Lines tool:



✕ The second tool on the Trim/Extend flyout toolbar activates the **Trim/Extend One Line** tool. This tool works the same way as the Trim/Extend Two Lines tool, except it only trims or extends one line.

 The third tool on the Trim/Extend flyout toolbar activates the **Trim Interior** tool. This tool trims a segment of a line, arc, or bezier which intersects with at least one other item. It trims along the item you click in both directions. If only one intersection is found, the item is trimmed back to that intersection. If an intersection is found in both directions, the segment between the intersections is deleted. The resulting lines are rebridged using the default bridging formula. This tool works for lines, arcs, and beziers.

To use this tool, click it, and then click the segment to delete.

Shown below is a construction before using the Trim Interior tool.

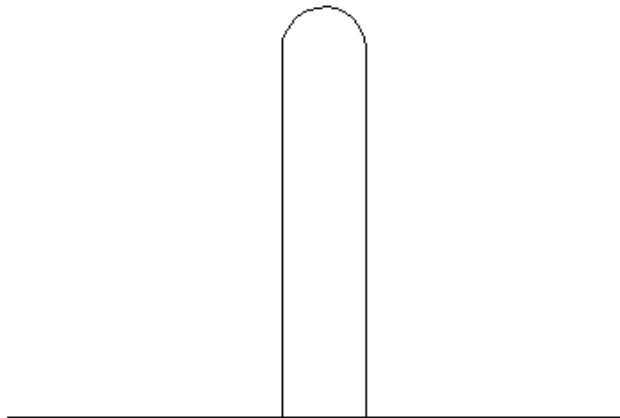

The Trim Interior tool is used to remove the segment at the slot opening in the picture shown below.

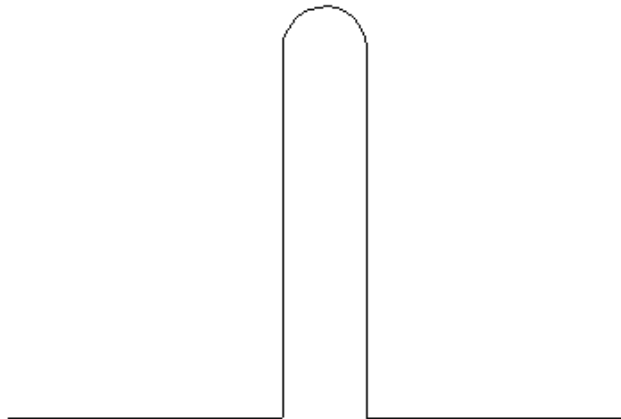

 The fourth tool on the Trim/Extend flyout toolbar is the **Trim Against Selection** tool. This tool trims or extends multiple lines against the current selection at the same time. You must select at least one line, arc, or bezier before starting this tool. This selection is called the *trim against* selection.

This tool now has two modes: *Limited* mode and *Full* mode. The mode is determined by how the lines trimmed against or extended to are connected. If the lines are connected so that there is a two-sided path, the tool can operate in Full mode, and all commands on the Status bar are available:

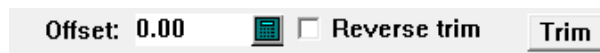



If the trim-against lines are not connected, or are connected or intersect in such a way that ArtiosCAD cannot follow them and clearly identify which side is which, the tool operates in Limited mode, and no commands on the Status bar are available. This functionality is equivalent to how the tool worked in previous versions.

There are a few considerations to keep in mind when using this tool:

- Only lines and arcs are extended. Beziers cannot be extended because it takes more information than is available to define their curves precisely.
- Items are trimmed to meet the *trim against* selection.
- The **Reverse trim** checkbox is available only when an item to be trimmed or extended crosses the *trim against* selection.
- If an item cannot be trimmed or extended to meet the *trim against* selection, it is not deleted.
- Right-clicking the mouse stops the tool and resets the current selection.

To use the **Trim Against Selection** tool in Limited mode, do the following:

1.  Use the **Select** tool to select the lines, arcs, or beziers to trim against.
2.  Click **Trim Against Selection**. The message in the Status bar should indicate that the *trim against* lines do not form one continuous path.
3. Click the object to trim on the part that you want to keep.
4. ArtiosCAD trims the object against the trim selection.

If you have selected a two-sided path of lines, arcs, or beziers, when you start the **Trim Against Selection** tool, it starts in Full mode with the controls on the Status bar enabled.

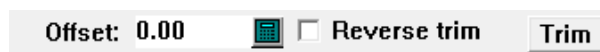

The **Offset:** field lets you specify a distance from the *trim against* lines that the lines will be trimmed back or extended past instead of being trimmed or extended flush with the *trim against* lines. When you specify an Offset, a red path appears at the designated distance next to the trim-against lines indicating where items will be trimmed or extended.

Reverse trim toggles the side of the selected the items to trim or extend. The parts to be kept are highlighted magenta, while the parts to be trimmed are turned grey.

Note:

Reversing the trim does NOT change the offset, however! The selected items still meet the same offset line. You must change the side on which you are selecting the items in order to change the offset line they meet.

Trim performs the trim or extend.

When you start the tool, select the items to be trimmed or extended. Select multiple items by holding down SHIFT while clicking, or you can make a window selection by clicking in empty space and dragging the opposite corner of the rectangle; everything touching a border of the

rectangle is selected. Where you select objects determines which parts are kept. Where you release the mouse button determines the position for all the selected items.

Shown below is an example of trimming lines inside a polygon with an offset.

1.  Use the **Select** tool to select the trim-against lines. These lines are connected and form a two-sided path, so the **Trim Against Selection** tool can use Full mode.

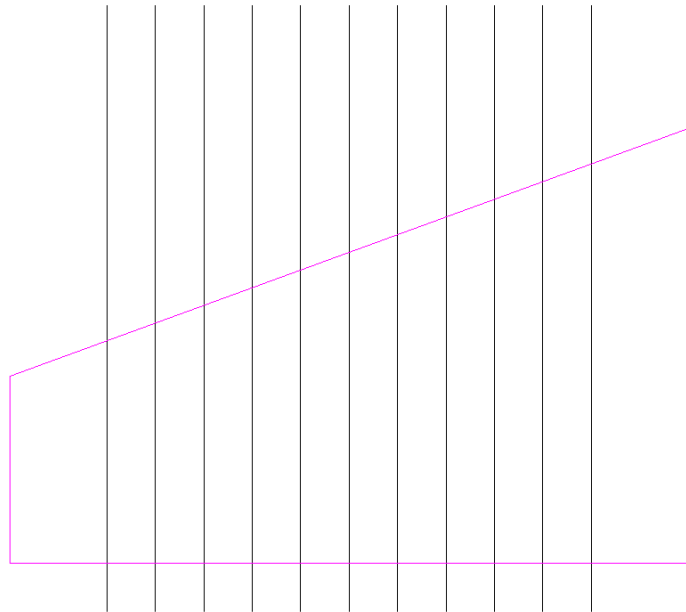

2.  Click **Trim Against Selection**.
3. Set an offset of 5 mm in the **Offset:** field on the Status bar.
4. Use a window selection to select the lines inside the polygon. Once the lines are selected, the red offset border appears, the lines to be kept turn magenta, and the lines to be trimmed turn grey.

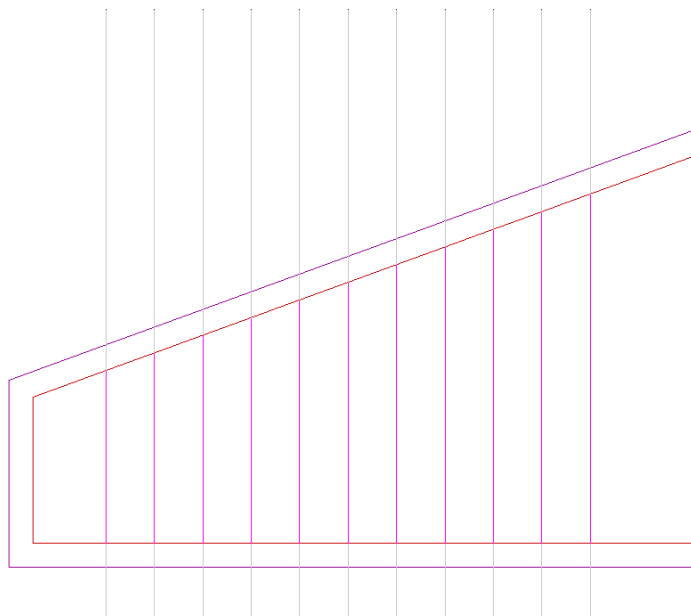
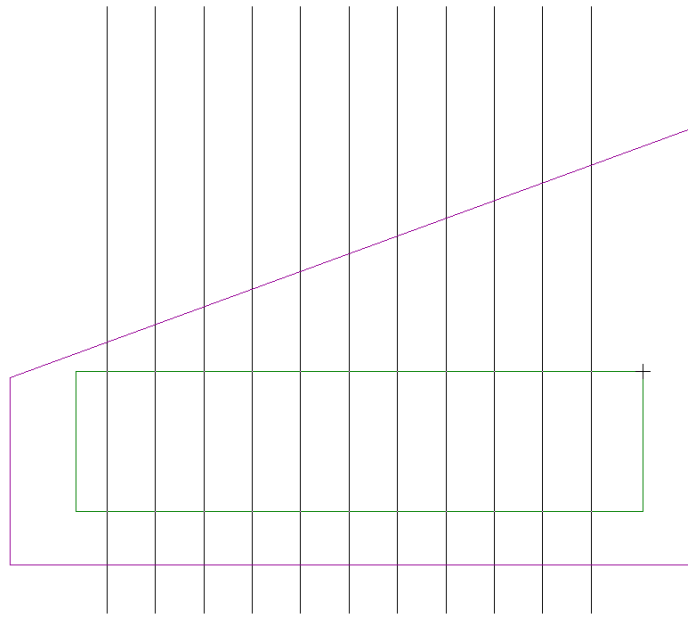

5. Click **Trim** to trim the lines.

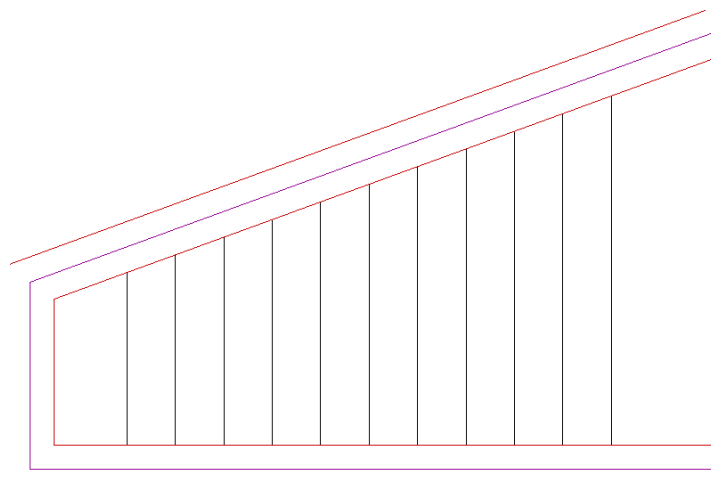

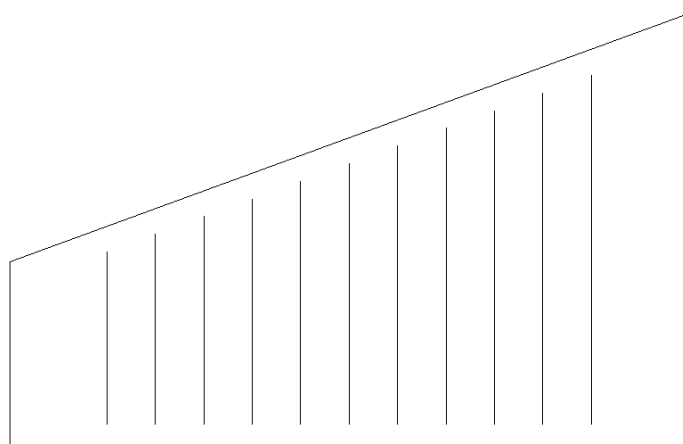

6. The tool remains active. Right-click the mouse to end it and see the result of trimming the lines.

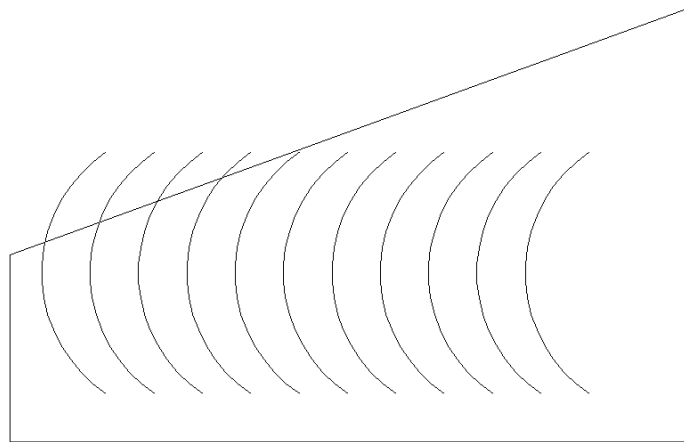

 **Trim Against Selection**, in Full mode, can also extend lines and arcs as well as trimming lines, arcs, and beziers. Shown below is an example of how it can trim and extend arcs at the same time.

1. Shown below is the geometry before it is changed.



2.  Use the **Select** tool to select the lines forming the polygon to be the *trim-against* lines.
3.  Click **Trim Against Selection**.
4. Use a window to select all the arcs inside the polygon.

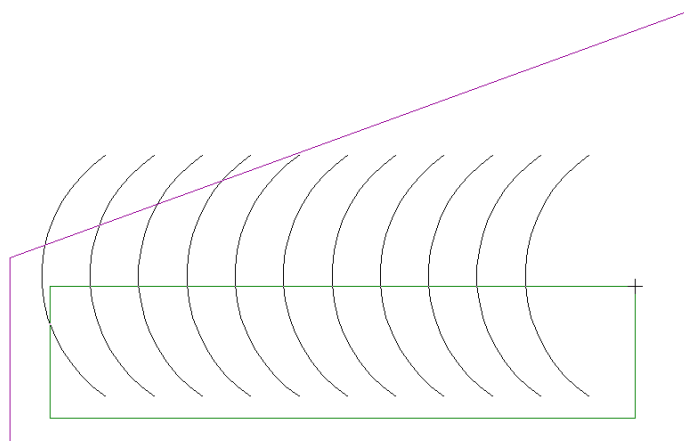

5. The parts to be trimmed turn grey, and the parts to be extended turn magenta. Note how some arcs stay the same; they are neither trimmed nor extended because before trimming, they do not touch one of the *trim-against* lines, and after extending, they still would not touch one of the *trim-against* lines.

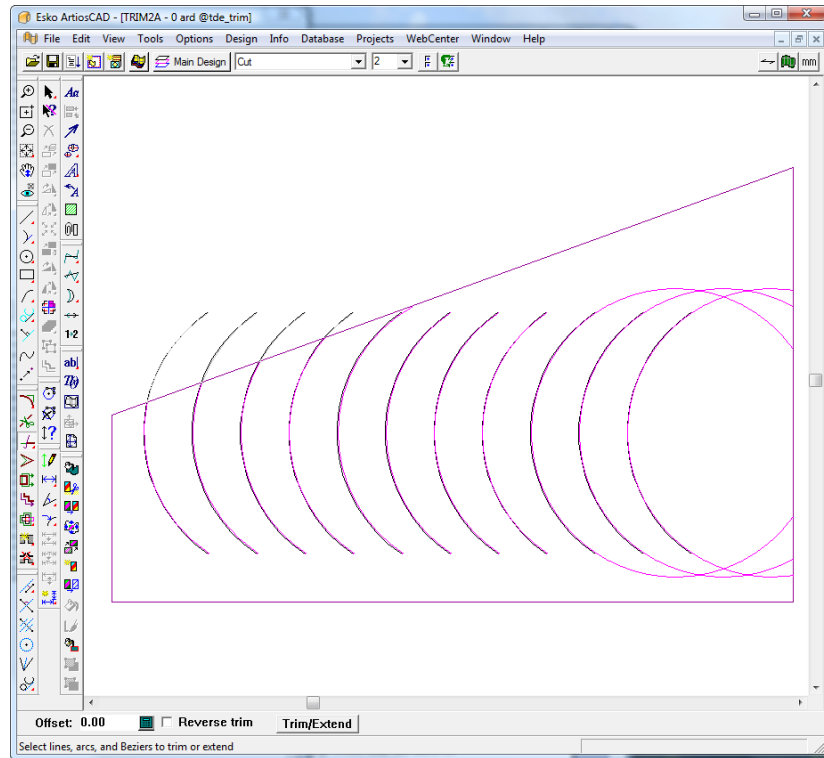

6. Click **Trim/Extend** to trim and extend the arcs.
7. Right-click the mouse to end the tool and see the results.

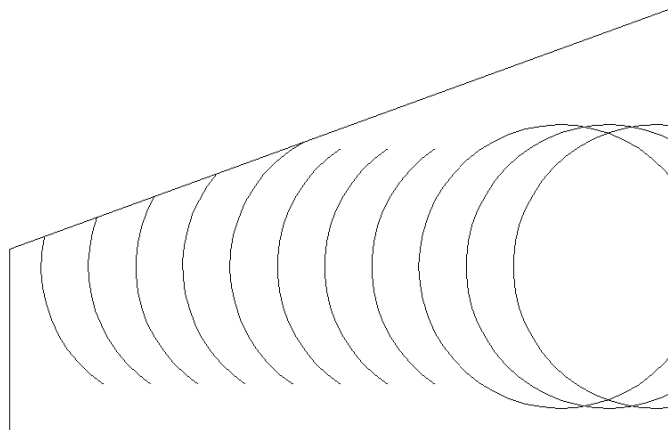

 The fifth tool on the Trim/Extend flyout toolbar is the **Extend Line** tool. This tool extends the current line or arc by a given distance. Specify a negative length in order to trim the line or arc.

The following options are on the Status bar when this tool is active:

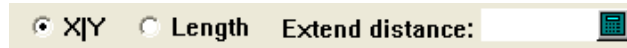

The **X|Y** option button extends the line or arc in either the X or Y axis depending on whether the geometry is closer to being horizontal or closer to being vertical.

Length extends the object by the length in the **Extend distance:** field.

To use this tool, do the following:

1.  Click the **Extend Line** tool.
2. On the Status bar, choose either the **X|Y** option or the **Length** option.
3. Enter a value in the **Extend distance:** field. (Enter a negative value to perform a trim.)
4. Click near the end of the item to change.
5. The item is extended or trimmed.

Note: ArtiosCAD reduces the number of bridges on the object as needed if they do not fit. If you specify a larger negative value than the length or radius of the line or arc, ArtiosCAD creates a zero-length line or arc. You cannot extend a full circle by a positive value. Extending an arc by a large positive value only extends it enough to form a full circle.

Stretch point

 The **Stretch Point** tool on the Adjust toolbar moves a point and any lines, arcs, or beziers that use that point as an endpoint. It can also adjust the end of a line when you activate the tool and click close to the end of the line. Turning on End points in the View Mode dialog box makes this tool easier to use.

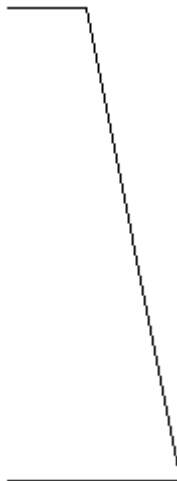

After selecting a point to stretch, ArtiosCAD prompts for the angle at which to move the point.

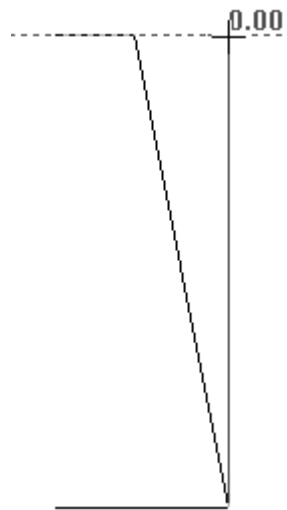

Then ArtiosCAD prompts for the distance to move the point. Use the pointer to align the drag with the bottom point. The completed view of the moved point is shown below.



To move the end of a line, use the following workflow:

1.  Activate the **Stretch Point** tool and click close to the end of a line, but outside the snap tolerance and not the endpoint itself (else the point will be stretched).

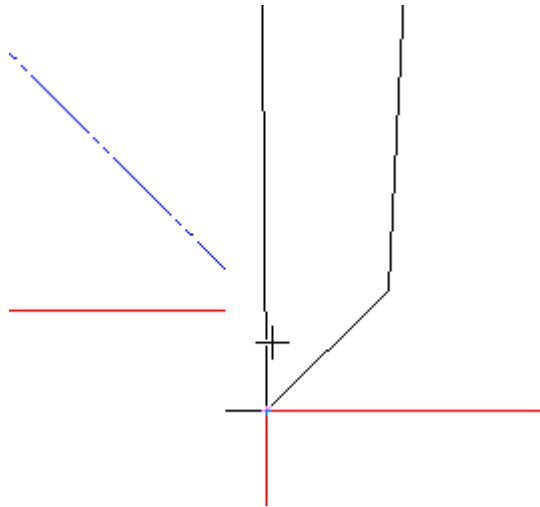

2. Drag the end of the line to its new location.

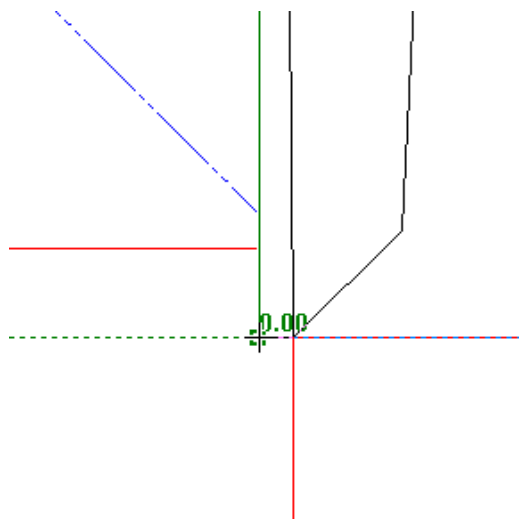

3. Click to set the put-down point.

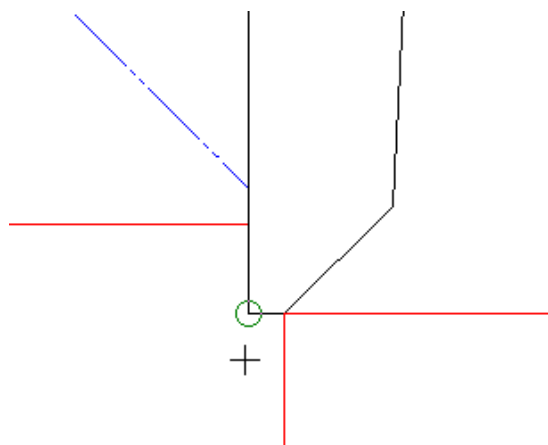

Stretch by Polygon



The fifth button on the Adjust toolbar activates the **Stretch by Polygon** tool, which moves lines while keeping them attached to connected lines, and is also used to move connected endpoints. Stretch by Polygon works with lines, arcs, beziers, arrows, and distance dimensions (both temporary and permanent). Use this tool by activating it, defining an area to stretch with a polygon, selecting the point to stretch from (the reference point), selecting the point to use as a handle while stretching, and then indicating the put-down point. The tool works by moving the lines or connected endpoints in the direction you set, given the requirements to preserve angles or radii and the requirement to keep common endpoints.

The stretch behaves differently depending on the option chosen in the drop-down list box on the Status bar. The reference point and the pick-up point can be the same.

If one end of a line, arc, bezier, arrow, or dimension is selected, ArtiosCAD moves the selected end and not the other. If both ends of an object are fully contained within the selection window, but its endpoints are not connected to any other selection, the object is moved in the direction you specify.

The **Distance**, **Angle** and **Radius** options in the drop-down list box on the Status bar modify the way ArtiosCAD stretches lines, arcs and arrows that cross the selection window or polygon. **Distance** preserves the distance between objects that are fully within the selection window or polygon. **Angle** preserves the angle of lines and arcs that cross the selection window. **Radius** preserves the angles of lines and the radii of arcs that cross the selection window or polygon. ArtiosCAD updates other lines fully inside the selection window or polygon that connect to these as needed.

Note: ArtiosCAD does not maintain angles when one end of a line is selected and this line is perpendicular to the stretch direction, because preserving the angle is not possible in this situation.

Note:

ArtiosCAD does not update radius and angle dimensions changed by this tool.

After the tool is activated, click in many locations to make a custom-shaped polygon to define the area to stretch, or hold down the mouse button and drag a rectangular polygon.

ArtiosCAD stretches dimensions if one end or an extension line is within the selection window or polygon and updates their values. Text is moved but not stretched.

This tool does not affect construction lines.

The default preservation option (Distance, Angle, or Radius) is set in **Options > Defaults > Startup defaults > Stretch by polygon options**.

Shown below is a seal-end container that is not resizable. This tool can change the size of the flaps while preserving their angles.

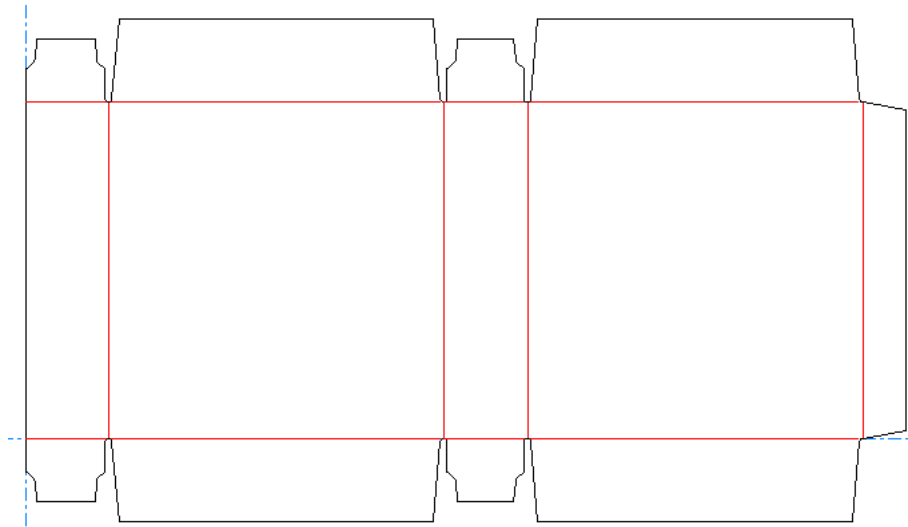

To change the size of the flaps, do the following:

1.  Click **Stretch by Polygon**.
2. Click at the upper left of the design and drag a window to the lower right corner of the flap at the right end, making sure to not select any of the creases.

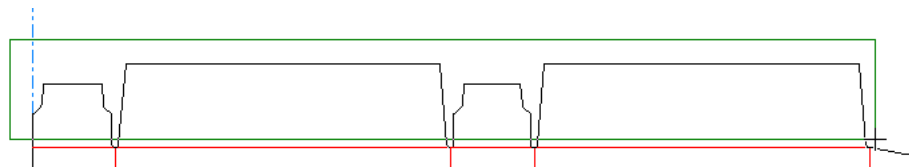

3. Select **Angle** in the drop-down list box on the Status bar.
4. Click the reference point. This is the point used as the anchor for the stretch. In this example, the bottom left corner of the leftmost flap is the reference point.

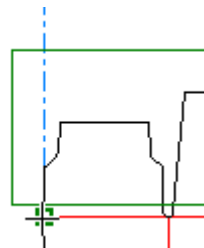

5. Click the handle point. This is the point that you pick up to stretch.



6. Click to set the angle of the stretch.

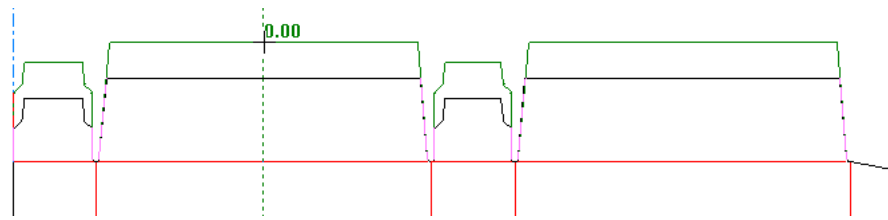

7. Click to set the distance of the stretch.

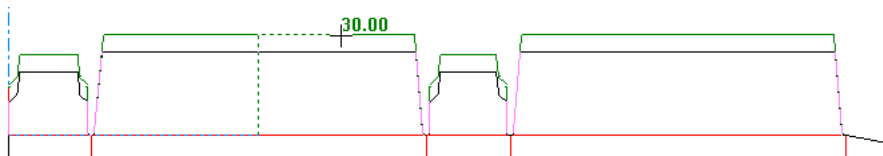

8. ArtiosCAD stretches the lines and preserves their angles. Note how the top flaps are larger than the bottom flaps.

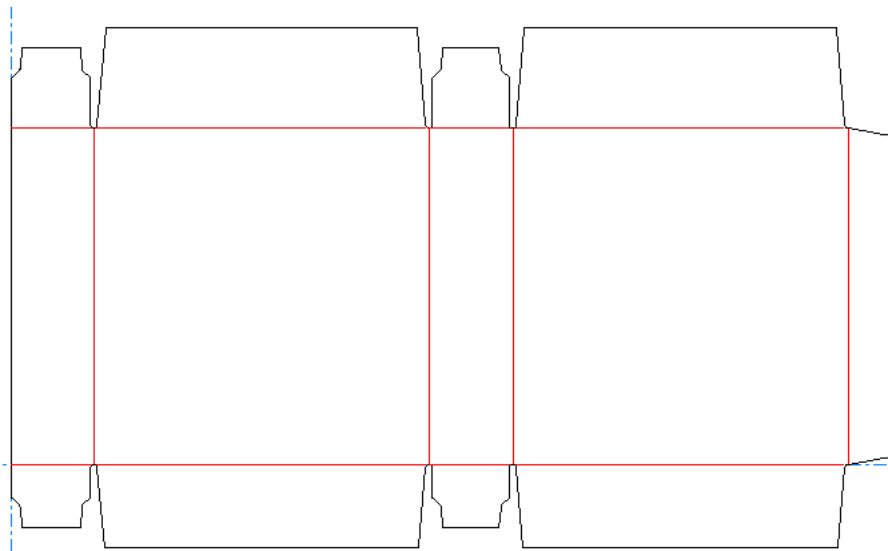

Follow



The sixth button on the Adjust toolbar activates the **Follow** tool. This tool is used to trace existing geometry and copy its outline. It is useful when making bleed outlines or when something needs to be reduced or enlarged by a specific distance rather than a scale.

The **Follow** tool works by prompting for a start point. It then prompts for more points along the path to be followed. The points do not need to be on the same line; the Follow tool will turn corners to reach the point you indicate.

The first four buttons on the Status bar control how **Follow** reaches points.





The first button, **Follow Left**, has the tool turn left at every intersection to reach the point indicated.





The second button, **Follow Right**, has the tool turn right at every intersection.

 The third button, **Direct Path to Point**, sends the tool directly to the point indicated

 The fourth button, **Arc Path to Point**, makes an arc from the current position through the through point you indicate to the end point you indicate.

Offset: 0  The **Offset:** field is used to specify the distance away from the original lines the path will be placed when complete.

  The fifth and sixth buttons control the offset of the new lines from the lines being followed. If you are following in a counter-clockwise (anti-clockwise) direction, the first button offsets them to the left or outside of the original lines (a negative offset) and the second button offsets them to the right or inside of the original lines (a positive offset). If you are following in a clockwise direction, the first button does a positive offset and the second button does a negative offset.

When selected, the **Round Corner** checkbox uses blends to connect lines instead of them meeting end-to-end.

 The sixth button deletes the last path made.

OK accepts the path and leads to the Follow Properties dialog box where the properties for the new lines are set. Make the desired selections and click **OK** to make the new lines.

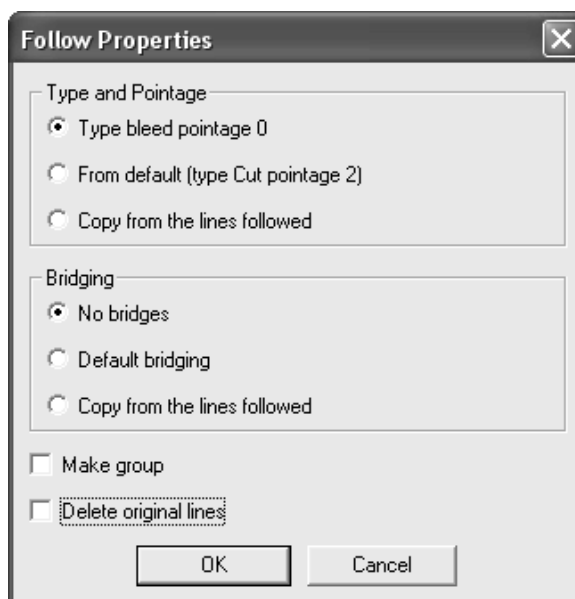

Example of using the Follow tool

The Follow tool concepts may be difficult for new users to grasp. This handy example is meant to show a particular situation in which the Follow tool makes life easier. The shape shown below needs to be made larger by 12 millimeters all around.

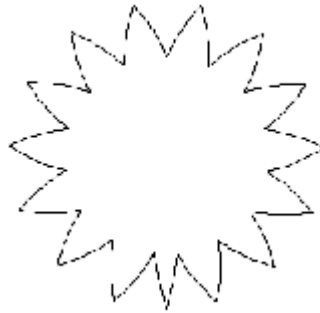

To make the star cutout larger, do the following:

1. Click the **Follow** tool on the Adjust toolbar. The **Follow Left** button is on by default.
2. Indicate the start point (Point 1), the next point along the path (Point 2), and the end point for the path (Point 3).

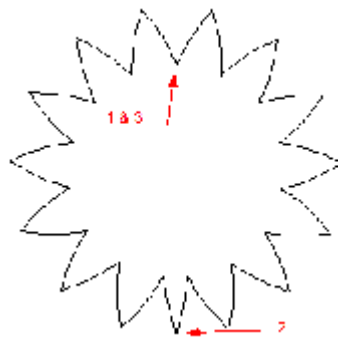

3. Make sure the system is in metric mode by checking the state of the **Units** button on the View bar at the top of the window. Enter 12 in the **Offset** field and click the **Negative Offset** button. A magenta outline will appear of the followed shape.

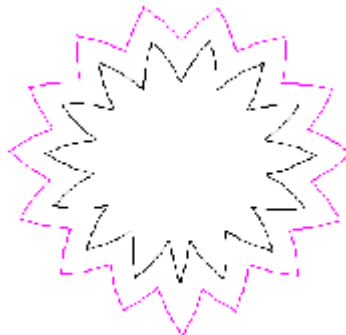

4. In the Follow Properties dialog box, set the **Type** and **Pointage** and **Bridging** options to **Copy from the lines followed**. Click **OK**. The cutout should now look like the picture below.

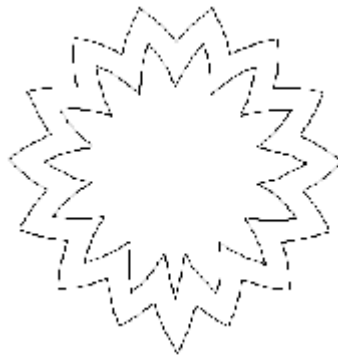

5. Delete the inner lines and the operation is complete.

Cloning Changes Using Auto-Repeat



If your design has areas with congruent geometry, you can clone changes to lines, arc, and beziers from one area to the others using **Auto-Repeat**. For example, you could change the radius on the corner of one flap, and have ArtiosCAD clone that change to matching flaps. Or you could add a crease to an ear and it would repeat to the congruent ears.

Auto-Repeat mode:

- works with tools that edit geometry, not tools that change other items such as details or graphics, and not with tools that affect the design as a whole (such as Bleed).
- does not copy lines that would overlap if copied
- does copy lines in areas that overlap, but without overlapping lines themselves, such as nested bottle shapes

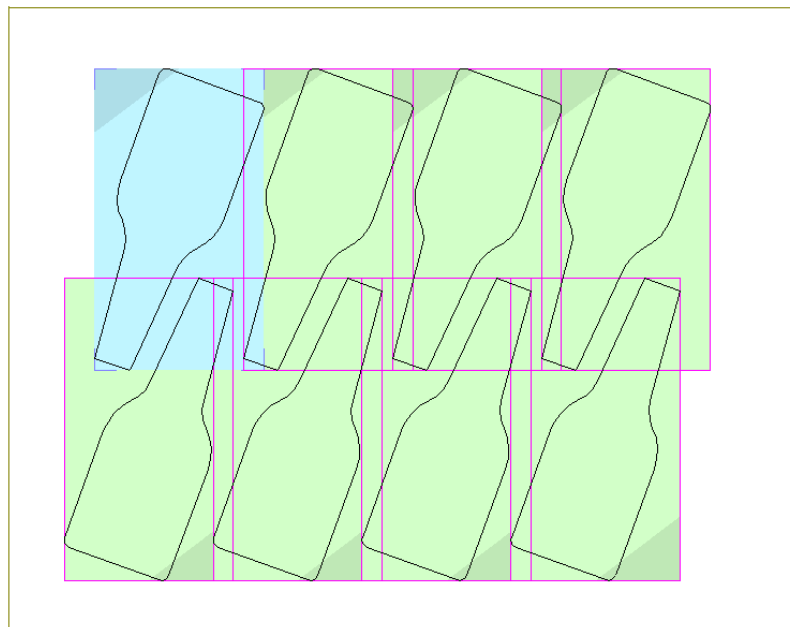

- updates more than one layer by placing changed or added lines into the same layer as they are in as the primary auto-repeat area

- works with canvases but in one part at a time, meaning it works within the same part but does not work across different parts.

Example of Using Auto-Repeat

This example shows how to use Auto-Repeat to change the size of some slots simultaneously by changing only one slot.

1.  Use a **Select** tool to select the objects to change.
 - a) Select lines in the area you want to repeat. You can only edit these selected lines, regardless of your ability to select lines later with tools like Stretch Point and Stretch by Polygon.

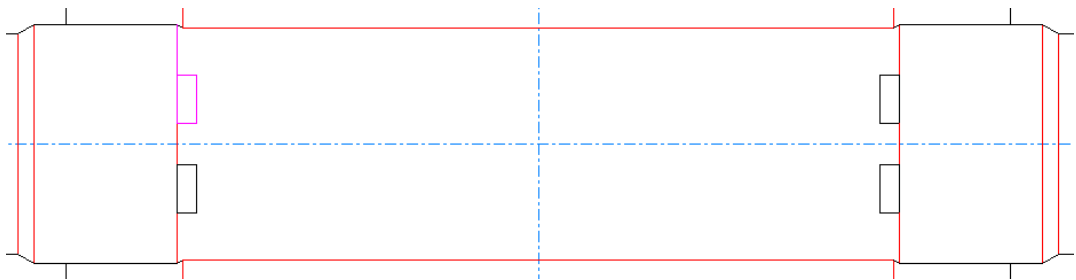

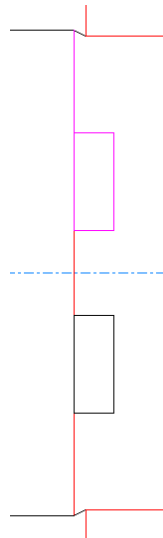

- b) Make sure to select more than one line so that ArtiosCAD does not have any ambiguity as to what to rotate. One line looks identical at 180 degrees rotation.
- c) Also make sure to select an asymmetrical construction so that ArtiosCAD mirrors it properly. In the example below, the four cut lines of the upper slot are selected, along with the crease going up toward the cut line.



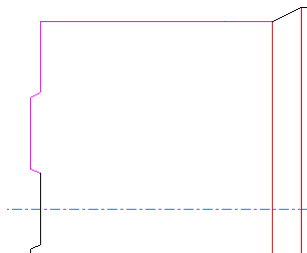
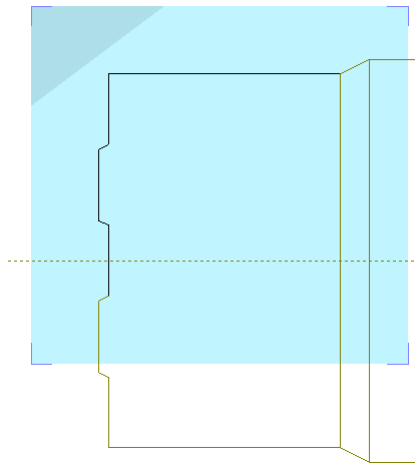
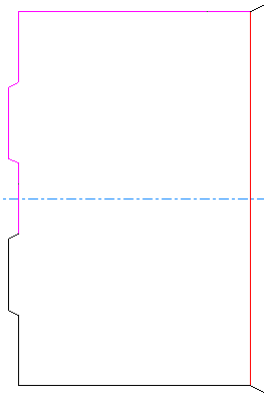

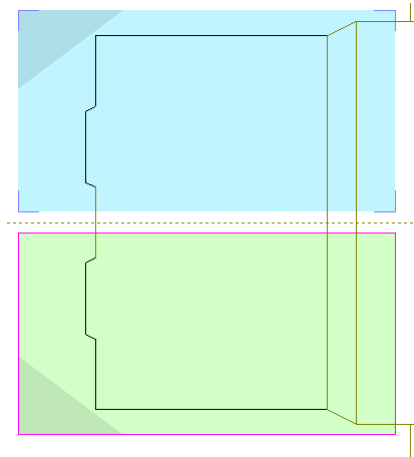
- d) Lastly, your selection should not contain lines that would overlap into another potential auto-repeat area. Shown below is a primary area that has an extra cut selected on the left side that prevents it from having an autorepeat area as shown.



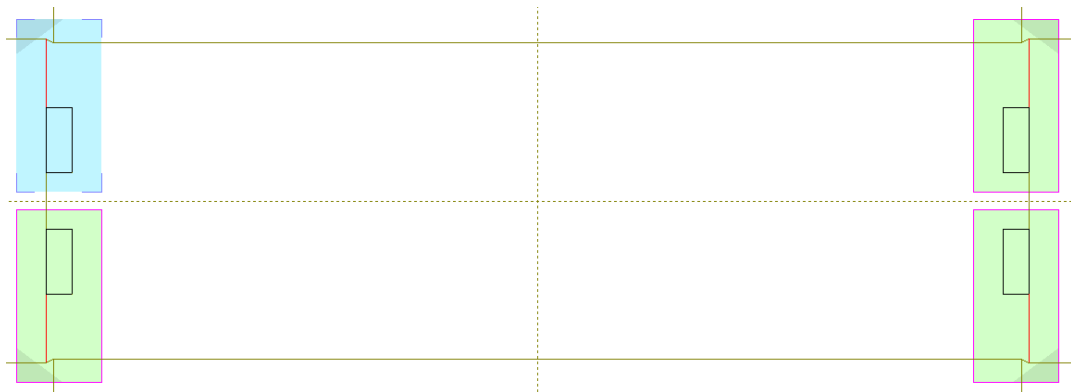

2.  Click **Show Auto-repeat Areas** on the Stage bar or **Edit > Auto-Repeat Areas**. ArtiosCAD enters auto-repeat mode and displays congruent areas to the one formed by the lines you selected. ArtiosCAD shows the primary auto-repeat area (the one you selected) in blue, and the areas in which it will repeat your changes in green (secondary areas). It also shades one corner of each area to show the effect of rotation and mirroring.



3.  Auto-repeat mode is in selection mode where you pick the secondary areas to use. Deactivate an auto-repeat area by clicking its edge; reactivate it by clicking its edge again. Selection mode ends when you activate another tool.
4. Now you can make any desired changes in the primary area using standard workflows of selecting items and adjusting them. You can only change those items you originally selected before entering auto-repeat mode; ArtiosCAD dims all the other geometry.
 - a) You can use the **Selection Ignoring Groups** mode of the Select tool, but any new lines you create will not be in a group. Only lines in the original selection will be available for selection.
 - b) If you want to trim or extend lines, if it's two lines, both must be in the original selection. If it's one line, only the first line must be in the original selection as ArtiosCAD is not changing the second line. If you want to trim against a selection, both lines must be in the original selection for them to be available for selection in auto-repeat mode.

- c) If you want to use an Edit tool, the **Select** tool is already active, so select the items and then activate the tool. If you want to use an Adjust tool, you do not need to select the items first.
- d) You can also add geometry in the primary area. It either has to overlap the primary area, or it must be closer to the primary area than any of the secondary areas.

5.  For this example, we will use **Shrink by Polygon** to make the slots slightly narrower. Click **Shrink by Polygon**.

- a) Click and drag a rectangle around the top cut, right cut, and bottom cut of the slot in the primary auto-repeat area.

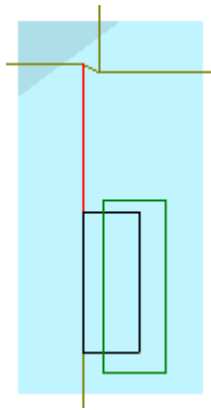

- b) Select the reference point of the middle of the left cut.
- c) Select the handle point of the middle of the right cut.
- d) Set the angle to 0.

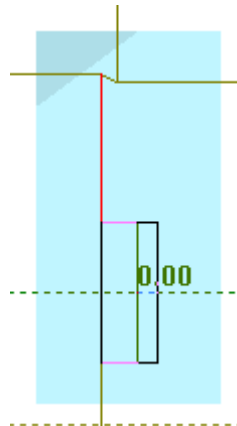

- e) Set the distance to 5/16 or another smaller number depending on the width of your slot.

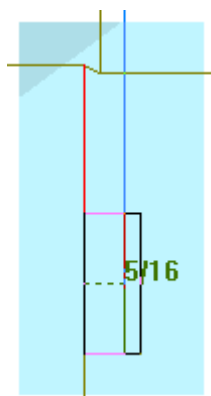

f) ArtiosCAD makes the slot narrower.

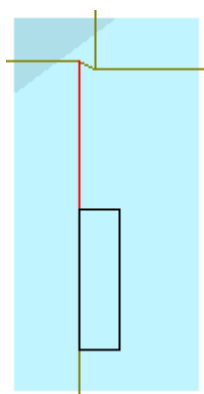

6. ArtiosCAD repeats the change of the primary area to the secondary areas.

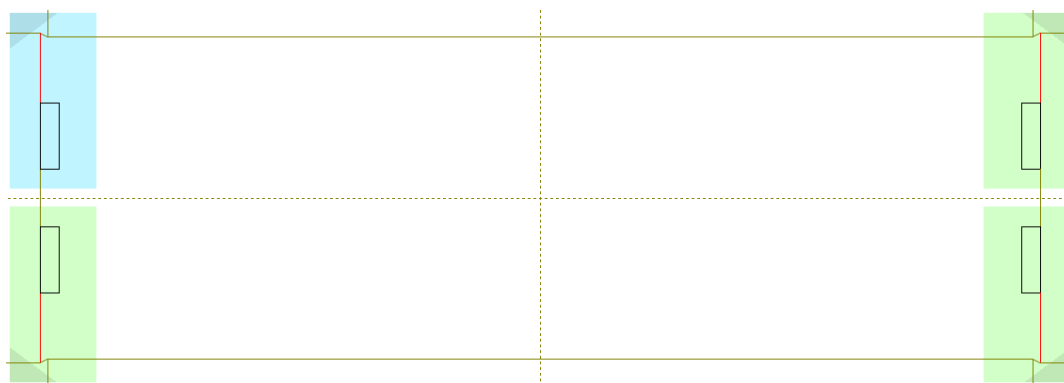

Exit auto-repeat mode by clicking its button on the Stage bar or **Edit > Auto-Repeat Areas**.

Note:

If you **Undo** a command while in auto-repeat mode and then make a change such as adding or removing a line, ArtiosCAD exits auto-repeat mode.

Preparing for Manufacturing

ArtiosCAD groups the tools for bleed, coating-free areas, bridging, nicking, and shortening creases for steel counters on the Prepare for Manufacturing toolbar.



Bleed tool

 Bleeds are used to define the area of ink bleed when the sheet moves through the printing press. To use the Bleed tool, create the design that will have a Bleed outline, and click the **Bleed** tool. If you are not in a Bleed Outline layer and there are none already created, you will be asked if you wish to create one.

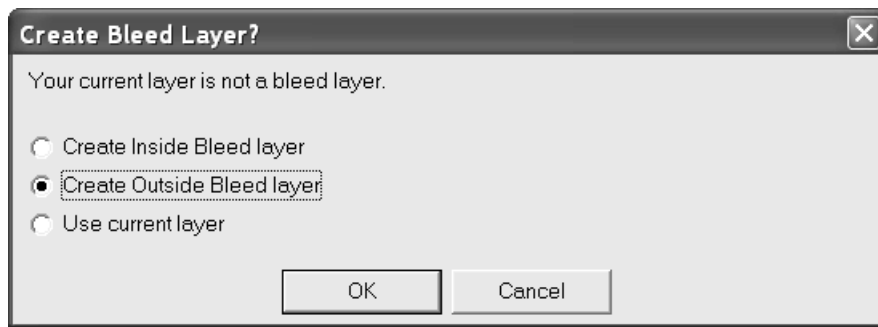

If you are not in a bleed layer and one already exists, you will be asked which layer to use:

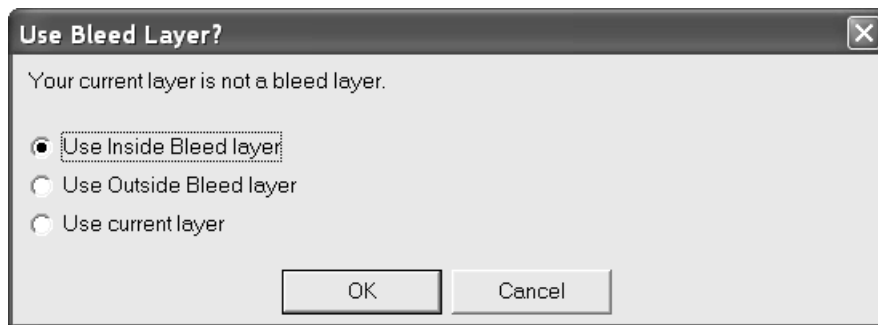

Choose the layer to create, or choose the current layer, and click **OK**. The inside or outside layer type option button is initially set according to the current side of the design.

A default bleed is automatically created, but you can modify it as desired as described below. The final bleed is not created until you click **OK** on the Status bar.

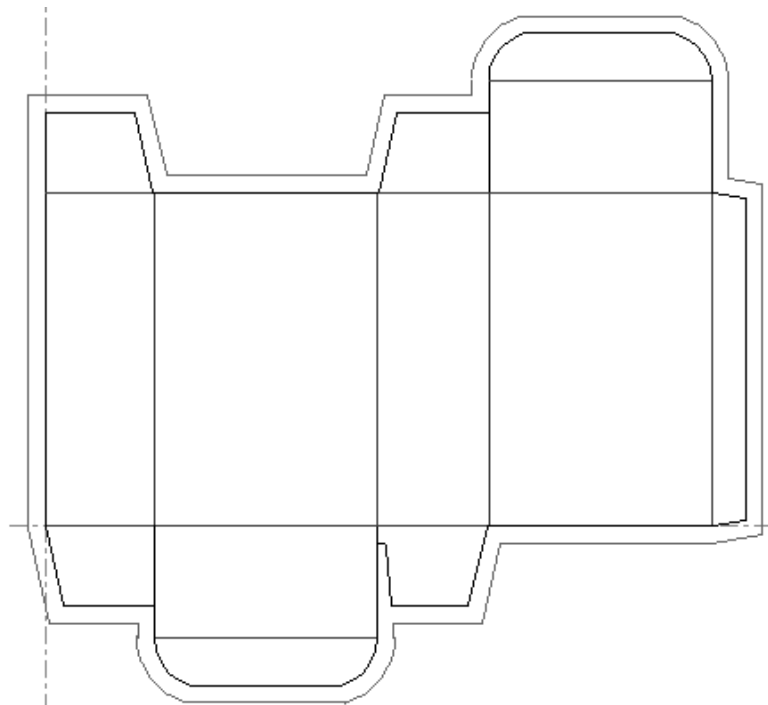

Click inside any panel to exclude it from the bleed. The right flap below is excluded from the bleed.

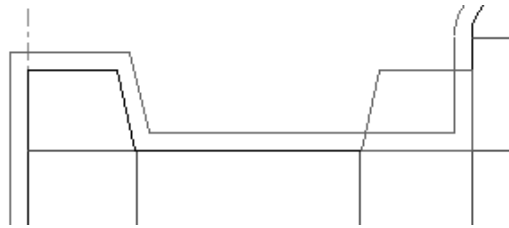

To change the distance between the bleed and the perimeter of the design, change the value in the **Offset** field on the Status bar.

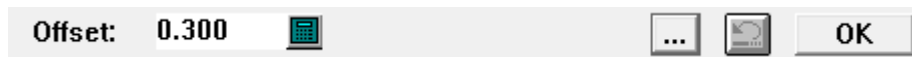

Clicking More Options (...) opens the Bleed Parameters dialog box.

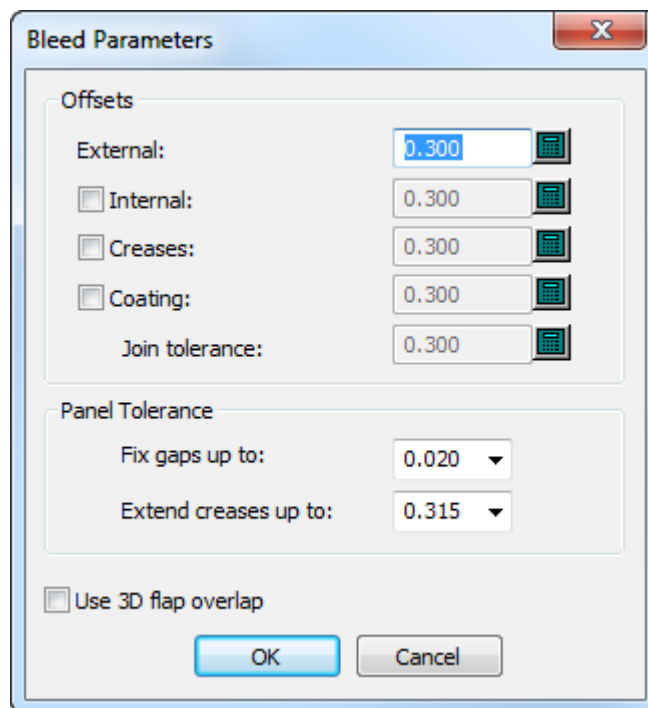

The checkboxes to the left of the optional offsets enable or disable them. If you enable the internal offset, the Status bar changes to have **External** and **Internal** fields.

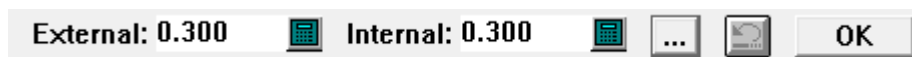



If you enable a separate coating offset, you can also set the **Join tolerance** to control the smoothness of how the coating lines join the bleed lines.

In the Panel Tolerance group, **Fix gaps up to** and **Extend creases up to** tell ArtiosCAD to fix small gaps up to the size indicated and to extend creases through gaps of up to the size indicated. This helps the tool find panels when creases do not touch cuts or there is a small

gap in a panel's periphery. The defaults for these values are in **Startup defaults > 3D Tools Options**.

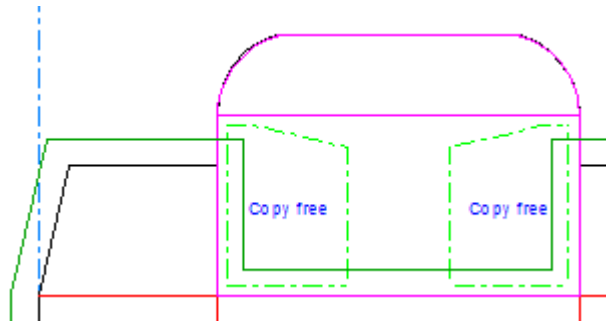
Use 3D flap overlap uses the flap information from **Flap Priority** and **Update 2D** in the 3D module to determine the bleed outline.



 Click the **Undo** button to undo a bleed action. Click **OK** to finish using the tool and create the final bleed.

Coating Free Area tool

 The second tool on the Prepare for Manufacturing toolbar is the **Coating Free Area** tool. The **Coating Free Area** tool defines panels on the box that will not receive a coating as the sheet passes through the printing press.

As with the **Bleed** tool, when you click the **Coating Free Area** tool, if you are not in a layer of class Coating, ArtiosCAD asks the kind to create, or to use the current one.

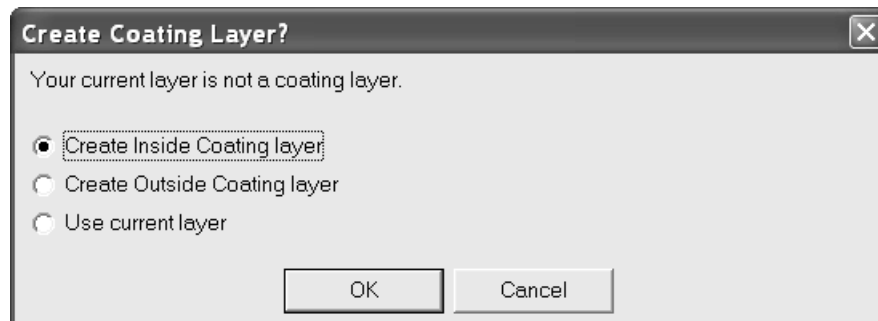

If a layer of class Coating already exists, the same layer-creation questions and dialog boxes appear as for the Dimension tools. You are asked to add to an existing layer, or to create a new one. Select an already-existing layer and click **Add To**, or click **Create New** to create a new coating layer.

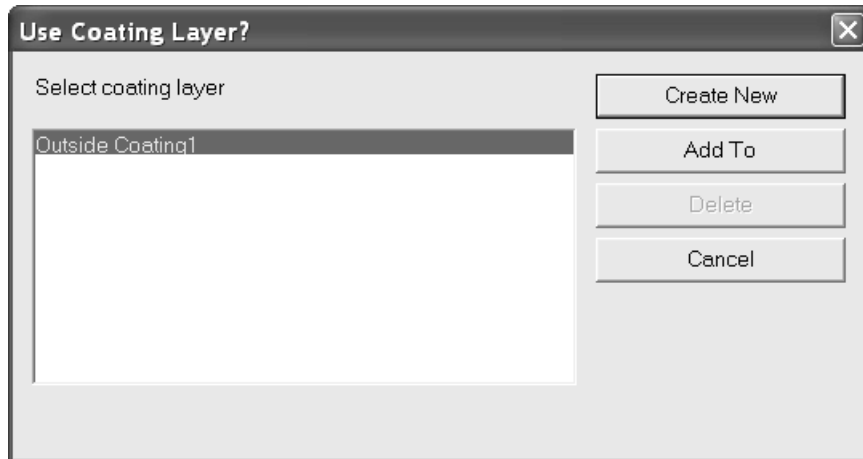

Once the layer management is decided, the tool activates. Click the panels of the box to be coating-free. The coating free area outlines will appear using the tolerances set in the fields on the Status bar. The **External** field controls how far the outline extends from the perimeter of the design, while the **Internal** field controls the distance from the outline to any internal lines in the panel.



 Click the **Undo** button to undo a varnish action. Click **OK** to finish using the tool. Shown below is a picture of panels which are coating free areas.

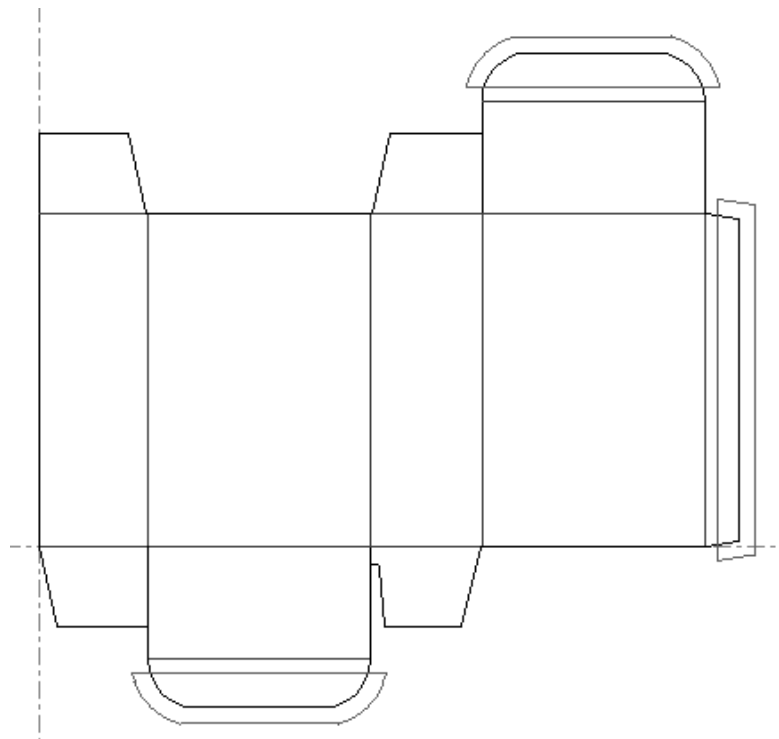

Notes on the Bleed and Coating tools

You must click **OK** on the status bar when done indicating what to create. If you change the window focus or select another tool, the tools are cancelled.

The tools only account for manufacturing line types in the Main Design, Manufacturing, and Windows and Cutouts layers. Line types such as print image and annotation are ignored when using these tools.

If you make a mistakenly select a panel, click the **Undo** button on the Status bar or restart the tool.

Defaults for these tools are contained in the single design parameter sets.

When you are in an inappropriate layer with automatic layer switching turned off and activate the Coating Free Area tool, ArtiosCAD only displays option buttons for the first instance of each class of coating layer. For example, if you have two **Outside Coating1** layers in a print item, and activate the Coating Free Area tool in the Main Design layer, ArtiosCAD prompts you to choose a coating layer. It displays only the first coating layer in each class, so if you chose the **Outside Coating1** layer, it would distribute items to the first instance of the layer. To work in the second **Outside Coating1** layer, change to that layer before activating the tool so that you are not prompted to choose a coating layer.

Add Bridge tool



The third tool on the Prepare for Manufacturing toolbar activates the **Add Bridge** tool.

ArtiosCAD automatically turns on the display of bridges in the View Mode when the **Add Bridges** tool is activated. Bridges are also on the right-click context menu in Single Design.

To add a bridge to a line, activate the **Add Bridge** tool, set the width of the bridge in the **Bridge Width:** field in the Status bar, and click the location of the center point of the new bridge.

The value entered in the **Bridge Width:** field will be the default value for the current session of ArtiosCAD.

If you try to add a bridge that is a different size than other bridges on the line, the Different Bridge Sizes dialog box appears. In it, you can choose to change the old bridges to the new size, to add a new bridge using the old size, or to use both sizes. Choose the desired option and click **OK** to add the bridge, or **Cancel** to return to Designer without adding the bridge.

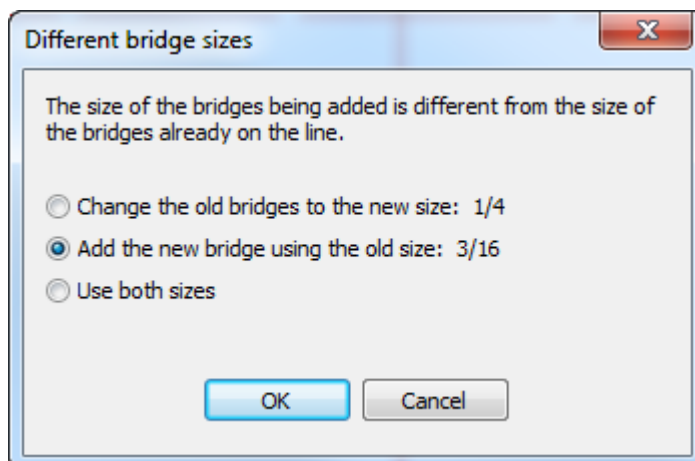

Note: If you change the nick size to a bigger size, some bridges may be removed to avoid overlapping.

Note: If you choose **Use both sizes** and will be sending this workspace to someone using a pre-12.1 version of ArtiosCAD, you must export it as an ArtiosCAD 12.x workspace using **File > Export > ArtiosCAD 12.x**.

Add Tack Bridge tool

 The fourth button on the Prepare for Manufacturing toolbar activates the **Add Tack Bridge** tool.

To use this tool to add a tack bridge to a wood edge line type, simply activate it and click the position for the new tack bridge.

If size of the tack bridge differs from tack bridges already on the line, a warning dialog box will appear. Choose the desired option and click **OK** to change the size of the tack bridges.



To change the tack bridge formula, click **Options > Change Tack Bridge formula** and select the new formula.

When a tack bridge is viewed in a Preview for an output that cuts or mills, the allowance for the tool diameter will make it appear larger than it would for a laser output.

Add Nick tool

 The fifth button on the Prepare for Manufacturing toolbar activates the **Add Nick** tool. This tool places a nick on the line that you select after activating the tool. By default, nicks appear as short lines perpendicular to the selected line, but this can be configured in Defaults in the Nick Styles catalog.

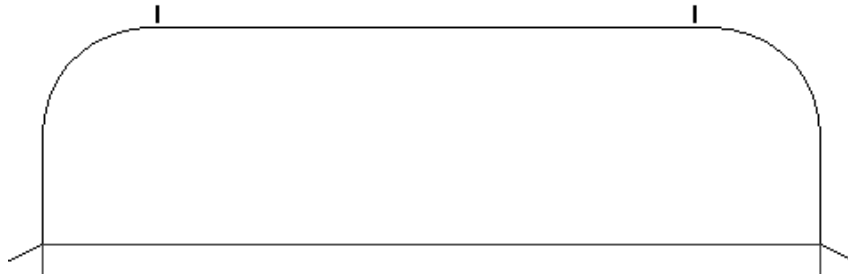



When active, this tool has configuration options on the Status bar as shown below.





The **Between nicks:** field appears only when the value in the **Number:** field is 2 or greater.

The six buttons on the status bar control the placement of the nick.

 The first button offsets the nick by the distance specified in the **Offset** field from the start or end of a line depending on which is closer to where you click.

 The second button places the nick at the center of the line clicked.

 The third button places the nick anywhere on the line you indicate. If you click within the snap tolerance of a point such as an intersection with a construction line, the nick snaps to the intersection.

 The fourth button places the nick at the end of a line.

 The fifth button fills the line with nicks. Each nick is separated from the others by the distance in the **Spacing:** field.

 The sixth button fills a path with nicks. For more information about this aspect of the tool, see the next section.

The **Nick size** control sets the size of the nick. Either specify a value in the field or select a value from the drop-down list box.

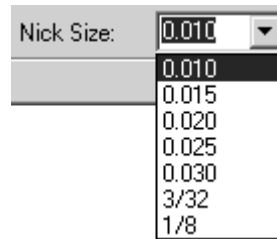

The **Offset** control sets the distance used in conjunction with the Offset placement method.

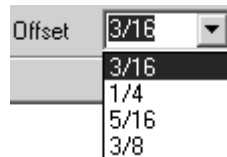

This control changes to the **Spacing** control when the Fill Line or Fill Path placement method is selected.

The **Number** control sets the number of nicks added when you click. A line may have up to 120 nicks. Either type the desired number of nicks in the field or select the value from the drop-down list box.

When the Number control is set to more than 1, the **Between nicks** control appears. This control sets the equidistant spacing between nicks. Either type the desired distance in the field or select the value from the drop-down list box.

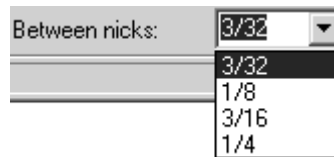

Nicks may move if they are added before removing double knives.

When making a multiple selection, the Properties page for that selection will now show nick controls if any of the items selected have nicks. If you change nicking options, only those items already having nicks change.

Note: When using the default nick size, if you change the board in the Board Information dialog box, and thus change the caliper, actual nick sizes are not updated unless the design is rebuilt.

As with bridges, if you try to add nicks to a line of a different size than nicks already along the line, the Different Nick Sizes dialog box appears. Choose the desired option and click **OK** to add the nicks, or click **Cancel** to return to Designer.

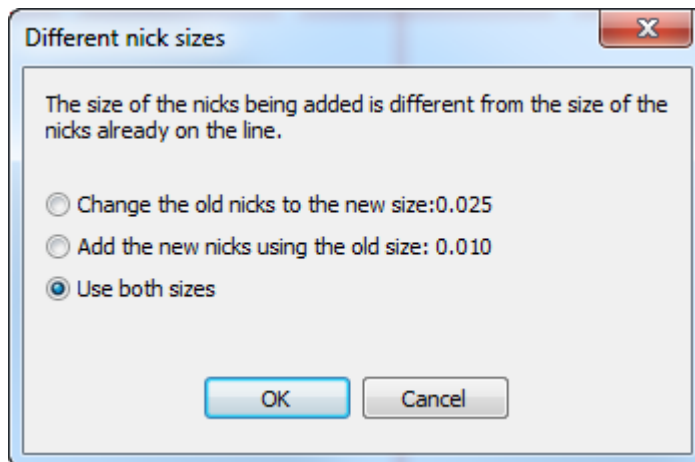

Note: If you choose **Use both sizes** and will be sending this workspace to someone using a pre-12.1 version of ArtiosCAD, you must export it as an ArtiosCAD 12.x workspace using **File > Export > ArtiosCAD 12.x**.

Filling a Path with Nicks

 **Fill Path** mode of the **Add Nick** tool is available only in Single Design because of the double knife removal and embedded designs considerations in Manufacturing. For this tool, a path is a sequence of lines of the same pointage and type with common end-points. You can define the path beforehand using the **Group Sequence** tool, or you can select the path while using the tool by selecting the first line in the path and then the last line in the path. If the path has any intersecting or meeting cuts, define the path beforehand.

When this mode is active, the Status bar has three additional controls for more options for adding nicks, the number of sets with which to fill the path, and the distance between the sets of nicks.

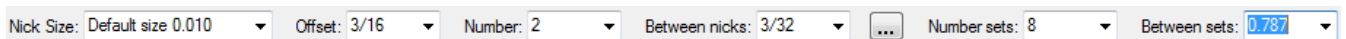

Clicking More options (...) opens the Add Nick Options dialog box.

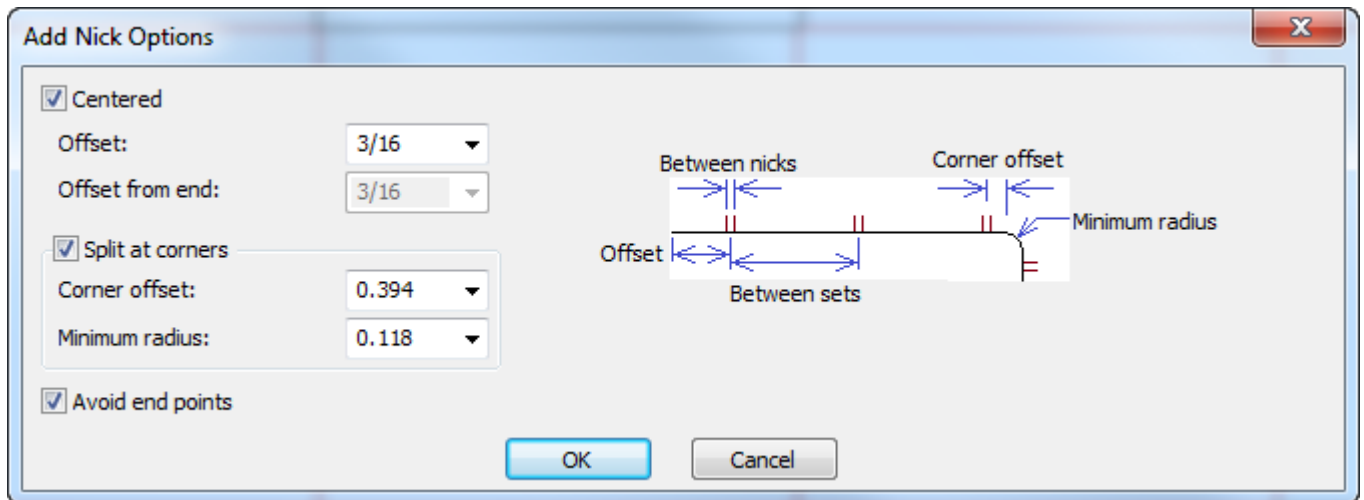



Centered keeps the nicks centered on the line and **Offset** defines the distance from the beginning of the line (and the end when Centered is checked). To enable a different offset at the end of the line, deselect Centered to make **Offset from end** available.

When there are corners, ArtiosCAD fits sets of nicks as best it can using the between nicks distance or number of nicks you specified. **Split at corners** keeps nicks away from corners by the amount specified in **Corner offset**. If a blend is larger than the **Minimum radius**, ArtiosCAD considers it a corner. Note that the distance between nick sets will not be exactly the same on each segment of the path comprising the corner.

Avoid End Points keeps the nicks from being on the shared end-point of two lines.

Note: If you rebuild a resizable design so that this path changes length, the distance between the nicks will be the same but the number of nicks will change.

To use this mode, do the following:

1. Make sure the desired path is all the same line type and pointage. If the path has any meeting or intersecting lines, use the Group Sequence tool on it first.
2.   Click **Add Nick** and select the **Fill Path** mode on the status bar.
3. Click the start of the path. ArtiosCAD places nicks on this line.
4. Click the end of the path. ArtiosCAD fills the path with nicks.

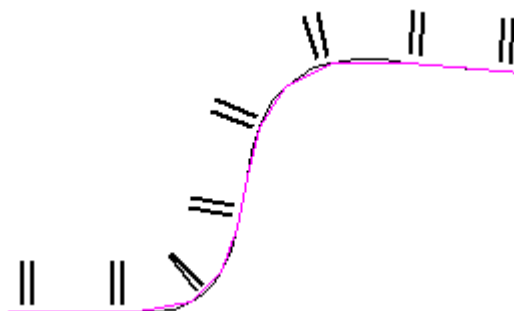

- Adjust the fields on the Status bar as desired for the offset, number of nicks, distance between nicks, number of nick sets, or the distance between nick sets. They will change accordingly.

Delete Bridge tool



The sixth button on the Prepare for Manufacturing toolbar activates the **Delete Bridge** tool. When this tool is clicked, bridges are turned on in the View Mode if they are not on already.

To delete a bridge, click this tool, and then click the bridge to delete.

To delete many bridges, click this tool, and then click and drag to do a marquee selection around the bridges to delete. ArtiosCAD deletes the bridges when you release the mouse button.

Move Bridge tool



The seventh tool on the Prepare for Manufacturing toolbar activates the **Move Bridge** tool. To move a bridge, click this tool, click the bridge to move, and click its new position on the line. The bridge will be moved so that it is centered on the position you select, and it will snap to a point if the click is within the snap tolerance.

Conline Through Bridge tool



The eighth button on the Prepare for Manufacturing toolbar activates the **Conline Through Bridge** tool. This tool creates a construction line which passes through the center of a bridge. To use this tool, click it, choose one of the placement options on the Status bar, and then click the bridge.

The placement options are:

- **Perpendicular to the line**, which creates a construction line at 90 degrees to the line, regardless of the orientation of the line;
- **Vertical**, which creates a vertical construction line (parallel to the Y axis of the design);
- **Horizontal**, which creates a horizontal construction line (parallel to the X axis of the design).

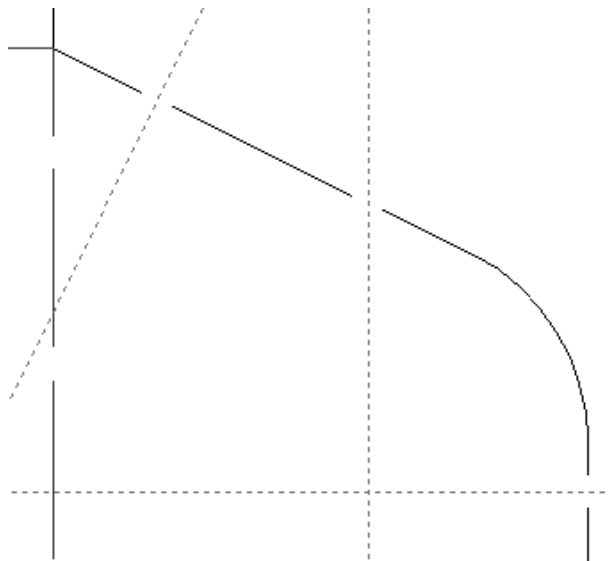

Delete Nick tool

 The ninth button on the Prepare for Manufacturing toolbar activates the **Delete Nicks** tool. To use this tool, click it, and then click the nick(s) to delete. This tool remains active until another tool is selected.

To delete many nicks, click this tool, and then click and drag to do a marquee selection around the nicks to delete. ArtiosCAD deletes the nicks when you release the mouse button.

Delete all nicks on a line at once by clicking **Delete All Nicks** on the Bridging tab of that line's Properties dialog box.

Move Nick tool

 The tenth button on the Prepare for Manufacturing toolbar activates the **Move Nick** tool. To move a nick, click this tool, click the nick to move, and then click the new position along the line for the nick. The nick will snap to its new position if you click within the snap tolerance of a point or an intersection.

Conline Through Nick tool

 The **Conline Through Nick** tool is the eleventh button on the Prepare for Manufacturing toolbar. It places a construction line through a nick either perpendicular to the line containing the nick, vertical through the nick, or horizontal through the nick depending on which option is selected on the Status bar.

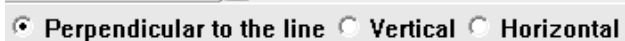

Changing nick properties

Once nicks have been added to a line, their size and the side of the line they are on can be modified by accessing the Bridging tab of the Properties dialog box for that line. The **Nicks** group on the Bridging tab appears only when a line contains nicks.

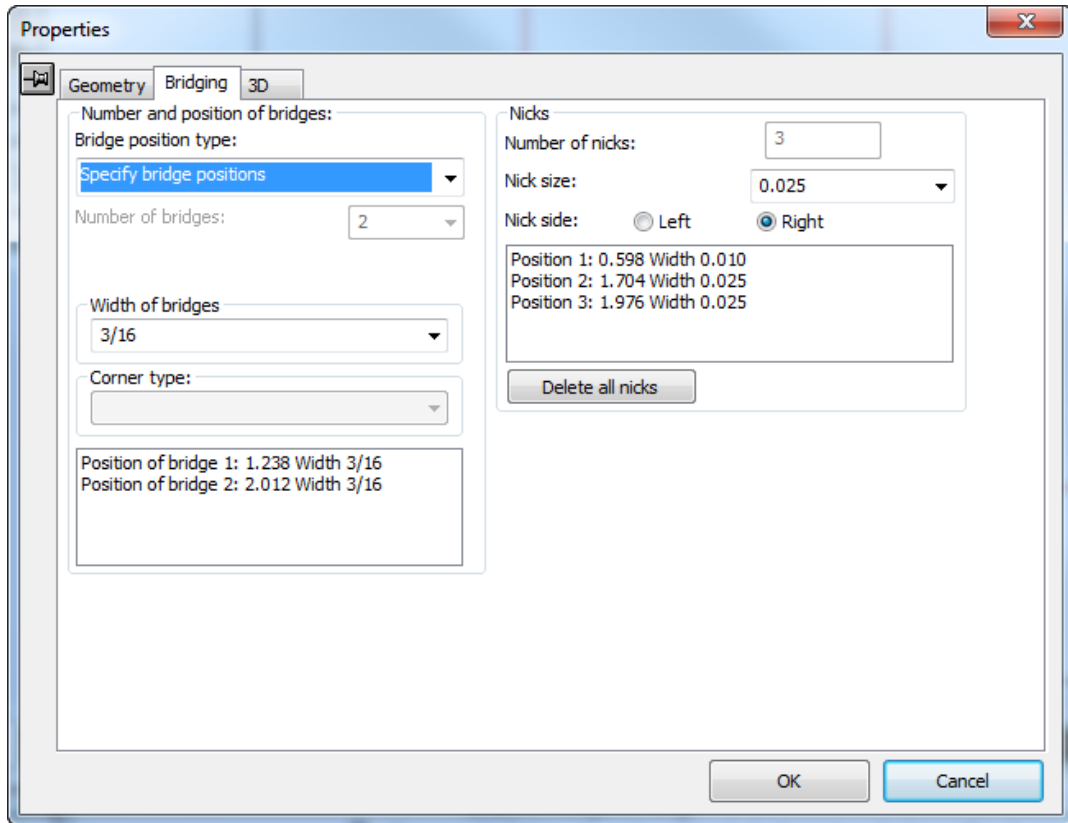

The **Nick size**: drop-down list box lets you choose a new size for all the nicks on the line. The **Left** and **Right** option buttons in the **Nick side**: field set the side of the line the nicks are on. (Check the **Direction** checkbox in the View Mode dialog box, and follow the direction of the line to determine which is the left side and which is the right side.)



Delete All Nicks deletes all the nicks on the currently selected line(s).

Shorten Creases tool

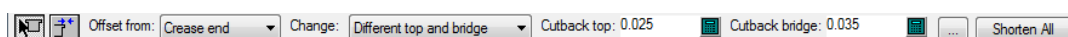
 The twelfth button on the Prepare for Manufacturing toolbar activates the **Shorten Creases** tool used for steel counters. It is available only in Single Design; if you turn on the Adjust toolbar in Manufacturing, this tool will not be available, but you can use it in an embedded design (via **Tools > Adjust**) and when you return to manufacturing, all instances of the embedded design are updated. When you activate this tool, ArtiosCAD turns on Crease cutbacks in the View mode. Shown below are its fields on the Status bar in Formula mode.



It has two modes:

-  Formula mode lets you change all the creases at once. Use formula mode if you have not yet created the counter. If you have already created the counter, use **Create or Rebuild Counter** instead.
-  Drag mode lets you adjust an individual crease or channel end by clicking it and dragging it by the desired distance.

To use **Shorten Creases**, do the following:

1. Make a single design as desired.
2.  Click **Shorten Creases**.
3. Choose **Formula** or **Drag** mode on the Status bar.
4. For formula mode, select the objects to offset from, what to change, and the cutbacks (the amount by which ArtiosCAD will shorten the creases).
 - a) Click **More Options (...)** to set more options for the tool. The cutback amounts are seeded from any values you entered on the Status bar previously.

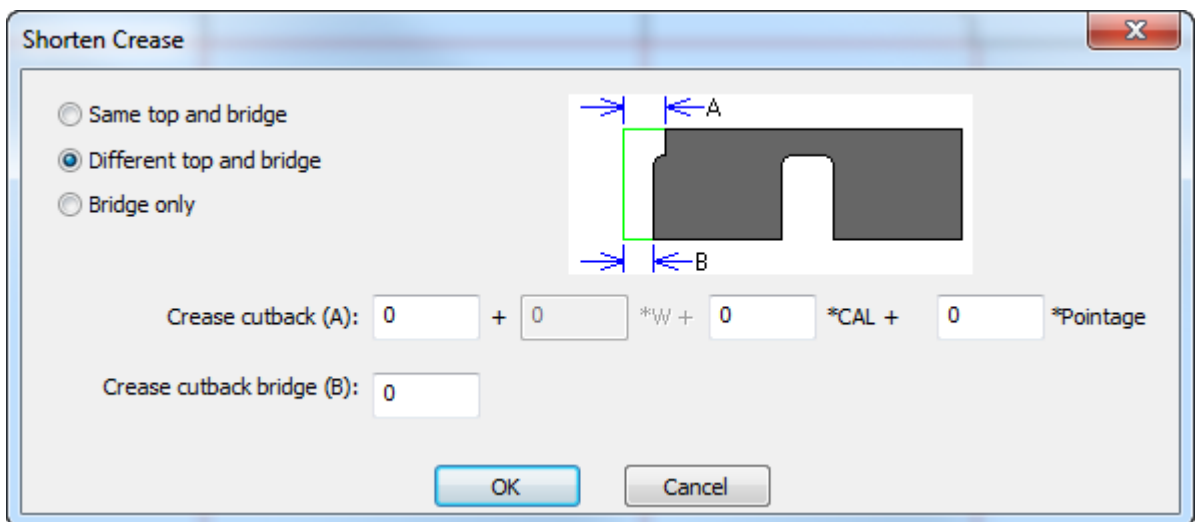

Click **OK** when you have set the options as desired to return to the tool.

- b) Click **Shorten All** to shorten all the creases in the design.
5. For drag mode, select the objects to offset from and what to change, and then start clicking creases and dragging them by the desired offset. If you choose to change **Bridge or Top and Bridge**, ArtiosCAD turns on Bridges in the View mode.

Changing physical properties

Changing physical properties of objects means copying, rotating, moving, mirroring them, or making any other change that affects their physical placement. The Edit toolbar and the Adjust toolbar contain most of the commands used to change physical properties. Most tools on the Edit toolbar are disabled until at least one item is selected.

Delete tool

X The **Delete** tool is the third tool on the Edit toolbar. Use this tool to remove unwanted elements from your design. There must be a current selection for this tool to be available.

When possible, use **Undo** rather than **Delete**.

If you delete something that you should not have deleted, use **Undo** to reverse the deletion.

Move To Layer tool

 The fourth button on the Edit toolbar activates the **Move To Layer** tool. At least one object must be selected for this tool to be available.

This tool has two modes of operation - one for Single Design, and another for Manufacturing. For the Manufacturing version of this tool, see the *Manufacturing* chapter.

To use this tool in Single Design, select at least one object, then click the tool. The Move To Layer dialog box will appear.

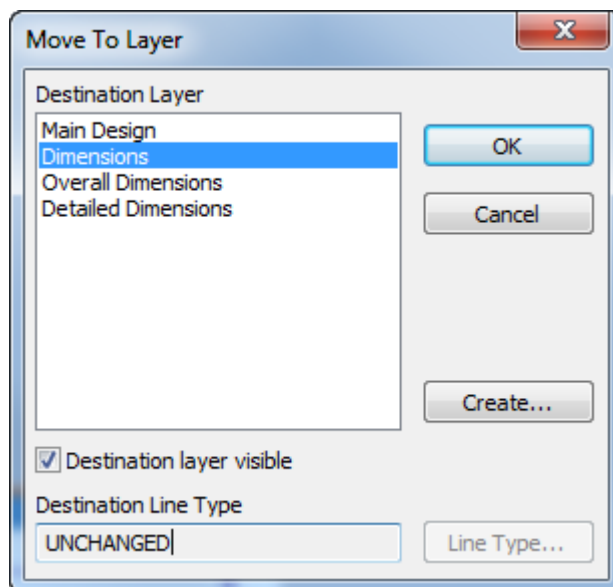

The existing unlocked layers of the design are shown in the Destination Layer list. If the desired layer is locked, cancel the tool, unlock the layer, and then reactivate the tool. If the layer into which you want to move the item does not yet exist, click **Create**, and the Create Layer dialog box will appear. Enter the name of the new layer, choose its class, and click **OK** to return to the Move To Layer dialog box.

To change the line type of the object(s) being moved, click **Line Type** and choose the new line type. You may select any line type, but it will be checked for layer appropriateness upon clicking **OK** to return to the Move to Layer dialog box. Click **OK** to return to the Move To Layer dialog box.

Once you have chosen the destination layer and have optionally changed the line type, click **OK** to move the object(s) into the destination layer, or click **Cancel** to cancel the operation. When you click **OK**, ArtiosCAD checks the layer appropriateness and warns if necessary, performs the move, and makes the new layer the active layer.

Move tools

 The fifth button on the Edit toolbar activates the **Move** tool.

Use this tool to move the current selection to a different location. There must be a current selection for this tool to be available.

When clicked, the Move tool prompts for a pick-up point. This is the handle you want to use to move the current selection – everything in the current selection is moved in reference to the pick-up point. Once a pick-up point is selected, ArtiosCAD prompts for the put-down point. This is the point around which the current selection is arranged identically to the way it was around the pick-up point. Use the fields on the Status bar to choose the drag method.

Rotate tools

 The sixth button on the Edit toolbar activates the **Rotate Right 90** tool, and when held down, activates the Rotate flyout toolbar. If you click a point in any item while a Rotate tool is active, you can move it using standard Move tool functionality.



 The first button on the Rotate flyout toolbar, and the default Rotate button on the Edit toolbar, activates the **Rotate Right 90** tool. This tool rotates the selected object 90 degrees clockwise around its center. The Rotate Right 90 tool has no prompts; it works instantly.

 The second button on the Rotate flyout toolbar activates the **Rotate Left 90 tool**, which rotates the current selection 90 degrees counterclockwise around its center.

Rotate Left 90 has no prompts; it is instantaneous.

 The third button on the Rotate Tools flyout toolbar activates the **Rotate 180** tool. This tool rotates the selected objects 180 degrees around the horizontal axis.

 The fourth button on the Rotate flyout toolbar activates the **General Rotate** tool. When activated, this tool prompts for a fixed point around which to rotate the current selection and a handle point (where the push is applied to perform the rotation).

Note: The points you choose do not have to be in the object being rotated - they can be any points in any part of the design.

The drag extend line goes through the fixed point and the handle point.

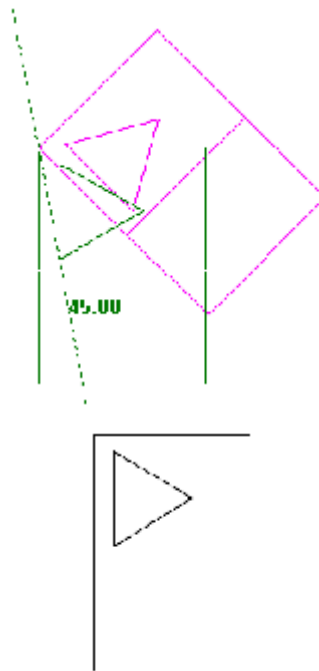

Mirror tools



The seventh button on the Edit toolbar activates the default **Mirror** tool, and when held down, activates the Mirror flyout toolbar.



There are two types of tools on this flyout toolbar. Those with arrows in the icons perform a move on the selection after mirroring it. Those without the arrows do not perform a move; rather, they mirror the selection about its center without moving it.

To use a tool which does not perform a move, select the item(s) to mirror, and then click one of the tools. The item will be mirrored in-place.



The first button on the Mirror flyout toolbar activates the **Mirror About Vertical** tool; this tool mirrors the selection about the Y axis and then performs a move.



The second button on the Mirror flyout toolbar activates the **Mirror about Horizontal** tool. This tool mirrors the selection about the X axis and then performs a move.



The third button on the Mirror flyout toolbar activates the **Vertical Mirror About Center** tool. This tool flips the current selection around on the Y axis.



The fourth button on the Mirror flyout toolbar activates the **Horizontal Mirror About Center** tool. This tool flips the current selection around on the X axis.



The fifth button on the Mirror flyout toolbar activates the **Mirror About Line** tool. This tool flips the current selection around any line or construction line you indicate.

Scale tools



The eighth button on the Edit toolbar activates the Scale Tools flyout toolbar.



The first button on the Scale flyout toolbar, and the default Scale tool on the Edit toolbar, activates the **Scale** tool. The Scale tool prompts for a fixed point, prompts for a handle point, and then changes the size of the current selection proportionally in all directions.



The second button on the Scale flyout toolbar activates the **Differential Scale** tool. The Differential Scale tool prompts for a fixed point and a handle point, but then lets you set the X scale and the Y scale independently.

Copy tools



The ninth button on the Edit toolbar activates the **Copy** tool, and when held down, activates the Copy Tools flyout toolbar.



To use the Copy tool, do the following:

1. Select at least one object to copy with a **Select** tool.
2. Click the **Copy** tool.
3. Click the pick-up point of the copy. This can be any point; it does not have to be part of the object(s) being copied.
4. Click to set the put-down point, or set the values in the fields in the Status bar to the desired angle, offsets, or distances. The copied objects will be oriented the same way in relationship to the put-down point as they were to the pick-up point.

Distribute to Layers

The **Distribute to Layers** checkbox on the Status bar of most of the Copy tools controls whether the copies of the items selected go into the same layers as the originals automatically or if they are placed in the current layer.

Distribute to layers

If **Distribute to Layers** is deselected and some of the selected items have inappropriate line types for the current layer, ArtiosCAD prompts you to select the desired action. Make the choice as desired and click **OK** to perform the copy or **Cancel** to cancel it.

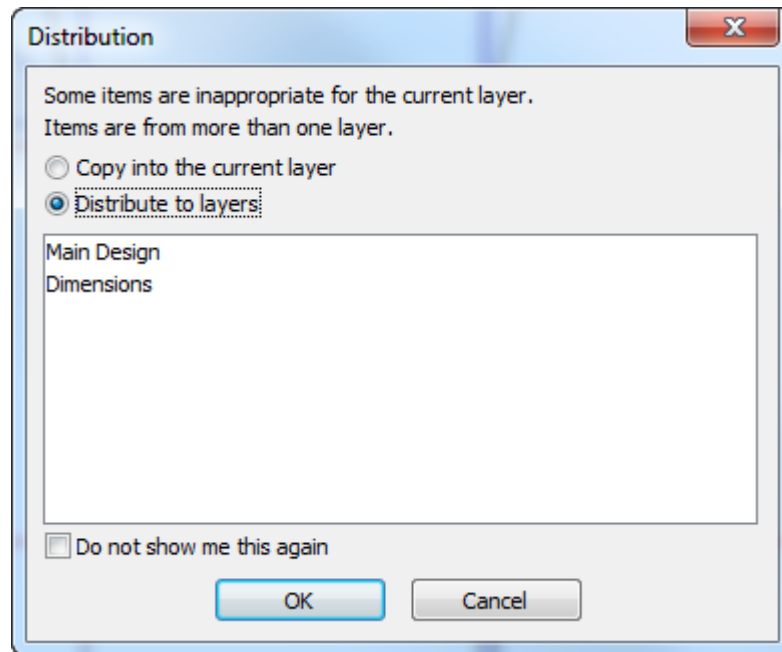

If an appropriate layer for the copy does not exist, a new appropriate layer is shown in green with **New** next to its name, and it will be created when you click **OK**. If the appropriate layer exists but is locked, its name is shown in red with **must unlock first** next to its name. You must cancel the copy and unlock the layer in order to use it for the copy.

Do not show me this again, when checked, tells ArtiosCAD to use the action you select to answer future instances in the same session and to not ask again.

This same dialog box appears when you use **Copy** and **Paste** on the Edit menu.

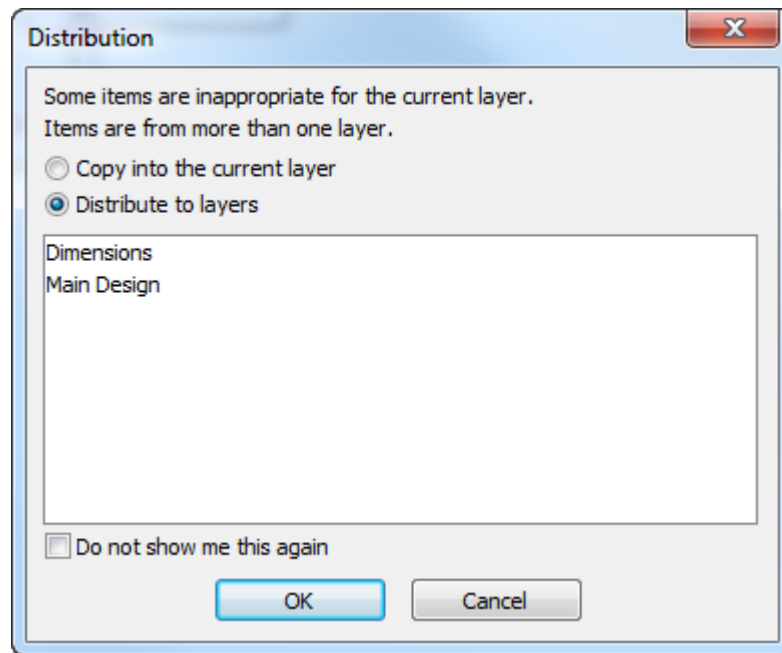

If there are too many layers, a red warning appears saying the maximum number of layers has been reached, and **Distribute to layers** becomes unavailable. The maximum number of layers is 250.

Layer distribution is available only with the tools in Single Design and canvases; it is not available with the same tools in Manufacturing.

To set defaults for Distribute to Layers, click **Options > Defaults > Design defaults > Distribute to Layers**. You may set whether the checkbox is selected or deselected by default, and to prompt if there is an inappropriate layer or switch to an appropriate layer automatically. If you choose to automatically switch, ArtiosCAD will use the Annotation layer class if no other is appropriate. If there is more than one appropriate layer, ArtiosCAD will use the one that was created first.

Repeated Copy tool

 The second button on the Copy tools flyout toolbar activates the **Repeated Copy** tool when clicked. This tool lets you make copies of selected objects repeatedly until you activate another tool. This tool is available only when there is a current selection. When this tool is active, seven buttons appear on the Status bar.



The two **Placement** buttons control the put-down points. The first button allows only a point (an intersection between two lines, an endpoint of another line, and so forth) to be used as a put-down point. The second button allows any coordinate to be used as a put-down point.

The first two **Rotate** buttons rotate the copy by 90 degrees - the first 90 degrees to the right; the second, ninety degrees to the left. The third button rotates the copy by 180 degrees.

The two **Mirror** buttons mirror the copy vertically and horizontally, respectively.

There are no drag prompts in the Status bar to aid placing the copied objects. The copied objects can be placed using the mouse only.

Copy Rotate tools

 The tenth tool on the Edit toolbar activates the **Copy Rotate Right 90** tool, and when held down, activates the Copy Rotate tools flyout toolbar.



As with the other Copy tools, there must be a current selection for this tool to be available.

To use this tool, select the item(s) to be copied, and click the tool. The selected items will be copied and rotated 90 degrees to the right using the center of the selected item(s) as the handle point. Clicking the tool again makes another copy, but adds 90 degrees to the angle of the copy. Click the tool once, and one copy is made at 90 degrees; click the tool again, and another copy is made, but this time the copy is at 180 degrees from the original. Clicking the tool a third time results in another copy at 270 degrees, and clicking the tool a fourth time makes a copy at 360 (or 0) degrees.

 The second button on the Copy Rotate tools flyout toolbar activates the **Copy Rotate Left 90** tool. This tool works similarly to the Copy Rotate Right 90 tool, but it rotates left instead of right. As with the Copy Rotate Right 90 tool, successive clicks are cumulative - each copy is rotated by 90 degrees more than the last copy.

 The third button on the Copy Rotate tools flyout toolbar activates the **Copy Rotate 180** tool. This tool works similarly to the Copy Rotate Left 90 and Copy Rotate Right 90 tools, but it rotates 180 degrees.

 The fourth button on the Copy Rotate tools flyout toolbar activates the **Copy General Rotate** tool. As with the other Copy Rotate tools, there must be a current selection for this tool to be available.

To use this tool, do the following:

1. Select the item(s) to copy.
2.  Click the **Copy General Rotate** tool.
3. Click the fixed point around which the item(s) will rotate.
4. Click the handle point. This is where the rotational force is applied.
5. Set the angle for the copy by using drag or by entering a value in the **Angle:** field in the Status bar.



6. Once the angle is set, the copy is made. The copy becomes the current selection.

Copy Mirror tools



The eleventh button on the Edit toolbar activates the **Copy Mirror about Vertical** tool, and when held down, activates the Copy Mirror tools flyout toolbar. As with the other Copy tools, these tools are available only when there is a current selection.



The **Copy Mirror about Vertical** tool copies the current selection and mirrors the copy about the vertical (Y) axis. It then activates the Move tool with the copy selected so that you can easily move the copy. To use this tool, do the following:

1. Select the item(s) to be copied and mirrored.
2. Click the **Copy Mirror about Vertical** tool. The item(s) will be copied and mirrored but not offset from the original - the mirrored copy will appear on top of the current selection.
3. Click the pick-up point for the copy.
4. Click the put-down point to place the copy.



The second button on the Copy Mirror tools flyout toolbar activates the **Copy Mirror about Horizontal** tool. This tool works similarly to the Copy Mirror about Vertical tool described previously but mirrors about the horizontal (X) axis instead of the vertical (Y) axis.



The third button on the Copy Mirror tools flyout toolbar activates the **Vertical Copy Mirror About Center** tool. This tool copy-mirrors the current selection about the vertical (Y) axis passing through its center. It does not perform a move. Distribute to Layers is unavailable when using this tool.



The fourth button on the Copy Mirror tools flyout toolbar activates the **Horizontal Copy Mirror About Center** tool. This tool copy-mirrors the current selection about the horizontal (X) axis passing through its center. It does not perform a move. Distribute to Layers is unavailable when using this tool.



The fifth button on the Copy Mirror tools flyout toolbar activates the **Copy Mirror about Line** tool. This tool makes a mirrored copy of the selected items around the line or construction line you select. It does not activate the Move tool afterward. As with the other Copy tools, this tool is available only when there is a current selection. Distribute to Layers is unavailable when using this tool.

To use this tool, do the following:

1. Select the item(s) to be copied and mirrored.
2.  Click the **Copy Mirror About Line** tool.

3. Click the line or construction line to use as the axis around which the copy will be mirrored. The copy is made when you click.
4. The copy becomes the current selection so that other tools may be used on it.

Complete design from half/quarter tool



The twelfth button on the Edit toolbar is the **Complete design from half/quarter** tool. Use this tool to quickly construct a symmetrical design from just a quarter or half of the design. This tool copies the lines and joins them appropriately so that the proper bridging is made.

If there is no current selection, the tool automatically selects all the lines in the layer; to only copy selected lines, select them before activating this tool.

Note: Lines are merged only if they join and can be replaced by a single line. Beziers are not merged. Lines on the mirror axis are not copied.

When this tool is active, three mode selectors are on the Status bar as well as an OK button.



The first mode selector copies the design or selection horizontally.

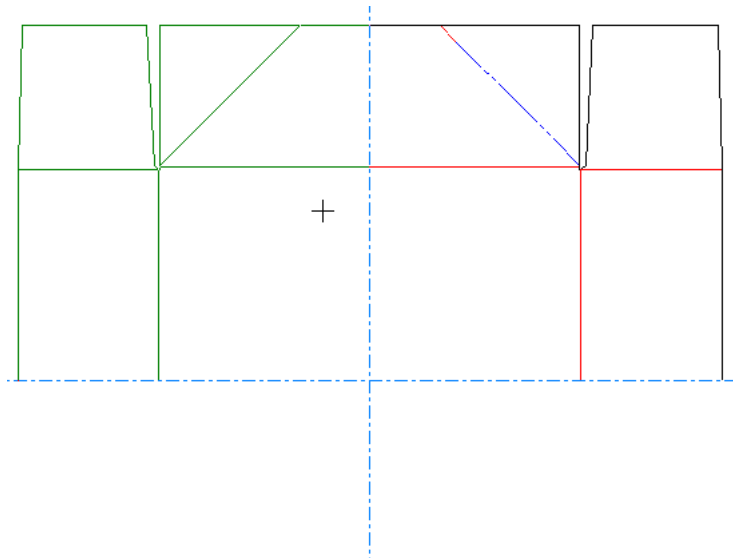

The second mode selector copies the design or selection vertically.

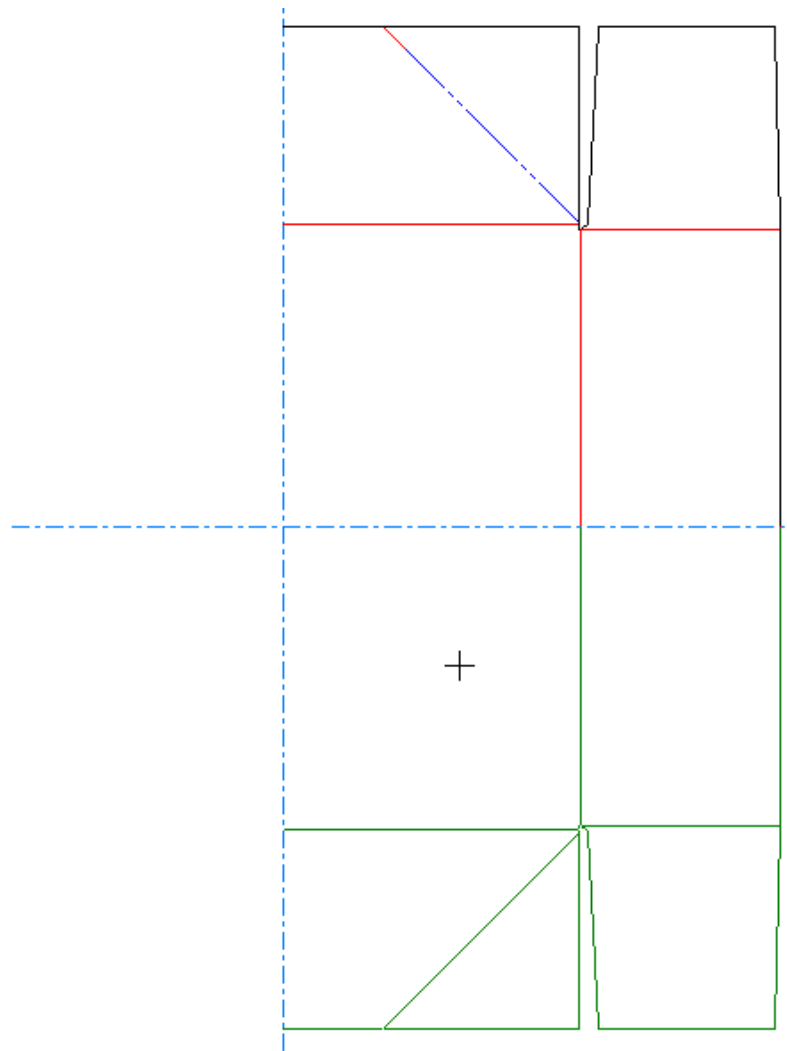

The third mode selector copies the design or selection both horizontally and vertically.

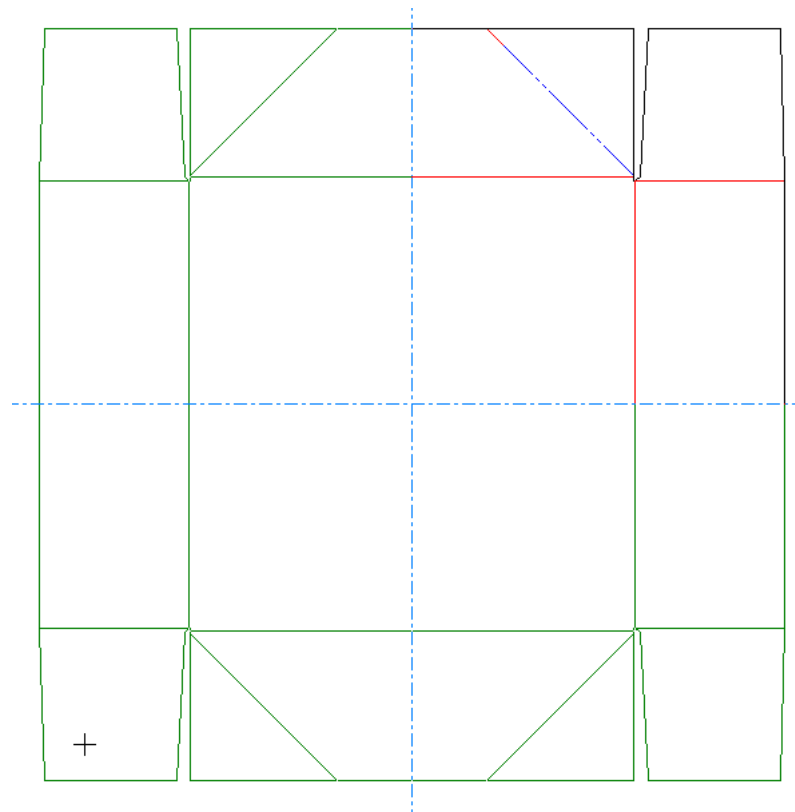

To use this tool, do the following:

1. Design the quarter or half design as you would normally.
2. If you only want to replicate part of the design, use the Select tool to select those lines.
3.  Click the **Complete design from half/quarter** tool.
4. The third mode selector is the default, so if you want only a horizontal copy or a vertical copy, choose one of those modes.
5. If the point about which the copy is to be made is not the origin, click that point.
6. The drag shows what the result will be if you click OK.
7. Click **OK** to make the copy and join the lines. The copied lines are distributed into layers as appropriate.

Shown below is an example of using the tool to complete a quarter design. The first step is to design the quarter to be duplicated.

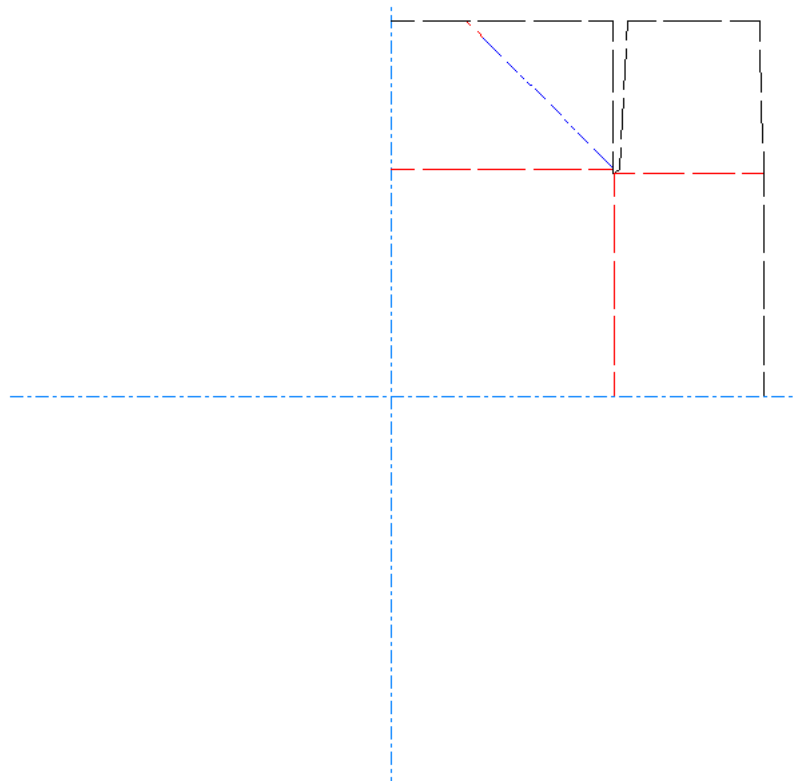

Next, choose the mode selector and drag in the direction of the duplication.

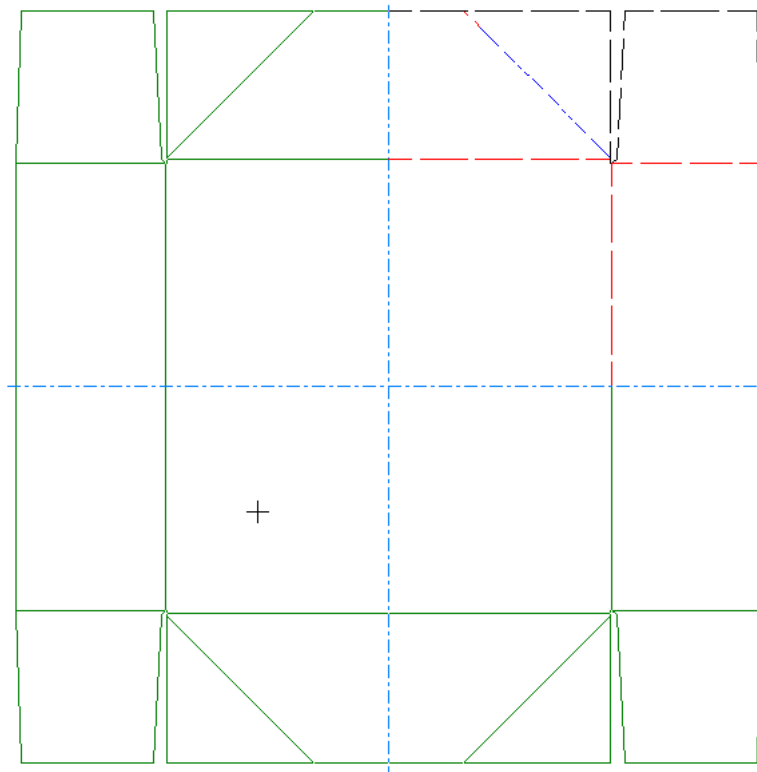

Finally, click **OK** to accept the duplication and join the lines. Note how the bridges span the axes instead of the lines butting against them as they would when using the Copy Mirror tools.

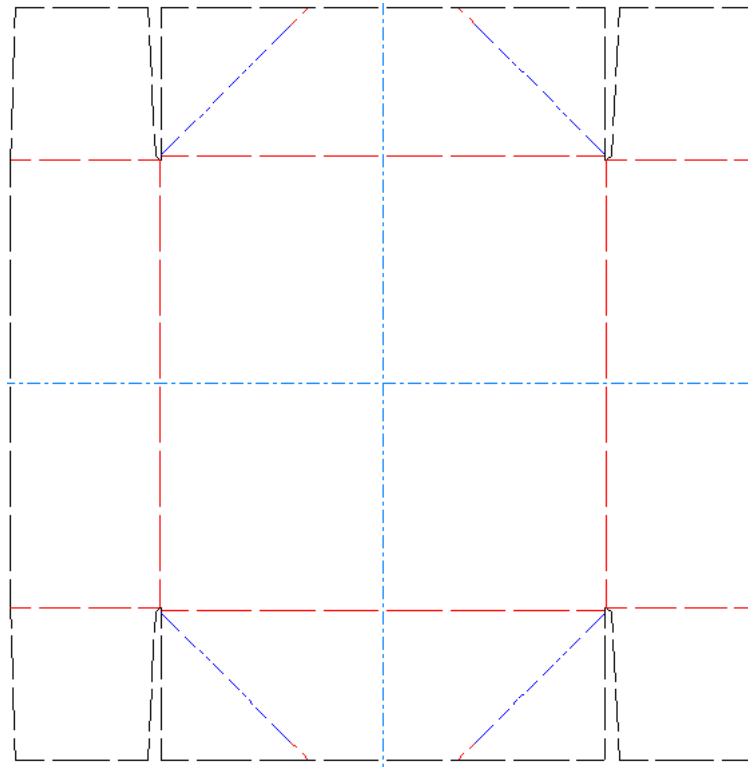

Copy Times tools

 The thirteenth button on the Edit toolbar activates Copy Times Tools flyout toolbar. The Copy Times tools are used to make multiple copies of the current selection and either offset them from the original by a regular distance or rotate the copies around a common point.



 The first button on the Copy Times flyout toolbar, and the default Copy Times tool on the Edit toolbar, activates the **Copy Times Offset** tool. There must be a current selection in order for this tool to be available.

Example of using the Copy Times Offset tool

In the one-piece container shown below, the hole in the lid needs to be repeated throughout the entire lid. Copy Times Offset is the perfect tool for the job.

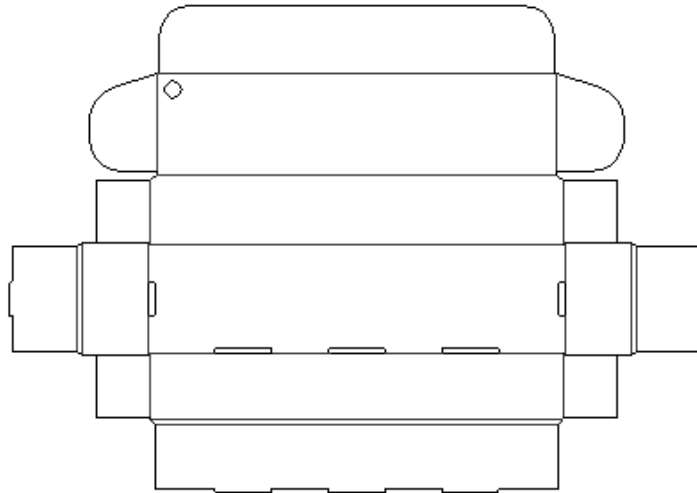

To make the copies, do the following:

1. Use the **Select** tool to select the hole.
2.  Click **Copy Times Offset** and enter the first and second numbers of copies desired in the fields on the Status bar. Press Enter. In this example, 9 copies and then 2 copies will be made, for a total of 30 holes.

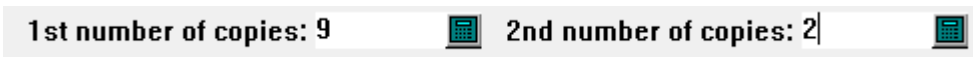

3. Choose the point at the bottom of the hole as the pickup point. Set the angle to 0.

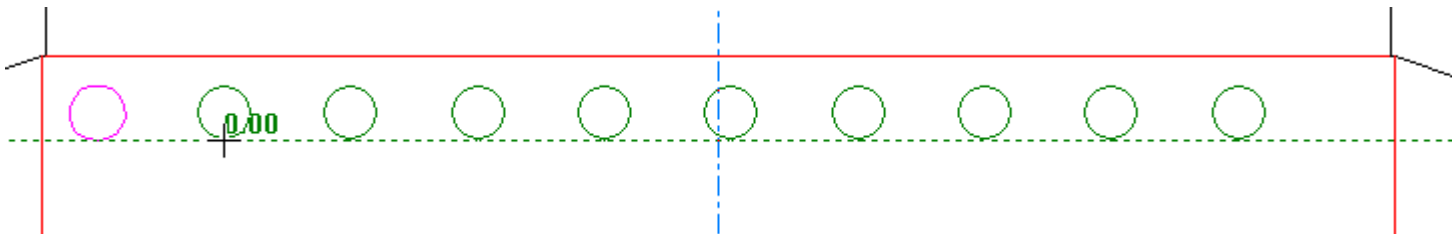

4. Choose the offset distance between the pick-up point and the put-down point.

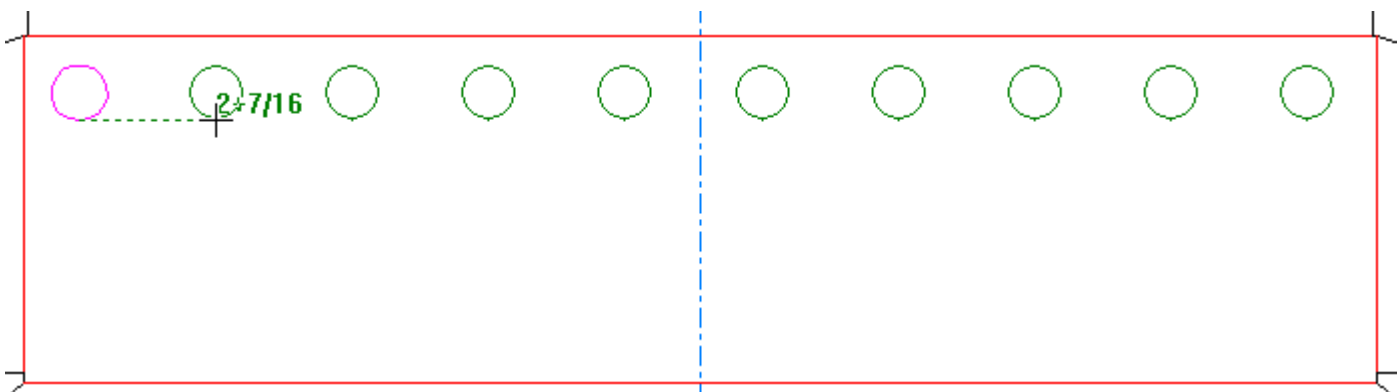

5. Press Enter to confirm the number of second copies on the Status bar.

2nd number of copies: 2 

6. Set the angle for the second copy.

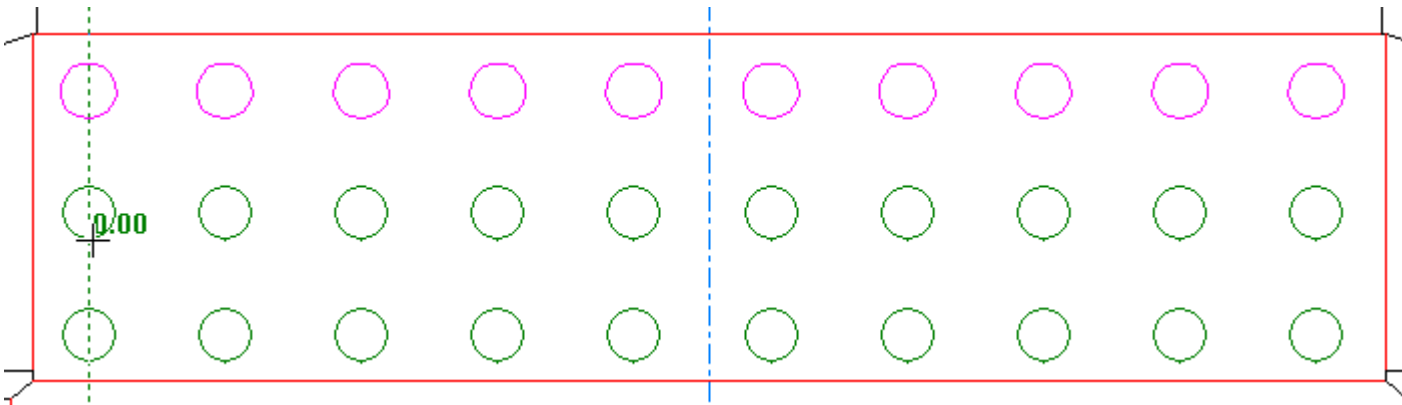

7. Set the offset for the second copy and click to set the put-down point.

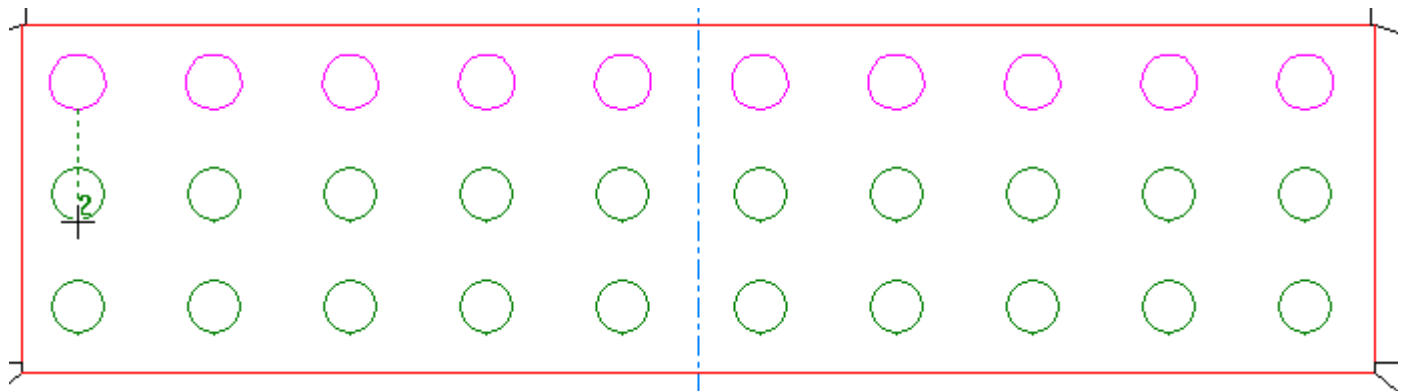

The end product should look like the picture below.

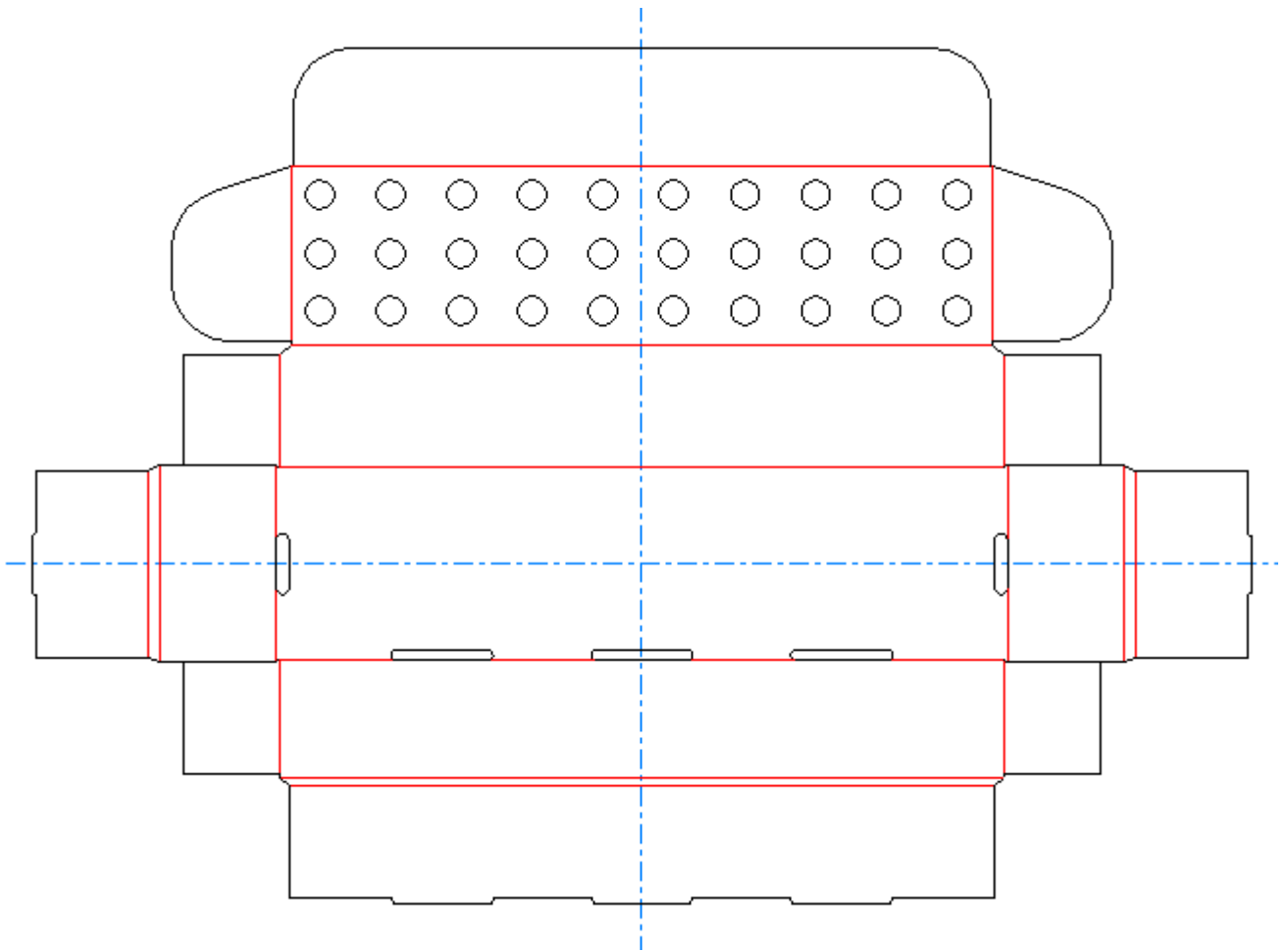

 The second button on the Copy Times flyout toolbar is the **Copy Times Rotate** tool. There must be a current selection for this tool to be available. This tool prompts for the number of copies, the fixed point (the point around which the selection is rotated), and the handle point (the point from which rotation is initiated).

Example of using the Copy Times Rotate tool

The following instructions can be used to make a starburst design in a bottle hanger in ArtiosCAD.

1. Use the **Rectangle** tool to make a rectangle, and then use the **Circle** tool to put a circle in it.

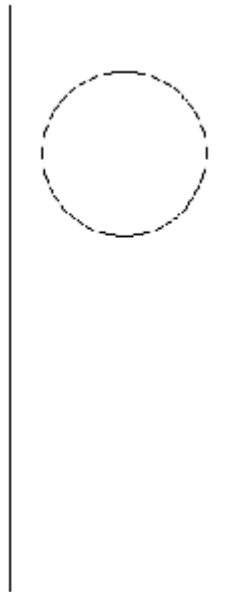

2. Use **Move to Point** to move the current position to the center of the circle.

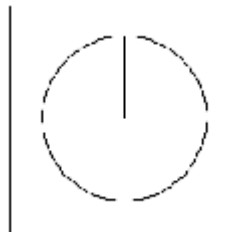

3. Draw a line from the center of the circle to the edge of the circle.
4. Use the **Select** tool to select the line created in Step 3.
5.  Click the **Copy Times Rotate** tool on the Copy Times flyout toolbar.
6. Enter 11 in the **Number of copies:** field.
7. Click the point at the center of the circle as the fixed point.
8. Click the point on the edge of the circle as the handle point.
9. Set the angle to 30 in Quadrant I and click to set the drag angle.



10. Delete the circle and draw a series of straight lines connecting the ends of the radial lines. Change these lines to creases.
11. The starburst opening is now complete.

An example of the design after it has had graphics added and brought into 3D:

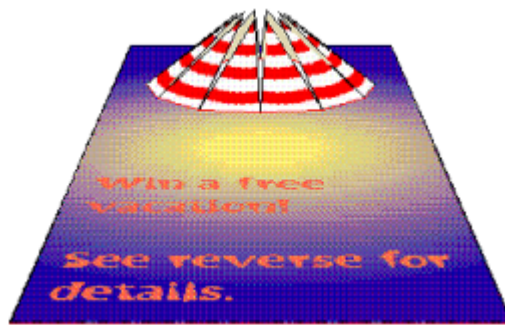



Group tools

 The fourteenth button on the Edit toolbar activates the Group Tools flyout toolbar.

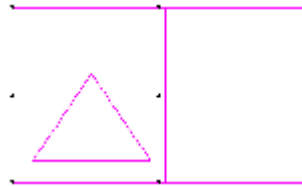

 The first button on the Group Tools flyout toolbar, and the default Group tool on the Edit toolbar, activates the **Ungroup** tool. When clicked, the Ungroup tool removes a level of grouping, making available the individual components or nested groups that comprise the current group.



 The second button on the Group Tools flyout toolbar activates the **Ungroup All** tool. This tool ungroups all items in the current selection, including nested groups, so that the individual components at every level are available.

 The third button on the Group Tools flyout toolbar activates the **Group** tool. The Group tool makes ArtiosCAD treat multiple objects as one object. A group shows nine handle points when it is selected. Multiple groups may be nested together to form one large group.

 The fourth button on the Group Tools flyout toolbar is the **Group Sequence** tool. You must have a current selection for this tool to be available, and the selected lines should be the same line type. When clicked, this tool groups the selected sequential lines together. To use this tool, select the lines to group, click **Group Sequence**, and optionally check **Reverse** on the Status bar to reverse the line direction.

If your current selection includes more than one path, ArtiosCAD groups each path separately. If your current selection contains mirrored special rules, ArtiosCAD converts them to the same line type.

Offset Lines tool



The fifteenth button on the Edit toolbar activates the **Offset Lines** tool. This tool moves or copies offset lines from the current selection, which must be a selection of end-to-end lines. Shown below are its controls on the Status bar.

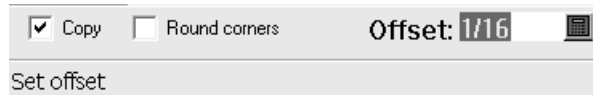

Copy copies the current selection. When it is off, the current selection is moved by offset.

Round corners inserts blends on corners where the offset is outward from the corner. No blends are added when the offset is inward.

Offset sets the amount of the offset.

To use this tool, select the lines to offset, activate the tool, check **Copy** or **Round Corners** as desired, and set the drag either using the mouse or by entering the offset directly in the field. The current selection will be moved or copied accordingly.

Horizontal/Vertical tools

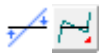

The first button on the Adjust Outline toolbar activates the Horizontal/Vertical flyout toolbar.

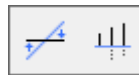

The first button on the Horizontal/Vertical flyout toolbar, and the default Horizontal/Vertical tool on the Adjust Outline toolbar, activates the **Make Horizontal/Vertical** tool. The Make Horizontal/Vertical tool makes the line you select either horizontal or vertical depending on which axis forms an acute angle in conjunction with the selected line.



The second button on the Horizontal/Vertical flyout toolbar activates the **Align Horizontal/Vertical** tool. Using this tool, you can align a series of points and the lines between them. Click the tool, drag a window that encompasses all the points to align, and then indicate the alignment point. Once the window is defined, all the lines and points in the window turn magenta to indicate they are selected.

Merge Lines tools



The second button on the Adjust Outline toolbar activates the Merge Lines flyout toolbar.



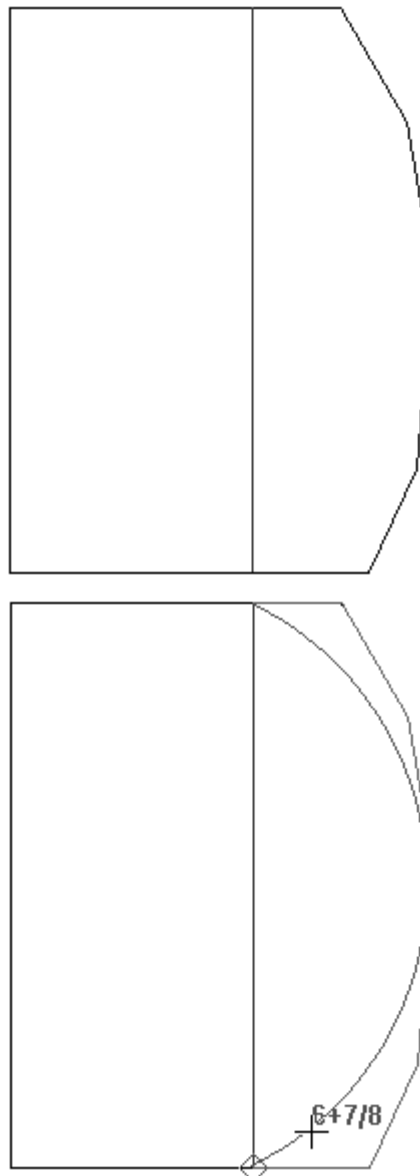

 The first button on the Merge Lines flyout toolbar, and the default Merge Lines tool on the Adjust Outline toolbar, activates the **Merge Lines Straight** tool. This tool merges a series of connected lines, arcs, or beziers into one straight line. Click the tool, indicate the first line in the series, and then indicate the last line in the series. The various lines will merge into one line.

 The second button on the Merge Lines flyout toolbar activates the **Merge Lines Into Arc** tool. This tool merges a series of connected lines, arcs, or beziers into an arc. Click the tool, indicate the first line in the series, indicate the last line in the series, and set the radius of the arc. The various lines will merge into an arc.

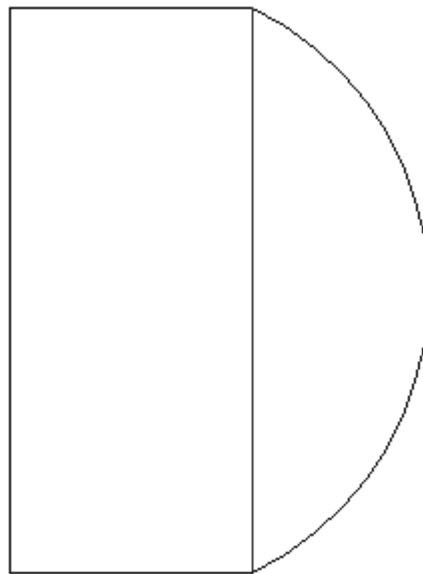





 The third button on the Merge Lines flyout toolbar activates the **Merge Lines Into Bezier** tool. This tool merges a series of connected lines, arcs, or beziers into a bezier. Click the tool, indicate the first line in the series, indicate the last line in the series, and then set the control points for the bezier. The various lines will merge into a bezier.

 The fourth button on the Merge Lines flyout toolbar activates the **Merge Lines to Intersection** tool. This tool merges a series of selected lines, arcs, or beziers into two lines that intersect. Click the tool, indicate the first line in the series, and then indicate the last line in the series. The first and last lines will intersect and any intermediate lines will be deleted.

Adjust Arc tools

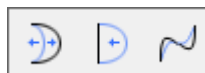
 The third button on the Adjust Outline toolbar activates the Adjust Arc flyout toolbar.





 The first button on the Adjust Arc flyout toolbar, and the default **Adjust Arc** tool on the Adjust Outline toolbar, activates the Adjust Arc tool. Use the Adjust Arc tool to adjust the radius of any arc. Straight lines may be converted into arcs using this tool.

 The second tool on the Adjust Arc flyout toolbar activates the **Straighten** tool. This tool prompts for the selection of an arc or bezier and then replaces it with a straight line.

 The third tool on the Adjust Arc flyout toolbar activates the **Adjust Bezier** tool. This tool converts a line or arc into a bezier, or lets you adjust the control points of an existing bezier. The control point of the bezier you adjust using this tool is determined by which end of the object you clicked closer to when selecting the object to adjust.

Direction tools

 The fourth tool on the Adjust Outline toolbar activates the **Reverse Direction** tool. This tool reverses the cutting direction of objects selected after activating this tool. Activate the tool and then indicate the line, arc, or bezier whose direction is to be reversed.

 The fifth button on the Adjust Outline toolbar activates the **Sequence** tool. This tool:

- Lets you manually specify the cutting order of lines and groups in the design.
- Works with lines, arcs, beziers, text, dimensions, and arrows.
- Works in any non-empty layer in Designer, but only works in user-defined or output layers in Manufacturing.
- Does not work with graphics or file windows, or with counter layouts.
- Disables the ability of a design to be rebuilt when used in a layer other than an output layer.

Note: There are important notes and warnings regarding using this tool and Outputs in the next section. Please read them carefully before using this tool.

If there are either graphics or file windows in the current layer, a dialog box asks you to either delete the graphics or exit the feature. Click **OK** after making your choice.

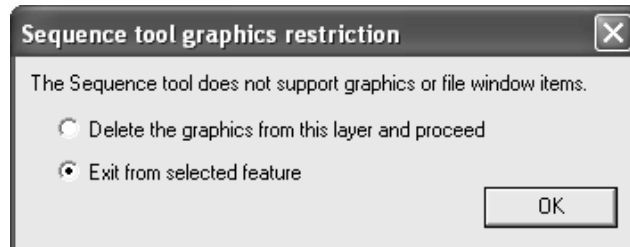

The standard Disable Rebuild dialog box appears if the design is rebuildable.

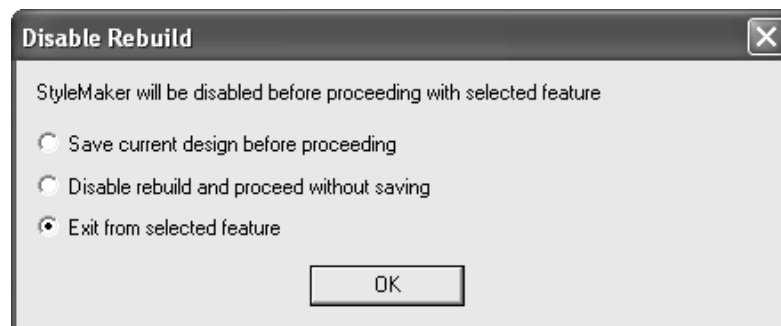

Once all the warning dialog boxes have been dismissed, the tool is active. All items not in the current layer turn gray, and line direction arrows and line numbers are turned on.

 The seventh button enters a group to let you resequence the items it contains. It is available only when a group is currently selected.

 The eighth button leaves a subgroup and resumes working in the level above it.

The third group of buttons on the Status bar controls the sequencing in the current level.

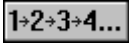
 The ninth button sequences all the items and subgroups in the current group. Click the first item to sequence and click the rest of the items in the desired sequence.

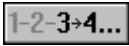
 The tenth button sequences a range of items. Click the item which immediately precedes the first item to resequence, and then click the rest of the items in the desired sequence.

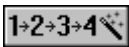
 The eleventh button automatically sequences all the items and subgroups in the current group, and also makes subgroups out of connected items.

The third group of buttons on the Status bar controls the direction of lines and options for the tool.

 The twelfth button reverses the lines in the current selection, or all the items in the group if there is no current selection.

 The thirteenth button opens the Sequence Tool Options dialog box as shown below.

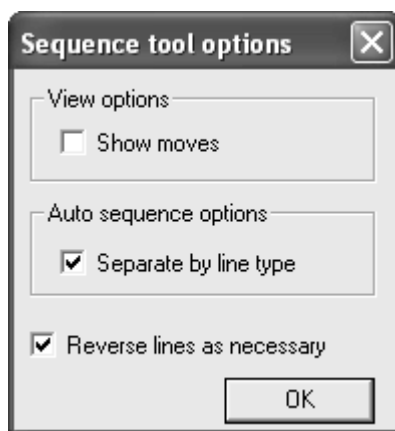

Show moves, when checked, shows a green dotted line between the end of one item and the start of the next. If the items are in a subgroup, it draws light blue dotted lines.

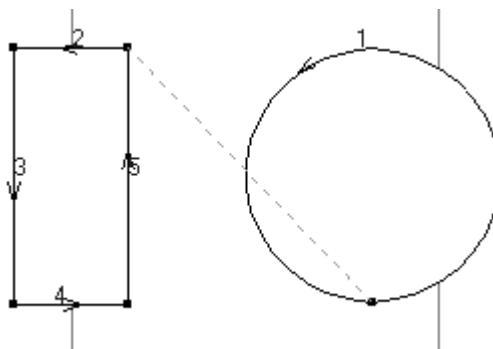

Separate by line type, when checked, causes the Auto Sequence button to separate the lines by type and pointage into groups, and then sequence each group. If text, arrows, or dimensions are present, they are moved into one group, and numbered in light green. When the option is not checked, lines are sequenced together regardless of type and pointage.

Reverse lines as necessary, when checked, reverses lines as needed to yield the best sequence. For the Sequence All and Sequence Range buttons, the first item selected is not reversed. When the second item is selected, both the first and second items may be reversed depending on the position of their start and end points. When the third and subsequent items are selected, they may be reversed, but the preceding items will not be reversed. For the Auto Sequence button, a new subgroup is created for each move, replacing any subgroups. When this option is not checked, the direction of lines does not change. However, the order of existing lines and subgroups changes, but the items within the subgroups do not change order.

Using the Sequence tool with Outputs

As most Outputs are configured to automatically resequence, it is important that you follow these procedures when outputting resequenced lines.

Sample output. In Defaults, copy an existing samplemaker output, rename it, and configure it using **Workspace Layer** for the **Driver Type** on the Device tab. Name the layer something appropriate such as **Resequenced**. If you plan to use this tool for sample layouts as well, clear the **Sequence one-ups in layout** checkbox on the Sample Sequencing tab. This has to be done only once.

Once the Output has been set up, use it, and then change to the layer just created. The line types will have been changed to sample line types. Use the **Sequence** tool as desired, and then output that layer to the samplemaker normally. The cutting order for lines set as sample line types will not be changed.

Plot output. In Defaults, copy an existing plotter output, rename it, and select **No optimization** in the **Optimization options** group on the Processing tab. If you plan to use this tool before plotting sample layouts as well, clear the **Sequence one-ups in layout** checkbox as well. This has to be done only once.

CAM output maintaining exact sequencing of all lines. In Defaults, copy an existing CAM output and rename it. On the Tool Selection tab of the new entry, set all the different tools to belong to group one, and then on the Optimization tab, clear the **Optimization** tab for group one. This entry will then maintain manual sequencing.

CAM output with optimized grouping but maintaining exact sequencing of lines within the optimized groups. In Defaults, copy an existing CAM output and rename it. On the Optimization tab of the new entry, clear the **Optimize** checkbox for each group in which manual sequencing is desired. Arrange the groups and sequencing as appropriate to achieve the desired results. When used, this Output will move the sequenced lines into the groups as defined, but will not reorder the lines in a group if the checkbox is not checked for that group.

Counter output. Counter outputs do not support manual sequencing.

Working with non-geometric elements

Non-geometric elements are elements of an ArtiosCAD design that are not burned on the die. They usually serve to organize parts of the design or to provide more information about the geometric elements.

Layers

ArtiosCAD uses the concept of layers to build a complete design. Think of a piece of paper with a drawing of a basic container. Then on top of that, add transparencies. One transparency could contain dimensions, another could contain art, and yet another could contain additional design geometry such as a window or an optional flap. A design may have up to 100 layers. All designs have one layer called Main Design. Designs made using standards may have many layers depending on the complexity of the standard.

Use layers to keep different parts of the design from interfering with each other. For example, if you are doing intricate design work, dimensions might clutter the workspace. Putting the geometry in one layer and the dimensions in another allows you to turn the dimensions off when desired.

Another reason to use layers is to control the flow of information. When exporting data from ArtiosCAD into a different format, only the layers that are turned on are exported. This way you can put sensitive data in one layer, turn it off, and then export the geometry to a file for your diemaker.

ArtiosCAD works with the layers that are turned on. Only layers that are visible are printed or exported to a file. However, all layers are saved when the design is saved regardless of their viewing status.

The layers that are displayed when a design is opened depends on the setting in **Options > Defaults > Shared Defaults > Design Defaults > Default View Mode**. You can choose to display the layers as they were when the design was saved, or you can choose to always display the same set of layers.

Layers are controlled by the Layer button on the View bar. The Layer button shows the name of the current layer - it is not labelled "Layer."

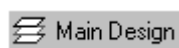

Clicking the Layer button activates the Layers dialog box. Shown below is a sample Layer dialog box.

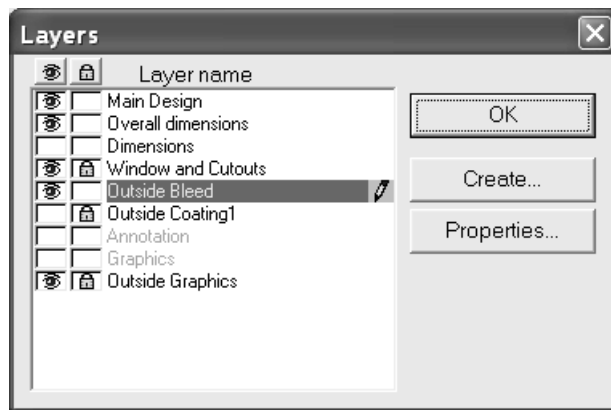

The current layer is highlighted and has a pencil icon at the right end of the highlight. Empty layers have dimmed names. Click the name of a layer to switch to it.

By default, the Layers dialog box in Single Design lists layers in the order in which they were created. To change the list order, change the default in **Options > Defaults > Design defaults > Layers Dialog Display Order** between **Show layers in the order they were created** and **Show layers in the order they are drawn**. The Layers Properties dialog box shows layers in the order in which they are drawn.

At the far left of the dialog box is the **Visibility** column. An eye icon in the box indicates the layer is turned on. Click the box to turn the layer on or off. The eye button at the top of the column turns all layers off except the current layer.

Between the Visibility column and the layer name is the **Lock** column. A padlock icon indicates the layer is locked and its contents may not be selected or changed. Click the box to lock or unlock the layer. The padlock button at the top of the column locks or unlocks all layers.

If **Temporary Dimensions** mode is active while in a **Dimensions** or **Overall Dimensions** class layer, when the Layers dialog box is opened, the pencil icon for the layer is dimmed to indicate **Temporary Dimensions** mode. It returns to normal when **Temporary Dimensions** mode is turned off.

If you have items selected when turning a layer on or off, if those items reside in the layer whose status is changing, the selection is cleared; otherwise, the items remain selected.

Locked layers

If you try to modify a locked layer with a tool that uses drag, the cursor changes to a pen with a red line through it as shown below, and no tools work. You must unlock the layer before attempting to modify it.



Attempting to use tools without drag in a locked layer results in **Current layer is locked** in the Status bar.



When you click a tool which requires a layer selection, ArtiosCAD indicates in various ways that a layer is locked and must be unlocked before it can be selected for use with the tool. Several examples of the different types of dialog boxes are shown below.

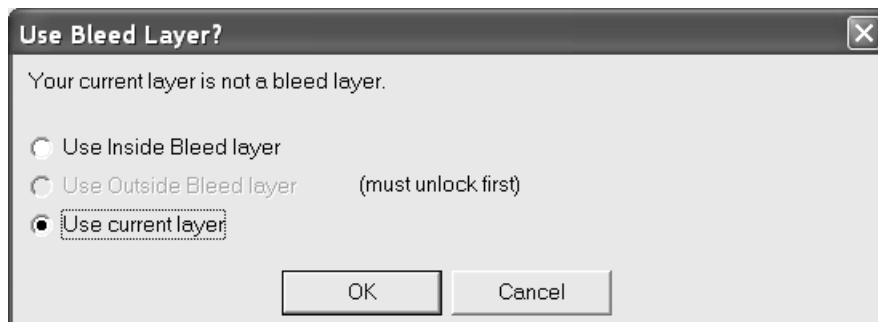
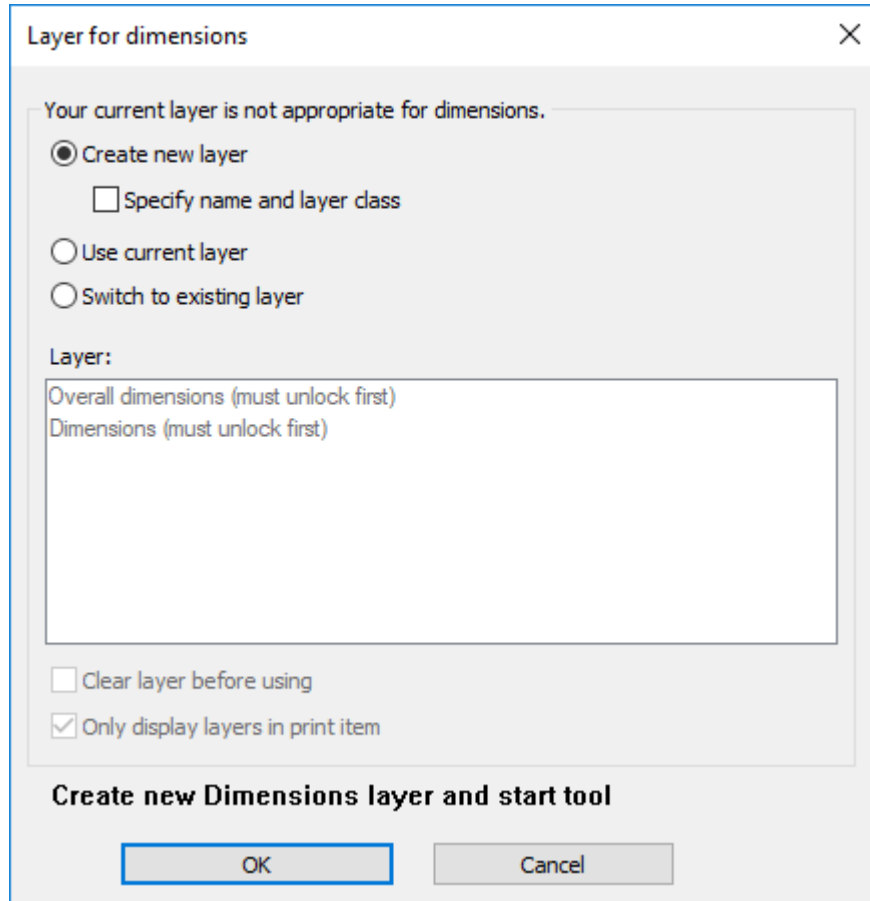

If you have items selected when locking or unlocking a layer, if those items reside in the layer whose status is changing, the selection is cleared; otherwise, the items remain selected.

For canvases, ArtiosCAD respects part-specific locks. The layer selection dialog box will allow you to go to layers that are locked in the active part but not for all parts, because most tools allow you to change the active part while in the tool.

Appropriate layers

When changing layers, ArtiosCAD checks that the current line type is appropriate for the layer class. For example, when switching to a Dimensions layer, ArtiosCAD checks the current line type, and if it is inappropriate (such as Cut or Perf), ArtiosCAD changes it to a type appropriate for the layer class (such as Annotation).

After changing layers, if you try to change the current line type to an inappropriate type for the layer and then activate any of the line-drawing tools on the Geometry toolbar, ArtiosCAD warns you as shown below.

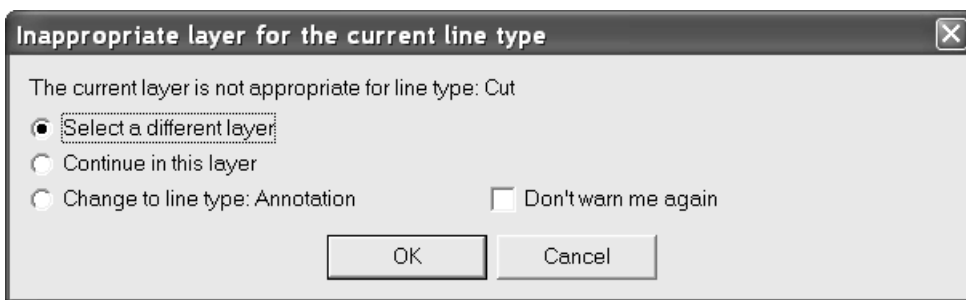

Select a different layer lets you choose a different layer in which to work, or to create a new layer. The list of layers shown contains only layers of those classes appropriate for the chosen line type. Choose a layer from the list and click **OK**, or click **Create New** to create a new layer.

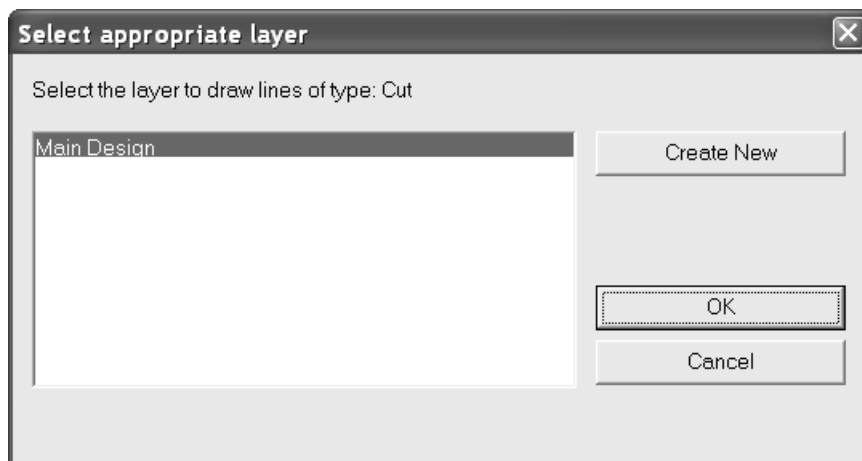

Continue in this layer keeps the line type you selected. Once one formerly inappropriate line is placed into a layer, ArtiosCAD will not warn again for that type in that layer.

Change to line type: line type changes to the line type ArtiosCAD suggests for this layer class.

Don't warn me again turns off all inappropriate layer warnings for the current ArtiosCAD session.

Automatic layer switching

ArtiosCAD can automatically change layers as you work if you have automatic layer switching enabled. For example, if you are working on a new design and want to add dimensions, when you click one of the Dimension tools, ArtiosCAD automatically creates a Dimensions layer and changes to it before starting the tool. When you choose another tool, ArtiosCAD returns you to the previous layer.

When this feature is active, ArtiosCAD checks to see if there are any valid layers for it to switch to. A valid layer is:

- in the current print item (if any print items exist)
- unlocked
- is of the default class (if **Switch only to layers of default class** is also enabled)

If there are no valid layers, ArtiosCAD creates one.

If there are two or more valid layers for them, ArtiosCAD will always prompt for bleed and varnish tools regardless of how its options are set.

If the current layer is of an appropriate class or already has an item of type the tool creates, ArtiosCAD stays in the current layer with no prompt.

If you turn this feature off, when you activate a tool needing an appropriate layer, ArtiosCAD prompts you to either:

- Create a new layer (and optionally specify its name and class)
- Use the current layer
- Switch to an existing layer (and optionally clear everything already in that layer if it is not empty).

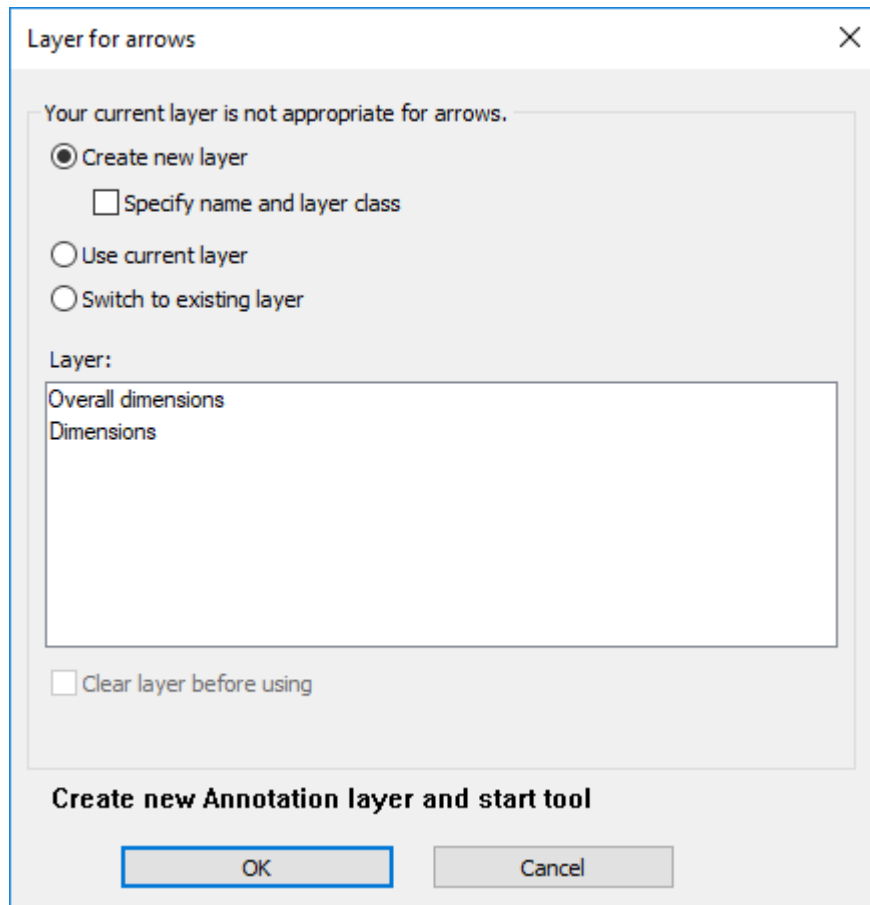

If you choose to specify the name and class of the new layer, ArtiosCAD displays controls for doing so. When you choose to switch to an existing layer, you can then click the target layer name and choose to delete its contents or not. Whatever you choose, the message above OK and Cancel changes to show the action ArtiosCAD will take when you click **OK**.

For canvases, ArtiosCAD respects part-specific locks. The layer selection dialog box will allow you to go to layers that are locked in the active part but not for all parts, because most tools allow you to change the active part while in the tool.

For counters, ArtiosCAD does not automatically switch layers.

Setting autoswitch options

Autoswitch behavior is configured in **Options > Tool Layer Options** while you are working on a design. It is seeded from Startup defaults and any changes you make persist through the session.

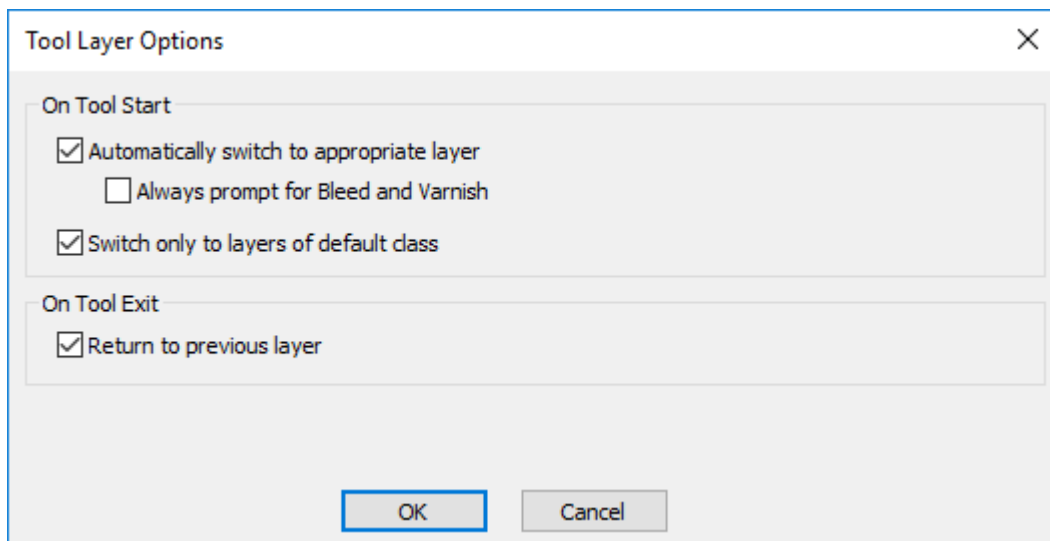

Automatically switch to appropriate layer turns this feature on and off.

Always prompt for Bleed and Varnish causes ArtiosCAD to always prompt for tools that would switch to those layers.

Switch only to layers of default class causes ArtiosCAD to only switch to layers whose classes match their names. For example, if this option were enabled and you had a layer called Dimensions but it was class Windows and Cutouts, ArtiosCAD would not switch to that Dimensions layer automatically when you started a Dimensions tool.

Return to previous layer controls how ArtiosCAD behaves when you finish using the tool that changed layers and activate a different tool.

Adding layers

To add a layer, click the Layer button on the View bar. Then click the **Create** button to activate the Create Layer dialog box. Click the class for the new layer. The class name will be used as the name of the new layer by default. If you want to name the layer something else, erase the contents of the **Name:** field and enter the desired name. Click **OK** to create the layer or **Cancel** to cancel the creation. When you create a new layer, you are placed in it automatically. The Layers dialog box will remain open after you create a layer.

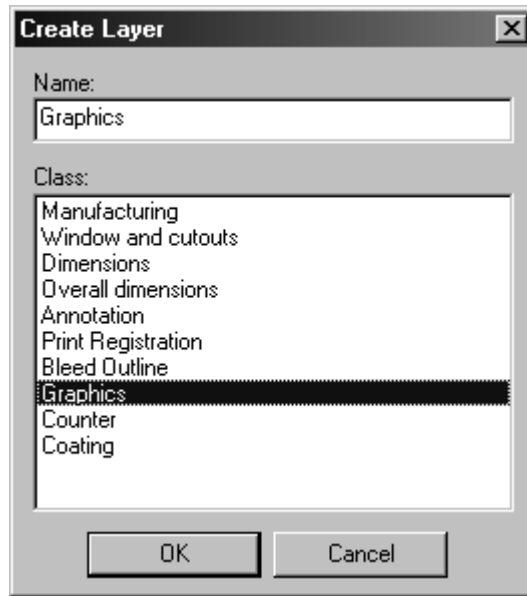

Manipulating layers

To turn a layer on, check the checkbox next to its name in the Layers dialog box.

To turn a layer off, clear the checkbox next to its name in the Layers dialog box.

The current layer is the one showing a pencil to the right of its name. You cannot turn off the current layer. To change the current layer, click the name of a different layer.

To change the name or class of a layer, select it in the Layer dialog box and click **Properties**. The Layer Properties dialog box will appear.

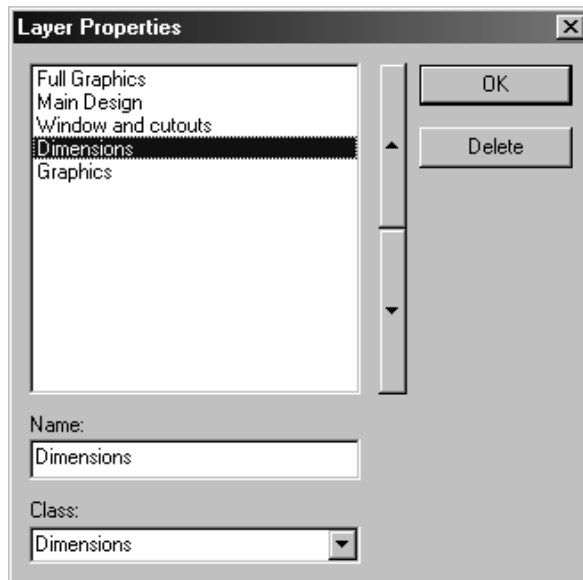

The names of the layers correspond to their position in the design. The layer at the top of the list is drawn first; the layer at the bottom of the list is drawn last. Layers toward the bottom of the list mask those toward the top of the list. Click the two arrows at the side of the list to re-order the selected layer.

Deleting layers

To delete a layer, do the following:

1. Click the Layer button on the View bar.
2. Click **Properties** in the Layers dialog box.
3. Select the layer to delete.

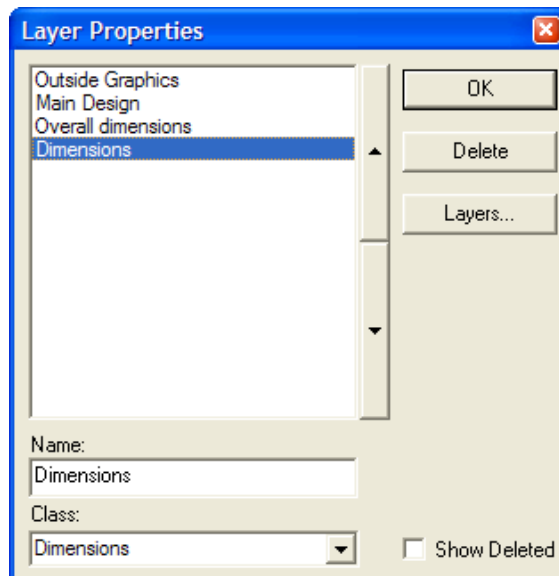

4. Click **Delete**. The name of the layer disappears from the list.

When you delete a layer, the current selection is reset, any extended items are reset, and the current tool is restarted after the layer is deleted. If you delete a layer while using a tool that requires a specific layer such as a bleed layer or coating layer, that tool will be finished and the Select tool will be activated.

Note: Deleting most layer types removes them from the layers listed in the Layers and Layer Properties dialog boxes and also removes the contents of the layer. However, any variables associated with the layer remain. **DocPlot** layers (made with Advanced StyleMaker) and **Output to Layer** layers (made with an Output) are physically deleted from the workspace. Opening a workspace containing deleted layers in an earlier version of ArtiosCAD will warn about unknown commands, but you may safely ignore that warning.

Reusing a deleted layer

ArtiosCAD workspaces have a limit of 251 layers (including Main Design). If you delete many layers, you may encounter this restriction unexpectedly when creating a new layer. To avoid this limit, you can reuse a deleted layer by removing its deleted marker.

To reuse a layer, do the following:

1. Click the Layer button on the View bar.
2. Click **Properties** in the Layers dialog box.
3. Check **Show Deleted**. (This needs to be done only once per ArtiosCAD session.)
4. Select the layer to reuse. It will have **(Deleted)** after its name.

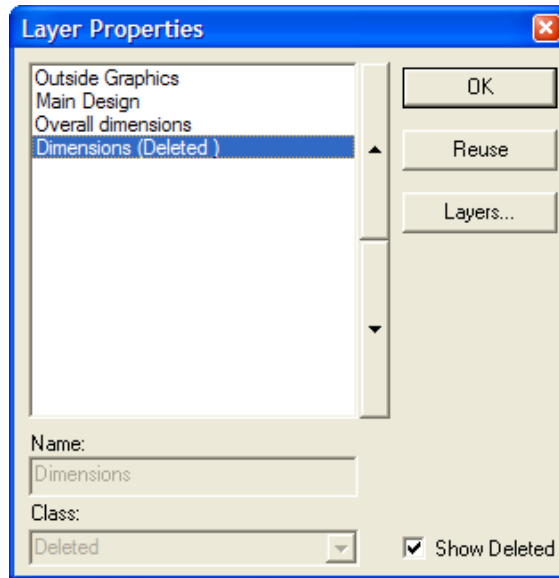

5. Click **Reuse**.
6. Set the **Class:** field appropriately for the content of the layer.
7. Click **OK**.
8. Change the contents of the layer as desired.

Moving items between layers

There are two ways to move items between layers. The first is to cut and paste, and the second is to use the **Move to Layer** tool. For the first method, see below; for the second, see the Move to Layer tool information in the Changing physical properties section of the Designer chapter.

To move items between layers, do the following:

1. Select the items to move and cut them as enhanced metafiles using **Edit > Copy > Copy as Enhanced Metafile**, or press CTRL-C. This requires the Designer module.
2. Click the Layer button on the View bar and set the current layer to the one where the objects are to be placed.
3. Paste the objects into the new current layer.

Note: Items copied and pasted between layers are not checked for appropriate line types.

Annotations and Dimensions

See the *Builder* chapter for complete instructions on using Annotation and Dimension tools.

Graphics

Graphics add color and excitement to your designs. Anyone can view ArtiosCAD designs containing graphics, but you must have the ArtMaker module in order to add graphics to

a design and manipulate them. Graphics are manipulated using the tools on the Graphics toolbar.



Adding graphics

One way to add a graphic to your design is to open it in your drawing application (such as Adobe Illustrator or Microsoft Paint), copy it to the Windows clipboard, and use the Paste command in ArtiosCAD.

Another way is to use the **Import File** command on the File menu and choose the file.



Another way to add a graphic to your design is to use the **Add Graphics** tool on the Graphics toolbar. This prompts you for the filename of the bitmap image you want to add.

Whichever method you use, ArtiosCAD adds the graphic to the current side of the design. Use the **Side** control on the View bar to change the side of the design to the desired side before adding a graphic.

When you click **Add Graphics**, ArtiosCAD opens the last directory accessed. To add graphics from a file not in this directory, navigate to the desired directory, select the file, and click **Open**.

ArtiosCAD can import TIFF, BMP, JPEG and PNG files in 24-bit color, 8 bits each for Red, Green, Blue.

For JPEG files, ArtiosCAD can import JPEG files up to 6000 by 6000 pixels. Likewise, ArtiosCAD can import PNG files up to 6000 by 6000 pixels.

TIFF has several different compression tags, but ArtiosCAD can only import uncompressed color data. When ArtiosCAD imports a CMYK TIFF, it converts it internally to RGB. The maximum image size that can be plotted at a reasonable speed is about 28MB less than the memory in the computer. The uncompressed image size is calculated as width multiplied by height (in pixels) multiplied by 3 bytes per pixel.

When saving the TIFF file for use in ArtiosCAD, use an integer for the number of pixels per unit of measurement, for example, 72 dots per inch, not 72.5 dpi.

Note: If the desired graphic file has more than one period in the name, rename it so there is only one period in the name.

Regardless of which method you use, once the image is in your design, ArtiosCAD automatically selects it and starts the **Move** tool. Click the pick-up point, set the drag, and then click the put-down point.

The Edit tools work on graphics – use them to fine-tune the appearance of the graphic. When using the Select tool to select a graphic, click the graphic's edge. The edge of the graphic should turn magenta and handle points should appear.

Any graphics are compressed when the design is saved. If you will be sending files to other people using versions of ArtiosCAD earlier than 6.5x, you must export them using the appropriate entries in the **File > Export** menu.

Register bitmap



The **Register Bitmap** tool, the second button on the Graphics toolbar, is used to align a bitmap precisely with the design. Use this tool when you get artwork for the entire design from an outside source. The bitmap will be associated with the current print item; change to another print item if desired before using this tool.

To use **Register Bitmap**, do the following:

1. Add the graphic, then click **Register Bitmap**.
2. Click the edge of the bitmap to register.
3. A dialog box appears asking what to clip against, the side of the design the bitmap will be on, whether to clip, and whether to scale to fit. If you set the **Side** to **Outside**, the graphic is added to the Outside Graphics layer; if you set the **Side** to **Inside**, the bitmap is added to the Inside Graphics layer. If a layer is locked, you may not choose it until you unlock it.

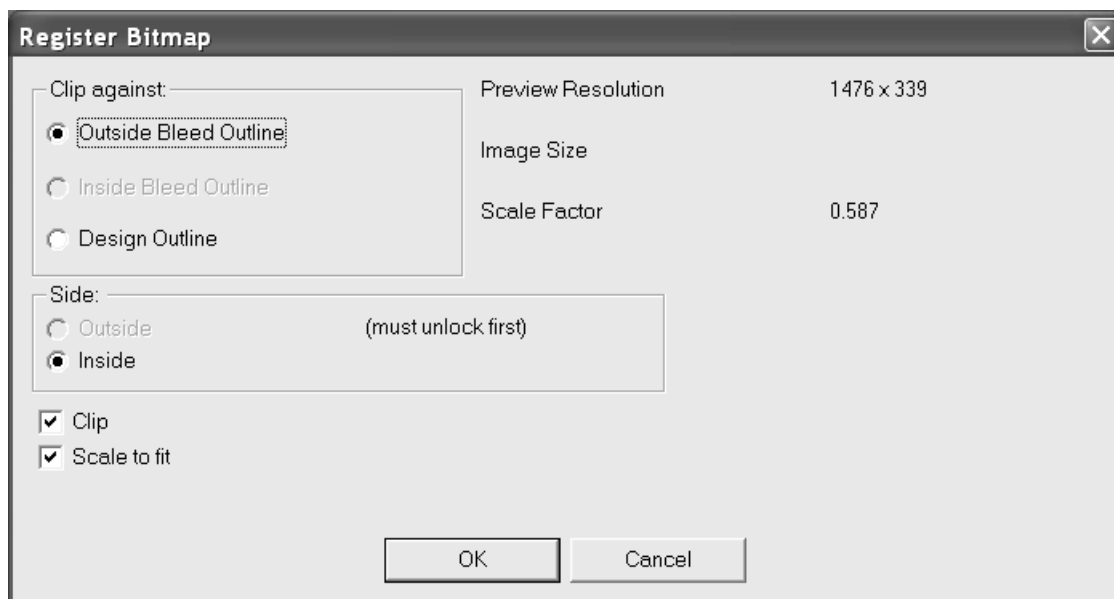

4. Click **OK** and the bitmap will be scaled to fit within the edges of the design or outline selected in the **Clip against** group.

To replace a registered bitmap and change the clipping and scale options, double-click the graphic to access its Properties. In the Properties dialog box, click **Browse** and select the new graphic. The Position Image dialog box appears as shown below. **Use same scale as old image** disables all options except the Position group and replaces the graphic at the same size. Set the options as desired and click **OK**.

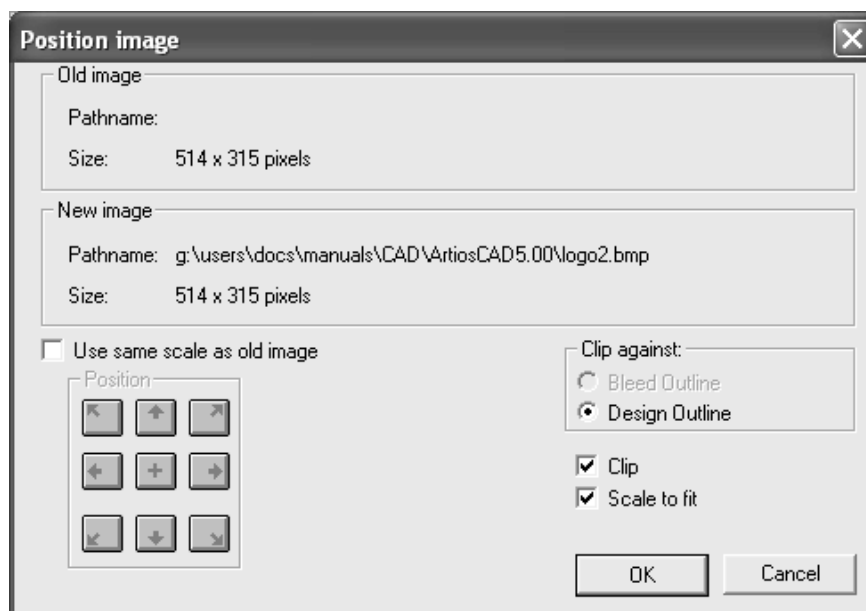

When registering a bitmap to a multi-piece single design, use this workflow: To register to the design, add the image to the design. Use the **Select** tool to select the manufacturing lines for a piece (without the bleed). To register to the bleed, select the bleed lines, without the manufacturing lines, selecting a connected loop of lines. Click the **Register Bitmap** tool. In the **Register Bitmap** dialog box, the **Clip Against** option button will lead to **Outside Bleed**

Outline, Inside Bleed Outline, or Design Outline depending on the selection. Click **OK** to register the bitmap.

Clip graphics



The third button on the Graphics toolbar activates the **Clip Graphics** tool. Use this tool to trim the edges of a graphic against a loop of lines in the design (called a *clipping path*). Click this tool, indicate the graphic to clip, indicate the clipping path, and click **OK** on the Status bar.

Replace graphics



The fourth button on the Graphics toolbar activates the **Replace Graphics** tool. This tool replaces one graphic in the design with another graphic in the design. The replacement graphic must already be in the design before activating this tool. Click the tool, indicate the graphic to be replaced, and then indicate the graphic doing the replacing. If the replacement graphic is a different size than the original, a dialog box will appear showing the difference in size and the necessary scale factor for the replacement graphic to be the same size as the original.

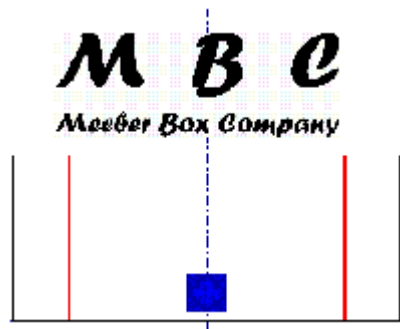

The MBC logo is to replace the existing graphic. After you activate the **Replace Graphics** tool and indicate the two graphics, ArtiosCAD prompts for confirmation of the replacement.

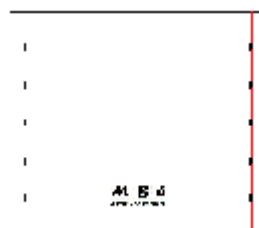
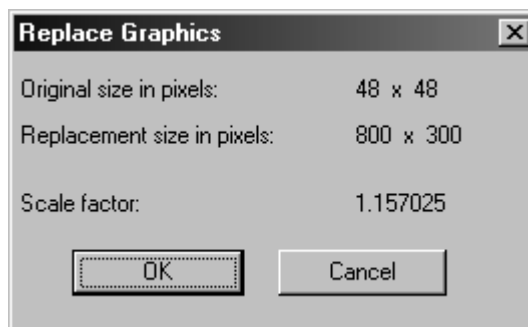

Move Graphics



The **Move Graphics** tool moves a graphic from one place to another.

To use this tool, ensure there is a graphic in the workspace, and then do the following:

1.  Click the **Move Graphics** tool.
2. Click the location to use as the pick-up point. It can either be on the edge of the graphic or within the boundaries of the graphic.
3. Move the mouse cursor to the desired put-down location and click the mouse button. Unlike the pick-up point, the put-down location will snap to points as well as a plain coordinate. The graphic will move appropriately.

AutoTrace bitmap



The **AutoTrace Bitmap** tool on the Graphics toolbar converts a bitmap image (such as a TIFF or BMP file) into lines and arcs that can be manipulated in ArtiosCAD. AutoTrace works best on line art drawings.



The **Color to Vectorize** option lets you choose the color that ArtiosCAD will convert to lines and arcs. **Drag Color** is the color of the lines used to show the lines that will be created. **Brightness Threshold %** controls how much will be vectorized in relation to the brightness of the color selected to vectorize. **Size Threshold** sets the size limit of items to vectorize. **Smoothing Threshold** controls the jaggedness of the new lines created. The **Dynamic** checkboxes, when checked, tell ArtiosCAD to update the screen as you drag the slider.

Below is shown a bitmap imported from another program which has been AutoTraced. The bitmap can be deleted and the remaining lines can be manipulated by all ArtiosCAD tools.

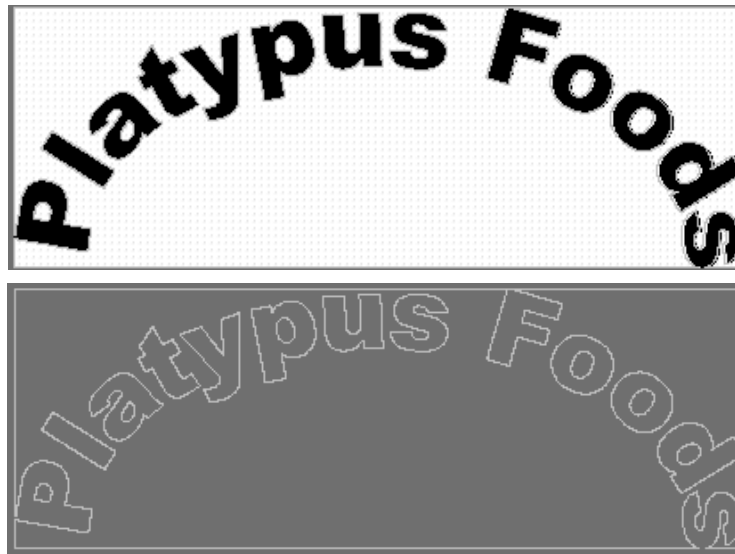

Adding a stock color



The seventh button on the Graphics toolbar activates the **Color Stock** tool. This tool adds a uniform color to all panels of the design. Choose the side of the design to color, and then click **Pick Color** to open the color palette, or enter the CMYK values for the desired color.

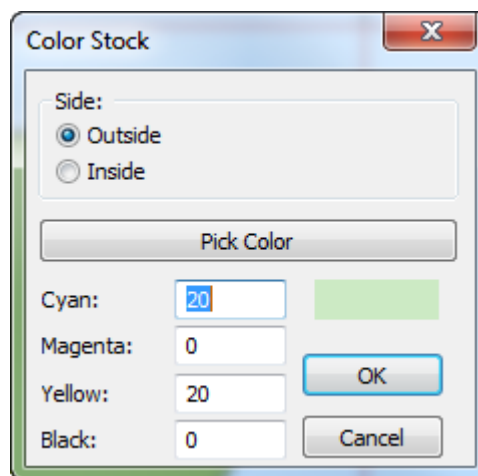

You may have only one stock color per side per print item. To change the current stock color, click the Color Stock tool and choose the new color.

Deleting a stock color

To delete a stock color, use **Undo** if possible. If that is not possible, select the edge of the design and double-click it (or press ALT-Enter), then click **Remove Fill** on the Graphics tab of the Properties dialog box.

Fill



The Fill tool on the Graphics toolbar lets you fill an area with color that is formed by a closed loop of design lines. To use this tool, select the lines that form a closed loop, and then click the **Fill** tool. The default fill color (FC Orange 021) will fill the area. To change the fill color, double-click one of the lines that forms the loop and choose the new color from the **Graphics** tab of the Properties dialog box.

You can change the default fill color on the Graphics tab of the Property Defaults control in Defaults. When an item is filled, the lines forming the closed loop are changed to type print image, and the lines are grouped together.

Stroke



The **Stroke** tool on the Graphics toolbar adds a ribbon of color around the edge of a line or group of lines you select.

The stroke evenly straddles the selected lines.

When applying a stroke, there are several options for how strokes meet and how they turn corners.

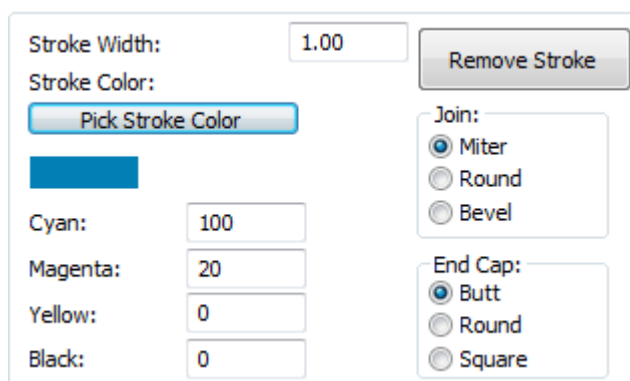

The options in the **Join** group control how strokes that meet are connected. **Miter** makes the inside and outside angles of the intersection the same. **Round** blends the outside corner of the stroke. **Bevel** chamfers the outside edge. Shown below is the junction of two stroked lines, with a mitered corner, a rounded corner, and a bevelled corner.





The options in the **End Cap** group control the ends of the stroke. **Flat** ends the stroke at the same point as the end of the object being stroked. **Round** makes a semicircle at the end of the stroke that projects beyond the end of the object being stroked. **Square** extends the end of the stroke half a stroke-thickness beyond the end of the object being stroked. Shown below is a flat stroke, a rounded stroke, and a squared stroke end. In the examples, the line being stroked is shown selected to clarify the stroke option.

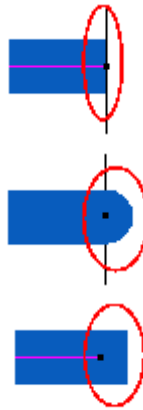

Fill panel



The **Fill Panel** tool on the Graphics toolbar fills the panel you indicate with the default fill color.

To use this tool, click it. The cursor will change to a paint bucket pouring paint. Click inside the panel you want to fill. ArtiosCAD will automatically exclude any cutouts that exist inside the panel.

Send to front and Send to back

Graphics in ArtiosCAD are applied in a layer one on top of another like a stack of paper on a desk. Layers are also stacked; to change layer order, and not the order of graphics within a specific layer, use the arrow controls in the Layers dialog box to change the layer order.



Send to front moves the selected graphic to the top of the stack so that it is visible in front of all other graphics occupying the same area in the design.



Send to back moves the graphic to the bottom of the stack.

To use these tools, first select the object(s) you want to send to the front or back, and then click either Send to button. Shown below are two rectangles - one in front and one in back, and then reversed.

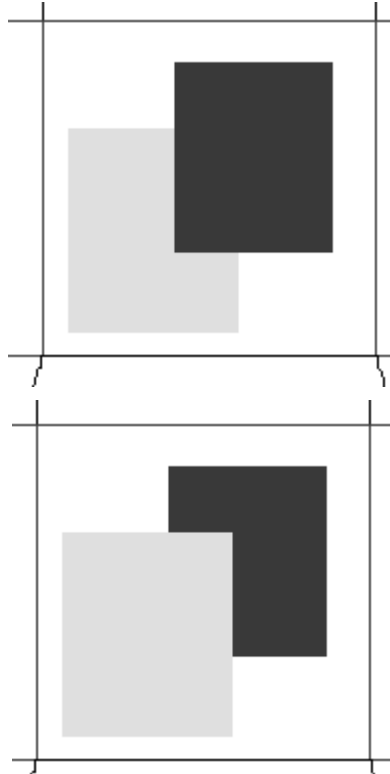

Adding a PDF file

To import a PDF file, do the following:

1. Make a normal single design.
2. Click **Add graphics** on the Graphics toolbar.
3. Navigate to the directory where the PDF file is located and change the **Files of Type:** drop-down list box to PDF.

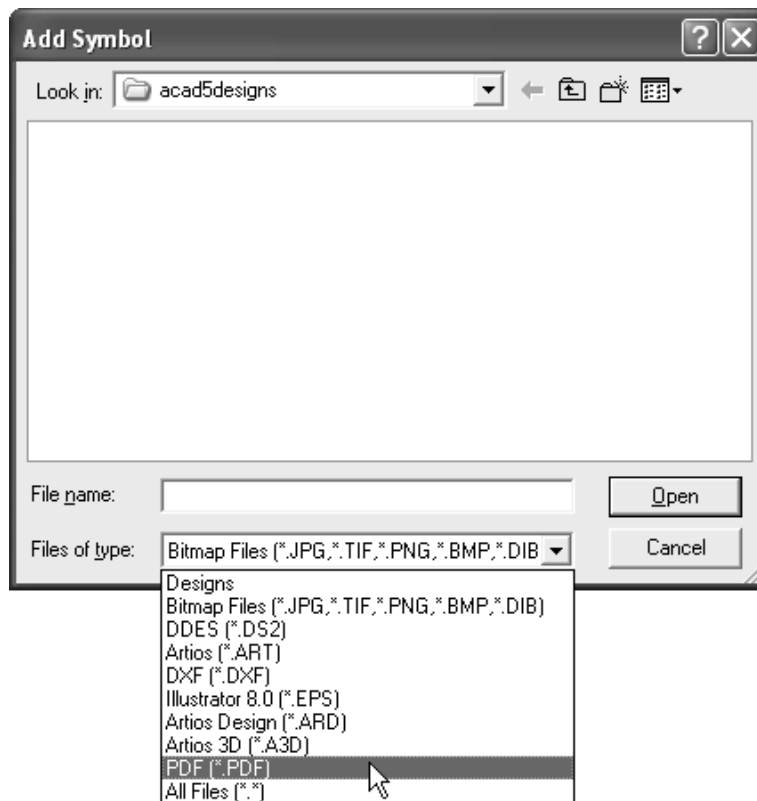

4. Select the file and click **OK**.
5. **Rendering Preview** will appear on the Status bar and then the image will appear in ArtiosCAD, ready to manipulate just like any other graphic image.

Working with Adobe Acrobat PDF files

If you have purchased the PDF option, ArtiosCAD displays more detail as you zoom in on a PDF graphic. This greater detail is called **high graphics mode**, and in Single Design can be turned on either in the View Mode dialog box, and also on the context menu accessed with the right mouse button. Shown below are the View Mode dialog boxes in Single Design.

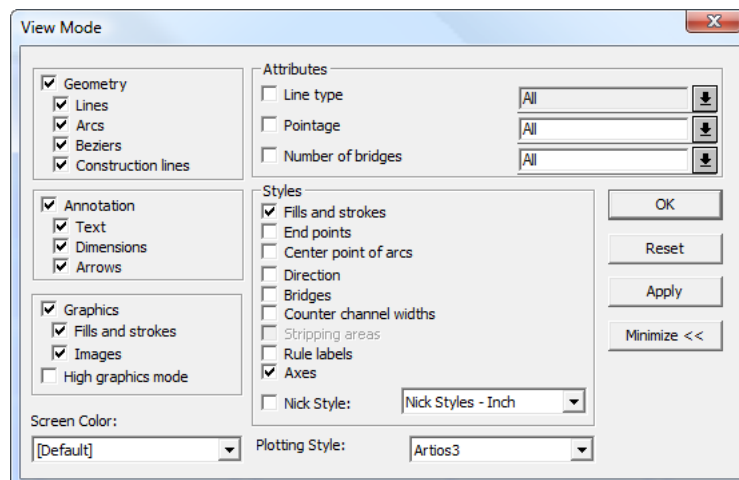

 In 3D, use the **3D Rendering and Image Quality** slider on the View toolbar to set the level of detail shown. It is also available in the View Mode dialog box.

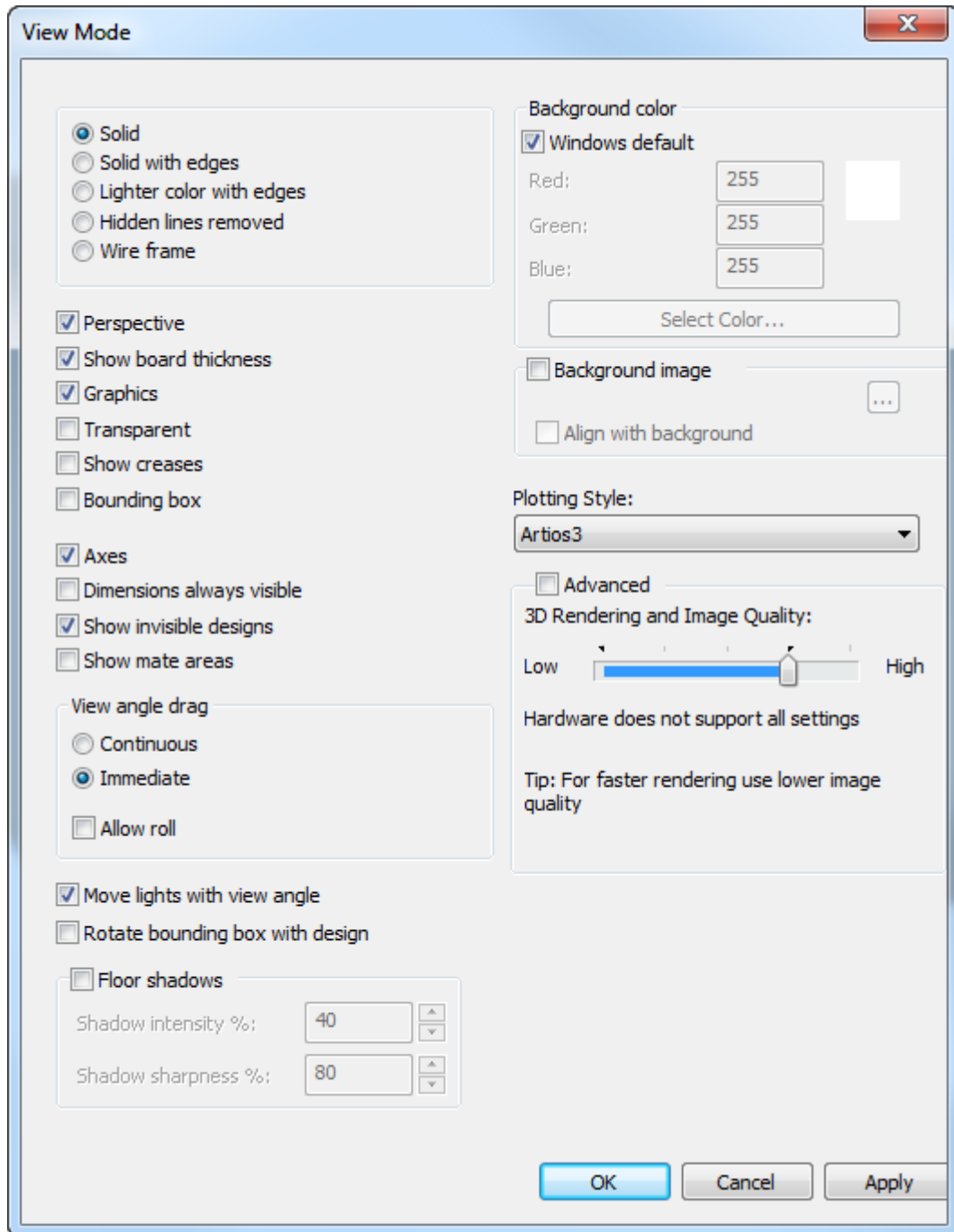

Use of this feature is very dependent on the performance and amount of memory on your system-specific display adapter.

Shown below is a design with a PDF graphic at preview resolution when high graphics mode is off. Notice the pixelation and jagged edges of the graphic.

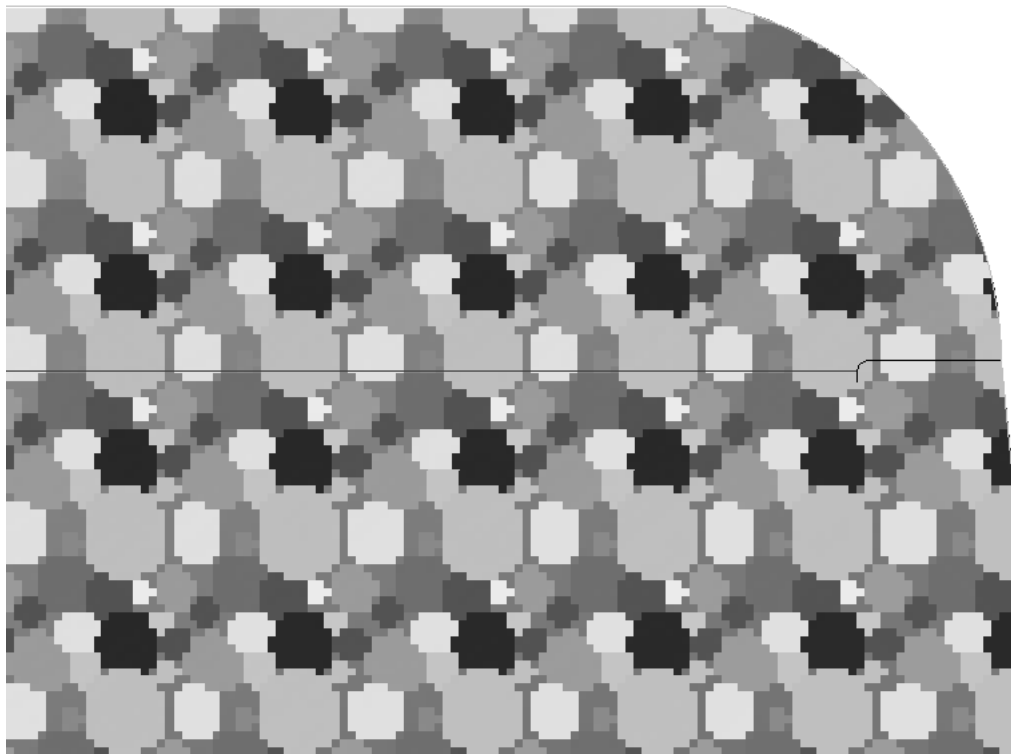

Shown below is the same graphic with high graphics mode turned on. Notice the smoothness of the curves.

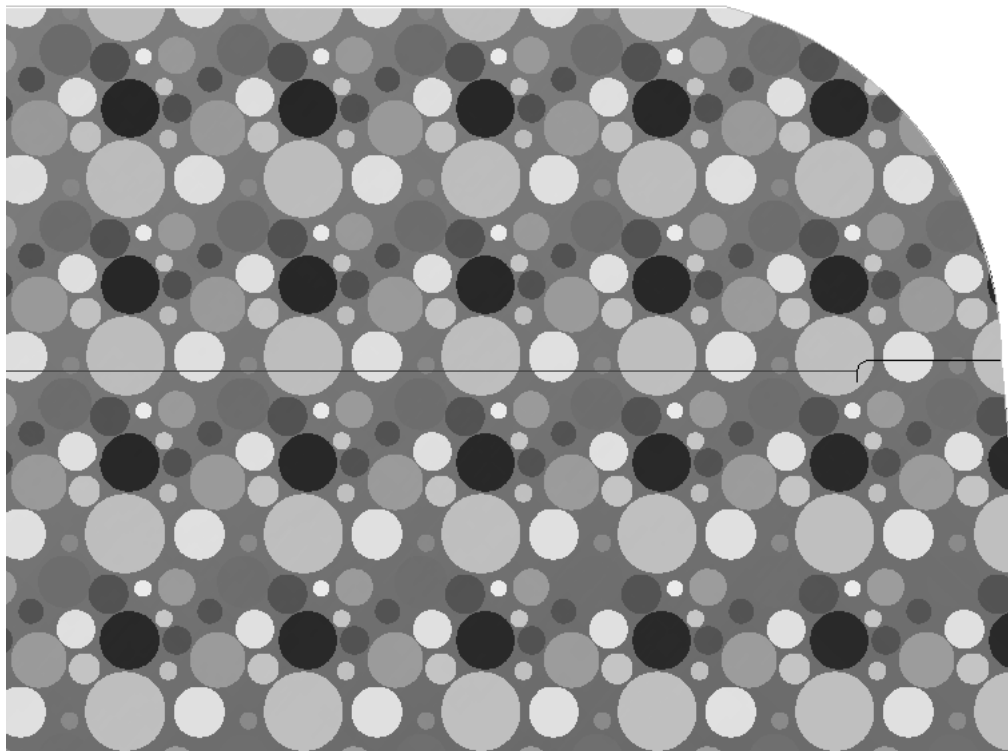

Note: When scrolling, you may have to refresh the screen using F2 or the **Refresh** command for high graphics mode to re-render the bitmap.

Note: The quality of the PDF file directly influences the quality of the zoom in ArtiosCAD. If the PDF file is downsampled or compressed, the effect of high graphics mode is limited compared with importing the graphic in another format such as TIFF or BMP.

Changing the reference to the PDF file

If you need to change the reference to the PDF file, for example if you rename the PDF file, or move it to another directory, double-click the edge of the PDF graphic in ArtiosCAD to access its Properties dialog box. Next, click **Browse** and reselect the file in its new location.

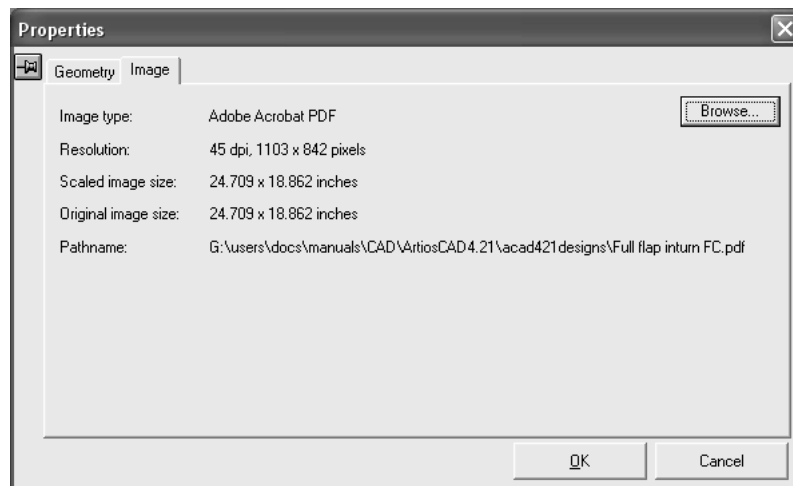

Troubleshooting

After adding the PDF file to the design, if the PDF file is not found, no error message is displayed, and the preview image is used instead. When the file is not found, the **Pathname** field in the Properties dialog box will change to **File not found** and will be in red. Click **Browse** to find and reselect the file.

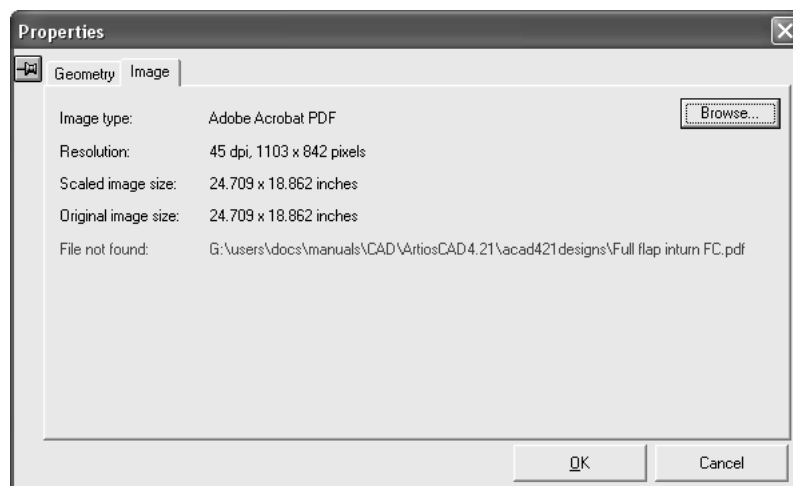

Automatic registration of Esko normalized PDF files in a single design

ArtiosCAD automatically registers, or precisely aligns, a PDF file to a single design if the PDF file was created either with the Structural Design Import and Esko PDF Export plug-ins for Adobe® Illustrator® or with the most recent version of BackStage.

Specifically, the PDF file must contain embedded XMP CAD-related data. You can check for this data in either a full version of Acrobat (not Acrobat Reader) or Illustrator. In Acrobat, click **File > Properties > Description > Additional metadata > Advanced**, or in Illustrator, click **File > File Info > Advanced**. Then expand the [http://ns.esko-graphics.com/ cadreg/1.0](http://ns.esko-graphics.com/cadreg/1.0) catalog entry and look for six egCadReg entries similar to those shown below.

```

http://ns.esko-graphics.com/cadreg/1.0/
  .. egCadReg:instanceID: file:../CONBURYCOOKIESLRG.ARD
  .. egCadReg:renditionClass: application/ard
  .. egCadReg:stationname
  .. egCadReg:orientation: 0
  .. egCadReg:orgX: 14.999946
  .. egCadReg:orgY: 256.999989
  
```

Note:

Auto-registering PDF files cannot be added to a 3D workspace using **Add a Design**. Instead, open the auto-registering PDF and then use **Add to Open 3D**.

Registering a normalized PDF file

There are two ways to register a normalized PDF file to the single design workspace:

- Use ArtiosCAD to open the normalized PDF file directly, interpret the embedded XMP data, and open the referenced workspace.
- Use ArtiosCAD to open the single design workspace, then click **File > Open** and select the normalized PDF file.

In the first method, ArtiosCAD searches for the single design workspace in the following locations:

1. The location specified in the embedded XMP data of the PDF file;
2. The same folder as the PDF file;
3. A relative folder from the folder containing the PDF file, specified in the embedded XMP data, such as \data or ..\graphics.

If ArtiosCAD cannot find the single design workspace to which to register the PDF file, it will open the PDF file using the vector import workflow.

In the second method, ArtiosCAD always places the PDF file in the Outside Graphics layer. If there is an existing Outside Graphics layer containing a PDF file with the same name as the one being opened, the layer is reused, else ArtiosCAD creates a new Outside Graphics layer.

Shown below is an example of an Illustrator workspace that has had a single design imported into it using the Structural Design Import plug-in and then has had graphics applied:

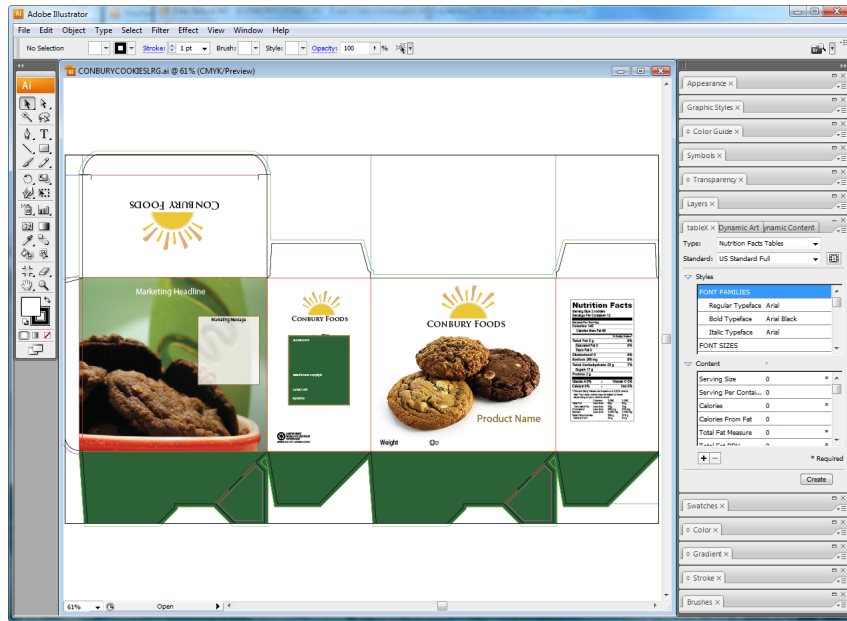

The single design workspace in ArtiosCAD:

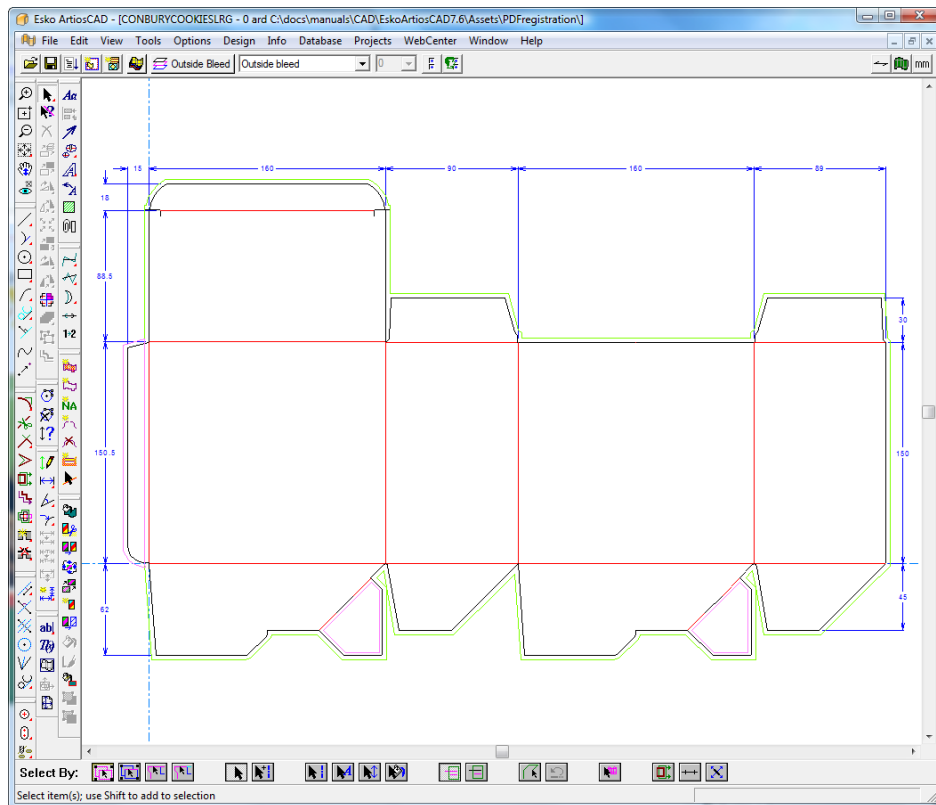

The Illustrator document exported as a normalized PDF file and combined with the single design workspace:

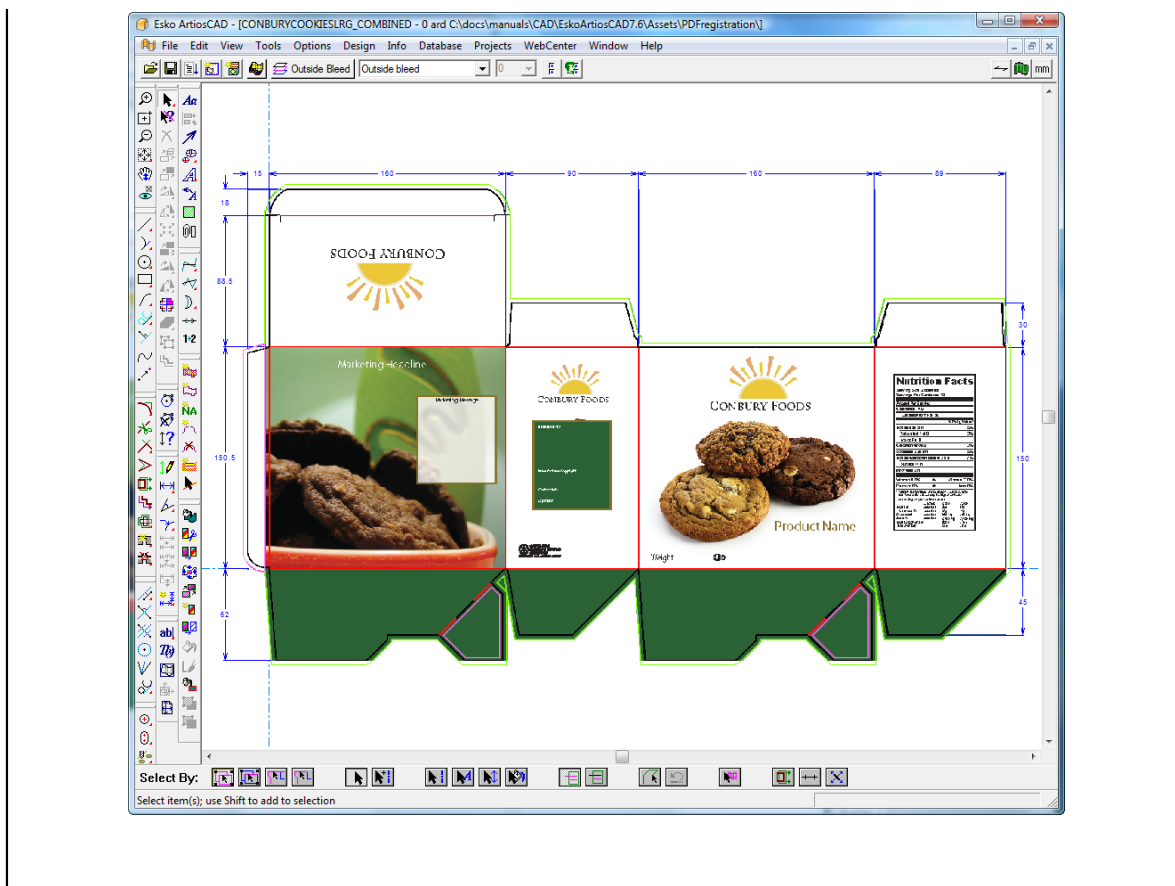

Other auto-registration formats

PDF files may also contain links to Collada or bag files. When ArtiosCAD opens such a PDF file, it will look for the referenced linked file, and if found, will automatically register the PDF graphics in 3D as the first printable area on the Collada or bag file.

Print items

Print items are groupings of layers into logical units. For example, if the same carton is to be printed in green and in red, instead of making two copies of the same design, you can create two print items and associate different overlays with each item. Then you can design a set of manufacturing tools that uses both print items. There may be up to 100 print items in a design.



The **Print Item** button on the View bar controls print items. The name of the current print item, if any, appears next to the icon.

To create a print item, click the **Print Item** button. If this is the first print item in the design, enter the name for the print item when prompted. If this is not the first print item in the design, click **Create** in the Print Item Properties dialog box and enter the name of the new print item.

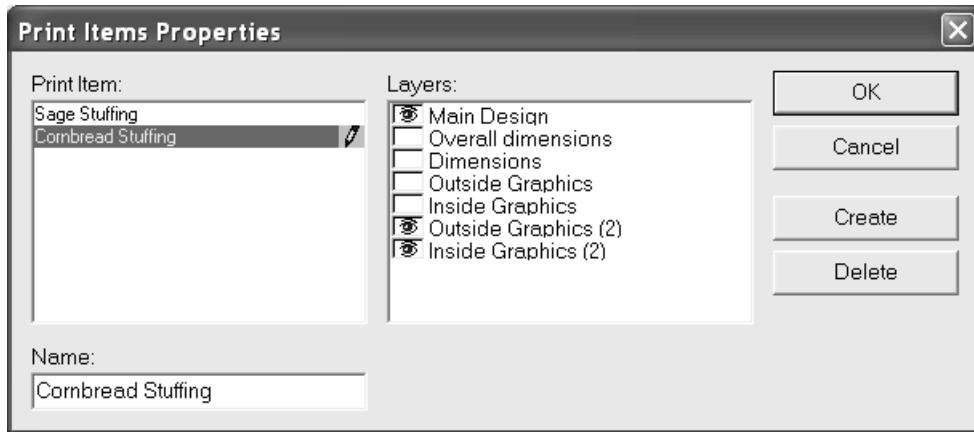

The current print item is highlighted in the **Print Item:** pane. The layers associated with the selected print item have eye icons in the **Layers:** pane. In the example above, the Main Design, Outside Graphics (2), and Inside Graphics layers are part of the Cornbread Stuffing print item.

The Main Design layer is always associated with every print item; its checkbox cannot be cleared.

To delete a print item, click **Delete** in the Print Items Properties dialog box.

Artwork Panels



Artwork panels are a way for you, the structural designer, to label which panels are visible and should therefore contain artwork to others in the supply chain such as a graphic designer. The panels are normally labeled **Front**, **Back**, **Left**, **Right**, **Bottom**, and **Top**. You can also indicate the **Principal** panel.

You can define artwork panels in three ways:

- In 3D, you can fold the design, position it as desired, export the information back to 2D, and have Artwork Panels automatically create the labels.

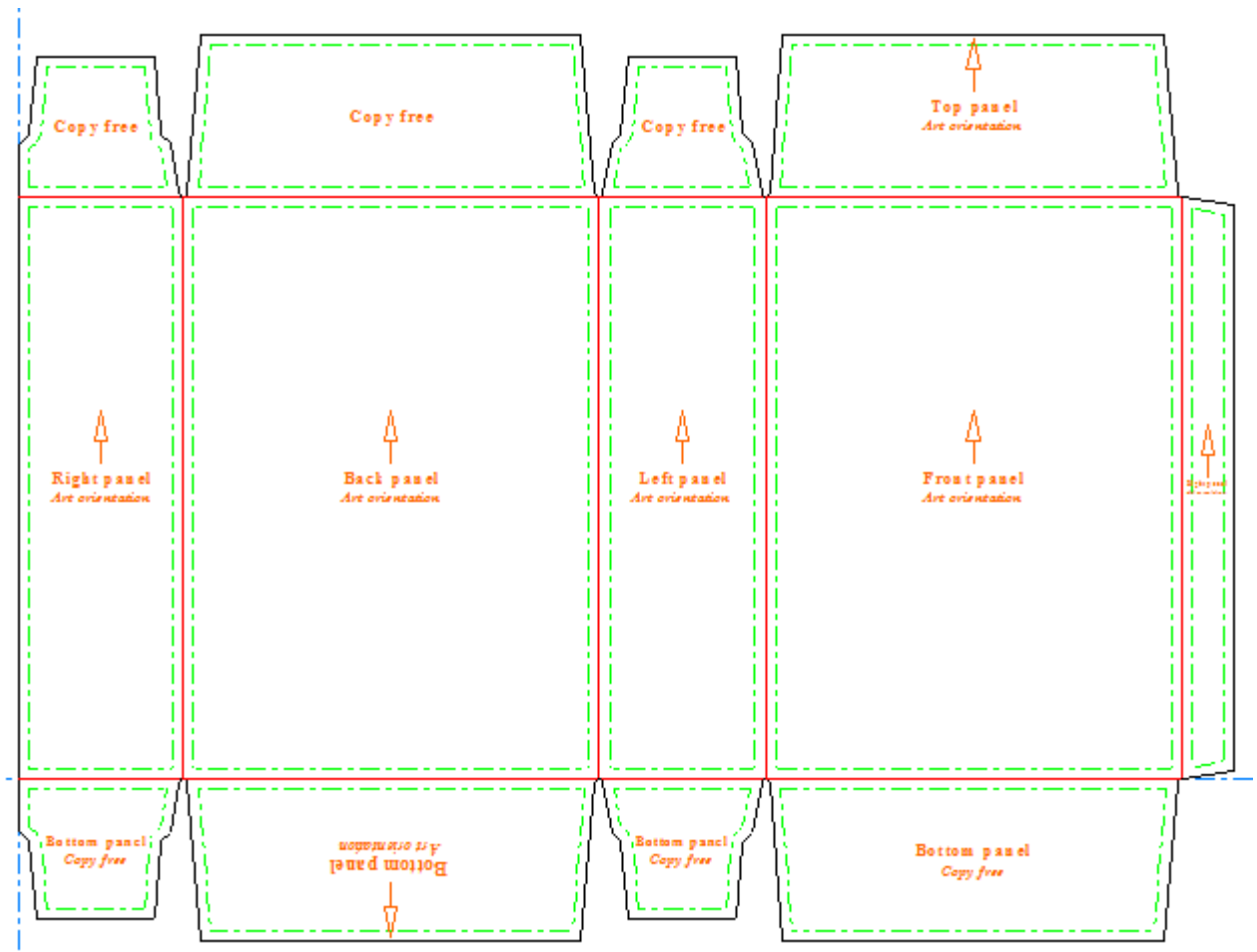

- If you do not have 3D, you can easily label the panels manually within **Artwork Panels**.

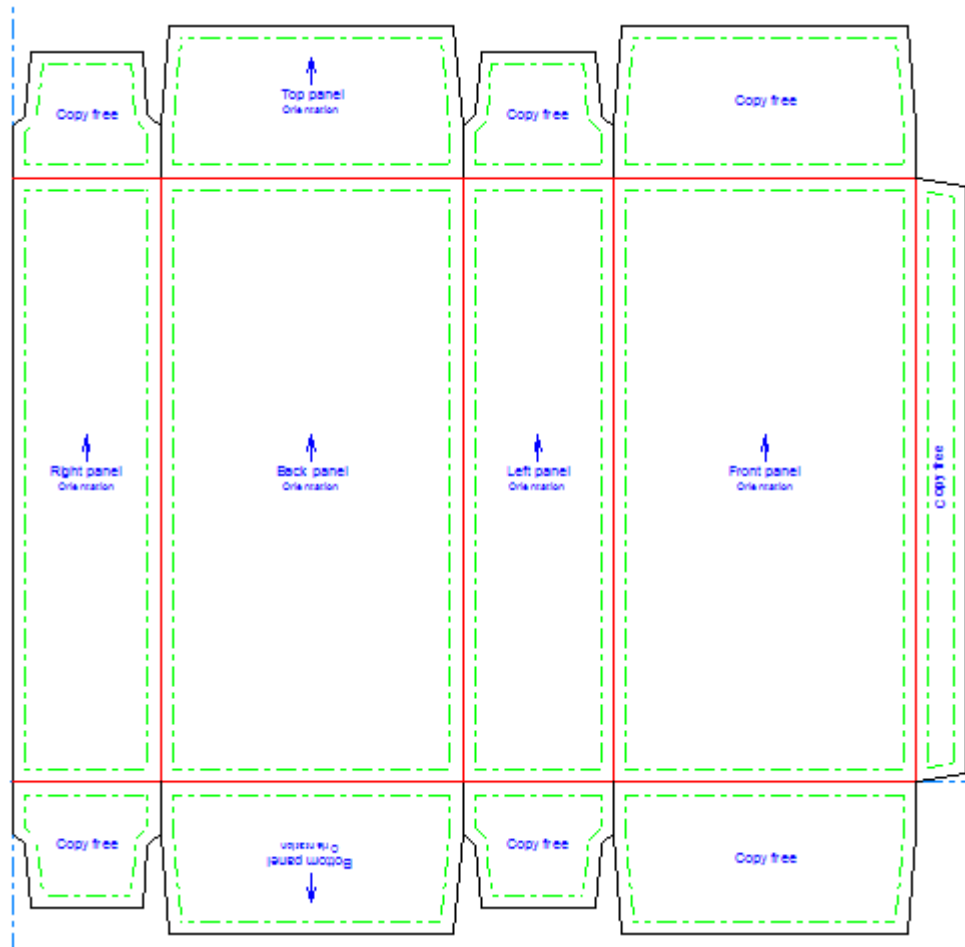

- You can also create a custom panel based on lines that form an outline.

Using the Artwork Panels Tool



When you click **Artwork Panels**, ArtiosCAD first prompts you to create an Artwork Panels layer if one does not already exist. Click **OK** to create the layer.

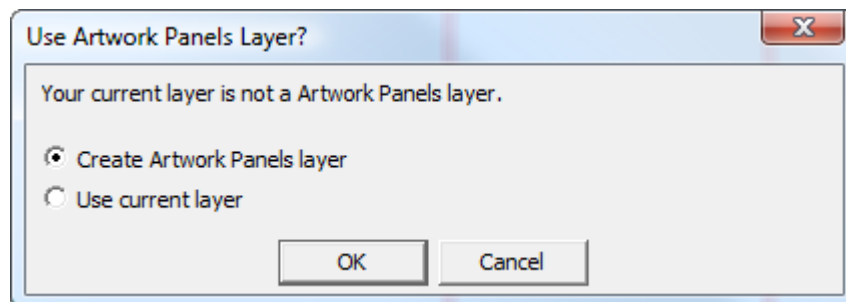

It then labels the panels of the design with their function if you have used the **Update 2D** tool in 3D. It gets information about panel positioning from 3D, or you can designate the panels manually.

Artwork Panels has the following controls on the Status bar:



Offset controls how far the panel label edges are from the design lines.

The drop-down list box showing **Copy free** sets the type of label created by your next click. If a panel is defined already, changing the selected item in the list changes a panel to that type when you click inside it. The default panel types and uses are:

Label	Purpose
Copy area	Can have copy text, but is not a front, back, left, right, top, or bottom panel
Rotate front	Rotates the front panel label between the front, right, back, and left panels so that a different panel is front. If you have 3D, you do this by changing the view angle.
Front	Make this a front panel
Back	Make this a back panel
Left	Make this a left panel
Right	Make this a right panel
Top	Make this a top panel
Bottom	Make this a bottom panel
Principal Display Panel	Make this the Principal Display Panel independent of the front, back, left, right, top, or bottom panel
Partial copy area	Make a copy outline from the outline of the visible part of the panel
Copy free	Make this a copy free panel
Partial copy free	Make a copy free area from the outline of the invisible part of the panel
Ink free	Make this an ink free panel, such as a glue flap
Clear	Deletes the label in the panel

A **copy area** is where the graphic artist may place copy text that is visible to the customer.

A **copy free area** is where the graphic artist should not place copy text because it cannot be seen or is hidden by a flap or the product. However, graphics may go in copy free areas.

An **ink free area** may not be printed.

 More Options opens the Properties dialog box.

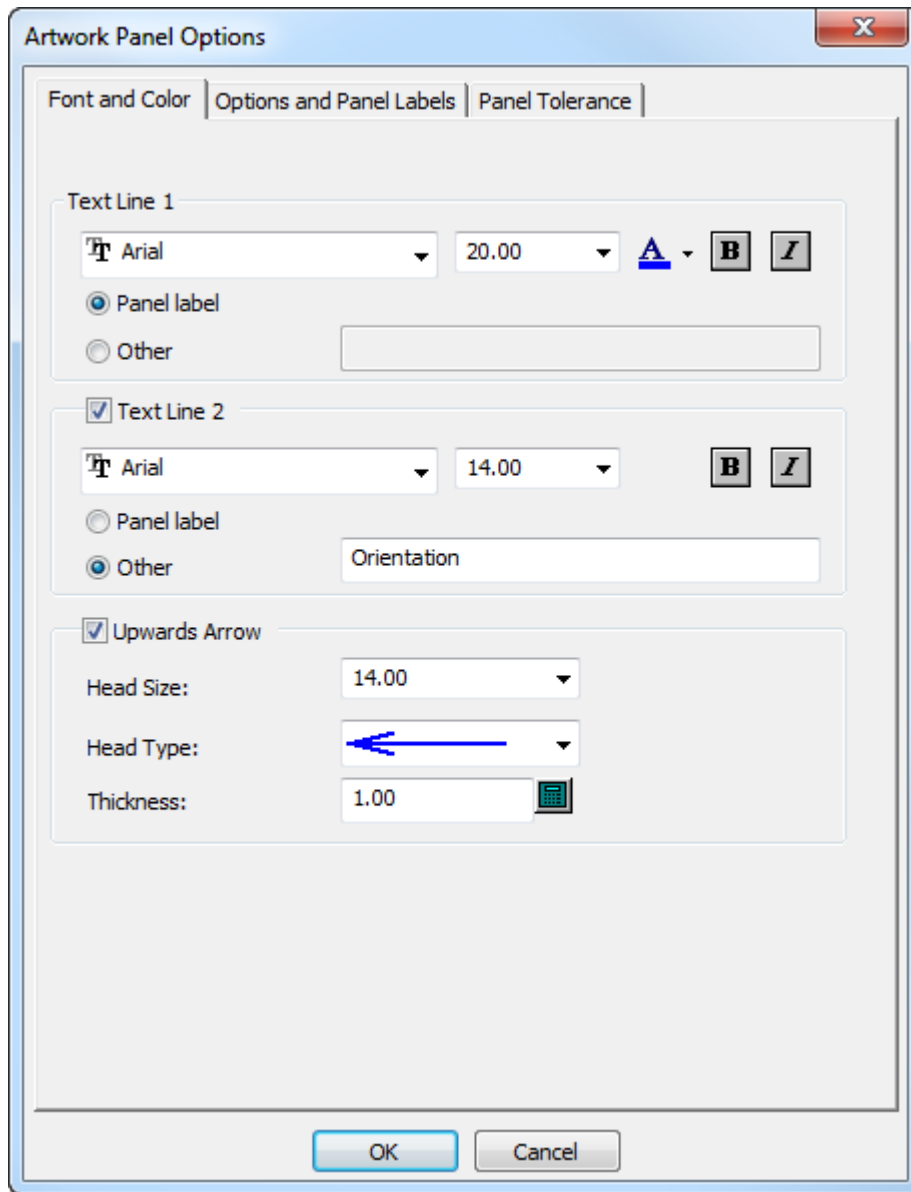

On the Font and Color tab are the standard font and color controls for the label, as well as controls to control the creation and appearance of an arrow. Set these options as desired.

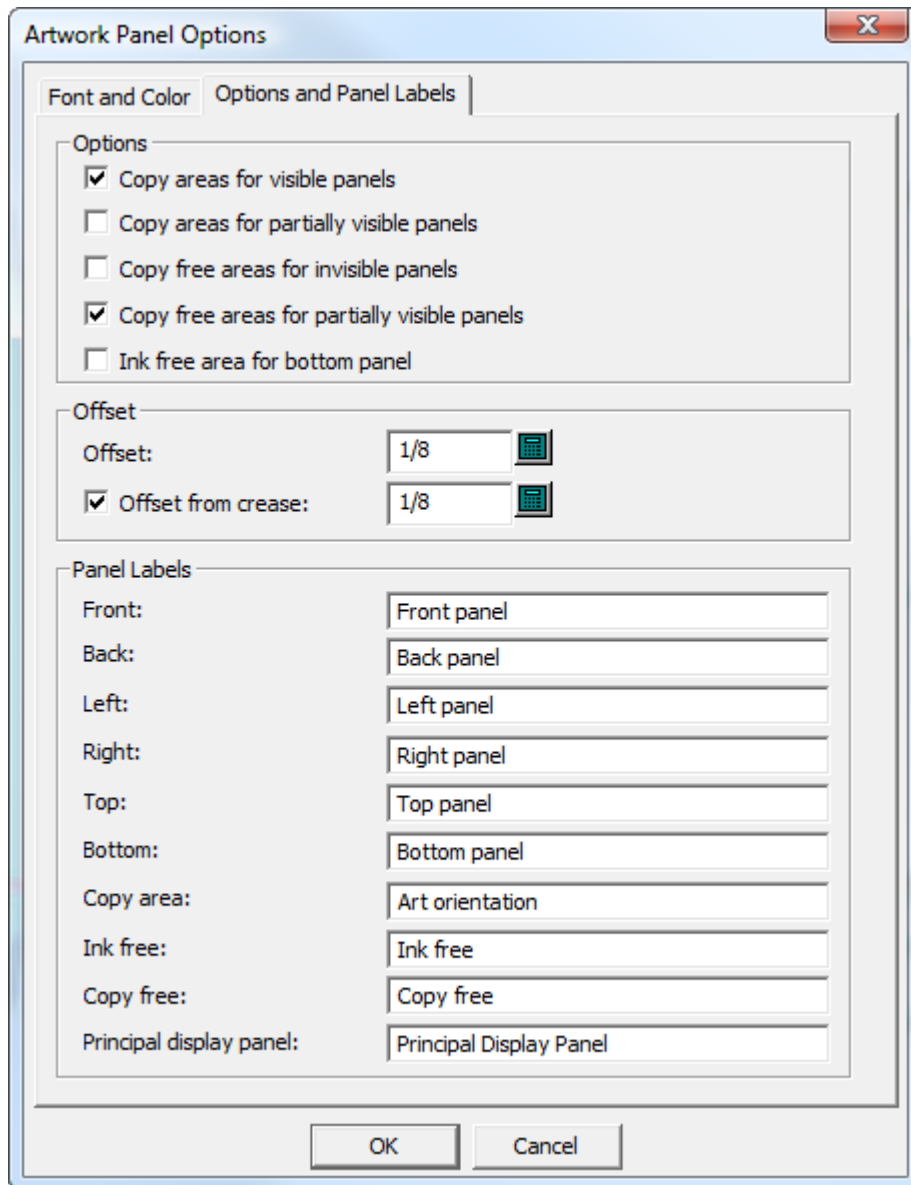

The options on the Options and Panel Labels tab control the types of panels **Artwork Panels** creates, the offsets for the panel edges, and the labels of the panels.

Copy areas for visible panels creates copy areas on visible panels. This option is enabled by default.

Copy areas for partially visible panels creates copy areas on those parts of panels that aren't hidden by other panels (such as flaps). If you have a flap arrangement like the one shown below, with the secondary flaps on top of the primary flaps, having this option selected would create an artwork panel as shown beneath that.

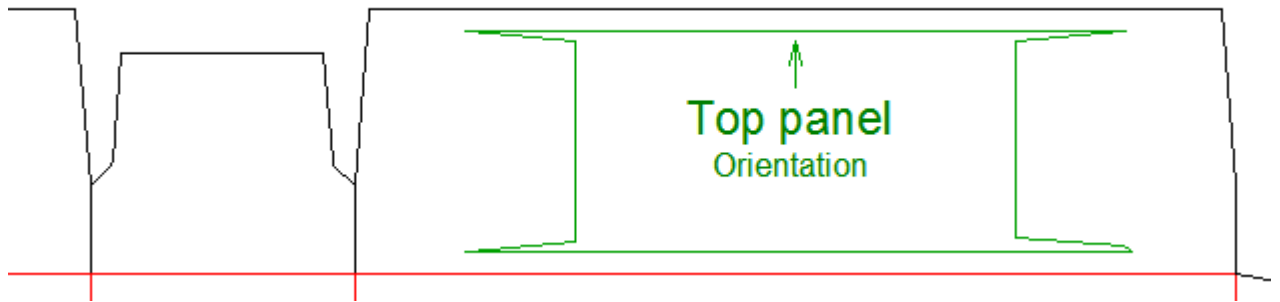

Copy free areas for invisible panels labels those panels customers will not see as copy free.

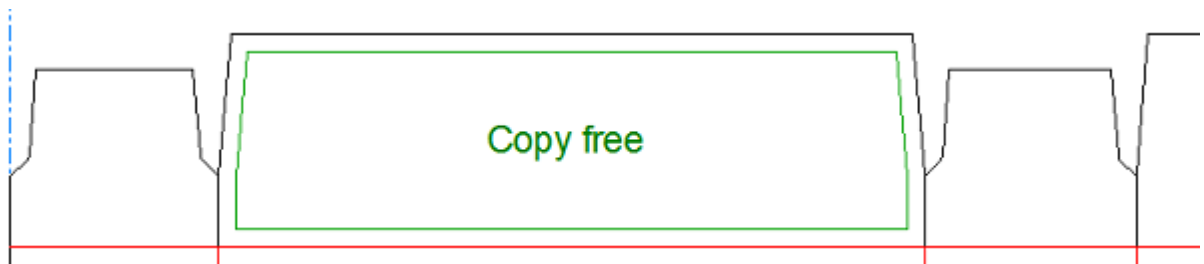

Copy free areas for partially visible panels labels the invisible parts of partially visible panels as copy free areas.

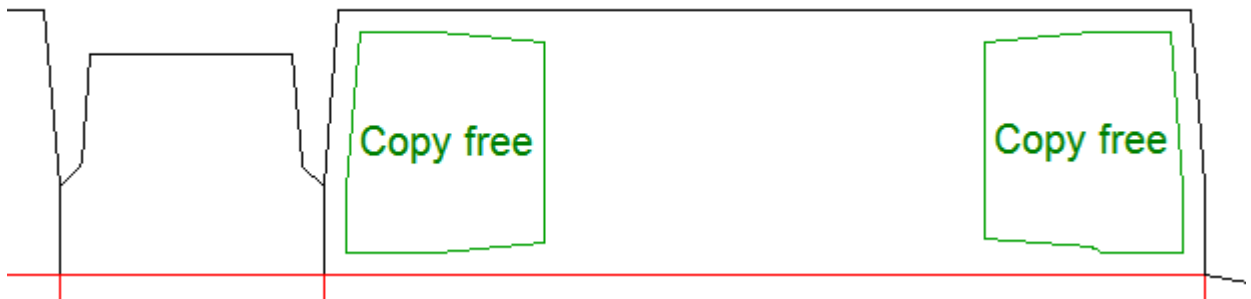

Ink free area for bottom panel labels all the bottom panels as ink free.

The options in the **Offset** group control the distance between the panel edges and the design lines. If desired, you can have a larger or smaller offset from creases by changing the value in **Offset from crease**.

In the **Panel Labels** group, change the labels of the panels as desired

Note: All of these options have defaults in the Artwork Panels section of Startup Defaults.

On the Panel Tolerance tab are **Fix gaps up to** and **Extend creases up to**. ArtiosCAD uses these tolerances to fix small gaps up to the size indicated and to extend creases through gaps of up to the size indicated. This helps the tool find panels when creases do not touch cuts or there is a small gap in a panel's periphery. The defaults for these values are in **Startup defaults > 3D Tools Options**.

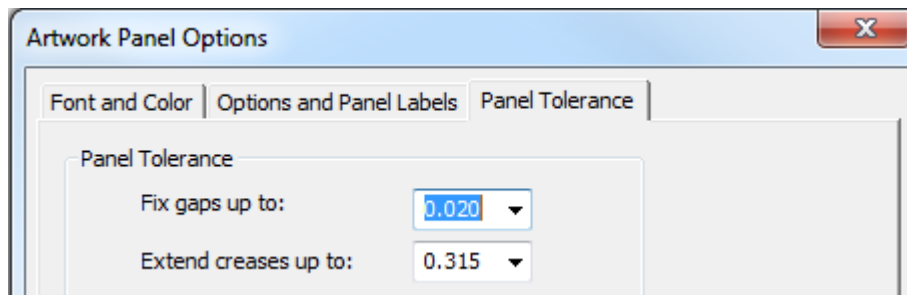

Click **OK** to close the More Options dialog box and return to the tool.

Once you have created the artwork panels as desired, click **OK** on the status bar to finalize them. ArtiosCAD changes all the panel edges to Copy area lines.

Note: Artwork Panels is limited to 20 panels per use, which should be enough for most designs. If you need more, use the tool again to manually add the extra panels.

Creating Artwork Panels from 3D Information

The quickest way to create artwork panels is to fold the design in 3D, set the flap priority and orientation, and export the 3D information to the 2D workspace.

1. Create or restore a design and make sure that for any non-folding creases or perfs, their 3D property is set to **Tear** or **Indent only**. Otherwise, **Artwork Panels** will later create extra panels.
2.  Convert the design to 3D. With the box open like this, ArtiosCAD does not know which flap should be on top.

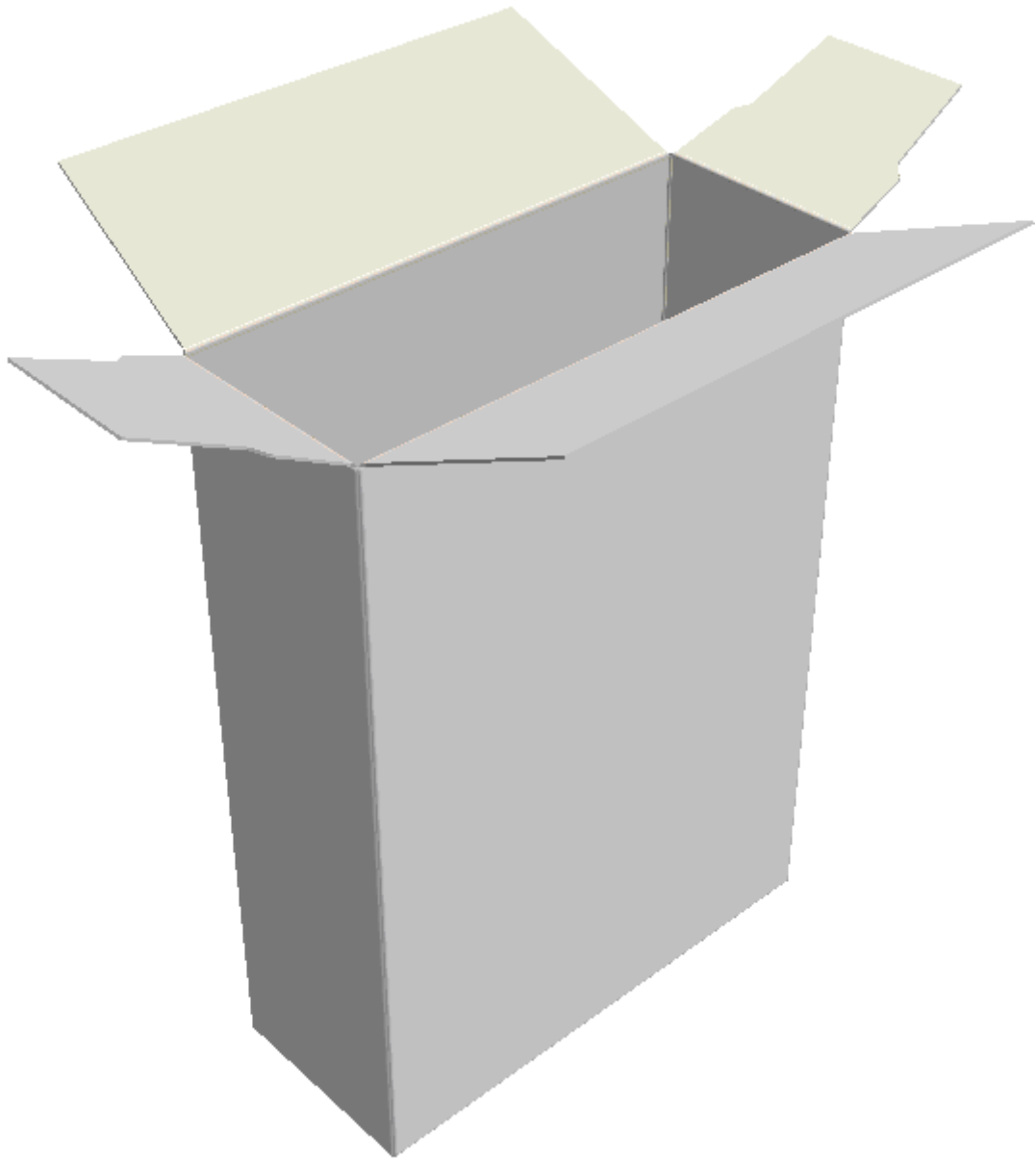

3.  Use one of the **Fold** tools to close the design.

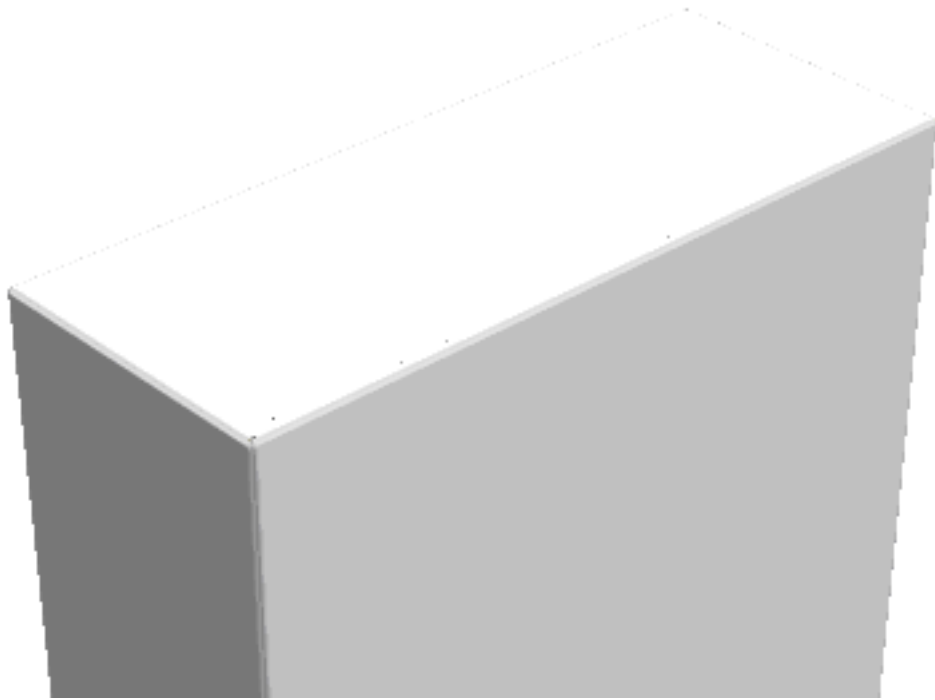

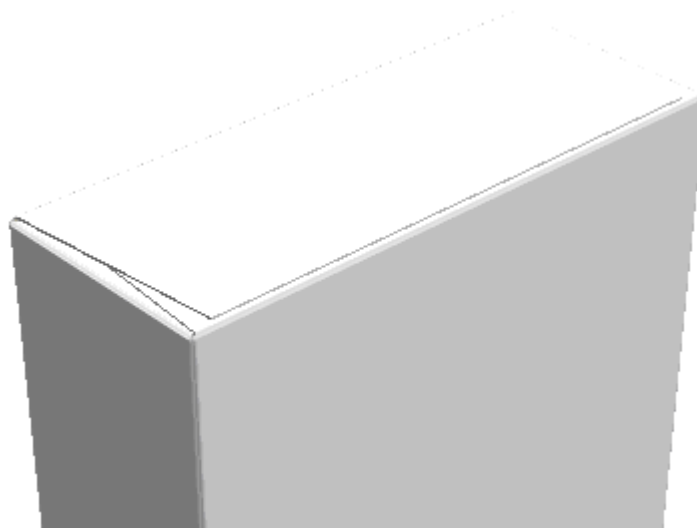

4.  Use **Flap Priority** to set the order of the flaps that are visible. However, at this view angle, ArtiosCAD does not know how to definitively order the panels.

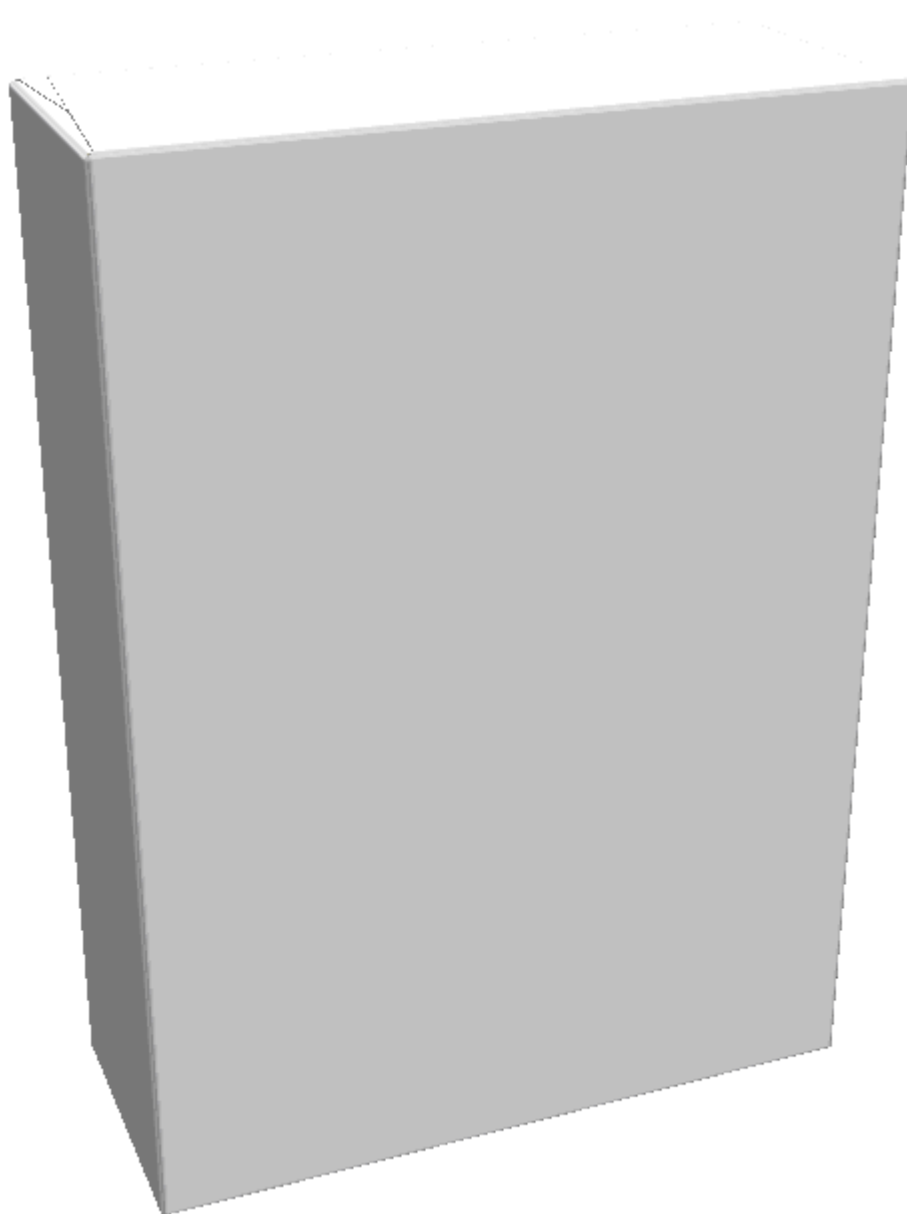

5.  Use **View Angle** to position the design so that the order of panels is not ambiguous. There is no doubt about which is the front panel in the example shown below.



6.  Click **Update 2D** to send the 3D panel information back to the single design workspace.
7.  Switch back to the single design and click **Artwork Panels** to start the process of labeling the panels as described previously. ArtiosCAD puts temporary labels in the panels for you to finalize before clicking **OK**.

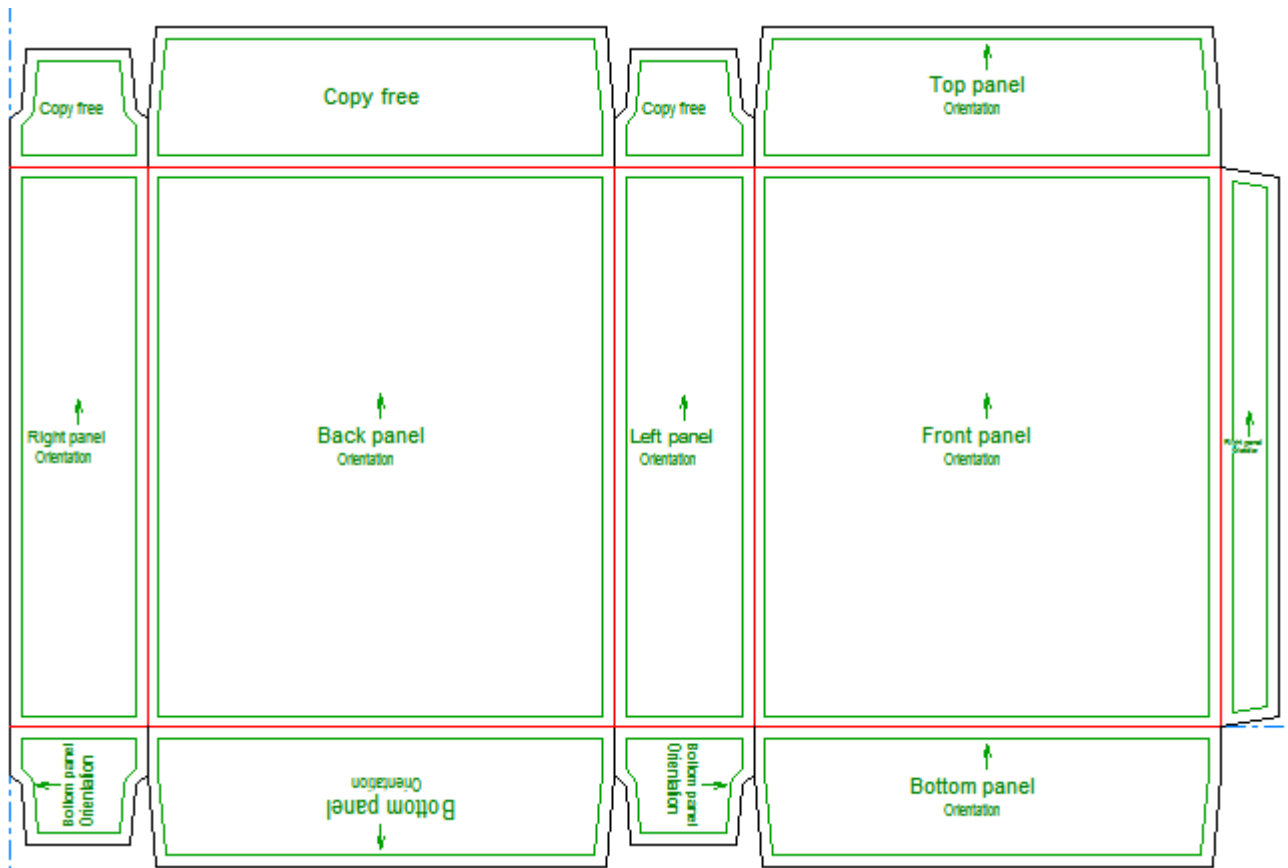

Creating Artwork Panels Manually

To create artwork panels manually, do the following:

1. Create a new design or restore an existing design.
2.  Click **Artwork Panels**. ArtiosCAD labels the panels with its best guesses as to their function.

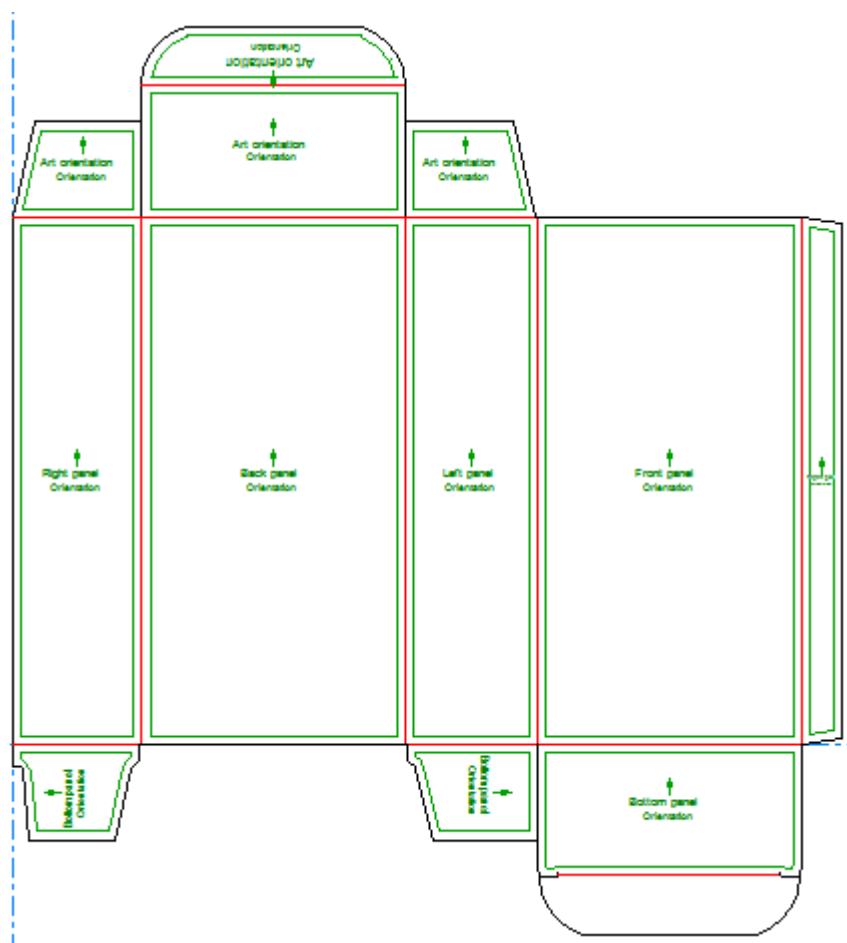

3. To change a panel, set the controls on the Status bar as desired and then click inside the panel.

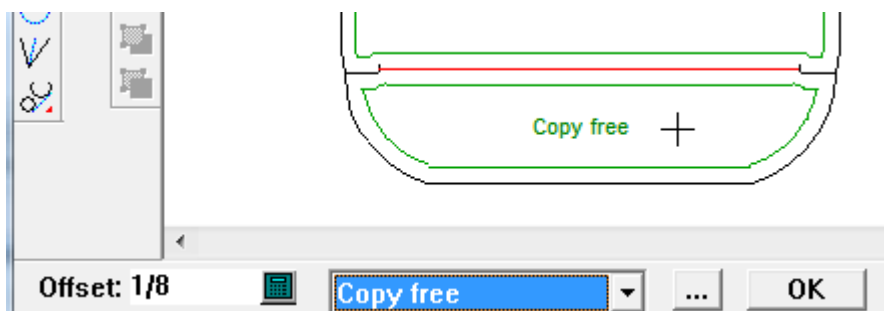

4. Click **OK** when done to finalize the panel labels.

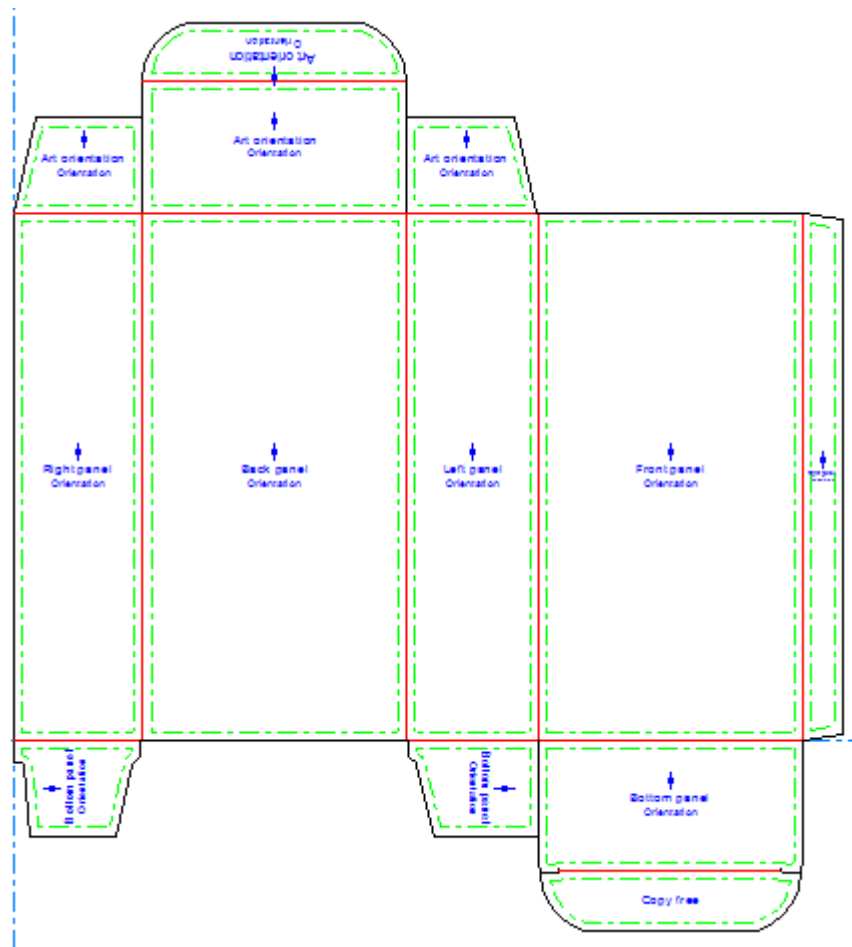



If you define a Bottom panel using **Artwork Panels**, when you convert the design to 3D, ArtiosCAD automatically suggests that panel as the base face. However, any base face set in 3D and then saved back into the single design takes priority, especially when you have run a standard, as most standards have base faces defined in 3D.

Creating Artwork Panels from Custom Outlines

To create artwork panels from custom outlines, do the following:

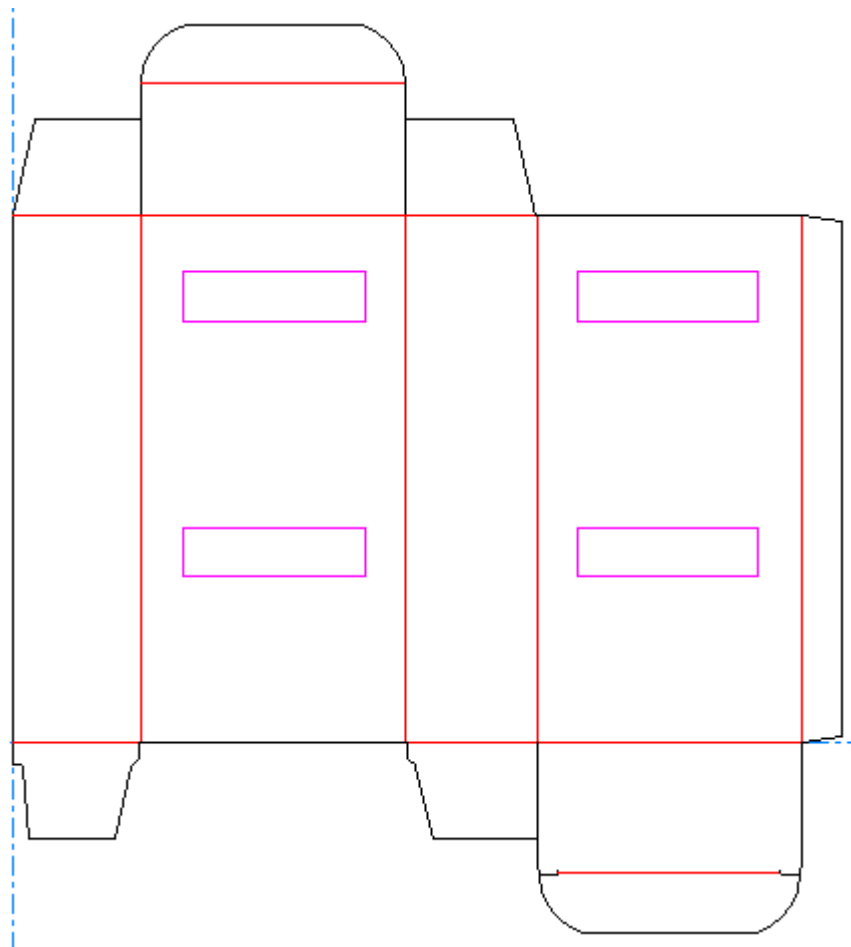
1. Create or restore a design and design the custom outlines. The outlines must form a loop.
2. Select the outlines.



3.  Click **Artwork Panels**.
4. Click **OK** to create an Artwork Panels layer.

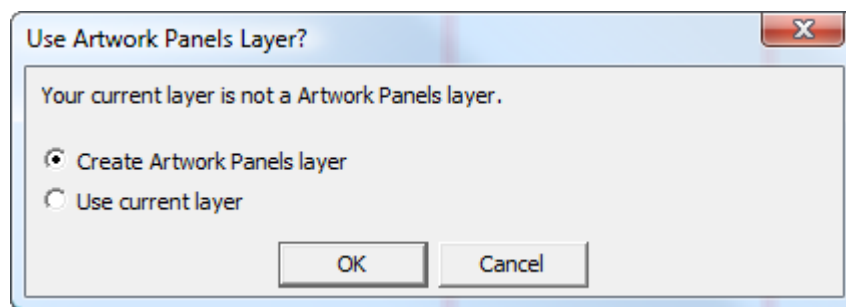

5. Once you click **OK**, ArtiosCAD creates the panels.

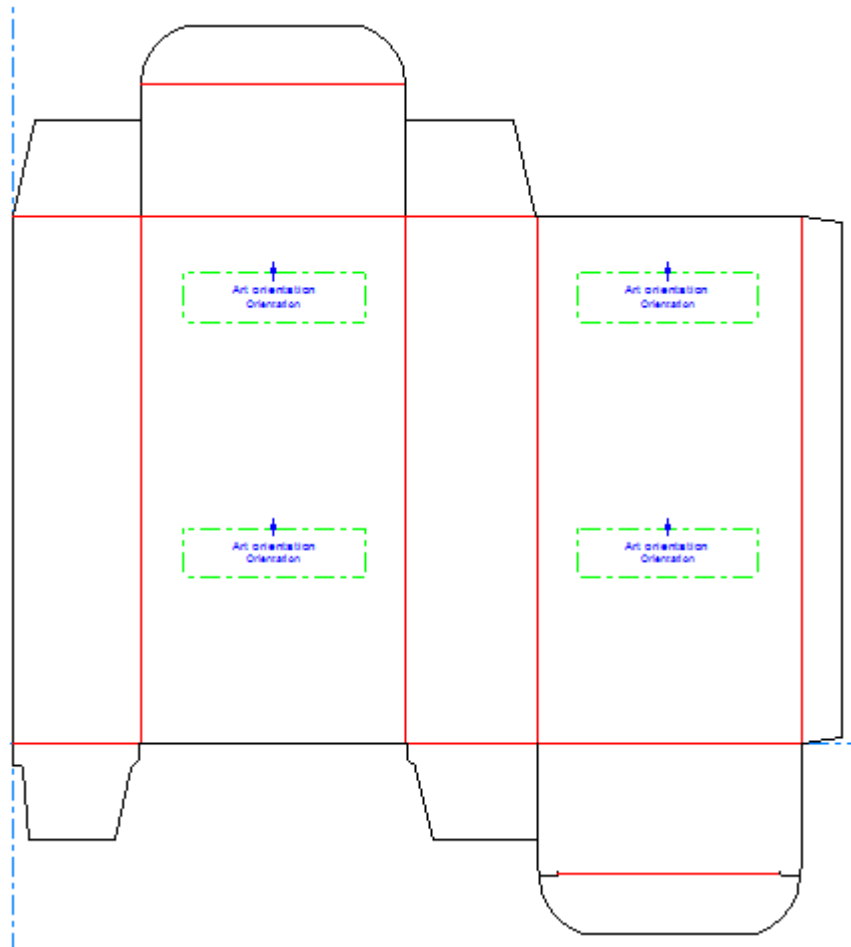

6. If you want to modify the panels, click **Artwork Panels** again.
7. Click **No** when prompted to clear the current Artwork Panels layer.
8. Use the tool as desired to modify the panels, clicking **OK** on the Status bar when done to finalize the changes.

Changing Artwork Panel Properties

To change the properties of an Artwork Panel after you have created it, double-click it with a Select tool to open its Properties dialog box.

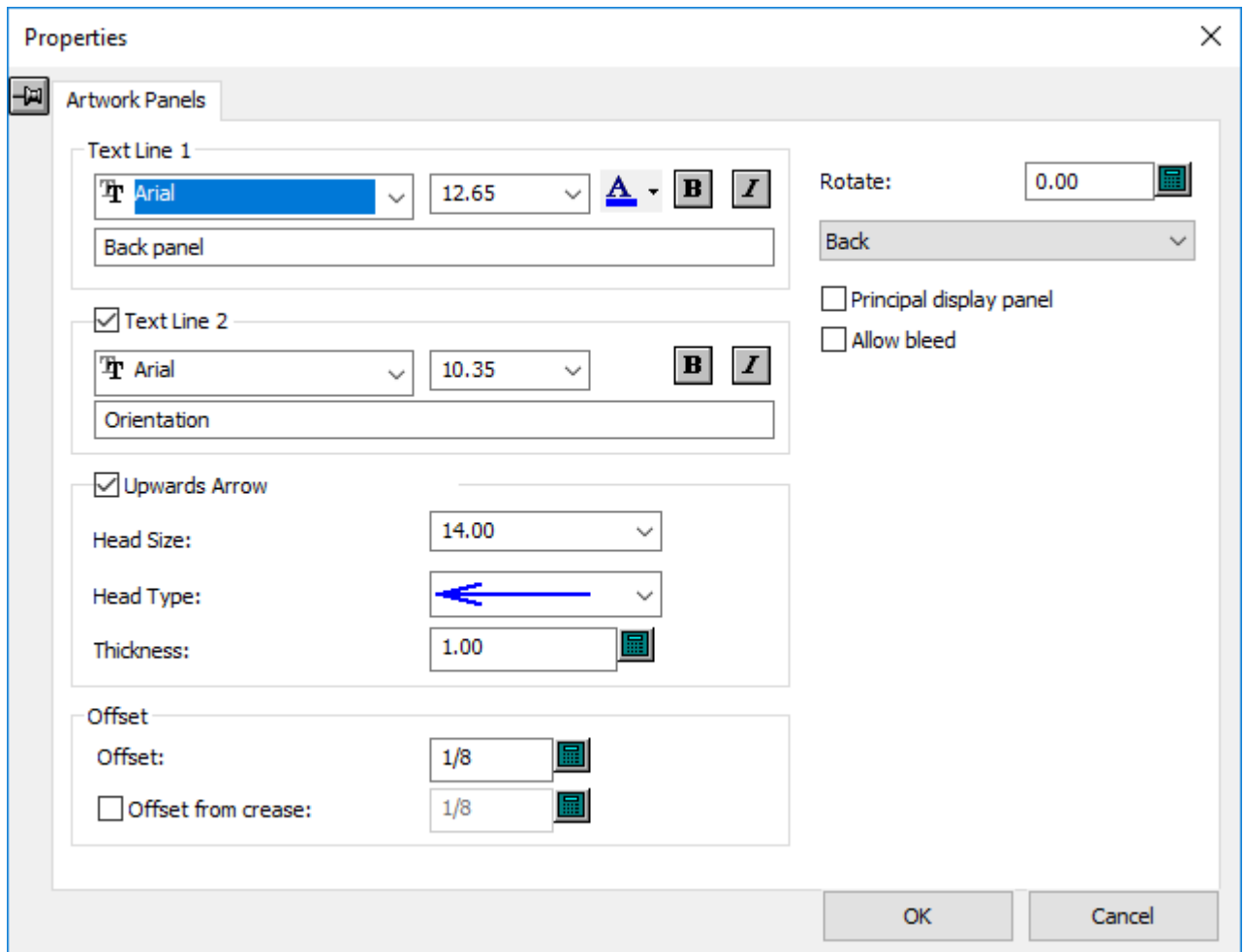

Principal display panel indicates to other Esko programs that the selected panel is the main panel to show of the design.

Allow bleed indicates to other Esko programs that other panels can be shown over this one. Click **OK** when you have finished changing the properties.

Dynamic Art

Dynamic art is database-driven artwork that graphic designers add to designs using other Esko software. The **Dynamic Art** tool in ArtiosCAD lets you designate placeholder rectangles for that artwork.

In ArtiosCAD, Dynamic Art rectangles have a copy type and sometimes a preview image. The four types of Dynamic Art are:

1. **Copy.** Used for text such as Product Name or Net Weight.
2. **Barcode.** Used for one- or two-dimensional bar codes.
3. **Symbol.** Used for symbols and images such as recycle or hazard symbols, or product logos.
4. **Table.** Used for tabular data such as Nutrition Facts tables.

Dynamic Art definitions are derived from the GS1 global business standard.

Using the Dynamic Art Tool

 When you click **Dynamic Art**, ArtiosCAD first prompts you to create a Dynamic Art layer if one does not already exist. Click **OK** to create the layer.

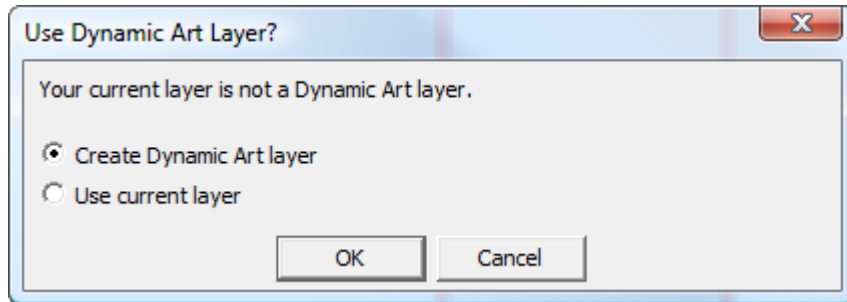

The Dynamic Art Options dialog box appears in which you select the type of Dynamic Art placeholder to create and set its options. Change the **Type**, **Category** (available only for Copy), **Element**, and **Text** as desired and click **OK**.

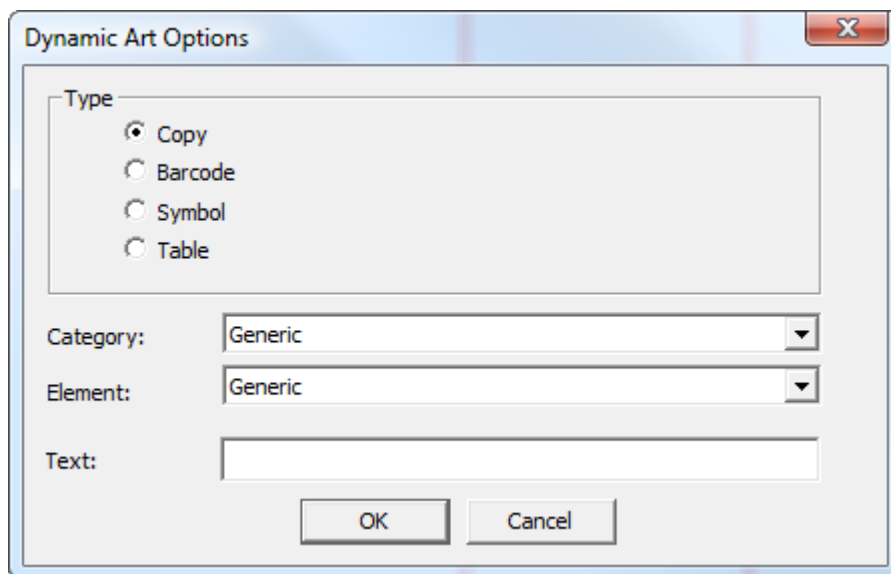

Drag appears for the placeholder. Click inside a panel to set the put-down point. It can be in a corner, the middle of a side, or the center.

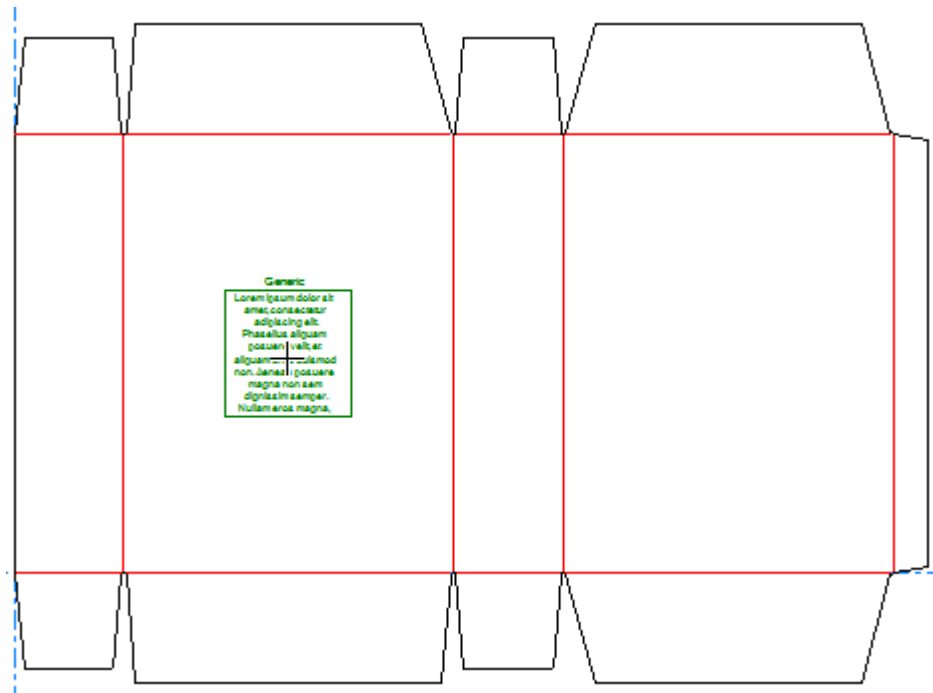

If you have an Artwork Panel defined, the orientation of the Dynamic Art placeholder follows the Artwork Panel definition.

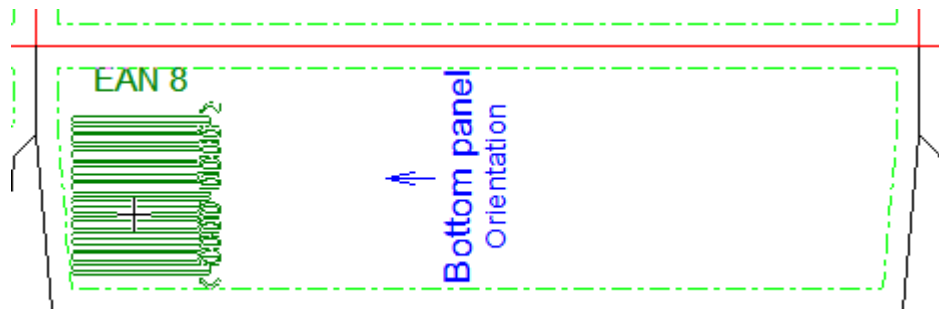

Set the options on the Status bar and click **OK** to finalize the placeholder. When you click inside the **Width** or **Height** field, the size automatically expands to the size of the panel minus the panel offset.



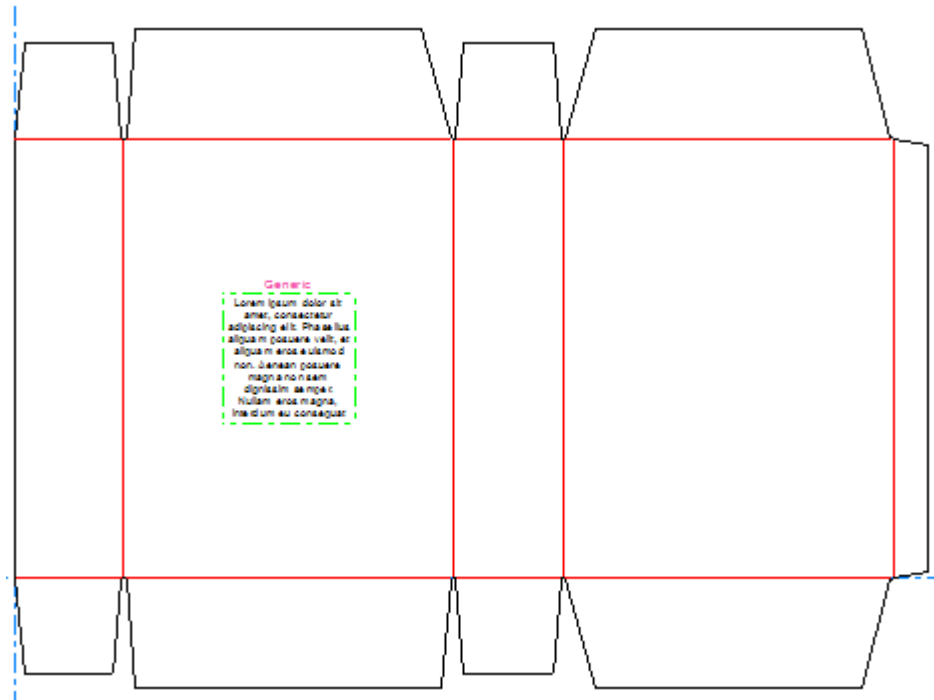

Adding a Copy Placeholder

To add a copy placeholder, do the following:

1.  Click **Dynamic Art** and click **Yes** if ArtiosCAD prompts you to create a Dynamic Art layer.
2. In the Dynamic Art Options dialog box, select **Copy** for the **Type** and choose the desired **Category** and **Element** from the drop-down lists. Enter any desired text in the **Text** field and click **OK**.

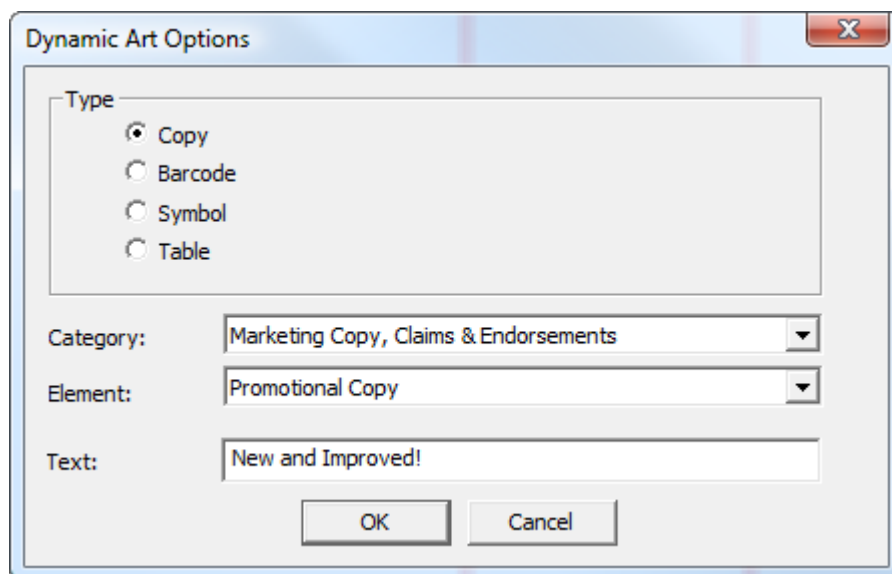

3. Use drag to set the put-down point of the placeholder.

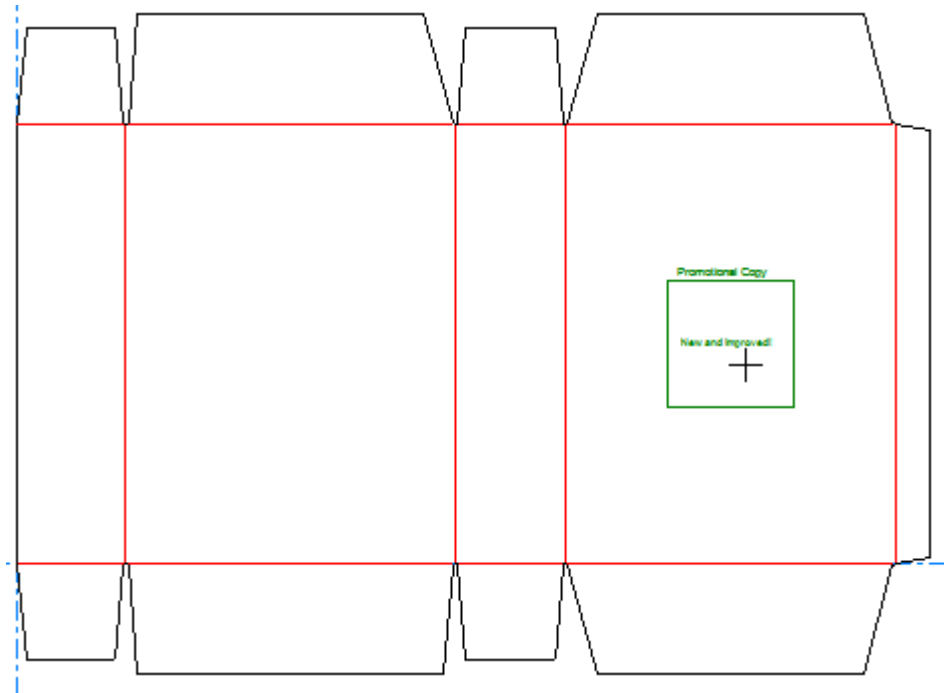

4. Set the fields on the Status bar as desired. **Width** and **Height** control the width and height of the placeholder. **Text** is the same text you entered in the Dynamic Art Options dialog box in the previous step. The directional label controls let you change the position of the placeholder's label.



Clicking More Options (...) opens the Dynamic Art Options dialog box. There are standard controls for font, color, and appearance. **Panel offset** controls the gutter between the placeholder and the panel edge. **Display "lorem ipsum" when no image or text specified** supplies contents if you don't enter any. When you are done setting options, click **OK**.

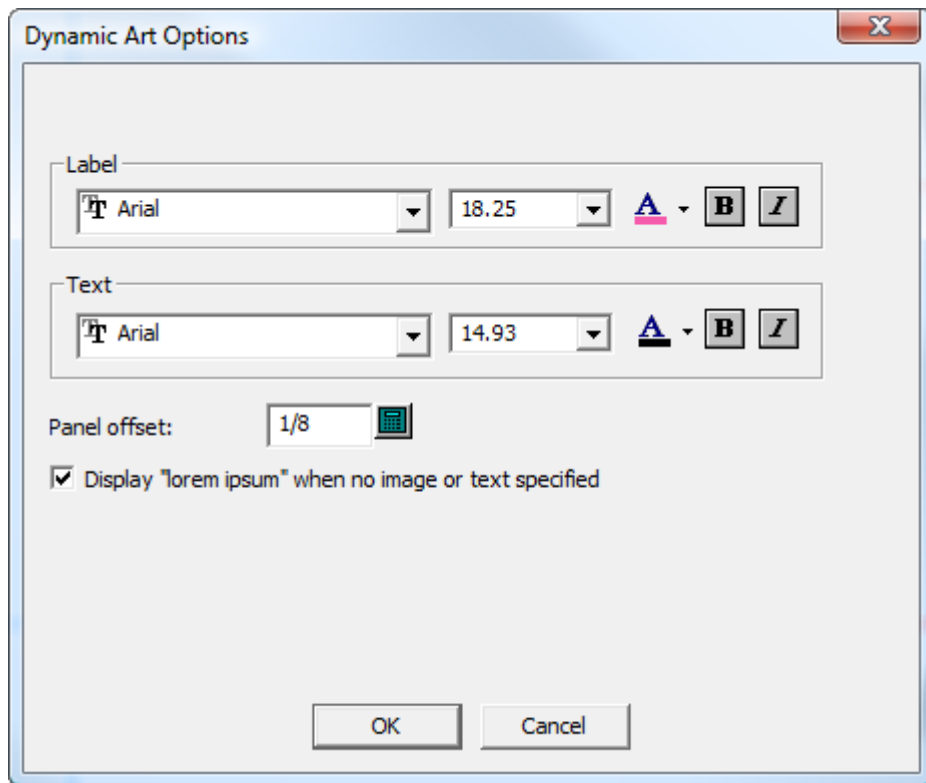

5. Click **OK** on the Status bar to finalize the copy placeholder.

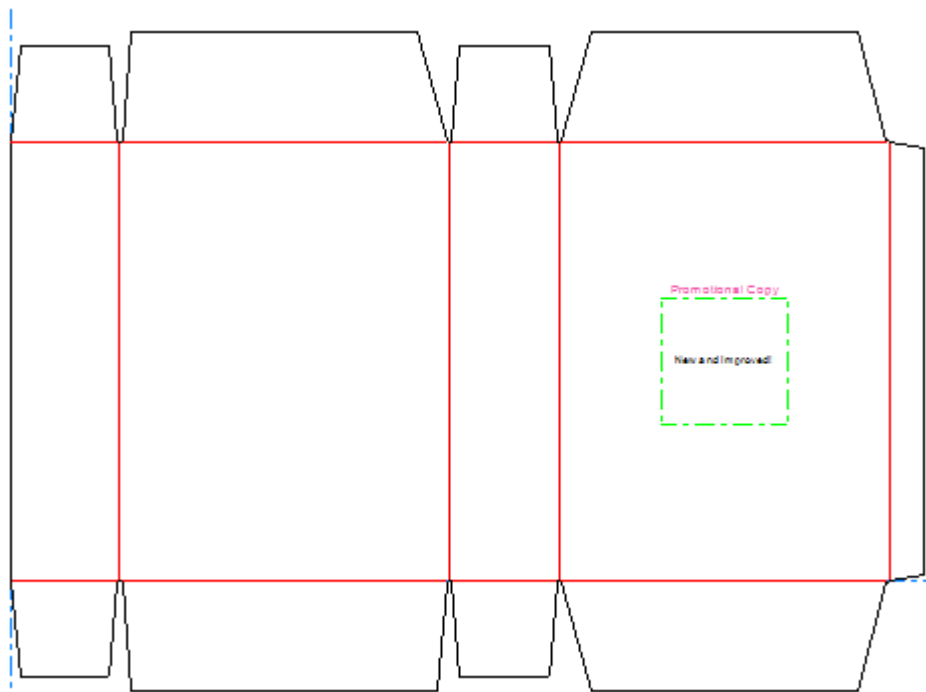

Adding a Barcode Placeholder

To add a barcode placeholder, do the following:

1.  Click **Dynamic Art** and click **Yes** if ArtiosCAD prompts you to create a Dynamic Art layer.
2. In the Dynamic Art Options dialog box, select **Barcode** for the **Type** and choose the desired **Element** from the drop-down list. Enter any desired text in the **Text** field and click **OK**.

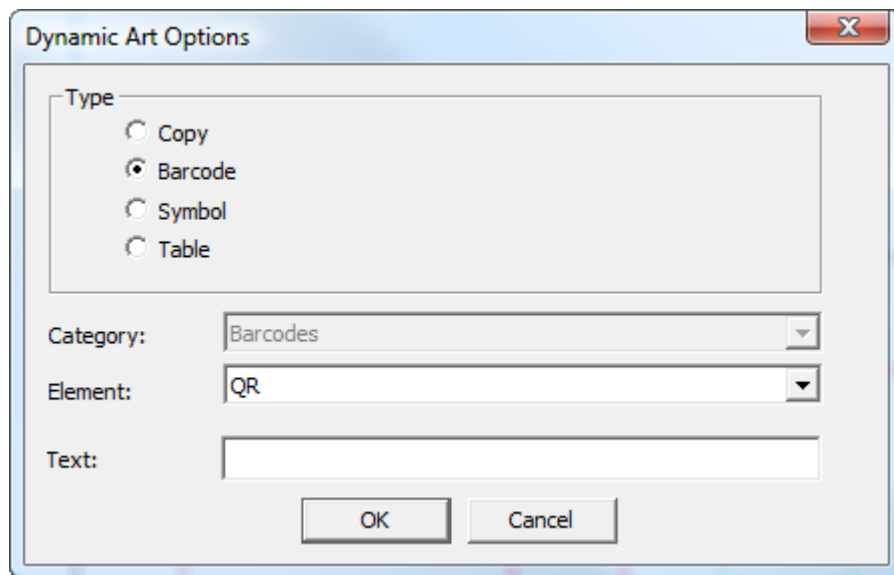

3. Use drag to place the put-down point of the placeholder.

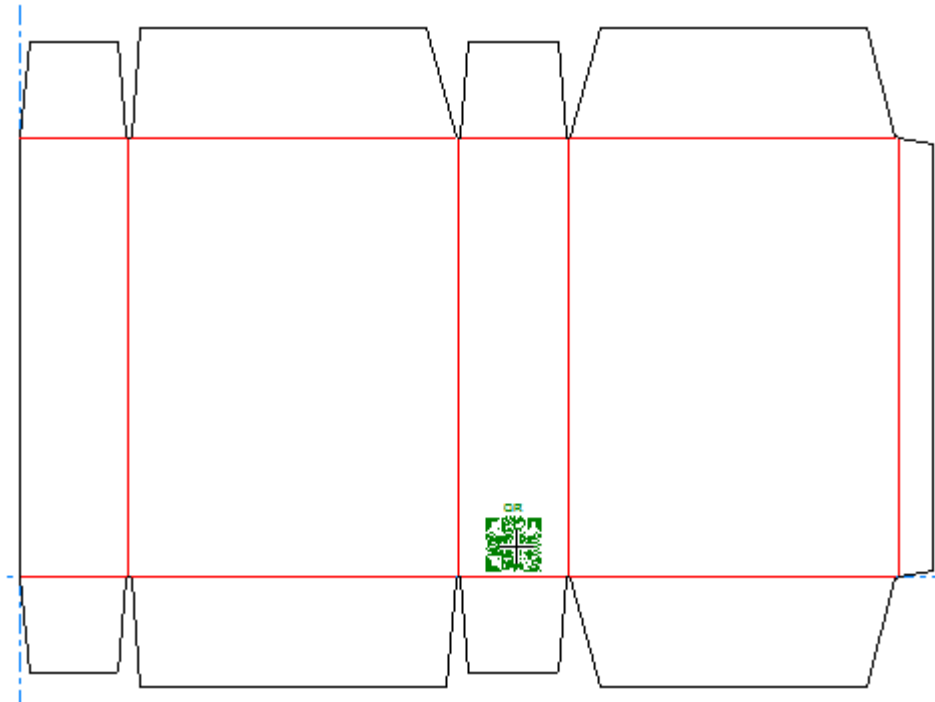

4. Set the fields on the Status bar as desired. **Scale** lets you set the scale of the placeholder. **Width** and **Height** control the width and height of the placeholder. **Text** is the same text you entered in the Dynamic Art Options dialog box in the previous step. The directional label controls let you change the position of the placeholder's label.



Clicking More Options (...) opens the Dynamic Art Options dialog box. There are standard controls for font, color, and appearance. **Panel offset** controls the gutter between the placeholder and the panel edge. **Display "lorem ipsum" when no image or text specified** supplies contents if you don't enter any. When you are done setting options, click **OK**.

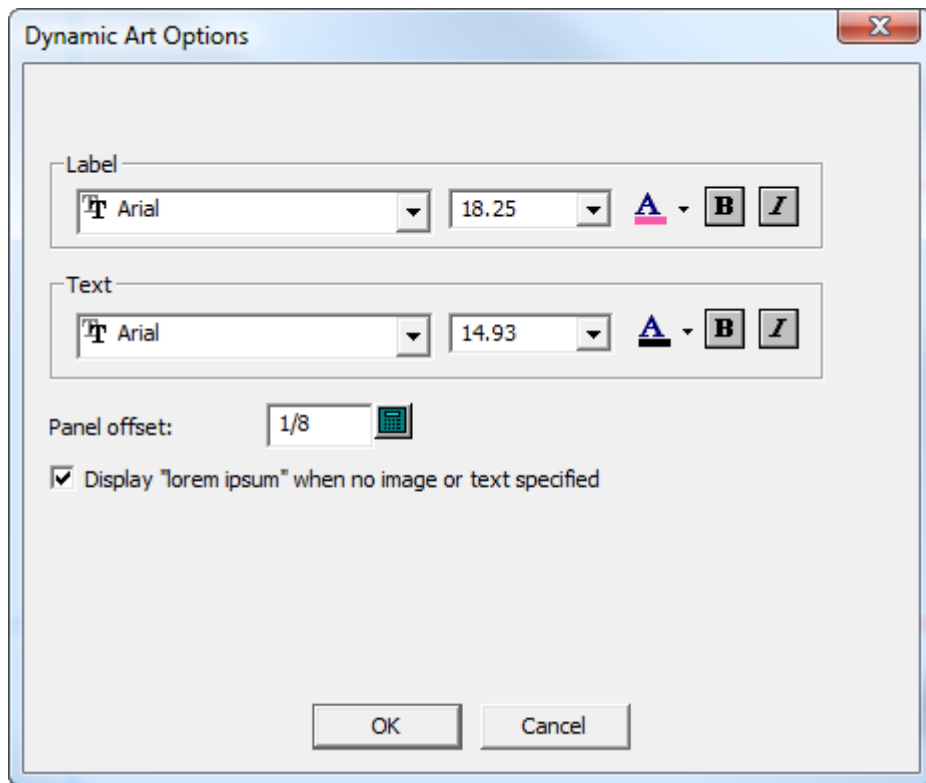

The Dynamic Barcodes plug-in will draw a barcode at its default size in Adobe Illustrator regardless of the scale or size specified for the placeholder in ArtiosCAD.

5. Click **OK** on the Status bar to finalize the barcode placeholder.

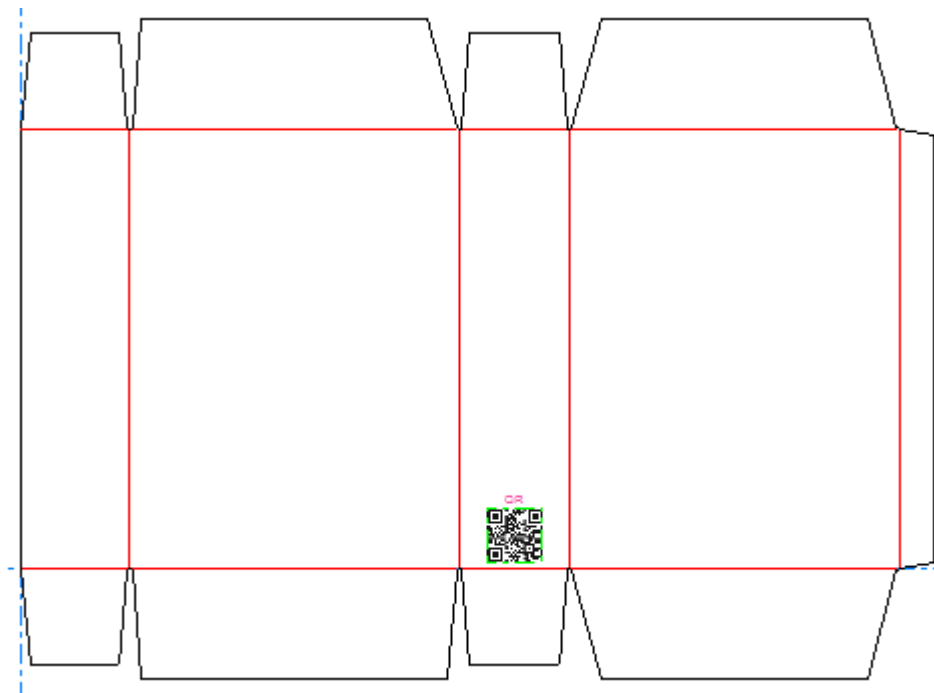

Adding a Symbol Placeholder

To add a symbol placeholder, do the following:

1.  Click **Dynamic Art** and click **Yes** if ArtiosCAD prompts you to create a Dynamic Art layer.
2. In the Dynamic Art Options dialog box, select **Symbol** for the **Type** and choose the desired **Element** from the drop-down list. Enter any desired text in the **Text** field and click **OK**.

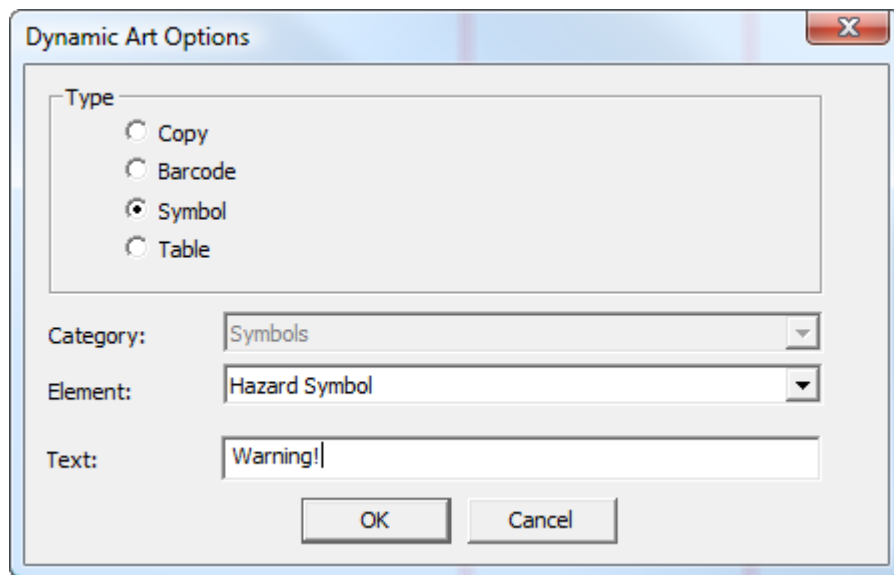

3. Use drag to place the put-down point of the placeholder.

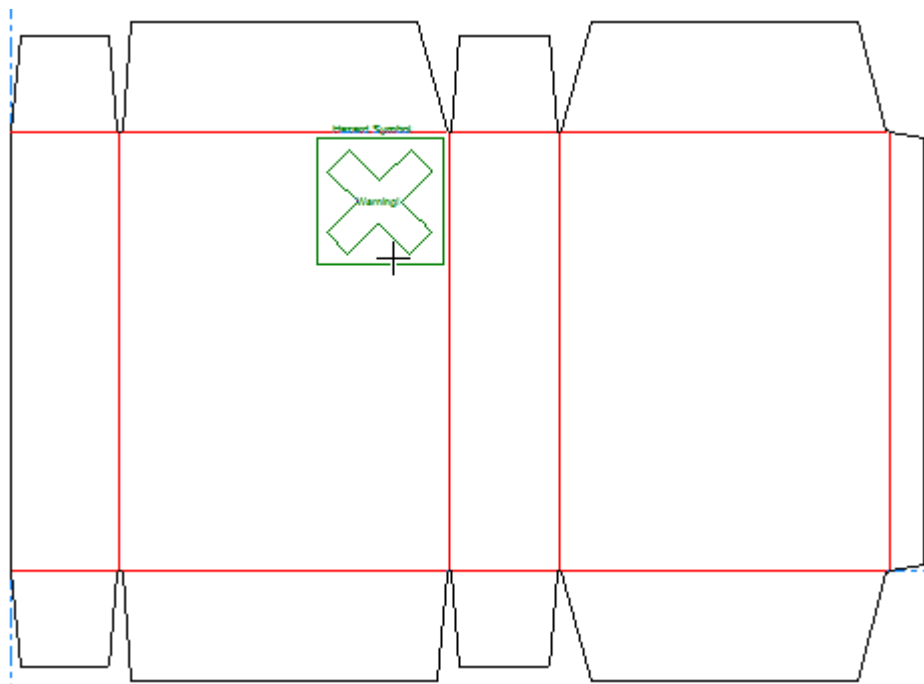

4. Set the fields on the Status bar as desired. **Width** and **Height** control the width and height of the placeholder. **Text** is the same text you entered in the Dynamic Art Options dialog box in the previous step. The directional label controls let you change the position of the placeholder's label.



Clicking More Options (...) opens the Dynamic Art Options dialog box. There are standard controls for font, color, and appearance. **Panel offset** controls the gutter between the placeholder and the panel edge. **Display "lorem ipsum" when no image or text specified** supplies contents if you don't enter any. When you are done setting options, click **OK**.

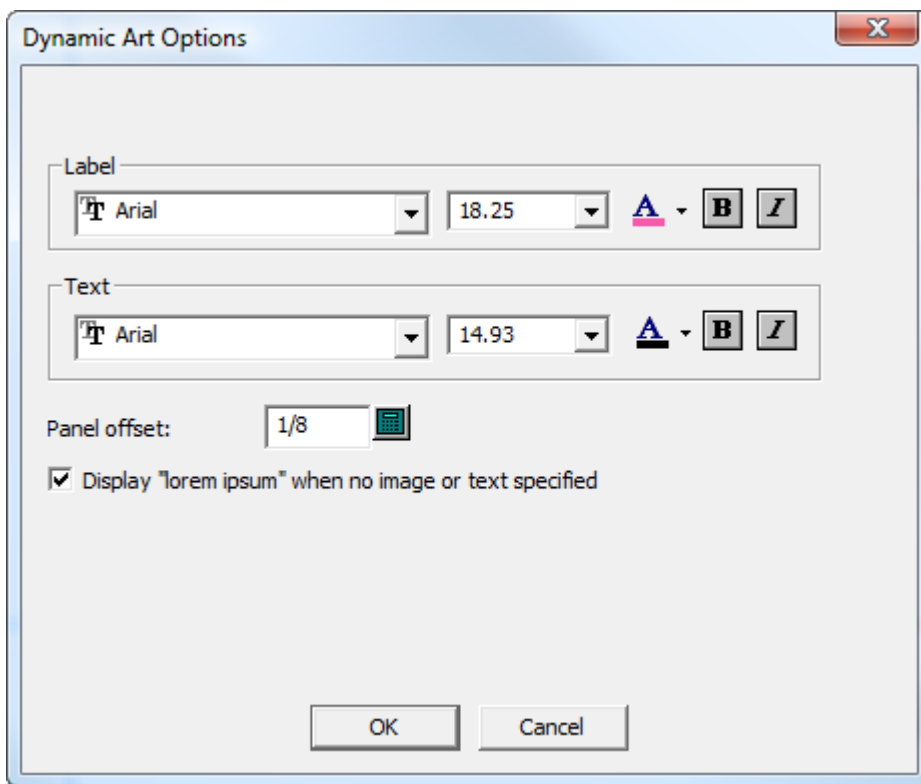

5. Click **OK** on the Status bar to finalize the symbol placeholder.

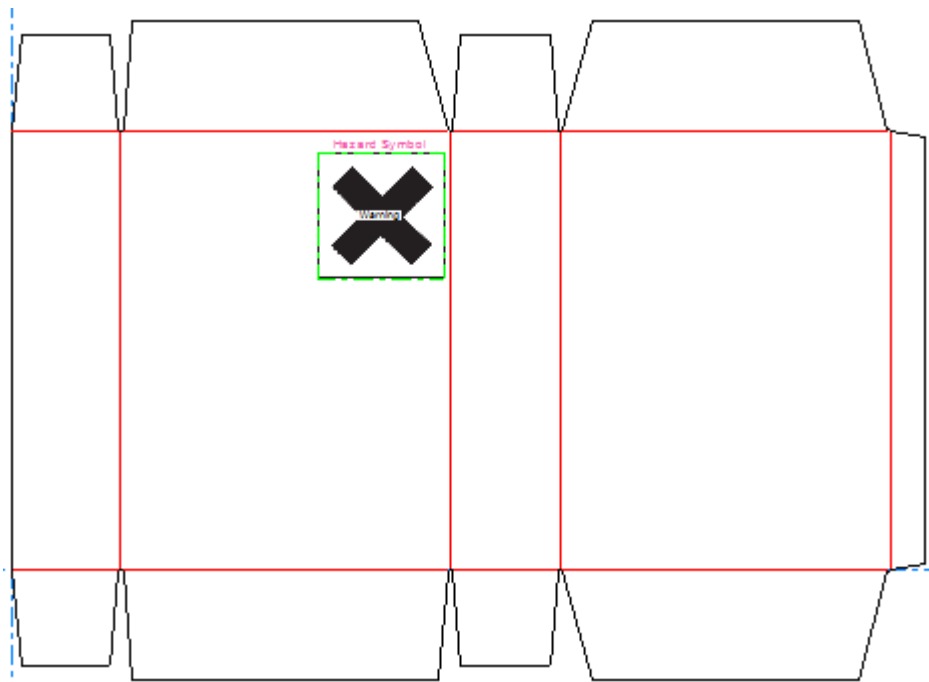

Adding a Table Placeholder

To add a table placeholder, do the following:

1.  Click **Dynamic Art** and click **Yes** if ArtiosCAD prompts you to create a Dynamic Art layer.
2. In the Dynamic Art Options dialog box, select **Table** for the **Type** and choose the desired **Element** from the drop-down list. Enter any desired text in the **Text** field and click **OK**.

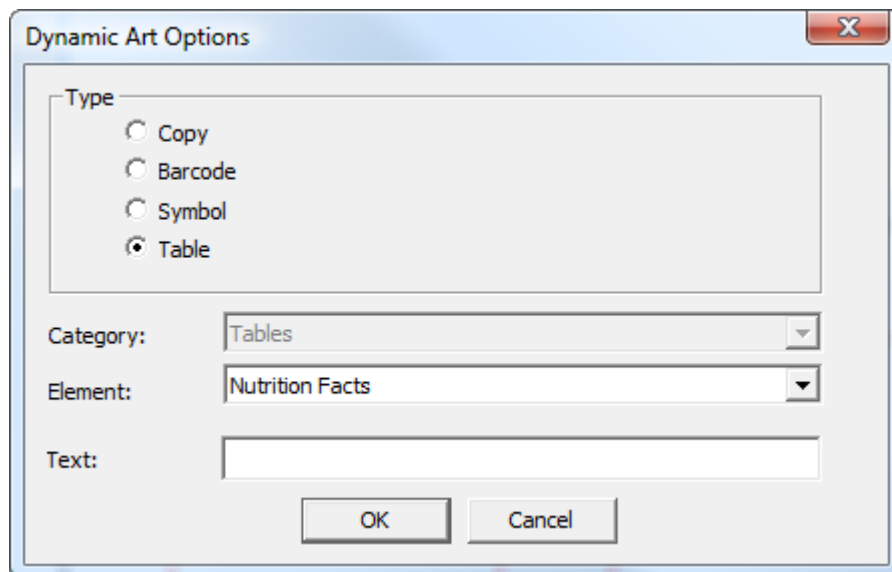

3. Use drag to place the put-down point of the placeholder.

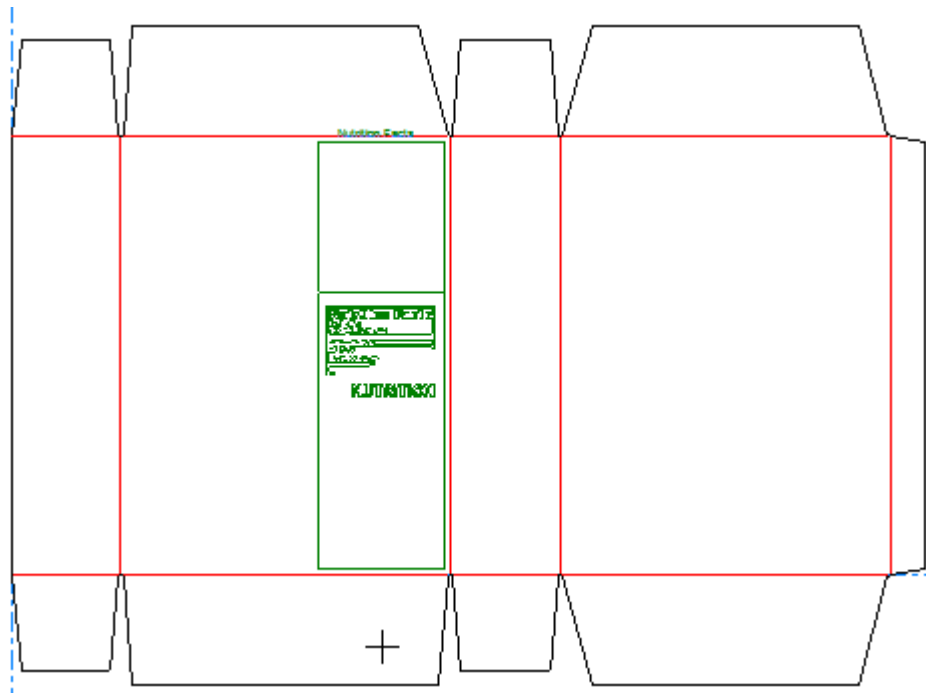

4. Set the fields on the Status bar as desired. **Width** and **Height** control the width and height of the placeholder. **Text** is the same text you entered in the Dynamic Art Options dialog box in the previous step. The directional label controls let you change the position of the placeholder's label.



Clicking More Options (...) opens the Dynamic Art Options dialog box. There are standard controls for font, color, and appearance. **Panel offset** controls the gutter between the placeholder and the panel edge. **Display "lorem ipsum" when no image or text specified** supplies contents if you don't enter any. When you are done setting options, click **OK**.

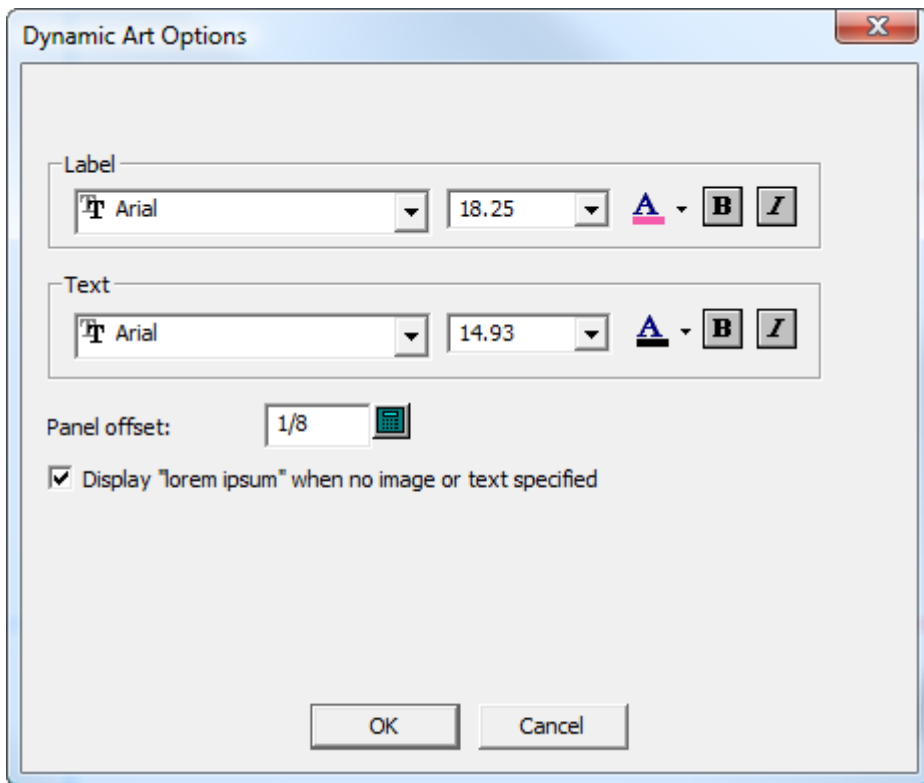

5. Click **OK** on the Status bar to finalize the table placeholder.

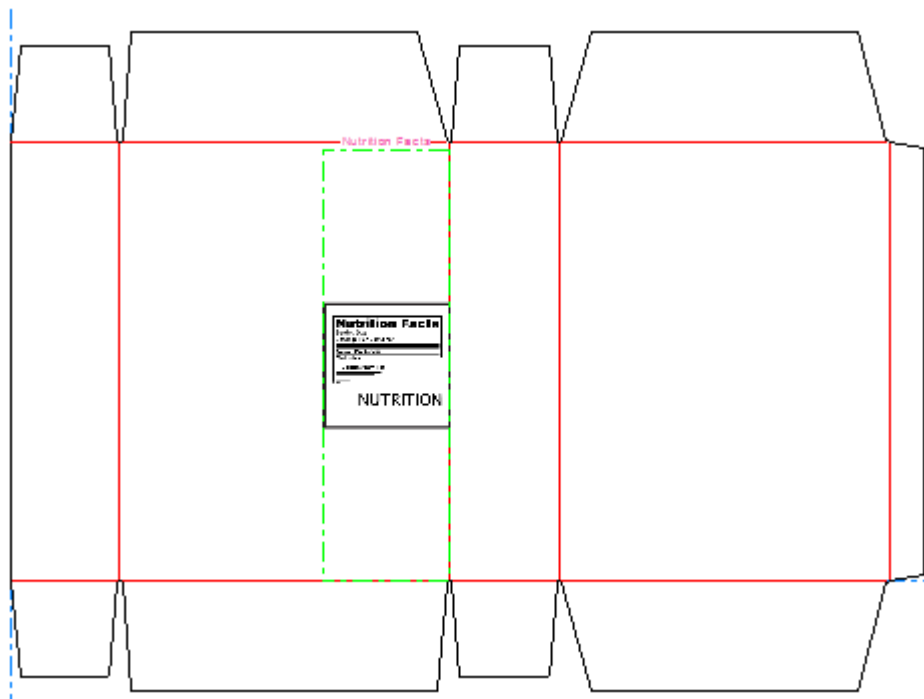

Changing Placeholder Properties

To change the properties of a Dynamic Art placeholder after you have created it, double-click it with the **Select** tool. In the Properties dialog box, you can change all its properties, and change the preview image file (if there is one).

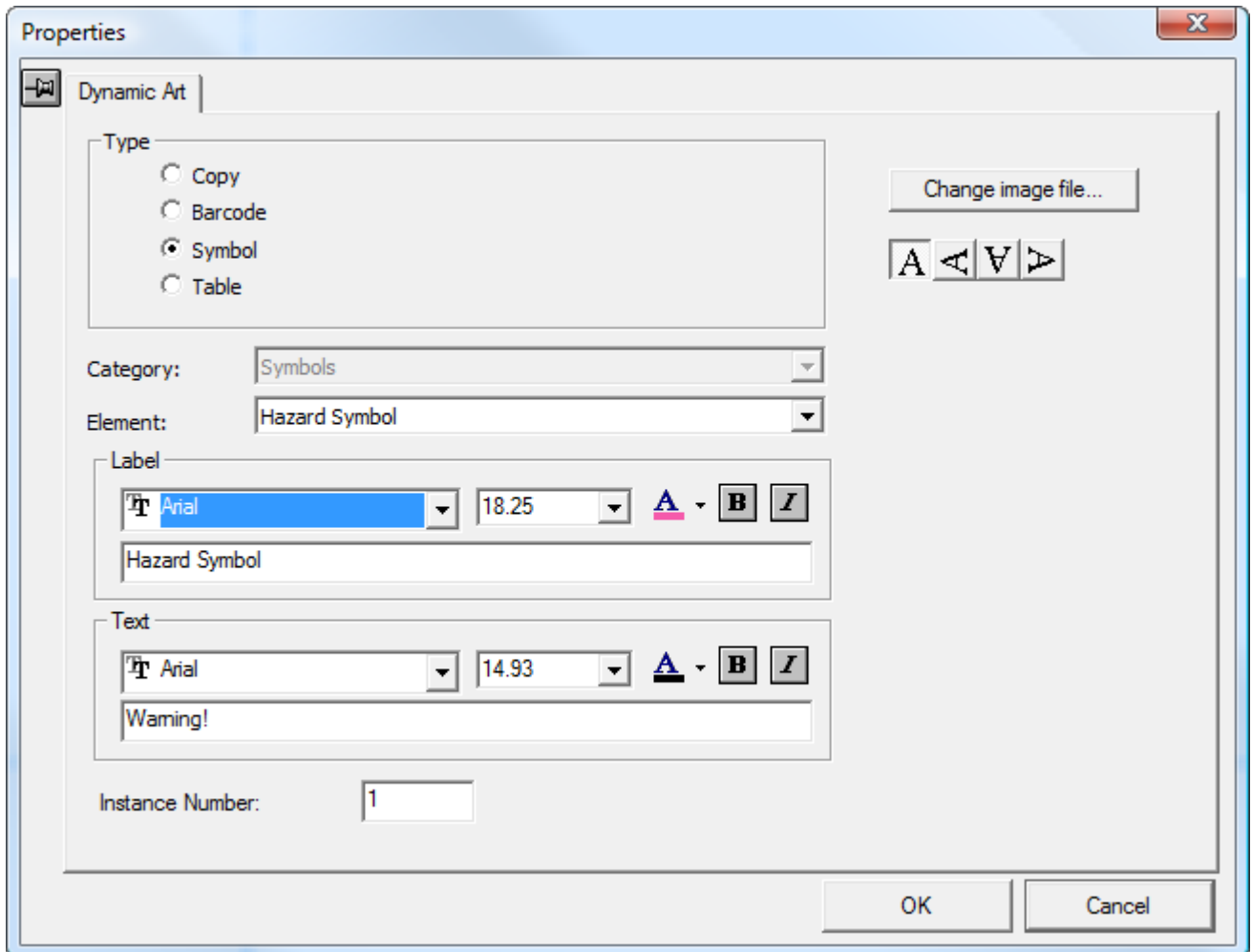

Other functions in Designer

Setting the Grain/Corrugation direction



The **Grain/Corrugation** button on the View bar controls the grain/corrugation direction of the design. A vertical symbol indicates a vertical direction; a horizontal symbol indicates a horizontal direction. Clicking the button opens the Structural Orientation dialog box, where you can set the side of the design and the grain/flute direction. The corresponding

buttons on the Toolbar will reflect any changes you make in this dialog box. Changes made in this dialog box alter the way the current view is interpreted.

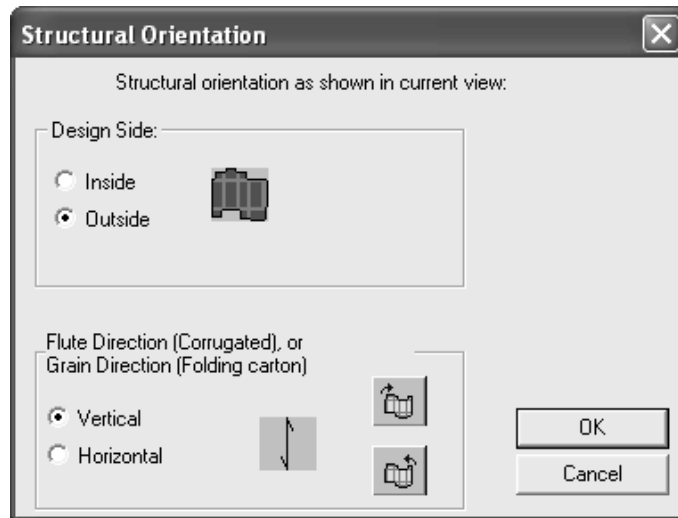

Setting the current side of the design

A design has two sides – the printed side and the unprinted side.

The **Side** button  on the View bar controls which side is up. Blue indicates printed side up; white indicates unprinted side up. This button flips the design when clicked. You may have graphics on both sides of the design.

Units and formatting

The **Units and Formatting** command on the **Options** menu controls the calculation, input, and display of numerals. Change the options as desired. In the **Format** group, you can choose between sixteenths and twentieths.

Note: You cannot change between sixteenths and twentieths in the Dimension Properties dialog box.

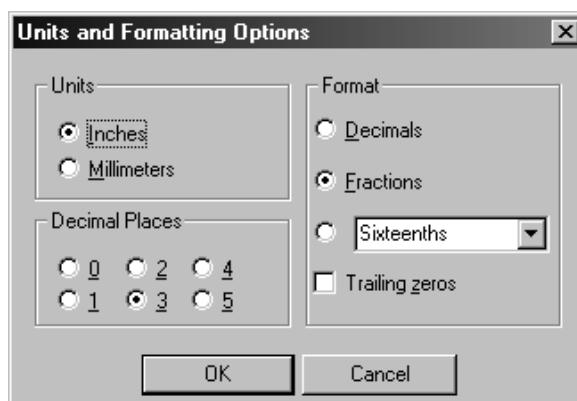

The Units button **In mm** on the View bar changes the units when clicked.

CloseUp windows

Click the middle mouse button to create a CloseUp window. If you don't have a middle mouse button, click **CloseUp** on the View menu or press CTRL-Space. Holding down CTRL while opening a CloseUp window opens it at a different scale.

A CloseUp window shows a zoomed-in view of the area surrounding the point you clicked. A CloseUp window will change if **Show window contents while dragging** is enabled in the Display Properties of the operating system.

Click the magnifying glass icon on the title bar of the CloseUp window to access its menu. Dynamic controls the real-time updating of the window as you drag it. **Options** opens the CloseUp Options dialog box.

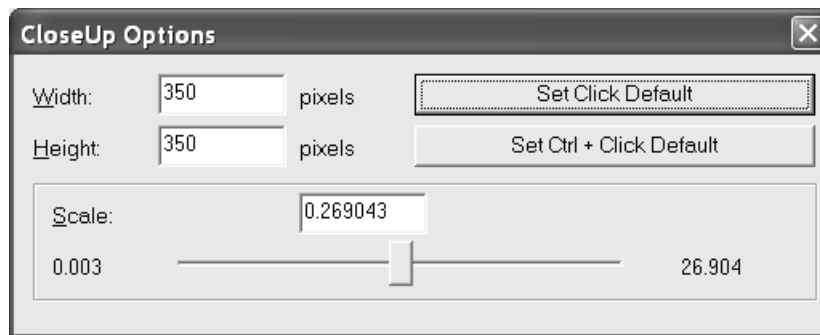

Width and **Height** change the size of the CloseUp window.

Scale and the slider beneath it specify the scale for the CloseUp window.

Set Default makes the values you set the values that are used for the remainder of the current ArtiosCAD session for regular CloseUp windows. **Set Ctrl + Click Default** sets the session default for CloseUp windows opened using the CTRL key.

Clicking the middle mouse button while in a CloseUp window closes the current window. SHIFT-middle mouse button closes all CloseUp windows, as do SHIFT-Spacebar and **Close All CloseUps** on the View menu.

Press CTRL-A to zoom out in CloseUp windows.

CloseUp window defaults are set in **Options > Defaults > Shared Defaults > Startup defaults > View tools options**.

StyleMaker

StyleMaker is an optional feature of ArtiosCAD that allows you to make your designs once and rebuild them with different measurements an infinite number of times.

StyleMaker works by using variables instead of absolute values. *Variables* are ways to store pieces of data that can change in the future. In ArtiosCAD variable names must start with a

letter and can be up to 6 characters long. Only use uppercase letters and numbers for the variable name.

Manipulating variables

There are two ways to define variables – by entering them on the fly in Status bar prompts, or by clicking **StyleMaker** on the Design menu. If you enter a variable on the fly, and have not defined the variable whose name you typed, ArtiosCAD asks you if you want to define the variable now. If you do, you are taken to the **Add Variable** dialog box.

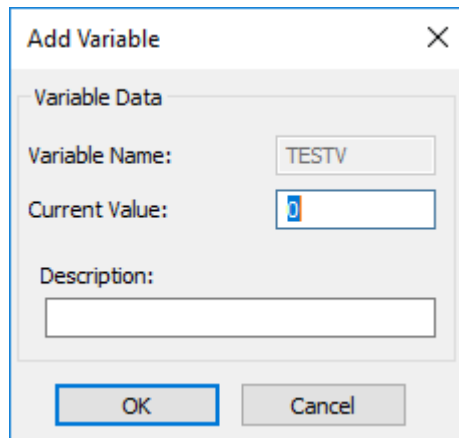

Enter a value to use for the variable in the **Current Value** field and enter the name of the variable in the **Description** field.

When you click **StyleMaker** on the **Design** menu, the StyleMaker dialog box opens.

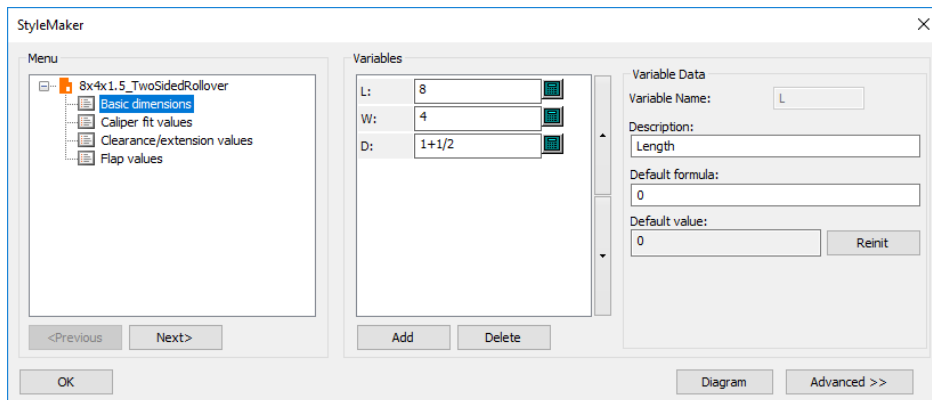

The **Variable Name**: field contains the name of the variable. It is unavailable if you typed the name in the Status bar. The **Description** is what appears in the menu as a ToolTip flyout when you rebuild the design. In the picture shown above, variable L is set to value of 4 with the description of Length. This means that when you are constructing geometry that refers to the length of the design, you can type L to answer prompts instead of 5.

To add a variable, click **Add** in the StyleMaker dialog box, or type its name in a Status bar prompt. All variables you define are shown in the Variable Keypad.

To delete a variable, click **Delete** in the StyleMaker dialog box.

To change the order of menus, drag and drop them as desired.

The **Advanced** button in the StyleMaker dialog box leads to the optional Advanced StyleMaker feature.

Rebuilding a design

Rebuilding a design lets you change the values of the variables you have defined. The process

is similar to running a standard. Click **Rebuild**  on the View bar, or click **Rebuild Design** on the **Design** menu and enter new values in the fields next to the variable names. When you are done entering new values, click **OK**.

Designs based on a pre-LASERPOINT IQ 2 version of LASERPOINT will be rebuilt using a black text window as they were in LASERPOINT.

Rebuilding a design with Rebuild Playback



The **Rebuild Playback** tool on the **Undo/Redo** toolbar and the **Design** menu lets you rebuild a design step by step while looking at the design as it is rebuilt. This is a powerful feature. Always save your design before using this command.

Note: Any commands in the Undo/Redo buffer are lost when you enter the Rebuild Playback tool. Perform all desired Undos and Redos before starting this tool.

When you make a rebuildable design, ArtiosCAD records each mouse click, menu command, and tool selection you make. These commands and procedures are stored in the design file itself. ArtiosCAD rebuilds the design by executing these stored commands with the updated variable values that you specify. When you rebuild a design normally, ArtiosCAD takes the new values and completes the new geometry automatically. The **Rebuild Playback** tool provides more control over the rebuild process.

To use this tool, click **Rebuild Playback**. The following tools will appear in the Status bar.



The **Position** scroll bar lets you step through each step of design construction, with the left most end being the unbuilt design, and the right most end being the built design. The single arrow buttons move the progress indicator by one step, while the double arrow buttons move to either the unbuilt design (the arrow pointing to the left) or the built design (the arrow pointing to the right). As you click the arrows, you will see the design being built. You may also drag the scroll bar button to rebuild the design.

The **Edit** button is described in depth in the following section.

Clicking **OK** accepts the changes you made. If the scroll button on the Position slider is not fully to the right, you are asked if you want to finish the design with the rest of the commands as they are, or if you want to ignore them. Choose appropriately and then click **OK**.



Editing the command history

When the **Rebuild Playback** tool is active, the **Edit** button on the Status bar brings up the **Edit Log** dialog box where you can change the commands used to rebuild the design.



The current command is shown in the **Command** field. You can modify the command directly, or you can just change its parameters by entering new values in the fields in the **Parameters** group. Each command has different parameters.

There are three parameter types. The parameter type affects the button at the end of the parameter input field.

 In the example above, the button is the keypad since both parameters are numeric. To change a numeric parameter, enter a new value, enter a variable or expression (you will be prompted to define the variable if it does not exist yet), or use the buttons on the keypad to indicate distances and angles.

 When the parameter refers to a line, the button is **Select line**. If you click it, you can then choose a different line to be made with the command. Use this with caution!

 When the parameter in the Edit Log dialog box refers to a point, the button is **Select point**, and the point is highlighted in the design area of the ArtiosCAD window. If you click it, you can then choose a different point to be acted on by the command. Use this with caution!

The arrow buttons step through the construction commands just as they do on the Position scrollbar. The double chevron button expands the dialog box to show the actual commands.

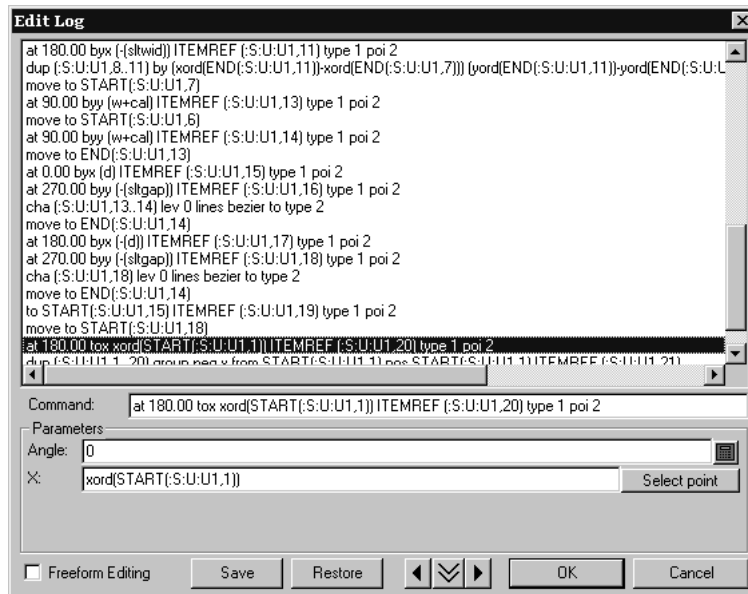

To select a command to modify, click it with the mouse, or move to it using the arrow keys on the keyboard.

The **Freeform editing** checkbox toggles the display of the **Command** and **Parameter** groups. Make changes to the commands by selecting them and then typing over them as you would in a word processor. There is a limit of 4096 characters per line. When in Freeform editing mode, the **Update** button updates the design.

The **Save** and **Restore** buttons let you save the commands to a text file and then restore them if desired. This would be convenient in case you made changes you did not mean to make.

Rebuild Playback notes and warnings

The dimension, **Fill**, and **Stroke** tools are not affected by Rebuild Playback.

The SET, DSET, IF, TRY, and LABEL commands cannot be used in the **Rebuild Playback** tool.

The **Rebuild Playback** tool works only with the commands saved in the design file and commands stored in the **Undo** command buffer. These are set up when the design is first rebuilt. If a restored design has never been rebuilt, starting the **Rebuild Playback** tool will start the rebuilding process first.

Define all desired variables in StyleMaker before running **Rebuild Playback**. Do not define variables in **Rebuild Playback** as this may lead to unpredictable results.

Using Advanced StyleMaker techniques to construct a standard

Creating standards in ArtiosCAD is easy. StyleMaker lets you construct standards with built-in design intelligence. For example, you can create a design in which the number of slots in the base is determined by the width of the design.

You must have purchased the Advanced StyleMaker option in order to use Advanced StyleMaker. If you do not have Advanced StyleMaker, you cannot complete the instructions in this section.

Variables are used to create rebuildable designs. The value of a variable can either be a formula that tells ArtiosCAD how to calculate the value, or it can be a constant value you specify each time the design is rebuilt. To make rebuildable geometry, you specify a variable when asked for a distance, angle, radius, or other measurement.

These instructions assume you already know how to construct geometry and use the tools on the Geometry and Edit toolbars. In this chapter, you will learn how to make a variable number of slots and tabs in a design so that you can make a tray similar to the one shown below.

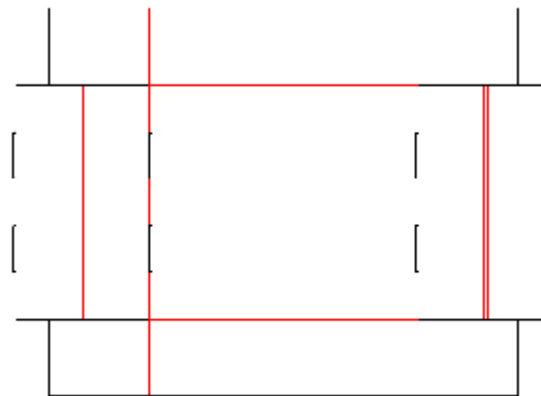

There are four steps to making a standard:

1. Plan the design.
2. Create the design by creating menus, adding variables, and constructing geometry.
3. Test the design.
4. Add the design to a Style Catalog.

Step 1 – Planning the design

The first step in designing a standard is to plan your design. Is there geometry that will always be the same, such as an angle setting or the radius of an arc? Which parts of the design need to be made with variables, and are their measurements dependent on other parts of the design? Be as thorough as possible.

The number of slots and tabs will depend on the width of the design. The standard will also give you the option of specifying the number of slots and tabs desired.

What do you know about the slots? You know that:

1. The slots should all be the same size.
2. The gap(s) between the slots and the slots should be the same length.
3. There should not be a slot touching either end of the line it is on.
4. There will be one more gap than the number of slots.
5. The length of each slot should be based on a fraction of the width of the design.

- 6. The size of the gap between the slots should be the length of the line that the gaps are next to, minus the distance all the slots take up, divided by the total number of slots plus 1.
- 7. The width of the slots should be twice the caliper plus the outside gain.
- 8. There will be times when you will want to specify the number of slots regardless of any formula.

These same bits of knowledge also apply to the number of tabs.

Let's assign variables and convert these concepts into expressions that can be used as formulae in ArtiosCAD.

Concept	Value
Length, Width, Depth	L, W, D
Caliper of the board	CAL
Method of creating slots (automatically or manually)	SLTMET
Number of slots and tabs	SLTNUM
Slot length	$SLTLEN=W/(2*SLTNUM+1)$
Slot width	$SLTWID=2*CAL$
Gap between slots	$SLTGAP=((W+CAL)- SLTNUM*SLTLEN) / (SLTNUM +1)$

Step 2 – Creating the design

Once you have planned as much as possible, it is time to begin using ArtiosCAD to transform your creative ideas into a design.

Create a blank design by starting ArtiosCAD and clicking **File > New > Design**. Choose an appropriate parameter set and board code.

Enter StyleMaker by clicking **StyleMaker** on the **Design** menu.

Click **Advanced** to enter Advanced StyleMaker.

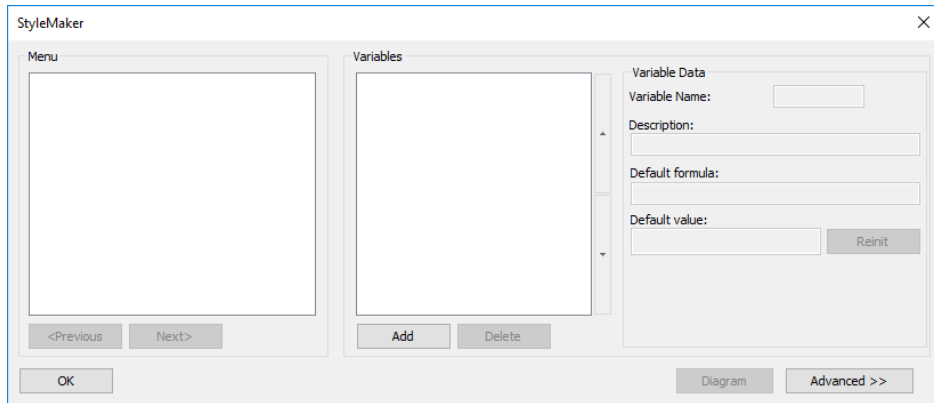

Shown below is the Advanced StyleMaker dialog box.

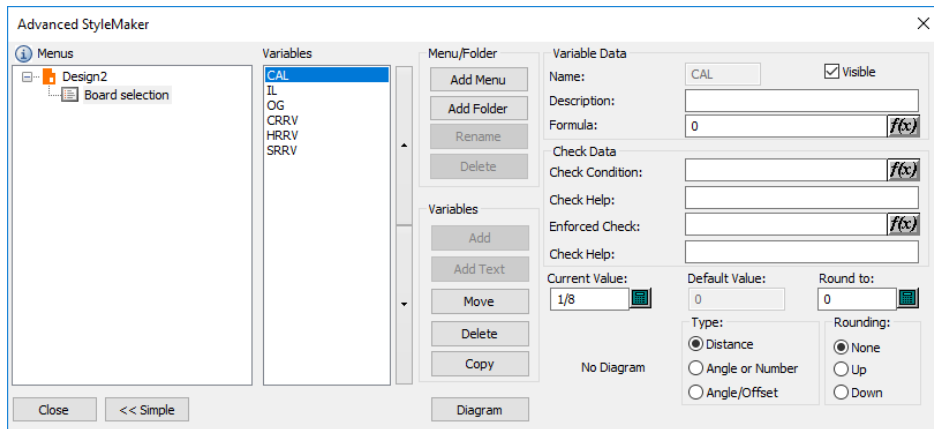

Making menus and creating variables

When you create a new blank design, ArtiosCAD automatically inserts a Board Selection menu so that you can change the board specifications when rebuilding the design.

Even though variables may use variables previously defined in the same menu as elements of their default values, the variable values are only saved when the menu is exited, and that variables within a menu may not reinitialize as expected. You could combine the variables into fewer menus, but that could affect the robustness of the rebuild process. SLTLEN and SLTGAP should be in separate menus after SLTNUM is defined. Thus, you need to add five menus.

The first menu should contain the basic dimensions of the design. The second menu should contain slot style choices – how ArtiosCAD will determine the number of slots in the design. The third menu should have the variables needed to calculate the number of slots. The fourth menu should have the slot length variable, and the last menu should have the slot gap variable.

Adding the Inside Dimensions menu

ArtiosCAD comes with a set of predefined menus and variables to aid in the construction of standards. Click **Copy** in the **Variables** group of the Advanced StyleMaker dialog box.

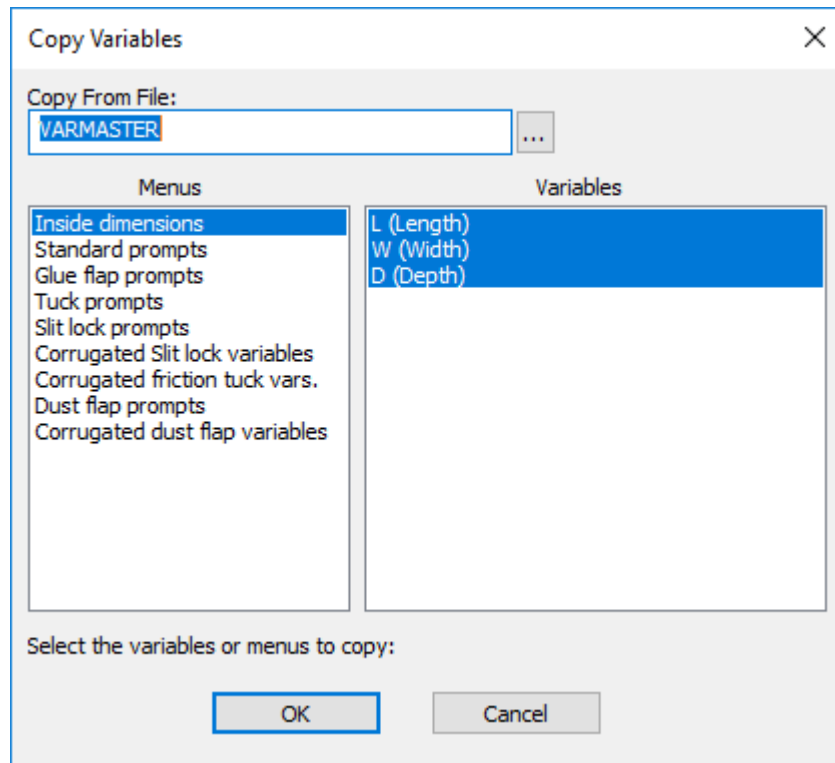

The **Inside Dimensions** menu and the variables within it are selected by default. Click **OK** to copy them into your design. In the Copy Menu or Variables dialog box, select **Copy entire menu** and click **OK**. The Advanced StyleMaker dialog box should look similar to the one shown below.

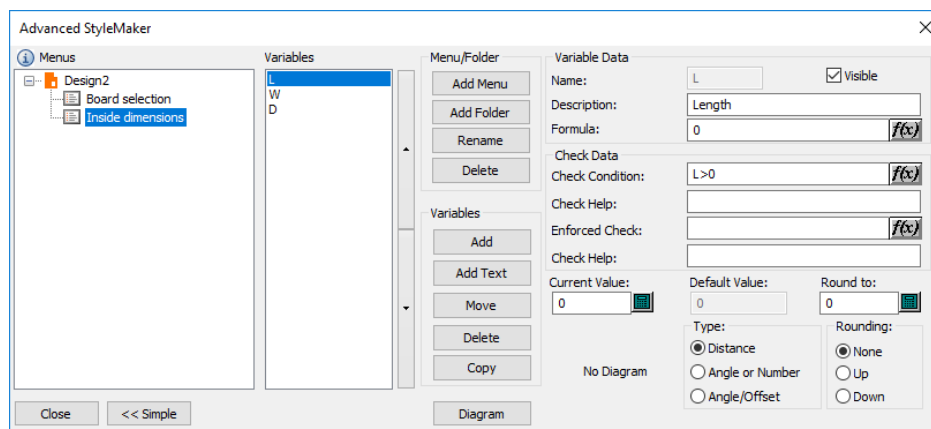

Select each variable and enter a value in the Current Value field. Suggested values are 24 inches or 600 millimeters for the length and width, and 12 inches or 300 millimeters for the depth.

Adding the Slot style choices menu

Click **Add Menu** in the Menu/Folder group to add the menu for the slot style choices. In the Menu Name dialog box, enter Slot style choices as the title of the menu. Set the menu type option button to **Style Choice Menu** as shown in the figure below. Click OK.

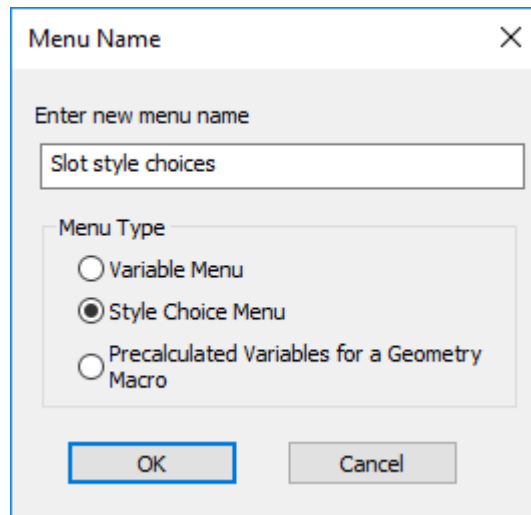

Click the **Add** button in the **Variables** group of the Advanced StyleMaker dialog box. Enter SLTMET in the **Variable Name** field and click **OK**.

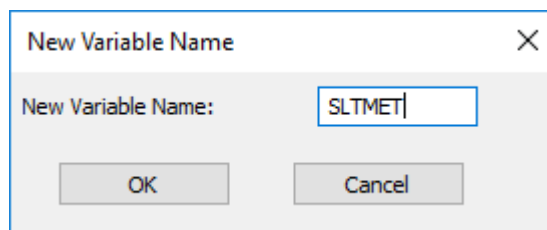

Once you click **OK**, the variable will appear in the list of variables. In the **Group title** field, enter Slot style choices. This is what will appear as the title of the group of choices presented when rebuilding the design. The way style choice variables work is that they set the variable to a value from a series of values that correspond to the entries you create in the **Style Choices** group. For example, the first entry you add sets the variable to 1, the second to 2, the third to 3, and so on. You then build geometry with the logic of "If X=1 then do A, if X=2 then do B, if X=3 then do C" and so on.

Click **Add** in the Style Choice Variable Data group and enter Auto as the caption (name) of the first choice. Click **Add** again and enter 1 as the caption. Repeat and enter 2 as the caption. Repeat and enter 3 as the caption. You should have a dialog box that looks similar to the one shown below.

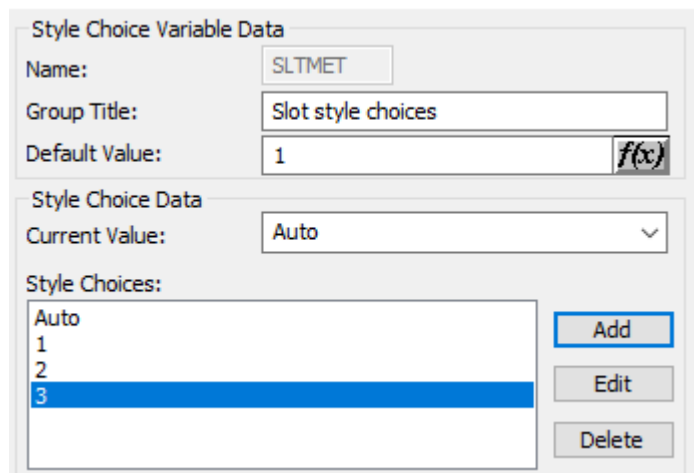

In this example, when rebuilding the design, if you pick choice **Auto**, SLTMET will be 1. If you pick choice **1**, SLTMET will be 2, and so forth.

Adding the Number of slots menu

Now comes the part where we build intelligence into the design. Click **Add Menu** in the Menu/ Folder group to add a new menu. Name it Number of slots and set the menu type option button to **Variable Menu** and click **OK**. Click **Add** in the Variable group and enter SLTNUM. Enter Number of slots in the Description field. Set the type to **Angle or Number** in the Type group. Click the formula button at the end of the **Formula** field to open the Edit Expression dialog box.

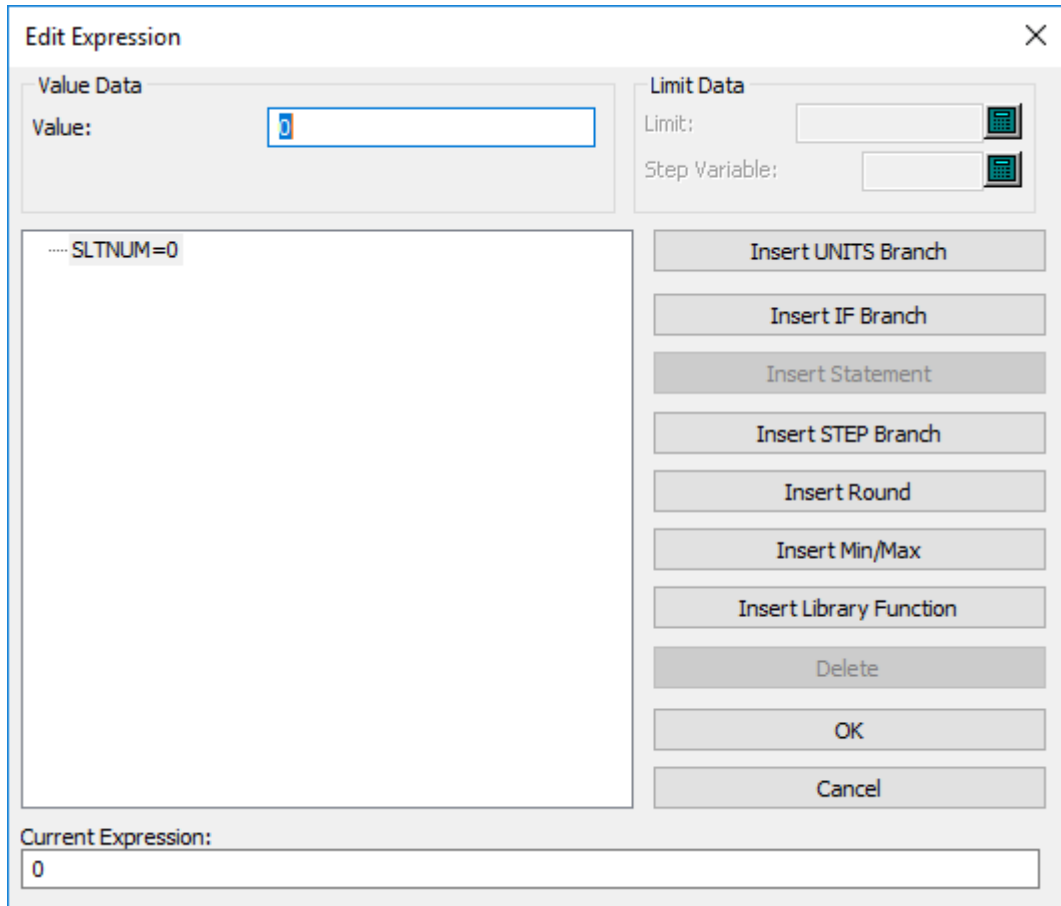

The logic to build into the design is an IF...THEN...ELSE structure. Click **Insert IF Branch**. In the IF Expression field, enter SLTMET=1. In the IF Value field, enter 1. In the ELSE Value field, enter 2. This means that if SLTMET=1 (if the Slot style choice is set to 1), then set the value of SLTNUM to 1, else set it to 2. Click **OK**.

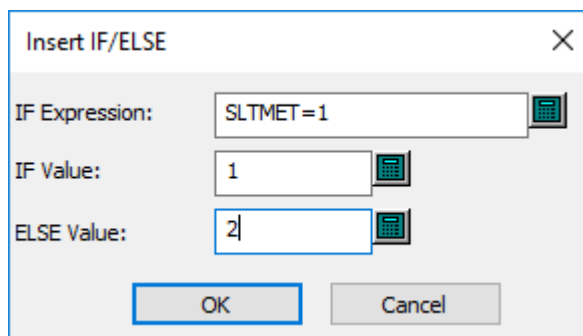

```

IF/ELSE
  IF SLTMET=1: SLTNUM=1
  ELSE: SLTNUM=2
    
```

But when the first Slot style choice is chosen (the Auto choice), ArtiosCAD is to automatically decide how many slots are needed. Therefore, a STEP function needs to be inserted in the IF statement.

A STEP function is an expression that uses this logic: When A is less than constant 1, set B to value X. When A is greater than (or equal to) constant 1 but less than constant 2, set B to value Y. When A is greater than (or equal to) constant 2 but less than constant 3, set B to value Z, and so on.

Therefore, select the **IF SLTMET=1: SLTNUM=1** entry and click **Insert STEP Branch**.

The number of slots should be based on the width of the design. Therefore, set the **STEP** variable to W. When the width of the design is less than 6, only 1 slot should be made; set the Step Limit to 6 and the Step Value to 1. Set the Otherwise value to 2. Click **OK**. The Edit Expression dialog box should look similar to the figure below.

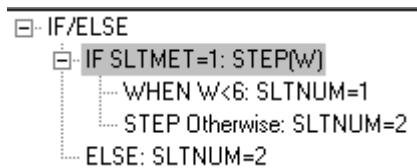

Now we want to add a STEP branch for when the Width is greater than 6 but less than or equal to 12. Click the **STEP Otherwise** line and then click **Add Step Entry**. Enter 12 for the Step Limit and 2 for the Step Value.

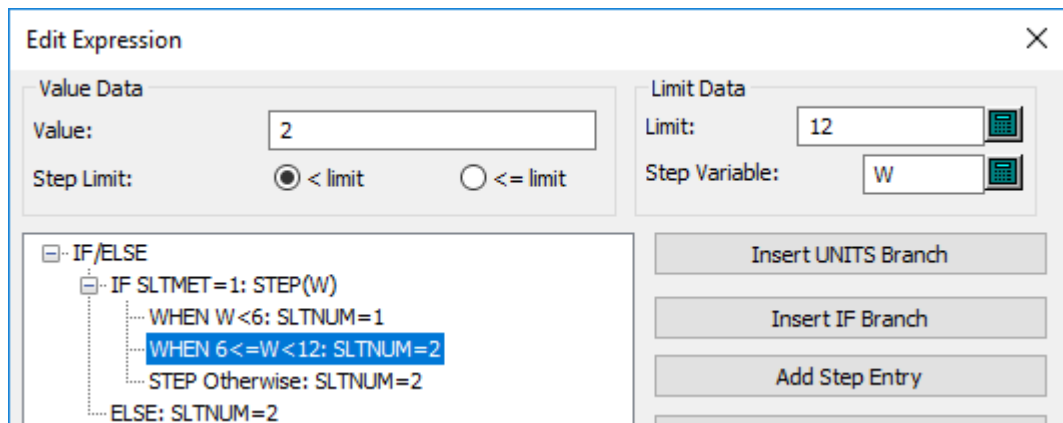

Repeat this process of adding STEP entries 4 times, increasing the Step Limit by 6 each time and the Step Value by 1 each time. The final **IF SLTMET=1** entry of the IF statement should look like the one in the next picture.

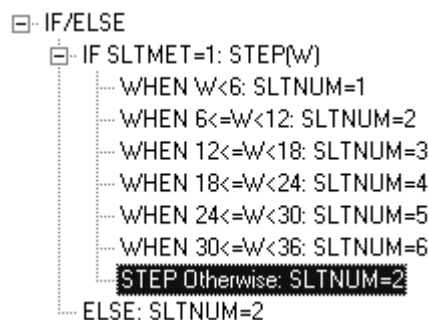

Now ArtiosCAD knows the number of slots to make if the **Auto** choice is chosen in the Slot Style Choices menu. However, IF statements must still be added for the other style choices.

Click the **ELSE: SLTNUM=2** entry and then click **Add If Entry**. Enter SLTMET=2 in the If Expression field and 1 in the If Value field. Click **OK**.

Add two more **IF** entries with the first having the If Expression of SLTMET=3 and the If Value of 2, and the second having the If Expression of SLTMET=4 and the If Value of 3. When you have finished, the Edit Expression dialog box should look like the following picture. Click **OK** to return to the Advanced StyleMaker dialog box.

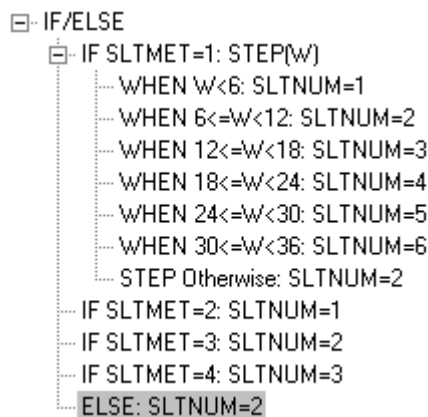

Now that the number of slots has been determined, you can set up the variables for the slot length and the gap between slots.

Adding the Slot dimensions menu

Click **Add Menu** in the Menu/Folder group. Enter Slot dimensions for the menu name and set the menu type option button to **Variable Menu**. Click **OK**.

Click **Add** in the Variable group. Enter SLTLEN as the name of the new variable and click **OK**. Enter Slot length in the Description field. Going back to what you know about the slots, enter $W / (2 * SLTNUM + 1)$ in the Formula field.

Click **Add** in the Variable group. Enter SLTWID as the name of the new variable and click **OK**. Enter Slot width in the Description field. Going back to what you know about the slots, enter $CAL * 2$ in the Formula field.

Now that the slot dimensions have been added, the slot gap variable can be added. This variable can be in the same menu as the Slot length and Slot width variables since it will be a hidden variable as it should not be modified when rebuilding the design.

Click **Add** in the Variable group. Enter SLTGAP as the name of the new variable. Clear the **Visible** checkbox so that no check appears in it. Enter Gap between slots in the **Description**: field. Going back to what you know about the slots, enter $((W + CAL) - SLTNUM * SLTLEN) / (SLTNUM + 1)$ in the Formula field. You may have to put in a temporary formula in order to clear the **Visible** checkbox.

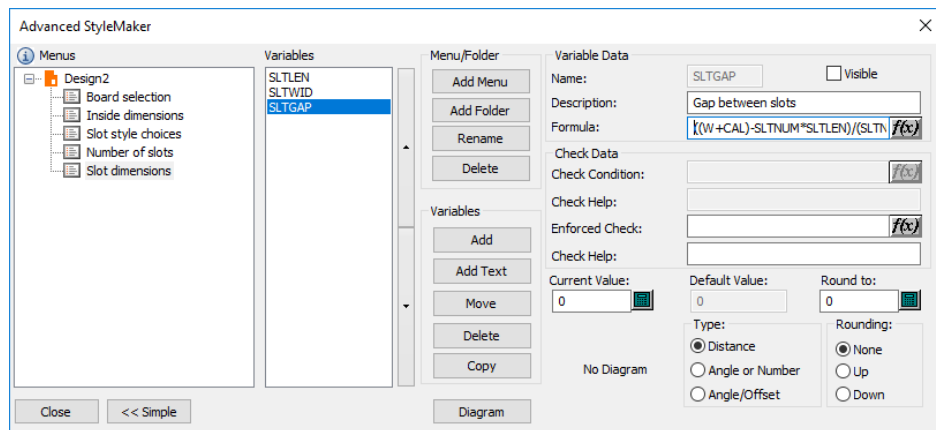

Now that all the menus and variables are defined, design construction can begin. Click **Close** and then save the design before proceeding.

Constructing the design

We will draw only half the design as it can be copied using the **Copy Vertical Mirror** tool to make a complete design.

Using the **Line** tool, draw a line at 0 degrees horizontally right from the origin with an X offset of L/2.

Draw a line from the end of line 1 up by SLTGAP. Change this line to a crease by selecting the **Select** tool, then double-clicking the line and selecting **Crease** in the Properties dialog box and clicking **OK**.

Change to the **Rectangle** tool and move the cursor in an up and left direction. Set the X offset to SLTWID and the Y offset to SLTLEN. You should have something that looks like the following picture.



Click the **Select** tool and select the crease and the slot.

Click the **Copy Times Offset** tool. The status bar will prompt for the number of copies to be made. Enter SLTNUM-1 and press Enter. Use the bottom point of the crease as the pick-up point. Set the angle to 0 vertically. Use the top right corner of the slot as the put-down point. You should have a construction similar to the figure shown below.

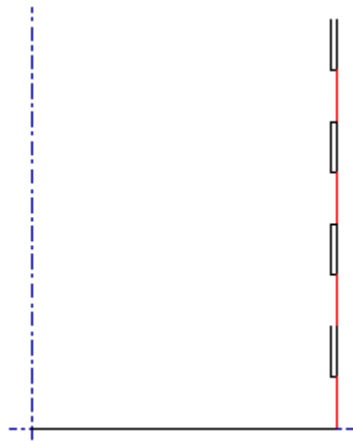

Use the **Move to Point** tool to move to the intersection of the bottom length line and the crease with the slots.

Make a horizontal line to the right using D for the X offset.

Make another horizontal line to the right using CAL*2 as the X offset.

Make yet another horizontal line to the right using D for the X offset.

Make a vertical line going up using SLTGAP as the Y offset.

Make a horizontal line going right using SLTWID as the X offset.

Make a vertical line going up using SLTLEN as the Y offset.

Make a horizontal line going left using SLTWID as the X offset. You should now have a construction similar to the one shown below.

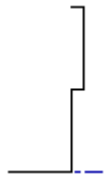

Use the **Select** tool to select the tab construction.

Use the **Copy Times Offset** tool to copy the tabs the same way as you copied the slots. Use SLTNUM-1 as the number of copies, use the intersection of the horizontal cut line and the vertical cut line as the pick-up point, set the angle to 0 vertically, and use the top left point of the tab as the put-down point. The result should be similar to the construction shown below.

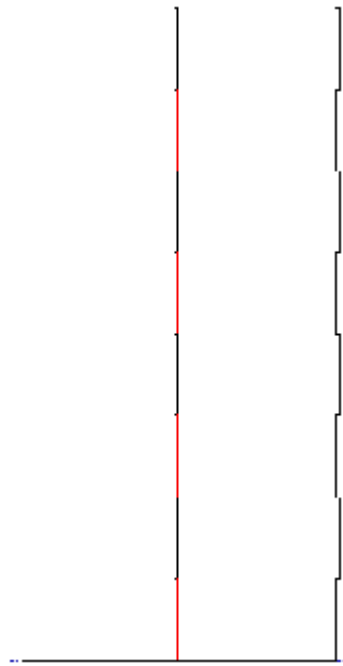

Click the **View Mode** button on the Zoom toolbar and turn on **Endpoints** in the **Styles** group.

Use the **Move to Point** tool to move to the right most point of the group of two points on the bottom cut line. You may need to zoom in to see the two points.

Use the **Line** tool to create a vertical line going up using W+CAL as the Y offset.

Use the **Move to Point** tool to move to the left most point of the group of two points on the bottom line.

Use the **Line** tool to create a vertical line going up using W+CAL as the Y offset.

Connect the tops of the two lines with a cut line.

Change both vertical lines just created to creases and turn off the viewing of endpoints. You should have a construction similar to the one in the picture below.

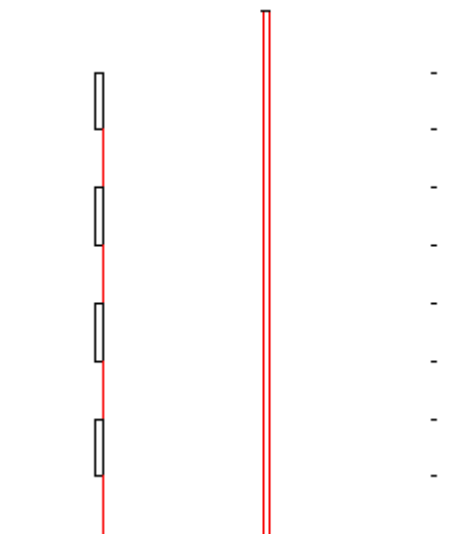

Use the **Move to Point** tool to move to the top of the right crease.

Draw a horizontal line to the right using D as the Y offset.

Draw a vertical line down using SLTGAP as the Y offset. IMPORTANT: DO NOT SNAP TO THE TOP OF THE TAB!

Use the **Move to Point** tool to move to the top of the left crease.

Draw a horizontal line to the left using D as the Y offset.

Draw a vertical line down using SLTGAP as the Y offset. IMPORTANT: DO NOT SNAP TO THE TOP OF THE SLOT!

Change this vertical line to a crease.

Draw a horizontal line from the top of the crease just created to the vertical axis. You should have a construction similar to the one shown below.

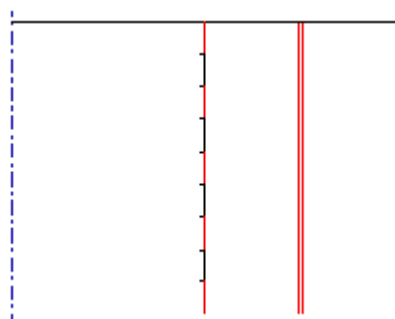

Use the **Select** tool to select all the lines in the design.

Click the **Copy** button on the Edit toolbar, then click the **Mirror About Line** button. Click to the immediate left of the vertical axis. You should have a construction similar to the one shown below. Save the design!



Construct the rest of the tray using the techniques learned so far.

Step 3 – Testing the design

There are two things to test in this design – its rebuildability and how it actually will work if produced. Rebuild the design using the **Rebuild design** command on the Design menu. Use different combinations of values for the length, width, and depth. Set the slot style choice to something different every time. You will have to REINIT the Slot Length variable each time you rebuild.

Use 3D to test its worthiness for becoming a production design. Make sure the tabs fit in the slots and that the rollover works correctly.

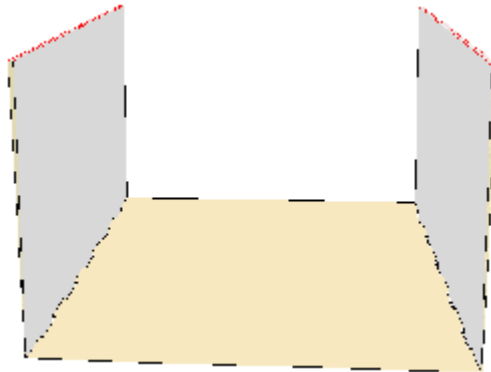

Step 4 – Adding the design to a Style Catalog

To give everyone using ArtiosCAD access to this new standard, add it to a Style Catalog. You should also put a copy of the design file in ..\Esko\Artios\ServerLib.

1. Exit from any open design so that the only commands on the menu bar are File, Options, and Help.
2. Click **Defaults** on the **Options** menu.
3. Right-click Style Catalog in the left-hand pane and pick **New**, then **Data** from the context menu.
4. Enter a name such as Custom Tray. Do not press Enter when done; rather, double-click the icon that precedes the name.
5. Set the **Standard Type** option button to **ArtiosCAD**.
6. Click  and double-click the resizable design you want to add to the catalog. The dialog box should have the same title as the name you entered, and should look similar to the following picture.

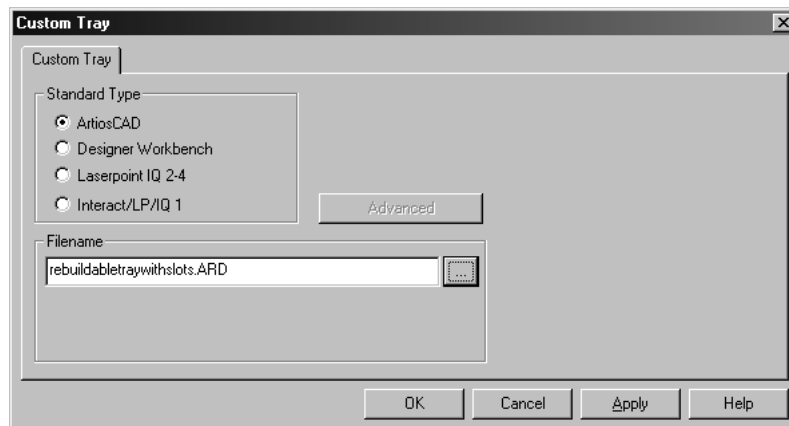

7. Click **OK** to add the design to the Style Catalog. The Shared Defaults pane of the Defaults dialog box should look similar to the following picture.

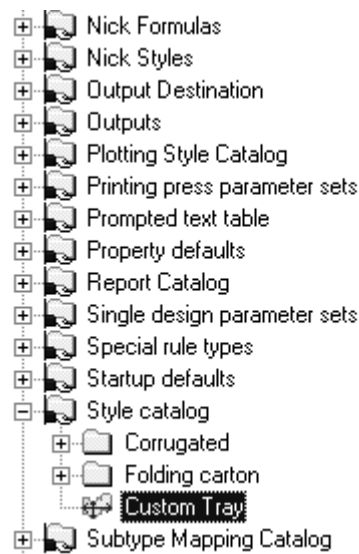

8. Click **File**, then **Save** to save the shared defaults. Next time you run Builder, you will see your custom design in the catalog listing as shown in the following picture.

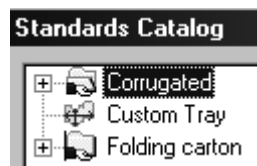

Your rebuildable design is now complete and can be used by everyone who uses this installation of ArtiosCAD.

Designing for Re-board®

Re-board® is a thick board made from recycled paper. Using it requires some different design techniques in ArtiosCAD from working with regular boards.

When you begin a design for Re-board®, use Inside view, Die Back side, and draw up and to the right to get the most sensible results.

When working with Re-board®, you must choose the proper V-notch line types when designing a single design. ArtiosCAD comes with crease types and cut types in the special rule catalog as shown below, but you can add others of your own specification to the catalog as desired.

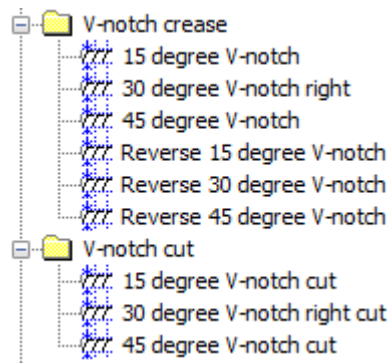

There are also generic Sample V-notch crease and Sample V-notch cut linetypes, along with a Sample reverse V-notch crease line type for use in samplemaking.

Because the knife on a samplemaker that cuts V-notch lines is not vertical, but instead is at an angle, there is a top to the cut (where the knife enters the material) and a bottom to the cut (the point at which the material rests on the table). The V-notch cut lines draw double lines but act as generic cuts when determining area, making a layout, and so forth. The principal black line shows the bottom of the angled cut, which is the line you draw, and the auxiliary red line shows the top edge of the angled cut. If the top red line does not affect the printable area, ArtiosCAD shows it as a dotted line.

ArtiosCAD fills area between the two lines to make it easier to understand what will be cut on a samplemaker. Dark yellow shading means you can see the medium between the two liners. Gray shading means you are looking at the bottom of the board and can't see the medium. Light yellow shading means ArtiosCAD cannot determine which side it is because the shape is not closed.

Consider the following constructions all shown in the inside view and Die Back side, and their results in 3D, inside view.

In this example, the black lines are reverse 30-degree V-notch cuts. Because the shading is gray, you can't see the medium, and because the red lines are dotted, they do not affect the print area size. The bevels are going toward the center of the design.

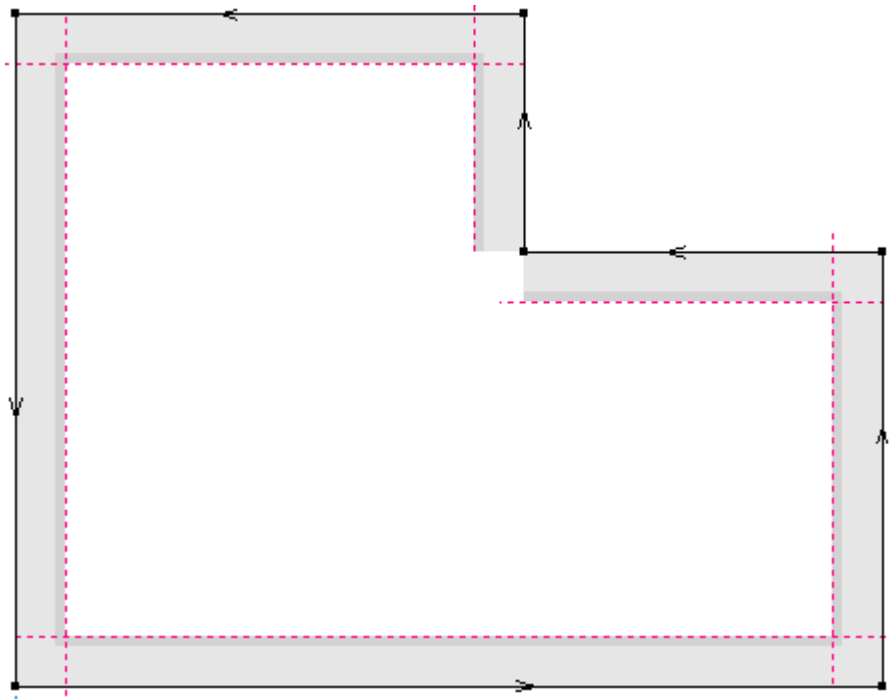

When you convert to 3D:

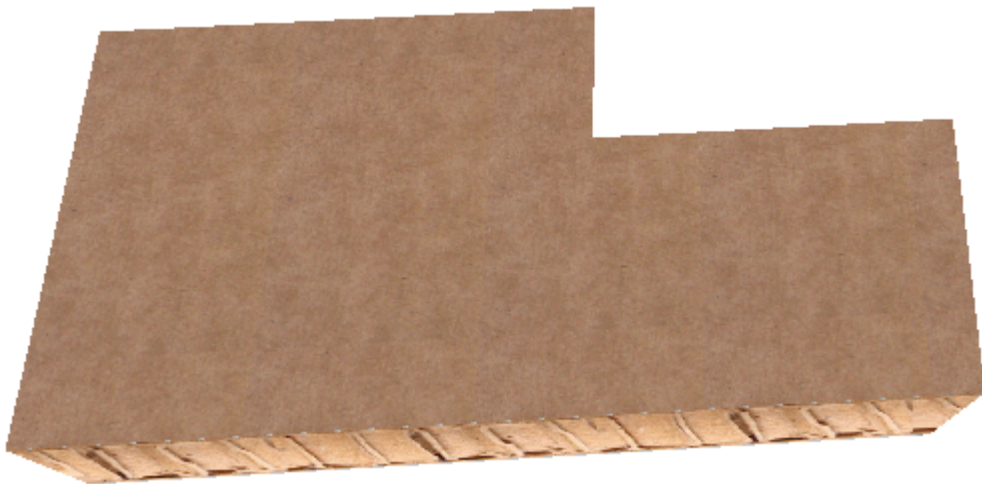

In this example, the black lines are again reverse 30-degree V-notch cuts, but note the line direction is opposite from the previous example. Also note that the shading is dark yellow, which means you can see the medium.

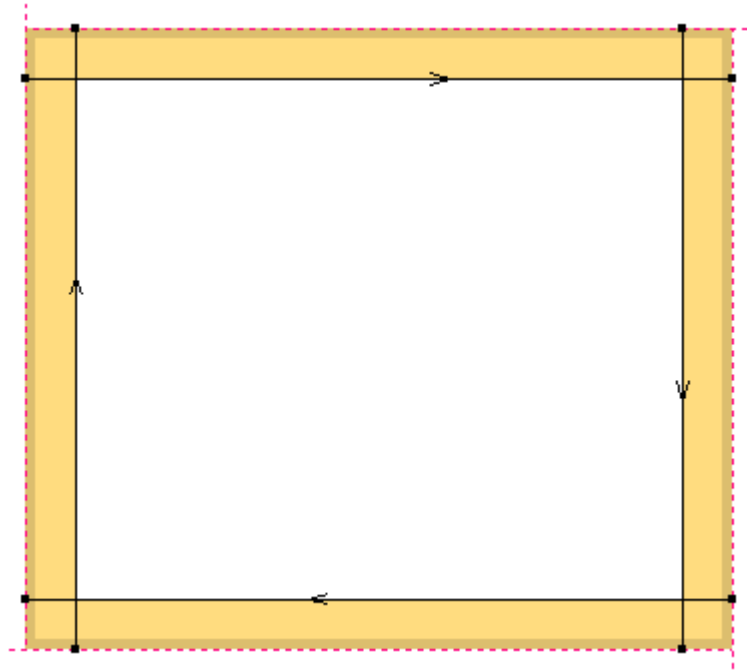

When converted to 3D:



In this example, the black lines are 45-degree V-notch cuts. There is a V-notch crease in the center of the design.

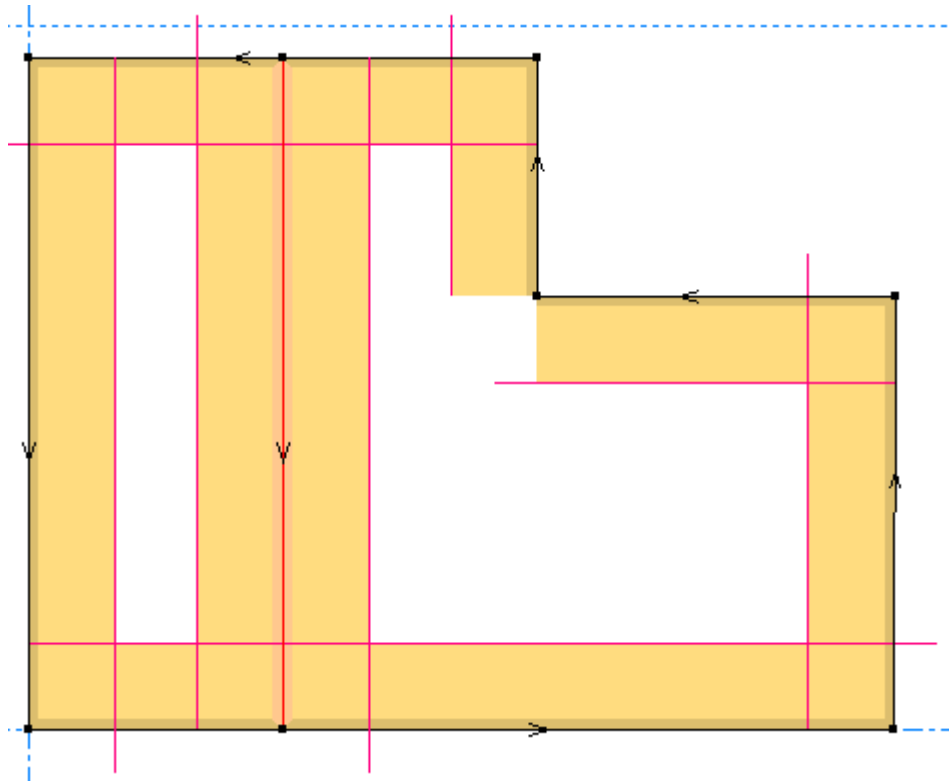

When converted to 3D:



Lastly, in this example, notice the gray shading indicates you cannot see the bevel. Also notice the red lines extend a bit. This is because this is required to actually cut the design.

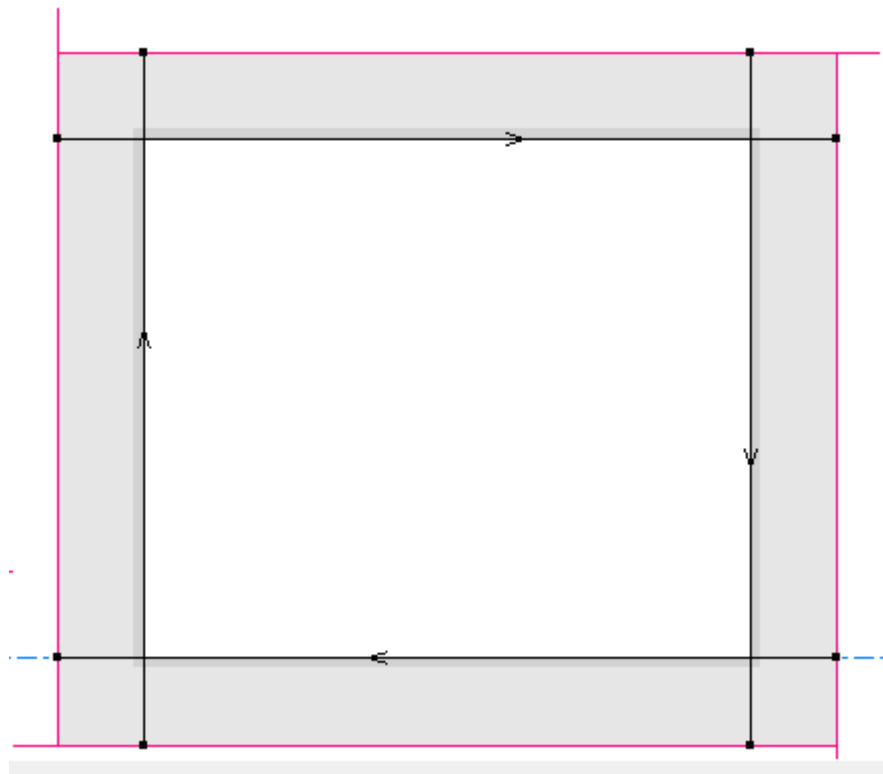

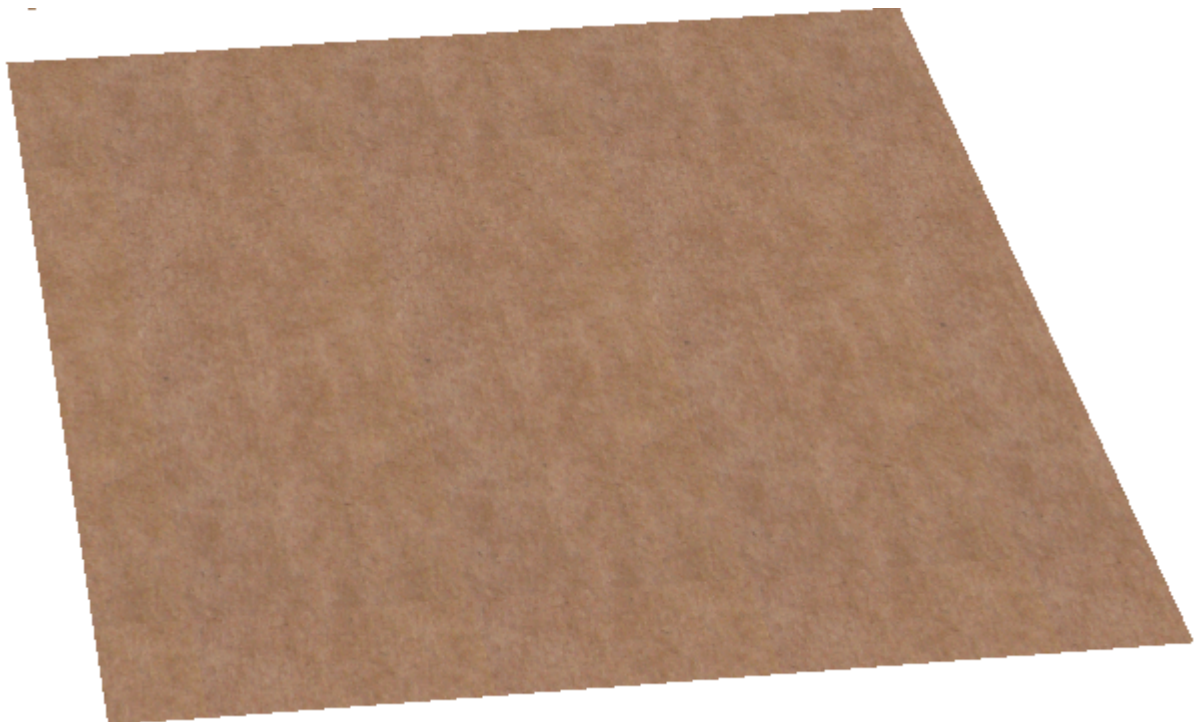

When converted to 3D, you can only see the inside of the design at this view angle. All the bevels are not visible.

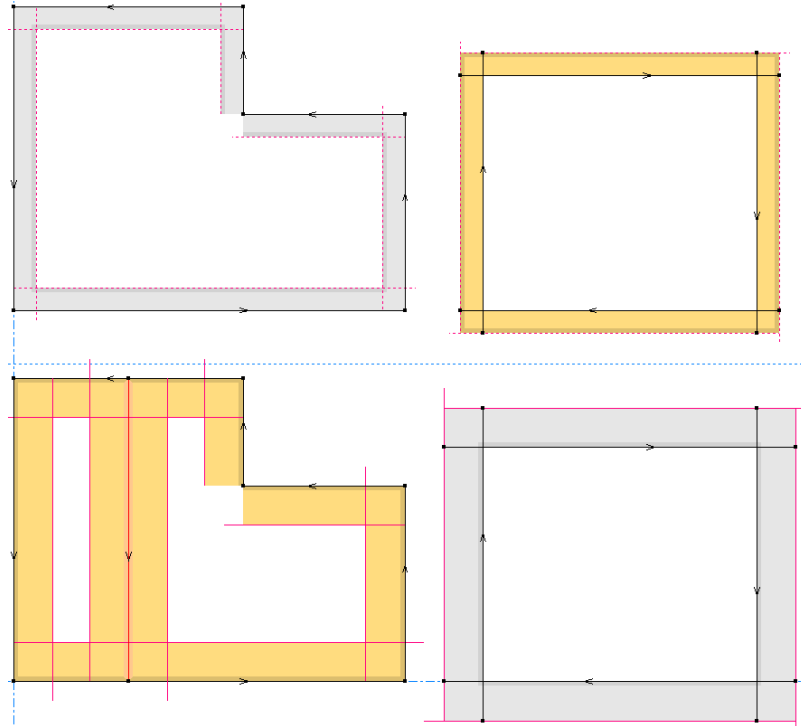

If you flip the design in 2D, areas that were dark yellow change to gray, and areas that were gray change to dark yellow.

 Before flipping using the **Side** toggle on the View bar:



 After flipping:

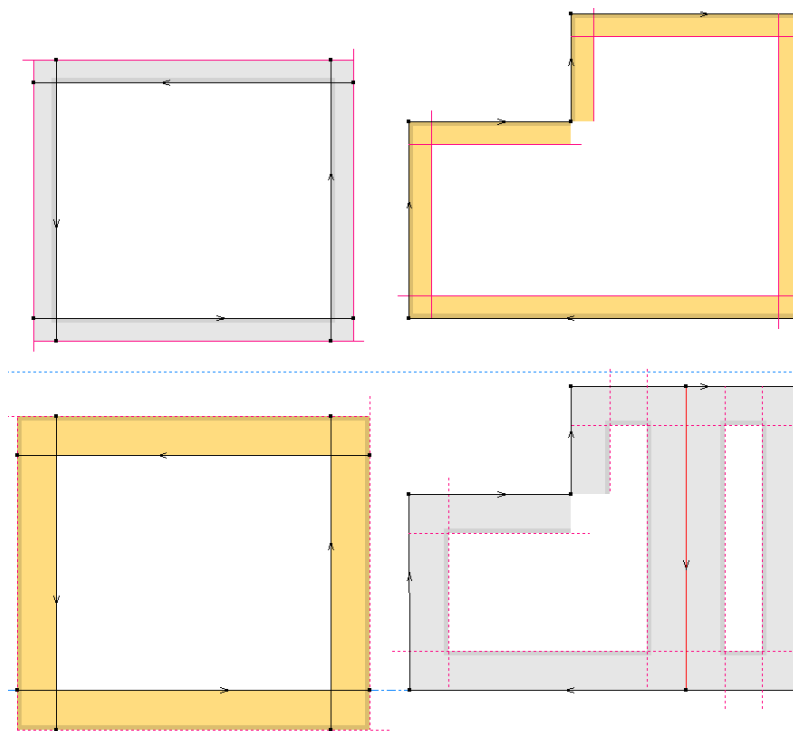

However, if you use the **Die Side** toggle, the position of the workspace remains the same, but the bevels flip direction.



Die Back side:

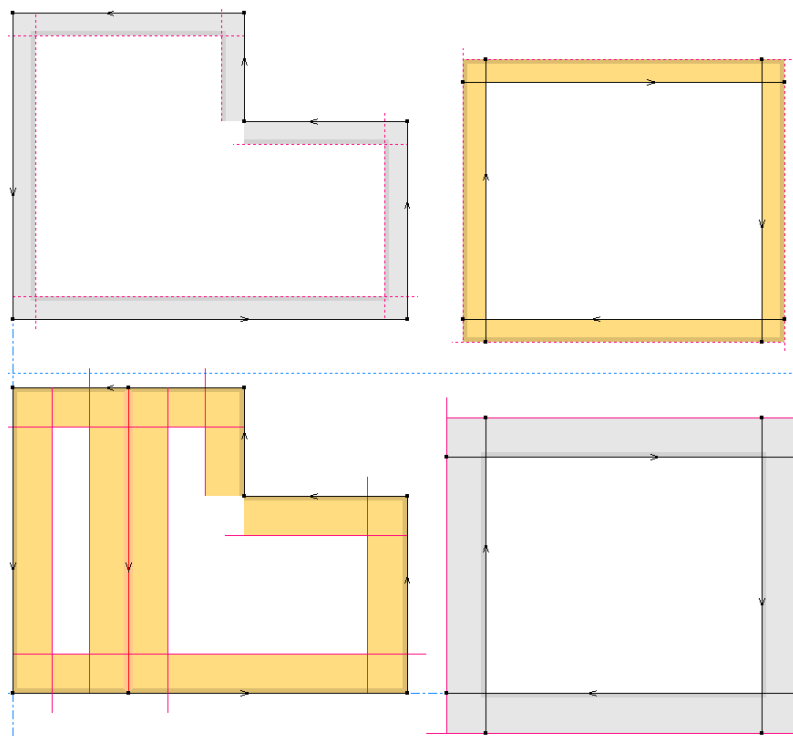



Die Knife side:

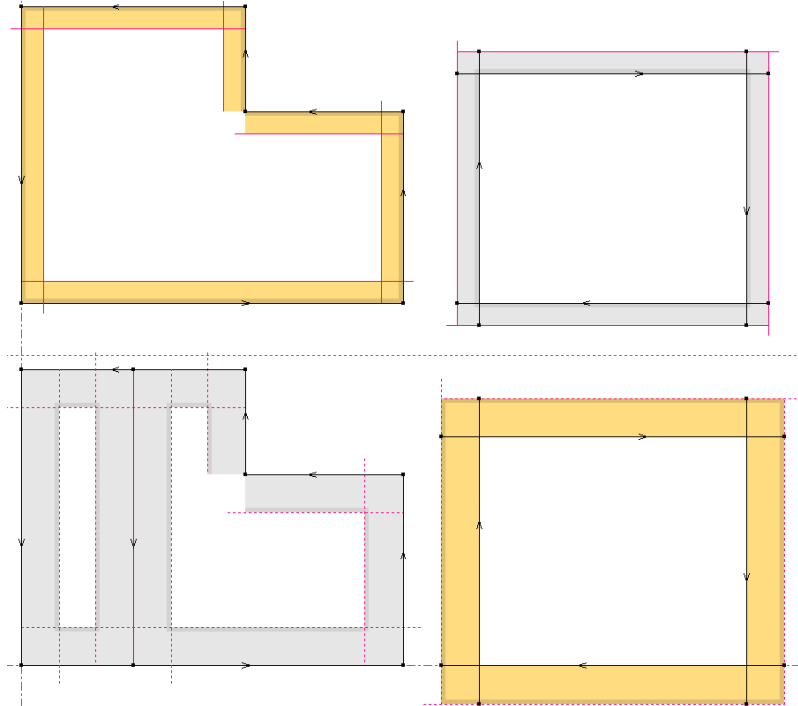

Reverse V-notch cut lines as necessary using **Reverse Direction** before doing a sample Output. When you reverse a V-notch cut, the red line flips from one side to the other. Sample output sequences normal cut lines but does not change the direction of V-notch cuts; ArtiosCAD outputs in the direction you drew them.

Note:

Curved lines are not supported for V-notch lines and Re-board[®] does not bend.

Note:

To make a cut or crease on the reverse side of the board, check **Reverse side** on the Special rule tab of the Properties dialog box for the rule in the workspace or in **Options > Defaults > Special rule types > <Rule type>**.

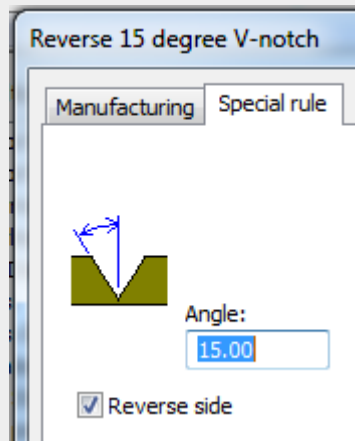

When you enable this option, when **Partial cuts fold outward** is enabled in the board definition,

- Partial cuts fold outward
- V-notches fold inward
- Reverse V-notches fold outward and are cut in a clockwise direction

If you use **Mirror** or **Copy Mirror** on V-notch cuts, ArtiosCAD reverses the line direction so the bevel cuts on the same side as the original lines.

Extending V-notch Cuts

When you are designing corners with V-notch, you need to extend the lines so that the corners actually meet and the design can be separated from the sheet.

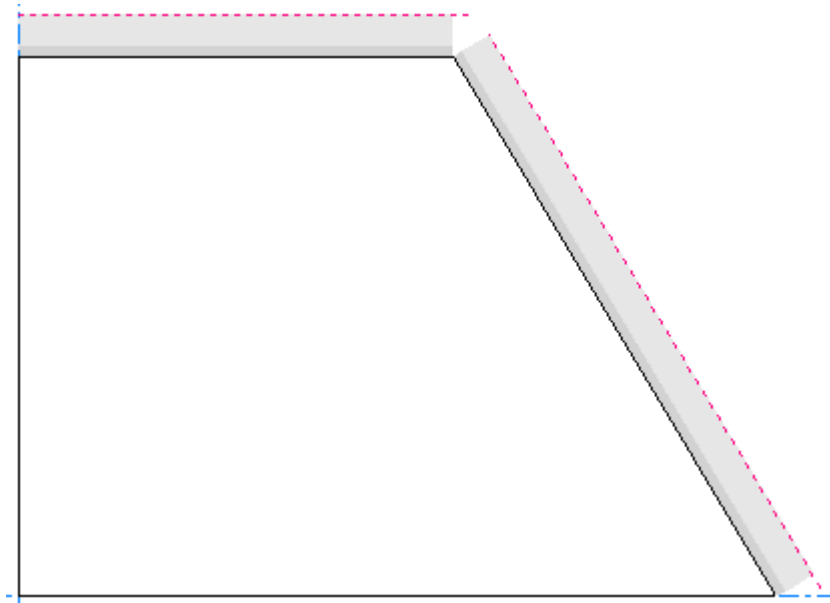

Design Checks will show a gap and that error will often be caught by **Convert to 3D** as well.

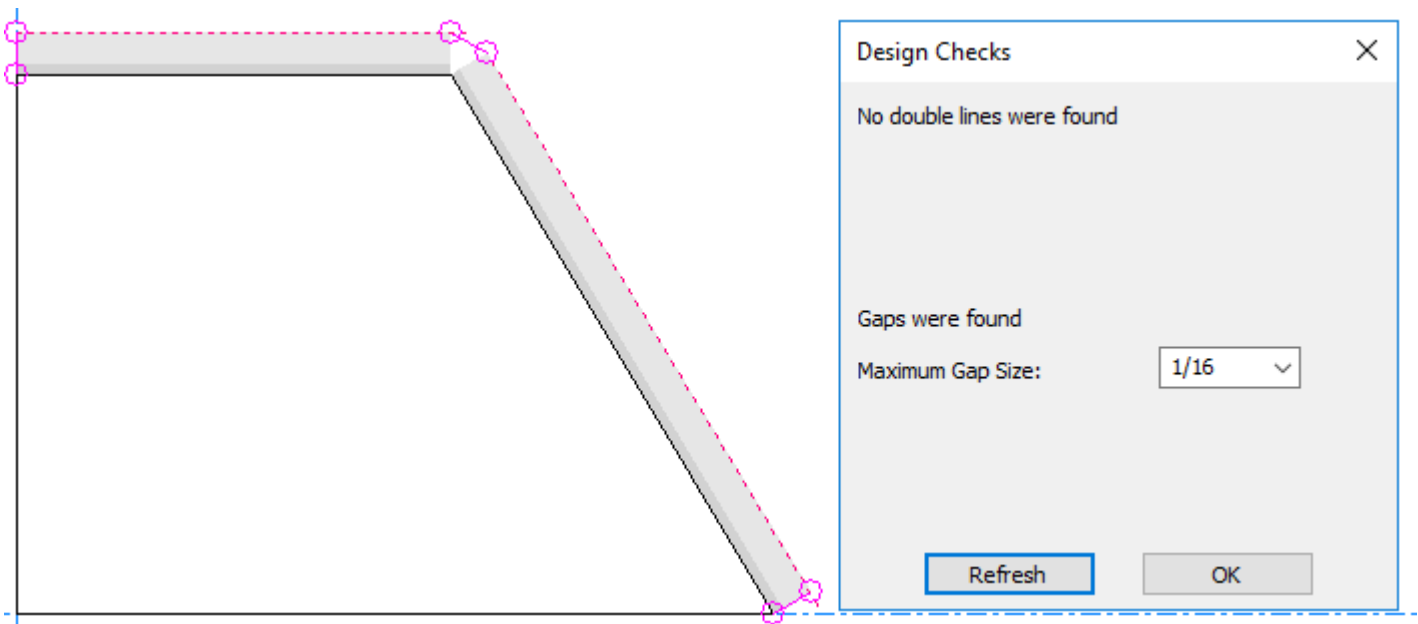

✗ Use **Trim/Extend 1 Line** for this.

Extend one black line to meet the top line of the other V-notch cut.

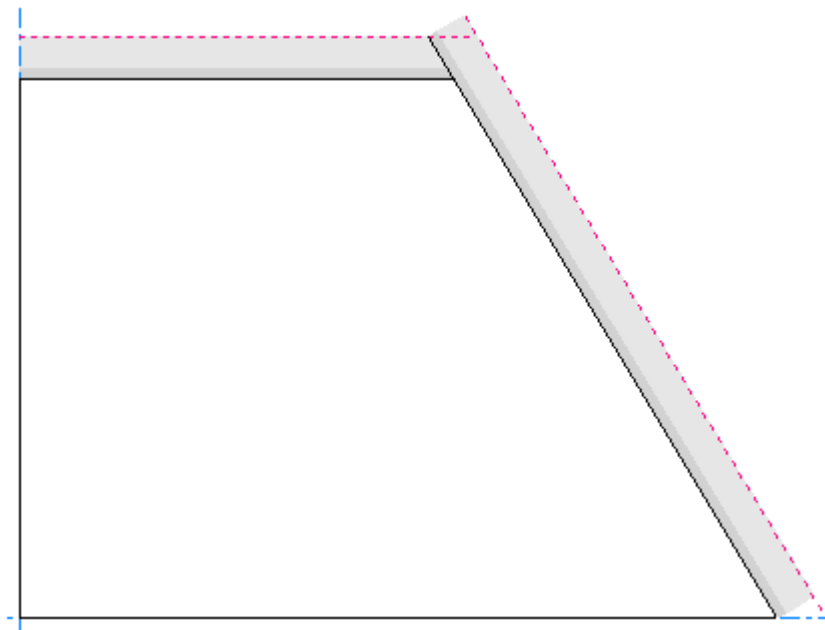

Repeat for the other one.

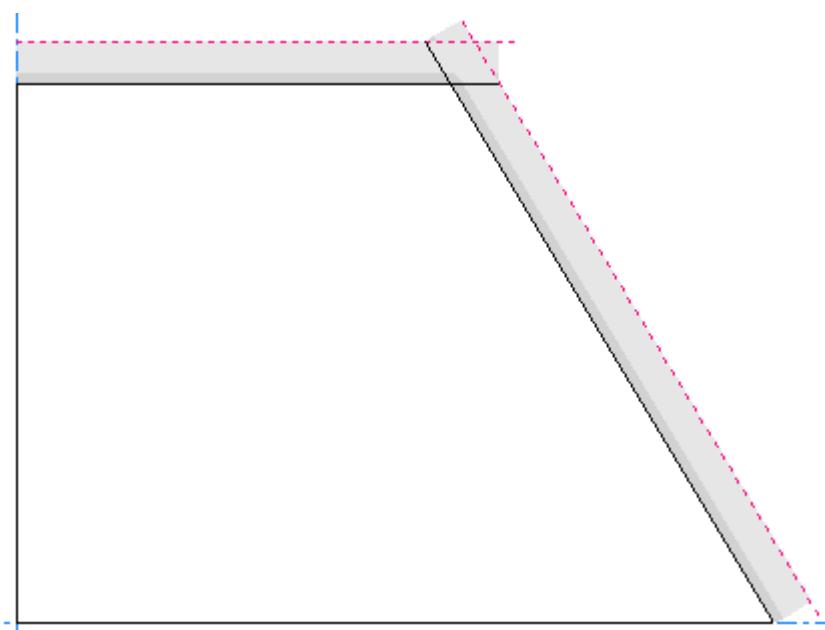

Compression Bends

Compression bends are formed when you fold Re-board[®] back on itself. The paper on the top of the board is torn off, exposing the inside cells. In Designer, ArtiosCAD shows this as a special rule with generic type crease with a bend line offset to either side. The area between the two bend lines is the paper that is torn off.

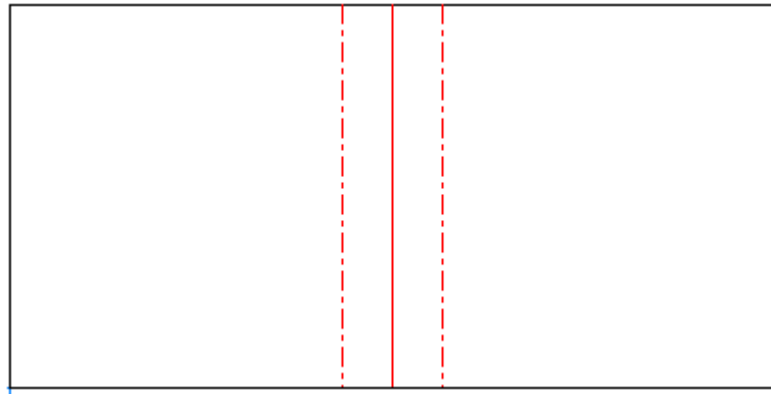

If a compression bend intersects with an angled cut line, create the geometry so that both bend lines meet the cut line.

For sample output, ArtiosCAD puts partial cuts on either side of the crease line. If you use custom plotting styles, make sure to update them with entries for the compression bend special rules.

The design shown above looks like this in 3D:

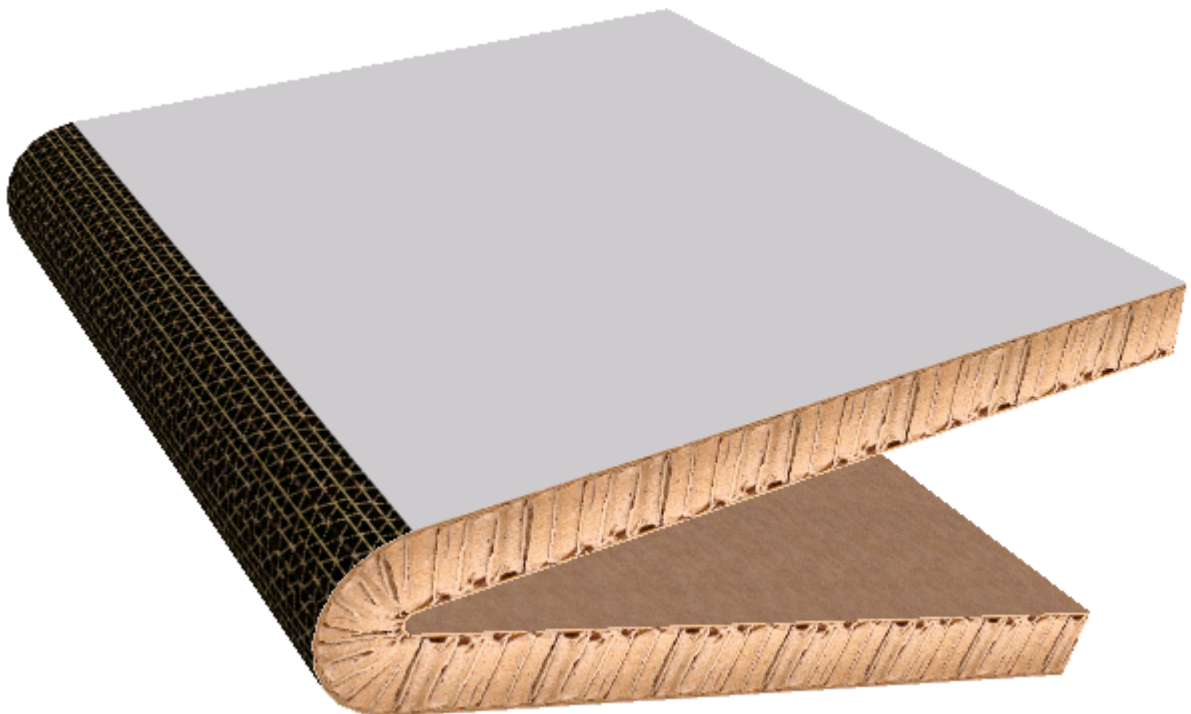

To set the properties of the compression bend, double-click its crease line and click the Special rule tab of the Properties dialog box.

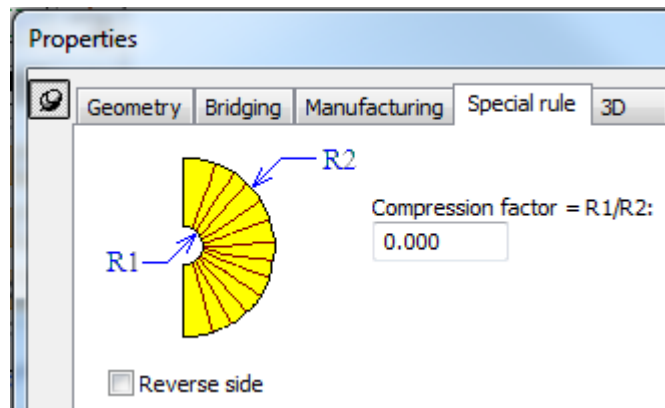

The compression factor and the board caliper define how close the two sides of the bend can get to each other. The compression factor is the inside radius of the bend divided by the outside radius of the bend. With a factor of 0, the two legs of the bend can be parallel. The compression factor must be between 0 and 0.8.

Reverse side makes a reverse compression bend cut from the reverse side.

In 3D, to change the side of the board on which the compression bend appears, double-click the design with **Select Designs** and deselect **Partial cuts fold outward** on the Board Information tab.

At this time, you cannot change the texture ArtiosCAD shows from within ArtiosCAD. If desired, make a backup copy of `..\Common\reboardtorntop.jpg`, and then put your desired image in that file. It should be a 16mm square that repeats a pattern.

Note:

Do not cross compression bends with other compression bends or creases.
Curved compression bends are not supported.

Designing Retail-Ready Containers

More and more, retailers are asking for retail-ready packaging in which part of the shipping container is torn off, the remainder is used as a display for the contents, and the whole thing is put on the shelf ready for customer selection and purchase.

In Single Design, there are special ways to design these features which you can then easily show in 3D. This section explains how to do the underlying design work.

Defining Tear-Away Parts

To define the tear-away parts:

- Use perfs or zippers
- Use cuts with gaps between them
- Use a combination of the above methods

Note: Curved creases can tear or fold but not both.

1. Design the parts of the container that will tear away with perfs and zippers. In the example below, lines labeled 1 are zippers set to tear and fold and lines labeled 2 are perfs set to tear.

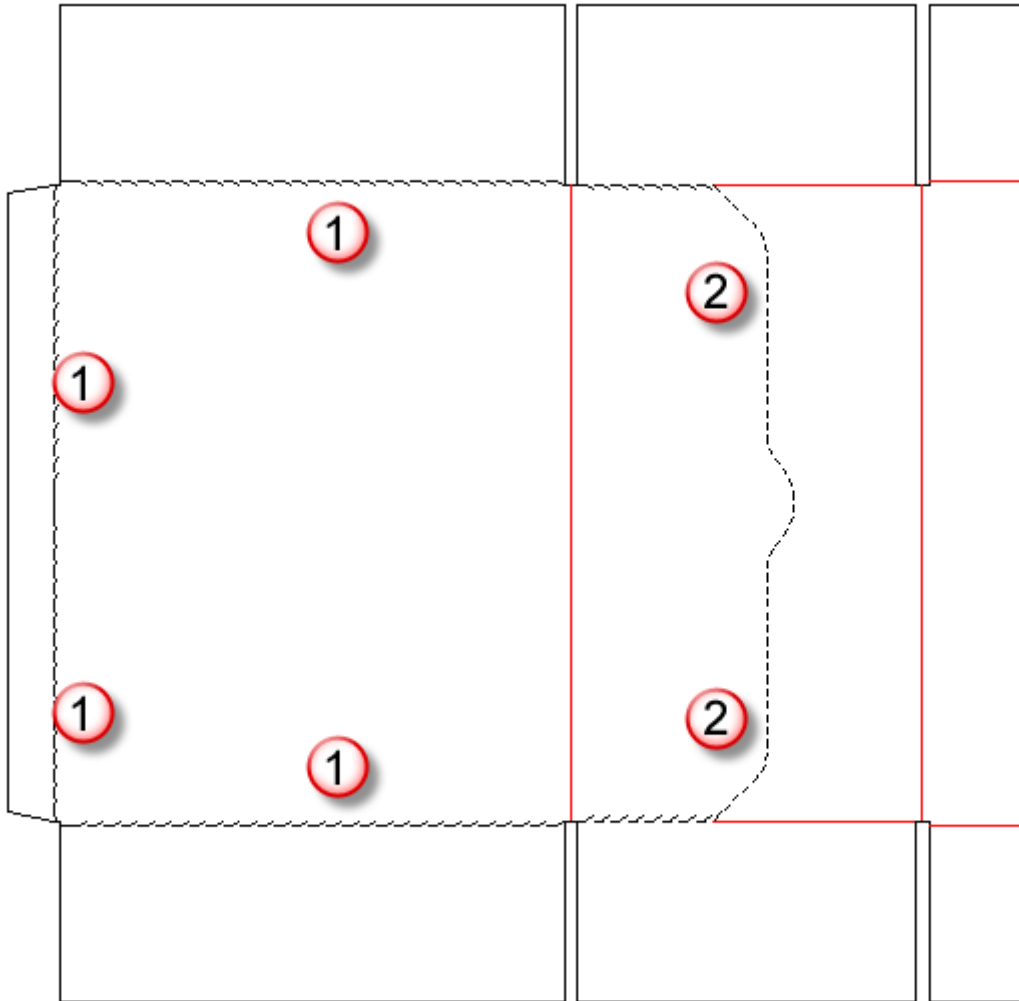

When a special rule has a sequence of lines like the example shown above, use the **Group Sequence** tool to group and align them.

2. Alternately, use a series of cuts and gaps to define a tear-away part, such as the custom zipper shown below.

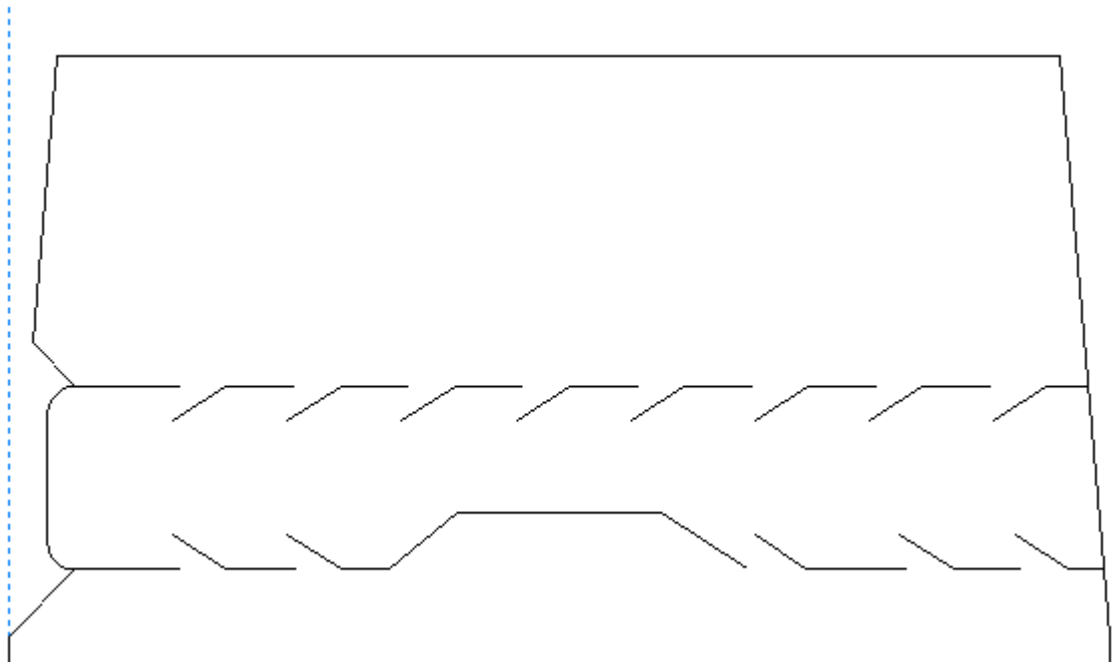

To define the outline of the tear-away part, add tear lines in a 3D Assist layer. The tear lines can either be individual lines that join the cut segments, or they can be two continuous lines over the zipper rules as shown below.

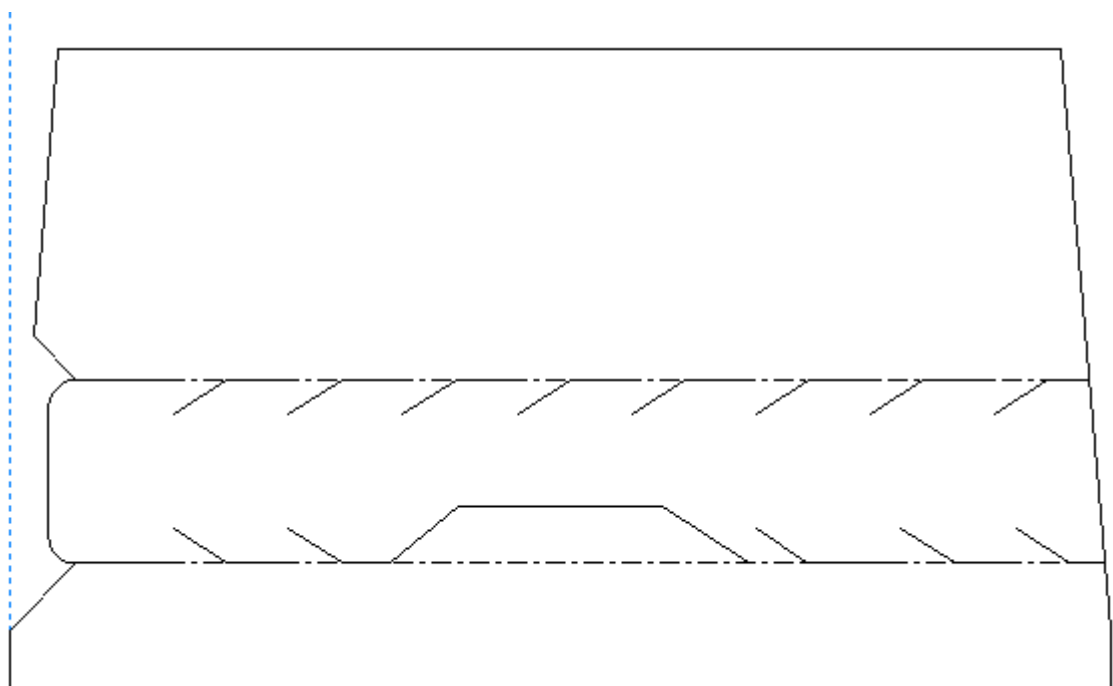

3. As the last design task before you convert the design to 3D, double-click the perfs or zippers with the **Select** tool and set them to either **Tear** or **Tear and fold** on the 3D tab of the Properties dialog box. If you cut and paste any lines with these attributes, you need to reapply them to the pasted copies, as that attribute is not copied.

Intelligent Counters

Counters are special templates made out of phenolic resin (plastic) or steel which are used in folding carton manufacturing. They are part of the die press tooling and are positioned between the folding carton stock and the bottom plate of the press. They aid in the production of creases by providing a place for the material to flex into when struck with creasing rule.

The Intelligent Counters module of ArtiosCAD automatically creates counters with just a few mouse clicks for most designs. Shown below is a typical plastic counter.

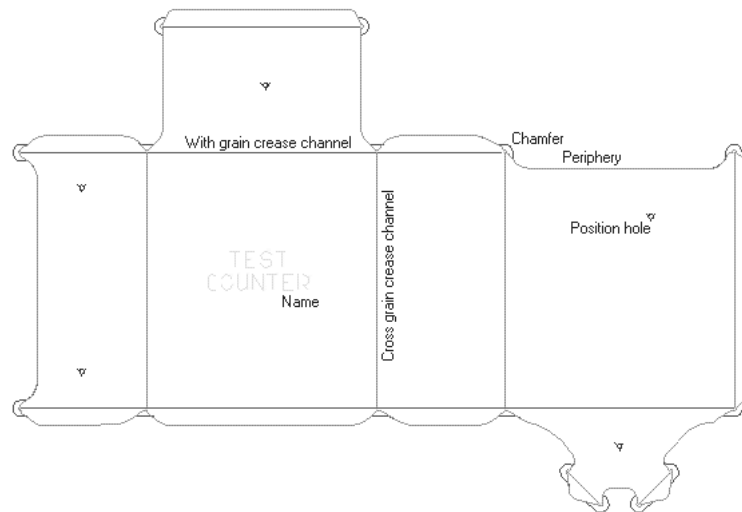

Shown below is a single steel counter with milled channels and an embossed area for a similar design. ArtiosCAD can also make steel counters in manufacturing files.

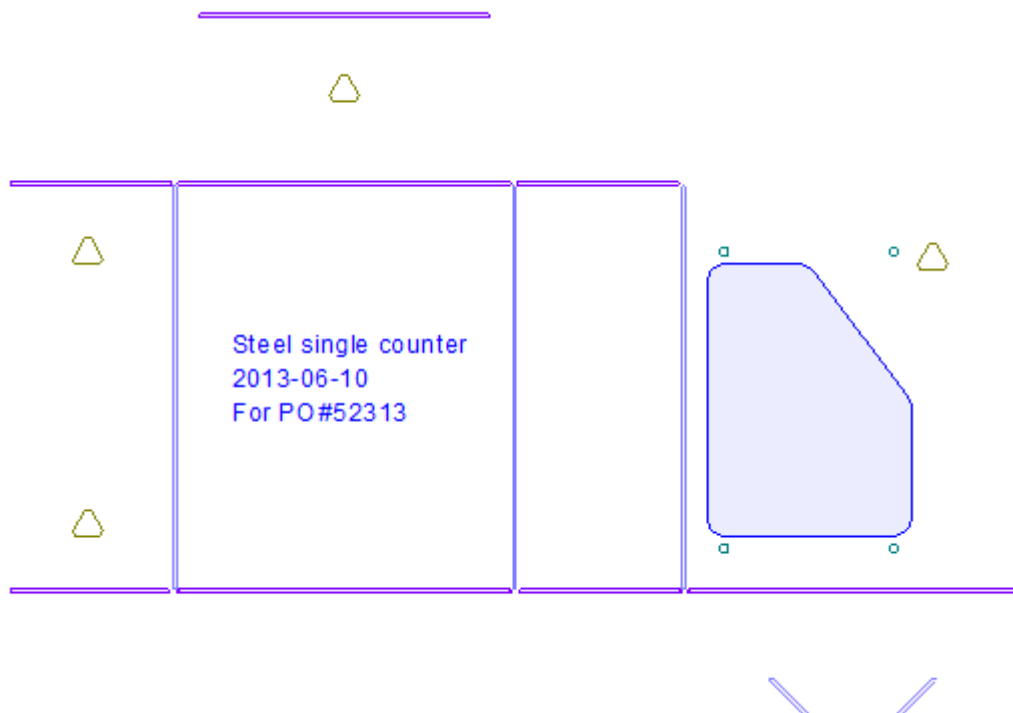

The edge of the plastic counter, the **periphery**, is shaped as it is because it has to go outside the creases but stay inside the cuts. It also needs to go far enough inside the cuts to avoid making marks on the board. Thus, a compromise has to be reached at the places where cuts and creases meet. This compromise is the subject of most of Intelligent Counters' setup parameters.

There are fourteen line types used for making counters:

Table: Counter line types

Line type	Description
With grain channel	Crease channels for with grain creases (those that are parallel to the grain of the board).
Cross grain channel	Crease channels for cross grain creases (those that are perpendicular to the grain of the board). Usually 0.004 inch wider than with grain creases.
Crease end tool	Cuts off the end of the crease channel where it meets a cut.
Periphery tool	Cuts out the counter with a bevelled edge.
Chamfer tool	Trims the edge of the counter with a gentler slope (except near creases) than the periphery tool.

Line type	Description
Reverse chamfer tool	Trims the edge of the counter in the opposite direction as the chamfer tool.
With grain slot	Cuts a slot for a with grain cut-crease.
Cross grain slot	Cuts a slot for a cross grain cut-crease.
Counter slot	Makes holes in a steel counter frame. Must be a complete loop.
Name tool	Etches an identifying label into the counter.
Position holes tool	Cuts the outline of the position hole, usually a circle.
Position holes tool 2	Second position holes tool, if using two tools.
Counter mill outline	Outline of area to be milled, for reverse creases, reverse partial cuts, or for embossing.
Milling tool	Mills out an area with a series of parallel lines.

These line types are mapped to physical tools by the CAM Tooling Setup, and they are offset or multiple-passed as necessary to allow for the tool widths.

Note: When using the milling tool, areas to be milled that are exactly the same width as the milling tool may sometimes be overlooked. In these situations, adjust the size of the area by 0.05 mm to allow the area to be milled.

Configuring Intelligent Counters

Intelligent Counters uses parameter sets to organize its parameters into easily-selectable groups. You must choose a parameter set when creating a counter. Several default parameter sets are installed with ArtiosCAD; some for plastic counters and some for steel counters. See the *Defaults* chapter for more information.

Intelligent Counters workflow for plastic counters

The general steps in making a plastic counter are as follows:

1. Construct your design making sure the perimeter of the design has no gaps and is composed entirely of cut lines.
2. Click the **Create or Rebuild Counter** tool on the Counter toolbar. Choose a counter parameter set and make appropriate selections in the prompts and options on the tabs.
3. Click **OK** to create the counter.
4. Add a name, tack bridges, and straps as appropriate.
5. Modify counter lines if needed.

6. Save the design and output it to the countercutter.

Creating and modifying a plastic counter

The tools on the Counter toolbar create and modify counters. Turn on the Counter toolbar by checking its box in the **View > Toolbars** dialog box. Alternately, you may turn it on via its button on the ToolRack, and you may select the tools directly from the **Tools > Counter** menu.



The first tool on the Counters toolbar is **Create or Rebuild Counter**. When clicked for the first time, this tool prompts you to select a counter parameter set. Select the set to use and click **OK**.



If your current layer is not a counter layer, you are prompted to create one. Click either option as desired and then click **OK**.

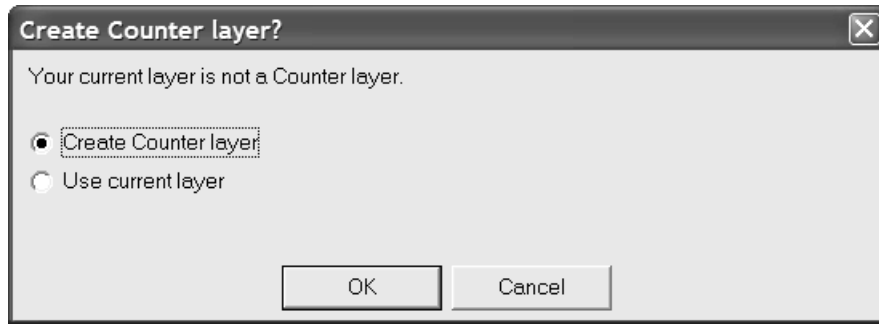

Creating a counter disables the rebuildability of a design. You can either save the design before proceeding, disable rebuild and go on without saving, or exit the counter creation process. Select the desired option and click **OK**.

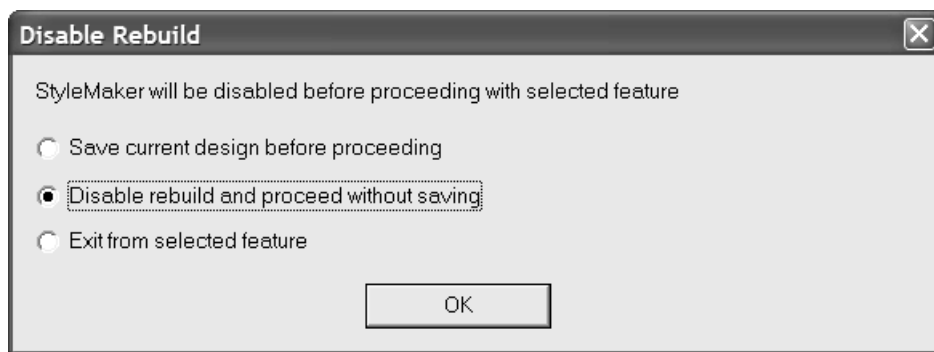

Once you have chosen a parameter set, this tool opens the Create or Rebuild Counter dialog box which is the heart of Intelligent Counters.

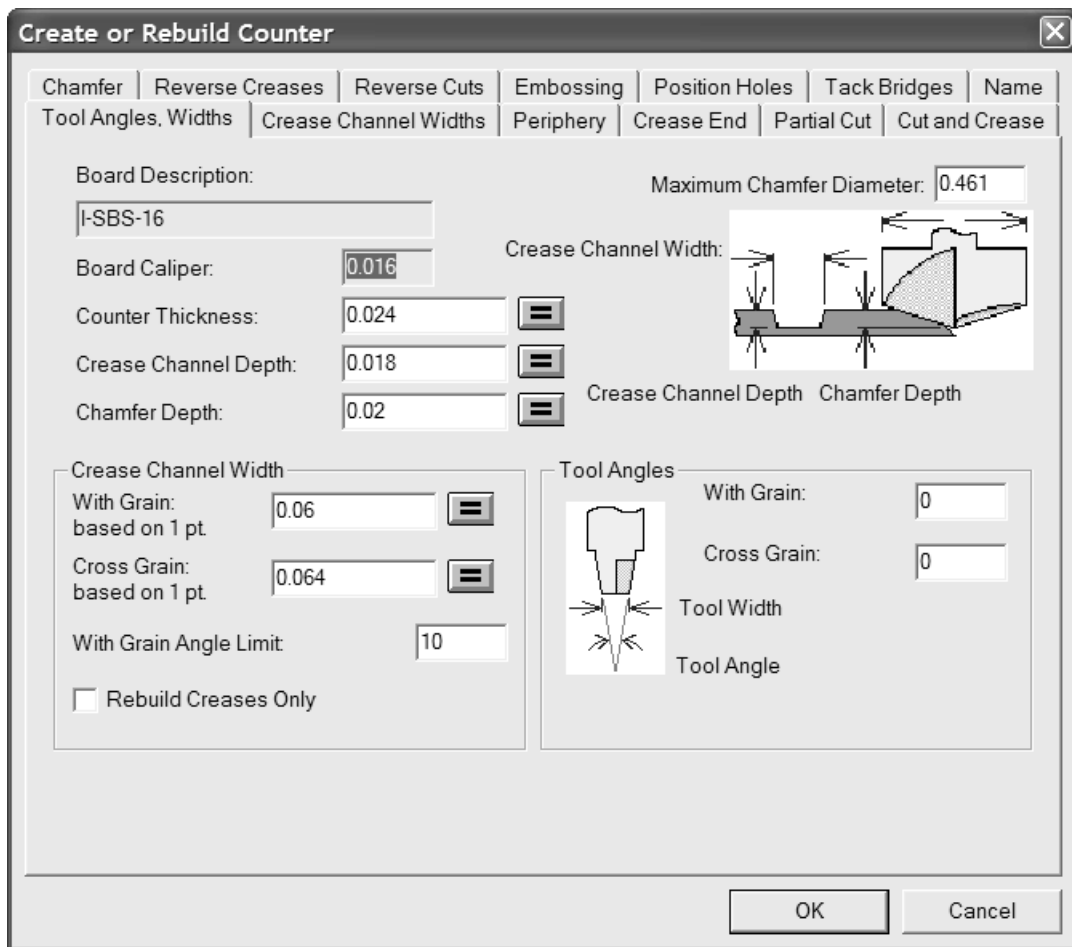

Clicking the equal-sign button at the end of a field recalculates the value in that field according to the formula in the counter parameter set. You can change the value itself in the field, but to change the expression used to calculate the value, you must modify the parameter set in Defaults.

The **Rebuild Creases Only** checkbox appears only when rebuilding a counter, and when clicked, causes this tool to only recalculate the crease channels.

Crease channel widths tab

The **Crease Channel Widths** tab of the Create or Rebuild Counter dialog box lets you specify different crease channel widths for with-grain creases and cross-grain creases after you have assigned them different subtypes in the Counter layer. You may define the subtypes and channel widths before creating or rebuilding the counter; the channel widths are set appropriately on Output.

Crease Channel Width		
With Grain:	0.06	=
Cross Grain:	0.064	=
Additional crease channel widths		
Subtype:	With Grain:	Cross Grain:
2	0.072	0.076
10	0.074	0.078
15	0.076	0.080

In the **Crease Channel Width** group, **With Grain:** and **Cross Grain:** are the initial values for crease channel widths of creases with no subtype assigned, or with a subtype defined that is not defined in the table of additional widths. These are initially set by the parameter set, and are repeated from the **Crease Channel Width** group on the Tool Angles, Widths tab. The equal-sign buttons at the end of each field reset the field to the value calculated by the formula for that field in the counter parameter set.

In the **Additional crease channel widths** group, you can define up to nine subtypes with different widths for with grain creases and cross grain creases in the appropriate fields.

You may also set the crease channel widths without rebuilding the counter by clicking **Tools > Counter > Crease Channel Width**.

Note: Rebuilding the counter removes any subtype assignments previously made. You must reassign the crease subtypes to lines in the Counter layer after rebuilding the counter. The subtype definitions are not cached; you will have to re-enter all the information.

If there are creases of the same subtype but different pointages, the channel widths from the table are used for the crease with the minimum pointage of that subtype, and creases with higher pointages get larger channel widths offset by the difference in pointage.

For any crease with a subtype defined in the **Additional crease channel widths** group, each subtype defines a specific channel width regardless of crease pointage. A 5-point with grain crease, for example, will have the same channel width as a 2-point with grain crease if both with grain creases have the same subtype applied.

Shown below is an example of wider channel widths in an Output made to a workspace layer. The top horizontal crease and the bottom right vertical crease are both wider than the default.

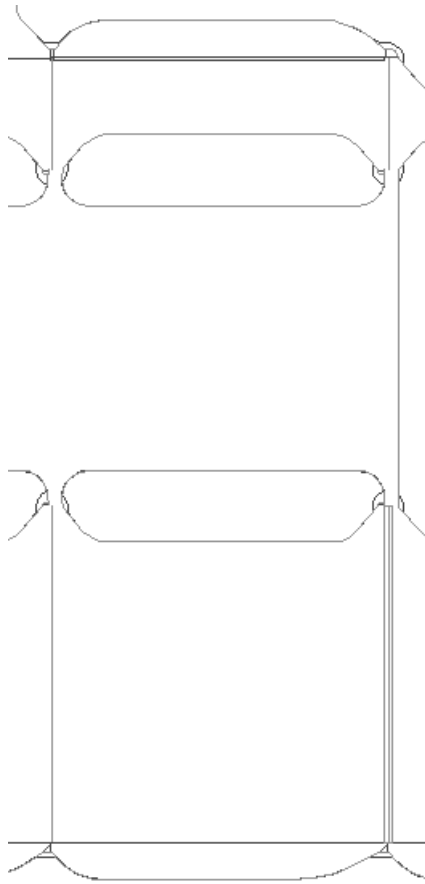

Note: The channel width adjustment using subtypes is meant to be small. The periphery tool path is **not** adjusted to compensate for the different channel widths.

Periphery tab

The **Periphery** tab of the Create or Rebuild Counter dialog box contains settings which affect the periphery tool.

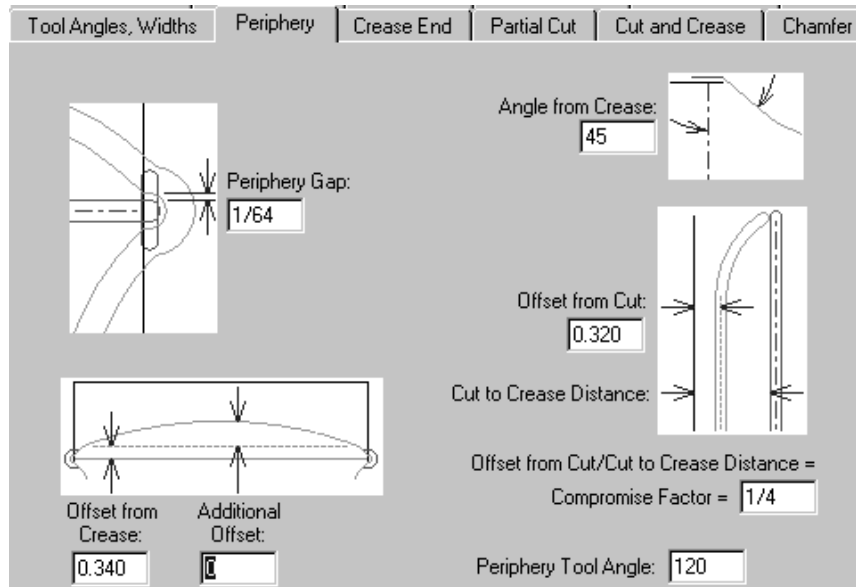

The parameters on this page of the dialog box are all measurements whose functions are illustrated in the pictures next to them except for the Periphery Tool Angle. The angle specified in the **Periphery Tool Angle** field, along with the thickness of the counter material, determines the width of the periphery.

Crease End tab

The **Crease End** tab of the counter parameter set dialog box controls how the crease ends are machined.

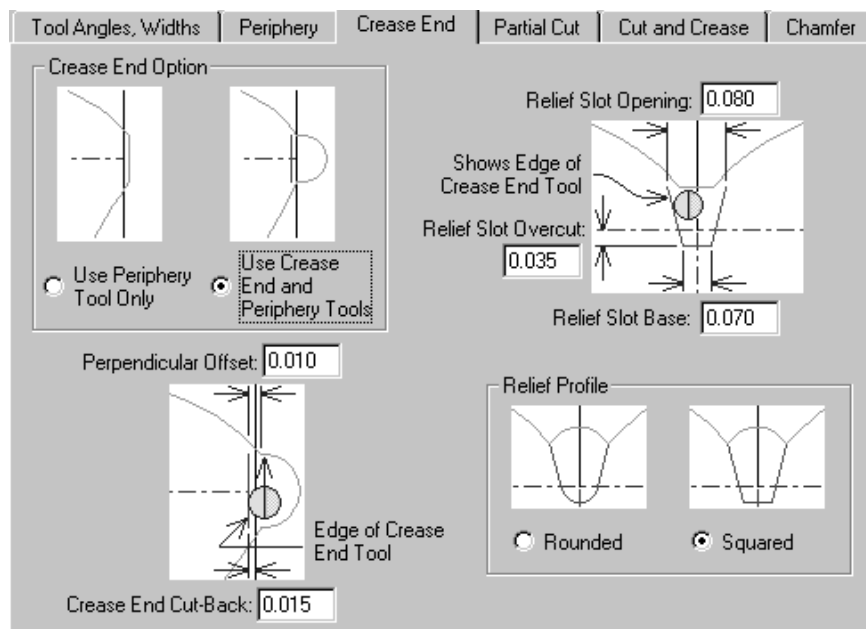

The options in the **Crease End Option** group, **Use Periphery Tool Only** and **Use Crease End and Periphery Tools** affect the display of the rest of the tab. If **Use Periphery Tool Only** is selected, all the pictures change to omit any reference to the Crease End tool.

Partial cut tab

Partial cuts and glue assist lines can have the counter extend underneath them if you so desire.

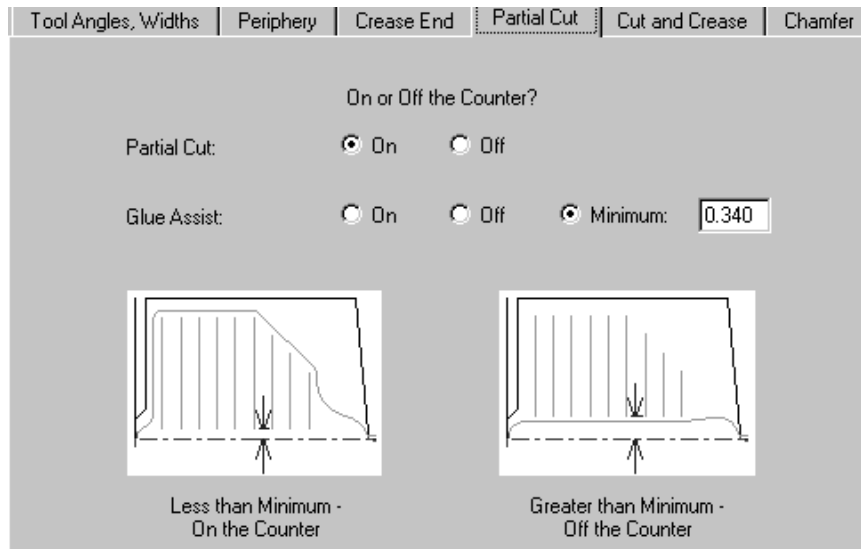

By default, Partial Cuts are set to be **On** the counter. Glue assist lines are set conditionally by default. They are off the counter if the distance between the crease and the closer end of the line is greater than the minimum specified in the **Minimum** field. Of course you can specify them to be **On** or **Off** for this counter.

Cut and Crease tab

The options on the **Cut and Crease** tab affect the creation of bowties, which are special constructs made necessary by having cuts and creases of such short length. All of the options are explained in the pictures.

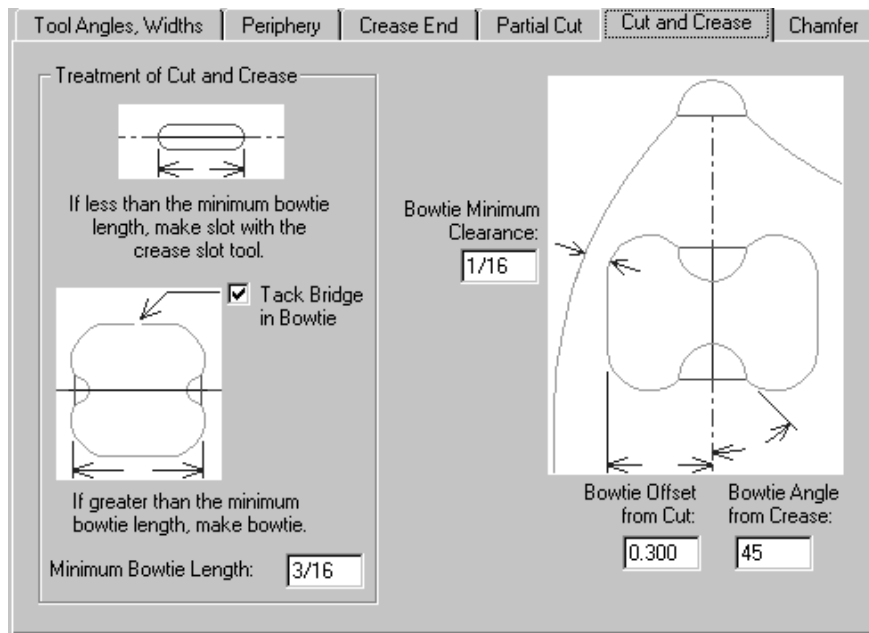

Chamfer tab

The options on the **Chamfer** tab affect the counter at those places in the design where cut lines and the ends of crease lines meet. The chamfer mostly follows the periphery except it always stays a specified distance away from crease channels.

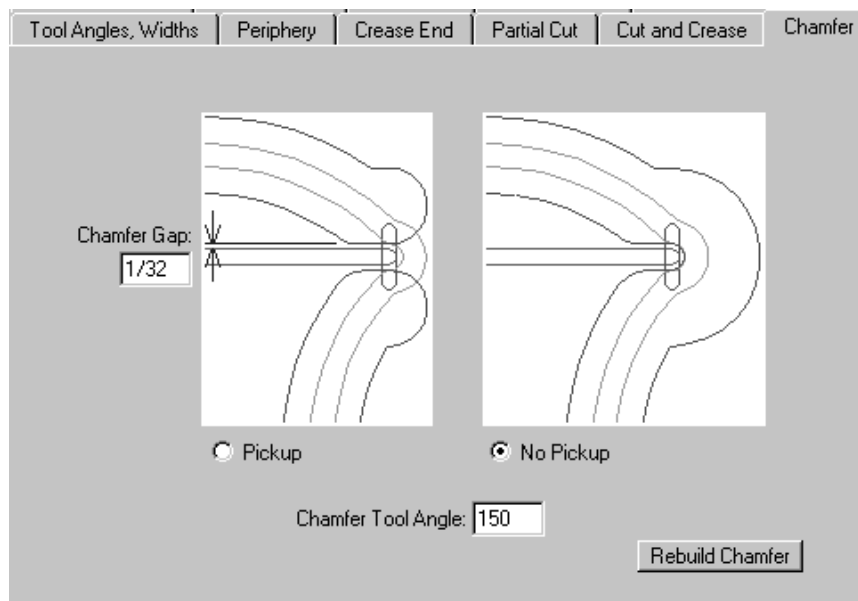

The **Chamfer Gap** is the distance between the inside edge of a chamfer and the crease channel. The **Pickup** and **No Pickup** options control whether the chamfer is continuous around the end of the crease channel. The **Chamfer Tool Angle** is the angle of the tool, which, together with the thickness of the counter material, determines the width of the chamfer channel.

The **Rebuild Chamfer** button does what it says.

Reverse Creases tab

Reverse creases are used to make a panel fold outward instead of inward.

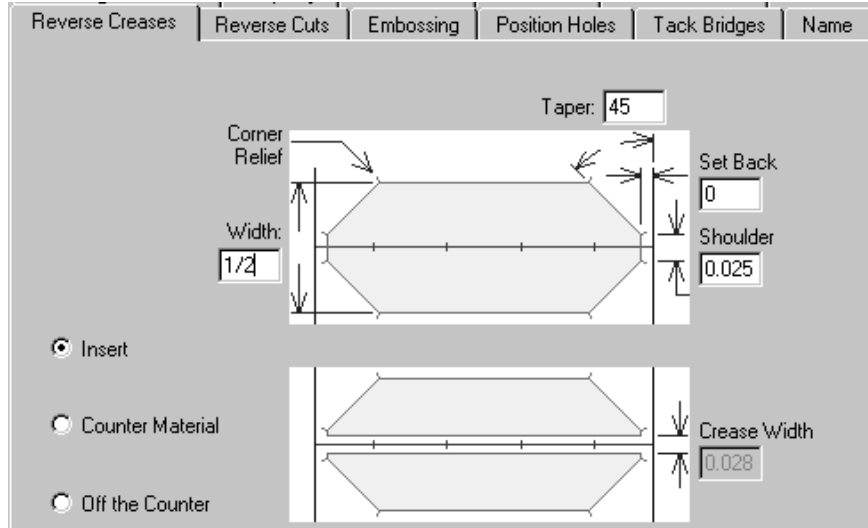

The **Insert** option indicates that a piece of foreign material will be attached to the counter to create the reverse crease. This is shown in the top picture on the tab. **Counter material** means that an area around the reverse crease will be milled out so that the board gets pushed into the depressed area. This is shown in the bottom picture on the tab. The **Crease Width** field becomes available when this option is selected. **Off the counter** disables all the fields.

Reverse Cuts tab

Reverse cuts are made on the counter in the same way as the Insert method for reverse creases. The parameters on the **Reverse Cuts** tab are explained in the picture.

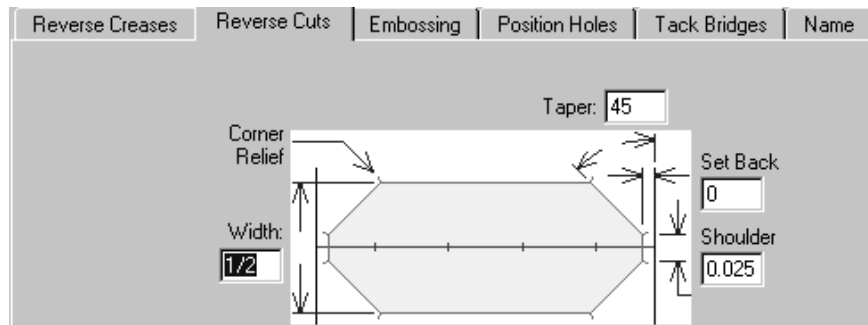

Embossing tab

An area of the board can be embossed by milling out the part of the counter surrounding the embossed area. An area is milled out in the counter half-crease channel width inside the half-crease lines, forming one side of a crease, thus making a raised emboss area. A relief is milled out on the outside of the half-crease lines to avoid making the other half of the crease channel. As with other tabs, the parameters on the **Embossing** tab are explained in the picture.

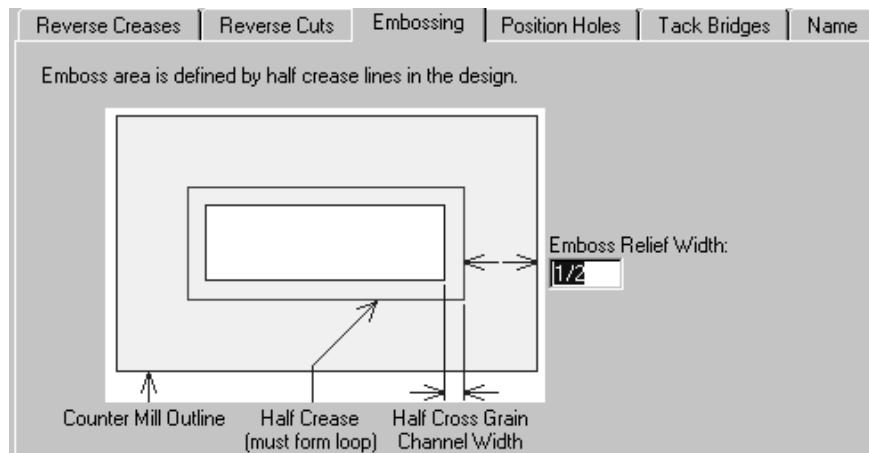

Position Holes tab

The **Position Holes** tab contains one parameter - the workspace name for the position hole. Click **Specify** to browse for a new workspace. In order to use the **Allow for tool diameter option** on the Counter Tool Widths tab in Outputs, you must make the outline of the hole in this workspace using the positioning hole tool line type. You should put any workspace you create in ServerLib.

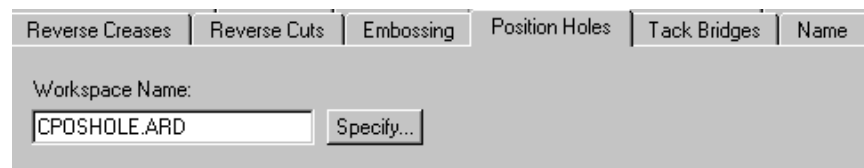

Tack Bridges tab

The **Tack Bridge Width** field on the **Tack Bridges** tab sets the width of tack bridges in the periphery of the counter for the next time the tack bridge tool is used, and it also sets the width of the tack bridges created automatically for bowties.

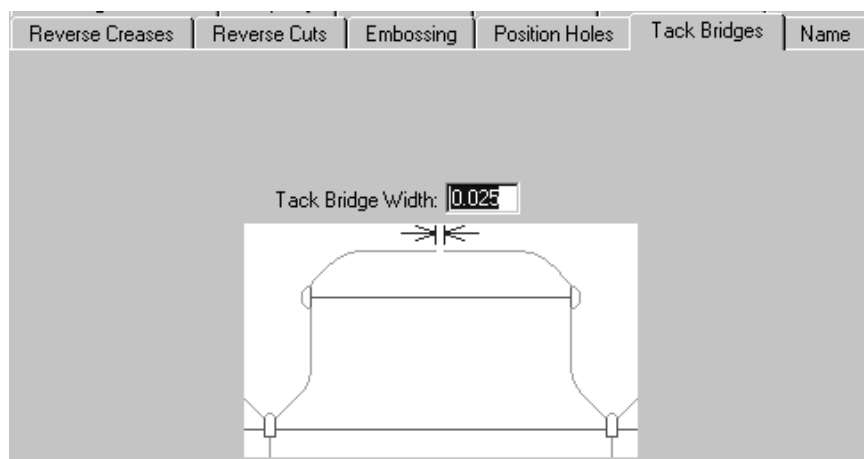

Name tab

The choices on the **Name** tab affect the output of the Name tool on the Counter toolbar. These choices include the font to use, its size, and its position, as shown in the picture.

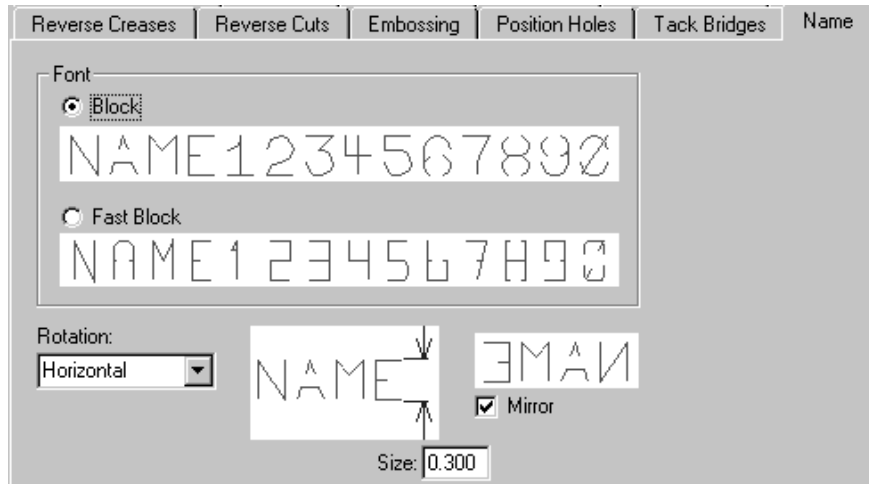

Once you have finished reviewing the options on the tabs, click **OK** to make or remake the counter and dismiss the Create or Rebuild Counter dialog box. Click **Cancel** to cancel the creation or modification of the counter. Click **Apply** to apply the changes you made to the options on the tabs while keeping the dialog box open.



The second button on the Counter toolbar activates the **Rebuild Chamfer** tool. Clicking this tool rebuilds the chamfer in the current counter layer. If you have made any manual changes to the chamfer, they will be lost. This tool also resequences the periphery lines into loops; if you have made any changes to the order, the changes will be lost.



The third tool on the Counter toolbar activates the **Add Counter Name** tool. This tool uses the options on the Name tab of the Create or Rebuild Counter dialog box to place the name of the workspace on the counter. Fields appear in the Status bar containing the attributes of the name.

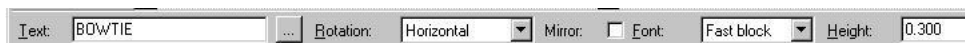

The only thing different about the fields on the Status bar compared with those on the **Name** tab is the ... button after the **Text** field. This button leads to the Burn Name dialog box, and by clicking it, you can enter a counter name spanning multiple lines of text.

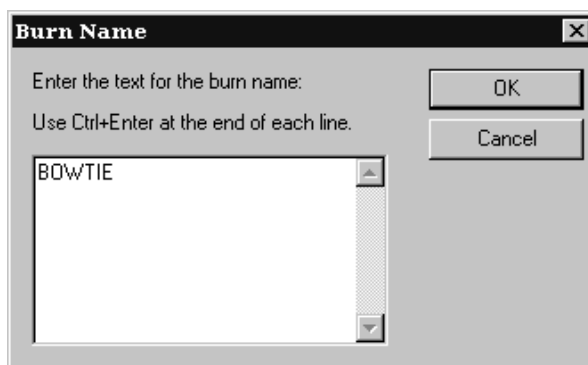

Enter the text for the first line, press CTRL-Enter, enter the second line of text, and so forth, and then click **OK**. A ghost drag image of the text will appear under the cursor. Position it and click to place it on the counter. This tool remains active after placing the name; click another tool to deactivate it.

 The **Add Counter Tack Bridge** tool is the fourth tool on the Counter toolbar and does just what it says. Click this tool, then indicate the position in the periphery where a tack bridge is to be placed. A tack bridge will be placed at the point you indicate with the width shown in the **Tack Bridge Width** field on the Status bar.

 The fifth tool on the Counter toolbar is the **Delete Counter Tack Bridge** tool and it, too, does just what it says. Click this tool and then click the tack bridge(s) to be deleted.

 The sixth tool on the Counter toolbar is the **Add Counter Strap** tool. **Straps** are thin pieces of counter material that hold delicate counters together. Straps are made using the periphery tool and are milled where they cross cut lines.

You should use this tool after designing the rest of the counter. To use this tool, do the following:

1. Make sure your counter is complete except for the straps.
2.  Click the **Add Counter Strap** tool on the Counter toolbar.
3. Click the point in the periphery where you want the first side of the strap to start.
4. Click the ending point of the first side of the strap in the periphery.
5. Click the start point in the periphery for the second side of the strap.
6. Click the ending point in the periphery for the second side of the strap.

You should have a construction that looks similar to the one shown below.

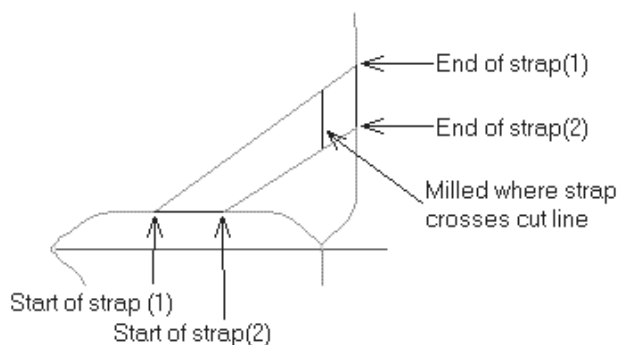

 The seventh tool on the Counter toolbar is the **Select Periphery Lines** tool. As periphery lines are often close to other lines, selecting them alone can be imprecise using a normal Select tool. Use this tool to select only lines made with the periphery tool. This tool has the same selection options on the Status bar as the Select tool in Designer. Once the periphery lines are selected, you can then move them, delete them, change them, and so forth.

Viewing the counter

To view the actual paths made by the counter tools, check the **Counter channel widths** checkbox in the View Mode dialog box. Shown below is a counter with the **Counter channel widths** option off and then on.

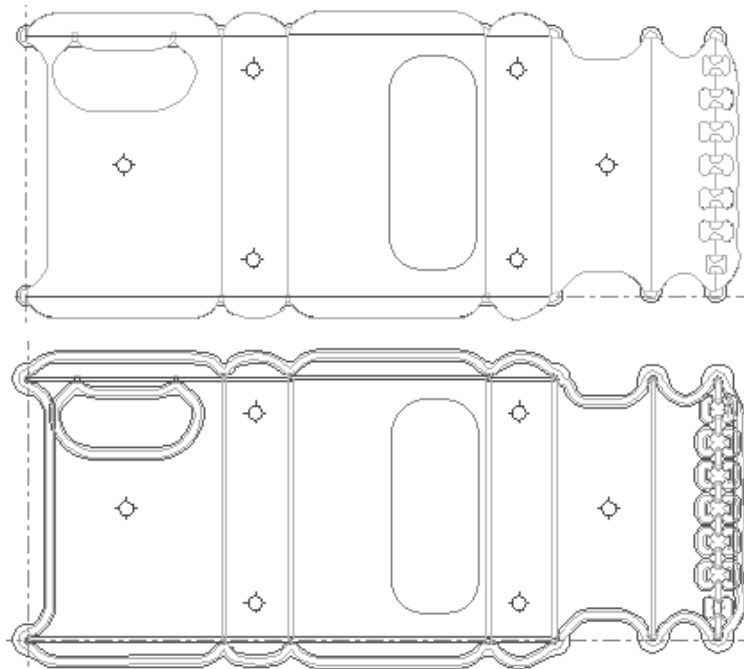

Note: Milled areas are not shown filled in with mill tool lines when the **Counter channel widths** checkbox is selected. They are only shown in the Preview dialog box of the Output.

Counter Position Holes

Counter position holes are made by inserting Laser Positioning Holes into the single design before creating a counter. Add Laser Position Holes via **Tools > Geometry Macros > Utilities > Laser Position Holes**.

Construct the Laser Positioning Holes design file with the origin at the center of the hole using symmetrical geometry and consecutive lines. Use only the **Positioning Hole Tool** line type and the **Positioning Hole Tool 2** line type in the Laser Positioning Holes design file.

Switching counter parameter sets

To switch to a different counter parameter set after choosing one initially, click **Change Counter Parameter Set** on the **Options** menu. You should rebuild the counter after changing the parameter set.



Outputting imported INTERACT and LASERPOINT IQ counters

INTERACT counters use different line types than those used in ArtiosCAD. You must change all the counter lines to ArtiosCAD line types by hand.

When outputting imported LASERPOINT IQ counters, use a **Plot** output type instead of a **Counter** output type when configuring the Output.

Intelligent Counters workflow for steel counters

Making steel counters uses a different workflow from plastic counters. Most people will make a single sheet of steel counters in Manufacturing instead of making individual counters for each station of a single design. You can create the counter inside the single design(s) and then create the frame in Manufacturing, or if the counter is simple enough and you do not need to do any manual changes to it, ArtiosCAD can create the counter layers in the embedded designs in Manufacturing along with the frame.

1. Make your manufacturing file out of single designs and nest them as desired.
2.  Add a dieboard edge using **Create Wood Edge**.
3.  Click **Create or Rebuild Counter**.
4. In the Rebuild Counter dialog box, **Rebuild frame** and **Oneup(s) counter layer** are checked by default if this is the first time you are creating the counter. Set these as desired and click **OK**.

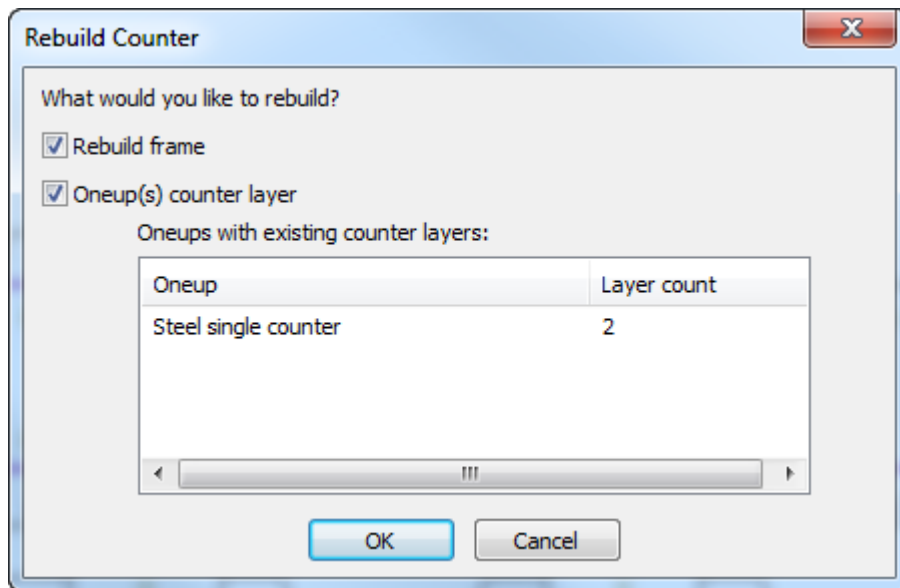

5. Select a parameter set and click **OK**.

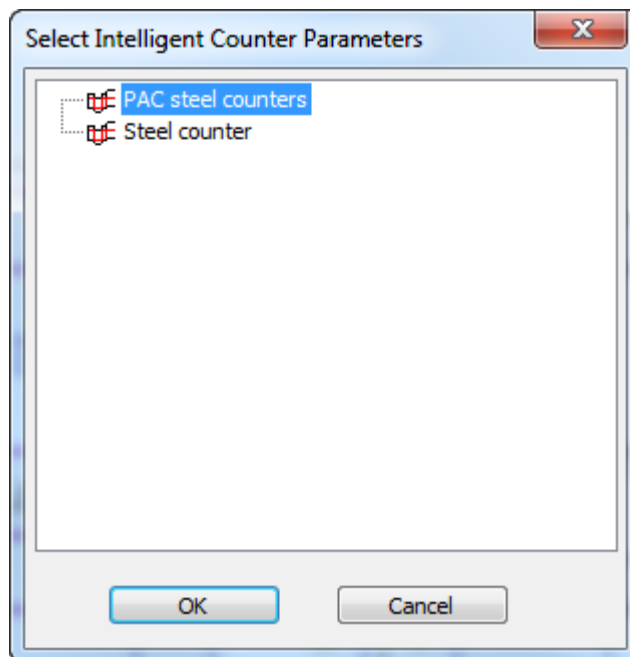

6. Click each tab of the parameter set in the Create or Rebuild Counter dialog box, adjusting entries as desired, and click **OK**.

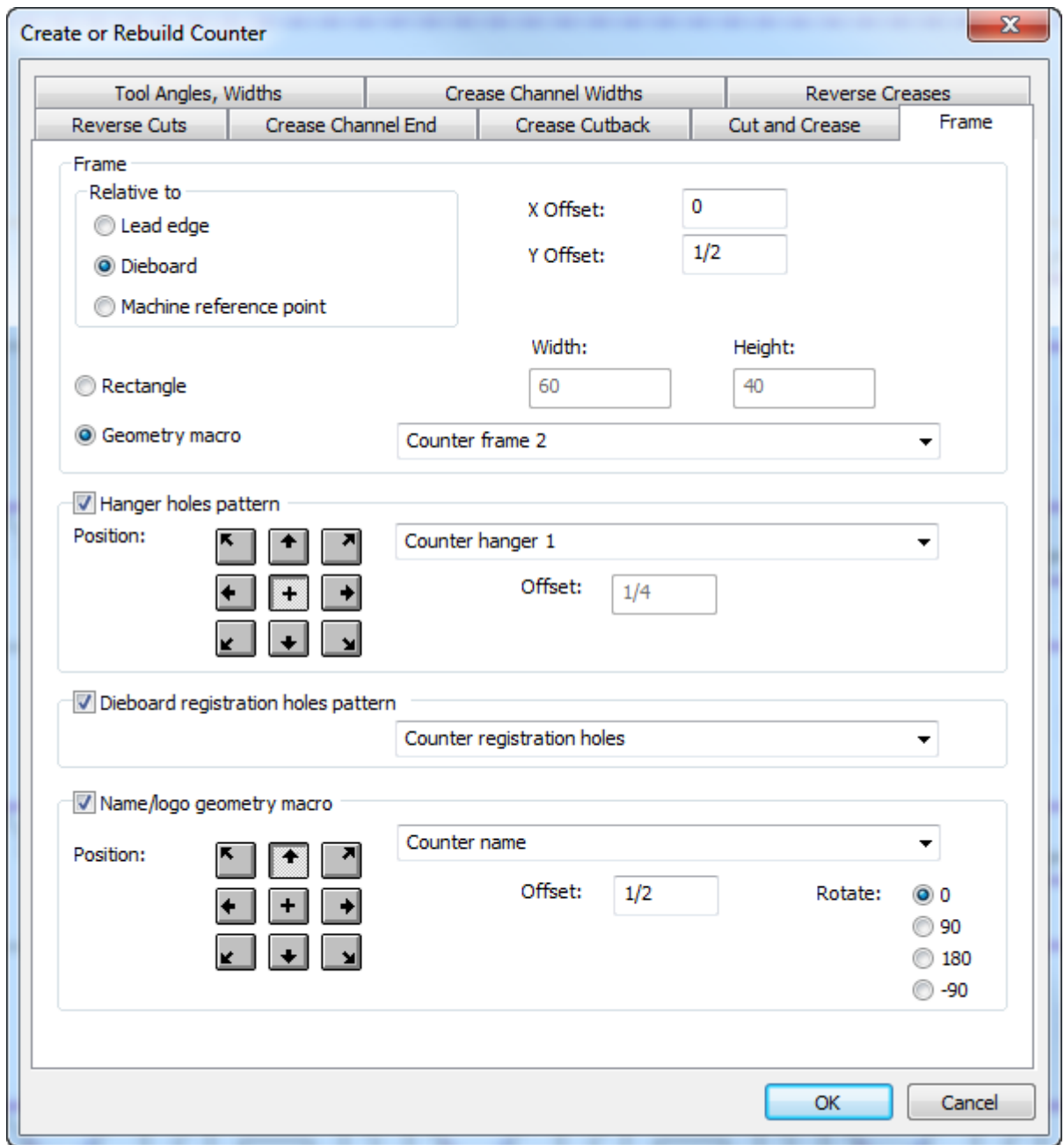

The entries on the Frame tab come from the die press parameter set; all the others come from the counter parameter set. For more information on configuring the parameter sets, please see the *Defaults* chapter. For more information on the Frame tab, refer to the Steel counter section in the *Manufacturing* chapter.

7. ArtiosCAD creates the Steel counter layer and frame.

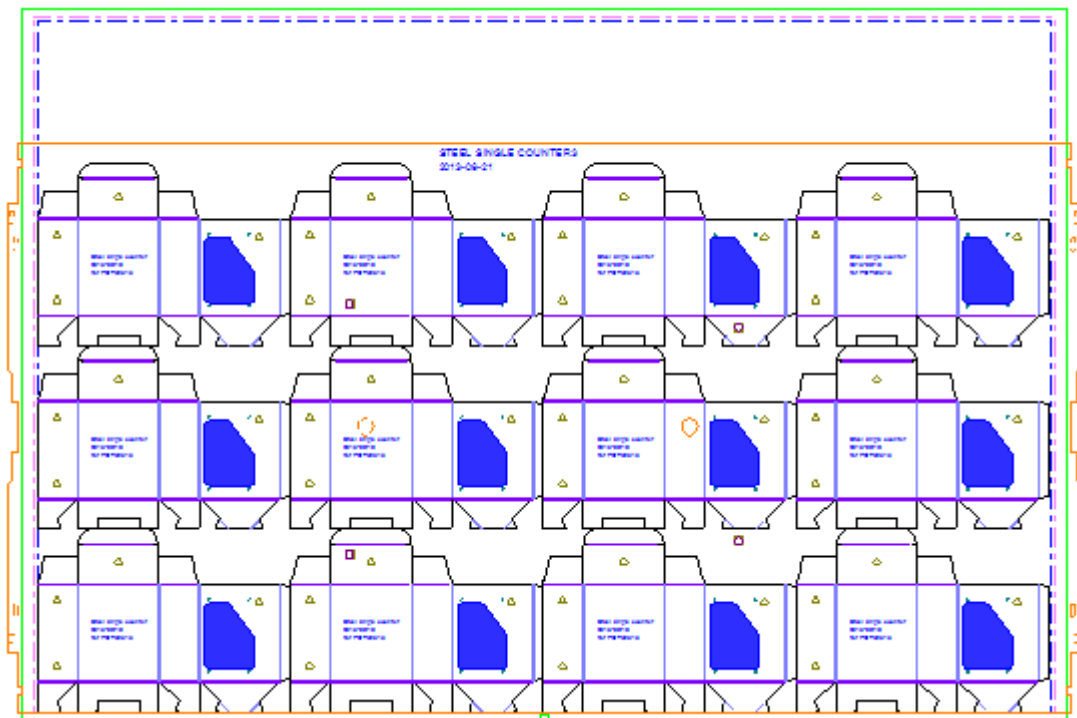

Steel counter workflow notes

There are concepts in the steel counters workflow not related to tool usage that are important to know.

Line types

Line types	Treated as
Perf, partial cut, glue assist perf	Cut
Second-height crease, matrix crease	Crease
Partial cut/crease, perf in channel, partial cut perf in channel, Second height cut/crease	Cut/crease

Channel depths

ArtiosCAD draws different channel depths as different shades, with deeper channels being darker.

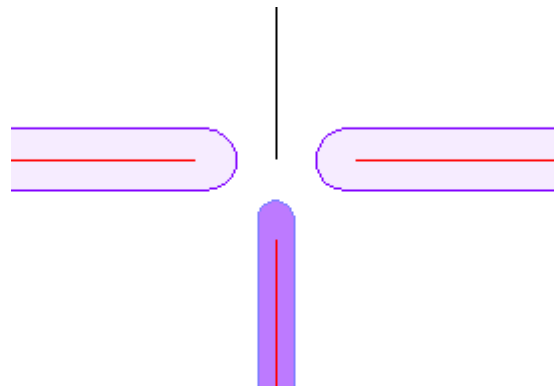

Channel properties

Double-click a channel edge and click **Channel** in the Properties dialog box to see the channel width and depth.

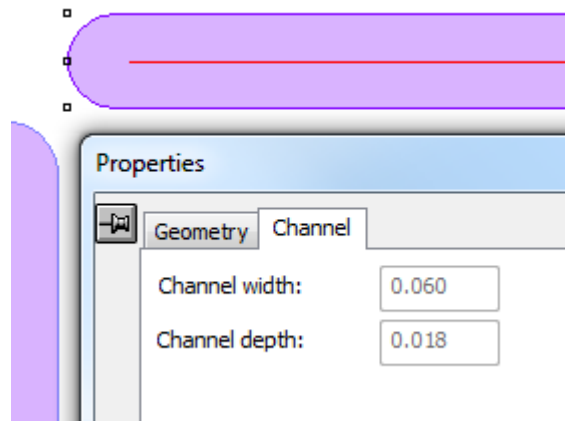

Creating crease channels manually

To create crease channels manually, add lines of type **With grain crease** or **Cross grain crease**. Make them into a loop and group them together.

Creating emboss areas

Emboss areas for steel counters are created by an insert in the die and another in the counter. The insert in the die usually has screw holes for attaching it to the die, and the insert in the counter fits into a milled area. You can use a geometry macro for the emboss area or create it manually. If you use a geometry macro, run it in a counter layer, use a placement option such as **Place the geometry offset from two lines**, and then use **Move to Layer** to move the screw holes into a die layer. In the example below, the screw holes of the Emboss 2 geometry macro are in the Manufacturing layer of the single design and the emboss area is in the Steel Counter layer.

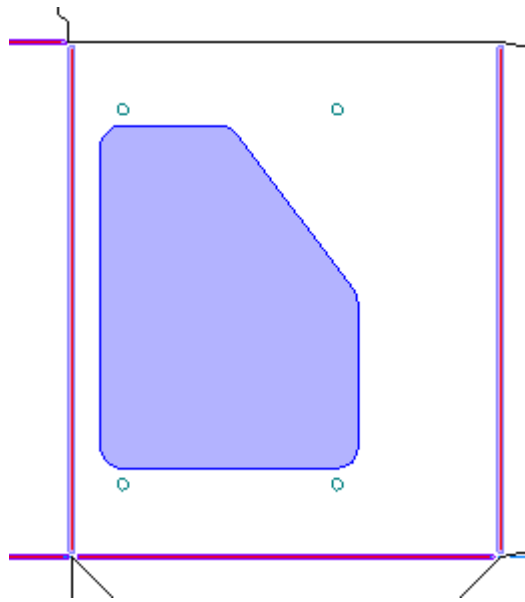

If the design has more than one print item with embossing, share the main counter layer between print items but put the emboss outlines in separate counter layers.

Steel counter creation warnings

 When you use **Create or Rebuild Counter** for a steel counter, ArtiosCAD warns you if it detects problems, such as if creases are too short or if a crease crosses more than one panel. Select the error line in the dialog box to highlight the error; hold down SHIFT to select more than one error at a time. In the example below, the crease is highlighted with a magenta rectangle.

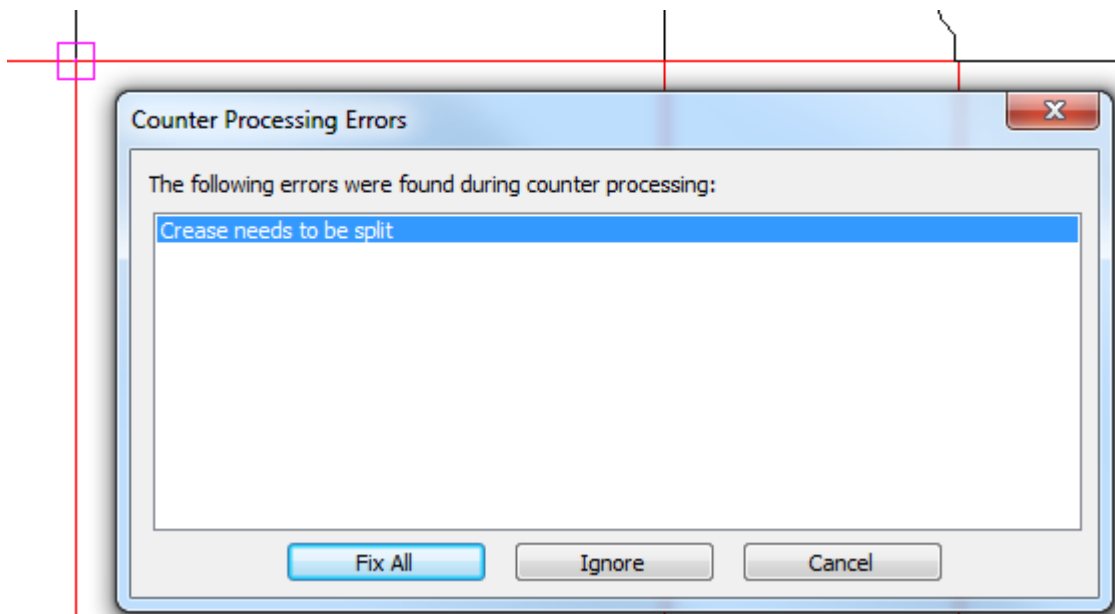

Fix all causes ArtiosCAD try to fix the errors as best it can, but you should note the error locations and check afterward to make sure the results are acceptable.

Warning	How to fix it	If you click Ignore
Generic cut and crease should be changed to a specific type before making the counter	Change the generic cut crease to a special rule such as 1/4 1/4 cut crease	ArtiosCAD treats the generic cut crease like a crease
Crease needs to be split	Split the crease where it crosses another cut or crease	ArtiosCAD does not shorten the crease at this point
Crease double lines	Delete one of the double lines using Design Checks	ArtiosCAD shortens one of the creases but not the other
Short lines at the end of crease lines	Merge or delete the short lines	ArtiosCAD does not shorten the crease correctly
Crease too short for crease channel	Merge or delete the short lines	ArtiosCAD does not shorten the crease correctly

Digitizing

Digitizing is the process of using a digitizer to input lines and arcs into ArtiosCAD. A **digitizer** is a flat tablet which uses electromagnetic energy to track movements of the digitizing puck over the surface of the digitizer. The geometric information derived from these movements is then sent to ArtiosCAD which translates it into lines and arcs. Digitizing is useful when you have a physical sample of a design but no CAD file to accompany it.

The digitizer must be set up before you can use it in ArtiosCAD. For information on setting up a digitizer, see the *Peripherals* chapter.

There are three physical locations used when digitizing.

1. Any coordinate on the digitizer, referred to as **<c>**.
2. An existing point, referred to as **<p>**. A point, when digitizing, is an end point or intersection point of existing lines in the current design. These lines may be pre-existing or just-digitized. To select a point, digitize a point **on the digitizer** within the snap distance of one of these points.
3. An existing line, referred to as **<l>**. To select a line, digitize a point **on the digitizer** within the snap distance of an existing line in the design.

The workflow for digitizing is straightforward.

1. Create a new ArtiosCAD design or open an existing one.
2. Navigate to the desired layer into which you wish to place the new geometry.
3. Click **Tools, Digitize**, and then **Begin Digitizing**.
4. Select the digitizer to use.
5. Digitize as desired by issuing digitizing commands.

6. Activate any other non-Zoom tool in ArtiosCAD to exit Digitizing.

Starting to digitize

Once you have gotten to the point where you are ready to digitize (steps 1 and 2 in the workflow above), click **Tools > Digitize > Begin Digitizing**. You will be prompted to select a digitizer:

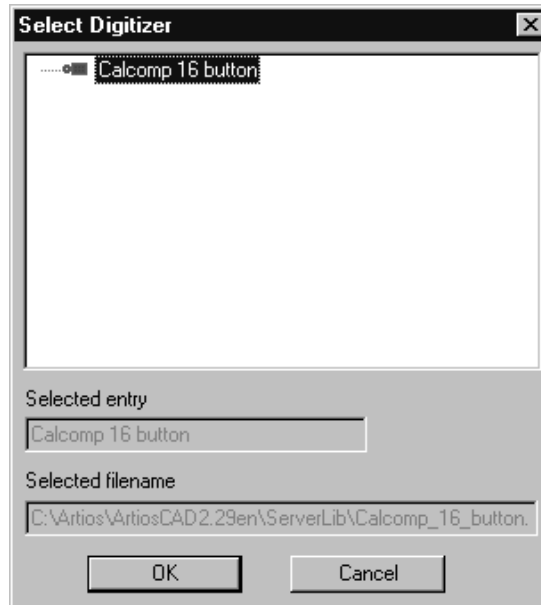

Select the digitizer to use and click **OK**. The status bar will change to look similar to the picture below.



The **Set Radius** field is used by some of the commands. There is no need to align the digitizer or place the menu at this time.

Secure the image to be digitized to the digitizer and start digitizing by issuing digitizing commands.

Issuing digitizing commands

There are two ways to issue digitizing commands. The first is by pressing the buttons on the digitizing puck. Press the button(s) that are listed in the table below to perform the command. For example, to create an arc through a coordinate, press 3 to indicate the coordinate through which the arc passes, and then 3 again to indicate the end coordinate of the arc.

Key sequence	Command
2	MOVE TO <c>
12	MOVE TO <p>

Key sequence	Command
0	LINE TO <c>
10	LINE TO <p>
3	ARC THROUGH <c> TO <c>
41	ARC THROUGH <c> TO <p>
14	ARC THROUGH <p> TO <c>
44	ARC THROUGH <p> TO <p>
77	CENTER <c> RADIUS <c>
76	CENTER <c> RADIUS <p>
7A	CENTER <c> RADIUS radius
66	CENTER <p> RADIUS <c>
67	CENTER <p> RADIUS <p>
6A	CENTER <p> RADIUS radius
52	INTERSECT <l> <l>
51	INTERSECT <l> <l> KEEP 1st
BBB	BLEND <l> <l> THROUGH <c>
BB1	BLEND <l> <l> THROUGH <p>
BBA	BLEND <l> <l> RADIUS radius
D	DELETE <l>
E	UNDO
F	REDO
CD	REPLOT - SCALE TO FIT
CC	REPLOT - CURRENT SCALE
CA	ZOOM BACK
CF	ZOOM WINDOW <c> <c>

If a command requires more keystrokes to identify it than there are data elements required for the command, the most recent digitized points are used.

The second way to issue commands is to use the digitizing menu configured when you set up the digitizer. Simply place the cross-hair over the desired menu command and press any button on the digitizing puck to activate the command. You can also use any button on the digitizing puck to indicate coordinates, points, and lines since the command is already known. Shown at left is the default digitizing menu. Note that it does not contain all the commands available. If you are a gasket maker, you may wish to add the circle-creation tools to it using the procedure in the *Peripherals* chapter.

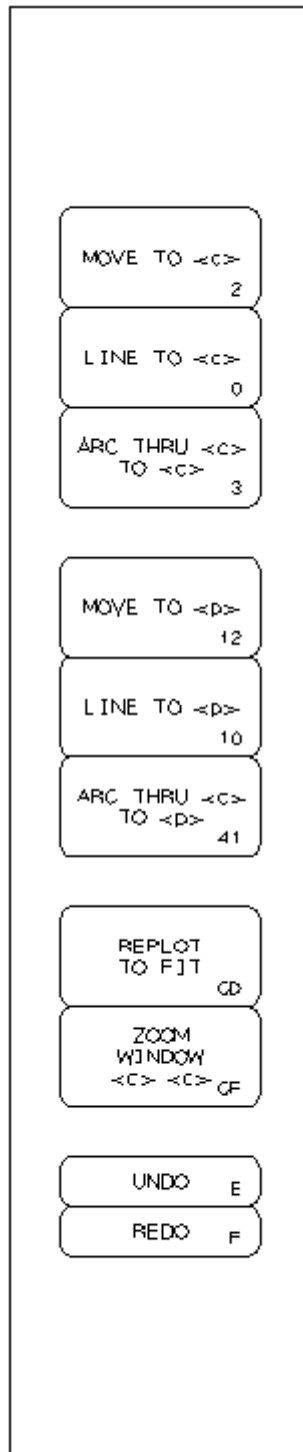

Example - Digitizing a simple shape

This example shows how to digitize the shape below using the commands that follow it. The numbers in the circles are the step numbers, while the numbers inside the digitizing puck are the buttons pressed on the digitizing puck.

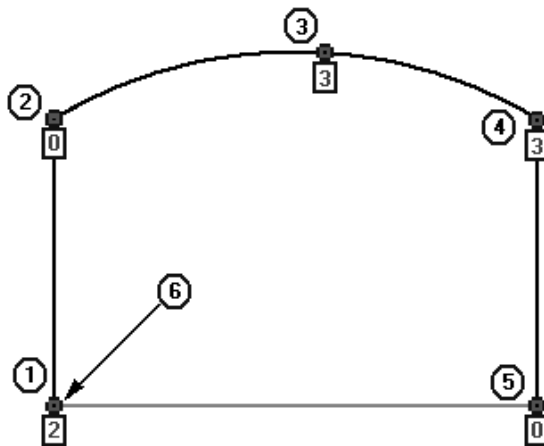

Key sequence	Menu command
0	LINE TO <c>
10	LINE TO <p>
2	MOVE TO <c>
12	MOVE TO <p>
3	ARC THROUGH <c> TO <c>

Start ArtiosCAD and open a new design. Click **Tools > Digitize > Begin Digitizing**. Choose the digitizer to use and click **OK** to enter Digitizing.

1. Digitize a MOVE to the beginning of the first line using the **2** button.
2. Digitize the end of the first LINE by moving the digitizing puck up a few inches and pressing the **0** button.
3. Digitize a coordinate the arc will go THROUGH by moving the puck up and to the right and pressing the **3** button.
4. Digitize the end-point of the arc by moving the puck down and to the right and by pressing any button. Any button will do because ArtiosCAD knows the ARC THROUGH <c> TO <c> command is being used.
5. Digitize the end of the next LINE by moving the puck straight down and pressing the **0** button.
6. Digitize close to the snap point at the start of the first line. The command is made of two button-presses. The first button pressed is **1**, and can be pressed with the digitizing puck anywhere. The second button pressed is **0**, and must be within the snap tolerance of the start of the first line.

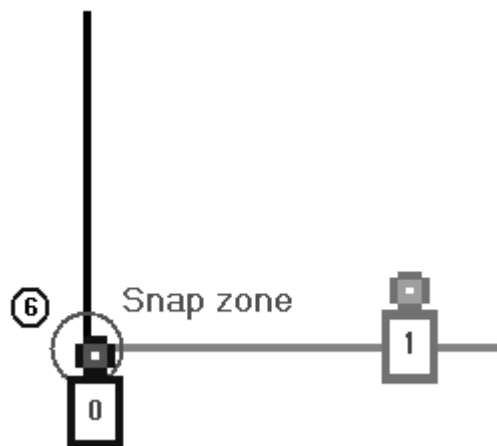

The shape is now complete.

Example - Blending a digitized corner

This example demonstrates how to blend a corner while digitizing. As in the previous example, the number inside the circle is the step number and the character inside the digitizing puck is the button pressed.

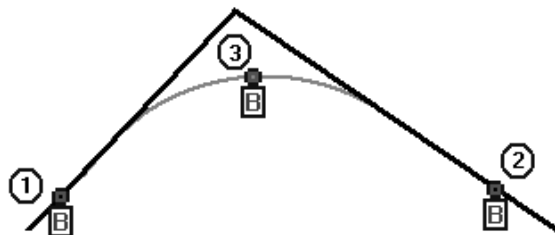

Start ArtiosCAD and open a new design. Click **Tools > Digitize > Begin Digitizing**. Choose the digitizer to use and click **OK** to enter Digitizing.

1. Digitize within the snap tolerance of the first line by pressing the **B** button.
2. Digitize within the snap tolerance of the second line by pressing the **B** button.
3. Digitize a THROUGH coordinate of the blend radius by pressing the **B** button again to complete the command.

Aligning the image on the digitizer

It can be difficult to place the image on the digitizer so that it is completely aligned with the digitizer's axes. To compensate for this, the digitizer can be aligned with known points on the image and known points in the ArtiosCAD Design window. For example, the item to digitize may be a cutout on an existing carton. The corners of the panel will therefore make good points for aligning the image to the design on the screen.

Between 0 and 3 points can be used to align the digitizer with the ArtiosCAD design window.

If 0 points are used, the origin of the digitizer matches the origin in ArtiosCAD.

If 1 point is used, the point selected on the screen corresponds to the digitized point. No scaling or rotation is performed.

If 2 points are used, the first point selected on the screen corresponds to the first point digitized. Scaling and rotation will be performed so that the second points align.

If 3 points are used, a best-fit is performed on the three points on the screen compared to the three points on the digitizer. The image is transformed, scaled, and rotated appropriately.

When aligning the digitizer, the screen points are selected first followed by the points on the digitizer.

To align the digitizer, do the following:

1. Start ArtiosCAD and open a new design. Click **Tools > Digitize > Begin Digitizing**. Choose the digitizer to use and click **OK** to enter Digitizing.
2. **Align Digitizer** Click **Align Digitizer** on the Status bar.
3. The Status bar will change:

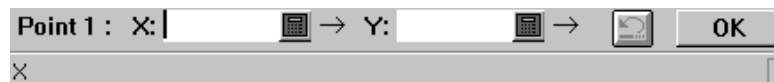

4. Click the mouse on-screen at the desired point. The X and Y fields will have values in them and the point number will increment. If you make a mistake, click the **Redo** button.
5. Repeat step 4 as desired depending on how you want to align the digitizer.
6. Click **OK** when done. If you have selected three points, you do not need to click OK.
7. Now that the screen points are selected, you must indicate the digitizer points.

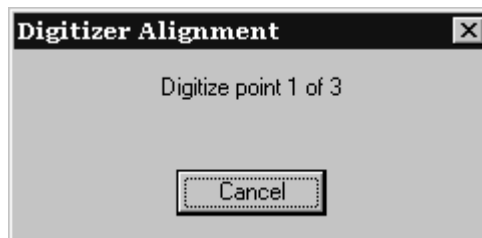

8. Move the digitizing puck to the first point on the digitizer and press any button. Repeat as prompted, moving to the second and third points if necessary.
9. Once enough points have been digitized, the New Digitizer Alignment dialog box appears.

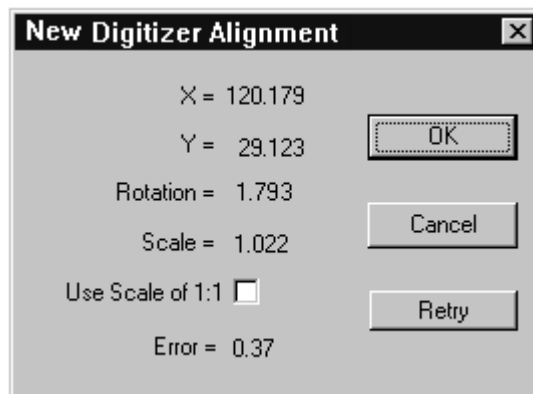

The new alignment is displayed. If two or more points were used, the scale might not be 1.000 and the Error will show how accurate a fit was made.

Checking the **Use Scale of 1:1** checkbox overrides the scale derived from the digitized points. This is useful when the scale factor isn't quite 1.000 but you want to use the rotation derived from the digitizer.

Click **Retry** to perform the alignment procedure again.

Clicking **OK** accepts the new alignment; clicking **Cancel** cancels it. The new alignment is effective until ArtiosCAD is restarted.

Using the digitizing menu

The digitizing menu provides an alternate way to use the digitizer. Selecting a point on a menu button (also called a **Menu Item Area**) with any button on the digitizer puck activates that command.

Using the menu means pressing more buttons on the digitizing puck than just by using the puck alone. For example, if you have a menu button which activates the **CENTER <p> RADIUS <c>** tool, two extra button-presses are required after selecting the button — one to satisfy the <p> and the next to satisfy the <c>. Any button can be pressed to make the data input.

Placing the menu is described in the *Peripherals* chapter.

Projects

ArtiosCAD provides three ways to work with Projects. The first and second ways are using the Project menu and the Project bar, which are the methods used in this chapter. The third way is using the Projects browser in DataCenter Admin, which is described more in the *DataCenter* chapter.

Getting started with Projects

Projects help to track and identify the relationships between designs. Use Projects to group logical single designs together, such as a display base and the items it will hold, or a shipping box and its dividers.

Projects are also used for generating Bill of Materials (BOM) Reports. See the *Outputs* chapter for more information about BOM Reports.

As with single designs, ArtiosCAD can assign names automatically to Projects and the documents within them if the appropriate configuration is performed in DataCenter Admin. See the *DataCenter* chapter for more information.

Creating a new Project

To create a new Project within ArtiosCAD, do the following:

1. Click **Projects > New Project**. The **Create New Project** dialog box appears.

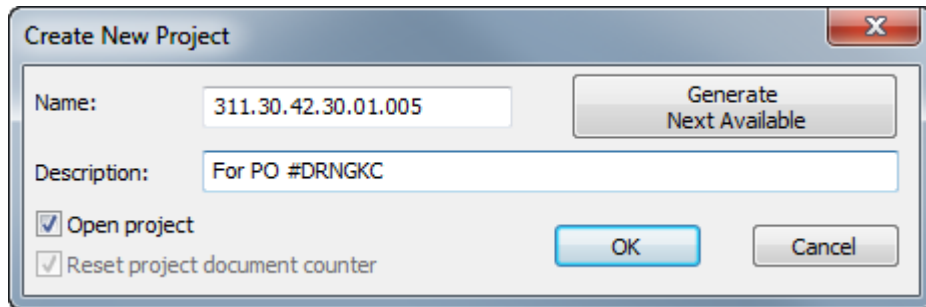

2. Enter the appropriate information in the **Name:** and **Description:** fields, or, if available, click **Generate Next Available** to have ArtiosCAD assign the next available number as the Project name. (This requires the proper configuration in DataCenter Admin.) The Project name must be unique and less than 80 characters.
3. Click **OK** to create the Project and open it. To simply create the Project without opening it, deselect **Open project** before clicking **OK**.
4. ArtiosCAD automatically opens the **Project Information** dialog box so you can add more detailed information about the Project.

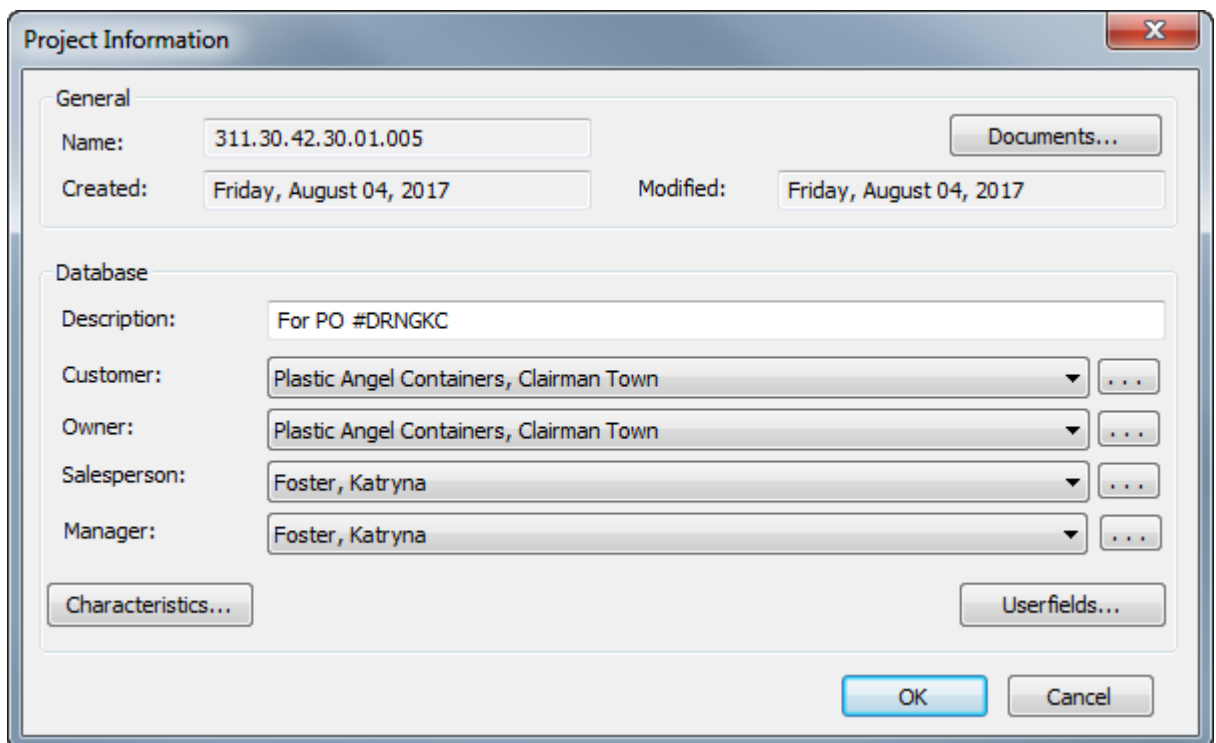

- If you set a description when you created the Project, you can change it by editing the **Description:** field.
- Set the **Customer:**, **Owner:**, **Salesperson:**, and **Manager:** fields by clicking the drop-down list box arrows and choosing an entry from the list shown for each field. To access

the standard database searching dialog box for each type of entry, click ... at the end of each field.

- To set characteristics or userfields for the Project, click the corresponding **Characteristics** or **Userfields** buttons. Projects have their own type of Userfields which must be configured in DataCenter Admin before they become available for use in ArtiosCAD. For more information about configuring userfields, see the *DataCenter* chapter.
5. If you chose to open it, the empty new Project is shown in the Project bar, which by default appears at the right edge of the drawing area.

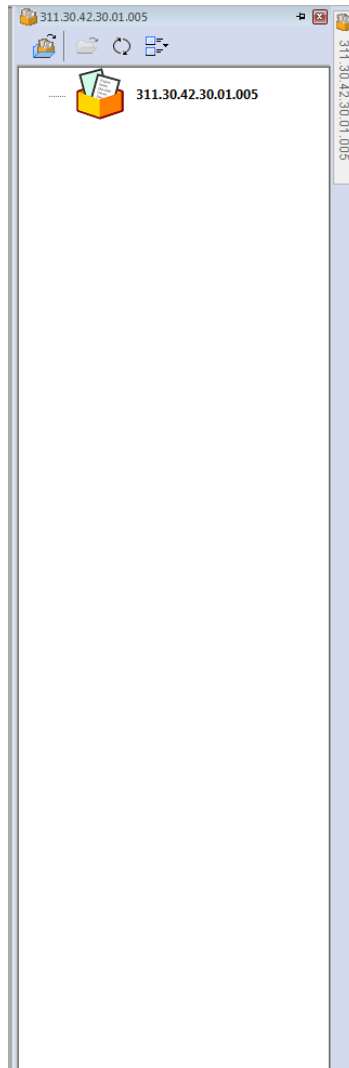

Adding documents to a Project

To add documents (single design workspaces) to a newly-created Project, do the following:

1. With the newly-created Project open, click **Projects > Project Documents**.
2. Click **Add** in the **Project Documents** dialog box.

3. In the **Add document(s) to project** dialog box, in the **Add from:** drop-down list box, select the Resource containing the desired documents.
4. Select the document to add by clicking its name. To select more than one document, hold down CTRL on the keyboard and select the desired documents.
5. Click **Add**. ArtiosCAD adds the selected document(s) to the Project and lists the results in the **Project Documents** dialog box as shown below.

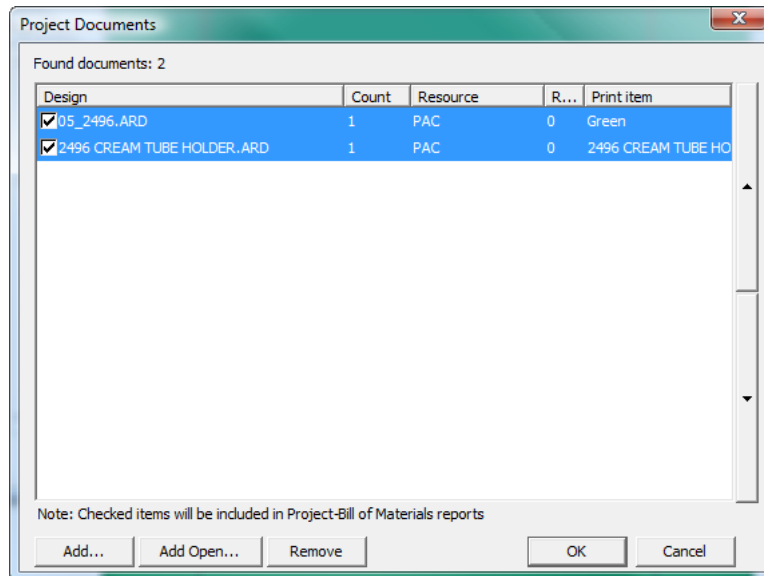

6. If a selected document has more than one print item, you can add another print item to the Project by selecting it from the drop-down list box that appears above the list of documents.

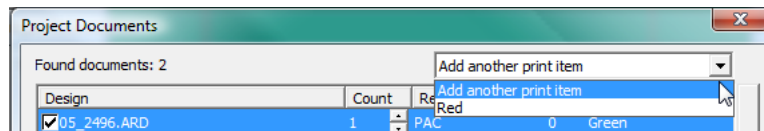

7. Click **OK** to return to ArtiosCAD. ArtiosCAD does not automatically open the documents you add to a Project.

Adding open documents to a Project

To add open documents to a Project, do the following:

1. Open the documents and the Project to which they will be added.
2. Click **Projects > Project documents**.
3. Click **Add Open**.
4. In the **Add Open Documents** dialog box, all the open documents are preselected. Click any document to deselect it from being added to the Project. If you make a mistake, hold down CTRL and select the documents to add to the Project.

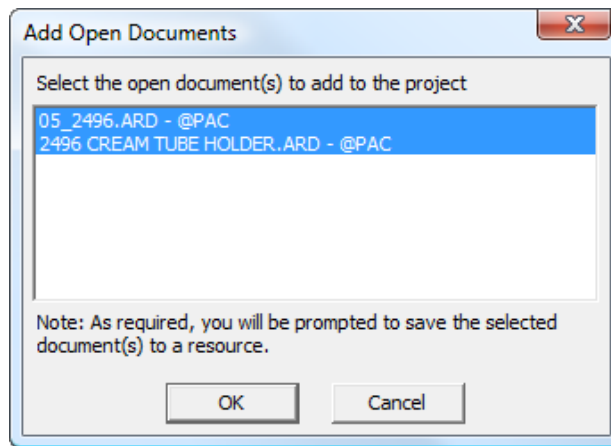

5. Click **OK** to add the documents to the Project. If any of the designs are not in a Resource, ArtiosCAD prompts you to save it/them in a Resource.
6. The documents appear in the **Project Documents** dialog box as shown below. Click **OK** to return to ArtiosCAD.

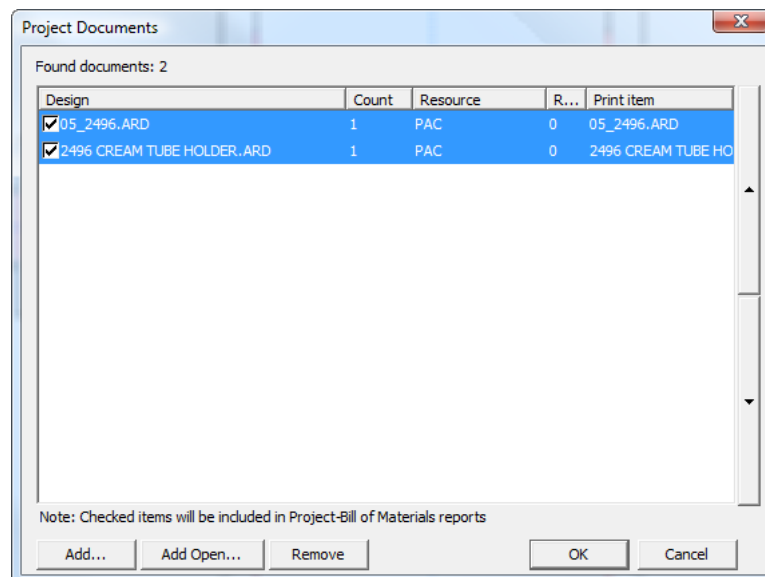

Opening a Project

ArtiosCAD keeps a list of the most-recently used Projects on the Projects menu. To open one of those most-recently used Projects, simply click it; ArtiosCAD also opens the documents that were open when the Project was last closed.

Note:

The number of saved Projects is configured in **Options > Defaults > Startup defaults > Most Recently Used Project List**.

To open a Project that is not on the most-recently used Project list, do the following:

1. Click either **File > Open Project** or **Projects > Open Project** to open the **Open Project** dialog box.

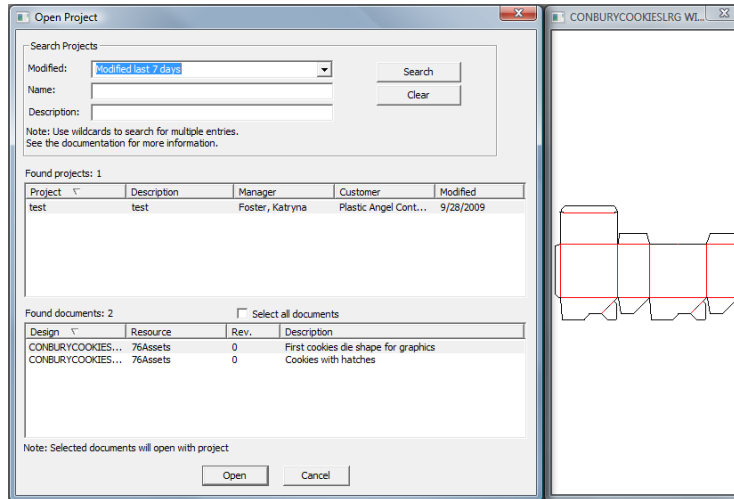

2. To open a Project using the **Open Project** dialog box, perform a search and then select the desired Project from the search results. You can search by the date the Project was last modified, by the name of the Project, the description of the Project, or by a combination of the three.
 - The **Modified:** drop-down list box lets you search for Projects modified during the last day, last 7 days, last 30 days, or a range of your choice by choosing **More options**. When you choose **More options**, you can specify the number of passed days within which to search for the Project, or you can set the beginning and ending dates of the range within which to search for the Project. Clicking either the **Begin date:** or **End date:** drop-down list box arrow when **Modified between dates** is selected activates a pop-up calendar that you use to choose the date to begin or end the range of date-searching. Click **OK** to return to the **Open Project** dialog box.

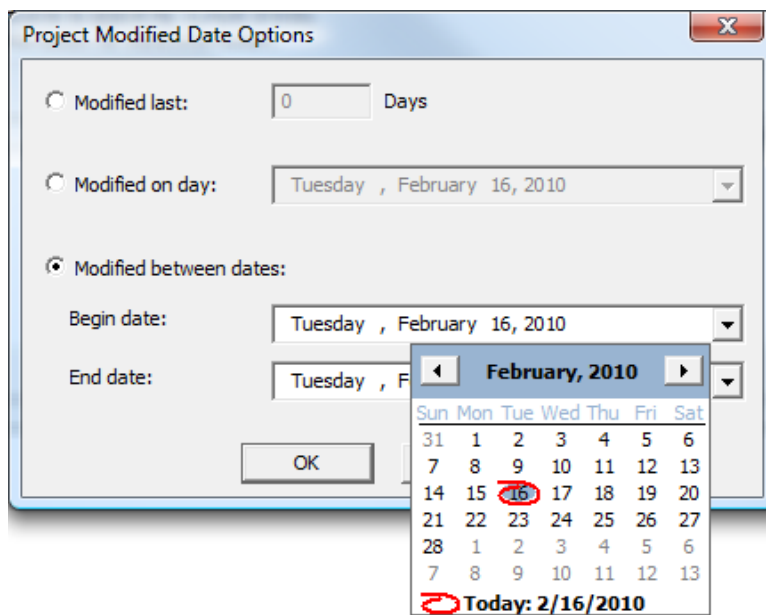

Note:

To not search by time the Project was last modified, set the **Modified** drop-down list box to ----.

Note:

When using the drop-down calendar in any of the fields, you can click the month and the year in the date and enter a different month or year, or use the up and down arrow buttons to change years.

- To form a search phrase in either the **Name:** or **Description:** fields beginning with a certain combination of letters, enter that combination of letters and an asterisk (*), such as 2496*. To form a search phrase containing a certain combination of letters, enter that combination preceded with and followed by asterisks, such as *2496*. To form a search phrase equaling an exact combination of letters, enter that combination of letters. To use an wildcard single-character match, use ? in place of the character, such as *24?6*, which will find all Projects containing 2406, 2416, 2426, and so forth.

Note:

% may be substituted for * in "match all" searches and _ may be substituted for ? in "match only one" searches. For more information about searching, see the Projects section in the *DataCenter* chapter.

3. Once you have chosen the method by which to search - **Modified:**, **Name:**, or **Description:**, and have entered the appropriate information, click **Search**. ArtiosCAD displays all matching projects in the **Found projects** pane, with the first Project selected. The documents in the first Project are listed in the **Found documents** pane, with the first one selected and shown in the Preview window.

4. To open the Project and the selected document, click **Open**. To open the Project and all its documents, check **Select all documents** and click **Open**. Clicking **Cancel** closes the dialog box.



You can also open a Project by selecting it in the Project Browser and clicking **Open Project**.

A Project's Modified date gets updated when you change any of the following:

- Any database information, such as the description, customer, owner, and so forth
- Any characteristics
- Any userfields or their values
- Any documents (add or remove documents, change the BOM count, and so forth).

Opening documents in a Project

ArtiosCAD provides two ways to open Project documents. To open documents in a Project, do the following:

1. Open the Project containing the desired documents. If you use the Most-Recently Used Project list on the Project menu to open the Project, ArtiosCAD opens the documents that were open when the Project was last closed.
2. Decide how you want to open the documents, and then proceed using the choices in the table below.

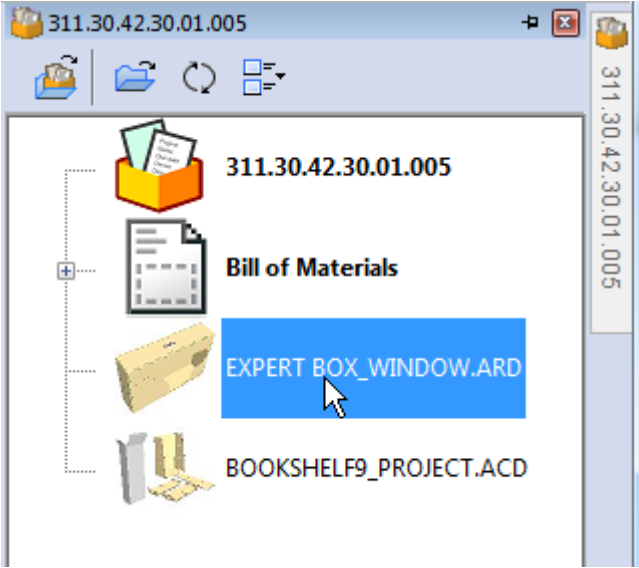
To open documents by...	Do this...
<p>Using the Project Bar</p>	<p>Hover over the Project name to expand the Project Bar if it is collapsed, and then double-click a document to open it.</p>  <p>You can also select a document it, right-click it, and click Open Document(s) on the context menu.</p> <p>Hover over a document to see its description.</p>

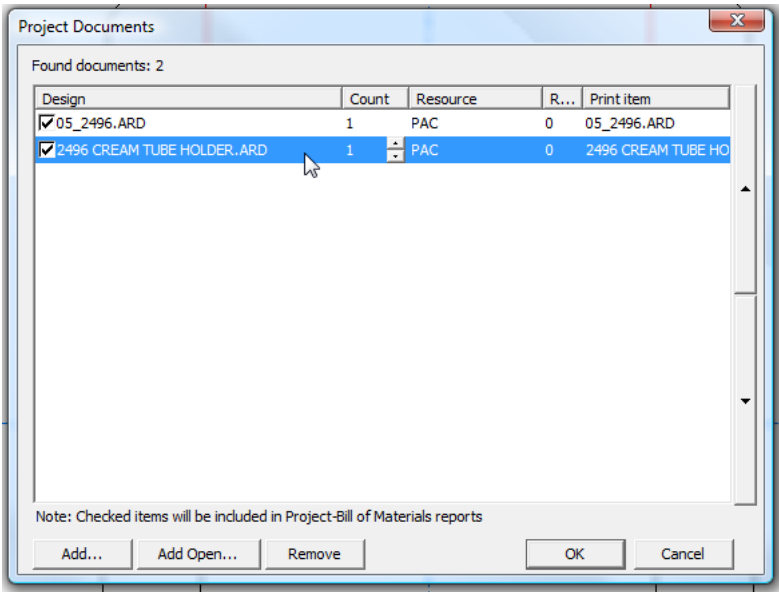
<p>To open documents by...</p>	<p>Do this...</p> <p>To open more than one document at once, hold down CTRL or SHIFT while selecting the documents, then click  Open Selected Project Documents on the toolbar, or right-click and click Open Document(s).</p> <p>ArtiosCAD opens the selected document(s).</p>
<p>Using a dialog box</p>	<p>Click Projects > Project documents, and in the Project Documents dialog box, double-click the document to open.</p>  <p>ArtiosCAD closes the Project Documents dialog box, opens the selected document, and shows the Project icon in its tab.</p>

ArtiosCAD shows that the document is in a Project by putting its icon in a tray in the window tab and by underlining the name in orange. In the example below, the left document is in the Project, and the right document is not.



Working with the Project Bar

ArtiosCAD lets you work with Projects using the Project Bar, which shows the files in the active Project if there is one. Using Projects is optional in ArtiosCAD Standard Edition, but their use is required in ArtiosCAD Enterprise. To open the Project Bar when it is not open, click **View**

> **Show Project Bar** or **Projects > Show Project Bar**. Shown below is the Project Bar with a Project open.

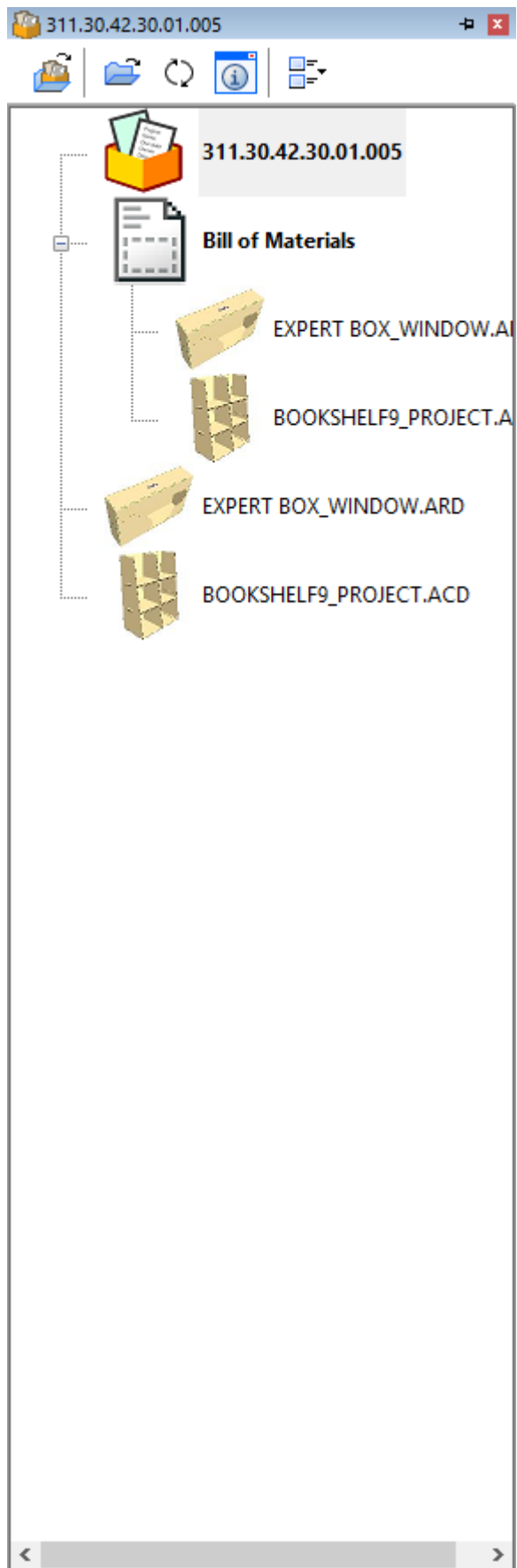

ArtiosCAD shows the name of the Project in the title bar of the Project Bar. If there is no open Project, ArtiosCAD shows *No Project*.

The first node in the list is the Project icon, then the Bill of Materials if one exists, and then documents and folders (folders in ArtiosCAD Enterprise only).

If a document has a print item specified, the name of the print item appears in parentheses after the name of the document.

When you expand the BOM, it may take ArtiosCAD a few seconds to populate it.

Double-clicking the BOM node opens all the documents in it.

Double-clicking a folder (ArtiosCAD Enterprise only) opens all the documents in the folder.

ArtiosCAD builds the Project Bar dynamically so there might be a slight delay as you change Projects.

In ArtiosCAD Standard Edition, the Project Bar appears when you open a Project and disappears when you close the Project. In ArtiosCAD Enterprise, the Project Bar appears automatically when you open a managed document.

Hover over a document in the Project Bar to see the first 40 characters of its description. If its description is longer, ArtiosCAD shows an ellipsis at the end.

Pressing CTRL-A when an item in the Project Bar is selected selects all expanded nodes in the tree.

The Project Bar Toolbar

The Project Bar toolbar contains four buttons. The first button depends on the version of ArtiosCAD you are using.



For ArtiosCAD Standard Edition, **Open Project** opens the Open Project dialog box.



For ArtiosCAD Enterprise, **Open Browser** replaces Open Project and opens the browser.



Open Selected Project Documents opens the documents you have selected. To select more than one document at a time, hold down CTRL or SHIFT while clicking items to select. If you have selected a Project node, ArtiosCAD opens all the documents in the Project and ignores everything else. If you have selected a BOM node, ArtiosCAD opens all documents in the BOM. If you have selected a folder (ArtiosCAD Enterprise only), ArtiosCAD opens all the documents in the folder.



Refresh checks for changes to the list of documents (and folders in ArtiosCAD Enterprise) in the Project since you opened it.



Show Information Dialog performs different actions depending on the current selection.

- If the Project is the current selection, clicking it opens the Project Information dialog box.
- If the Bill of Materials is the current selection, clicking it opens the Project Documents dialog box in ArtiosCAD Standard Edition. In ArtiosCAD Enterprise, it opens the Project Bill of Materials Documents dialog box.
- If a document in the Bill of Materials is the current selection, and that document is open, clicking it changes focus to that document and opens its Oneup Database Information dialog box.
- If a document in the Bill of Materials is the current selection, and that document is not already open, clicking it opens the document's Oneup Database Information dialog box in read-only mode. In ArtiosCAD Enterprise, if that document is a native file type, ArtiosCAD opens the Oneup Database Information dialog box in read-only mode. If the document is not a native file type, ArtiosCAD displays an error message.
- In ArtiosCAD Enterprise, this button is not available when a folder is selected.



If the Bill of Materials is the current selection



Icon Size lets you choose between **No icons**, **Small icons**, **Medium icons**, and **Large icons**.

Manipulating the Project Bar

Pinning and Hiding

The default state of the Project Bar is to auto-hide itself. To pin it to the window so it is always visible, click the pushpin icon at the right end of the Project Bar's title bar . It changes to show it is pinned . To set the bar to auto-hide again, click the pushpin icon.

Detaching

The Project Bar is detachable from the main window of ArtiosCAD and may be docked on either the left or right side of the drawing area. To detach it, first pin it so it does not auto-hide, then drag it by its title bar to the desired position. You can resize the Project bar as desired.

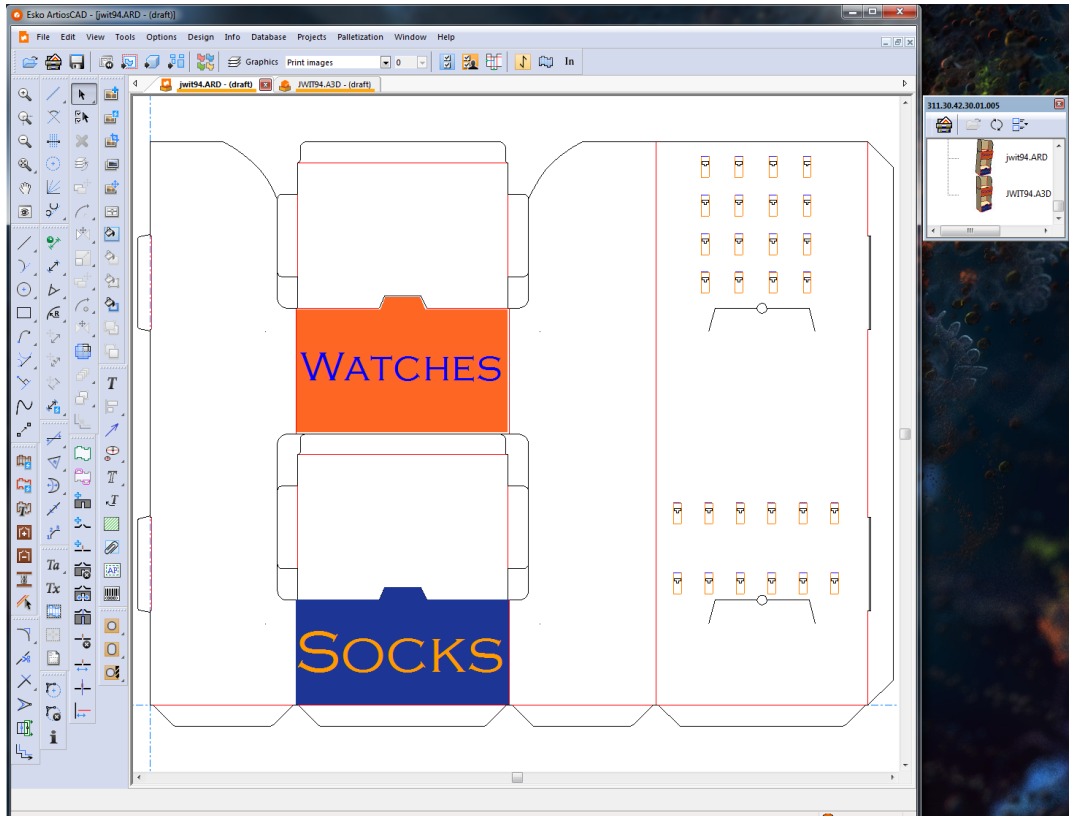

Docking

To dock the Project Bar after detaching it, drag it back into the main ArtiosCAD window, and position the cursor over the arrow indicating where you want it to go. The target area turns blue.

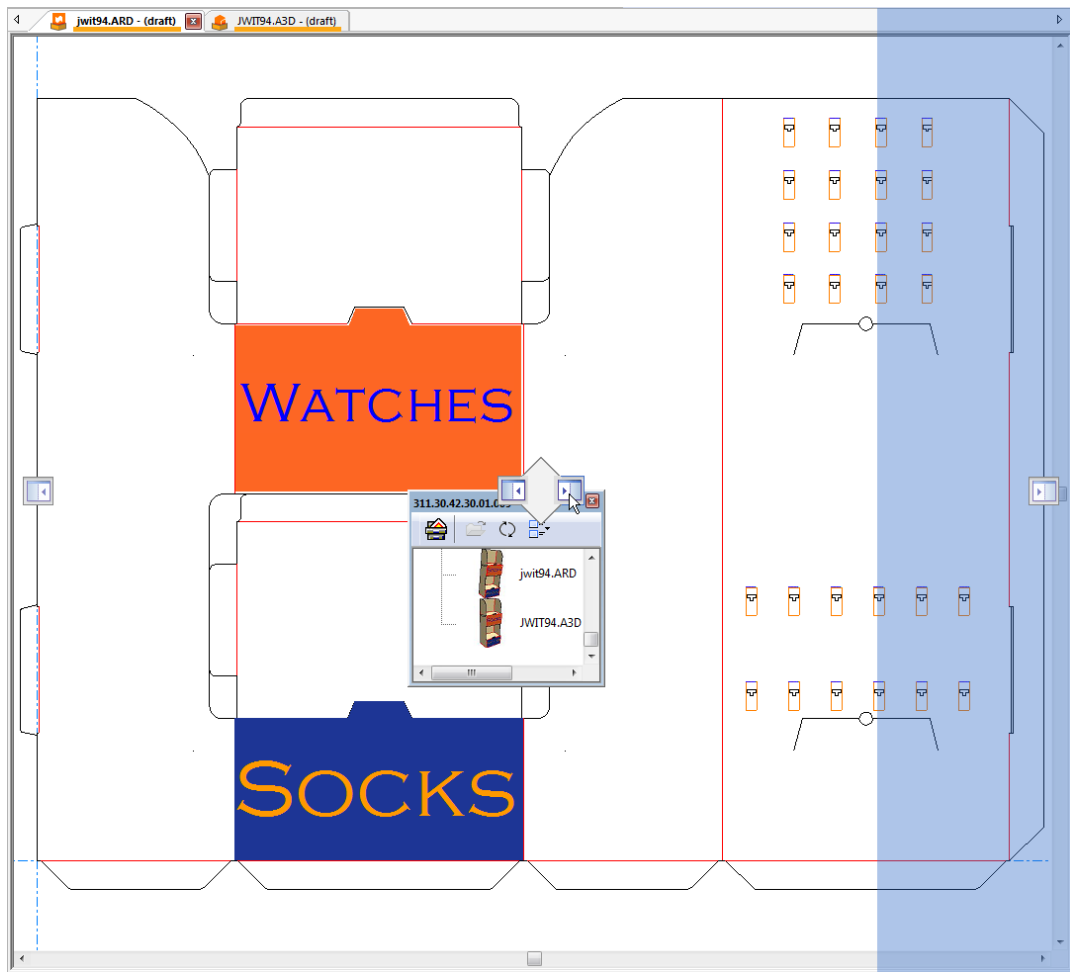

Release the mouse button to dock the Project Bar.

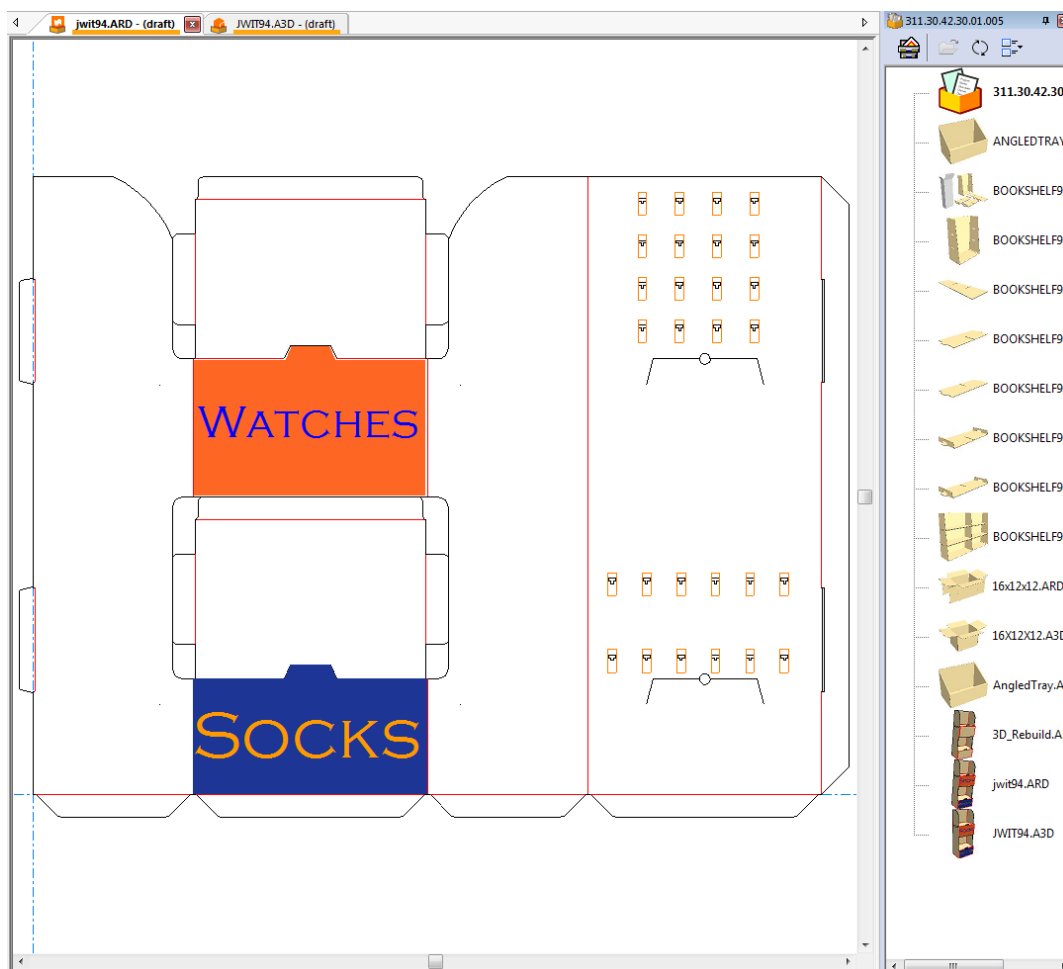

Closing

To close the Project Bar, click the red X at the right end of its title bar.

Using Both the Parts List and Project Bar

If you have a canvas in a Project, the Parts List and the Project Bar are independent of each other and you may manipulate them as desired. Shown below are both hidden.

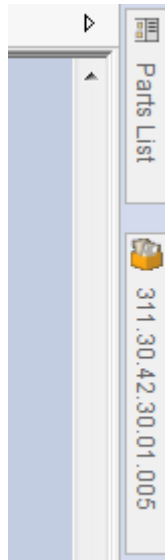

Shown below are both docked.

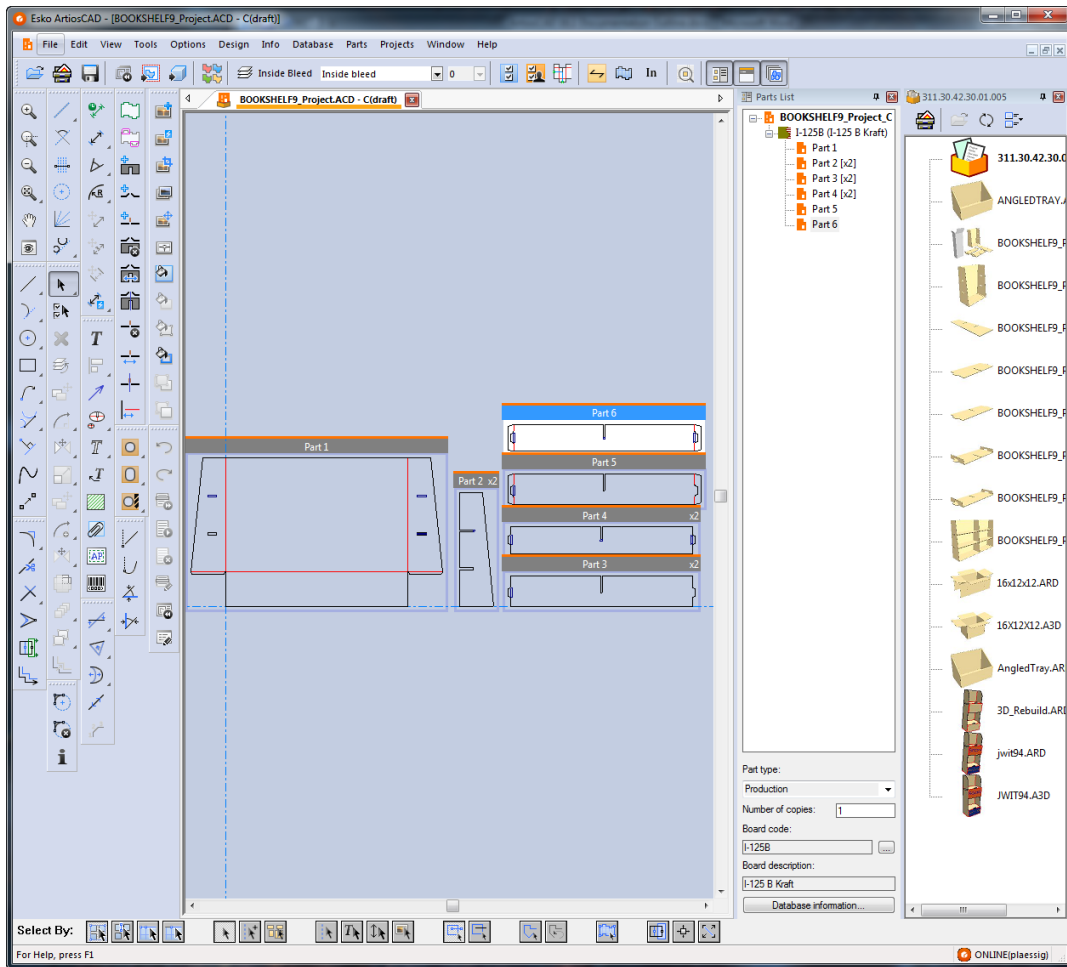

Setting Project information

Each Project may have a description, a customer, an owner, a salesperson, a manager, characteristics, and Project userfields assigned to it using the **Project Information** dialog box. ArtiosCAD prompts for this information when you create a new Project, but you can change this information at any time. Shown below is the default **Project Information** dialog box. You may design a custom Project Information dialog box in Defaults.

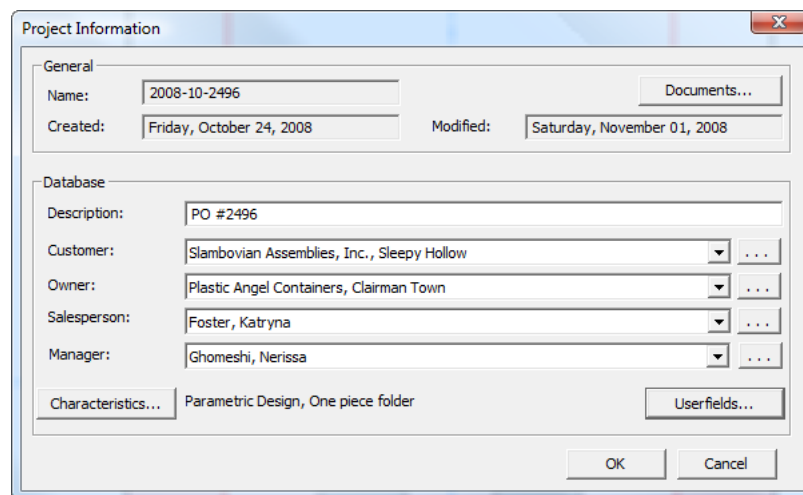

To set Project information after the Project has been created, do the following:

1. Open an existing Project.
2. Click **Projects > Project Information**.
3. If you set a description when you created the Project, you can change it by editing the **Description:** field.
4. Set the **Customer:**, **Owner:**, **Salesperson:**, and **Manager:** fields by clicking the drop-down list box arrows and choosing an entry from the list shown. To access the standard database searching dialog box for each type of entry, click ... at the end of each field.
5. To set characteristics or userfields for the Project, click the corresponding buttons **Characteristics** or **Userfields**. Projects have their own type of Userfields which must be configured in DataCenter Admin before they become available for use in ArtiosCAD. For more information about configuring userfields, see the *DataCenter* chapter.
6. To add or remove documents to or from the Project, click **Documents**, which opens the **Project Documents** dialog box as described earlier.
7. Click **OK** to return to save the changes and return to ArtiosCAD. Any changes made to the information are saved to the database once you click **OK**.

Closing a Project

To close the active Project, do the following:

1. Click **Projects > Close Project**.
2. If any Project documents are open, ArtiosCAD will ask if you want to close them. Click **Yes**.
3. If any Project documents being closed have unsaved changes, ArtiosCAD will ask if you want to save changes. Click **Yes** or **No** as desired.

Notes and warnings for Projects

A **Projects** item has been added to the General information category of the calculated text table. When used on a Report, this item generates a comma-separated list of Project codes.

Revisions

A Project may only contain one revision of a single design.

When you click **Save As Revision** in a single design that is part of a Project, the Save As Revision dialog box will show a list of the Projects of which the single design is a member. Migrate the Projects information to the new revision by selecting the checkbox next to the Project name. To keep the Project information in the old revision, clear the checkbox next to the Project name.

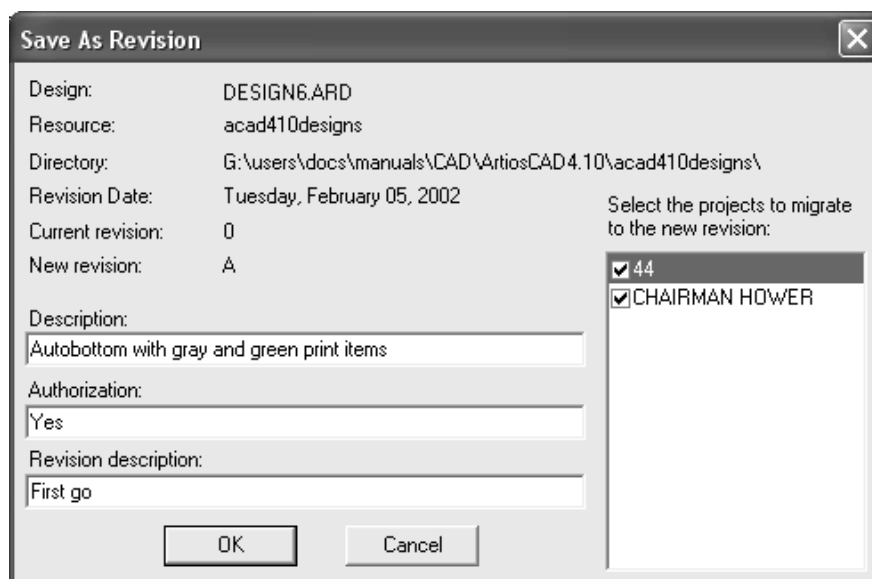

Opening files from another database

When you open a single design containing records from another database, the Add Database Entities dialog box appears. In this dialog box, choose which entities to add to your database by checking the checkbox next to each available category. The enabled categories depend on which entities are set in the single design.

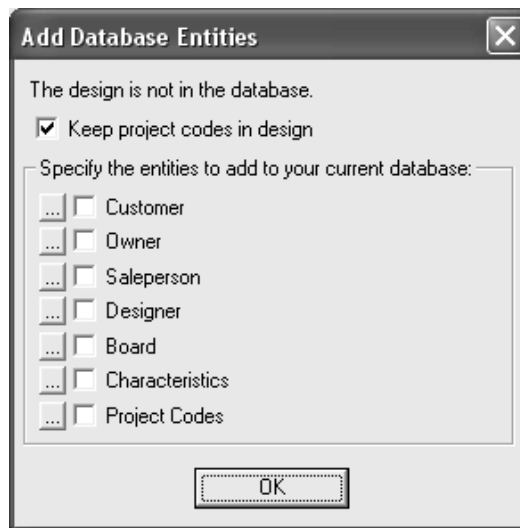

The **Keep project codes in design** checkbox controls whether or not ArtiosCAD leaves the Project codes from the foreign database in the single design or if it strips them out.

To see the specific entities for each category of database entities, click ... next to the checkbox. All entities will be added if you check the checkbox; there is no way to choose which specific entities are added to the database. Specific Project entities are shown below; click **OK** to return to the Add Database Entities dialog box.

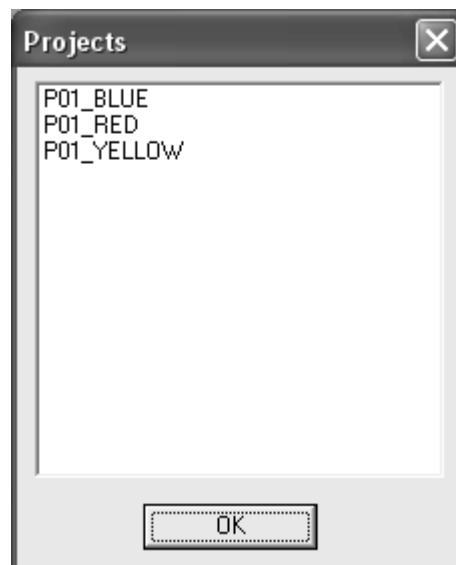

To add a design containing Project codes from another database to your database and additionally have the Project codes in that design added to your database, do the following:

1. Put the design into a resource (whether by saving it from an email message, copying it off a floppy disc, or whatever method you use).
2. Start ArtiosCAD and open the design.
3. In the Add Database Entities dialog box, check both the **Keep project codes in the design** and the **Project Codes** checkboxes.
4. Save the design, making sure to not change the name or resource.

Design Checks

Use **Design Checks** on the Design menu to check the design for double lines, gaps in the perimeter, rules with pointage 0, and rules of different pointages that meet.

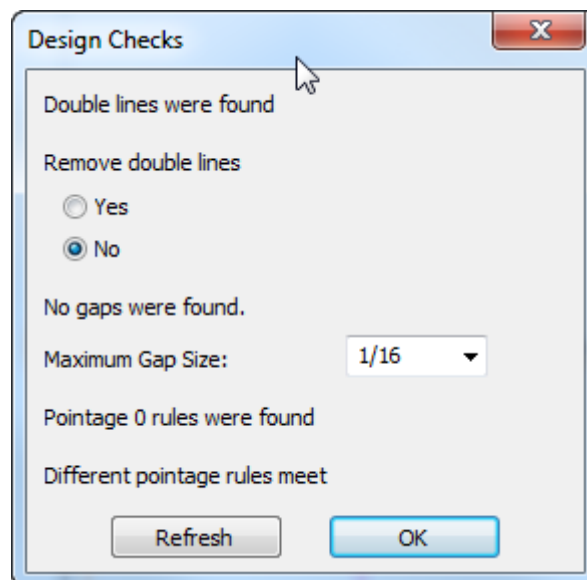

To remove double lines, click **Yes** and then click **OK**. To leave them unchanged, click **No**. 50 double lines are reported initially when the check is run.

Maximum Gap Size sets the size of the largest gap that will be found by Design Checks. The tool finds gaps smaller than the value set for this field. If it finds any gaps, they are circled with magenta circles.

To search for other gaps, change the value in the **Maximum Gap Size** field and click **Refresh**.

If **Design check before Save, Save as** is checked in **Options > Defaults > Shared Defaults > Design Defaults > Save Options**, the design is checked when it is saved. This option is off by default.

Canvases

Canvases are design workspaces made of multiple separate pieces called *parts*. Their filenames have the extension .ACD, which stands for ArtiosCAD Canvas Design Document.

Some designers, especially those who work on displays, like to have all the pieces together in one file. Others like to design alternate views of the finished project and include them in the workspace. Whatever your drafting style is, if you want more than one piece in a workspace, canvases are for you.

Canvases:

- Do not contain manufacturable geometry at the canvas level, meaning you can only draw in a part, except for construction lines
- Convert to 3D and manufacturing just like single designs

Parts:

- Can be exported as single designs or exist only in the canvas
- Have three major types: **Production**, **Non-production**, and **Layout**. Non-production parts are meant to represent things such as an exploded view or notes. Layout parts are meant for quick nests to see if the parts fit on a sheet, but you can also convert them to manufacturing workspaces for other workflows.
- The minor part type **Remainder** which ArtiosCAD creates (if needed) when rebuilding a canvas
- The minor part type **Hardware**, created only by the **Add Hardware** tool in 3D. There is no way to add such a part manually to a canvas.
- Expand and contract automatically depending on how you draft inside them

The canvas interface

The canvas interface is similar to that for single designs, but there are a few differences.

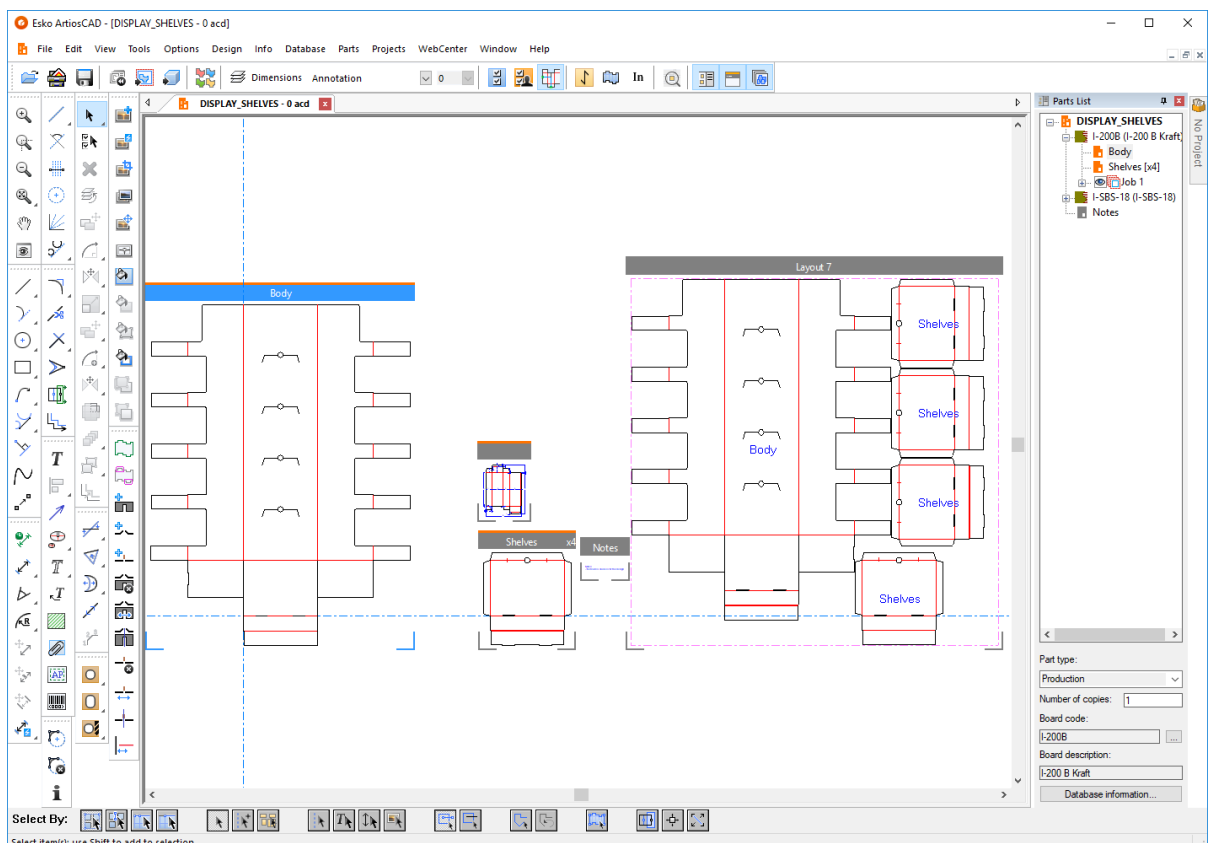

Canvases have a Parts List at the right edge of the drawing area that is organized by board codes used in the canvas. Use the toggle at the right end of the View bar to turn it on

and off. Drag the handle between the Parts List and the drawing area to resize the Parts List as desired. Click an item in the Parts List to change the active part or to make the canvas itself active (for setting database information, among other things).

Like the Project Bar, the Parts List may be detached, docked on either the left or right side of the drawing area,

Right-click the canvas name in the Parts List to:

- **Create Part**
- **Import Standard as New Rebuildable Part**
- **Import File as New Rebuildable Part**
- **Import File as New Static Part**
- **Import File as New Rebuildable Part Reference**
- **Import File as New Part Reference**
- **Convert to Manufacturing**

Right-click a single design part name in the Parts List to:

- **Rename Part** (which you can also do by single-clicking a part's name in the list)
- **Delete Part**
- **Mark as Production / Mark as Non-production**
- **Make Read-Only**
- **Convert to Manufacturing**
- **Isolate Part**
- **Add to Bill of Materials**
- Display or change **Board Information**

Hover over a part name in the Parts List to see its filename.

Right-click a board in the Parts List to:

- **Create Layout**
- **Create Part**
- **Change Board**

Right-click a job in the Parts List to:

- **Recalculate Job**
- **Delete Job**
- **Rename Job**

Right-click a layout in the Parts List to:

- **Rename Layout**
- **Delete Layout**
- **Shrink Sheet to Fit**
- **Convert to Manufacturing**
- **Isolate Part**

Right click a Hardware part in the Hardware folder on the Parts List to rename it.

Hardware parts:

- are meant to appear on the BOM and give a visual representation of the part in the canvas.
- on a BOM, they are in their own folder but are deselected by default
- have a lock symbol next to them in the list and in their title bars to show they are read-only
- are created and modified only by the **Add Hardware** tool in 3D
- do not have information that can be changed manually in the Parts List; the part type, part name, and description are for information only

- make unavailable most tools and workflows when they are the active part

You can also single-click a selected part in the Parts list to rename it.

At the bottom of the Parts List are controls that act on the selected part. Different part types have different controls. For single design parts, one lets you set the part type to **Production** or **Non-production**. Non-production parts appear at the bottom of the Parts List.

Number of copies lets you set the number of copies of the part you need in the canvas to complete the customer's order, without having to have identical copies of the same part. ArtiosCAD uses this number in jobs and layouts to determine the job quantity. If you use a variable in a **Copy Times** tool for the number of copies, you can then use that variable in the Number of copies field, and AC will update it appropriately after rebuild. To use the CAL(x) function in this variable, create a new variable and set it to CAL(x) first, then use the new variable in the **Copy Times** expression. The part frame shows the evaluated number but the Number of copies field shows the expression.

More Options (...) next to Board Code lets you change the board code for the selected part or canvas. Lastly, you can also see the database information for the selected part or canvas by clicking **Database information**.

When you select a job in the Parts List, you can click **Job Information** or **Recalculate Job**. Each job has a visibility button preceding its name in the Parts List so that you can turn it off individually from the others.

When you select a layout in the Parts List, you can set the **Number of sheets**, the **Sheet width**, and the **Sheet height**. ArtiosCAD also displays the waste percentage and the blank size. Additionally, you can click **Sheet Properties**, **Layout Information**, **Recalculate Job**, and **Database information**.



Each part has a frame drawn around it, or corner marks, or nothing, depending on the settings on the Canvas/Parts Options tab in Startup Defaults in Defaults. Production parts have an orange line at the top of their title bars and an orange icon in the Parts List. Non-production parts have a gray line at the top of their title bars and a gray icon in the Parts List. Use the toggle at the right end of the View bar to turn it on and off. You can also toggle part frames in the View Mode dialog box, as well as on the **View > View Options** menu. The part name in the title bar disappears if it is too long to show based on the zoom level.



To show or hide layouts, use the **Show or Hide All Layouts** toggle above the Parts List. This works best when you stack the layouts in vertical columns, as ArtiosCAD shifts parts left and right when you use this control. Use **View > Show All Layouts** if you prefer a menu command.

Feature availability in canvases and parts

While the canvas interface is similar in many ways to that of single design, there are some features and menus that are not available.

Not available in canvases and parts:

- **Tools > Counter**
- **Tools > Reports**
- **Help > Diagnostics > Import NC File**
- Palletization
- Sequencing tool

- **Group Sequence** and **Design from Half/Quarter** are not available.

In ArtiosCAD Standard Edition, **Publish to WebCenter** is not available for canvases.

The following features are not available when the canvas is active, but are available when a part is active:

- **File > Import > Import File**
- **Edit > Paste**
- **Edit > More Select**
- **Edit > Edit Tools**

If the current tool is not available when switching to a canvas, ArtiosCAD activates the **Select** tool.

For Layout parts, only Outputs and Geometry Macros (with **Move to Layer** enabled) are available.

For Reports around Layout parts, you can use **Select** to select elements of the Report. Inside the sheet, it only selects entire parts.

Using Isolation Mode

 The **Isolation Part** toggle at the right end the stage bar enables isolation mode, which shows only the current part on the screen and hides all other parts.

Not in isolation mode:

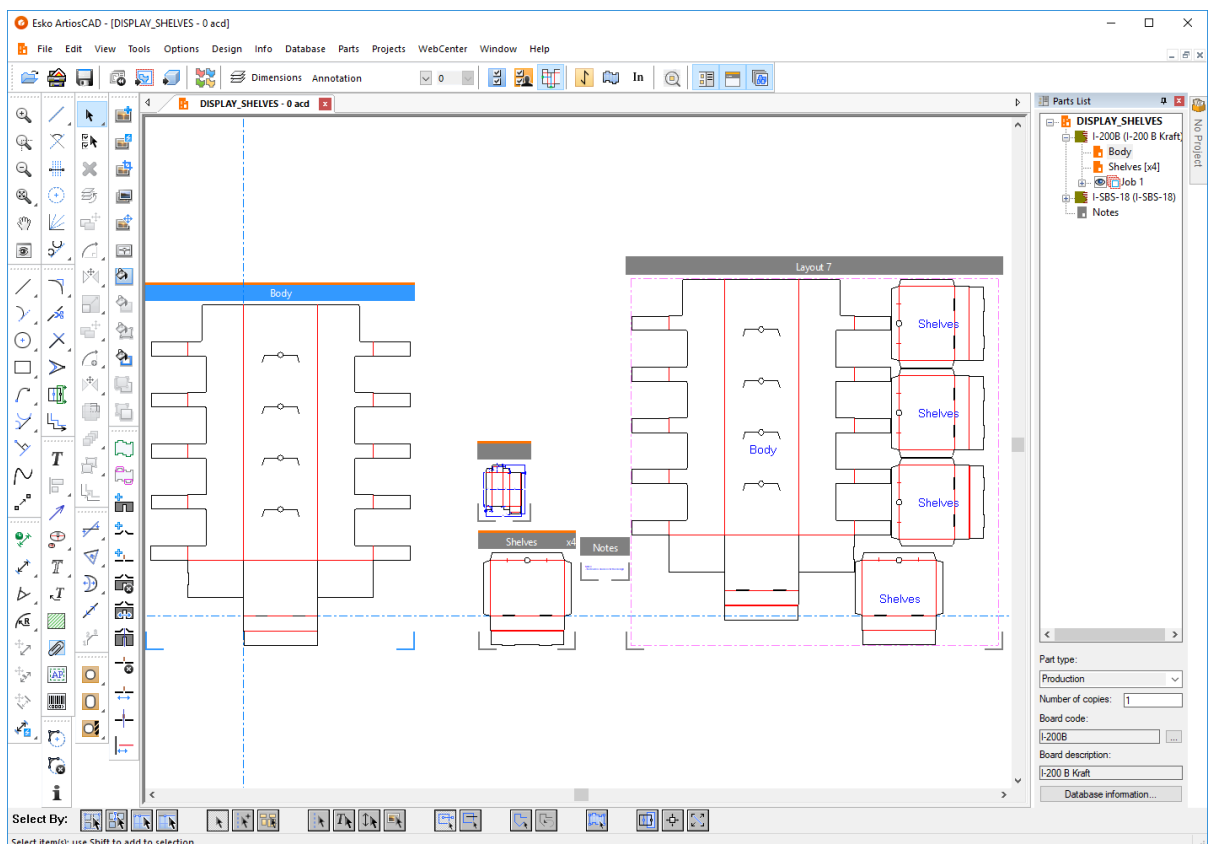

In isolation mode for part Body:

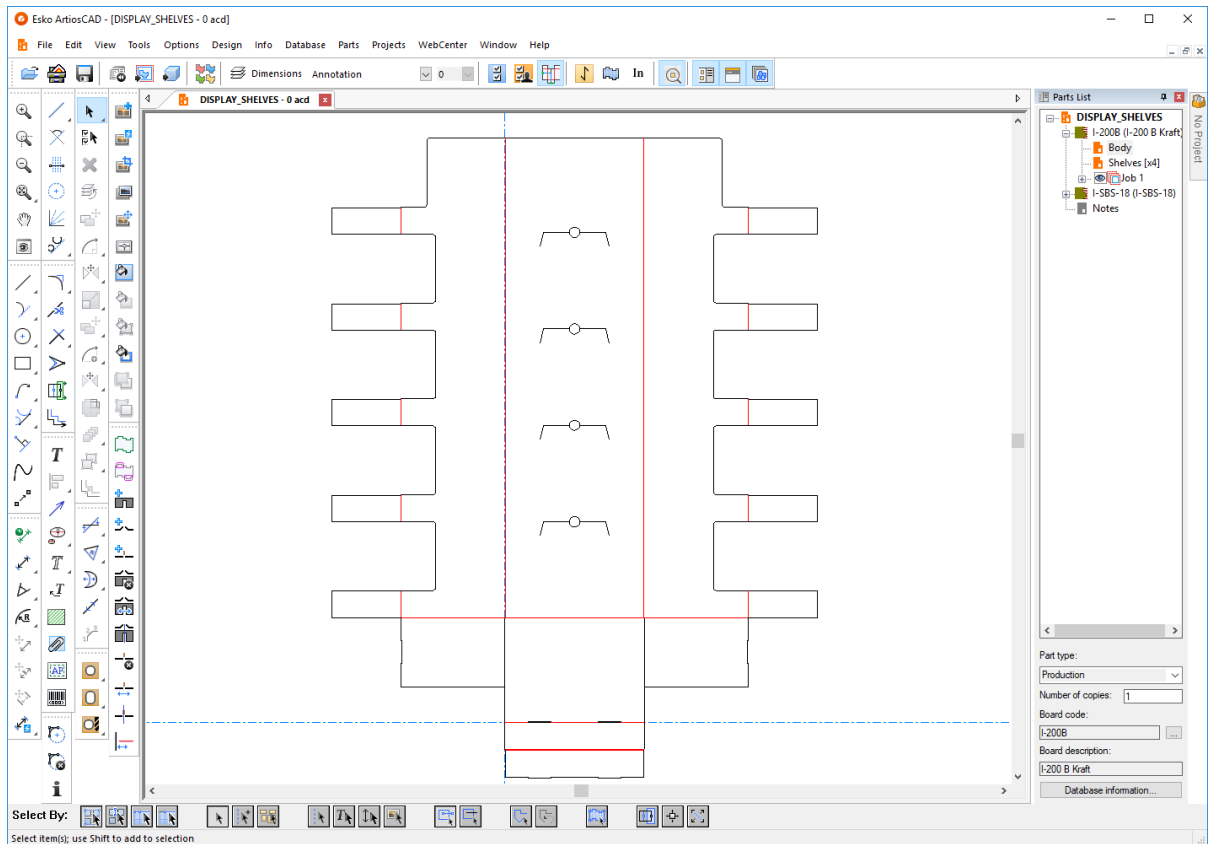

Starting isolation mode scales the view of the part to fit the window size. While you are in isolation mode, other parts of the canvas are hidden even if you zoom out. Ending isolation mode scales the view of the canvas to fit the window size.

There are four ways to start or end isolation mode:

- Click **View > Isolate Part**
- Click **Part > Isolate Part**
- Right-click the part's title bar and click **Isolate Part**
- Right-click the part's entry in the Parts List and click **Isolate Part** on the context menu.

Isolation mode supports production parts, non-production parts, and layout parts. It does not support job parts.

To change to a different part without leaving isolation mode, click that part in the Parts List.



When you end isolation mode, ArtiosCAD updates any layouts that reference that part.

Manipulating the Parts List

Pinning and Hiding

The default state of the Parts List is to auto-hide itself. When it is hidden, a Parts List tab appears for it at the top of a toolbar on the side of the drawing area to which the Parts List is docked.



To pin it to the window so it is always visible, click the pushpin icon at the right end of the Parts List's title bar . It changes to show it is pinned . To set the bar to auto-hide again, click the pushpin icon.

Detaching

The Parts List is detachable from the main window of ArtiosCAD and may be docked on either the left or right side of the drawing area. To detach it, first pin it so it does not auto-hide, then drag it by its title bar to the desired position. You can resize the Parts List as desired.

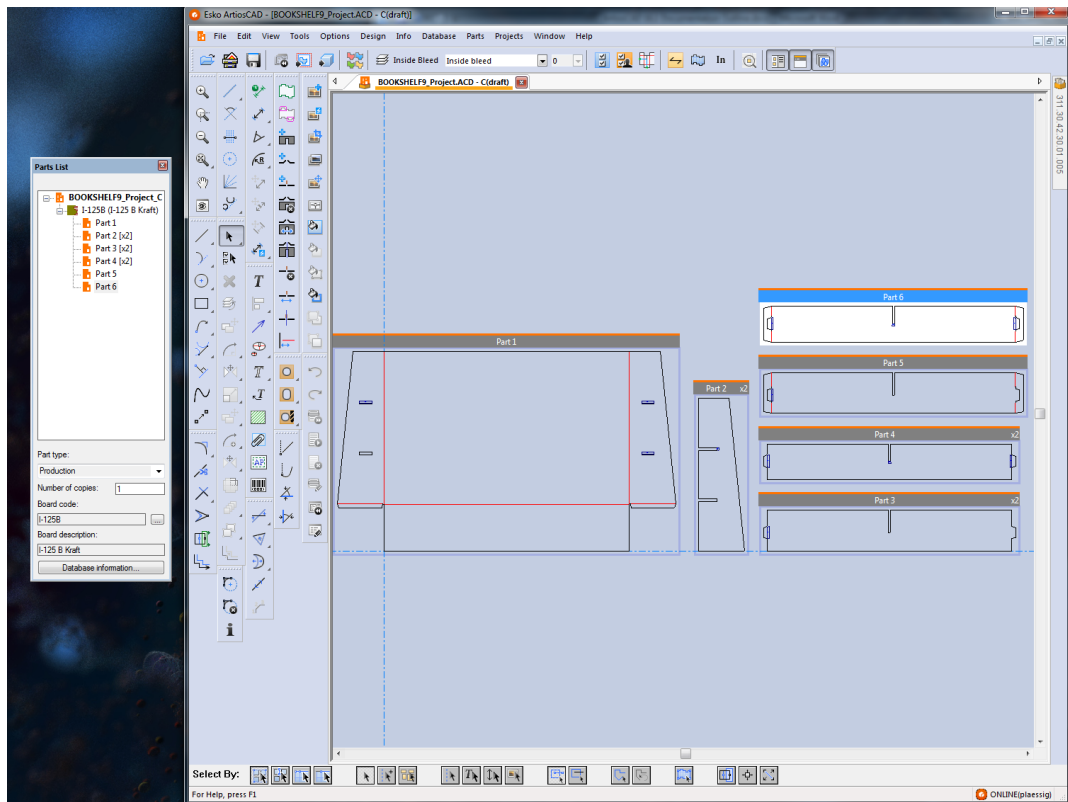

Docking

To dock the Parts List after detaching it, drag it back into the main ArtiosCAD window, and position the cursor over the arrow indicating where you want it to go. The target area turns blue.

Release the mouse button to dock the Parts List.

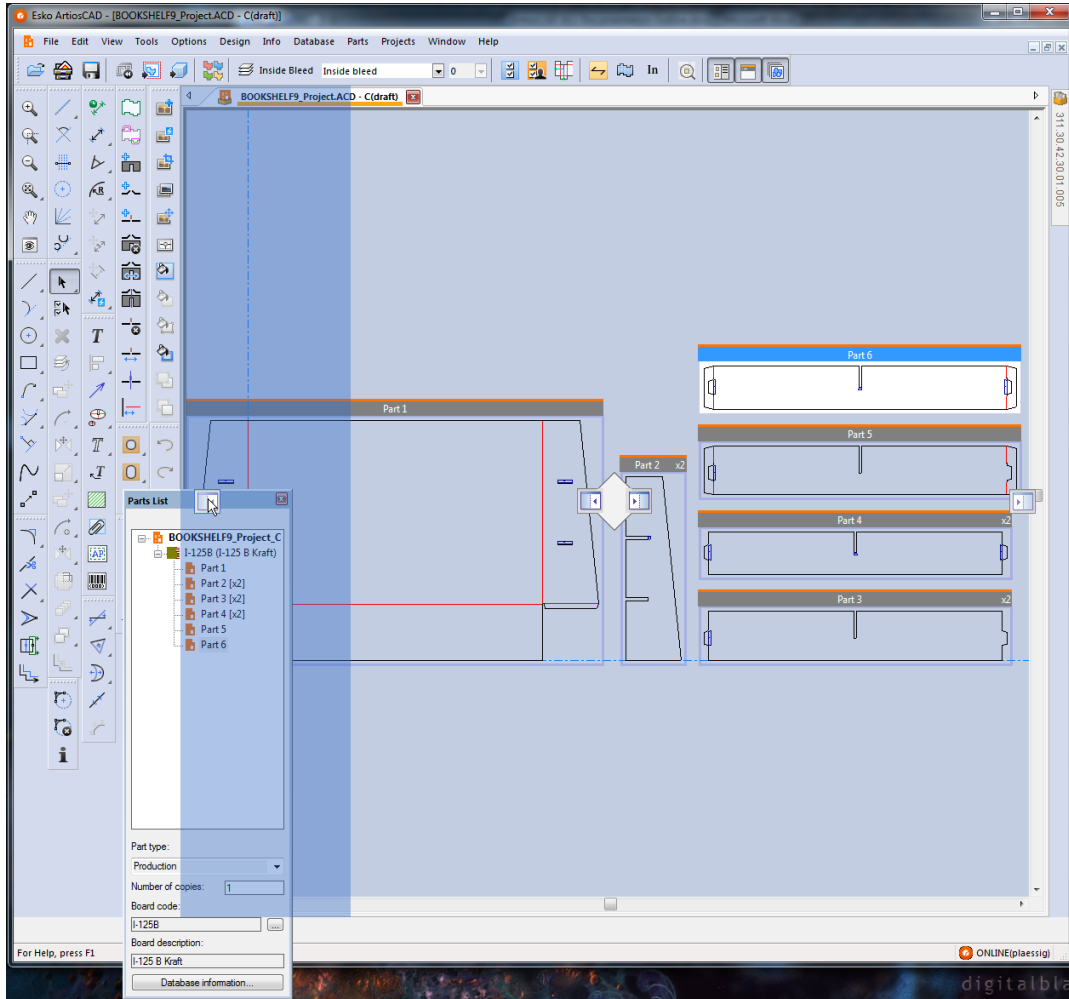

Closing and Opening

To close the Parts List, click the red X at the right end of its title bar. To open it again, click **View > Parts List**.

Using Both the Parts List and Project Bar

If you have a canvas in a Project, the Parts List and the Project Bar are independent of each other and you may manipulate them as desired. Shown below are both hidden.

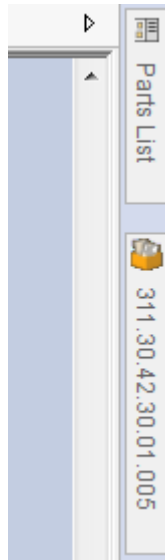

Shown below are both docked.

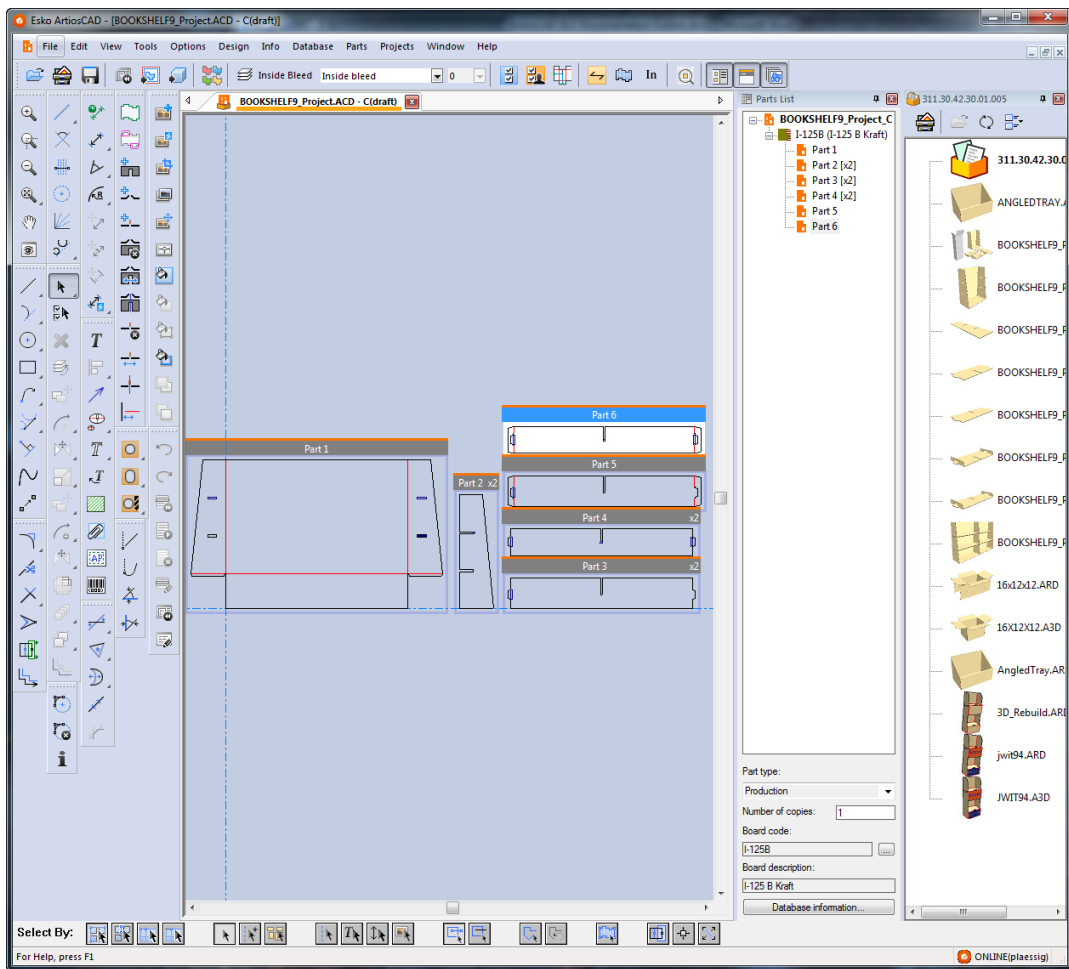

File operations

Creating a new canvas

To create a new canvas, do the following:

1. Click **File > New > Canvas**.
2. In the Single Design Settings dialog box, choose a parameter set and board, and click **OK**.
3. A blank canvas with one part of the default size for new parts appears. The current position is the origin.

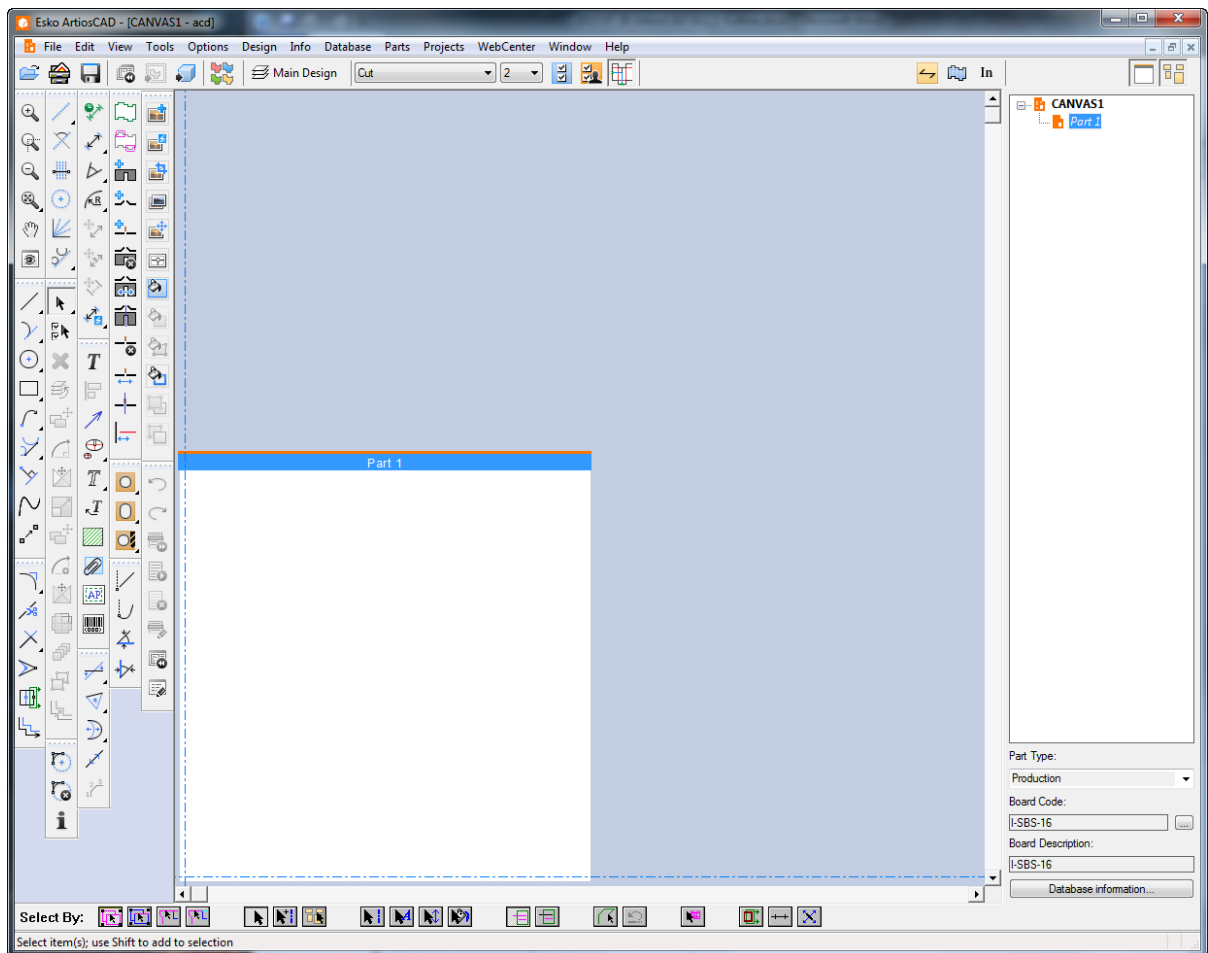

4. You are now ready to start designing as usual in Part 1.

Converting an existing design to a canvas

To convert an existing design to a canvas, do the following:

1.  With the design open, click **Convert to Canvas** on the View bar, or click **File > Convert to > Canvas**.

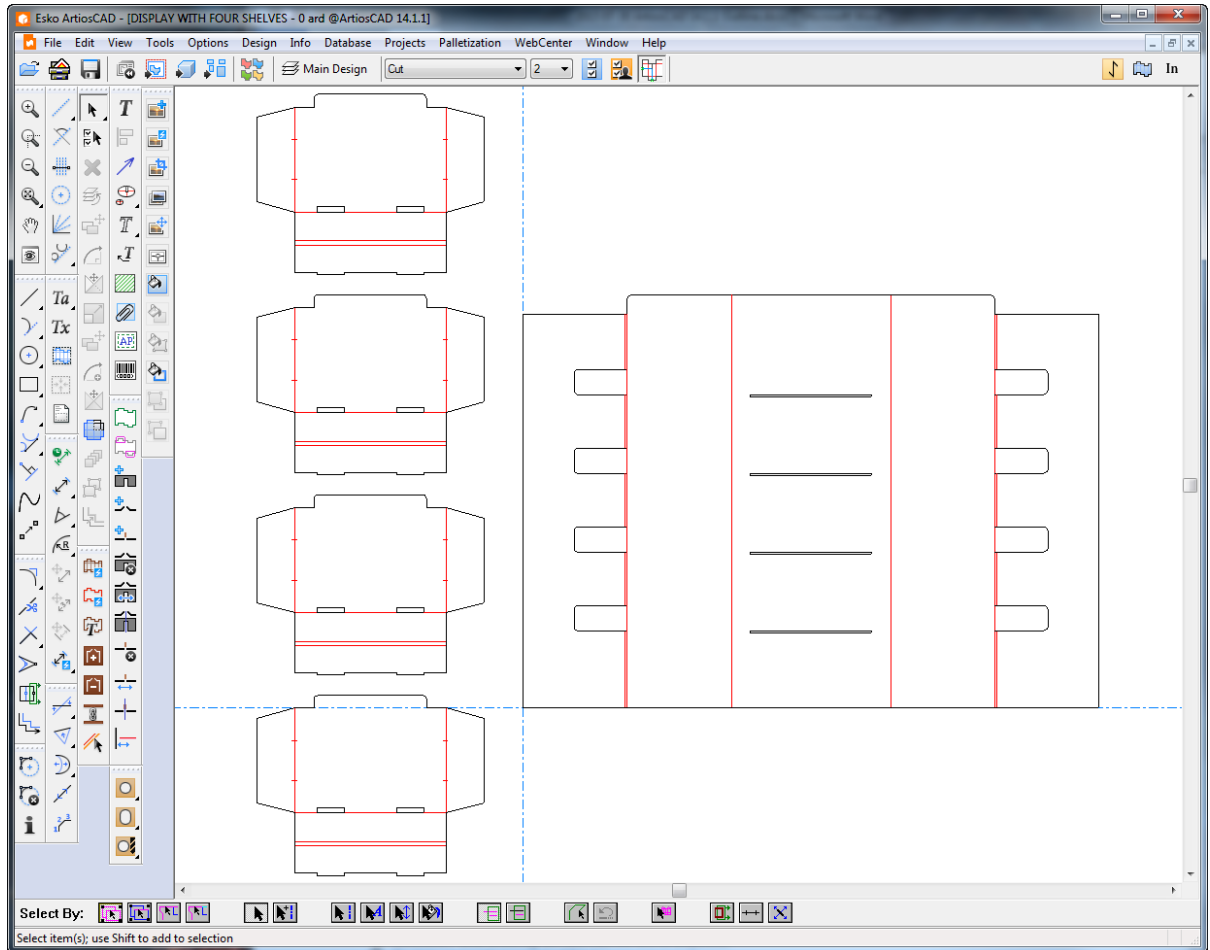

2. ArtiosCAD automatically puts the geometry into parts as needed, with the following considerations:
 - a) ArtiosCAD puts geometry that touches or overlaps into one part.
 - b) ArtiosCAD tries to consolidate multiple copies. If the design has multiple identical contours, ArtiosCAD makes one instance of the part and updates the part count as appropriate. This works best when the creator made the geometry complete before using Copy Times to make more contours. This consolidation process does not apply when the creator copied different parts of a single part separately, edited the geometry after copying it, or used the regular Copy tool instead of Copy Times. Also, files based on earlier ArtiosCAD standards may behave unpredictably with a variable number of items being placed in the wrong part. Files based on standards made after ArtiosCAD 16 should not have this problem.
 - c) ArtiosCAD numbers the parts by rows starting from the top left.
 - d) Parts are production parts if they contain non-zero length lines.
 - e) Small parts are those that are smaller than 10mm.

- f) The maximum number of parts is 149. If there are more than 149 parts, ArtiosCAD merges parts that are close together until there are fewer than 149 parts.
 - g) ArtiosCAD creates a remainder part if needed. It contains zero-length lines used for standards, remaining isolated lines, and small parts (if needed).
 - h) ArtiosCAD maintains groups during the conversion.
 - i) If dimensions span multiple pieces in the original design, this results in a larger converted part containing the spanned pieces. Check your dimensions before converting to avoid unexpected results.
 - j) ArtiosCAD creates hardware parts based on hardware placement lines.
3. ArtiosCAD turns on all layers but documentation plots and Output layers and sets the active part to part 1. You may now start drawing as desired.

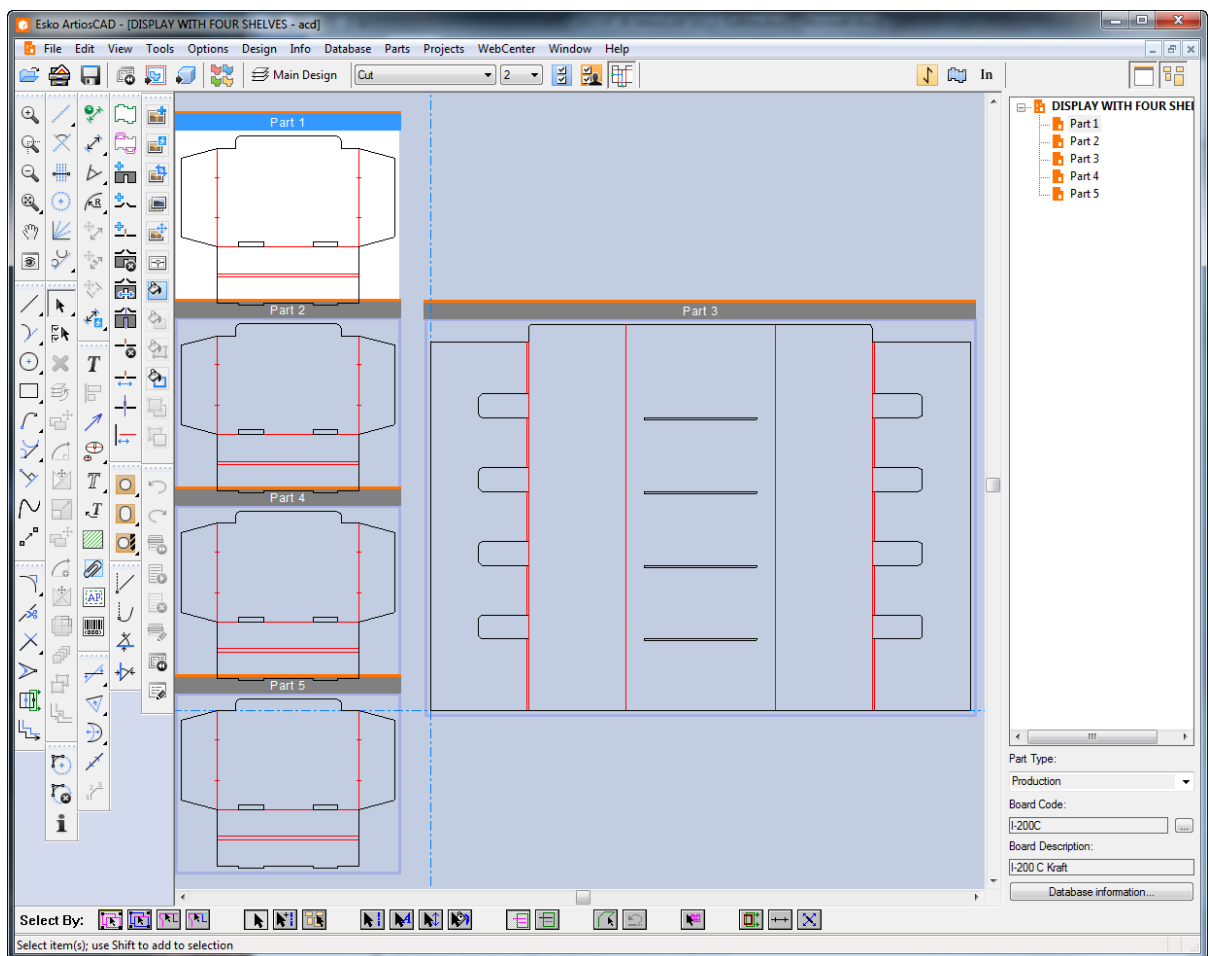

Creating a new empty part

Use one of these methods to create a new empty part:

Note: Always create parts with space between them. Do not overlap parts.

1. In a canvas, right-click over an empty spot in the canvas and click **Create Part** on the context menu.

- a) ArtiosCAD puts the lower left corner of the new part where you clicked the mouse and moves the current position to the bottom left corner of the new part, unless it would overlap another part.
 - b) If the potential new part overlaps another part, or if the cursor is within half of the default size of the potential new part plus the gutter to another part, ArtiosCAD aligns the new part either horizontally or vertically with the closest corner of the existing part.
 - c) If the new part would still overlap another part, ArtiosCAD places it at the bottom right of the canvas.
2. Right-click the canvas in the Parts List and click **Create Part**, or click **Parts > Create Part**, or right click a board in the Parts List and click **Create Part** on the context menu. ArtiosCAD will align the new part (if possible) with the bottom right of the active part, else position it at the bottom right of the canvas.
 3. ArtiosCAD names the part Part *X*, where *X* is the next part number. If you save the part as a standalone workspace, ArtiosCAD will use the part number as part of the name if your system is configured to base the part filename on the canvas.
 4. The new part appears in the Parts List with its name in grey italic to indicate it is empty.
 5. ArtiosCAD sets the new part to type Production and marks it active.

Importing a file from a standard as a new rebuildable part

To create a new rebuildable part based on a standard, do the following

1. In your canvas, click either **File > Import File > From Standard As New Rebuildable Part** or right-click the canvas in the Parts List and click **Import Standard As New Rebuildable Part**.
2. In the Standards Catalog dialog box, choose an ArtiosCAD standard (one with blue dimension lines in its icon) from the Standards Catalog and click **OK**. You can choose an earlier standard but the resulting part will not be rebuildable.

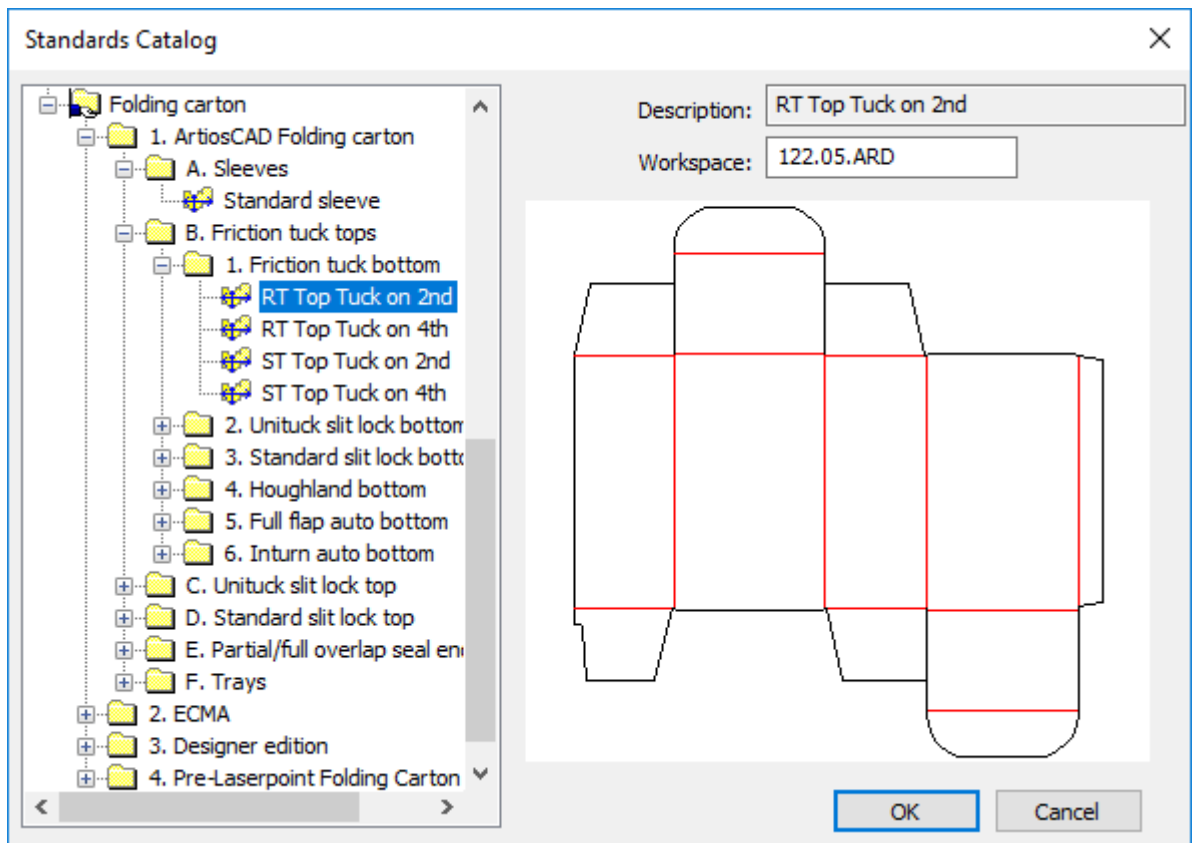

3. Choose a board for the new part. ArtiosCAD sets the units, side, and grain direction from the canvas.
4. In the Import File as New Part dialog box, ArtiosCAD shows the menus and variables for the standard, and provides options for what to do if menus or variables from this new part conflict with menus or variables that already exist in the canvas. **Make sure to set the variables' current values normally as you would when running the standard.**

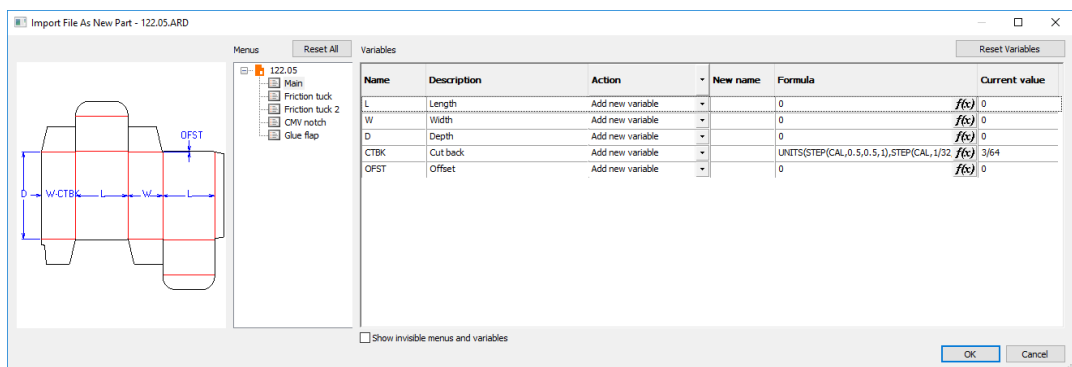

ArtiosCAD displays an information icon when there are issues you need to resolve. Hover over the icon to see a ToolTip describing the issues. In the case of a conflicting menu name, click the menu name to change it.

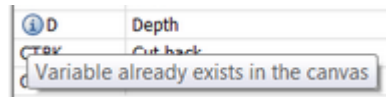
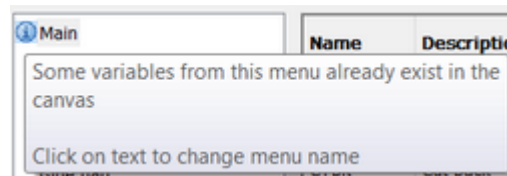

Name	Description	Action	New name	Formula	Current value
L	Length	Add new variable		0	<i>f(x)</i> 0
W	Width	Add new variable		0	<i>f(x)</i> 0
D	Depth	Add new variable		0	<i>f(x)</i> 0
CTBK	Cut back	Add new variable		UNITS(STEP(CAL, 0, 5, 0, 5, 1), STEP(CAL, 1/32	<i>f(x)</i> 3/64
OFST	Offset	Add new variable		0	<i>f(x)</i> 0

To give a variable a new name, enter the new name in the New name field. To edit a formula by hand, double-click inside the Formula field; to edit it using the Formula dialog box, click **f(x)** at the end of the Formula field. To change the current value, change it in the Current Value field. Variables which are option buttons have those options in a drop-down list in the Current Value field; set them as desired. There are three possible Actions, which you can set individually or for all using the column header:

- a) **Add variable.** Adds the variable to the canvas if it does not already exist. If it does already exist, ArtiosCAD gives it a new name by appending an instance number to the end. ArtiosCAD updates all downstream formulas that use this variable with its new name.
 - b) **Use formula or value.** Enables only the Formula field for you to enter either a new formula or value that replaces the variable. ArtiosCAD replaces future instances of this variable with the value or formula you enter and does not add the variable to the canvas.
 - c) **Use existing variable.** This option makes all other fields unavailable. ArtiosCAD uses a variable of the same name that already exists in the canvas instead of this variable. This option is available only when such a condition exists.
5. Click **OK** when you are done going through the menus and resolving issues. If there are any check conditions which are not satisfied, ArtiosCAD prompts you to resolve them.

This results in a rebuildable part becoming part of the canvas. When you rebuild the canvas, a node for this part will appear in the rebuild tree.

When you import a standard as a new part, ArtiosCAD observes the following limits:

- The maximum number of special rules in the part is 39.
- The maximum number of fonts in the part is 39.
- The maximum number of colors in the new part is 999.

Importing a file as a new rebuildable part

To import an existing resizable ArtiosCAD design as a new rebuildable part, do the following:

1. Click **File > Import File > As New Rebuildable Part**, or right-click the canvas in the Parts List and click **Import File as New Rebuildable Part**. This merges the single design's menus, variables, and log file into the canvas'.
2. Depending on the type of ArtiosCAD you are using, the file selection dialog box or the file browser appears, pre-seeded to files of type **Artios Design (*.ARD)**. Select the file to import, and click **Open**. If you select multiple files, ArtiosCAD processes them sequentially and you will loop through the import process for as many times as files you selected.
3. In the Import File as New Part dialog box, set the variables in the menus as desired. If this is not the first rebuildable part in the canvas, there may be name collisions for many of the menus and variables. Hover over the information icons to see the issues and resolve them. Click **OK** when you have reviewed all menus and variables.
4. If the active part is empty, ArtiosCAD imports the file into the active part; otherwise, ArtiosCAD places the new part at the bottom right of the canvas and makes it active.
5. ArtiosCAD puts the contents of the imported file's layers (if any) into the layers of the canvas.
 - a) If the same layer name and layer class already exists, ArtiosCAD puts the imported file's layer contents in that layer. Layer names are case-sensitive.
 - b) ArtiosCAD will create the layer if necessary.
 - c) All layers of the new part are unlocked, even if those layers are locked in other parts.
6. The part keeps the board code of the original file.

When you import a file as a new part, ArtiosCAD observes the following limits:

- The maximum number of special rules in the part is 39.
- The maximum number of fonts in the part is 39.
- The maximum number of colors in the new part is 999.

If the file you are importing contains hardware placement lines, ArtiosCAD checks if the canvas already contains the hardware part. If it does not, and ArtiosCAD can find the hardware part workspace, ArtiosCAD adds the hardware part to the canvas with a part count of 1.

You can **Undo** an import like this once, only before making changes such as changing geometry or menus.

Use **Rebuild Playback** to see what happens during rebuild. ArtiosCAD turns on Isolation Mode for this part during Rebuild Playback. Do not add geometry while in Rebuild Playback. However, you may change expressions and formulae if desired.

Importing a file as a new static part

To import an existing file as a new static (non-resizable) part, do the following:

1. Click **File > Import File > As New Static Part**, or right-click the canvas in the Parts List and click **Import File as New Static Part**.
2. Depending on the type of ArtiosCAD you are using, the file selection dialog box or the file browser appears, pre-seeded to files of type **Artios Design (*.ARD)**. Supported file types extensions include .ARD, .CF2, .DS2, .DD3, .DXF, .DWG, .PDF, and .AI Change the selector if desired, select the file(s) to import, and click **Open**. If you select multiple files, ArtiosCAD

processes them sequentially and you will loop through the import process for as many times as files you selected.

3. If you chose a file that uses import tuning, the appropriate tuning dialog box appears.
4. If the active part is empty, ArtiosCAD imports the file into the active part; otherwise, ArtiosCAD places the new part at the bottom right of the canvas and makes it active.
5. ArtiosCAD puts the contents of the imported file's layers (if any) into the layers of the canvas.
 - a) If the same layer name and layer class already exists, ArtiosCAD puts the imported file's layer contents in that layer. Layer names are case-sensitive.
 - b) ArtiosCAD will create the layer if necessary.
 - c) All layers of the new part are unlocked, even if those layers are locked in other parts.
6. If the imported file is a single design, the part gets the same board code as the original single design.

When you import a file as a new part, ArtiosCAD observes the following limits:

- The maximum number of special rules in the part is 39.
- The maximum number of fonts in the part is 39.
- The maximum number of colors in the new part is 999.

If the file you are importing contains hardware placement lines, ArtiosCAD checks if the canvas already contains the hardware part. If it does not, and ArtiosCAD can find the hardware part workspace, ArtiosCAD adds the hardware part to the canvas with a part count of 1.

You can **Undo** and **Redo** the import of a static part as many times as desired.

Importing a file as a new part reference

To import an existing file as a new part reference, which is a link to an existing design that is marked read-only, do the following:

1. Click **File > Import File > As New Part Reference**, or right-click the canvas in the Parts List and click **Import File As New Part Reference**.
2. Depending on the type of ArtiosCAD you are using, the file selection dialog box or the file browser appears, pre-seeded to files of type **Artios Design (*.ARD)**. Change the selector if desired, select the file to import, and click **Open**.
3. If you chose a file that uses import tuning, the appropriate tuning dialog box appears.
4. If the active part is empty, ArtiosCAD imports the file into the active part; otherwise, ArtiosCAD places the new part at the bottom right of the canvas and makes it active.
5. ArtiosCAD puts the contents of the imported file's layers (if any) into the layers of the canvas.
 - a) If the same layer name and layer class already exists, ArtiosCAD puts the imported file's layer contents in that layer. Layer names are case-sensitive.
 - b) ArtiosCAD will create the layer if necessary.
 - c) All layers of the new part are locked, even if those layers are unlocked in other parts.
6. All aspects of the new part reference are locked. A lock icon appears in the Parts List next to the part name as well as in the title bar of the part to show it is locked. All tools display the No cursor while that part is active.

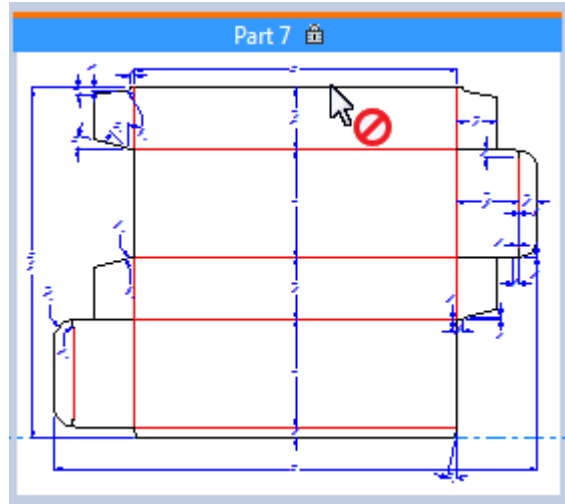
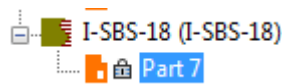

What you *can* do is use points in the locked part reference as reference points while using tools in other unlocked parts. You can also move the entire part.

When you import a file as a new part reference, ArtiosCAD observes the following limits:

- The maximum number of special rules in the part reference is 39.
- The maximum number of fonts in the part reference is 39.
- The maximum number of colors in the new part reference is 999.

If the file you are importing contains hardware placement lines, ArtiosCAD checks if the canvas already contains the hardware part. If it does not, and ArtiosCAD can find the hardware part workspace, ArtiosCAD adds the hardware part to the canvas with a part count of 1.

To view the path of the read-only part reference in the future, open the Save Parts dialog box.

When you export parts using **Save As** or **Save As Revision**, ArtiosCAD updates the link to the read-only part. However, when you use **Save As** on the canvas itself, ArtiosCAD does not update the path for referenced parts.

Importing a file as a new rebuildable part reference

Importing a file as a rebuildable part reference is just like importing a file as a regular part reference. The imported part is read-only and, at first, not resizable. To make it resizable, you must make it writable first. To import a file as a rebuildable part reference, do the following

1. In your canvas, click either **File > Import File > As New Rebuildable Part Reference** or right-click the canvas in the Parts List and click **Import File As New Rebuildable Part Reference**.
2. In the Import File As New Rebuildable Part Reference dialog box, navigate to the file(s) to import and click **Open**. You may select more than one file; ArtiosCAD will loop through the import process as many times as needed.
3. In the Import File As New Part dialog box, hover over the information icons in each menu as needed and fix the issues as required. Click **OK** when you have resolved all the issues.

4. If the active part is empty, ArtiosCAD imports the file into the active part; otherwise, ArtiosCAD places the new part at the bottom right of the canvas and makes it active.
5. ArtiosCAD puts the contents of the imported file's layers (if any) into the layers of the canvas.
 - a) If the same layer name and layer class already exists, ArtiosCAD puts the imported file's layer contents in that layer. Layer names are case-sensitive.
 - b) ArtiosCAD will create the layer if necessary.
 - c) All layers of the new part are locked, even if those layers are unlocked in other parts.
6. All aspects of the new part reference are locked. A lock icon appears in the Parts List next to the part name as well as in the title bar of the part to show it is locked. All tools display the No cursor while that part is active.

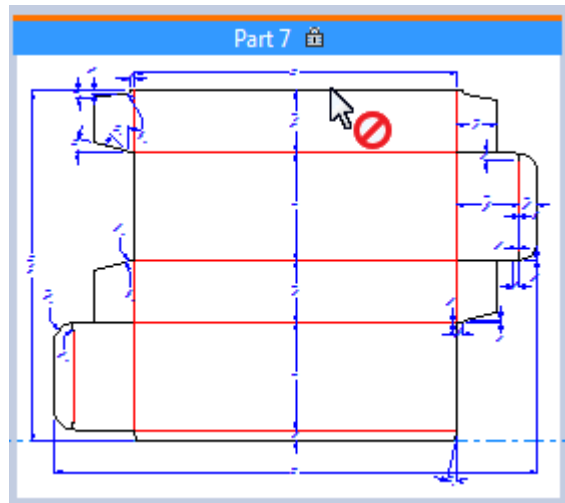
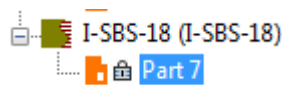

What you *can* do is use points in the locked part reference as reference points while using tools in other unlocked parts. You can also move the entire part.

7. Presumably you want to make this part rebuildable. Right-click it in the Parts List and click **Make Writable**.
8. ArtiosCAD recognizes that this is a reference to a resizable design and prompts you to decide what to do.

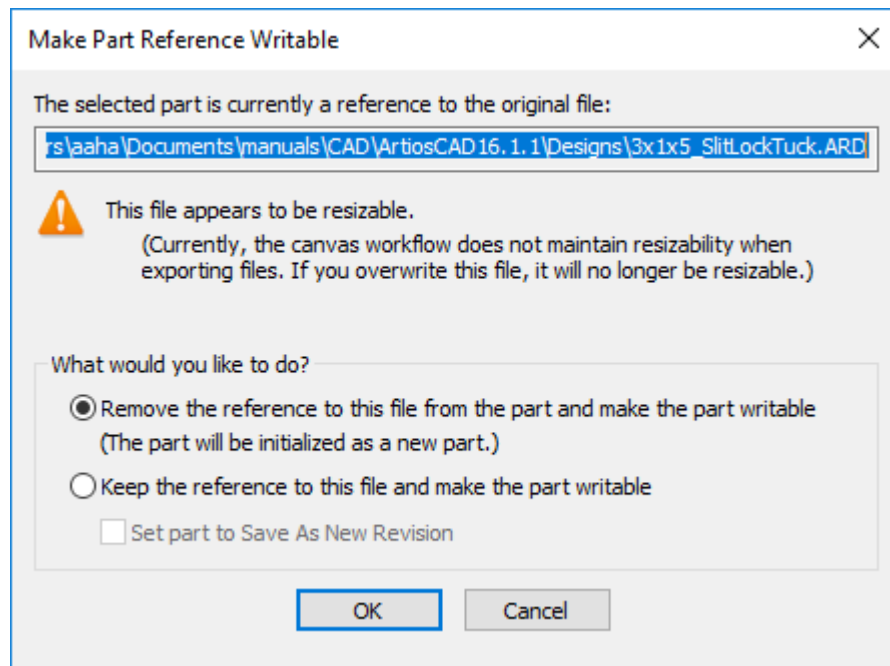

- a) The default action is **Remove the reference to this file from the part and make the part writable**. This essentially inserts a standalone version of the referred file as a new part so ArtiosCAD can rebuild it. This option is always selected and there is no setting in Defaults to control it as it is considered dangerous to change it.
- b) **Keep the reference to this file and make the part writable** has the potential to **MODIFY THE ORIGINAL FILE WHEN YOU REBUILD THE CANVAS**. Use this option with caution. To mitigate the danger, you can choose to **Set part to Save As New Revision**, which is the default behavior when you choose this option. If you export this part that is still a reference, the first time, the action is set to **Save as New Revision**, and then future exports are set to **Overwrite Existing**, but you can change those actions as desired.
- c) Click **OK** to finish importing the file as a rebuildable part reference.

Deleting a part

To delete a part, do one of the following:

1. Right click the name of the part in the Parts List and click **Delete Part**.
2. Make sure the part you want to delete is the active part and click **Parts > Delete Active Part**.
3. Right-click inside the part over a blank space so that it turns magenta and click **Delete Part** on the context menu.

Saving a canvas

When you save a canvas, you can choose to be prompted to save the parts to individual ArtiosCAD workspaces (the default), to save modified parts automatically to individual workspaces, or to leave the parts as self-contained entities in the canvas document.

Note: If you are using ArtiosCAD Standard Edition, **Publish to WebCenter** is not available for canvases.

1.  Design the canvas as desired and click **File > Save**, or click **Save** on the View bar.
2. ArtiosCAD prompts you to pick a location and set the filename, or you can use auto-naming if it is available for your chosen location. Save the file in your desired way.
3. Set the database information for the canvas and click **OK**. If you save the parts individually, they will inherit the Customer, Owner, Salesperson, and Designer you set for the canvas.
4. If your ArtiosCAD is set to save parts while saving a canvas, ArtiosCAD will prompt you to save the parts. See *Saving Parts* for more information.

The Defaults that control the savings of parts when saving a canvas are in **Options > Defaults > Startup options > Canvas/Parts Options**.

Saving parts

Parts can exist only within the canvas, or you can save them to individual ArtiosCAD workspaces if you want to work on them independently. If you work on them independently, ArtiosCAD will prompt you to synchronize the canvas versions with the individual versions the next time you open the canvas.

Note: You must save the canvas before you can save parts individually. **Save Parts** is unavailable until you save the canvas.

1. If you are using the default settings, ArtiosCAD opens the Save Parts dialog box.

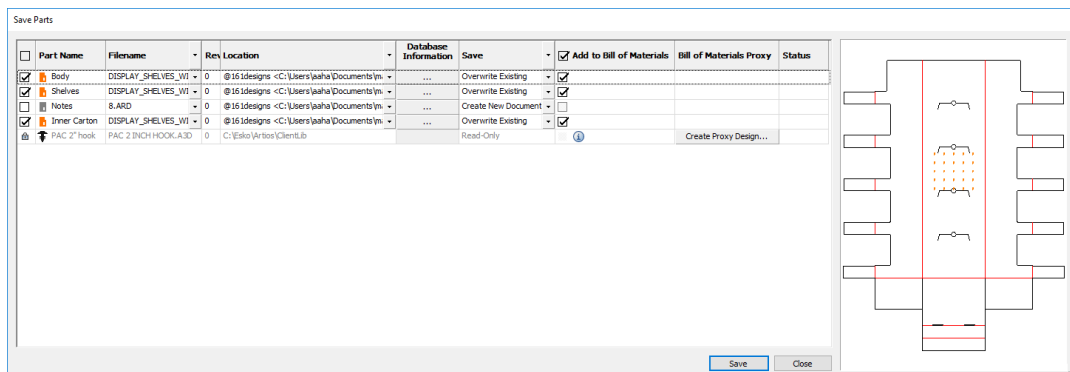

- a) ArtiosCAD selects all Production parts by default for saving. Their icons are orange. Non-production parts are not selected and their icons are gray. Read-only parts are listed but are unavailable, and hardware parts are not exportable. ArtiosCAD automatically selects those parts that have changed since the last save. Toggle all the parts' selection for saving or not saving by clicking the checkbox in the column header.
- b) In the Filename column, ArtiosCAD bases the part filename off either the part name or the canvas filename, depending on your Defaults configuration. If your system uses the part name, the filename is the part name with the ArtiosCAD file type extension. If your system uses the canvas filename, the part filename is set to the canvas filename, followed by a delimiter and then the number of the part. If the location at which you are saving the part supports it, you can click the drop-down list box activator at the end of the field and pick **Autoname** (for a resource or Project) or **Autogenerate (Canvas)**

- or **Autogenerate (Part)** (based on the location in which you are saving the canvas). To set the action for all the filenames at once, click the drop-down list box activator in the column header. For ArtiosCAD Enterprise, the canvas will be version 2 if you choose to autogenerate the name. If you choose to Autaname or Autogenerate, ArtiosCAD updates the filename appropriately. You may also double-click the filename to manually edit it as desired if it is not being generated automatically. Note that referenced parts use different filenames.
- c) If you are using ArtiosCAD Enterprise, and if the Project in which you are saving the parts supports autonaming AND supports a suffix, the Suffix column allows you to set it.
 - d) The Revision column shows the revision character for the part.
 - e) In the Location column, choose where to save the part. ArtiosCAD seeds the location to where you are saving the canvas, but you can choose a different location for each part. To set the location for all the locations at once, click the drop-down list box activator in the column header. You may:
 - **Browse For Folder** (in ArtiosCAD Standard Edition)
 - **Select Resource** (in ArtiosCAD Standard Edition)
 - **Use Canvas Directory** (in ArtiosCAD Standard Edition)
 - **Browse** (in ArtiosCAD Enterprise, which opens the browser)
 - **Use Canvas Location** (in ArtiosCAD Enterprise)
 - f) In the Database Information column, click More Options (...) to open the Parts Database Information dialog box. The Length, Width, and Depth fields are **for information only** and are **not structurally effective**. This is why they are editable.
 - g) The Save column shows the result of ArtiosCAD evaluating the action it will take. The available actions in this column when you click the drop-down list-box activator are **Save**, which overwrites an existing document, or **Save As New Revision**. If you choose **Save as New Revision**, you must enter a comment, and if this is not the first save, an option to update all BOMs with this revision appears. As with the other columns, set the actions for all the parts by clicking the drop-down list box activator in the column header. The potential results are listed below.
 - **Create New Document**. The destination document does not exist yet.
 - **Overwrite Existing**. The destination document already exists and ArtiosCAD will replace it.
 - **Currently Open**. The destination document is already open as an independent workspace. Close it before saving the part.
 - **Disk File Newer**. The independent version has been saved since you tried to save the part.
 - h) The Add to Bill of Materials column controls if ArtiosCAD adds the part to the BOM.
 - i) The Bill of Materials Proxy column controls if rArtiosCAD creates a proxy design for a hardware part for use on a BOM. If you click a column entry, you can specify the resource in which ArtiosCAD creates the proxy design and its filename.
 - j) The Status column shows the progress of the save.
2. Click **Save**. When you click Save:

- A progress bar appears.
 - **Stop** replaces **Save** and **Close**.
 - ArtiosCAD updates the Status column for each part.
3. When the save process completes, ArtiosCAD shows a status message showing if there were any errors. Click **Close** to close the Save Parts dialog box.

After saving a part, the path for it does not change when you save the canvas in a new location. Timestamps and paths can be inconsistent if you save parts and not the canvas thereafter. This usually results in the status of Disk File Newer.

When canvas parts contain hardware holes and hardware placement lines, ArtiosCAD copies them to exported parts. If you convert those exported parts to 3D, however, ArtiosCAD does not repopulate the hardware parts; that happens only in canvases.

Saving revisions

Saving revisions of canvases and parts in ArtiosCAD Standard Edition requires that **Base filename is earliest revision** be selected in **Options > Defaults > Startup defaults > Revision Disk File Format**.

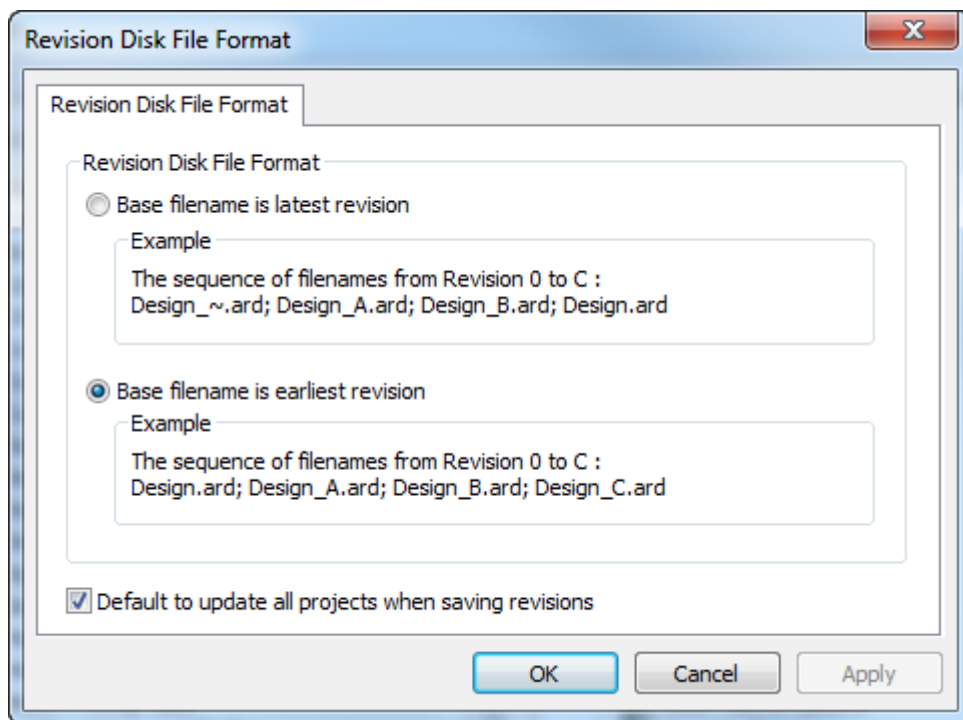

You may not save revisions if that option is set to **Base filename is latest revision**. **Default to update all projects when saving revisions** controls if ArtiosCAD Standard Edition updates other Projects containing an individual part workspace with the new revision.

When you save a revision of a canvas in ArtiosCAD Standard Edition, there is an option to **Also save parts as revisions**. This option is selected by default.

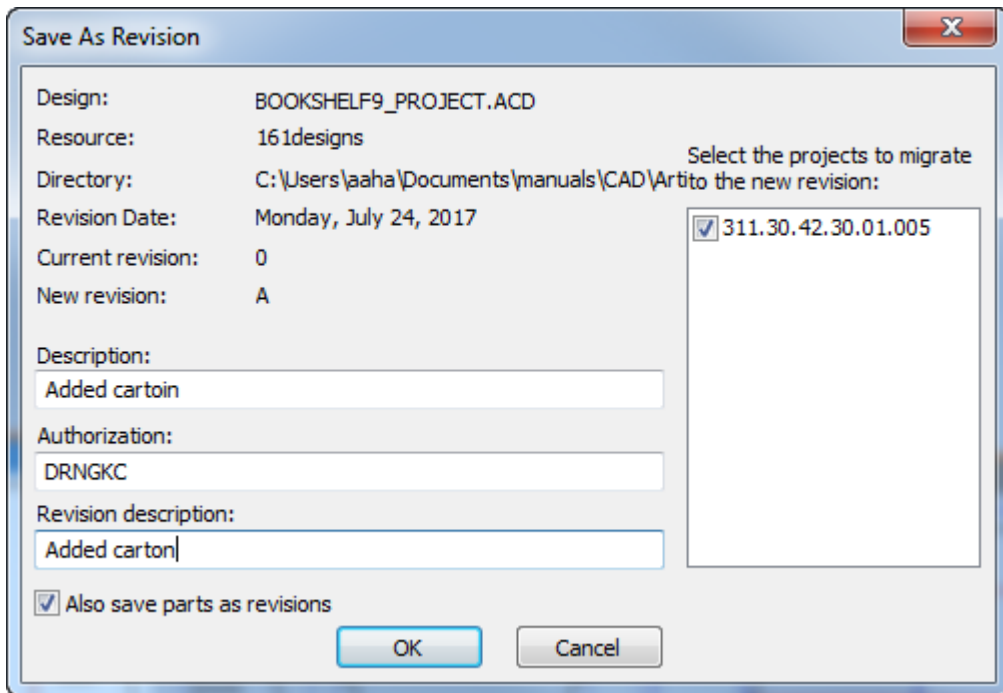

If you leave this option selected when you click **OK**, ArtiosCAD opens the Save Parts dialog box with additional information for the revisions. ArtiosCAD seeds the Revision Description and Authorization fields from the Save As Revision dialog box, but you can change them for each part as desired by selecting the part and changing them. You can also choose to add the parts to the BOM or not if this is the first time you are saving them.

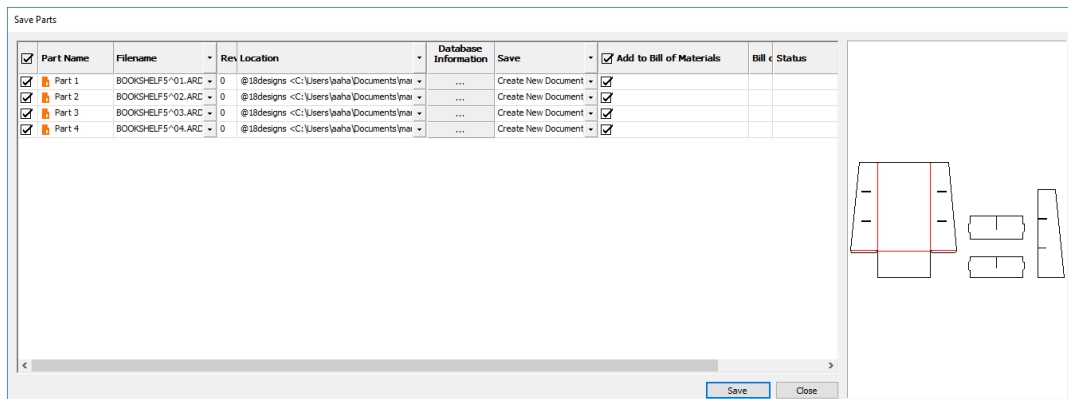

Click **Save** to begin saving the parts. Click **Close** when done, and then click **OK** in the Canvas Database Information dialog box.

If you are using ArtiosCAD Enterprise, the procedure is similar. When you click **Publish Revision**, in the Save Managed Document dialog box is **Also Save Parts As Revisions**.

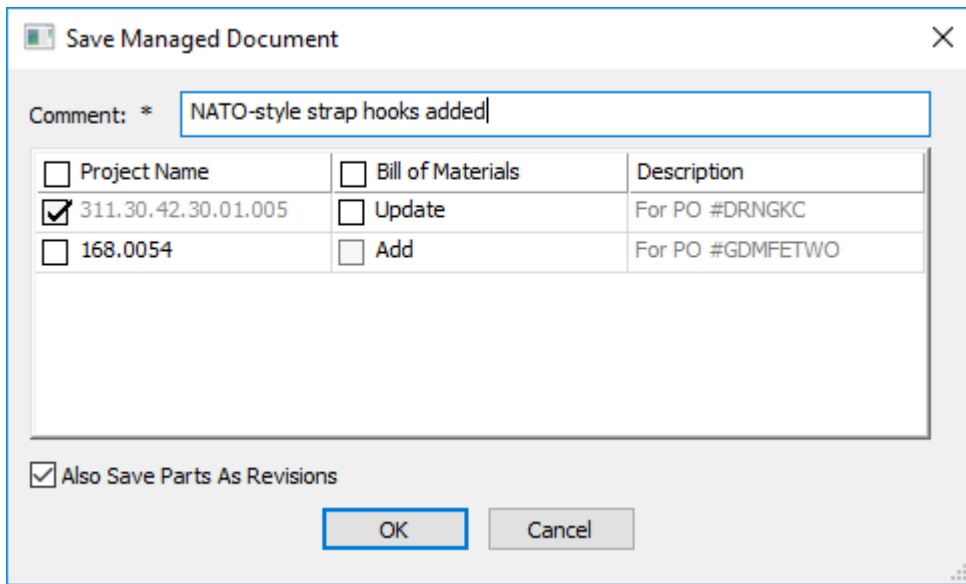

ArtiosCAD Enterprise then prompts you to set the canvas database information, and when you click **OK**, opens the Save Parts dialog box. ArtiosCAD Enterprise seeds the Comment field for each part from the Canvas Database Information dialog box, but you can change it for each part as desired by selecting the part and changing it. The **Add to Bill of Materials** column controls whether the new revision of a part is used on a BOM on which that part appears.

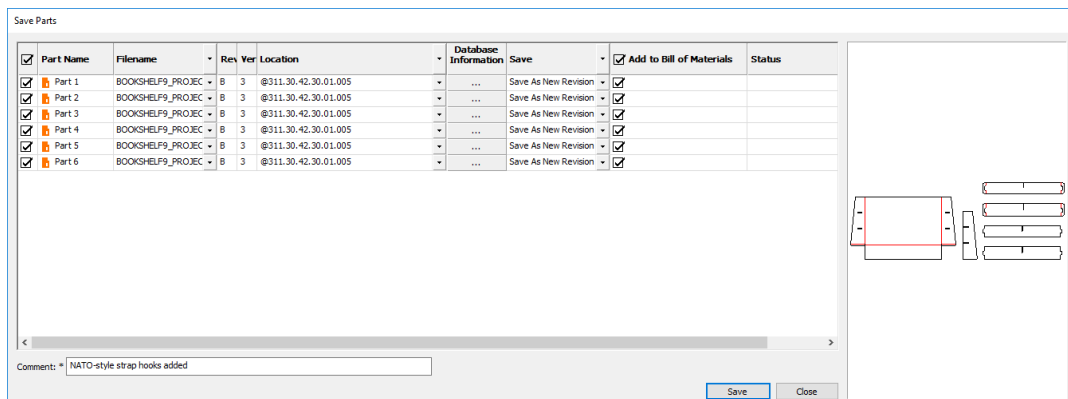

Click **Save** to begin saving the parts. Click **Close** when done.

In ArtiosCAD Enterprise, to control if other Projects containing parts workspaces are updated with new revisions, use **For linked documents, default to 'Update All Related Projects'** in **Options > Defaults > Startup defaults > Save Options**.

Opening a canvas in ArtiosCAD Standard Edition

To open a canvas in ArtiosCAD Standard Edition, do the following:

1.  Click **Open** on the View bar if you already have a document open or click **File > Open**.
2. In the Open dialog box, use either **Directory View** or **Resource View** to navigate to the desired location. By default, the Files of type selector is set to **Designs**, which includes canvases.

3. Click the desired canvas. ArtiosCAD shows a preview as with a single design.

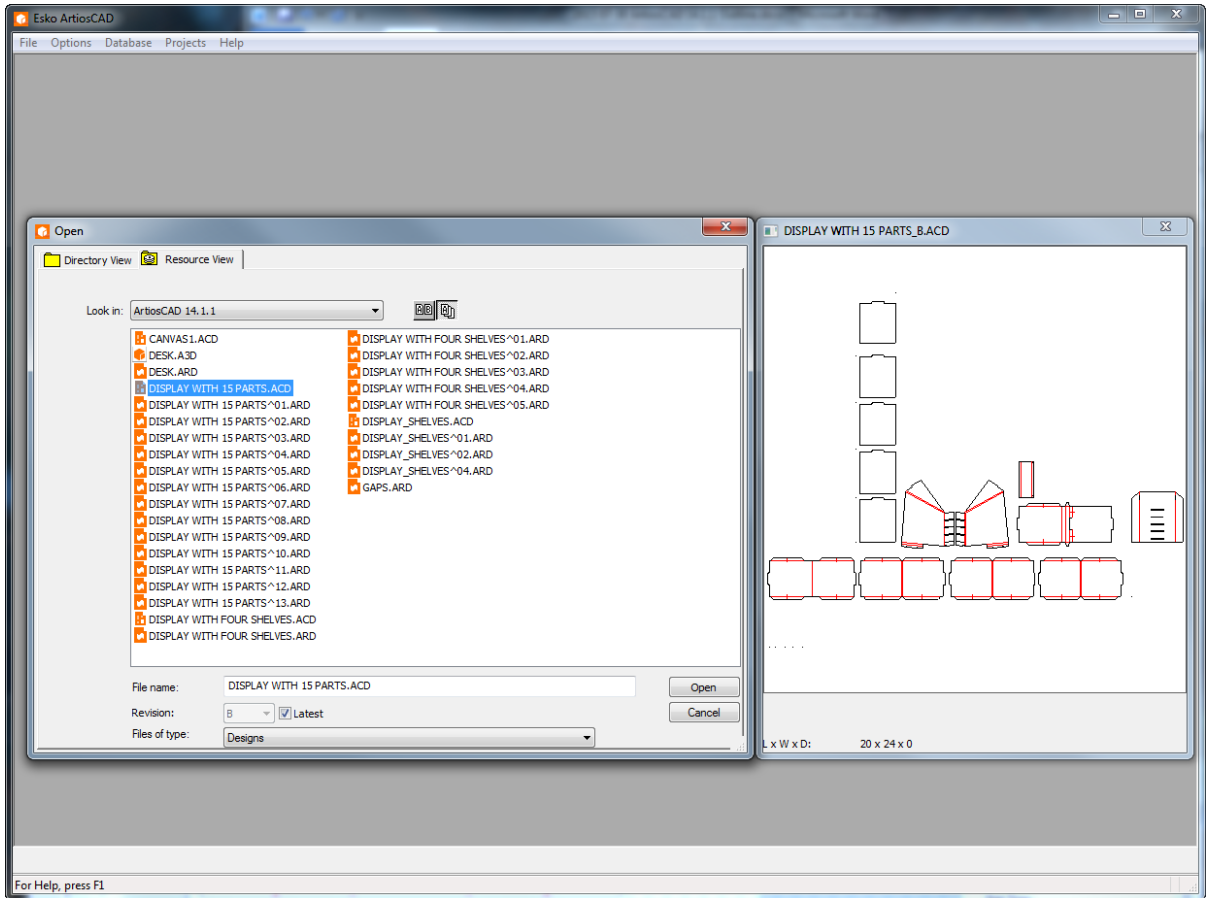

4. Click **OK** to open the canvas.
5. ArtiosCAD checks to see if any parts in the canvas have been saved as independent workspaces, and if they are different, prompts you to choose which version to use. See *Synchronizing Parts* for more information.
6. If the parts have not changed, ArtiosCAD opens the canvas.

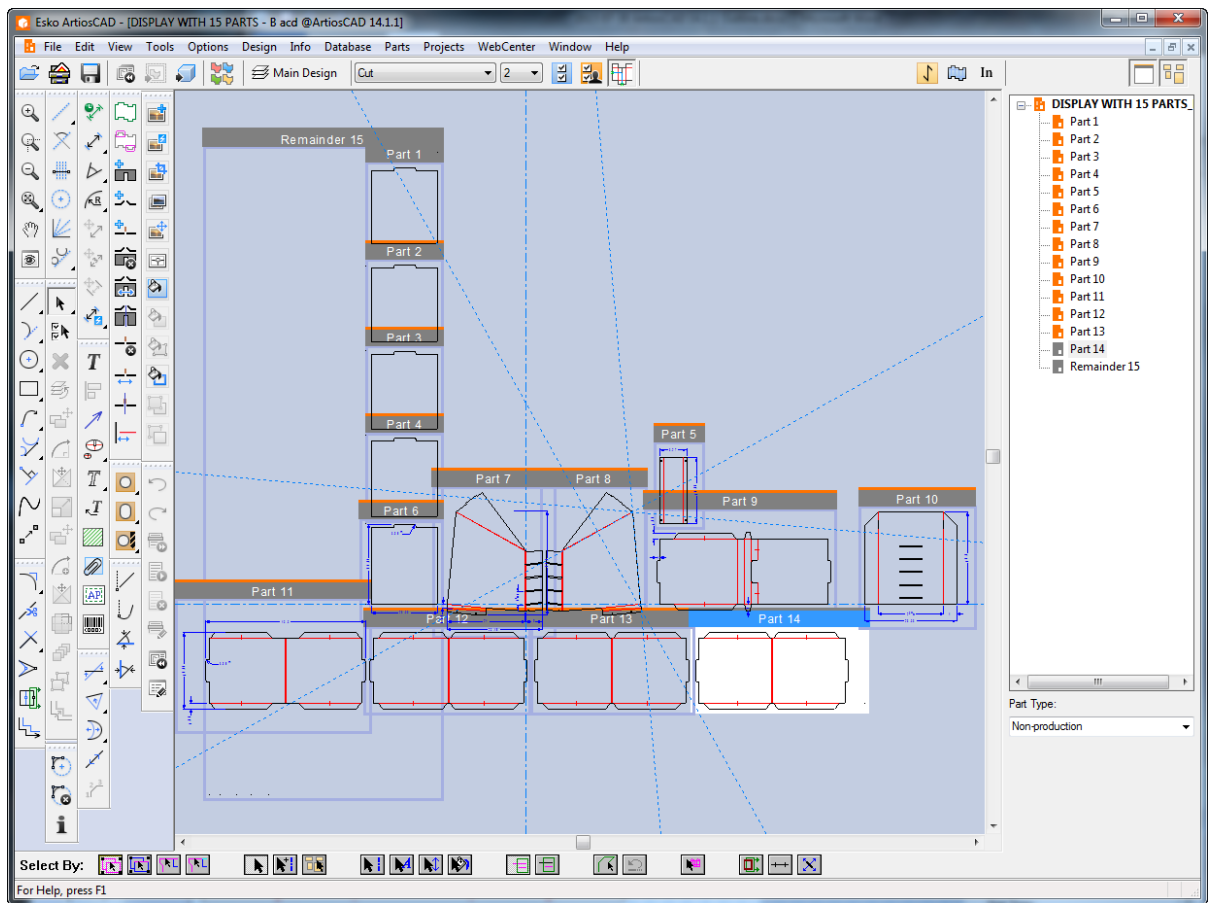

Opening a canvas in ArtiosCAD Enterprise

To open a canvas in ArtiosCAD Enterprise, do the following:

1.  Click **Browser** on the View bar if you already have a document open or click **File > Browser**.
2. Navigate to the desired Project and folder containing the canvas to open. By default, the Files of type selector is set to **Designs**, which includes canvases.
3. Click the desired canvas. ArtiosCAD Enterprise shows a preview in the preview pane.

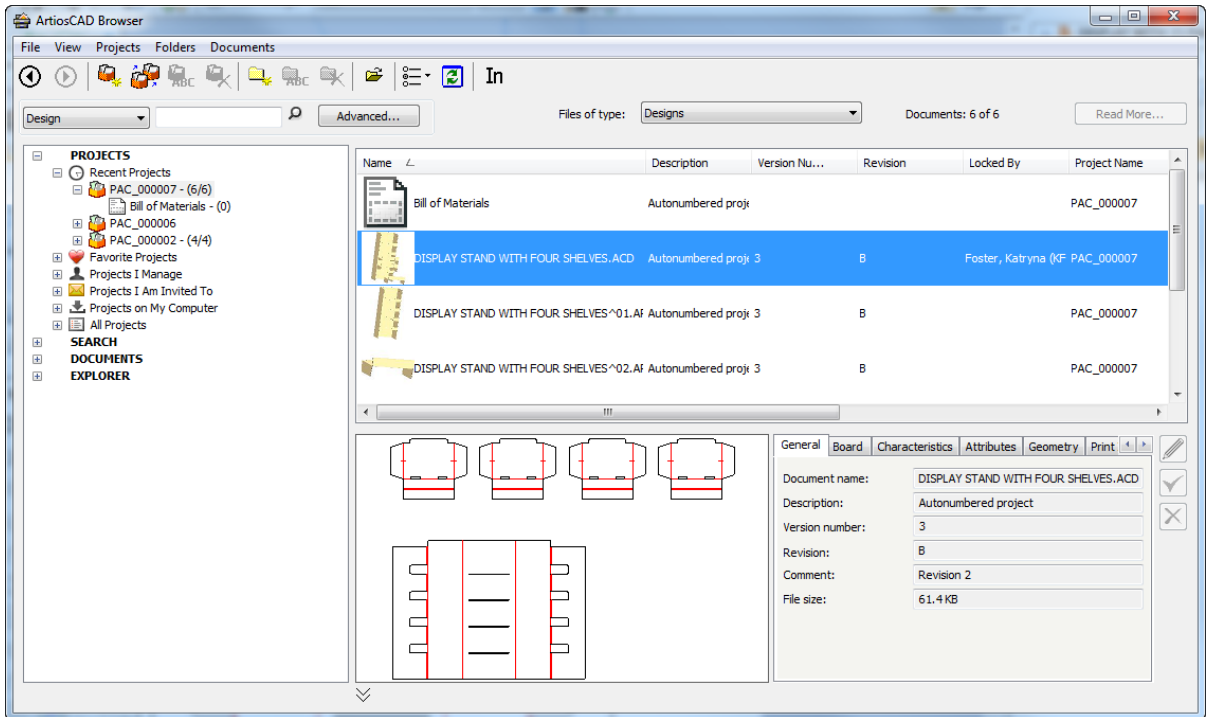

4. Double-click the canvas to open it.
5. ArtiosCAD Enterprise checks to see if any parts in the canvas have been saved as independent workspaces, and if they are different, prompts you to choose which version to use. See *Synchronizing Parts* for more information.
6. If the parts have not changed, ArtiosCAD Enterprise opens the canvas.

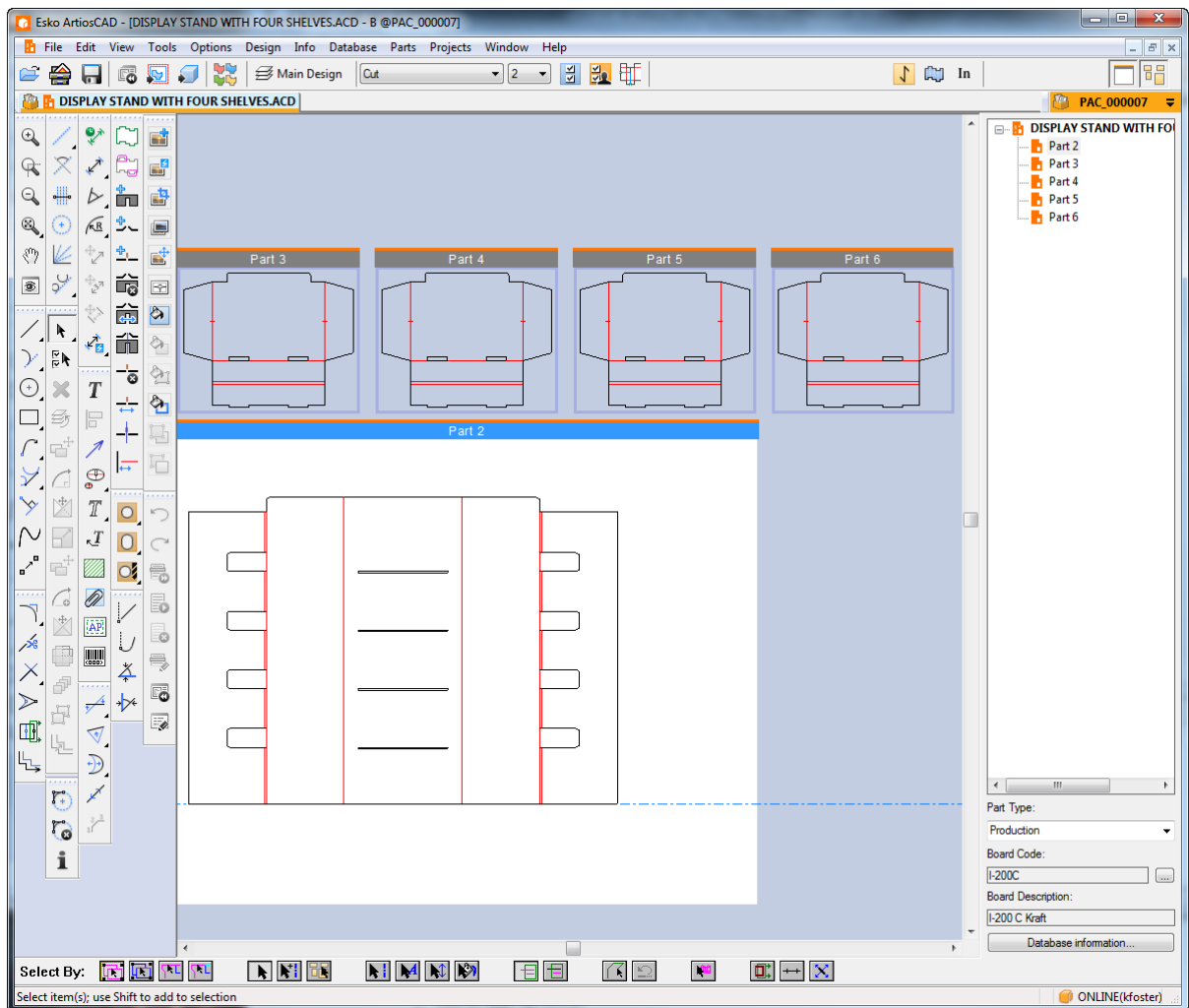

Synchronizing parts

When you open a canvas, ArtiosCAD check the parts and their independent workspaces (if applicable), and if there are differences, prompts you to select which version to use in the Update Parts dialog box. ArtiosCAD Standard Edition looks for newer disk files, while ArtiosCAD Enterprise looks for newer revisions.

Note: Parts synchronization is not supported in offline mode in either ArtiosCAD or ArtiosCAD Enterprise.

To synchronize parts in a canvas, do the following:

1. Open a canvas in which you have saved parts and then made changes to the individual part workspaces.
2. ArtiosCAD begins to open the canvas, detects differences, and opens the Update Parts dialog box.

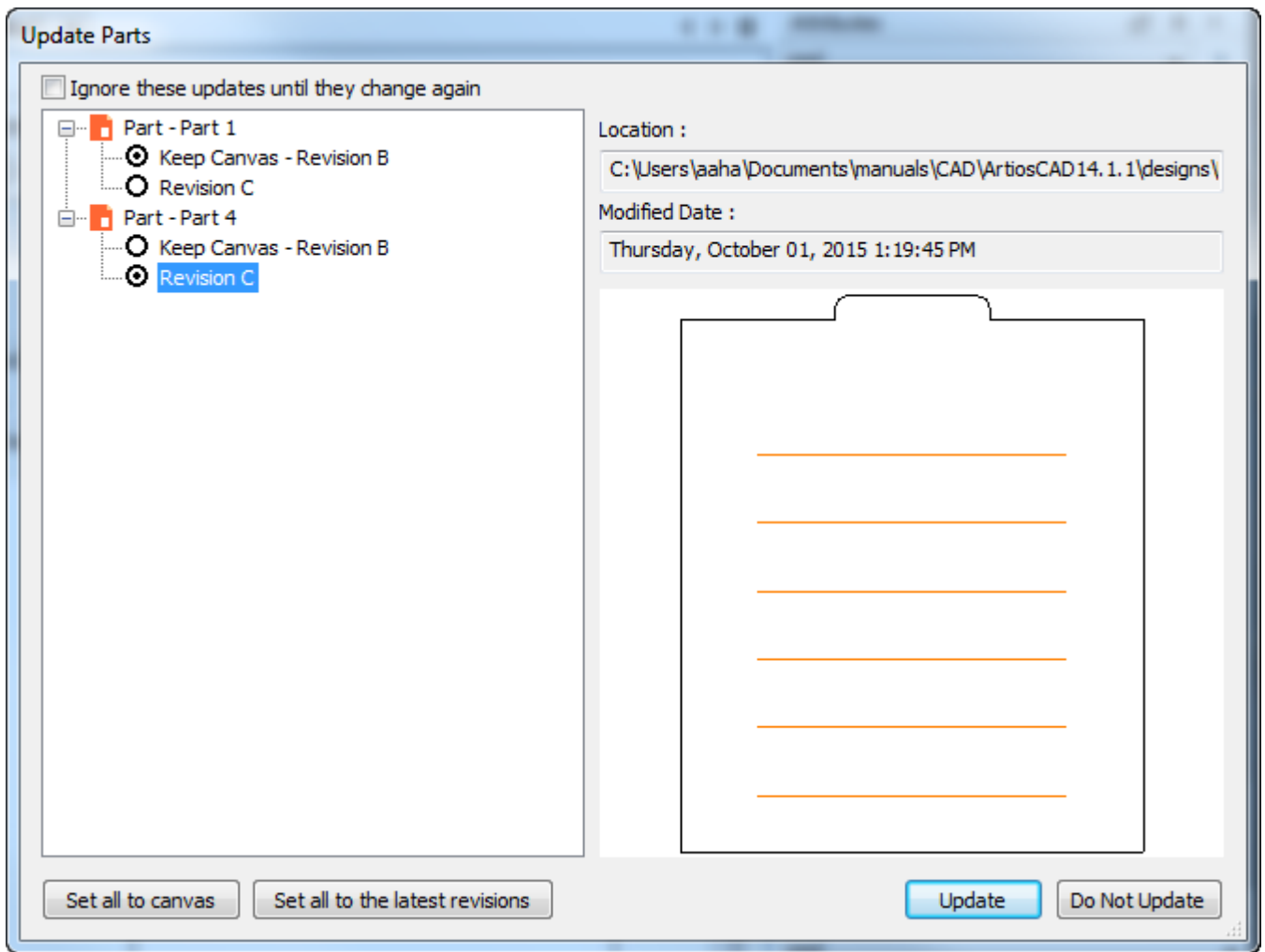

This dialog box lets you choose which version of the part to use in the canvas.

- a) ArtiosCAD shows a list of changed parts on the left side of the dialog box. An orange icon means the part is in its last-saved location. A grey part icon indicates the individual part workspace is not in the location recorded in the canvas and is missing.
 - b) Choose which version to use for each part by clicking its option button. ArtiosCAD shows a preview of the selected part in the preview pane. To quickly toggle all the parts, click **Set all to canvas** or **Set all to the latest revisions**.
 - c) **Ignore these updates until they change again** keeps ArtiosCAD from asking you about these differences by updating their timestamps in the canvas.
 - d) Click **Update** to update the canvas with these changes.
3. When you choose a newer version of a part, ArtiosCAD does the following:
- a) Replaces the geometry in the canvas part with the geometry from the individual workspace.
 - b) The bridging and fold angles in the revised part replace those in the canvas part.
 - c) No construction lines from the revised part copy into the canvas.
 - d) The position of the revised part with respect to the origin copies into the canvas, which might cause it to move on the canvas.

- e) Layers that were changed in the revised part are changed in the canvas. ArtiosCAD ignores empty layers, as well as changes to the layer name and class.
- f) ArtiosCAD updates the canvas with any updates to print item definitions in the revised part, but it does not delete print items in the canvas if they were deleted in the revised part, and it does not change the definition of the print item in the canvas if it was changed in the revised part.
- g) If the grain direction in the revised part is different than that of the canvas part, ArtiosCAD rotates the part on the canvas appropriately.
- h) ArtiosCAD updates the board definition of the canvas part with that of the revised part.
- i) ArtiosCAD replaces the database information of the canvas part with that from the revised part, except for Customer, Owner, Salesperson, and Designer, which are inherited from the canvas.
- j) For 3D: If you changed the base face in the revised part, the base face changes in the canvas part. If you changed the outline of the base face in the revised part, ArtiosCAD clears the base face of the canvas part. If you made animations in the canvas part, they are preserved when ArtiosCAD updates the part. If you changed the number of panels in the revised part or the shape of the base face, ArtiosCAD resets the animation. Animations made in the revised part after converting it to 3D are not added to the canvas during an update.
- k) Color definitions updated in the revised part transfer to the canvas.
- l) Graphics added to the revised part transfer to the canvas.
- m) If you changed property defaults and formulae in the revised part, they do not transfer to the canvas.
- n) For ArtiosCAD Standard Edition, the database information from the revised part transfers to the canvas for the simple descriptions, calculated values, and characteristics, with non-existing characteristics removed and the characteristic description updated based on the code. For userfields, if the canvas userfields came from a different database (based on the database ID), ArtiosCAD deletes the ones from the part. If the canvas userfields are from the same database, ArtiosCAD removes non-existing userfields coming from the part. ArtiosCAD adds all pre-calculated and required userfields.
- o) For ArtiosCAD Enterprise, the database information from the revised part transfers to the canvas for the simple descriptions, calculated values, and characteristics. ArtiosCAD Enterprise removes those characteristics present in the canvas part that do not exist in the revised part. For Attributes, ArtiosCAD Enterprise adds those that exist in the Attribute Category but are not in the revised part. ArtiosCAD Enterprise re-evaluates calculated Attributes.
- p) For board information, ArtiosCAD performs a case-insensitive comparison of the board code and board description for the parts with the board codes and descriptions in the database. For those boards that differ, it lists those from the part that it does not find in the database with their calipers, costs, tests, and papers in the Update Board dialog box.

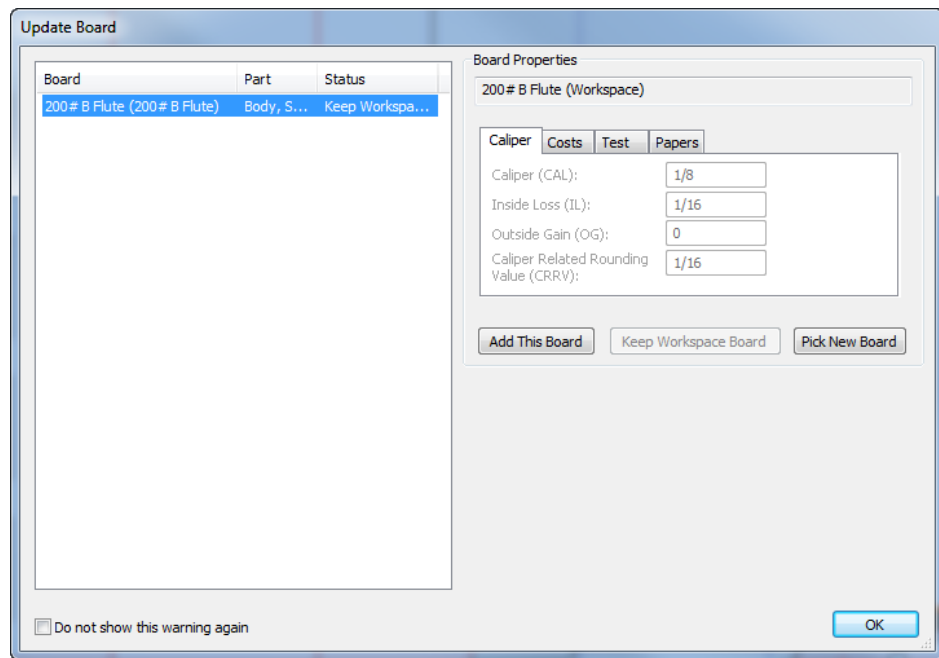

Use **Add This Board** (ArtiosCAD Standard Edition only! ArtiosCAD Enterprise users must use the normal method of board management), **Keep Workspace Board**, or **Pick New Board**. If you use **Add This Board**, ArtiosCAD adds the board to the top level of the tree, but without mediums/liners, 3D information, or texture images. **Keep Workspace Board** is available only after you have chosen a different board using **Pick New Board** and want to return to the original. **Do not show this warning again** marks the board as validated. Click **OK** when you have chosen how to resolve a board conflict.

Converting a part to Manufacturing

1. To convert a Production part to a manufacturing workspace, do one of the following:
 - a) Hover over an empty spot of a Production part or its title bar and right-click it. Then click **Convert to Manufacturing** on the context menu.
 - b) Right-click a Production part in the Parts List and click **Convert to Manufacturing** on the context menu.
2. If you have not already saved the part as a standalone single design workspace, ArtiosCAD prompts you for a design name. It automatically seeds it from the part name.
3. ArtiosCAD prompts you to choose parameter sets and machines as usual.
4. ArtiosCAD adds the part to the sheet and awaits your next command.

Parts management

Making a part active

To make a part active, do one of the following:

1. If Parts Frames are turned on, click the part's title bar.

2. Click the part's name in the Parts List.
3. Right-click inside the part over a blank space so that it turns magenta and click **Set Active Part** on the context menu.
4. When you are moving geometry, snap it to a point in a non-active part.

Changing a part's type

There are two main types of parts: *Production* and *Non-production*.

Production parts can be converted to manufacturing and are included in various calculations.

Non-production parts cannot be converted to manufacturing and are meant to store information not necessary for the construction of the container. When a non-production part is selected in the Parts list, it does not show a board code and the board information and database information buttons are unavailable. However, you can see and set that information for them in the Database Information dialog box on the Database menu. Non-production parts are also not selected by default when saving parts and when outputting a canvas BOM.

To change a part's type, use one of the following methods:

- With the part selected in the Parts List, change the **Part type** drop-down list box.
- Right-click the part in the Parts list and click **Mark as** on the context menu. It will be the opposite of the current state.
- Hover over the part, right-click, and click **Mark as** on the context menu. It will be the opposite of the current state.

Two special part types are *Output* and *Remainder*, which ArtiosCAD uses only when making an Output to a layer and when doing a rebuild.

Hardware parts are added by the **Add Hardware** tool in 3D and can not be added manually. Hardware parts are in their own folder in the BOM and are deselected by default.

Splitting a part

To split a part into two parts, do the following:

1.  Use **Select** to select the geometry to put into a new part.
2. Right-click and click **Split Part** from the context menu, or click **Parts > Split Part**.
3. ArtiosCAD puts the selected geometry into a new part and moves the current position into the new part. Note that it does not physically move the geometry; for that, use the normal method of selecting and moving objects.

If the current selection is all in one part, ArtiosCAD copies the L, W, and D (if set), board, characteristics, simple descriptions, and Userfields from the original part into the new part.

Moving objects to a part

To move objects to a different part, do the following:

1.  Use **Select** to select the objects to move to a different part.
2. Right-click and click **Move to Part** from the context menu, or click **Parts > Move to Part**.
3. Click inside the part to move the objects into; it turns magenta.

4. ArtiosCAD moves the selected objects into the part you indicated. The parts expand or contract to accommodate the moved objects. Note that ArtiosCAD does not physically move the objects; for that, use the normal method of selecting and moving objects.

Moving a part

When you move a part, everything associated with the part moves, even items in locked and/or invisible layers. To move a part, do the following:

1.  Click the title bar of the part (if Part Frames are turned on) with the **Select** tool and drag the part to the new position.
2. Alternately, click **Parts > Move Part**
 - a) Move the mouse cursor inside the part to move. It will turn magenta to indicate it is selected.
 - b) Click inside the part and drag the part to its new location.
3. As you drag, ArtiosCAD displays alignment lines to other parts.

If you try to place a part so that it intersects another part, ArtiosCAD displays a warning cursor and turns alignment lines red, but will let you do it. You should not place parts over other parts.

Changing properties

When you change properties of a selection across multiple parts, ArtiosCAD properly updates each part and records the change for future use.

Parts Options

Click **Parts > Parts Options** to open the Parts Options dialog box.

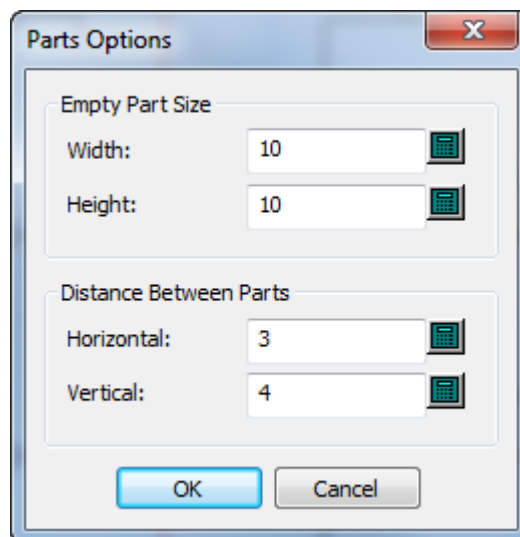

In the Empty Part Size group, **Width** and **Height** set the default size for new parts. Changing these values does not change the size of existing empty parts.

In the Distance Between Parts group, **Horizontal** and **Vertical** control the gutter between parts when converting to a canvas and using **Auto Space Parts**. This gutter applies to outermost design lines in the part, not the part frames.

The Defaults for these values are in **Options > Defaults > Startup defaults > Canvas/Parts Options**.

Parts database information

ArtiosCAD is context-aware and shows you the database information for either a part or the canvas depending on which you have selected in the Parts List.

Parts inherit the canvas' **Customer, Designer, Salesperson, and Owner** database fields. Those fields are read-only in the Parts Database Information dialog box.

In the Design group, **Length, Width, and Depth** are shown for information only. ArtiosCAD only uses the canvas variables in StyleMaker. If you set them in a part, ArtiosCAD uses those for Reports and Outputs but not for actual construction. This is also so that if you import a part from a standard, you can see the values used to run the standard.

ArtiosCAD shows the Manufacturing database information dialog box for Layout parts. It copies this information to Manufacturing if you convert the layout part to Manufacturing.

The table below shows how ArtiosCAD sets the database information for a part depending on its source.

	Create Part	Import File as New Part	Import Standard as New Part
Name	Set to the part's filename	Set to the part's filename	Set to the part's filename
Saved date	Clear	Imported from original file	Clear
Resource	Clear	Clear	Clear
Revision date	Initialized to current time	Imported from original file	Initialized to current time
Directory	Clear	Clear	Clear
Revision #	Clear	Imported from original file	Clear
Open project	Uses current project	Uses current project	Uses current project
Customer	Uses canvas values	Uses canvas values	Uses canvas values
Owner	Uses canvas values	Uses canvas values	Uses canvas values

	Create Part	Import File as New Part	Import Standard as New Part
Sales person	Uses canvas values	Uses canvas values	Uses canvas values
Designer	Uses canvas values	Uses canvas values	Uses canvas values
Description	Clear	Imported from original file	Imported from standard
Short description 1,2,3	Clear	Imported from original file	Imported from standard
Authorization	Clear	Imported from original file	Clear
Revision description	Clear	Imported from original file	Clear
L, W, D	Clear	Imported from original file	Imported from standard
Board info	Set to canvas board	Imported from original file	Chosen by you during Run a Standard
Grain	Uses canvas values	Uses canvas values	Uses canvas values
Characteristics	Clear	Imported from original file	Imported from standard
Userfields	Clear or populated with required fields	Imported from original file	Clear or populated with required fields
Blank width, height	Calculated from part	Calculated from part	Calculated from part
Area	Calculated from part	Calculated from part	Calculated from part
Rule length	Calculated from part	Calculated from part	Calculated from part

Working with read-only parts

Read-only parts let you include designs in canvases without accidentally modifying them. They are also useful when you want to add a standardized design to a canvas for inclusion on the Bill of Materials.

ArtiosCAD shows that a part is read-only by placing a lock icon next to the name in the part's title bar, next to the part name in the Parts List, and in the Save Parts dialog box.

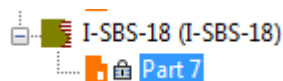

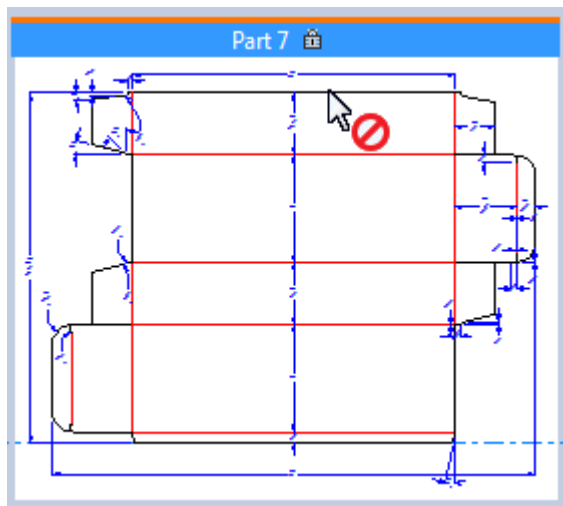

Part Name	Filename	Rev	Location	Database Information	Save	Status
<input checked="" type="checkbox"/> Part 1	BOOKSHELF9^01.ARD	0	@161designs <C:\Users\aaaha\Documents>manuals	...	Create New Document	
<input checked="" type="checkbox"/> Part 2	BOOKSHELF9^02.ARD	0	@161designs <C:\Users\aaaha\Documents>manuals	...	Create New Document	
<input checked="" type="checkbox"/> Part 3	BOOKSHELF9^03.ARD	0	@161designs <C:\Users\aaaha\Documents>manuals	...	Create New Document	
<input checked="" type="checkbox"/> Part 4	BOOKSHELF9^04.ARD	0	@161designs <C:\Users\aaaha\Documents>manuals	...	Create New Document	
<input checked="" type="checkbox"/> Part 5	BOOKSHELF9^05.ARD	0	@161designs <C:\Users\aaaha\Documents>manuals	...	Create New Document	
<input checked="" type="checkbox"/> Part 6	BOOKSHELF9^06.ARD	0	@161designs <C:\Users\aaaha\Documents>manuals	...	Create New Document	
<input type="checkbox"/> Part 7	DISPLAY_SHELVES_WITH_HOOKS^04.ARD	0	@161designs <C:\Users\aaaha\Documents>manuals\CA	...	Read-Only	

When the active part is a read-only part, ArtiosCAD:

- Makes all fields unavailable for changing in the Database Information and Board Information dialog box. ArtiosCAD beeps if you click inside them or try to type.
- Makes all tools unavailable.
- Does not allow you to import files into it.
- Ignores it for DieMaker's Fix-It and double line removal in Design Checks.
- Ignores it in the **Intersect Design** and **Add Hardware** tools in 3D.
- Does not save changes in 3D to a read-only part back to 2D when saving a 3D workspace.
- Displays "Active Part is Read-Only" in the Layers dialog box.

Making a read-only part writable

To make a read-only part writable, do the following:

1. Make the read-only part the active part.
2. Either:
 - Hover over the part in the Parts List, right-click, and click **Make Writable** on the context menu.
 - Right-click the part's title bar and click **Make Writable** on the context menu.
 - Click **Parts > Make Active Part Writable**.

Making a writable part read-only

To make a writable part read-only, do the following:

1. Make the writable part the active part.
2. Either:
 - Hover over the part in the Parts List, right-click, and click **Make Read-Only** on the context menu.
 - Right-click the part's title bar and click **Make Read-Only** on the context menu.
 - Click **Parts > Make Active Part Read-Only**.

Note: By definition, you cannot save a read-only part. Save changes to the part before you make it read-only.

Breaking the link to a formerly read-only part

To break the link to a read-only part and save the active part as something new, do the following:

1. Make the part writable.
2. Save the new part and change the path, the filename, or both.
3. ArtiosCAD breaks the link.

Rebuild in canvases

When you rebuild a canvas, ArtiosCAD shows the different rebuildable parts as nodes on a tree:

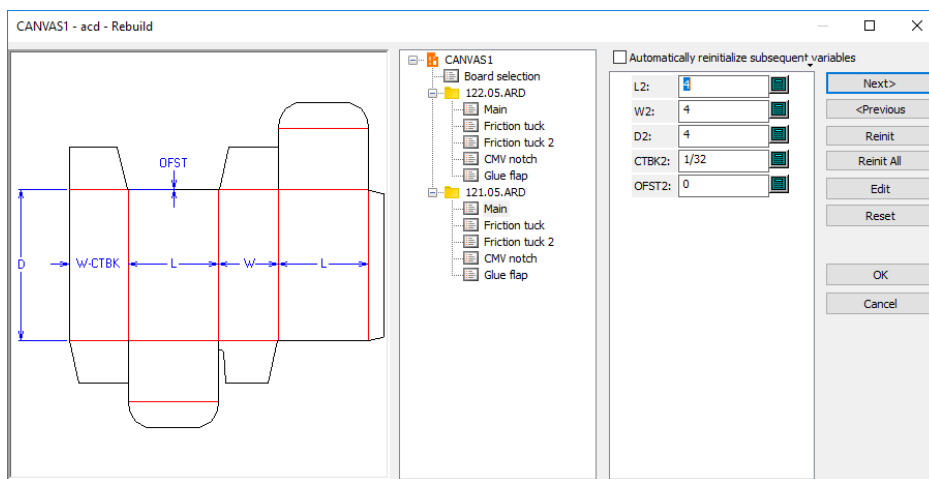

- ArtiosCAD rebuilds all parts. To rebuild only one part, only change the variables for one of the parts in the tree.
- ArtiosCAD may put some geometry in the Remainder part.
- If you use **Undo** or **Redo** after deleting a part and then rebuild, ArtiosCAD may put extra geometry in the Remainder part.
- The commands for creating a part and deleting a part get re-executed on rebuild so the active part may change when ArtiosCAD completes the rebuild.

Parts saved to independent workspaces are not rebuildable. However, if those parts had a specified L, W, D or board variables, those get exported to the workspace even though the canvas does not use them.

Parts updated on opening a canvas are not rebuildable in the canvas.

Geometry pasted into a canvas is not rebuildable as ArtiosCAD does not copy variables from the source design.

If you change the L, W, or D for a canvas, ArtiosCAD updates the L, W, D for parts having matching values that were not imported.

When drafting a rebuildable canvas, intra-part referencing works safely.

If rebuilding a canvas is important to you, one suggested workflow for a display standard with multiple parts that use the same board is:

- Convert it to a canvas
- Make changes to the canvas and rebuild it, but be wary of the number of parts changing
- Convert to 3D and arrange the assembly
- Return to the canvas and modify it
- Rebuild the canvas and use **Previous** to change the board in the Board Selection dialog box

- Update the 3D workspace.

If you need to rebuild a canvas using different boards for each part, draft parts as separate standards and add them to a style catalog. Then use **Import File > From Standard as New Rebuildable Part** and use a different board for each part as desired.

Undo and Redo in canvases

In a canvas, **Undo** and **Redo** work just as they do in a single design. If you Undo creating a new part, the part created before it becomes the active part. If there is no previous part, ArtiosCAD makes the canvas active. If you redo undoing creating a part, ArtiosCAD adds the part but does not make it active.

Layers in canvases and parts

The same layers in the canvas exist in all the parts. Different parts cannot have different layers.

Canvases do not have layers of *Horizontal cross section*, *Label graphics*, or *Shrink wrap graphics*.

For locked layers, you can lock layers per part, but if you lock the canvas layer, that layer is locked for all parts, and likewise for unlocking layers.

The Layers dialog box in canvases has **Active Part Lock**, which, when clicked, opens the Active Part Locked dialog box. Use this dialog box to lock and unlock layers for the active part. Layers that are empty in this part have gray names.

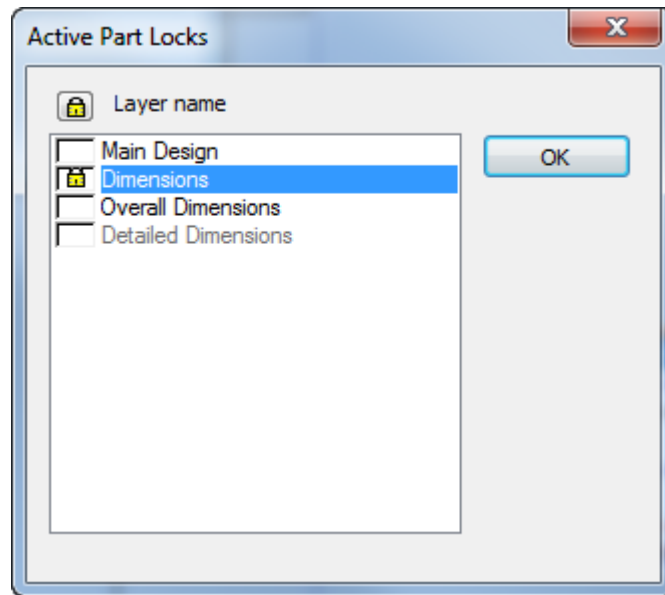

In the Layers dialog box for a canvas, if one part has a locked layer that is not locked in all parts, or is not locked in the canvas, the lock icon is present but dimmed.

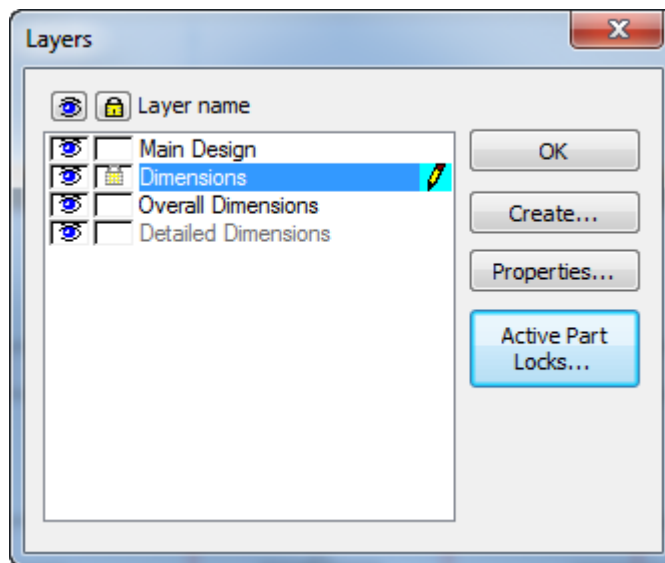

Copying and pasting in canvases

When you copy and paste from a single design into a canvas, ArtiosCAD pastes at the origin or bottom left of an empty part. If the canvas is not empty, ArtiosCAD pastes in the active part to the top left of the existing geometry. In all cases, ArtiosCAD tries to not overlap parts.

Pasting within the same canvas is similar to using **Copy** in that you paste into the active part and activate **Move** automatically after pasting.

You may not paste items from the *Horizontal cross section*, *Label graphics*, or *Shrink wrap graphics* layers from other designs as you cannot create a solid of revolution from a canvas.

ArtiosCAD does not copy print items when you paste.

You may not rebuild pasted geometry as ArtiosCAD does not copy variables from the source design.

Pasting has the following limits:

- Number of layers: 250
- Number of special rules: 39
- Number of fonts: 39
- Number of colors: 999

Changing the boards

Variable indexing

To accommodate part resizability, ArtiosCAD indexes each part's board variables for the caliper, inside loss, outside gain, and corrugated rounding value (if a corrugated board) (CAL, IL, OG, and CRRV). When you add parts, the variables have an index number appended to them. For example, for the second part you add, ArtiosCAD uses CAL(2), IL(2), and OG(2). Using just the variable without an index refers to the current part. If you want to refer to another part's variables, use its part number in the variable. If you were working in part 2, using CAL would refer to CAL(2), but to specify the caliper for part 4 while in part 2, you would use CAL(4).

If you have not renamed the parts, the part name contains the part number. If you have renamed the parts, use the **Boards** button in the keypad to open the Select Board Expression dialog box, which shows the parts and their numbers.

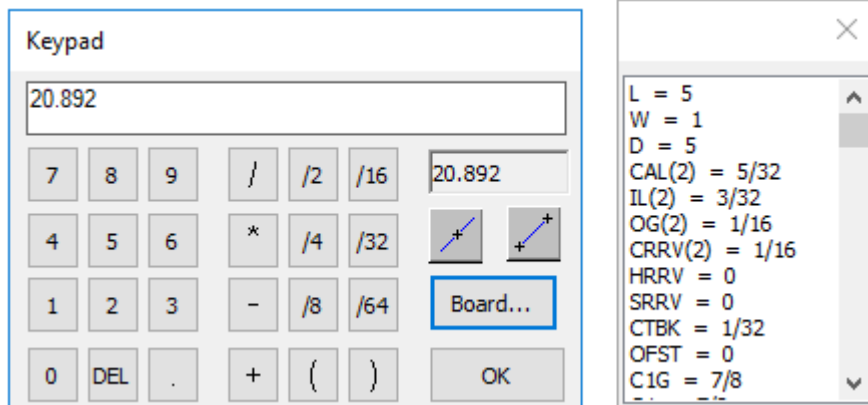

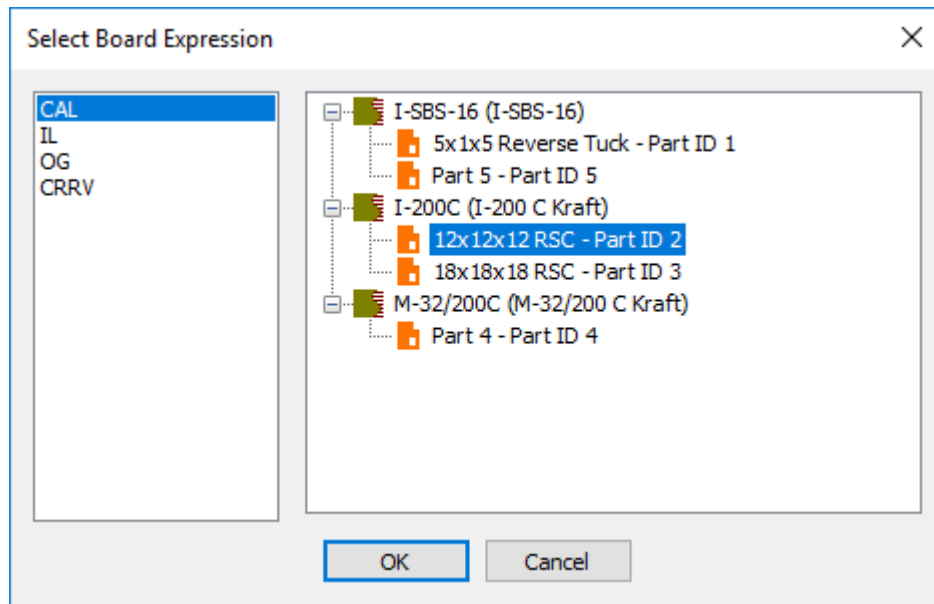

Changing the board used by multiple parts

To change the board used by multiple parts, do the following:

1. Right-click the board in the Parts List and click **Change Board** on the context menu.
2. Choose the new board in the Part Board Information dialog box and click **OK**.

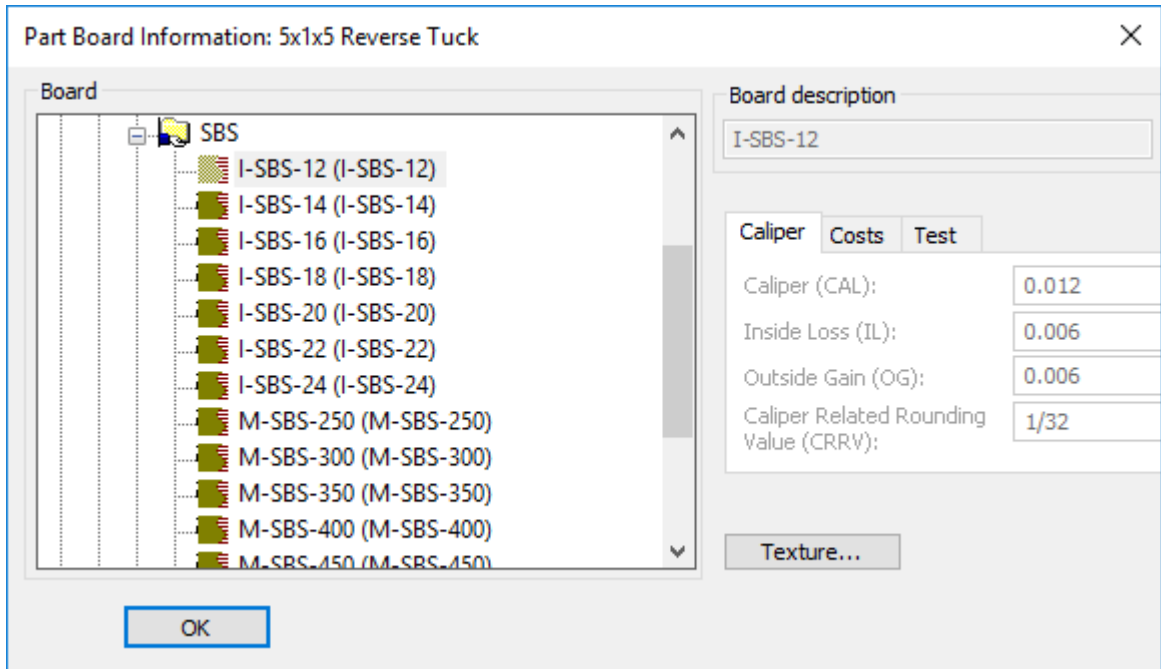

3. The existing board in the Parts List changes to the new board.
4. If any of the parts were resizable, ArtiosCAD highlights **Rebuild** on the View bar to indicate you should rebuild the canvas in order to update the parts with the new variables.

Changing the board used by one part

To change the board used by one part, do the following:

1. Right-click the part in the Parts List and click Board Information on the context menu.
2. Choose the new board in the Part Board Information dialog box and click **OK**.

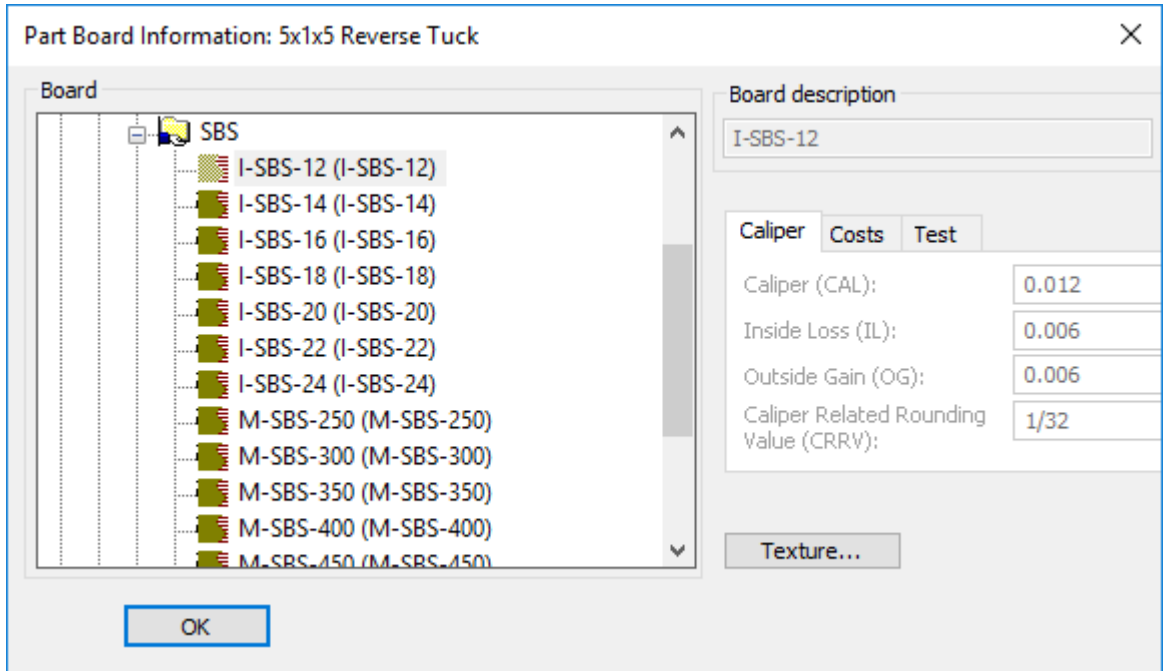

3. ArtiosCAD adds the new board to the Parts List and moves the part under it.
4. If the part was resizable, ArtiosCAD highlights **Rebuild** on the View bar to indicate you should rebuild the canvas in order to update the part with the new variables.

Other notes

When you write a canvas standard, before you add geometry, create the same number of empty parts as different boards you want to use. Next, change the board for each part appropriately. That way, when you create geometry and want to refer to different parts' variables, you will easily know the index number for each part without having to check in the Keypad.

Drafting in canvases

Drafting in a canvas is similar to drafting in a single design, but there are differences. Specific tools and toolbars have notes following this section.

Report and **Counter** tools are unavailable in canvases.

Advanced Standard and **Registration Holes** tools work the same way as **Geometry** and **Dimension** tools.

Undo-Redo, **Extend-Measure**, and **View** tools work the same as they do elsewhere.

Drafting rules

Keep parts separate. Parts should be self-contained.

When you draw new geometry:

- If you draw geometry **from a point** in the active part, the active part remains active and the geometry remains in the active part regardless of the location of the end-point.
- If you draw geometry **from coordinates** in the active part, and snap to a point or intersect another line in the destination, ArtiosCAD puts the new geometry in the destination part and makes the destination part active. If you snap to coordinates, ArtiosCAD puts the new geometry in the source part and does not change the active part.
- If a part is active and the start point is outside it, if the destination snaps to a point in the active part or intersects a line in the active part, ArtiosCAD does not change the active part and the new geometry goes in it. If the destination is coordinates, ArtiosCAD puts the new geometry in the part containing the source and changes that part to the active part.

When you move existing geometry:

- If you **snap it to a point**, ArtiosCAD puts the geometry into that part and makes that part active.
- If you **move it to coordinates** or **intersect it** with a line in another part, ArtiosCAD expands the source part to include the moved geometry and the source part remains or becomes the active part.

Construction lines in canvases

Canvases use the **Canvas construction line** line type. Its default appearance is a long-dashed blue line, unless the current plotting style has the Remainder type set, in which case ArtiosCAD uses that. For Outputs, it uses the same tool as Construction line 1.

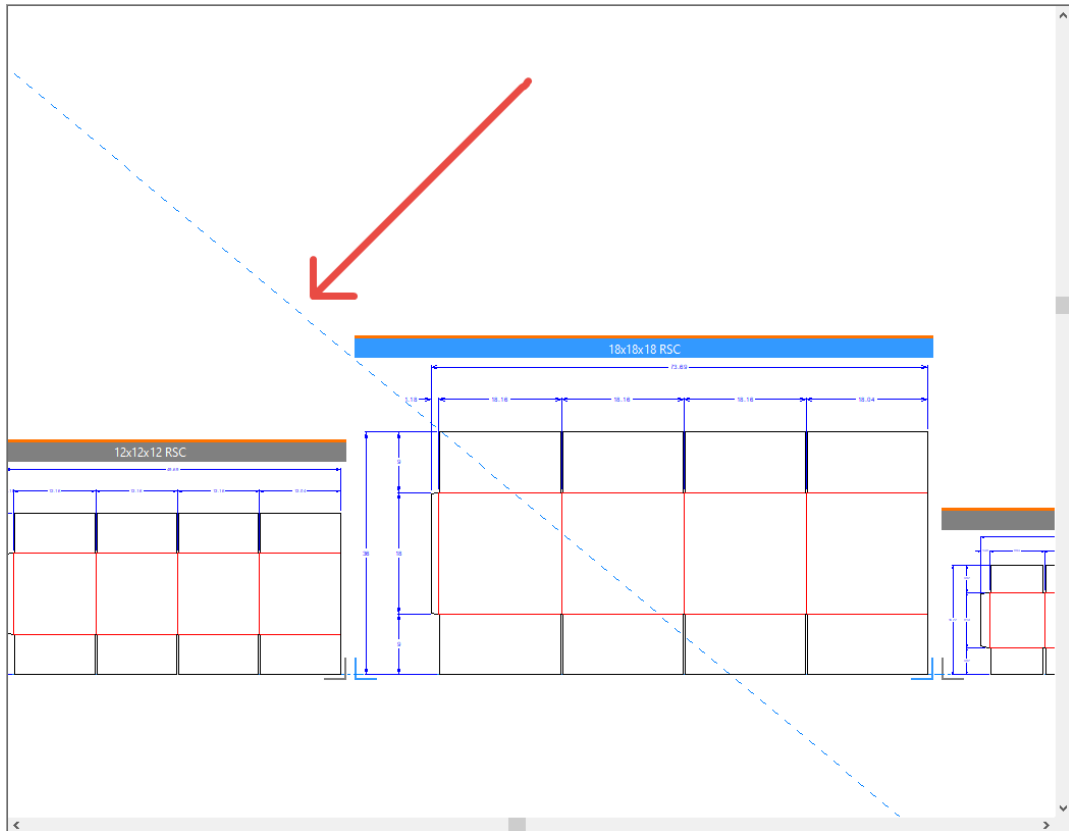

Construction line creation

When the canvas is active, ArtiosCAD creates construction lines in the canvas.

When a part is active, and you use items from that part only to make a construction line, ArtiosCAD puts the construction line in the part as type Construction line 1 and activates that part.

When a part is active, and you use items from two different parts to create a new construction line, ArtiosCAD creates a canvas construction line and activates the canvas.

When a part is active, and you use a canvas construction line to create a new construction line, ArtiosCAD creates the construction line in the canvas and activates the canvas.

When you open a canvas, if it has no part construction lines but has construction lines at the canvas level of other types, ArtiosCAD converts those other construction line types to Canvas construction lines.

When you convert a design to a canvas, ArtiosCAD converts all construction lines to type Canvas construction line.

When you import multiple rebuildable designs at once, ArtiosCAD puts all the construction lines into part 1 as type Construction line 1.

ArtiosCAD does not import construction lines from static designs.

Other notes

When you move a part, ArtiosCAD moves its construction lines too.

Split Part, **Move to Part**, and **Move to Layer** ignore all construction lines.

To move a construction line from a part to the canvas, double-click the line with **Select Conlines** while the part is active, then change its linetype to Canvas construction line. This does not work in reverse as you cannot change canvas construction lines.

Geometry toolbar tools

When you use tools on the Geometry toolbar (**Line Angle/Offset**, **Arc Start Angle**, and other tools that work the same way) with the start- or end-point touching geometry in a part, ArtiosCAD creates the geometry in that part and makes that part active. If the start- or end-point does not touch anything, ArtiosCAD creates the geometry in the active part.

Dimension tools

When you dimension lines in a part, ArtiosCAD makes it the active part and puts the dimensions in it.

If the dimensions use **Scale text size upon rebuild**, the size is based on the canvas. Therefore, to avoid dimensions at the wrong size, create all the geometry in the canvas before creating dimensions.

ArtiosCAD puts dimensions spanning multiple parts in the current part, even if neither end-point is in the current part.

Adjust tools

The Adjust tools work in canvases as follows:

- **Blend**, **Chamfer**, and **Blend Three Lines** set the active part to the one in which you are creating geometry. ArtiosCAD creates the new blend line in the part containing the first line you clicked.
- **Split** and the **Trim** tools set the active part the part in which geometry changes. If you selected geometry from multiple parts, ArtiosCAD does not change the active part.
- **Follow** and **Stretch Point** work only within the active part.
-  **Stretch by Polygon** has a status bar button, **Select in Active Part Only**, to restrict the selection to objects in the active part regardless of the size of the polygon.

Adjust Outline tools

The Adjust Outline tools work in canvases as follows:

- You may only select geometry within the same part.
- **Sequence** is unavailable in canvases.
- They set the active part to the one in which you change geometry.

Annotation tools

The Annotation tools work in canvases as follows:

- ArtiosCAD puts new text and arrows into the active part.
- In **Detail**, you can clip only within one part. ArtiosCAD adds the detail to the part containing the clip and sets it to the active part.

- ArtiosCAD puts the line type label into the part containing the line associated with the label. If you did not select a line, ArtiosCAD puts the label in the active part. If you selected a line in another part, that part becomes the active part.
- **Artwork Panels, Dynamic Art, Bleed, and Coating** tools work only in the active part. ArtiosCAD changes the cursor to a cross-hair with a *No* circle if the cursor is over a panel in a non-active part.
- **Hatch, Mate, and Fill Panel** work on a panel in the active part, and change the active part to that in which you clicked. Panels must be in the same part.

Edit tools

The Edit tools work in canvases as follows:

- The **Copy** tools add to the active part. If the tool has a move mode, ArtiosCAD adds new geometry to the part containing the put-down point to which you snapped and makes that part active. **Copy Mirror About Center, Copy Mirror About Line, Copy Times Offset, and Copy Times Rotate** are exceptions as they always add geometry to the active part.
- For the **Edit** tools, all changed items stay in their parts. If all changed items are from the same part, ArtiosCAD makes this part active. If not, ArtiosCAD does not change the active part. If the tool has a move mode and the pick-up point is on a piece of geometry in the selection, ArtiosCAD moves the selection to the part containing the put-down point, which also becomes active. This entire process may be undone with one Undo.
- **Group Sequence** and **Design from Half/Quarter** are not available.
- **Group** can group only items from one part and that part becomes active.

Graphics tools

The Graphics tools work in canvases as follows:

- **Add Graphics** adds graphics to the active part.
- **Register Bitmap** registers a bitmap from any part into geometry in the active part.
- **Clip Graphics** switches the active part to the part containing the selected graphics. You may select the clipping path in non-active parts but all lines should be in the same part.
- **Replace Graphics** switches the active part to the part containing the old graphics, but you may select new graphics from any part.
- **Move Graphics** and **Auto-Trace Bitmap** change the active part to the part containing the old graphics.
- **Color Stock** works on the active part.
- **Fill** works on a closed loop of lines all in the same part, and changes the active part.
- **Stroke** changes the active part to the selection and all lines must be in the same part.
- **Fill Panel** changes the active part to the selection and all panel lines must be in the same part.
- **Send to Front** and **Sent to Back** change the order of layers for all parts and the canvas.
- **Save Graphics As** exports graphics from any part.

Prepare Manufacturing tools

The Prepare Manufacturing tools work in canvases as follows:

- **Bleed** and **Coating** tools work only in the active part.
- ArtiosCAD changes the cursor to a cross-hair with a No circle if you try to select a panel in a non-active part.
- **Bridge** tools change the active part to that of the changed line. For a multiple selection using a rectangle, if all the lines are in one part, ArtiosCAD makes that part active. If the lines are not in the same part, ArtiosCAD does not change the active part. For **Add Nick** with the **Fill Path** option, the path can be in only one part. If the path already exists, ArtiosCAD changes the line and makes the part active. If the path goes across parts, ArtiosCAD fills the first line with nicks and does not create a path. The tools that add construction lines do not change the active part and ArtiosCAD puts the construction lines on the canvas.
- **Shorten All** in **Shorten Creases** does not change the active part.

Information menu

On the **Information** menu, **Rule Length**, **Blank Size**, **Area**, and **Board information** all work on the active part.

Using geometry macros in canvases

Geometry macros that use the *Place the geometry on/offset* placement methods should work without any changes. These include the **Folding carton tools**, **Graphic symbols**, **Hangars**, and **Laser Position Holes** geometry macros. These geometry macros will:

- Place the geometry in the active part.
- Set the active part if you snap them to a point.
- Add a layer to the part if needed.

Registration marks that use the *Placement computed by geometry macro* placement method should work with parts.

Geometry macros that used advanced placement methods will probably not work correctly as they expect layers for a single design. These include geometry macros that use *Placement computed by geometry macro* (other than registration marks), in-place geometry macros, and INTERACT macros.

The **Line Type Legend** geometry macro gathers information for the entire canvas and makes a Remainder part.

Dimensioning the sheet of a layout part

If you want to add dimensions for the sheet of a layout part, there is a geometry macro for that which places the dimensions in the Overall Dimensions layer of the canvas. It uses the **Placement computed by geometry macro** placement method.

1. Make the layout the active part.
2. Click **Tools > Geometry Macros**.
3. Open the Utilities catalog and click **Sheet Dimensions**.
4. Click **OK**. ArtiosCAD adds dimensions to the sheet in the Overall Dimensions layer of the canvas.

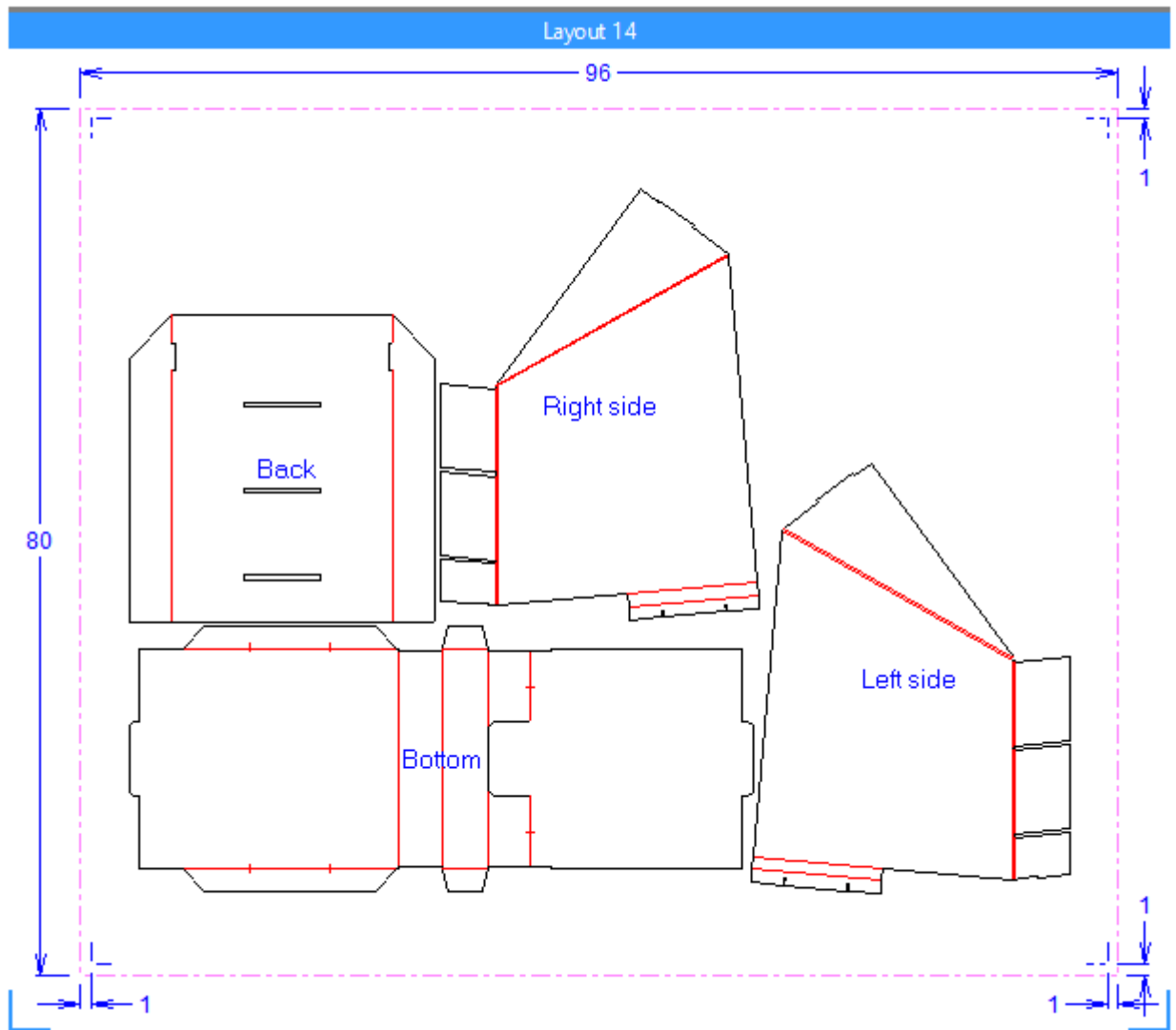

If you change the layout part, delete what was created by the geometry macro before running it again. You can use **Delete Layout Annotation** in the Sheet Properties dialog box for this.

Creating your own canvas geometry macro

If you want to create your own sheet dimensions geometry macro for canvas layout parts, here is a suggested workflow. You will need Advanced StyleMaker for this.

1. Open SHEETDIMS.ARD in InstLib and replicate its menus and variables in your own workspace.

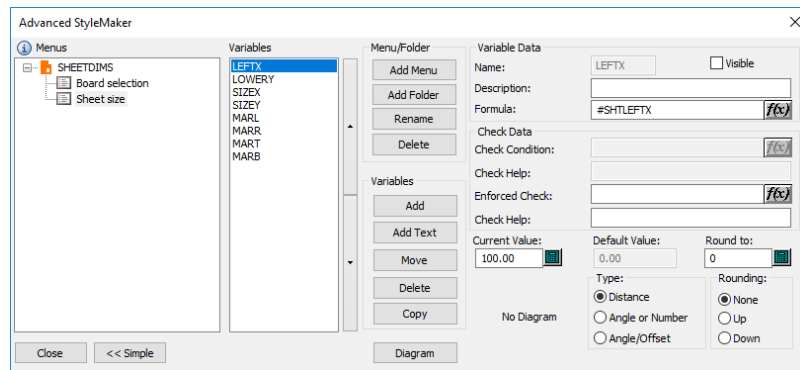

2. Use sensible non-zero current values such as 1500mm for the sheet width and 20mm for the margins.
3. Use the variables to make two nested rectangles, one for the sheet and one for the margins (inside the one for the sheet).
4. Dimension the rectangles as desired.
5. Delete the rectangles.
6. Rebuild the workspace with different sheet sizes and margins to verify it rebuilds properly.
7. If you are satisfied with how it operates, make the variables invisible in StyleMaker by deselecting the **Visible** checkbox for each one. If you still want to test it, keep the variables visible as otherwise when you rebuild the workspace, ArtiosCAD will reinitialize them to their formulas, which will not work as the geometry macro workspace itself does not have a layout.
8. If you want the dimensions to work in both Imperial and metric, edit the log file using **Rebuild Playback** and remove **FORMAT 2** from the end of each distance command.
9. Save the workspace.
10. Copy it to ServerLib.
11. Add it to the Geometry Macro catalog. Specify the **Placement computed by geometry macro** placement option and enable **Move to Layers**.

For other types of geometry macros, use placement option **Place the geometry at any location**.

Useful variables for sheet dimensions

Use these system variables to define the variables in your custom sheet dimensions geometry macro. The example geometry macro uses them.

System variable	Description
#SHTLEFTX	X position lower left of the sheet
#SHTLOWERY	Y position lower left of the sheet
#SHTSIZEX	Sheet width
#SHTSIZEY	Sheet height
#SHTMARR	Sheet left margin
#SHTMARR	Sheet right margin
#SHTMART	Sheet top margin
#SHTMARB	Sheet bottom margin

These system variables are available as well, but the example geometry macro does not use them.

#SHTRIML	Distance from left sheet edge to layout blank
#SHTRIMR	Distance from right sheet edge to layout blank
#SHTRIMT	Distance from top sheet edge to layout blank
#SHTRIMB	Distance from bottom sheet edge to layout blank

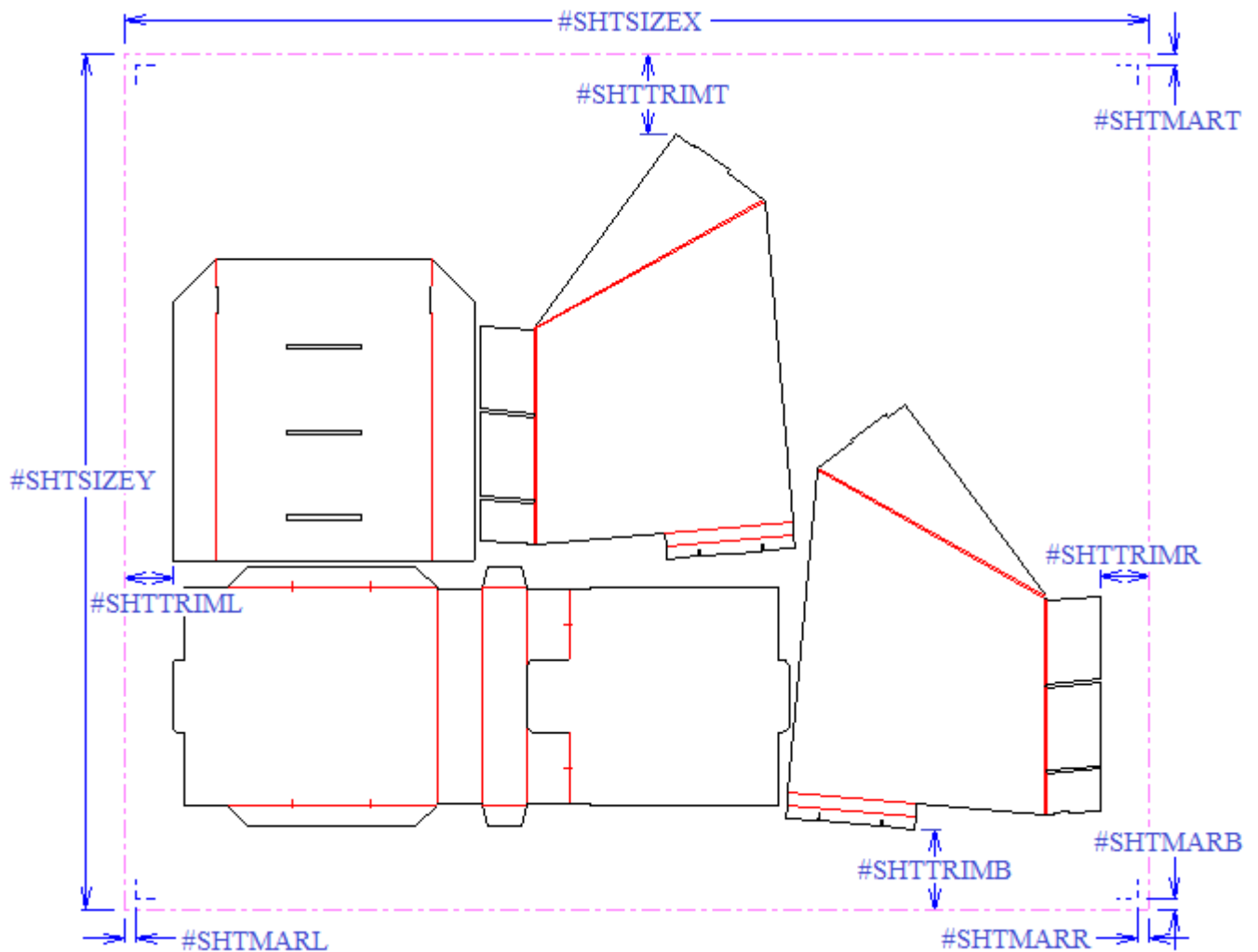

Library functions for canvases

Library functions for canvases are similar to geometry macros in that those that depend on the section structure for a single design will not work properly. To work around this, use these system variables instead.

Old library function

LIBRARY(DESBLANKX)
 LIBRARY(DESBLANKY)
 LIBRARY(DESLEFTX)
 LIBRARY(DESLOWERY)
 LIBRARY(DESCENTERX)
 LIBRARY(DESCENTERY)
 LIBRARY(LIBAREA1)
 LIBRARY(LIBAREAH1)
 LIBRARY(LIBWAGRAIN)
 TLIBRARY(LIBDBSTYLE.TXT)

Updated system variable

#MANSIZEX
 #MANSIZEY
 #DESLEFTX
 #DESLOWERY
 #DESCENTERX
 #DESCENTERY
 #AREA
 #AREAH
 now uses #MANSIZEX, #MANSIZEY
 #DBCHARS\$

Layouts in canvases

You can quickly nest production parts together onto sheets using the canvas layout feature. This is primarily meant to see if the parts will fit on the sheet as they are or if you need to refine their design slightly to make the most efficient layouts.

Canvas layouts have two components:

- Layouts, which are nested arrangements of parts on one sheet of board
- Jobs, which are groups of layouts of parts on the same board

You can create a layout automatically based on existing parts, or you can create an empty layout and manually add parts to it.

For parts on layouts, ArtiosCAD shows lines in the Main Design, Manufacturing, and Window and Cutouts layers. It does not show dimensions, text, arrows, or graphics. However, it retains these items when you convert a canvas to a manufacturing workspace.

Note: If you intend to create a layout, ensure none of the part frames in the canvas overlap each other, as that might lead to unpredictable results.

Creating a layout automatically

ArtiosCAD can create a layout automatically for all the production parts that use the same board in a canvas.

To find the nesting outline in a part, the ArtiosCAD nesting algorithm uses either a single loop or a bounding box. A single loop is formed by:

- All lines, arcs, and/or beziers with non-zero lengths
- Of type cut (and special rule of generic type cut)
- In the Main Design, Manufacturing, or Window and Cutouts layers.

If ArtiosCAD cannot find a single loop, it uses a bounding box formed by:

- All lines, arcs, and/or beziers with non-zero lengths

- Of type cut, crease, print registration, bleed, print images, die etch (types 1..19), and special rules based on these types
 - In the Main Design, Manufacturing, or Window and Cutouts layers.
1. Make sure all the parts in the canvas are clearly separated.
 2. Either:
 - a) Right-click the board in the Parts List and click **Create Layout**, or
 - b) Click **Parts > Create Layout > (board code)**.
 3. In the Layout Options dialog box, select all the parts to include in the layout. ArtiosCAD selects all the parts with the same board automatically. Set the values for the sheet size, margins, gutter, nesting choices, quantities, and sheet edge style. The width and height must be greater than zero. The gutter and margins must be greater than or equal to zero.

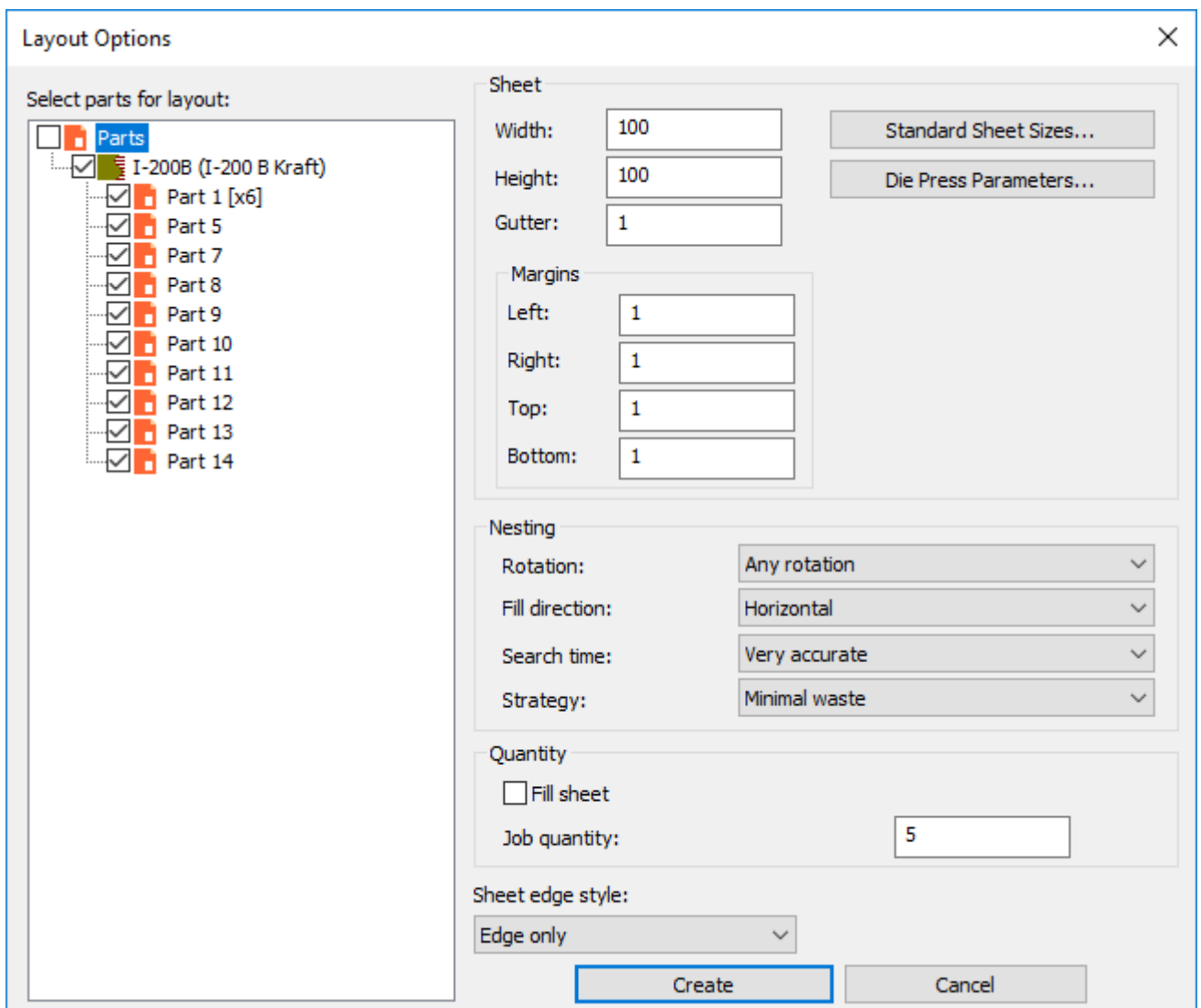

Alternately, you can choose a standard sheet size or a die press by clicking **Standard Sheet Sizes** or **Die Press Parameters**, and use the values from those sources.

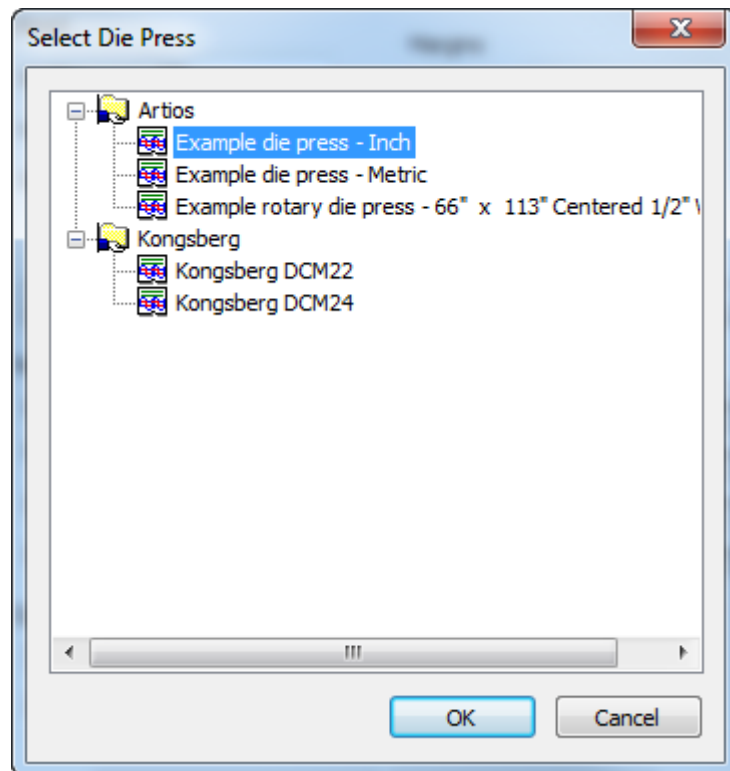
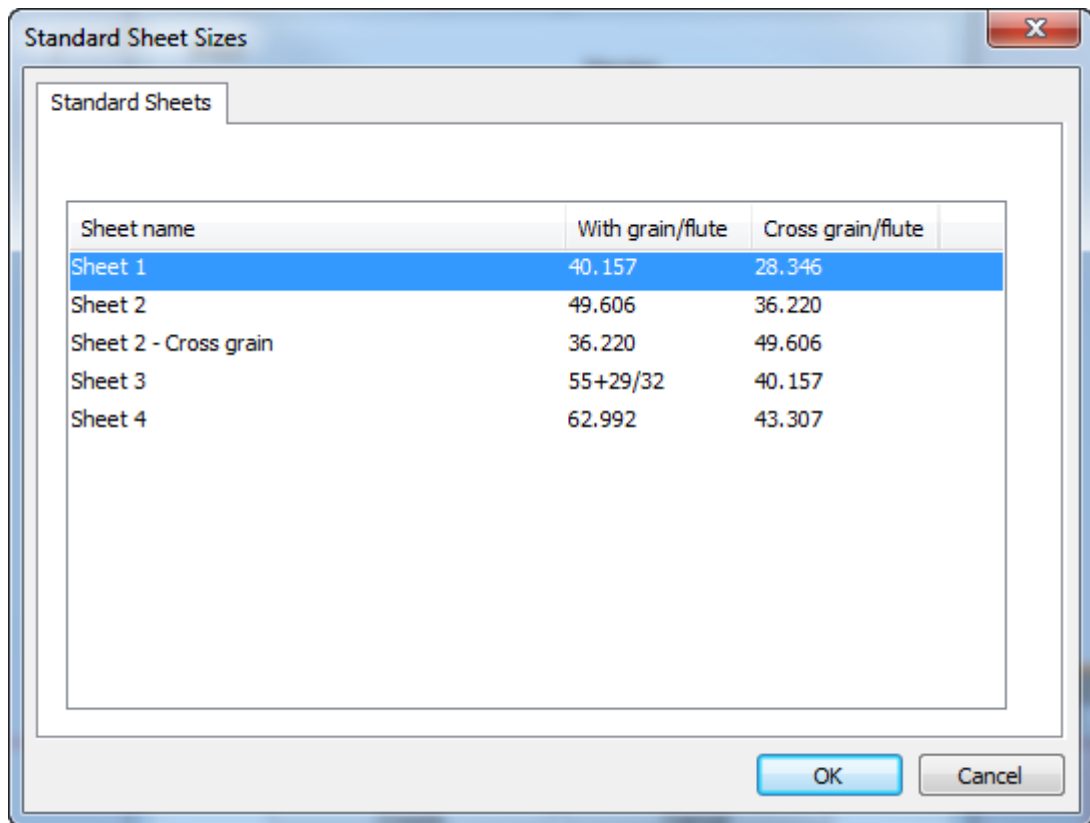

4. In the Nesting group, set the options for computing the nest as desired.
 - a) Rotation can be **No rotation**, **180 rotation**, **90 rotation** or **Any rotation**. This applies to all parts in the layout.
 - b) Fill direction can be **Horizontal** or **Vertical**. This specifies the basic shape of the layout. If you set this to Horizontal, any unused space in the layout is horizontal.
 - c) Search time can be **Very fast**, **Fast**, **Accurate**, or **Very accurate**. The faster the search, the less accurate the nest.
 - d) For the strategy, **Minimal waste** creates the layout with the least amount of waste. **Minimal layout** creates the layout with the least overrun for the parts with a greater job quantity. **Priority by size** places the emphasis on making the closest number of larger parts to the job quantity.
5. In the Quantity group, set the **Job quantity** to the number of produced pieces of each part you need. This must be an integer greater than zero. This number multiplied by a part's number of copies determines the ordered quantity. **Fill sheet** adds parts to the sheet even after ArtiosCAD meets the ordered quantity. There is no control over which part ArtiosCAD uses to fill the sheet. The proportion of extra copies is roughly equal to the same as it would be for a single job.
6. Click **Create** to create the layout. If you have more parts than will fit on a single sheet, ArtiosCAD creates as many layouts as needed to accommodate all the parts in the job. Shown below is a one-layout job.

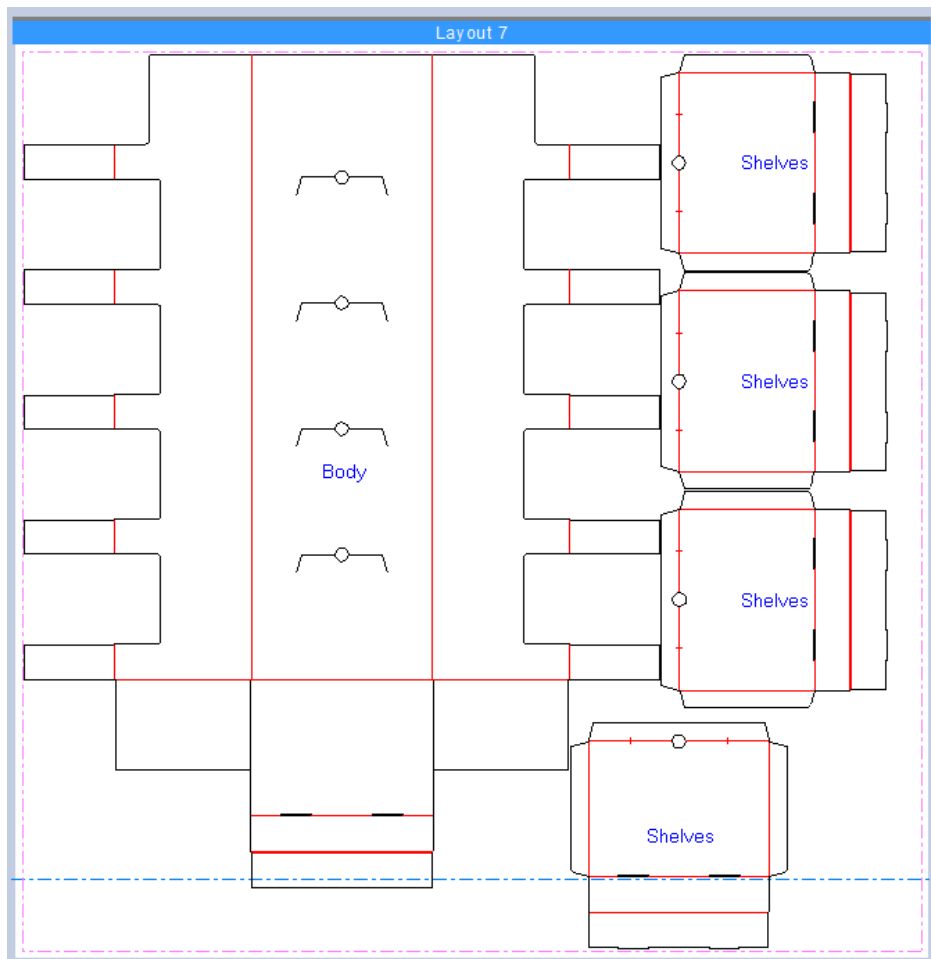

ArtiosCAD stacks multiple layouts vertically to the right of the parts.

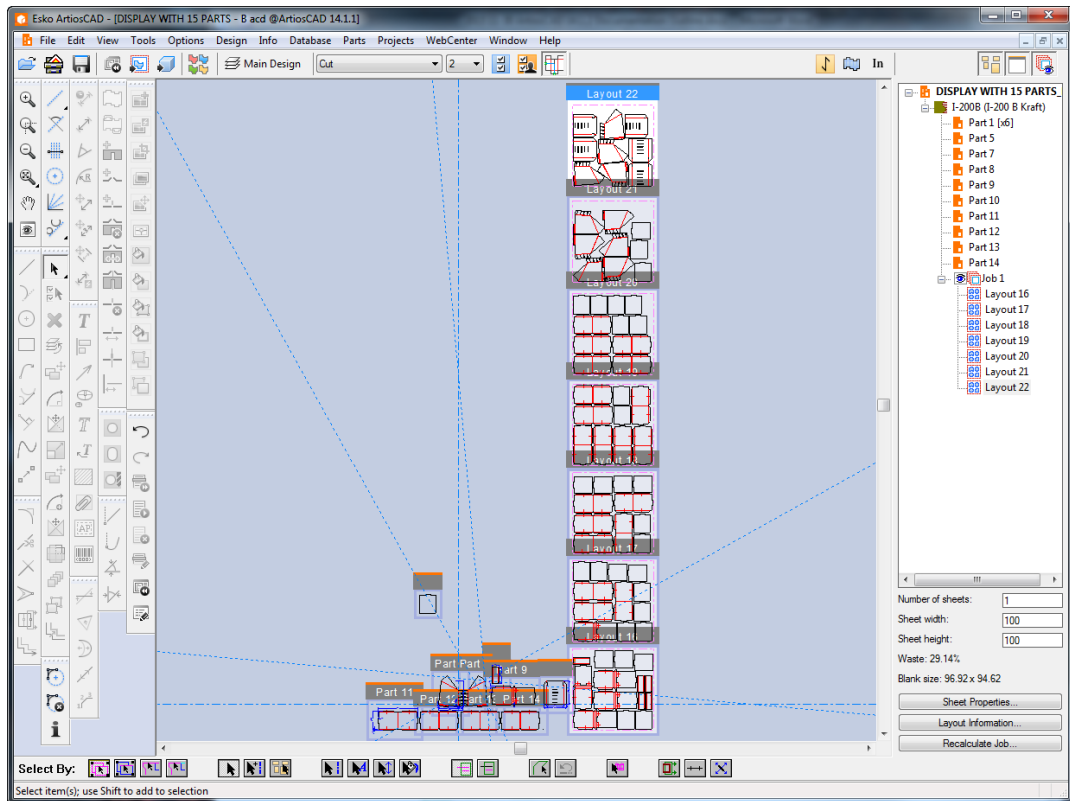

ArtiosCAD remembers your selections in the Layout Options dialog box and will reuse them if you create additional layouts in this canvas.

7. ArtiosCAD adds the job and layout(s) to the Parts List.

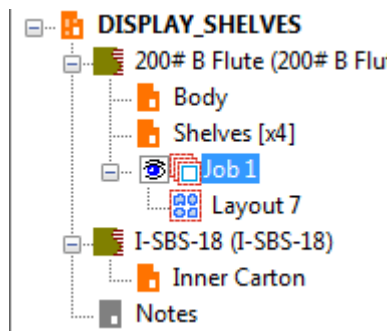

ArtiosCAD puts all production parts with the same board into the layout(s). It does not place empty parts or parts with no structural lines in the layout(s). If a part does not fit on the sheet, ArtiosCAD does not include it in the layout(s) and does not put it in the job parts list.

If ArtiosCAD encounters errors during the layout creation, when it is done creating the layouts, it displays the Job Information dialog box with a section listing the errors and warnings. In the example below, the job quantity required a number of layouts that exceeded the limit of 20 layouts per job.

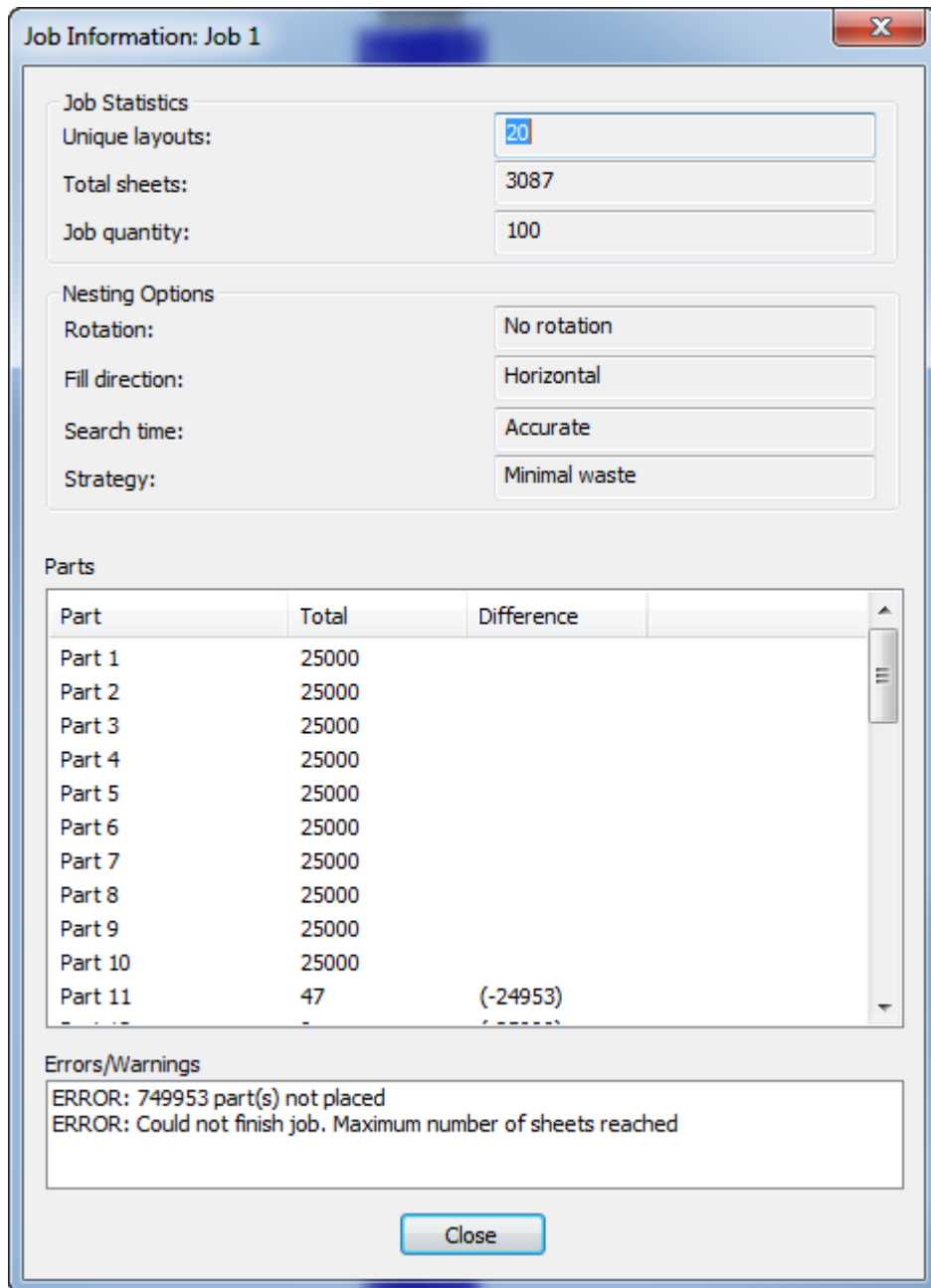

Recalculating a job

If you change parts, or want to change aspects of an automatically generated layout in a canvas, recalculate the job. Keep the following in mind:

- ArtiosCAD re-runs the parts through the nesting algorithm using the current part count.
- You will lose any manual changes you made to the layout.
- The number of physical copies of parts in a layout is irrelevant; it is the job quantity across all the layouts in the entire job that is the relevant number.
- If you recalculate an empty job, ArtiosCAD includes all production parts having the same board as the layout, except for those parts too large to fit on the sheet.

- If you recalculate a non-empty job, ArtiosCAD only uses the parts already in the job. Use Edit Layout to add or remove parts.
- ArtiosCAD recalculates the all the layouts in the job, not just a single layout.
- **Recalculate a job rather than using Undo/Redo.**

To recalculate a job, do the following:

1. In the Parts List, select either the job or one of its layouts.
2. At the bottom of the Parts List, click **Recalculate Job**. (Alternately, right-click a job and click **Recalculate Job** on the context menu, or click **Parts > Recalculate Job**).
3. In the Job Options dialog box, ArtiosCAD includes parts with different boards in different nodes by default and shows the same options as when you created the job or last recalculated it. Set the options as desired and click **Recalculate Job**.

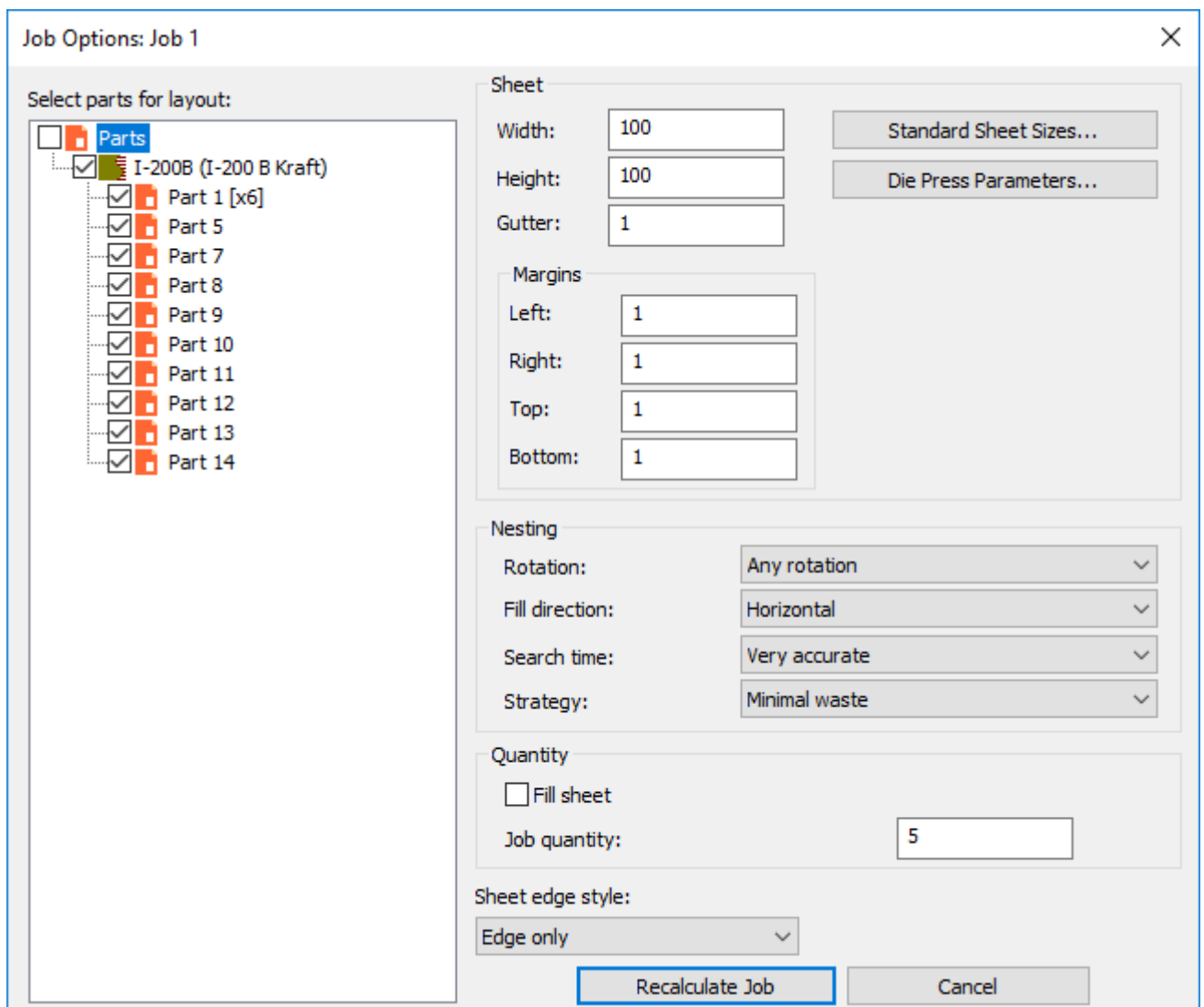

4. ArtiosCAD recalculates the job and rebuilds the layout(s) based on your changes.

Creating a layout manually

You can also create a layout manually.

1. Make sure all the parts in the canvas are clearly separated.
2. Click **Parts > Create Layout > <board code>**.
3. In the Layout Options dialog box, deselect all the parts to create an empty layout. Set the values for the sheet size, margins, gutter, nesting choices, quantities, and sheet edge style. The width and height must be greater than zero. The gutter and margins must be greater than or equal to zero.

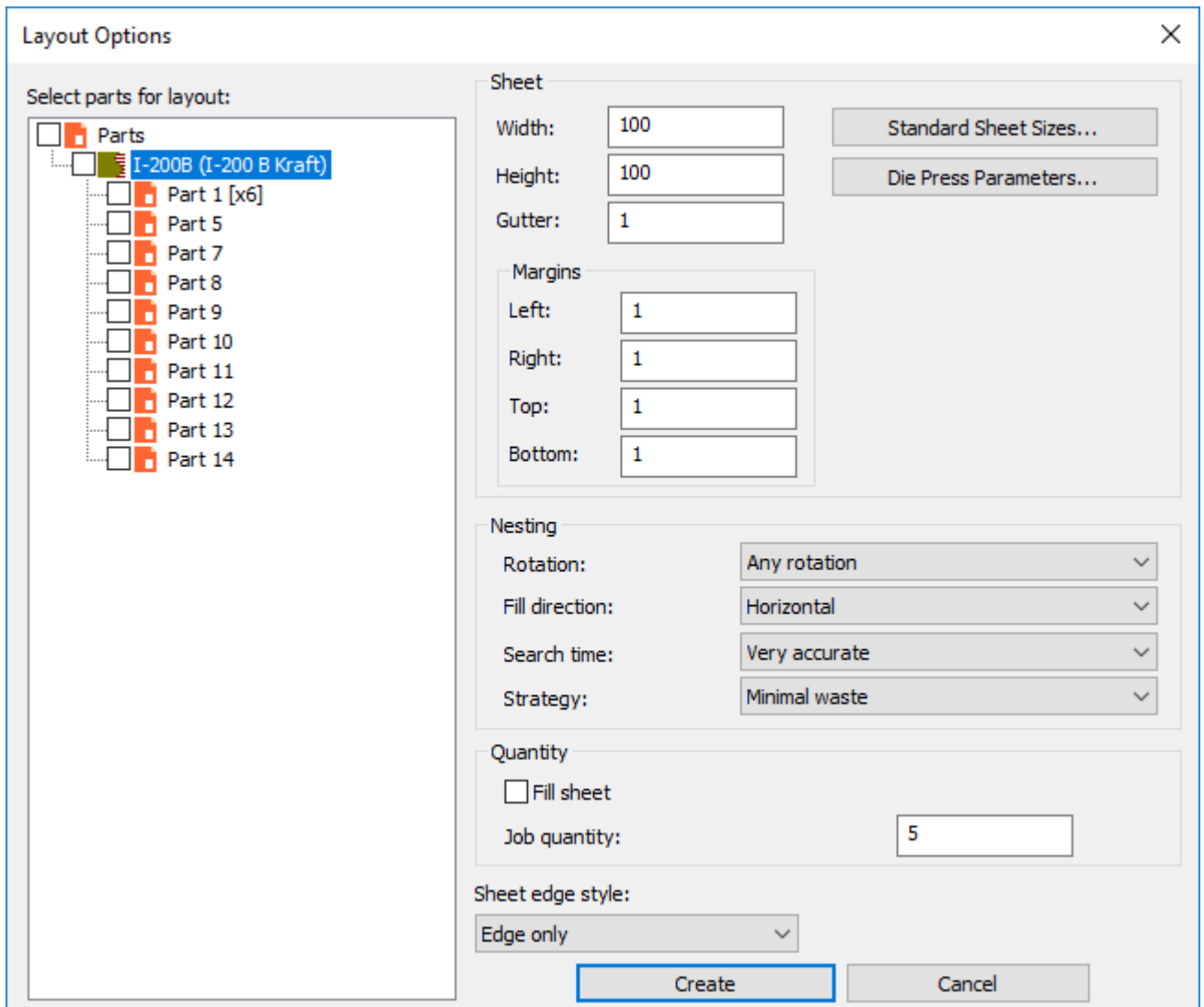

Alternately, you can choose a standard sheet size or a die press by clicking **Standard Sheet Sizes** or **Die Press Parameters**, and use the values from those sources.

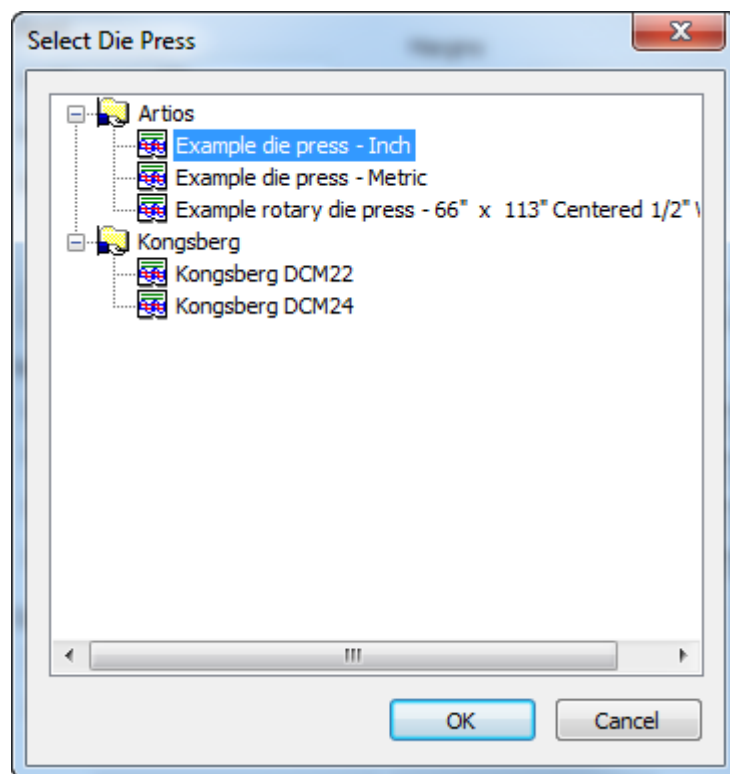
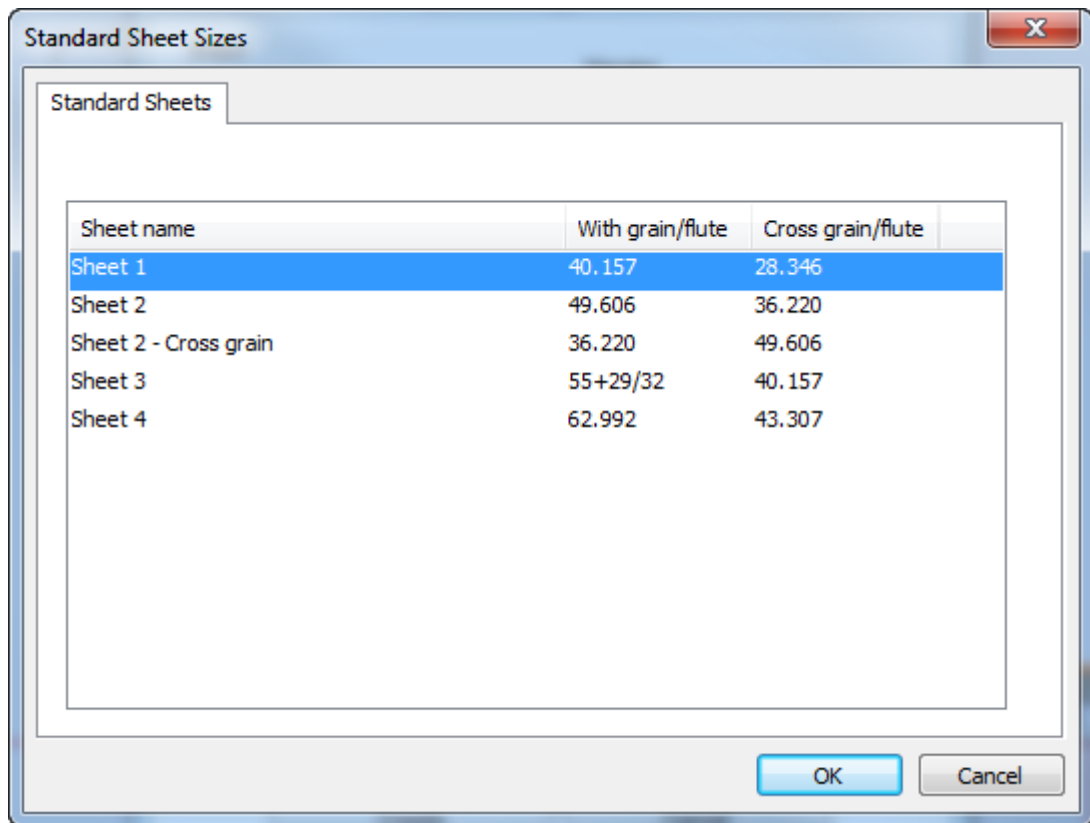

4. Click **Create** to create the layout.
5. ArtiosCAD creates the job and empty layout to the right of the other parts, and makes the layout the active part.

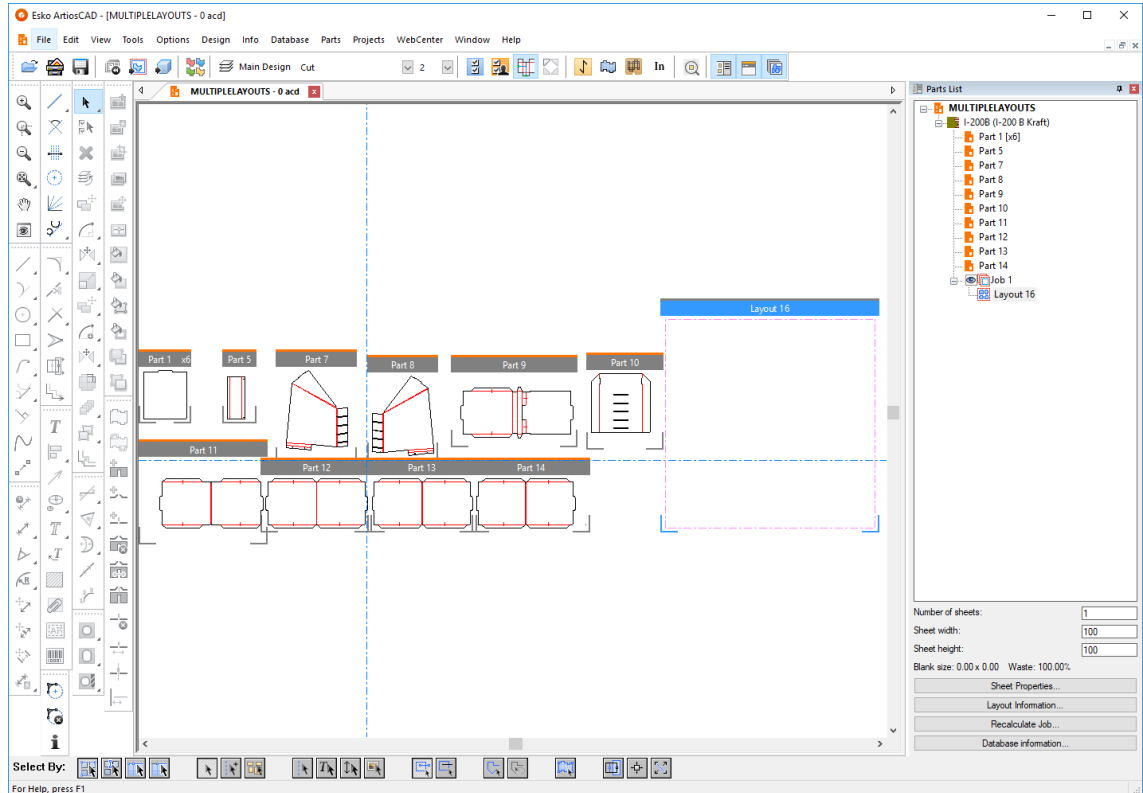

To get additional layouts in a manually created job, recalculate the job and ArtiosCAD will add layouts as needed per the number of copies set for the parts.

Adding parts to a layout

There are two ways to add parts to a layout: either by dragging them into the layout or by using Edit Layout, which is covered in the Edit Layout topic.

To add a part by dragging it into a layout, do the following:

1.  With the Select tool, drag the part onto the sheet, or use **Parts > Move Part**.
2. As you drag the part past the sheet border, ArtiosCAD changes the drag of the part frame to the part outline. Green drag means that the position of the part on the sheet is allowed; red drag means the position is not allowed.

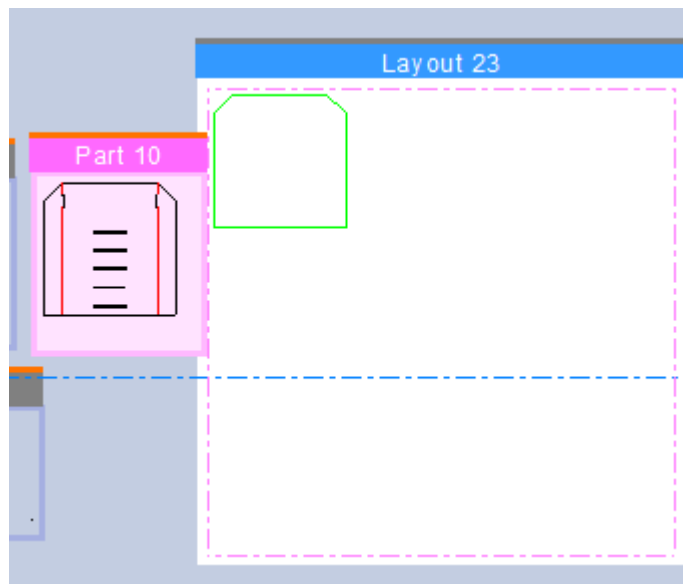

3. Click to place the part in the desired position. ArtiosCAD snaps to the borders of the sheet and to other parts with the gutter, but allows you to place it where you want.

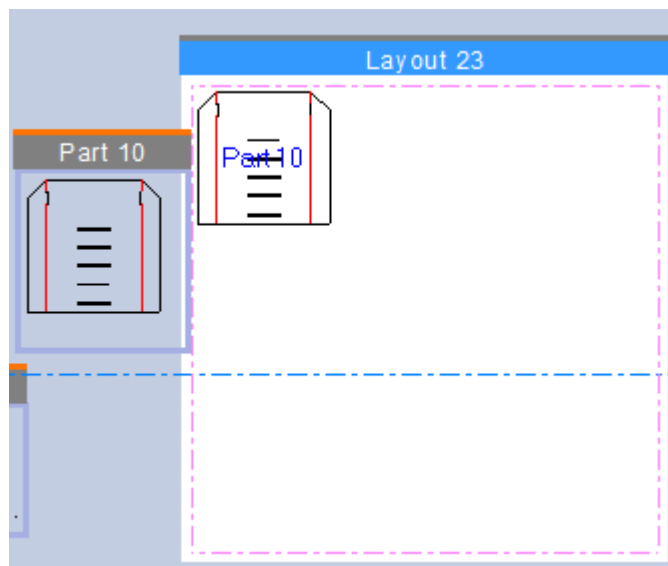

If ArtiosCAD shades the part grey, that means that either it is closer to another part than the gutter distance, or it overlaps another part, or that it overlaps the sheet border. If ArtiosCAD shades the part yellow, that means it has a different board than the layout.

4. Repeat as desired for other parts.

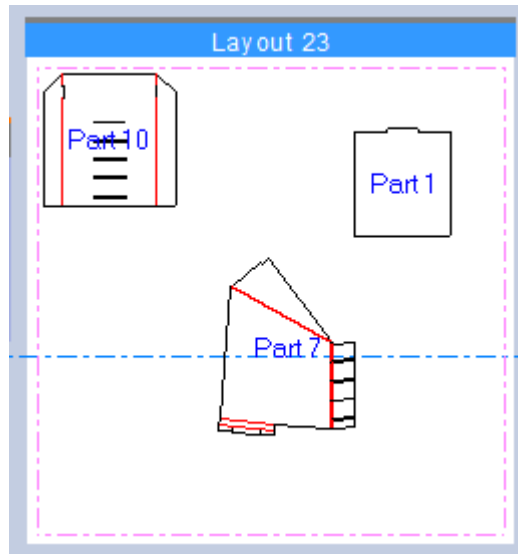

5. If desired, optimize the nesting of the layout by clicking **Recalculate Job**. ArtiosCAD adds layouts to the job as needed to satisfy the number of copies of the parts.

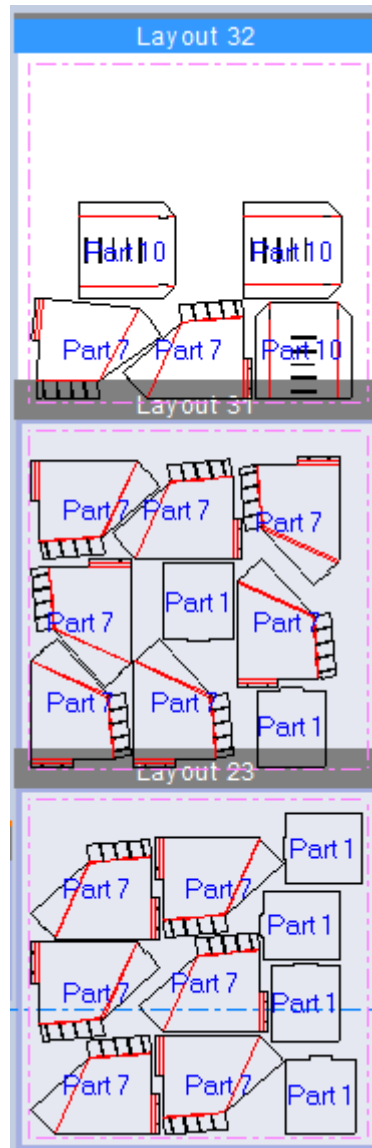

Editing a layout

Once parts are on a layout, you may want to adjust their positions. Use Edit Layout to add parts, copy, move, rotate, and remove parts from a layout. To activate Edit Layout, either click **Parts > Edit Layout**, or click inside a part on a layout while the Select tool is active. If you use the menu command, ArtiosCAD prompts you to select the part in a layout. The layout does not need to be the active part and this tool does not set the active part.

When active, Edit Layout displays a toolbar above the selected part containing more tools.



It also highlights the part on which it is acting.

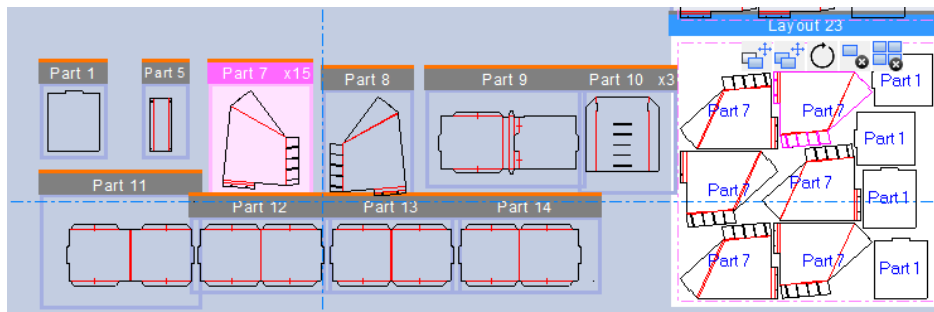

Moving a part on a layout

To move a part on a layout using Edit Layout, do the following:

1.  With a part selected and Edit Layout active, click **Move Part**.
2. Use the drag to move the part to the new position on the layout. Note that the cursor changes to a move cursor.
 - a) ArtiosCAD highlights if you are over a midpoint or endpoint for selecting a pick-up point, and likewise for setting a put-down point. ArtiosCAD highlights the outline of the part.
 - b) If you are moving a part which touches another part and shares the pick-up point, ArtiosCAD selects the part the cursor is in.
 - c) If you are not over a point, ArtiosCAD uses the blank center as the handle and indicates this with a crosshair.
3. Click to set the put-down point. ArtiosCAD highlights any midpoints or endpoints you drag over. ArtiosCAD moves the part and Edit Layout remains active on the selected part so you can do other things to the part.

Remember that red drag indicates an unwise (but allowed) put-down point and gray parts mean they overlap either other parts or the sheet border.

Copying a part on a layout

To copy a part on a layout using Edit Layout, do the following:

1.  With a part selected and Edit Layout active, click **Copy Part**.
2. Use the drag to copy the part to the new position on the layout. Note that the cursor changes to a copy cursor.
3. Click to set the put-down point. ArtiosCAD copies the part and Edit Layout remains active on the selected part so you can do other things to the part.

Remember that red drag indicates an unwise (but allowed) put-down point and gray parts mean they overlap either other parts or the sheet border.

Rotating a part on a layout

To rotate a part on a layout using Edit Layout, do the following:

1.  With a part selected and Edit Layout active, click **Rotate Part**.

2. Use the drag handle to rotate the part about its center by 5-degree increments. ArtiosCAD measures the angle from the part in the canvas, not the part on the layout, even though it is acting on the layout part. Hold down SHIFT for 90-degree increments. Set the angle to 0 to match the position of the part on the layout.
3. Release the mouse button to set the put-down point. ArtiosCAD rotates the part and Edit Layout remains active on the selected part so you can do other things to the part.

Remember that red drag indicates an unwise (but allowed) put-down point and gray parts mean they overlap either other parts or the sheet border.

Deleting a part from a layout

To delete a part on a layout using Edit Layout, do the following:

1.  With a part selected and Edit Layout active, click **Delete Part**. You may also press DEL when Edit Layout is active.
2. ArtiosCAD deletes the part from the layout.

Deleting a part from a job

To delete a part from a job using Edit Layout, do the following:

1.  With a part selected and Edit Layout active, click **Delete Part From Job**. You may also press SHIFT-DEL when Edit Layout is active.
2. ArtiosCAD deletes all copies of the part off every layout in the entire job.

Note that recalculating the job will not return the deleted part to the job. You must manually add it back to a layout to return it to the job.

Renaming a job or layout

Renaming a job or layout is just like renaming any other part. To rename a job or layout, do one of the following:

1. Right-click the job or layout in the Parts List, click **Rename Job** or **Rename Layout**, and enter the new name.
2. Or, single-click the job or layout and enter the new name.

ArtiosCAD shows the new name in the Parts List and in the part frame title bar of the layout (for a layout).

Deleting a layout

Deleting a layout is just like deleting any other part. To delete a layout, do the following:

1. Right-click the layout in the Parts List and click **Delete Layout** on the context menu.
2. Alternately, right-click anywhere over the layout and click **Delete Layout** on the context menu.
3. ArtiosCAD deletes the layout.

Note that after you have deleted a layout from a job, recalculating the job may recreate the layout.

Deleting a job

To delete a job, do one of the following:

1. Select the job in the Parts List, and then click **Parts > Delete Job**.
2. Right-click the job in the Parts List and click **Delete Job** on the context menu.

ArtiosCAD deletes the job.

Part Labels

To show or hide part labels on canvas layouts, use **View > Show Part Names in Layouts**.

Viewing information about a job or layout

To view information about a job or a layout, select it in the Parts List and then click one of the buttons at the bottom of the Parts List: **Job Information**, **Sheet Properties**, or **Layout Information**.

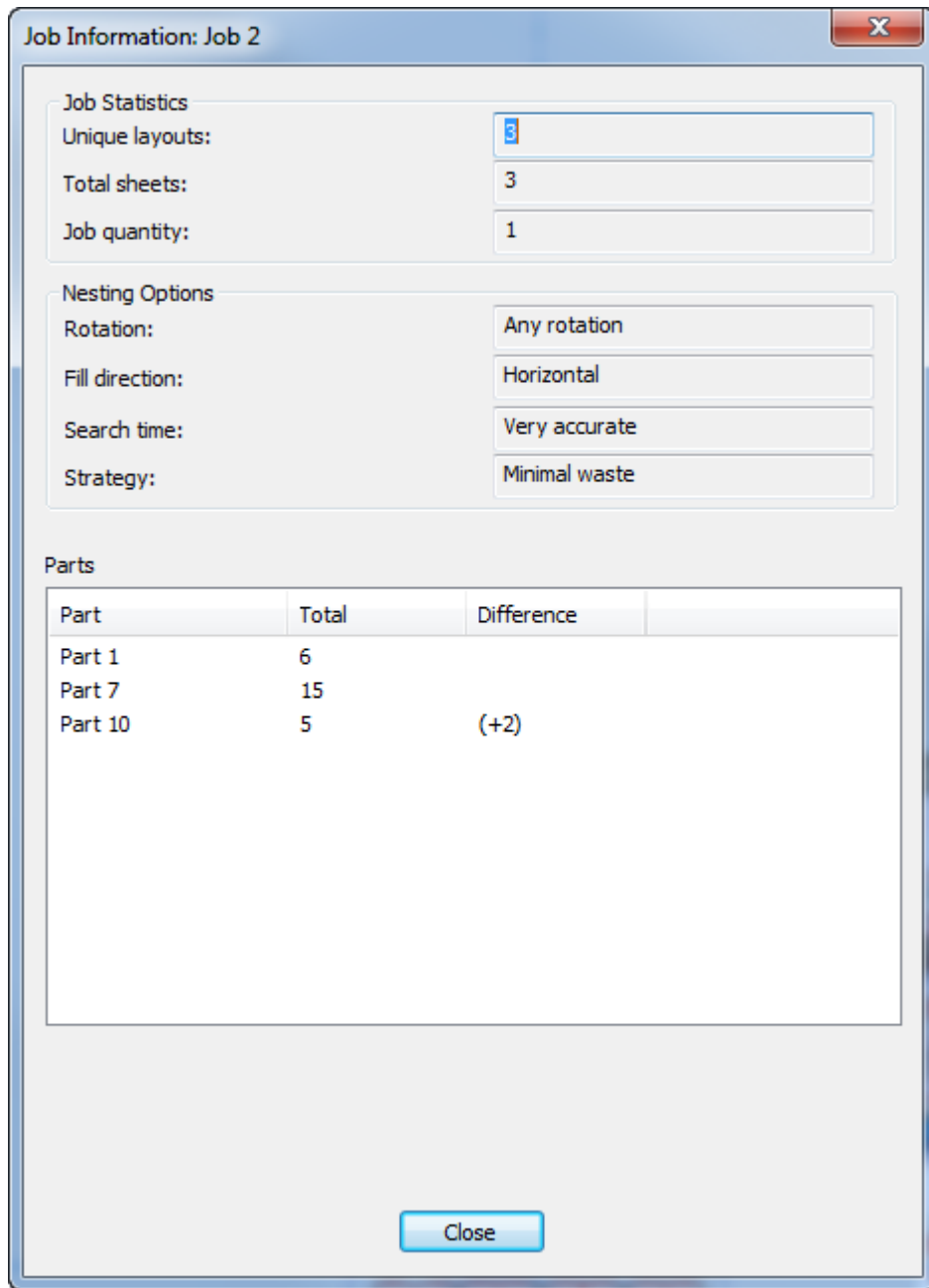

In the Job Information dialog box, Unique layouts are the number of different layouts contained in the job. Total sheets is the product of the number of layouts times their sheet counts. The Job quantity and Nesting Options each reflect the options you chose when you created the layout.

In the Parts group, ArtiosCAD shows the parts in the job, the number of parts contained in all the layouts comprising the job, and the difference between the number of parts contained in the layouts versus the job quantity.

In the Sheet Properties dialog box, ArtiosCAD displays information about the sheet used to make the layout - the width and height, the gutter, the margins, and the blank size of the layout residing on the sheet. You can also change the layout justification (its position on the sheet) and specify a sheet edge style. If you have used a geometry macro on this layout part, use **Delete Layout Annotation** to remove its product.

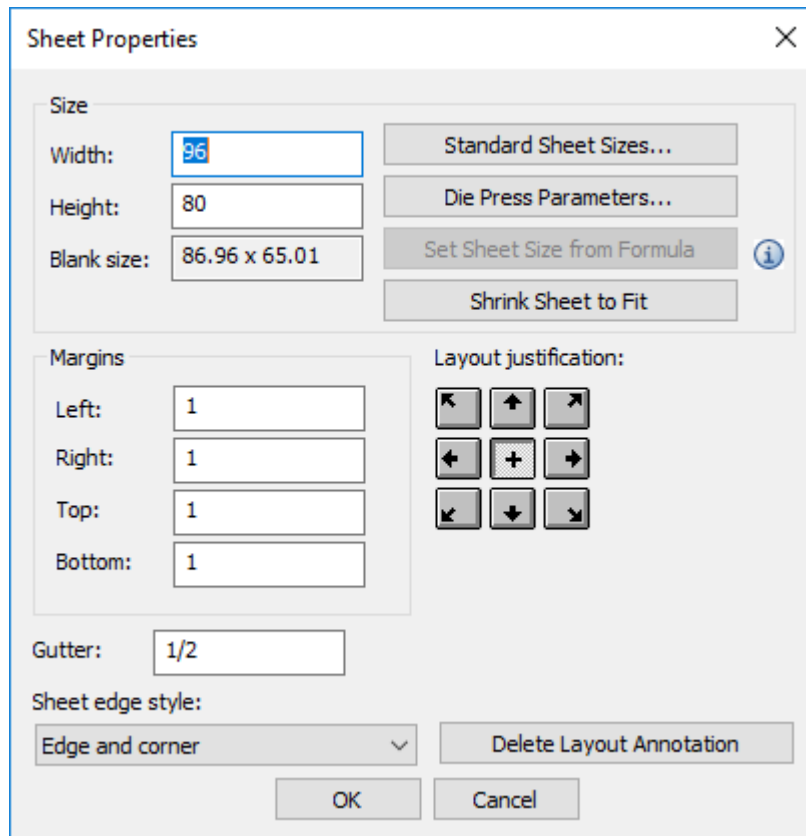

Change the values in the fields as desired, or click **Standard Sheet Sizes**, **Die Press Parameters**, or **Shrink Sheet to Fit** to change the size of the sheet(s). If you have a sheet size formula defined in Defaults (**Startup Defaults > Canvas Layout Options**, **Set Sheet Size from Formula** becomes available.

In the Layout Information dialog box, ArtiosCAD shows the waste percentage, the blank size, and lists the parts in the layout with their count.

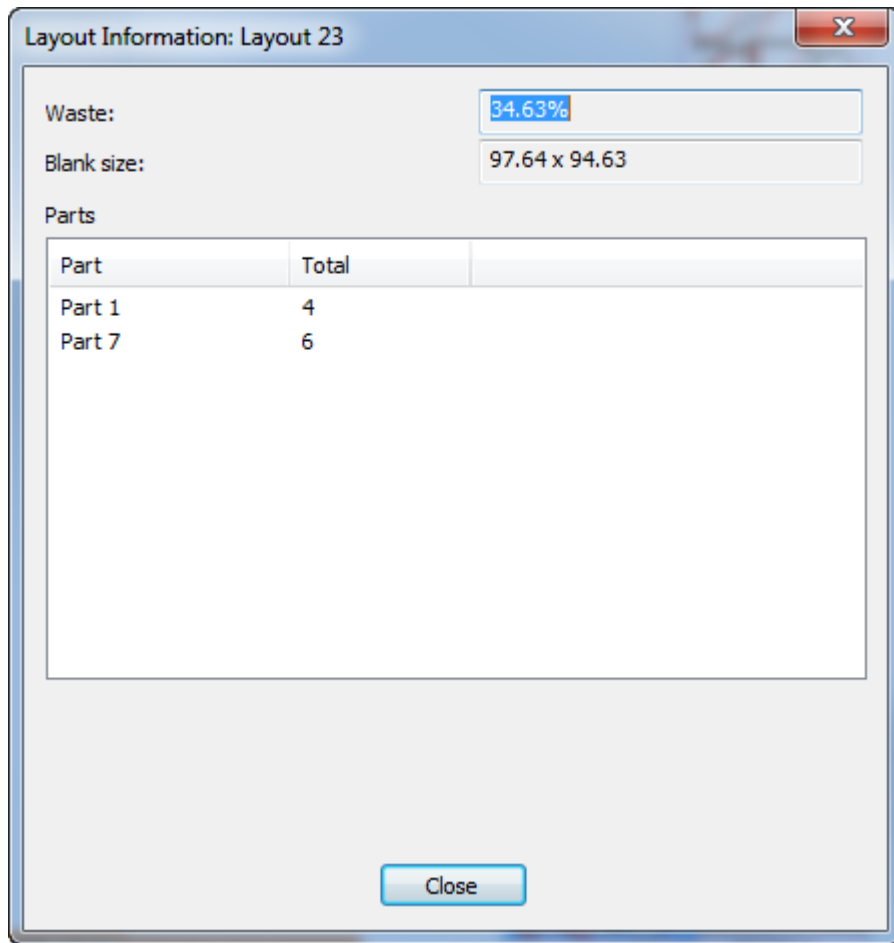

ArtiosCAD shows any errors or warnings about this layout part in this dialog box.

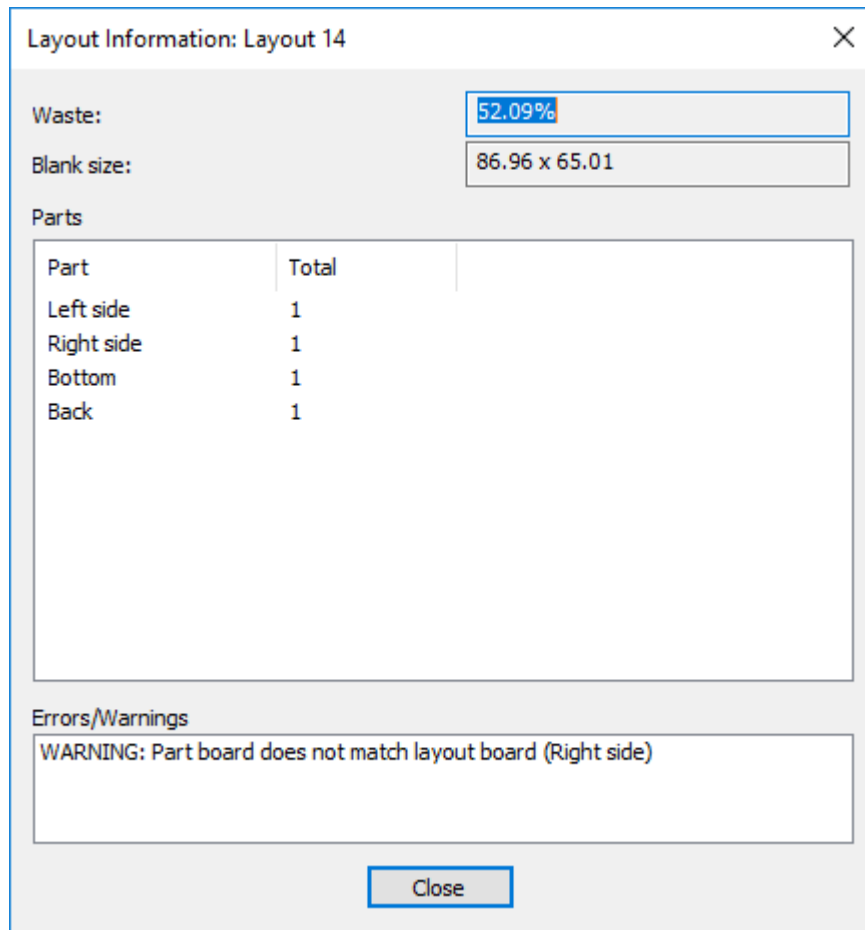

Converting a canvas layout to manufacturing

Converting a canvas layout to a manufacturing workspace follows the same general workflow as converting a production part or single design. To convert a canvas layout to a manufacturing workspace, do the following:

1. Make the canvas layout the active part.

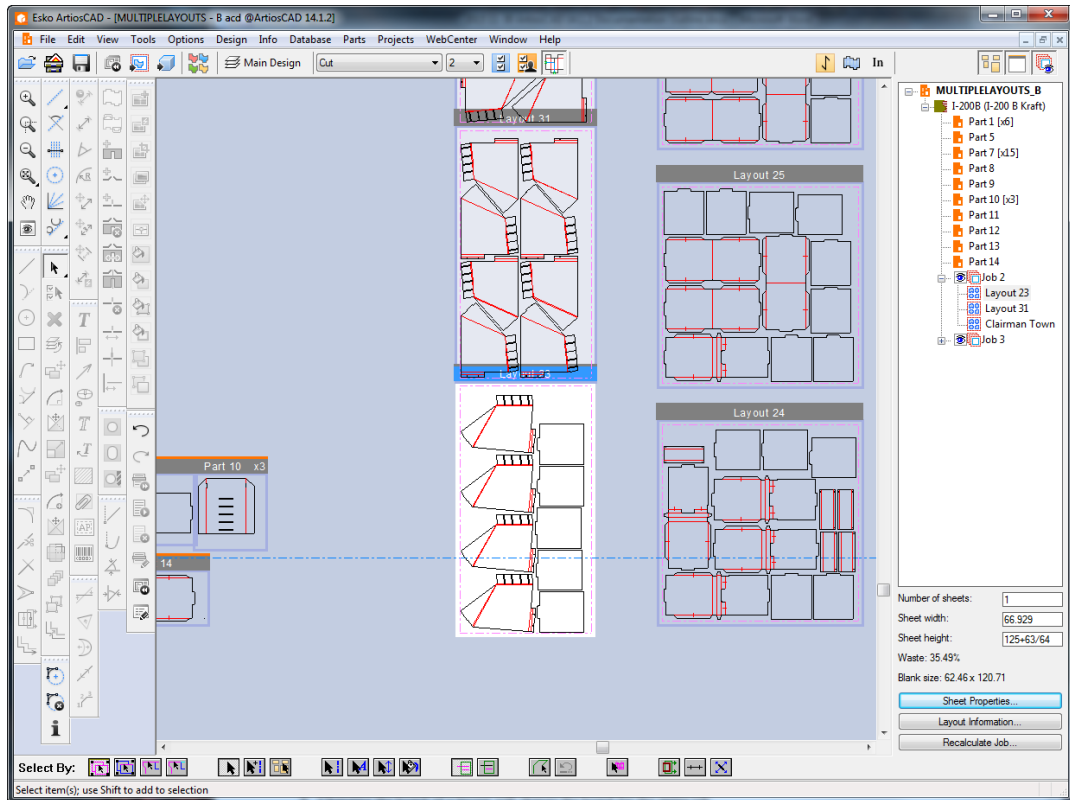

2.  Click **Convert to Manufacturing** on the View bar, or click it on the context menu by right-clicking the layout in the Parts List or when hovering over the layout itself.
3. Choose the parameter set and machines to use in the Layout Settings dialog box and click **OK**.
4. ArtiosCAD brings all the production parts from the canvas layout into manufacturing with the same positioning. It honors the sheet size, margins, and gutter from the canvas layout.

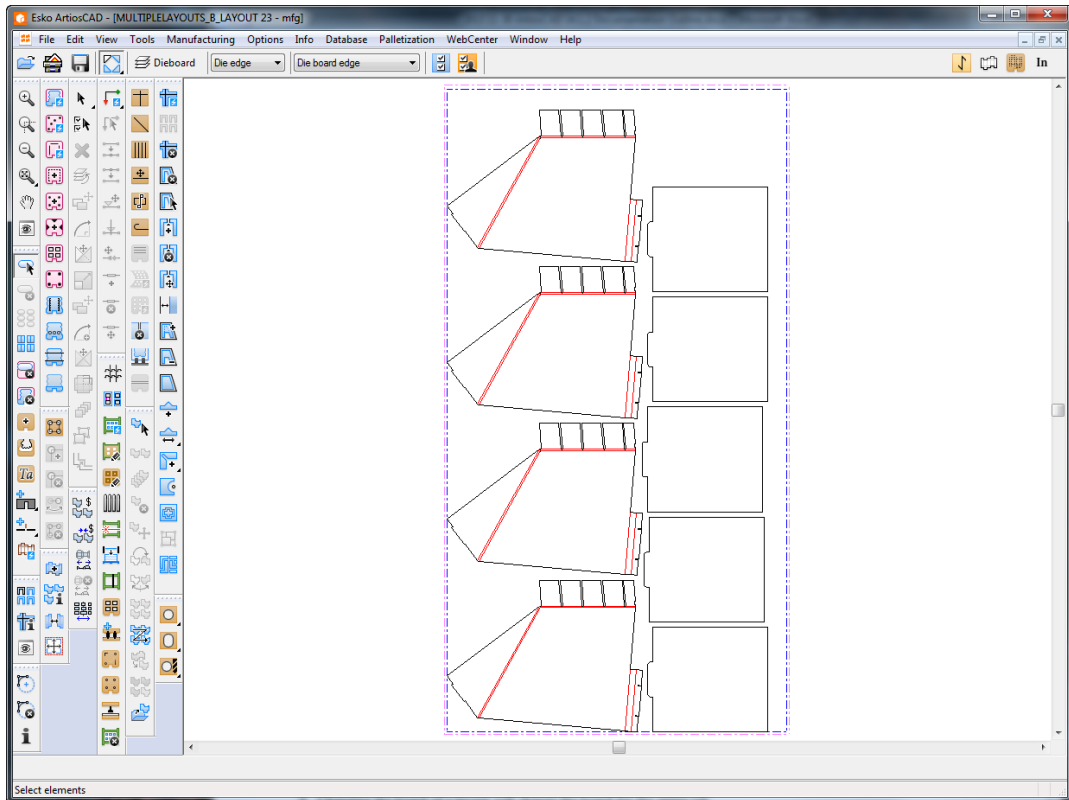

ArtiosCAD does not maintain a link between the canvas layout and the manufacturing workspace. There is no way to reuse the settings from a previous Convert to Manufacturing operation.

ArtiosCAD brings all the database information from the layout part into the manufacturing workspace.

Canvas layouts notes and warnings

Keep the following considerations in mind when using canvas layouts:

- Dynamic drafting does not provide intersection points from layout parts.
- Drafting and referencing a point within a layout part uses coordinates, not a point reference.
- You cannot select the sheet edge or lines of parts included in layouts. You may not edit them with normal tools.
- You can use temporary dimensions in a canvas layout using the snap points of the layout and the included parts.
- If you move geometry using Move instead of Move Part, ArtiosCAD shifts the geometry within the layout part.
- Most edit tools are unavailable when a layout part is the active part.
- Tools that switch parts when you interact with another part do not switch parts when you work with a layout part.
- Layout parts use the same grain direction and side as the canvas and the other parts in the canvas.
- Layout parts do not show up in the Save Parts dialog box and behave similarly as non-production parts.

- If you create a new part to the right of a layout part, turn off that layout part off and then on again, it will shift to the right of that new part. It is therefore easy to make the workspace quite spread out.
- Layout parts inherit the canvas database information. If you view the database information for a layout part, ArtiosCAD shows the Manufacturing database information dialog box, and the pieces of information inherited from the canvas are read-only. However, you can set the pieces that are not read-only such as the description, authorization, and revision description.
- If a part is contained in a layout and you change its type from Production to Non-production, ArtiosCAD does not remove it from the layout.
- Changing the board of a layout changes the board for the entire job.
- If you rebuild a canvas containing layout parts, the parts in the layouts may change size and overlap. The sheet size does not change during rebuild and ArtiosCAD may move the layouts so they do not overlap production parts. Recalculate the layout to get the parts sized correctly in the layouts.
- To add production parts to a canvas containing layouts, turn all the layouts off, add the production parts, and turn the layouts back on.

13. Manufacturing

Introduction to Manufacturing

Manufacturing is the module of ArtiosCAD that makes production tools from single designs. These tools are mounted in presses. As the sheets of board move through the press, the tools cut the design out of the sheet and remove interior and exterior waste.

Within Manufacturing are submodules that perform different tasks. Each module is purchased separately according to your individual needs.

Layout manually arranges single designs on sheets of board.

DieMaker creates flat dies.

Rotary DieMaker creates rotary dies.

Stripping removes interior and exterior waste.

Intelligent Layout automatically makes many different layouts, compares their waste percentages, and lets you choose the best layout to make.

Cost/Estimating calculates how much a layout will cost to make and run across multiple cost centers.

Intelligent Counters, in the context of Manufacturing, manually arranges counters on a sheet of counter material for milling on a counter maker.

Designing manufacturing tools usually follows this general workflow:

1. Create a layout.
 - Create a new blank layout and add single designs to it, **or**
 - Convert a single design to a layout, **or**
 - Convert a single design to a Standard Sheet layout.
2. Create tooling for that layout.
 - Create a die wood edge.
 - Add stripping rules, carrier rules, and a mounting bar. The stripping rules cut the waste into smaller pieces for easier removal, and the carrier rules prevent the sheet from sagging as it moves through the press.
 - If using a rotary dieboard, create rule paths and add splits if necessary.
 - Add stripping components, rules, pins, and blocks to rid the sheet of waste. The upper and lower stripping boards (also known as top and bottom, male and female) are created automatically.

Within this two-part workflow there are additional decisions to make. Will you make your own nest or use the automatic nesting tools? Is Intelligent Layout or Costing/Estimating available? If you are a folding carton user and have Intelligent Layout, do your designs have print items defined? If you are a corrugated user and have Costing/Estimating, do you have an idea of possible order quantities desired?

When you open saved Manufacturing files, the layers displayed are set according to the defaults in **Options > Defaults > Shared Defaults > Design Defaults > Default View Mode**.

Manufacturing prerequisites

Before designing a layout and creating tooling, you should make sure of the following:

- Machines are set up in Defaults.
- Cost centers are set up in Defaults (if you plan to use Intelligent Layout and/or Costing and Estimating).
- Board weights and costs are set correctly in DataCenter Admin.
- If intending to use Standard Sheet Layout, that standard sheet sizes are set up in Defaults. See the *Defaults* chapter for more information.

In addition, the Manufacturing modules have the following limits:

- For manual layout, the maximum number of repeated designs is 300.
- For Intelligent Layout, the maximum number of repeated designs is 255.
- The maximum number of different designs in a layout is 100.
- The maximum number of design/print item combinations in Intelligent Layout is 100.
- A single design may have up to 100 print items.
- Each single design included must have a unique filename.

Standard Sheet Layout

Standard Sheet Layout quickly nests a single design on a sheet and lets you choose the layout to make from a list of automatically generated layouts. It works with one single design workspace; to make a combination layout with more than one single design, either use manual layout or Intelligent Layout. Standard Sheet Layout requires Intelligent Layout.

To use it, do the following:

1. Open the single design to turn into a layout.
2. Click **File > Standard Sheet Layout**. The Standard Sheet Layout dialog box opens.

Sheet Layout Parameters tab

The Sheet Layout Parameters tab is the first tab in the Standard Sheet Layout dialog box as shown below.

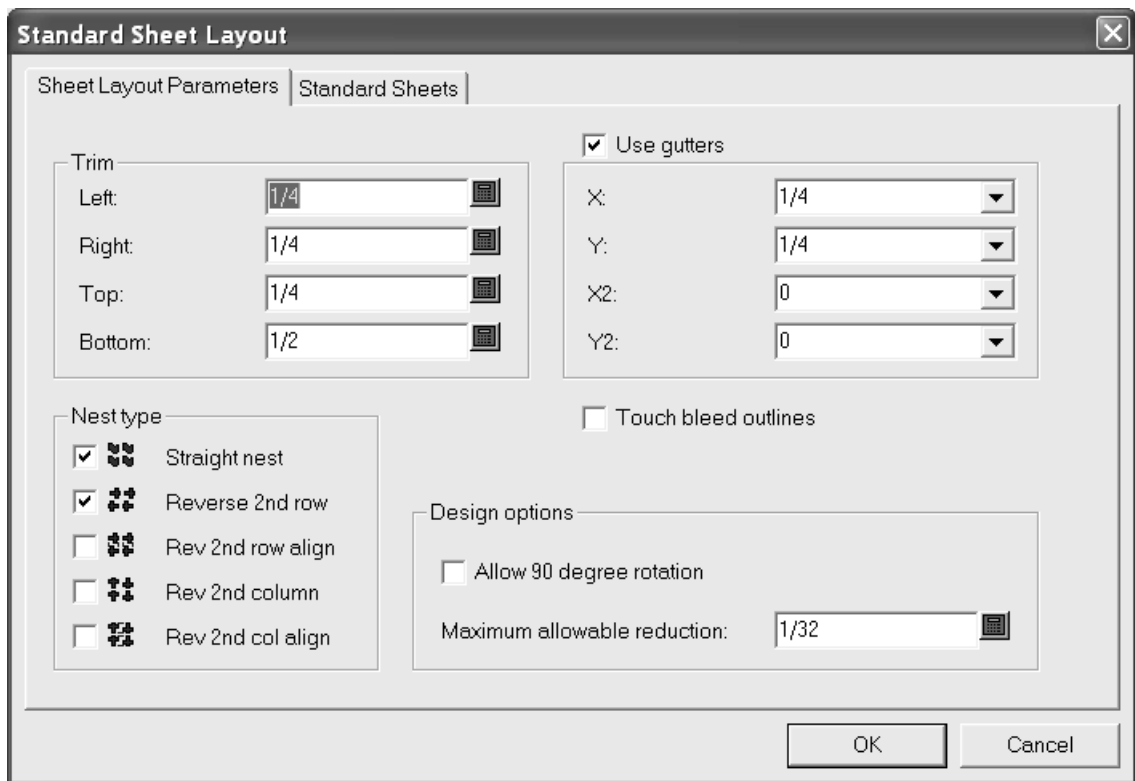

In the **Trim** group, the fields set the trim tolerances at the edge of the sheet. Set them to be less than the maximum values for the presses used to produce the layout.

Use gutters inserts gutters between designs in the nest when it is checked. When it is clear, the single designs touch. The values in the **X** and **Y** drop-down list boxes set the gutters in X and Y for the first and second rows and columns of single designs in the layout. The values in the **X2** and **Y2** drop-down list boxes set the gutters between the second and third rows and columns. These are repeated as appropriate between all the rows and columns in the layout.

In the **Nest type** group, the checkboxes control the kinds of nests made automatically. Select the checkboxes next to the type of nests to use; clear those next to undesired nests.

Touch bleed outlines controls whether the designs touch using the bleed outlines or the edges of the designs. If **Use gutters** is enabled in conjunction with **Touch bleed outlines**, the gutters are inserted between the bleed outlines instead of the edges of the designs.

In the **Design options** group, **Allow 90 degree rotation** lets designs rotate so they are cross-grain; the sheet grain runs in the longer direction. **Maximum allowable reduction** is the maximum distance that could be shaved off each design in order for another row or column to fit on the sheet. If such a cutback is possible in each design, a row or column will overlap the edge of the sheet when a layout is suggested and there will be values in the various **Reduction** fields of the Sheet Layout Results dialog box.

Standard Sheets tab

1. Click **Standard Sheets** to view or modify the values on the Standard Sheets tab as shown below.

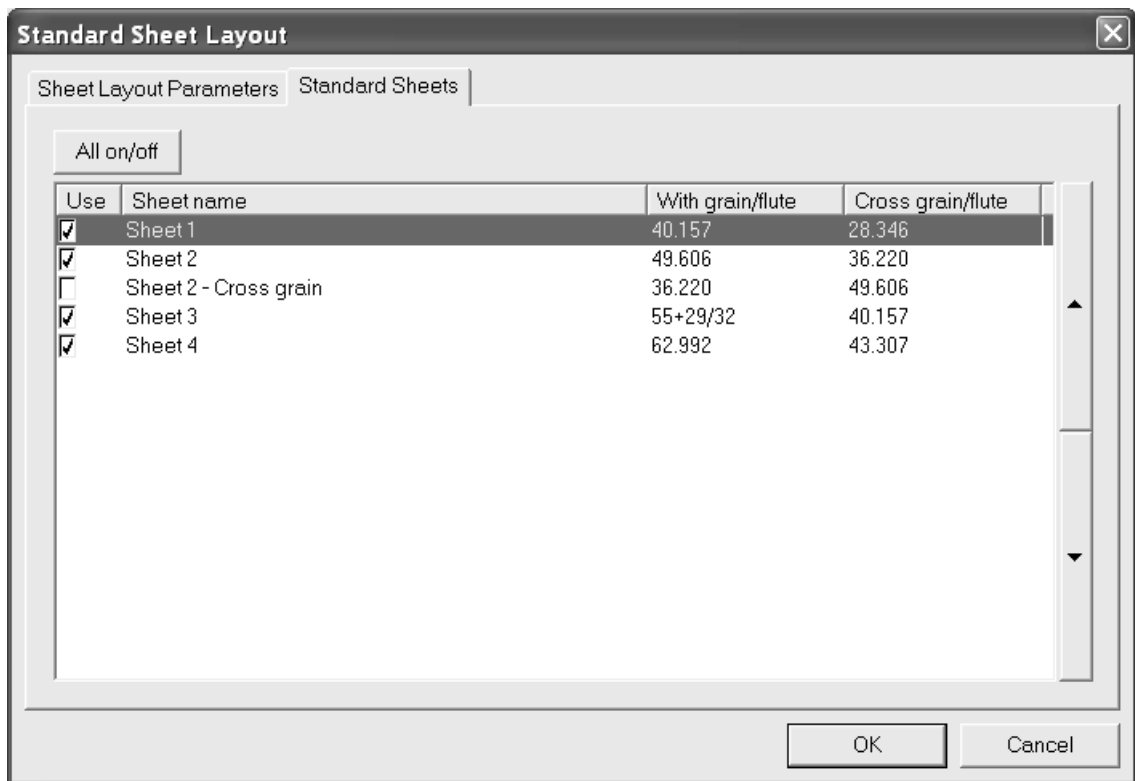

Listed on the tab are the standard sheets that are defined in Defaults. To use a sheet for possible layout solutions, check its box in the **Use** column. To disable its use, clear the checkbox. To toggle the usage of all sheets at once, click **All on/off**.

The arrows on the side of the dialog box move the currently-selected sheet up and down in the list of sheets. The order of sheets on this tab is the same order used to present layout results.

Viewing results

1. Click **OK** to generate prospective layouts. The Sheet Layout Results dialog box opens as shown below.

Sheet Layout Results

Sheet name	With ...	Cross ...	%Waste	#X	#Y	T...	Direc...	Nest Type	Reduction
Sheet 1	40.157	28.346	72.94	2	1	2		Straight	
Sheet 1	40.157	28.346	72.94	2	1	2		Reversed 2nd row	
Sheet 2	49.606	36.220	48.57	3	2	6		Straight	
Sheet 2	49.606	36.220	74.29	3	1	3		Reversed 2nd row	20.806
Sheet 3	55+29/32	40.157	58.84	3	2	6		Straight	
Sheet 3	55+29/32	40.157	72.56	4	1	4		Reversed 2nd row	16.869
Sheet 4	62.992	43.307	54.84	4	2	8		Straight	0.002
Sheet 4	62.992	43.307	54.84	4	2	8		Reversed 2nd row	

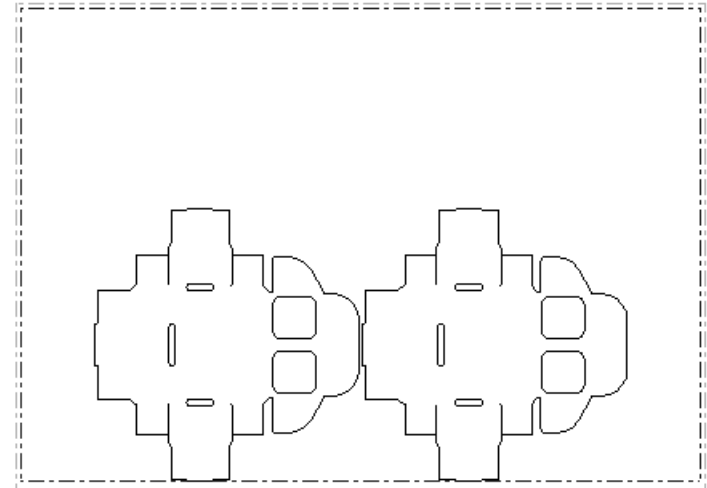

Sheet

← Reduction:

X:

Y:

Oneup

Reduction:

X:

Y:

The list of prospective layouts is initially sorted first by sheet used and then by nest type. Click any column heading to sort by that column. The first three columns repeat the entries in the sheet table, while the remaining columns display information about the prospective layout. **%Waste** is the percentage of waste on the sheet ignoring holes in the single designs. **#X** is the number of single designs across the sheet and **#Y** is number back. **Total** displays the number of single designs on the sheet. The **Direction** column is blank if the all single designs are with-grain, or displays **Rotated** if that option was enabled and used to construct the prospective layout.

The selected prospective layout is shown in the preview window. Click another layout to see its preview.

The **Sheet** group shows the grain/corrugation direction and the amount of total reduction needed for another row or column of single designs to fit on the sheet.

The **Oneup** group shows the reduction needed in each single design for another row or column of single designs to fit on the sheet. If the single design was rotated, the word **Rotated** appears in red.

Click **Cancel** to return to the Standard Sheet Layout dialog box to adjust parameters.

1. Click **Make Layout** to make the selected prospective layout.
2. Choose the parameter set and presses for the layout and click **OK**.

3. The layout is created and can be modified as desired.

Notes and warnings

Sheet sizes have the with-grain direction first and the cross-grain direction second.

A single design is initially placed on the sheet so that its grain direction matches that of the sheet. If your single design is being rotated inexplicably and you did not check **Allow 90 degree rotation**, check its grain direction in Designer to see if it matches that of the sheet. The **Reverse** nest types and the gutters are implemented relative to the laid-out orientation of the single design.

After using Standard Sheet Layout, the original single design workspace is still open and unsaved behind the layout. When you save the workspace, the manufacturing parameter set information used to construct the layout is saved in it. If you later convert it to manufacturing or another Standard Sheet Layout, the presses you selected the first time are selected by default and the **Use design parameter set** and **Use design press** checkboxes are checked. To choose a different parameter set or press, deselect those checkboxes.

To create a workspace that does not have this manufacturing information in it, create an Information Filter output that does not include Manufacturing parameter sets, and then output the workspace through that Output.

If the sheet size of the selected prospective layout conflicts with the one in the manufacturing parameter press, a warning dialog box appears as shown below after **Make Layout** is clicked. Choose the appropriate choice and click **OK**, or click **Cancel** to return to the single design.

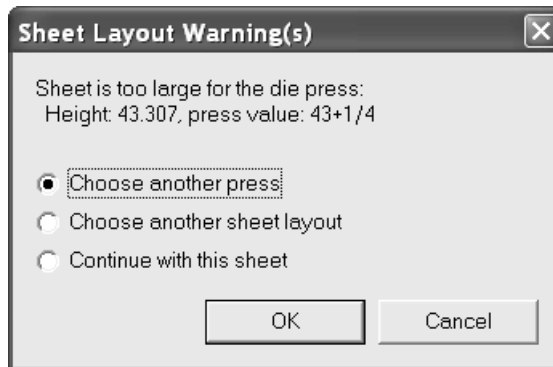

If the trim is too small, the following dialog box is displayed. Click **OK** to make the layout or click **Cancel** to return to the single design.

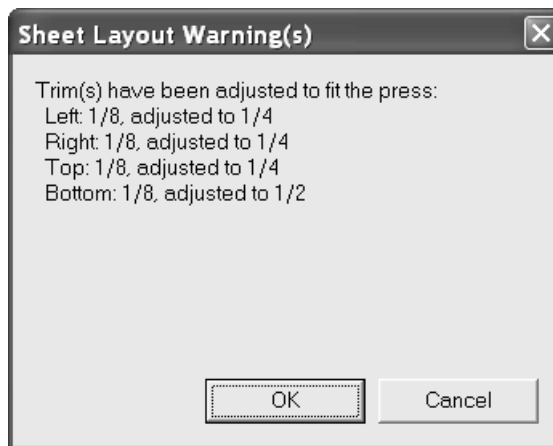

If the trim is too small and the sheet is too big, the following dialog box appears. Choose the appropriate choice and click **OK** to make the layout, or click **Cancel** to return to the single design.

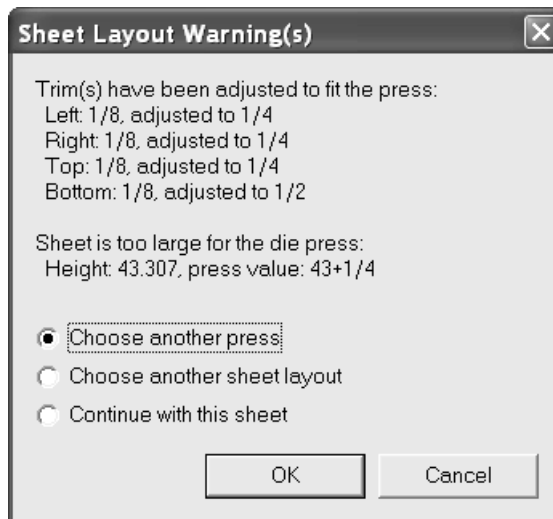

Further examples

Shown below are further examples of the Sheet Layout Results dialog box with all sheets and nest types selected, as well as **Allow 90 degree rotation** enabled.

Sheet Layout Results [X]

Sheet name	With ...	Cross ...	%Waste	#X	#Y	T...	Dir...	Nest Type	Reduction
Sheet 1	40.157	28.346	72.94	2	1	2		Straight	
Sheet 1	40.157	28.346	72.94	2	1	2	Rotated	Straight	
Sheet 1	40.157	28.346	72.94	2	1	2		Reversed 2nd row	
Sheet 1	40.157	28.346	72.94	1	2	2	Rotated	Reversed 2nd row	
Sheet 1	40.157	28.346	72.94	2	1	2		Reversed 2nd row aliç	
Sheet 1	40.157	28.346	72.94	2	1	2	Rotated	Reversed 2nd row aliç	
Sheet 1	40.157	28.346	45.88	2	2	4		Reversed 2nd col	
Sheet 1	40.157	28.346	59.41	3	1	3	Rotated	Reversed 2nd col	
Sheet 1	40.157	28.346	72.94	2	1	2		Reversed 2nd col aliç	
Sheet 1	40.157	28.346	72.94	2	1	2	Rotated	Reversed 2nd col aliç	
Sheet 2	49.606	36.220	48.57	3	2	6		Straight	
Sheet 2	49.606	36.220	48.57	3	2	6	Rotated	Straight	

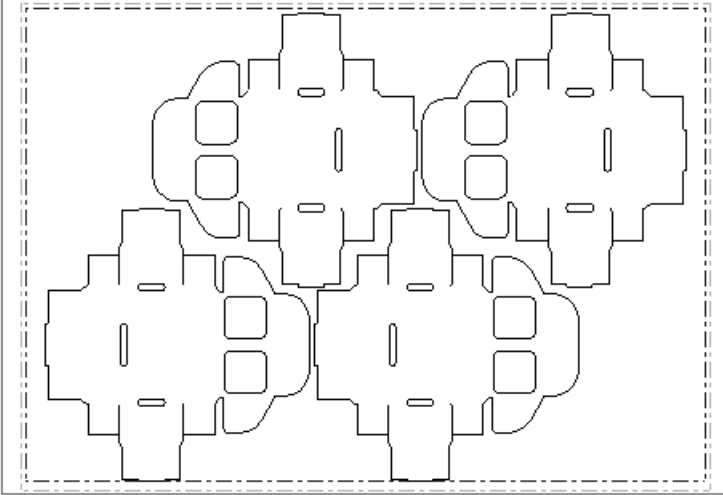

Sheet

← Reduction:

X:

Y:

Oneup

Reduction:

X:

Y:

Make Layout
Cancel

Sheet Layout Results [X]

Sheet name	With ...	Cross ...	%Waste	#X	#Y	T...	Dirac...	Nest Type	Reduction
Sheet 1	40.157	28.346	72.94	2	1	2		Straight	
Sheet 1	40.157	28.346	72.94	2	1	2	Rotated	Straight	
Sheet 1	40.157	28.346	72.94	2	1	2		Reversed 2nd row	
Sheet 1	40.157	28.346	72.94	1	2	2	Rotated	Reversed 2nd row	
Sheet 1	40.157	28.346	72.94	2	1	2		Reversed 2nd row aliç	
Sheet 1	40.157	28.346	72.94	2	1	2	Rotated	Reversed 2nd row aliç	
Sheet 1	40.157	28.346	45.88	2	2	4		Reversed 2nd col	
Sheet 1	40.157	28.346	59.41	3	1	3	Rotated	Reversed 2nd col	
Sheet 1	40.157	28.346	72.94	2	1	2		Reversed 2nd col aliç	
Sheet 1	40.157	28.346	72.94	2	1	2	Rotated	Reversed 2nd col aliç	
Sheet 2	49.606	36.220	48.57	3	2	6		Straight	
Sheet 2	49.606	36.220	48.57	3	2	6	Rotated	Straight	

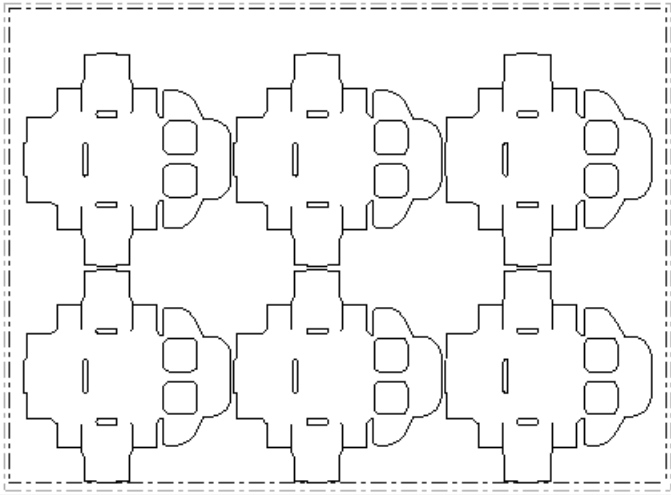

Sheet

← Reduction:

X:

Y:

Oneup

Reduction:

X:

Y:

Make Layout **Cancel**

Sheet Layout Results [X]

Sheet name	With ...	Cross ...	%Waste	#X	#Y	T...	Dirac...	Nest Type	Reduction
Sheet 2	49.606	36.220	48.57	3	2	6		Straight	
Sheet 2	49.606	36.220	48.57	3	2	6	Rotated	Straight	
Sheet 2	49.606	36.220	74.29	3	1	3		Reversed 2nd row	20.806
Sheet 2	49.606	36.220	65.72	2	2	4	Rotated	Reversed 2nd row	
Sheet 2	49.606	36.220	48.57	3	2	6		Reversed 2nd row aliç	
Sheet 2	49.606	36.220	48.57	3	2	6	Rotated	Reversed 2nd row aliç	
Sheet 2	49.606	36.220	65.72	2	2	4		Reversed 2nd col	
Sheet 2	49.606	36.220	74.29	3	1	3	Rotated	Reversed 2nd col	17.597
Sheet 2	49.606	36.220	48.57	3	2	6		Reversed 2nd col aliç	
Sheet 2	49.606	36.220	48.57	3	2	6	Rotated	Reversed 2nd col aliç	
Sheet 2 - Cros36.220	49.606	48.57	48.57	3	2	6		Straight	
Sheet 2 - Cros36.220	49.606	48.57	48.57	3	2	6	Rotated	Straight	

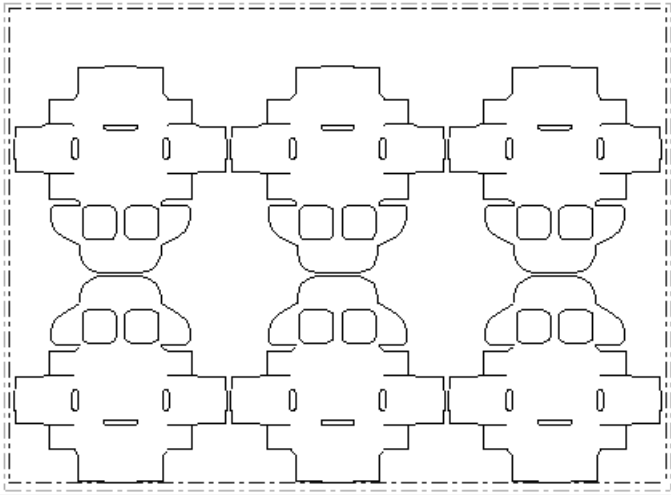

Sheet

← Reduction:

X:

Y:

Oneup

Rotated Reduction:

X:

Y:

Sheet Layout Results

Sheet name	With ...	Cross ...	%Waste	#X	#Y	T...	Dirac...	Nest Type	Reduction
Sheet 3	55+29/32	40.157	58.84	3	2	6		Reversed 2nd col alig	
Sheet 3	55+29/32	40.157	58.84	3	2	6	Rotated	Reversed 2nd col alig	
Sheet 4	62.992	43.307	54.84	4	2	8		Straight	0.002
Sheet 4	62.992	43.307	66.13	3	2	6	Rotated	Straight	
Sheet 4	62.992	43.307	54.84	4	2	8		Reversed 2nd row	
Sheet 4	62.992	43.307	49.19	3	3	9	Rotated	Reversed 2nd row	
Sheet 4	62.992	43.307	54.84	4	2	8		Reversed 2nd row alig	
Sheet 4	62.992	43.307	66.13	3	2	6	Rotated	Reversed 2nd row alig	
Sheet 4	62.992	43.307	49.19	3	3	9		Reversed 2nd col	
Sheet 4	62.992	43.307	43.55	5	2	10	Rotated	Reversed 2nd col	
Sheet 4	62.992	43.307	54.84	4	2	8		Reversed 2nd col alig	0.002
Sheet 4	62.992	43.307	66.13	3	2	6	Rotated	Reversed 2nd col alig	

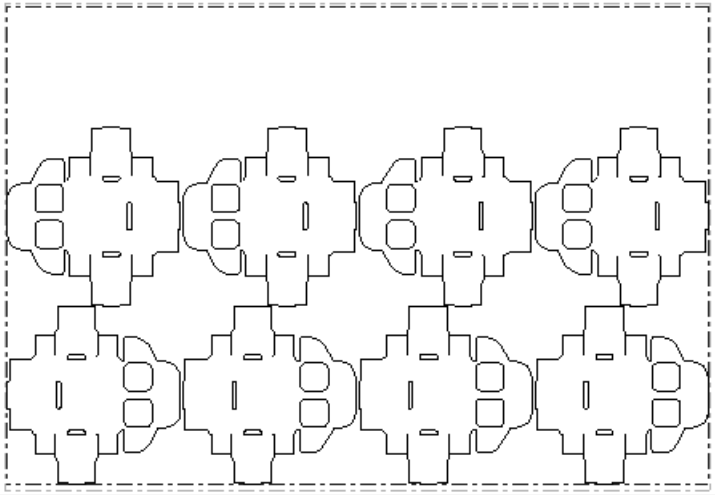

Sheet

Reduction:

X:

Y:

Oneup

Reduction:

X:

Y:

Make Layout
Cancel

Intelligent Layout and Costing/Estimating

Intelligent Layout performs automatic sheet layout calculation. Costing/Estimating provides detailed production costing information for your estimators.

There are two workflows when using Costing/Estimating. One is if you have Intelligent Layout as well, and the other is if you do not have Intelligent Layout. Costing/Estimating without Intelligent Layout is designed to be particularly useful in the following scenarios:

1. If you already know what the layout will be (e.g. if you have pre-made dies, or if there will be one design per sheet).
2. If you will have a long run of a layout with a straight nest using the maximum sheet size.

If you have Intelligent Layout without Estimating, you can automatically make layouts based on minimizing printing and diecutting costs. Note that the board cost, die cost, and press cost information need to be approximately correct (within a factor of two), even if you are not using the cost results, because these costs affect how layouts are selected.

Costing/Estimating enables the following:

1. Item cost centers such as folder-glurers

2. The Ink coverage, Prompted variables, Cost breakdown, and Cost/item tabs in the Quantities and Costs dialog box.
3. The Quantities Mode option to have different layouts for different quantities

If you have Estimating but not Intelligent Layout you have to make your layouts manually before you do your estimating. This is perfect for corrugated users who usually only have one or two designs on a sheet.

Overview: How to design a layout using Intelligent Layout

1. Create designs to use in the layout.
2. Create a new layout and add the new designs to it.
3.  Click **Quantities and costs**.
4. Check the board weight and cost to make sure they are correct.
5. Enter the ordered quantities and click **Rebuild**.
6. Examine the information on the Total Cost tab, decide which layout best meets your qualifications and click **OK**.
7. Create tooling.

Refer to the upcoming example for more detailed instructions.

Overview: How to use Costing/Estimating when creating a layout

1. Create designs to use in the manufacturing file.
2. Create a new manufacturing file and add the new designs to it.
3. Use the nesting and copying tools to build a layout.
4.  Click **Quantities and costs**.
5. Check the board weight and cost to make sure they are correct.
6. Set ink coverage, if any.
7. Set the values for prompted variables, if any.
8. Examine the information on the Total Cost tab, decide which layout best meets your qualifications and click **OK**.
9. Create tooling.

Refer to the example which follows for more detailed instructions.

Example - How to use Intelligent Layout with Costing/Estimating to produce a layout with multiple items

This example makes a layout with three different designs and uses Intelligent Layout and Costing/Estimating.

Create three designs

For the purposes of this example, create three designs, all style RT Top Tuck on 2nd (in the Folding Carton Standards Catalog).

DESIGNA	4 x 3 x 5 inches or 100 x 75 x 125mm
DESIGNB	4 x 2½ x 4 inches or 100 x 60 x 100mm
DESIGNC	3 x 2 x 3 inches or 75 x 50 x 75mm

If you use different sizes, you will get a different yield and a different number up.

Create a new layout and add the three designs

1. Click **File > New > Manufacturing**.
2. Click **OK** to accept default parameter sets and machines, or choose others if desired. A blank manufacturing file will be created.
3.  Click **Add oneup**.
4. Navigate to the directory or resource containing the designs you made, highlight DESIGNA, and click **Open**. DESIGNA appears in the bottom left of the sheet.

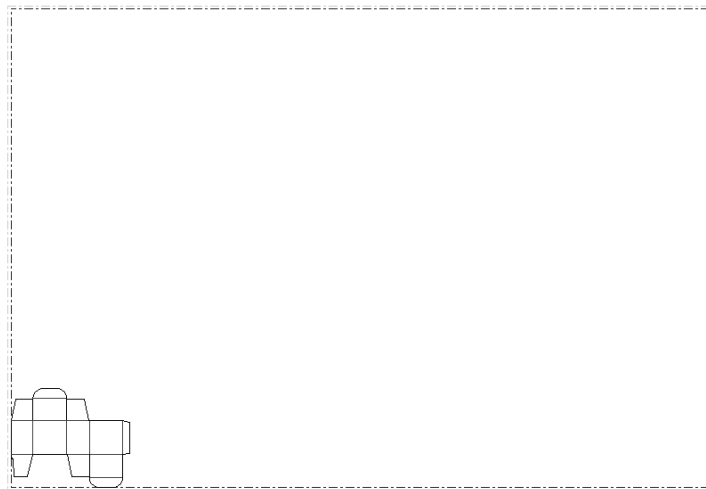

5. Repeat steps three and four for DESIGNB and DESIGNC.

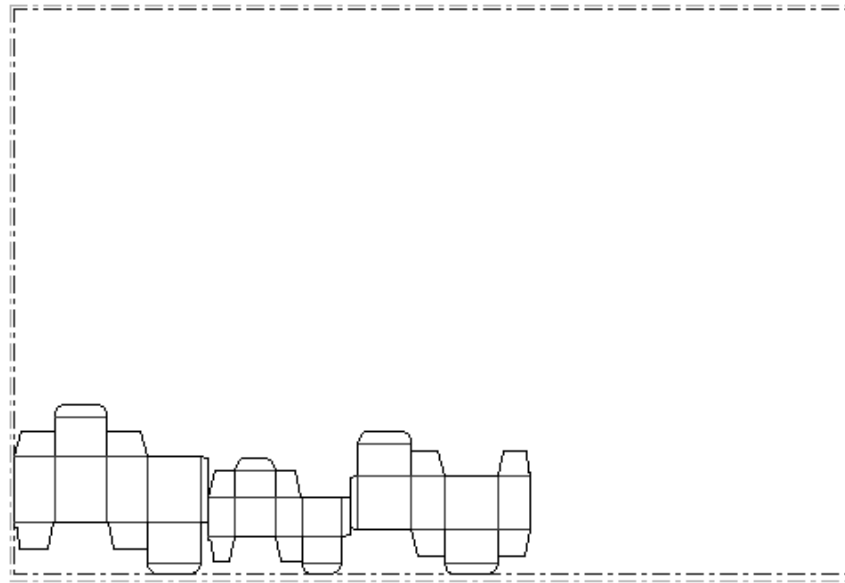

6. Click **Change gutter distance**.
7. Select **¼ inch** or **5mm** from the drop down list.
8. Click **OK**.

Check the board weight and cost

1. Make sure the Intelligent Layout toolbar is turned on using the Toolbars master control.
2.  Click **Intelligent layout parameters**, and then click the Board/Die cost tab. If the designs were not made in ArtiosCAD2.10 or later, they likely have incorrect board basis weight and cost. The board basis weight and cost should be reasonable, for example:

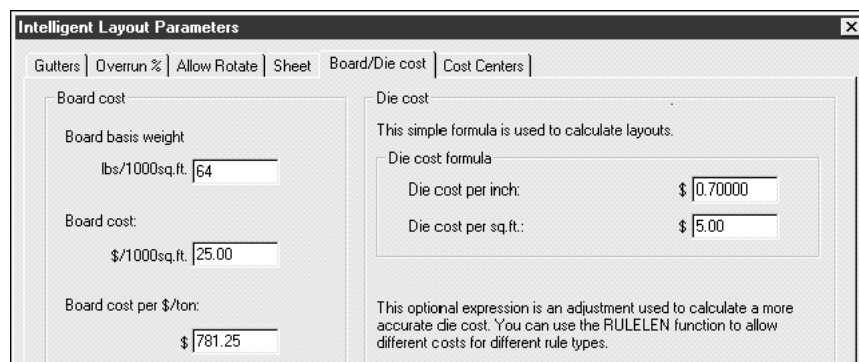

Correct the basis weight and cost if necessary. The board cost needs to be approximately correct within a factor of two for Intelligent Layout to give meaningful results.

3. Click **OK**.

Enter the ordered quantities and Rebuild

1.  Click **Quantities and costs**.
2. Type ordered quantities such as 100000 for DESIGNA, 300000 for DESIGNB, and 200000 for DESIGNC as shown in the following dialog box:

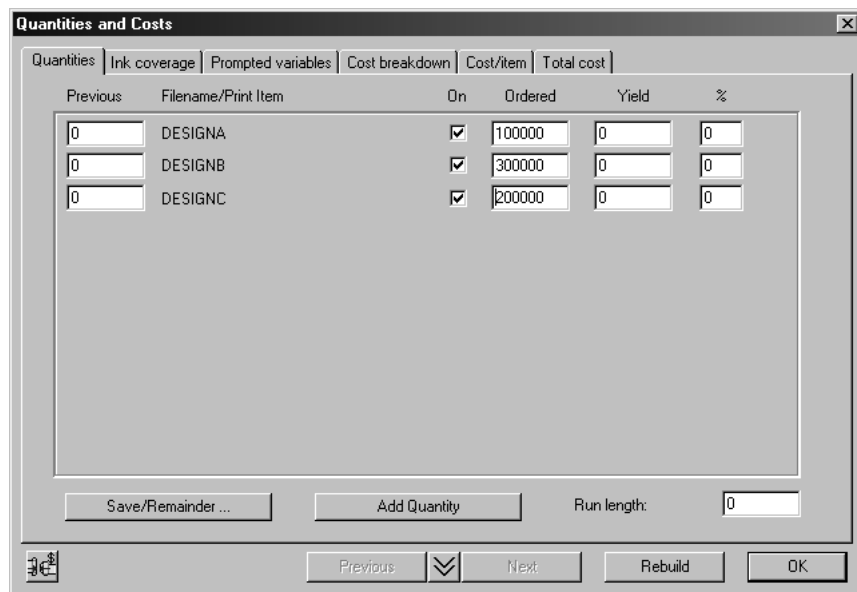

3. Click **Rebuild** to calculate a layout. You will see a progress indicator for a few seconds while it calculates layouts:

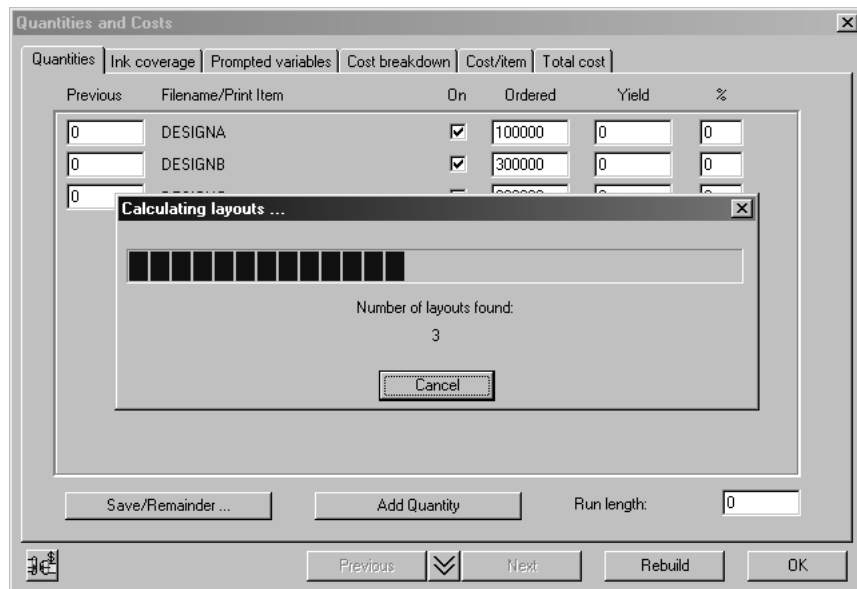

4. When it has finished calculating layouts, the progress control disappears, the run length and yields are calculated, and the Quantities tab is updated:

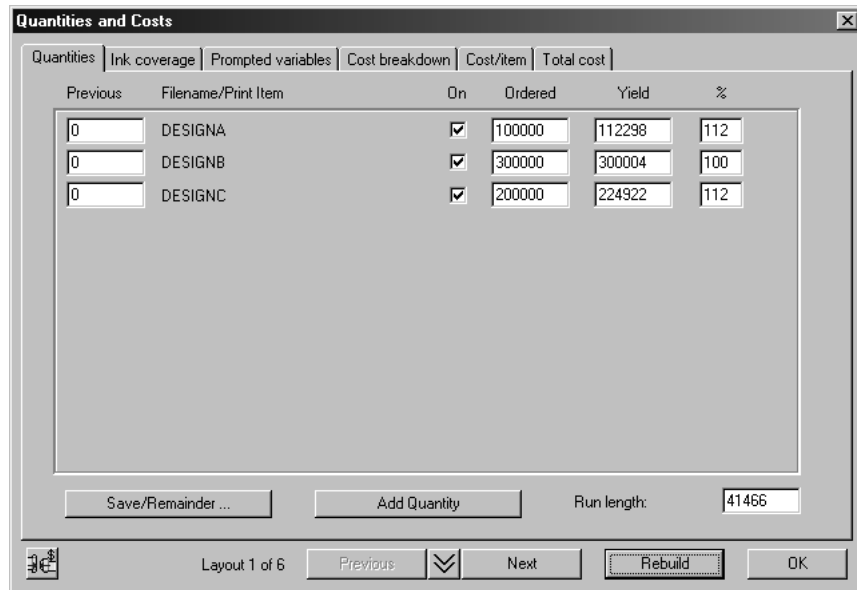

The text at the bottom of the dialog Layout 1 of 6 indicates that it calculated six layouts; cycle through these layouts using the **Next** and **Previous** buttons. Note that layouts are ordered by ascending sheet cost.

Set the ink coverage

1. Click the Ink coverage tab and enter the number of colors and the inks used. The number of colors is used to determine the make ready for the printing press and the ink information is used to calculate ink cost. The number of inks does not have to be the same as the number of colors. For each ink you need to estimate the coverage and enter the cost per pound/kilo. As an example you might enter an ink called CMYK at 200% coverage, followed by any spot colors used.

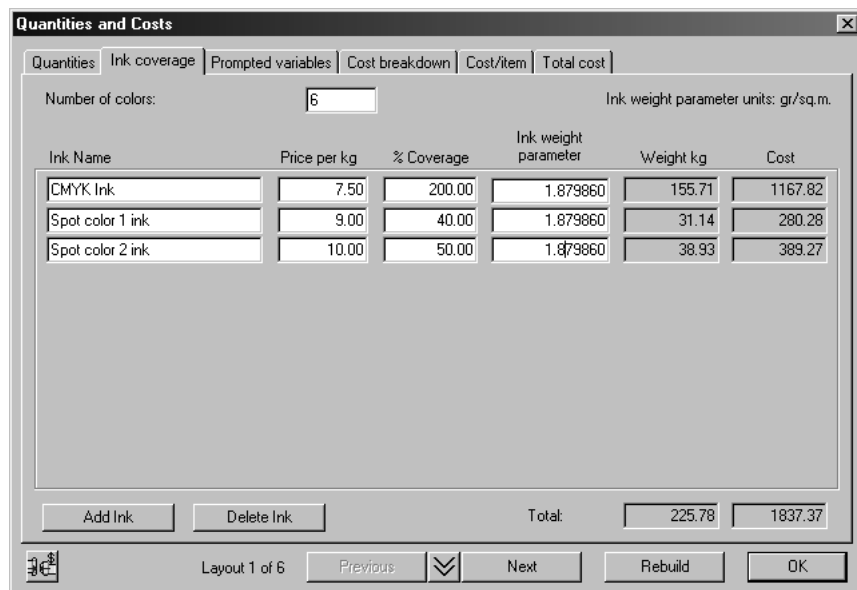

2. After changing the number of colors click **Rebuild**, as specifying ink affects the selection of the layout.

Set the prompted variables

1. The default cost centers for Intelligent Layout include a window width parameter for the windowing machine, and a Folder difficulty for the folder-gluer. Set these parameters for each design as shown in the following dialog box.

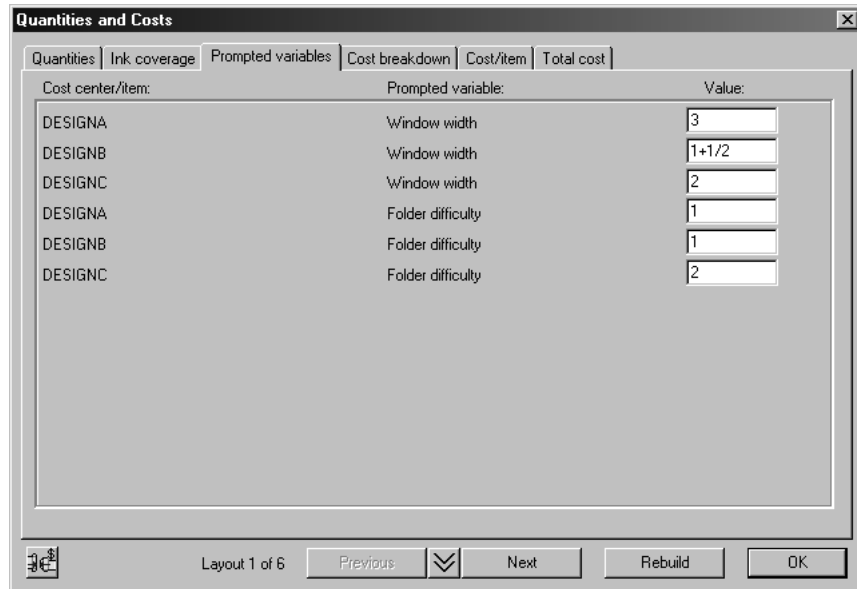

Examine the total cost

1. Click the Total cost tab in the Quantities and Costs dialog box to see information similar to that shown in the following dialog box:

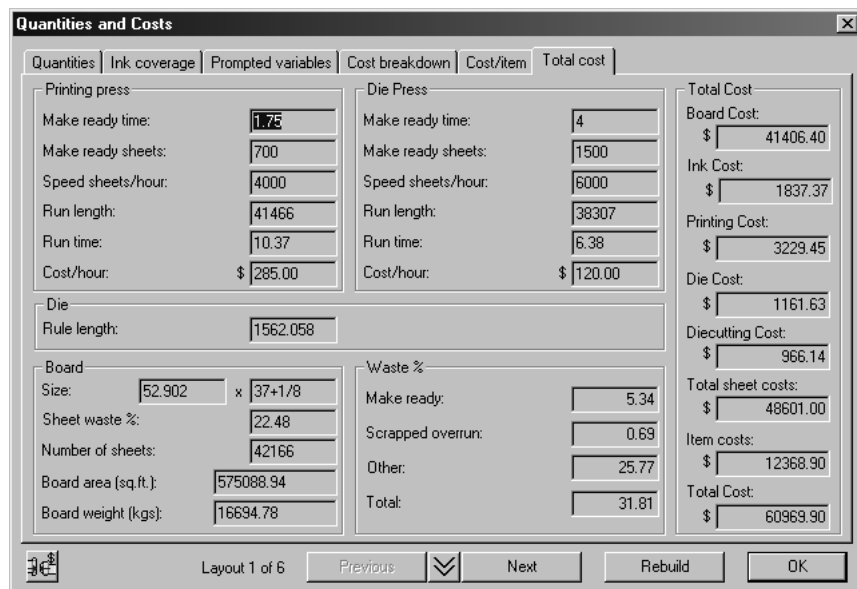

Here is an explanation of the values in this dialog:

Table: Quantities and Costs

Term	Meaning
Make ready time	The time to set up the machine in hours.
Make ready sheets	The number of sheets used while setting up the machine.
Speed sheets/hour	Average speed of the machine while running.
Run length	Number of sheets used while running, separate from make ready. The run length of the die press is shorter than the run length of the printing press due to run waste on the printing press and make ready on the die press.
Run time	Time the machine is running, hours.
Cost/hour	Cost of using the machine per hour.
Rule length	Approximate rule length in the die. Does not allow for double line removal or stripping rules. Used in the calculation of the die cost.
Rule length warning	A warning is shown if the rule length exceeds the maximum rule length for the die press.
Sheet size	The size of the sheet in X and Y.
Number of sheets	Total number of sheets used, including make ready.
Board area	Total area of board used, including make ready.
Board weight	Total weight of board used, including make ready.
Layout waste	$(\text{area of waste in a single sheet}) / (\text{area of sheet}) * 100\%$.
Make ready waste	$(\text{Amount of board used in make ready and run time waste for all cost centers, including folder-glueers and so on}) / (\text{Total board used}) * 100\%$.
Scrapped overrun	$(\text{Area of board scrapped due to excess overruns}) / (\text{Total board used}) * 100\%$.
Total waste	$(\text{Area of board in the cartons delivered}) / (\text{Total board used}) * 100\%$. Note: This is not a sum of all waste.
Ink Cost	Cost of inks used as specified in the ink coverage page.
Printing Cost	Cost of using the printing press, including make ready.
Die cost	There is a formula for the die cost based on the sheet area and rule lengths. Note that since there is no separate formula for stripping

Term	Meaning
	boards, varnish blankets and other tooling, the die cost formula should be set up to include these as well.
Diecutting cost	Cost of using the die press including make ready.
Total sheet costs	Subtotal of board cost + Ink cost + Printing cost + Die cost + Diecutting cost + any other sheet cost centers.
Item costs	Cost of the item cost centers (the ones downstream from the die press) such as folder-gluer, windowing and shipping.
Total cost	Total sheet costs + Item costs.

The formula for calculating the cost of a cost center is:

$$(\text{make ready cost}) + ((\text{run time}) * (\text{cost/hour})) + ((\# \text{ sheets}) * (\text{cost/sheet}))$$

Setting the overrun percentage

This section illustrates how the overrun percentage can be controlled by the Overruns tab.

- 
 Click the icon in the lower left to change from the Quantities and Costs dialog box to the Intelligent Layout Parameters dialog box, and then click the Overruns tab. You will see the following dialog box:

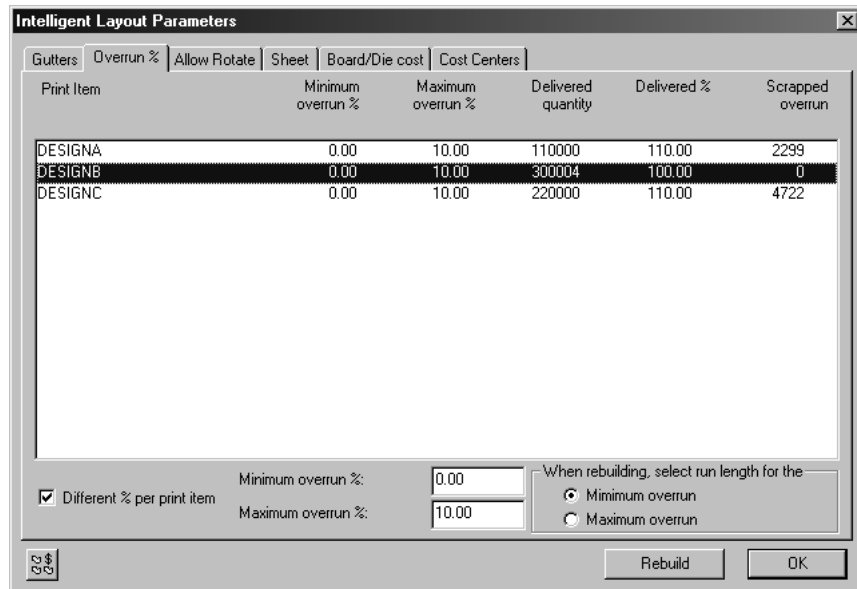

The table below explains the Overruns dialog box.

Table: Overruns

Term	Meaning
Minimum overrun %	The minimum overrun acceptable. 0 means make at least 100% of the ordered quantity.
Maximum overrun %	The maximum overrun acceptable. 10 means that the customer will accept up to 110% of the quantity ordered. Anything over 110% is assumed to be scrap.
Delivered Quantity	Quantity delivered to the customer (does not include the scrapped overrun). Note that the Yield column on the Ordered Quantities page does include the scrapped overrun.
Delivered %	Quantity delivered to the customer as a percentage of the ordered quantity. Should be in the range 100+minimum% and 100+maximum%.
Scrapped Overrun	The number of excess cartons above the maximum overrun. It is assumed that these will be scrapped (e.g. thrown out or recycled) and not processed by downstream machines such as the folder-gluer.
Different % per print item	When on, you can select multiple rows by SHIFT- or CTRL-clicking. Use this to set the overrun % to be different for different items. When off, all the items are selected, and you change the overrun % for all items at the same time.
Minimum overrun option button	Calculate the run length as the smallest that gives yields \geq minimum overrun for all items on the sheet.
Maximum overrun option button	Calculate the run length as the largest that gives yields \leq maximum overrun and yields \geq minimum overrun for all items on the sheet.

Effect of minimum and maximum overrun

The following example illustrates the difference between the Minimum and Maximum option button selections.

- 
 Set the option button to **Minimum overrun**, switch back to the Quantities and Costs page by clicking the icon, enter new ordered quantities as follows, and rebuild:

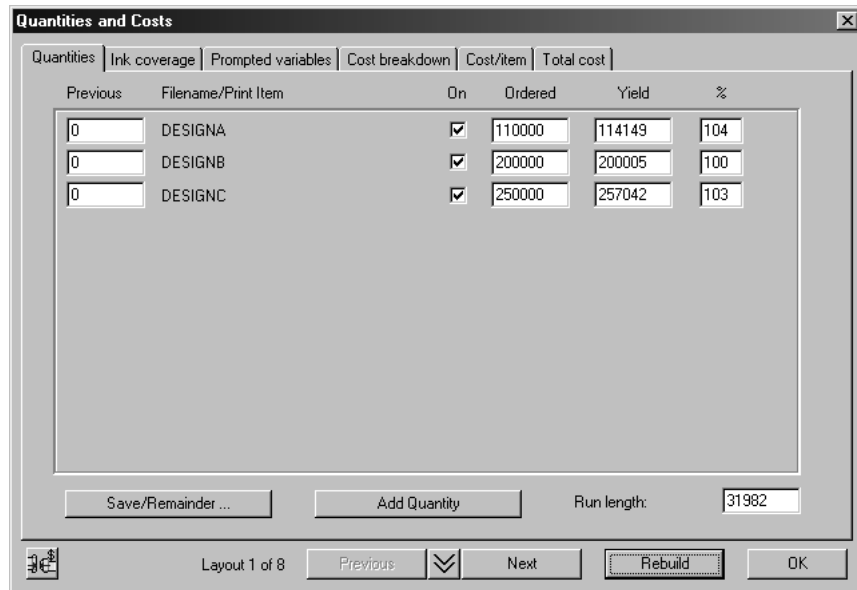

2. You will get a new layout and different yields. Note that you will often get a layout that does not give the exact yield quantity required, because you can only put a whole number of each design on the sheet. In this case DESIGNB is 100%, whereas DESIGNA and DESIGNC are slightly over, at 104% and 103%.
3. Switch to the Overruns tab, change the option button to **Maximum overrun**, and switch back to the Ordered Quantities page. Do not click Rebuild! Now the run length has increased to fit the maximum overrun which is 10%:

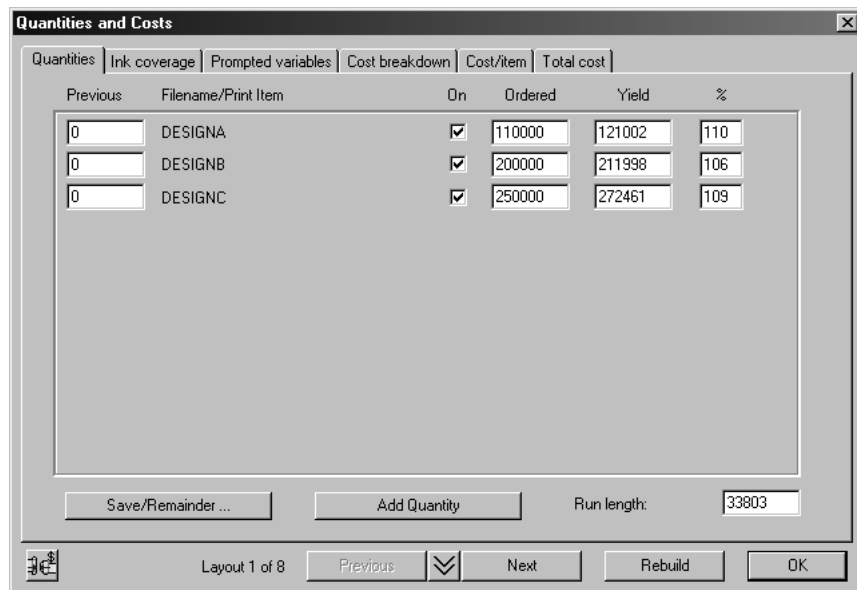

Scrapped overrun

Sometimes the overrun is larger than the maximum and you get scrapped overrun, particularly when there are only 1 or 2 of that design on the sheet. For example, change the ordered quantity of DESIGNC from 250000 to 25000, and rebuild. The new layout has only 2 of DESIGNC, giving a yield of 176%:

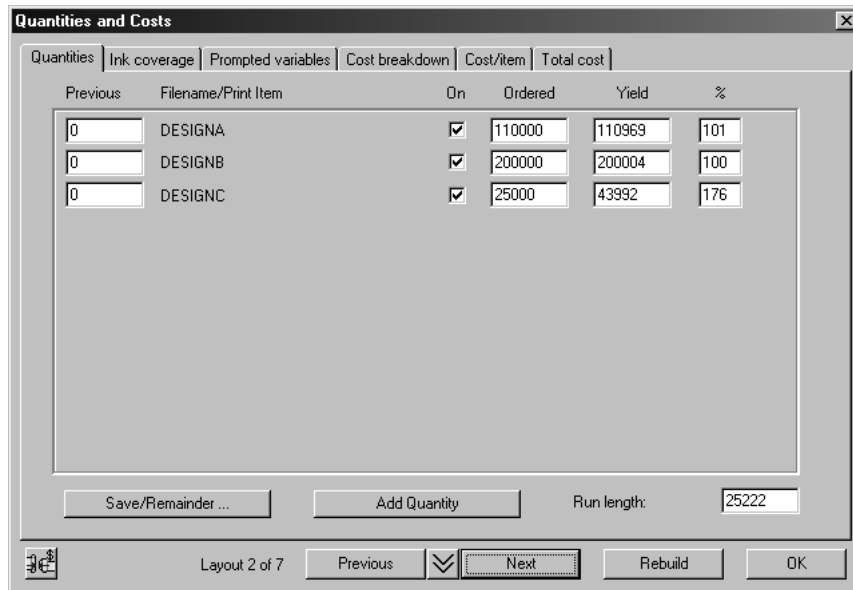

Since the customer will not accept over 110%, the remainder is shown as scrapped overrun on the Overrun % page:

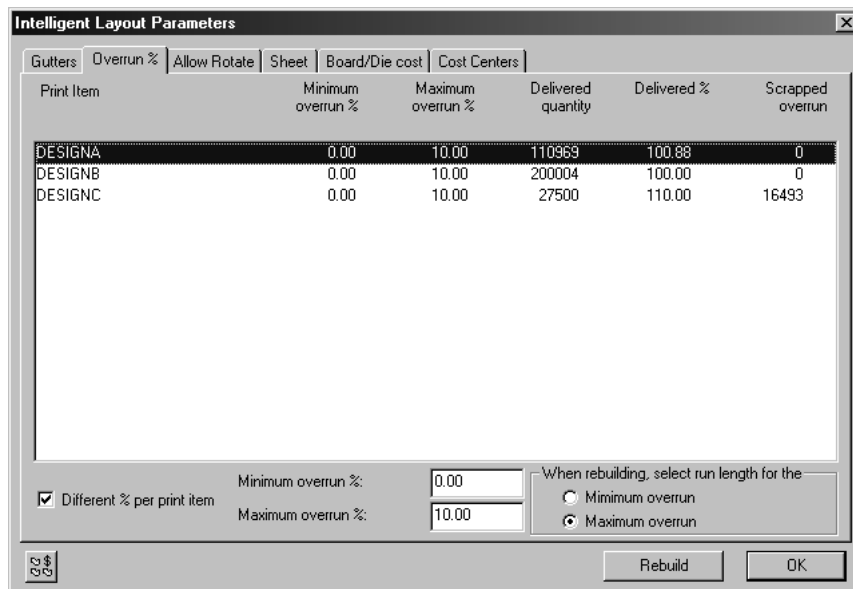

Note that when you have scrapped overrun, it makes no difference which overrun method button is selected.

How to use print items with Intelligent Layout and Costing/ Estimating



ArtiosCAD supports the concept of print items. Several print items may have the same structure, but different print on each structure. All the print items are stored in the same ArtiosCAD design file.

Example: Using print items with Intelligent Layout and Costing/ Estimating

The following is an example of how print items work in Intelligent Layout.

Creating Print Items

Start from the layout you made in the previous example and add some print items to the design DESIGNC.

1.  Click **Open embedded design** and select one of the small designs. A new window appears, titled layoutname:DESIGNC. This is the copy of design DESIGNC that is embedded in the manufacturing document.
2.  Click **Print items**.
3. Enter the name of the first print item, such as Beef.
4. Click **OK**.

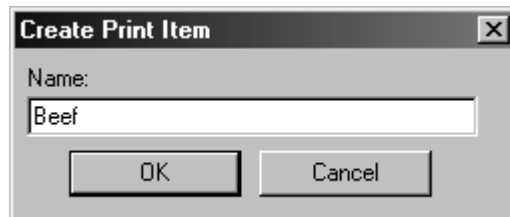

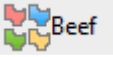
The button  changes to  showing that the current print item is Beef.

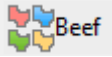
5. Click  again.

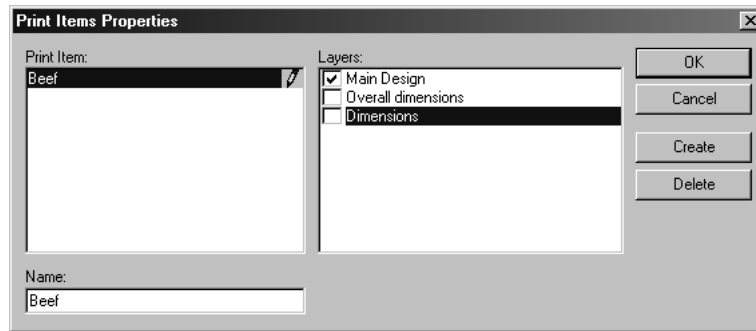

6. Click **Create**.
7. Type the name of another print item, such as Chicken and click **OK**.
8. Repeat to add another print item, such as Pork and click **OK**.

Return to Manufacturing

1. Click **File**, and then click **Return to Manufacturing** to close the embedded design.
2.  Click **Quantities and costs**.
3. Enter new ordered quantities, e.g. 200000 beef, 200000 chicken, and 300000 pork.
4. Click **Rebuild**.

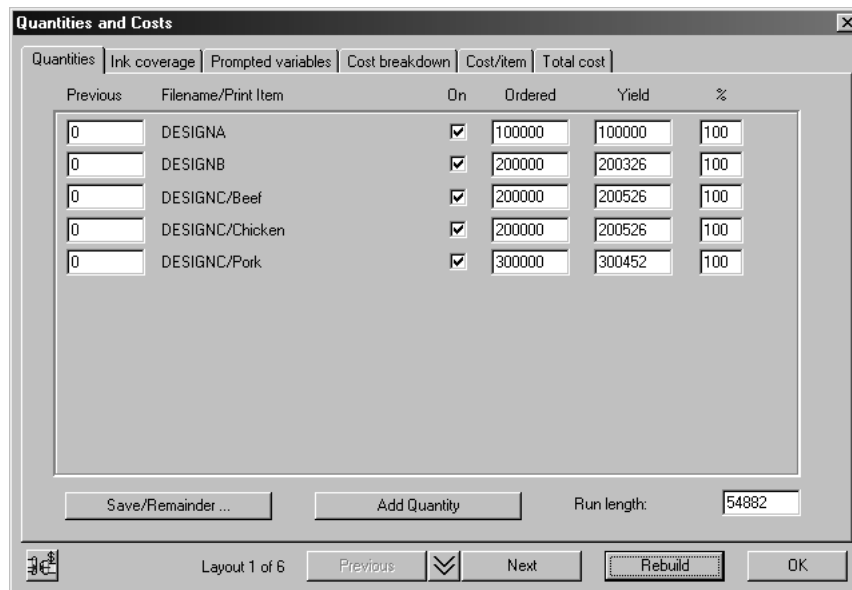

5. Click **OK** to close the dialog to see the layout better.

Check the Print Items in the Layout

1. Click **View** and then click **Item labels**.
2. Select **Use print item names**.
3. Click **OK**.

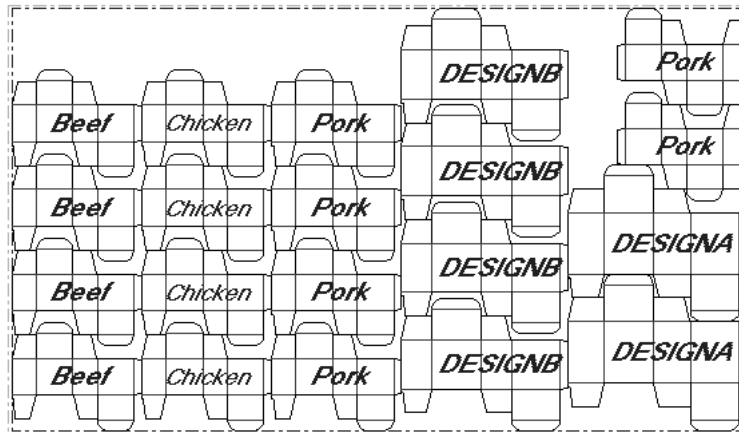

If you have ArtMaker, you can add graphics to the designs and view them by turning on the **Graphics** checkbox in the Oneup Layers Class dialog box on the **View** menu.

Ghosting constraints

This is an illustration of how ghosting constraints can affect a layout (for the pictures shown here, the maximum sheet size was 60 x 42 inches).

With no ghosting constraints, the layout looks like this:

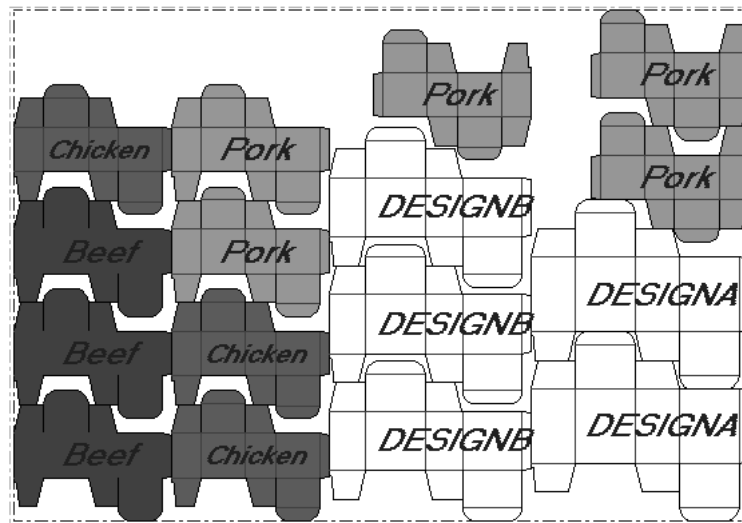

There is a light red item behind a dark green item and this may not be acceptable due to printing considerations (ghosting constraints). The green ink may bleed into the red ink while the cartons move through the press. To change the ghosting constraints:

1.  Click **Intelligent Layout Parameters**, then click **Gutters**.
2. Click **Beef** on the left and then clear the **Chicken** checkbox on the right. This means that the Chicken item cannot be placed behind the Beef item.
3. Click **Chicken** on the left and then clear the **Beef** checkbox on the right. This means that the Beef item cannot be placed behind the Chicken item.

- Click **Rebuild**. The new layout is built with the constraint that Beef and Chicken items cannot be placed in the same column:

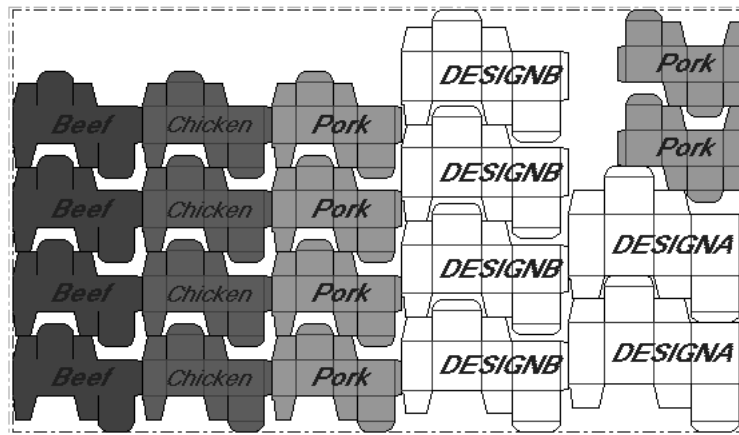

Multiple Sheets

To illustrate the need for more than one sheet, suppose you had more designs in an order. From the earlier layout, add two more designs DESIGND and DESIGNE, so the complete list is:

DESIGNA	4 x 3 x 5 inches or 100 x 75 x 125mm
DESIGNB	4 x 2½ x 4 inches or 100 x 60 x 100mm
DESIGNC	3 x 2 x 3 inches or 75 x 50 x 75mm
DESIGND	3 x 2 x 4 inches or 75 x 50 x 100mm
DESIGNE	5 x 4 x 6 inches or 125 x 100 x 150mm

Enter new ordered quantities for DESIGND of 40000 and DESIGNE of 30000, with a maximum sheet size of 60 x 40 inches or 1500 x 1000 mm, and then click **Rebuild**. Get results as follows:

Previous	Filename/Print Item	On	Ordered	Yield	%
0	DESIGNA	<input checked="" type="checkbox"/>	100000	120652	121
0	DESIGNB	<input checked="" type="checkbox"/>	200000	201304	101
0	DESIGNC/Beef	<input type="checkbox"/>	200000	0	0
0	DESIGNC/Chicken	<input type="checkbox"/>	200000	0	0
0	DESIGNC/Pork	<input checked="" type="checkbox"/>	300000	322082	107
0	DESIGND	<input checked="" type="checkbox"/>	40000	40000	100
0	DESIGNE	<input checked="" type="checkbox"/>	30000	40000	133

Run length: 44426

Layout 1 of 6 Previous Next **Rebuild** OK

When there are many designs, the proportions might not fit particularly well on the sheet, and there may be overruns of one or more items. In this case there is 133% of DESIGNE. Because the numbers do not work out well, we can try fulfilling the order with two sheets.

Intelligent Layout does not handle multiple sheets automatically but it provides some tools for assistance in this case.

Using the On Checkboxes and Save/Remainder

You could try putting the larger designs on a separate sheet. The two larger designs are DESIGNA and DESIGNE. To make a sheet with just those, do the following:

1.  Click **Quantities and costs**.
2. Turn off the checkboxes for designs DESIGNB, DESIGNC, DESIGND, and click **Rebuild**:

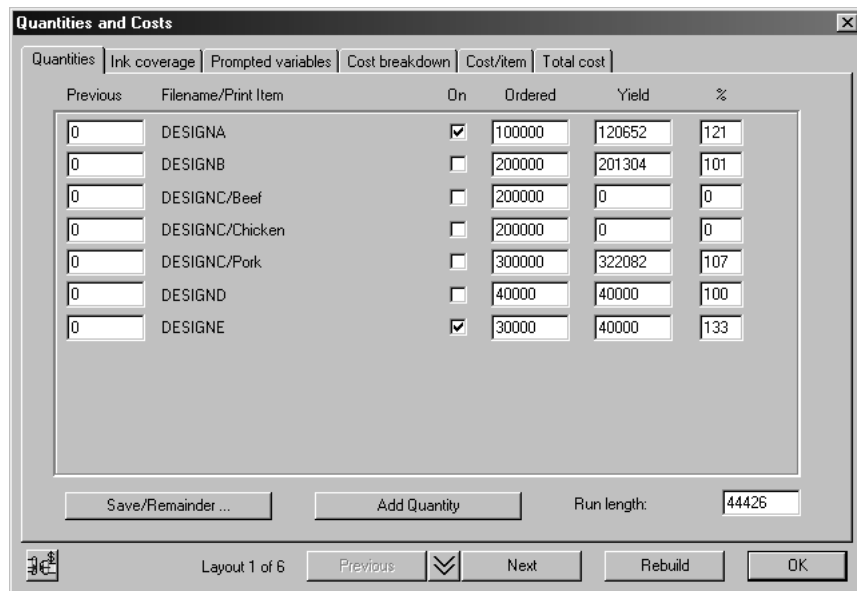

3. Use **Previous** and **Next** to find a layout with the least overrun.

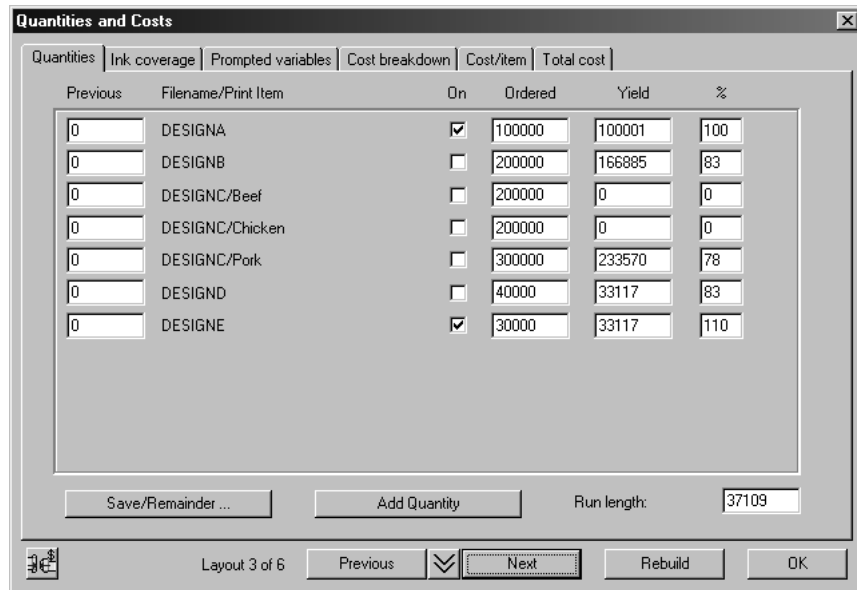

4. Click **Save/Remainder**. A confirmation dialog box will appear.

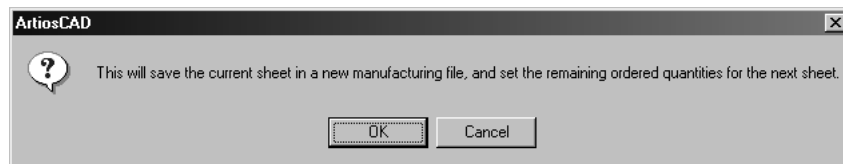

5. Click **OK** to save this layout with a new name.
6. The yield quantities from the layout you just saved are now in the Previous column of the new layout, the checkboxes for the designs in the layout just saved are turned off, and the checkboxes for the remaining designs are turned on. Click **Rebuild** to make a layout for the remaining items:

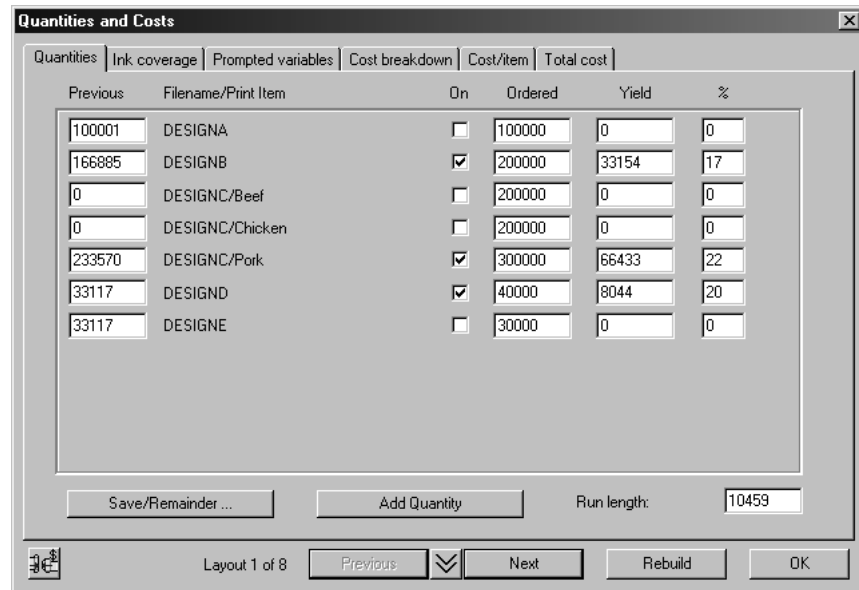

How to adjust layouts made using Intelligent Layout

To adjust layouts made using Intelligent Layout, use the tools described in this section. Any manual changes you make to a layout will be lost if you do a Rebuild.

Specify Nest tool



The **Specify Nest** tool overrides the automatically calculated nest between designs. To use this tool:

1. Identify a pair of designs one above the other, for which you want to change the nest.
2.  Click the **Specify Nest** tool.
3. Click a pickup point in the higher of the two designs.
4. Drag this design horizontally, and place it using a put-down point in the required position relative to the design underneath it.

The column containing these two designs is rebuilt using the new nest you have defined. The new nest will be used in the next rebuild, and if the two designs are the same, in the next use of the manual nest tools.

Delete Nest tool



This tool allows nests created by the **Specify Nest** tool can be deleted. In the Delete Nest dialog box, hold down CTRL to select more than one nest at a time. Click OK to delete the selected nests.

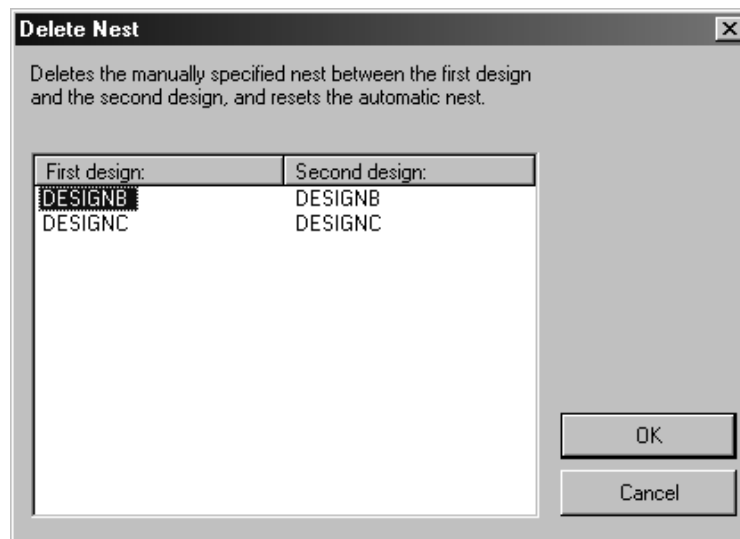

Move Design or Column tool



The **Move Design or Column** tool makes quick, simple adjustments to a layout created by Intelligent Layout.

To move a design up or down in a column:

1.  Click the **Move Design or Column** tool.
2. Select the design to move.
3. Click near the new position in the same column

To move a column:

1.  Click the **Move Design or Column** tool.
2. Click a design in the column to move.
3. Click near the position (in a different column) where you want to move the column.



Manual Adjustments

If you make manual adjustments to a layout created by Intelligent Layout, or create the whole layout manually, the value in the Quantities and Costs dialog will be automatically updated.

Multiple Quantities in Costing/Estimating

The other mode of using Costing/Estimating is when you have only one design, but you want to quote several estimates depending on the quantity ordered by the customer. The following example shows how this works.

Adding to the list of quantities

1. Open one design in ArtiosCAD.
2.  Click **Convert to manufacturing** and choose a parameter set and presses to use.
3.  Click **Quantities and costs**. The Quantities and Costs dialog box appears showing the single design.

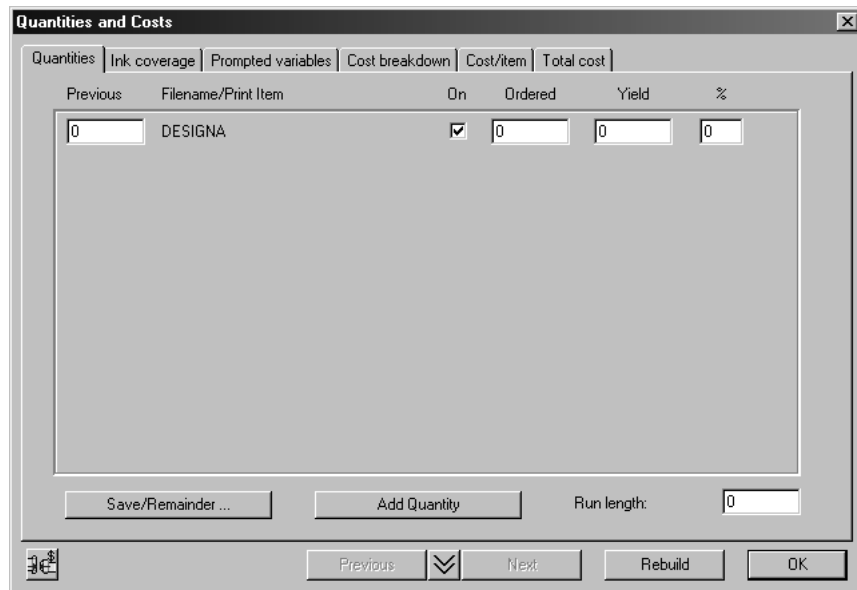

4. Click **Add Quantity**. The format of the Quantities tab changes, showing multiple quantities instead of multiple items:

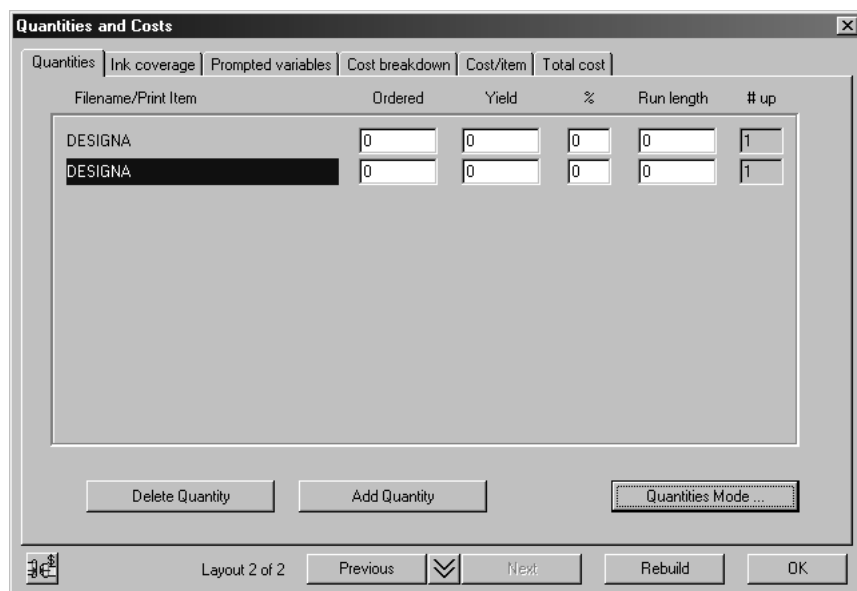

5. Click **Add Quantity** twice more.
6. Enter ordered quantities 20000, 50000, 100000, 200000.
7. Click **Rebuild**.

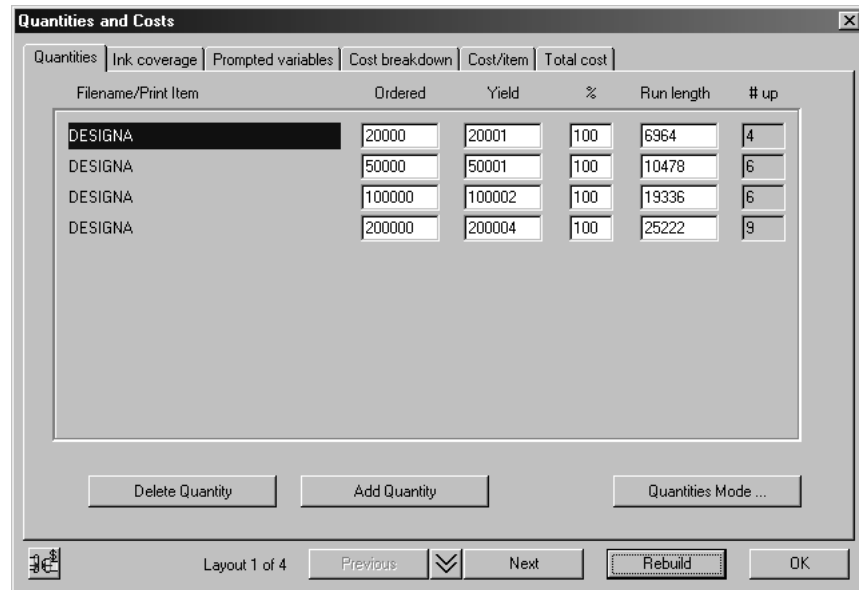

Different Layout for Each Quantity

Note that there is a different number up, hence a different layout, for each quantity. An important principle in estimating is that the best layout depends on the quantity. For a long run, the biggest cost is the press time, which is optimized with a large sheet. For a short run, the biggest cost is the make ready, which is optimized with a smaller sheet. For intermediate run lengths, there is a trade-off between make ready and the press time. Intelligent Layout does this automatically, but it is important to understand what is happening.

Clicking on the first column changes between layouts in the same way as the **Next** and **Previous** buttons.

Cost/1000 for Different Quantities

The Cost/item tab of the Quantities and Costs dialog box shows costs per thousand items for each ordered quantity.

Item	Ordered:	Delivered:	Delivered %:	Cost:	Cost/1000:
DESIGNA	20000	20001	100.01	4755.69	237.76
DESIGNA	50000	50001	100.00	8481.56	169.63
DESIGNA	100000	100002	100.00	14403.14	144.03
DESIGNA	200000	200004	100.00	25844.00	129.22

Whether there is a different layout or the same layout for each Quantity is controlled by the Quantities Mode. If you want to have the same layout for each quantity:

1. Go to the Quantities tab in the Quantities and Costs dialog box.
2. Select the desired layout.
3. Click **Quantities Mode**.
4. Select **Same number up for all quantities**.

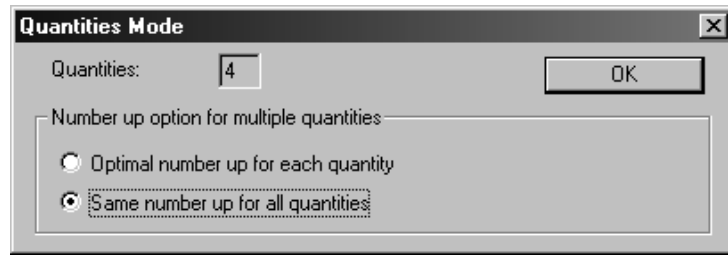

5. Click **OK**.

Filename/Print Item	Ordered	Yield	%	Run length	# up
DESIGNA	20000	20001	100	6964	4
DESIGNA	50000	50002	100	14936	4
DESIGNA	100000	100000	100	28222	4
DESIGNA	200000	200003	100	54796	4

If you only purchased Estimating and not the Intelligent Layout option, the **Quantities Mode** is **Same number up for all quantities** always.

How to use manual layout tools to design a layout

This section describes how to create a new set of manufacturing tools completely from scratch. A set of manufacturing tools includes a die wood, into which the cutting rule is inserted; a female stripping board, through which waste material is pushed; and a male stripping board, which pushes the waste through the female board.

ArtiosCAD can create many of these elements automatically, but you have the flexibility to design your own tools as well.

You must create and save the designs to be used in the manufacturing tools before creating a new layout.

Overview: How to design a layout manually

1. Open one of the designs to be used in the layout and convert it to a manufacturing file. Choose a parameter set and machines. Add more designs if desired.
2. Use nesting or copy tools to duplicate the design(s) across the sheet.
3. Create tooling.

Creating the workspace and defining machines

The first step in creating a new set of manufacturing tools is to create the workspace that stores them and to define which machines will use the tools.

To create a new set of manufacturing tools, start ArtiosCAD and click **New Manufacturing File** on the **File** menu. This will create the workspace and prompt you to select a manufacturing parameter set, a die press, and a printing press. Click **OK** when you have made your selections.

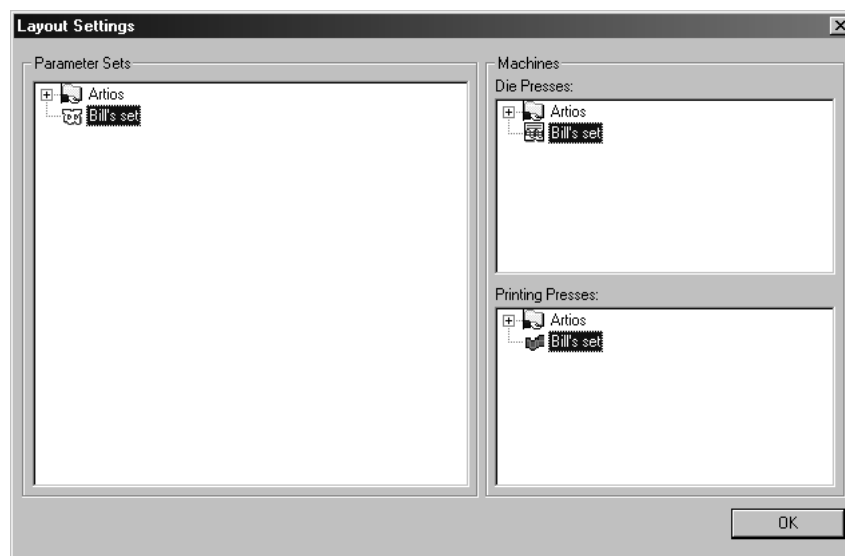

Once you click **OK**, an empty sheet will be created that is sized according to the values in the parameter set.

Converting a canvas to Manufacturing

 You can convert a canvas to Manufacturing when the active part is not empty and is of type Production. ArtiosCAD creates a manufacturing workspace and adds the active part to the sheet.

If you saved the parts to individual workspaces, ArtiosCAD uses the part workspace filename for the base of the manufacturing workspace filename. If you did not save the parts to workspaces, ArtiosCAD bases the manufacturing workspace filename on the canvas filename and part number.

Otherwise, converting a canvas to Manufacturing is just like converting a single design, as ArtiosCAD checks the blank size, checks for double lines, and checks for zero-length lines. If the blank size is 0, ArtiosCAD cancels the conversion.

 To add more parts to the manufacturing workspace than just the active part, save the parts to individual workspaces using **Save Parts** and then add them to the layout using **Add Oneup**.

Adding designs to the sheet and arranging them

 The next step is to add a design to the layout. Click the **Add Oneup** tool. The Add oneup dialog box will appear along with a window that previews each design clicked.

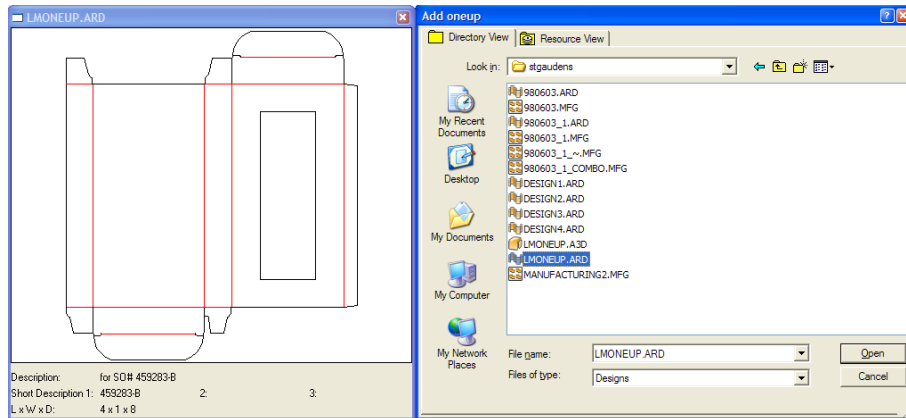

Double-click the name of the design to add to the layout. Repeat this process to add different designs. Do not do this to add more copies of the same design.

Note: Adding more than one design to a layout creates a combination layout, which is covered later in this chapter.

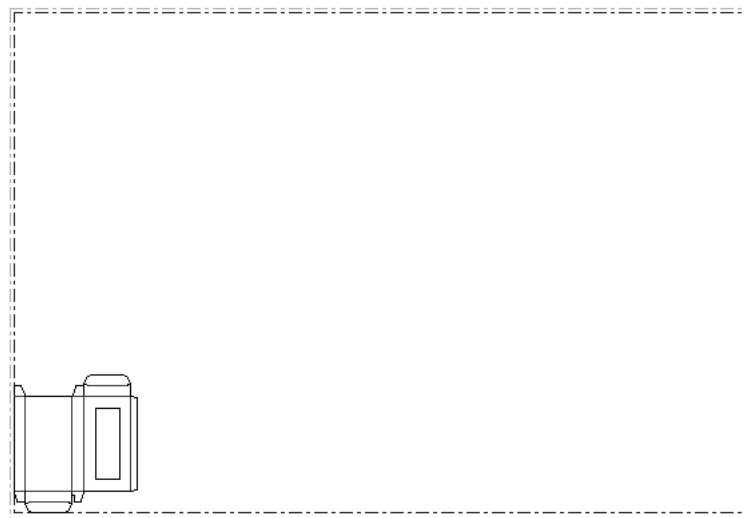



 If the design has print items, click the **Change Print Items** tool to select the print item to use.

Arranging designs using the Nest tools

After placing the design on the sheet, the next step is to arrange as many copies as possible on the sheet. This process is called nesting.

Note: There is a limit of 300 designs per manufacturing sheet.

The distance, or **gutter**, between designs is set to zero by default. You can change it before using a Nest tool. Alternately, you can change it while using a Nest tool by specifying different step values between the rows and columns in the edit boxes on the Status bar.

1.  Click the **Select Design** tool and then click a line in the design. Handle points will appear at its perimeter and it will turn magenta to indicate it is selected.
2.  Click the **Straight Nest** tool, or choose one of the other Nest tools from the Nest Tools Flyout toolbar shown below.





The first tool on the flyout toolbar is the Straight Nest tool, which performs no rotation or alignment on the single designs as it arranges them.

 The second tool on the flyout toolbar is the **Reverse 2nd Row Nest** tool, which flips the design horizontally every other row.

 The third tool on the flyout toolbar is the **Reverse 2nd Row Align Nest** tool, which works similarly to the **Reverse 2nd Row Nest** tool, except that it butts each row of designs against the sheet edge instead of nesting them as close together as possible.

 The fourth tool on the flyout toolbar is the **Reverse 2nd Column Nest** tool, which flips the design vertically every other column.

 The fifth tool on the flyout toolbar is the **Reverse 2nd Column Align Nest** tool, which works similarly to the **Reverse 2nd Column Nest** tool, except that it butts each column of designs against the sheet edge instead of nesting them as close together as possible.

 The sixth tool on the flyout toolbar is the **Honeycomb Row Nest** tool, which nests round shapes close together by row.

 The seventh tool on the flyout toolbar is the **Honeycomb Column Nest** tool, which nests round shapes close together by column. Both honeycomb nest tools support gutters.

3. Once you select a Nest tool, as you move the drag with the mouse, ghost images of the design appear.

Press tab while the drag is active to change the number of designs and step values between designs as desired. **X1** is the horizontal distance between the left edges of each single design's bounding box. **Y1** is the vertical distance between the bottom edges of each single design's bounding box. **X2** is the horizontal distance between the left edges of the second and third columns of single designs, and then the fifth and sixth. **Y2** is the vertical distance between the bottom edges of the second and third rows of single designs, and then the fifth and sixth. Shown below is an example of different **X1**, **X2**, and **Y2** values.

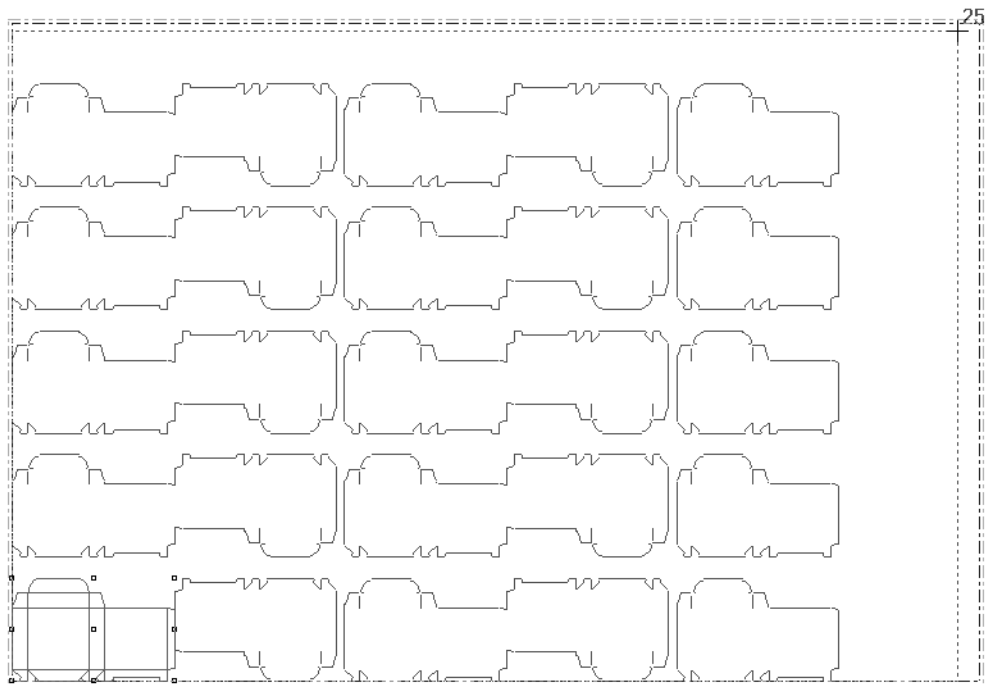

4. Click the mouse button when the ghost images fit inside the sheet without going over an edge. The other tools on the Nest flyout toolbar may allow more designs on a sheet; try them all. Shown below is an acceptable nest. Note that the total number of designs in the nest is shown next to the cursor.

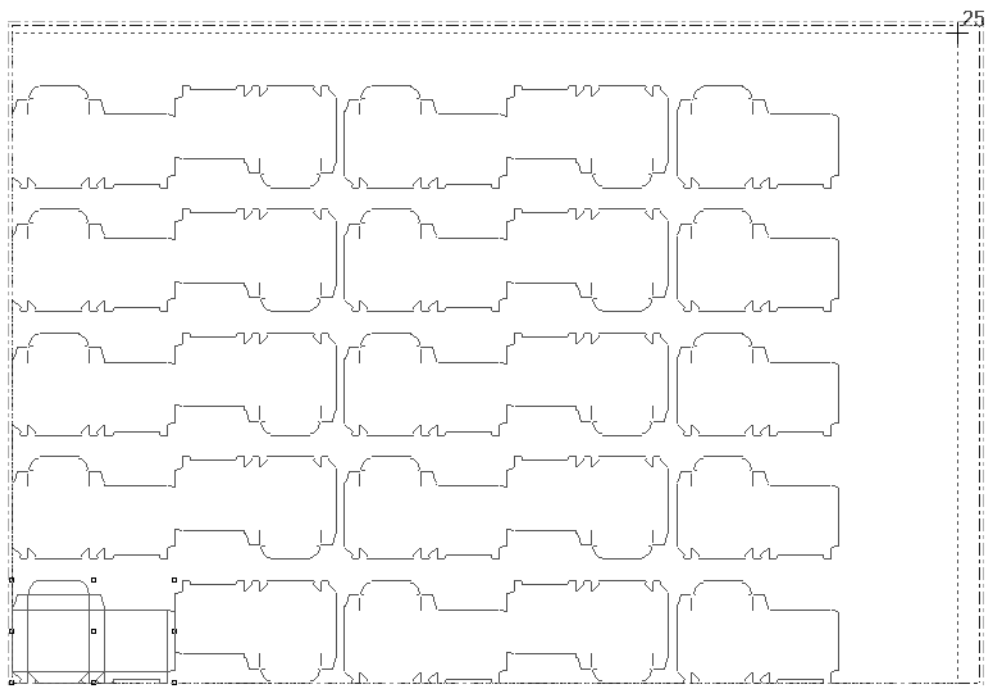

Shown below is an unacceptable nest as the single designs extend beyond the edge of the sheet.

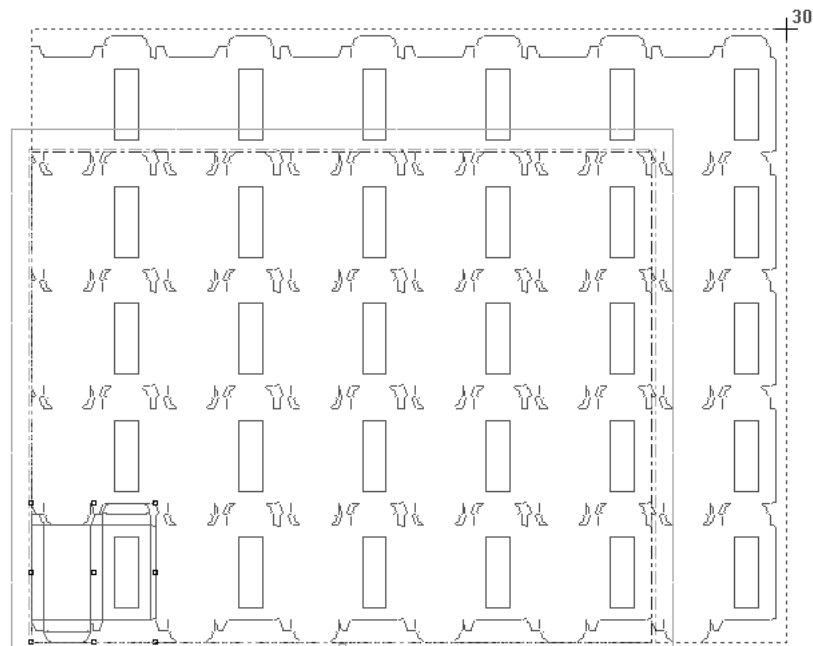

ArtiosCAD allows nests to overflow by one design so that you can see the distance by which you miss nesting an extra row. If you miss by only a small distance, this allows you to adjust your sheet size or gutter as needed so that the extra row fits. If you miss by a large distance, this shows that you have to accept less designs on the sheet.

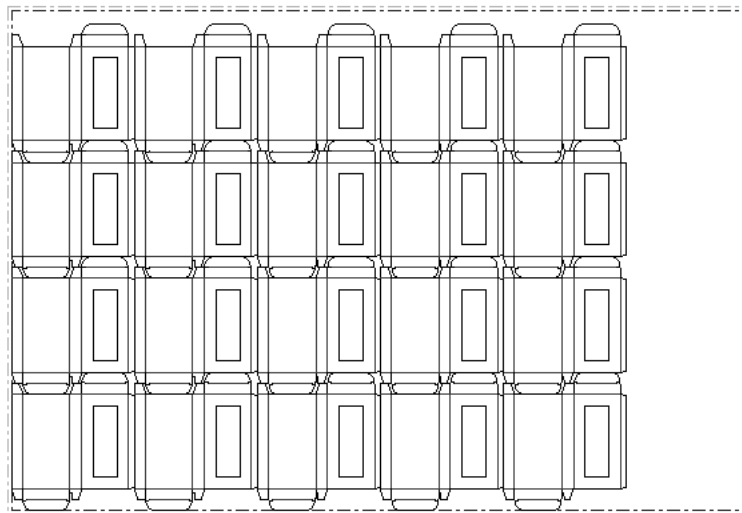

Changing the gutter between designs

 The *gutter* is the distance between designs. By default, the gutter between the nested copies is set to zero. If you want a gutter between the copies, use the **Change Gutter Distance** tool and set the options in the Gutter Distance dialog box to the desired values.

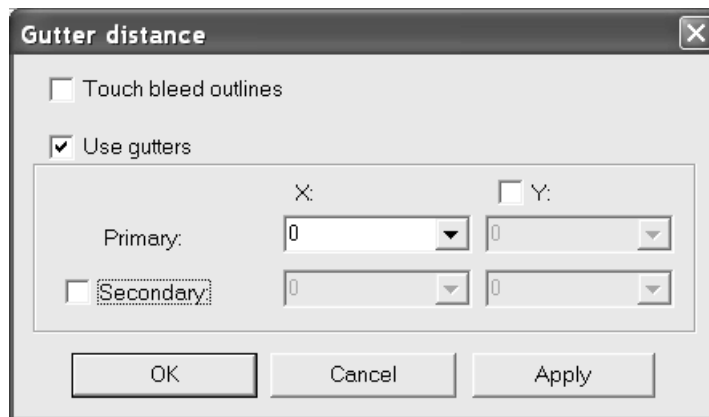

Touch bleed outlines uses the outer-most lines in the Inside Bleed or Outside Bleed layers of the single design(s) as the basis for the nest.

Use gutters enables gutters between the design edges. The checkboxes next to **Y** and **Secondary** enable different gutters as described in step 3 of the previous procedure. X and Y in the **Primary** row are X1 and Y1, while X and Y in the **Secondary** row are X2 and Y2.

The gutter will appear in the Nest tool drag.

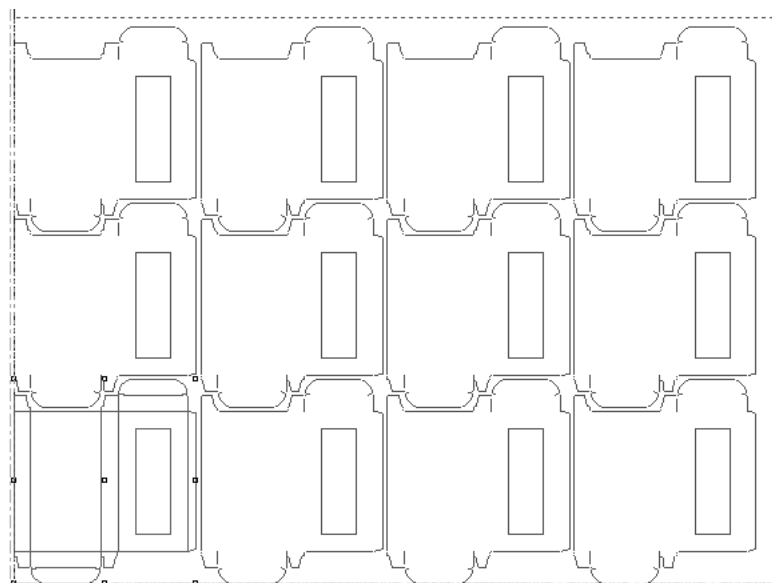

Gutter defaults are contained in **Defaults > Manufacturing parameter sets > Parameter set > Startup defaults > Layout gutters**.

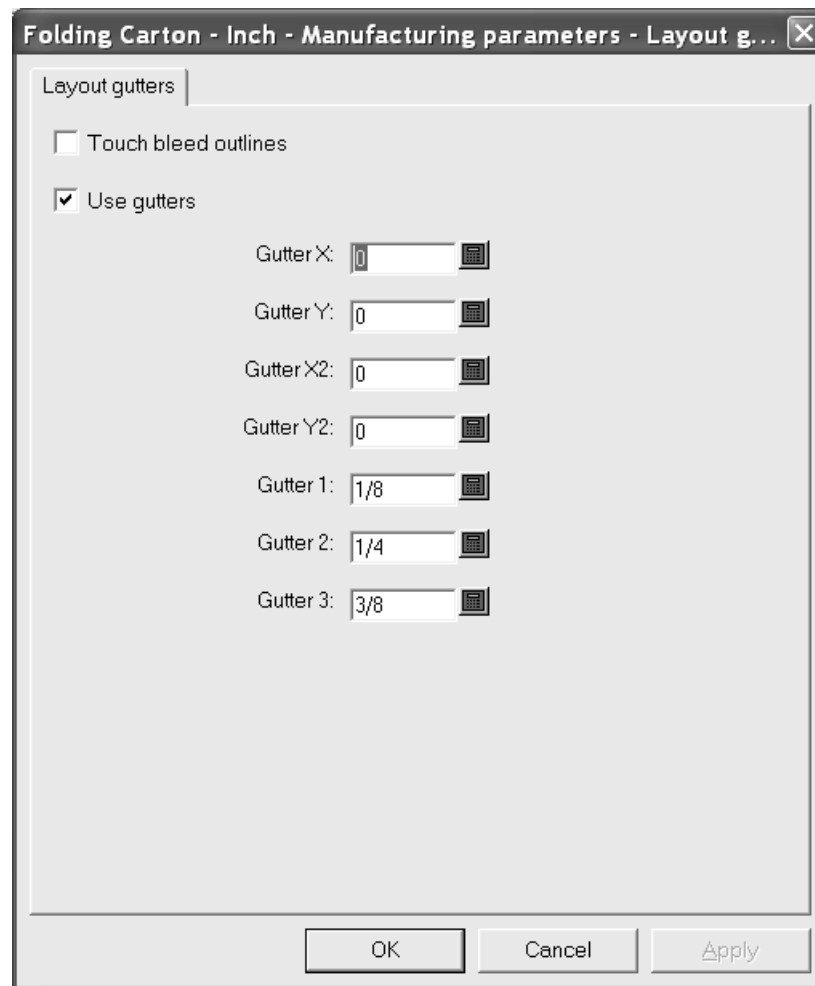

Arranging designs manually

If you don't want to use a Nest tool to arrange the designs on the sheet, you can arrange them manually using the following tools:

- the **Copy Designs** tool
- the **Copy Times Designs** tool
- the **Move Designs** tool
- the **Rotate Design** tools
- the **Mirror Design** tools.

To arrange the designs, you must first add at least one design to the layout using the **Add oneup** tool. Then select the design using the **Select Design** tool and use the tools listed above to arrange the designs as you wish.

When arranging designs, hold down the SHIFT key to constrain the angle to 0/90/180/270 degrees. Clicking will only set the angle of the drag – it will not snap to a point if SHIFT is held down.

Making a combination layout

A combination layout is a manufacturing file that contains different designs.

To create a combination layout, do the following:

1.  Add the different designs to the sheet using **Add oneup** tool. Use the adjustment tools to change their position if desired.

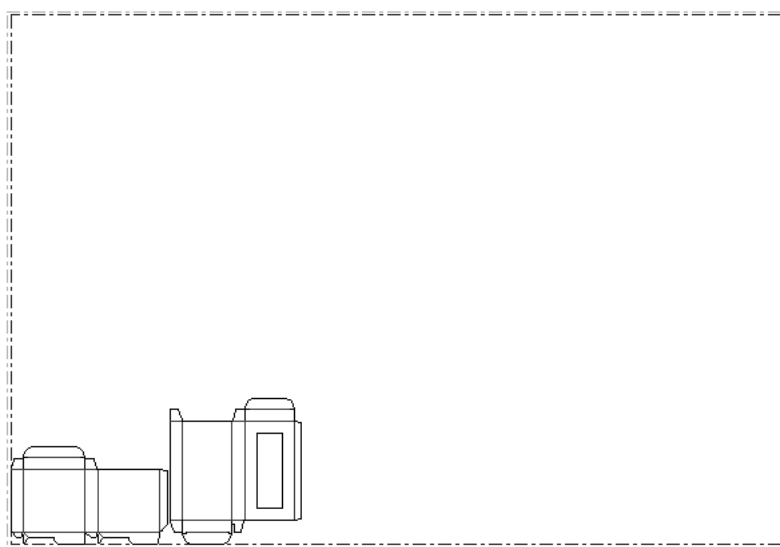

2.  Select all the designs with the **Select Designs** tool.
3. Use the tools on the Edit Layout toolbar to copy and move the designs.

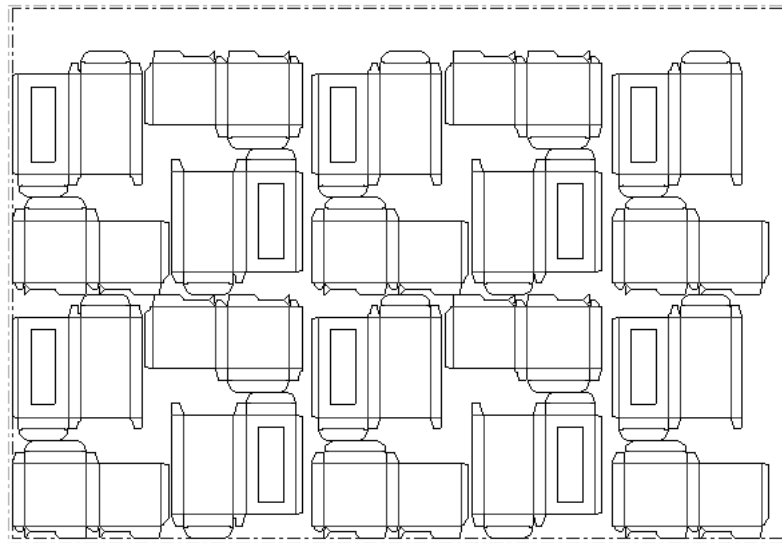

Changing the sheet size and justification of the designs

If the nested designs don't completely fill the sheet, you may want to adjust the size of the sheet or the position of the designs on the sheet.



Click the **Change Sheet Size** tool to do this.

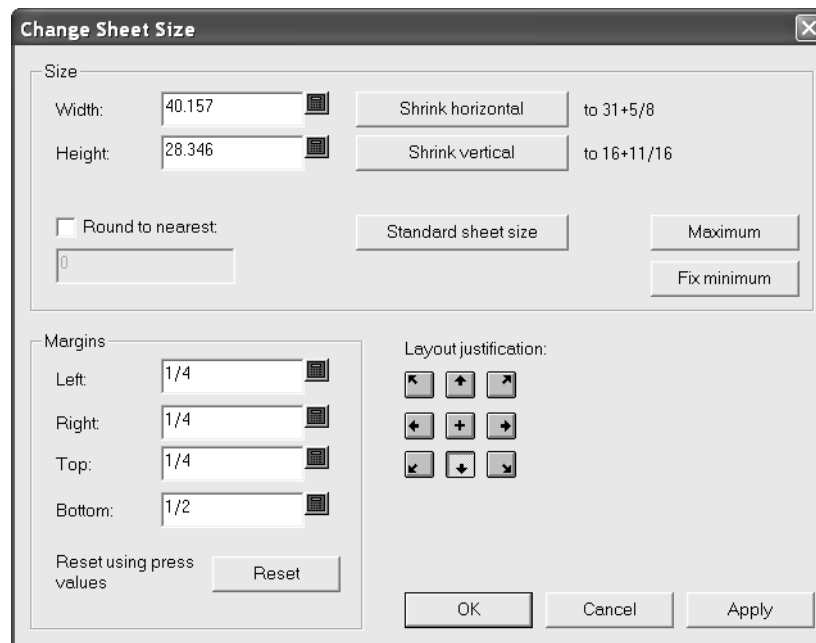

You must choose a layout justification method before you can change the fields in the **Size** and **Margins** groups. The buttons in the **Layout Justification** group move the group of designs so that the bottom center of the designs is aligned with the bottom center of the sheet (as shown above); the other buttons in the group move and justify the oneups in the direction indicated. Once a layout justification method is chosen, all the other fields become available and you can

adjust the size of the sheet and its margins. **Standard Sheet Layout** lets you choose from the list of standard sheets defined for Standard Sheet Layout. Shown below is a sheet shrunk to the perimeter of the single designs.

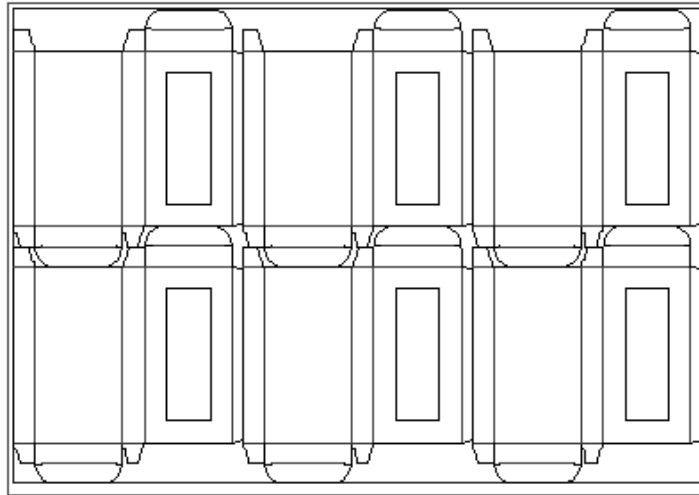

How to modify a single design embedded in a manufacturing file

Single designs that you add to a manufacturing file are copied and embedded in the manufacturing file.

Note: You cannot rebuild an embedded design. Also, do not change both the side up (using the **Side Up** tool on the View bar) and the structural orientation (using the **Structural Orientation** tool on the View bar); change one or the other but not both. ArtiosCAD stores the creation time of the embedded design and compares the internal timestamp to the one of the original workspace on the hard disc to check if the original design has changed since it was embedded. If the layout workspace came from another site, ArtiosCAD cannot compare the timestamps and it will take a long time to open the workspace. To disable this check and have the workspace open faster, deselect the **Check embedded designs upon opening MFG file** checkbox in **Options > Defaults > Shared Defaults > Startup defaults > Embedded Design Check**.

To change a single design embedded in a manufacturing file, do the following:

1.  Click the **Open Embedded Design** tool and select the one up to open. If desired, deselect the **Add layout lines** checkbox. If you leave the checkbox selected, annotation lines representing the designs touching the selected design are shown in Single Design for reference while editing as shown below.

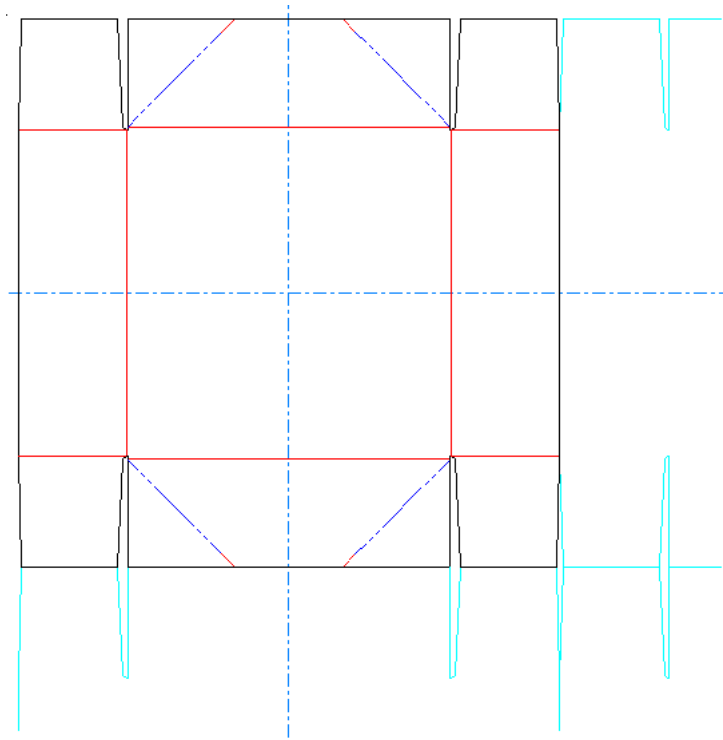



The initial state of the checkbox and the amount of annotation lines shown are set in **Options > Defaults > Startup defaults > Embedded Design Window Size**.

2. Modify the design as desired.
3. To save the embedded copy as the original file, click **File > Save Design**, use the same filename, confirm overwriting it, and then click **File > Return to Manufacturing**. To save it as a new workspace, enter a new filename in the Save As dialog box. The **Save** button on the toolbar does a **Save As**.
4. To keep the original copy as it was and only modify the embedded version, click **File > Return to Manufacturing**.

How to replace designs in a layout

To replace a design in a layout, use the Replace Selected Oneups tool. The Replace Selected Oneups tool can also rename designs in a layout, or save them as entirely new single design workspaces with new names.

To replace a design in a layout with another, do the following:

1.  Select the instances of the design to replace with the **Select Oneups** tool. Hold down CTRL to select more than one instance.
2.  Click **Replace Selected Oneups**. The Replace Oneup(s) dialog box appears.

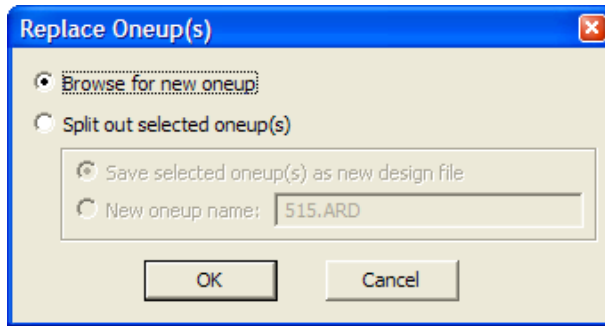

3. There are two main option buttons in the Replace Oneup(s) dialog box. **Browse for new oneup**, when clicked, prompts you to select a new file for replacing the one currently in the layout. Selecting **Split out selected oneup(s)** lets you either save the selected design(s) as a new single design workspace (Save selected oneup(s) as new design file) or just rename the selected design(s) in the layout (New oneup name). Choosing **New oneup name** does not create a new file.
4. Click **OK** to either browse for the new design, save a new workspace, or rename the design in the layout.

If the new design is a different size than the original, or has a different grain/corrugation direction, or a different position, the Replace Oneup Position dialog box appears as shown below.

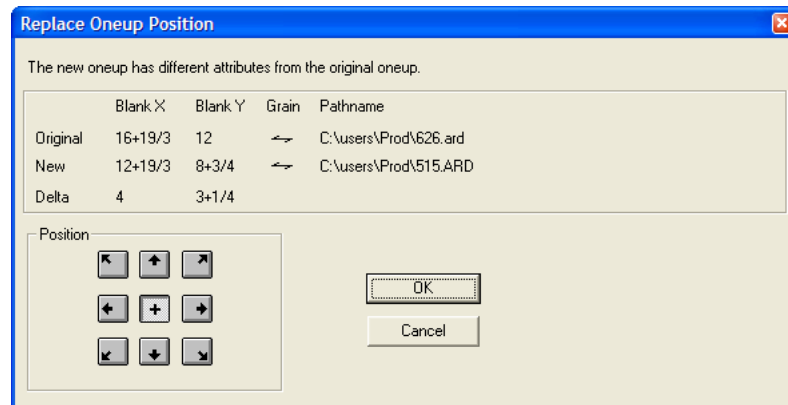

To change the position of the new design in reference to the position of the bounding box of the old design, click the appropriate button in the **Position** group.

How to perform manual sequencing of designs

 ArtiosCAD usually performs automatic sequencing of single designs within a layout when it is output. If desired, you can turn off the fully automatic sequencing in the Output definition and control the automatic sequencing of the single designs yourself using the **Layout Manual Sequencing** tool.

This tool is available only in the Dieboard layer of manufacturing files and also in counter layouts. This tool does not have Undo functionality.

Note: Any sequencing done with this tool will be lost on Output if sequencing is enabled in the Output definition in Defaults. To check for a CAM output, open the Output definition in Defaults and look on the Processing tab. If the **Sequence one-ups in layout** option is checked, ArtiosCAD will discard the manual sequencing you specified when the layout is output. To deselect the checkbox, check the **Enable subroutined output** checkbox and clear the **Sequence one-ups in layout** checkbox. To check for a Sample output, look on the Sample Sequencing tab and clear the **Sequence one-ups in layout** checkbox.

When activated, this tool places option buttons on the Status bar as shown below and performs a default nest from the bottom left by row.



Sequence order numbers appear in the center of each single design indicating their cutting order. Green dashed lines connect the designs. The picture shown below is the default sequence.

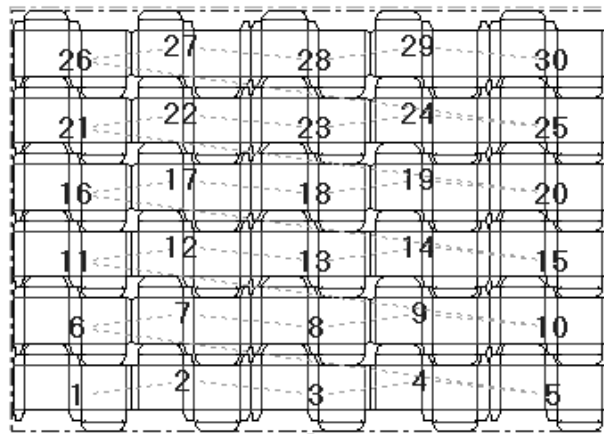

 The first group of four buttons sets the starting point for the sequencing. The first button starts the sequencing at the bottom left of the layout. The second button starts the sequencing at the bottom right of the layout. The third button starts the sequencing at the top left of the layout. The fourth button starts the sequencing at the top right of the layout.

 The second group of four buttons controls the sequencing direction and is not available until a button in the first group is pressed.

The first button sequences each horizontal row, starting each row on the same side of the layout so that each row is sequenced in the same direction, as shown in the picture above, with the starting point at the bottom left.

The second button sequences each vertical column, starting each column on the same side of the layout so that each column is sequenced in the same direction. The picture shown below starts from the bottom left.

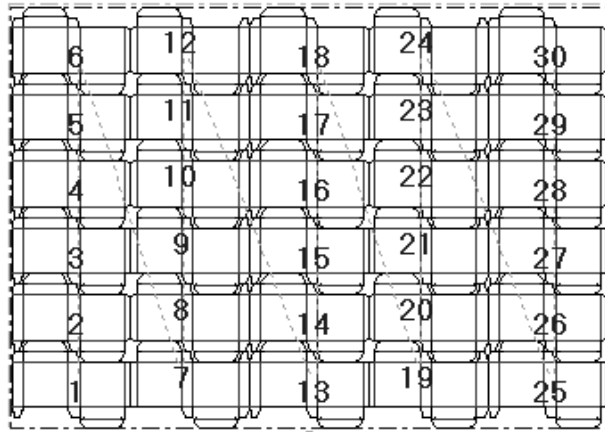

The third button sequences each row, starting on opposite sides of the layout so that each row is sequenced in the opposite direction, forming a horizontal snake pattern. The picture shown below starts from the bottom left.

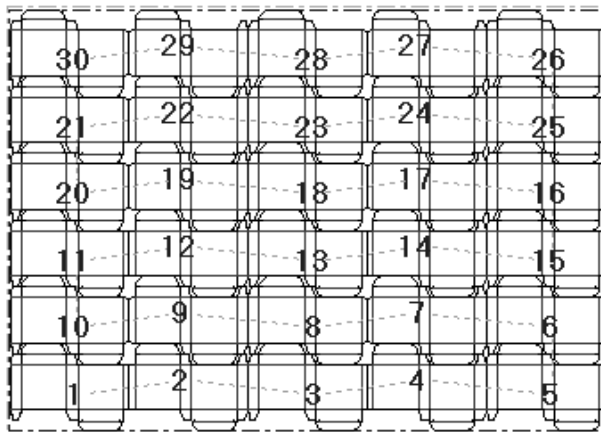

The fourth button sequences each column, starting on opposite sides of the layout so that each column is sequenced in the opposite direction, forming a vertical snake pattern. The picture shown below starts from the bottom left.

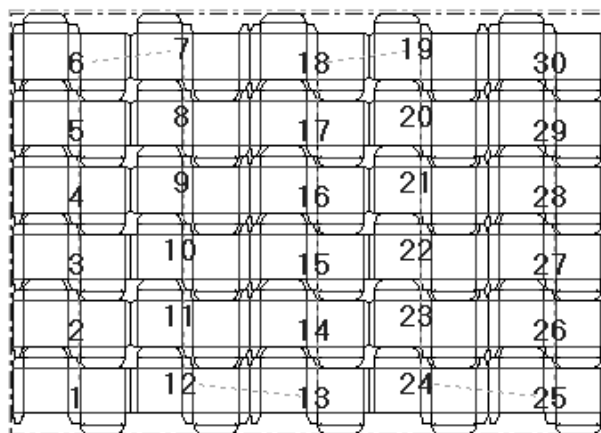

1→2→3→4... The **Sequence All** button lets you manually sequence the single designs in the layout.

To use this tool, do the following:

1. **1-2-3-4...** Click **Sequence All**.
2. Click the first design in the sequence. It will become number one, and all the others will increment up by one to reflect the change.
3. Continue clicking single designs. As you click them, they will be incremented up by one - the first design clicked is one, the second two, the third three, and so forth, with the remaining designs incrementing up by one conforming to the pattern you selected on the Status bar.

The sequence shown below is exaggerated for effect.

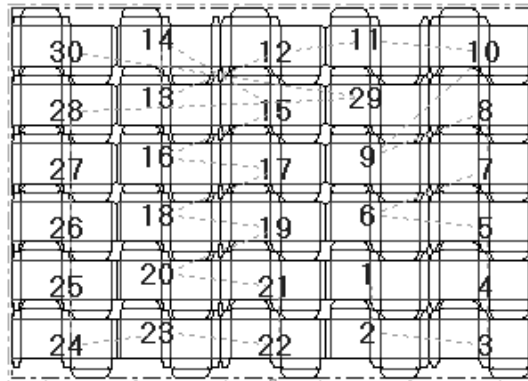

1-2-3-4... The **Sequence Range** button lets you resequence a specific range of one-ups, instead of sequencing all of them.

For example, in the layout shown below, it is sequenced by row, but perhaps it should be a vertical snake instead.

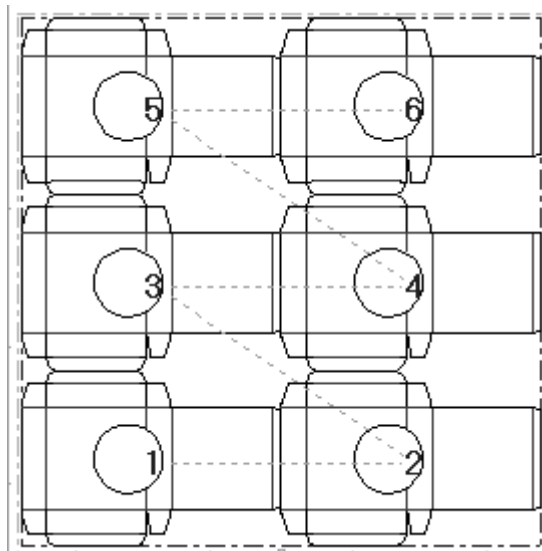

To resequence the single designs without using the automatic sequencing tools, do the following.

1. **1-2-3-4...** Click **Sequence Range** and then click design three. It will not change.

2. **Indicate next item** will appear on the status bar. Click design six. It will change to design four.

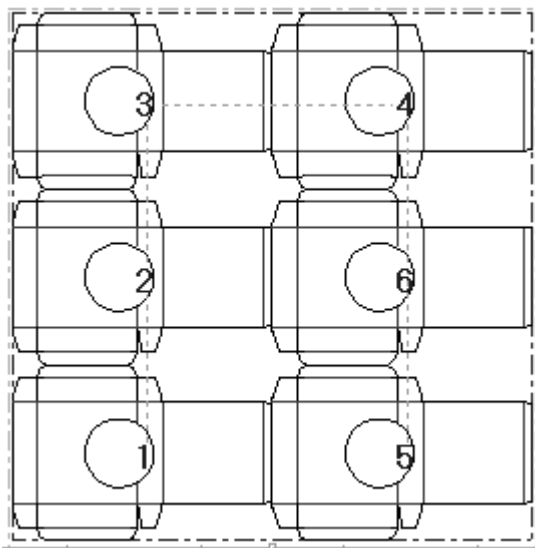

3. Click design six to change it to design five. What was design five changes to design six at the same time, and the resequencing is complete.

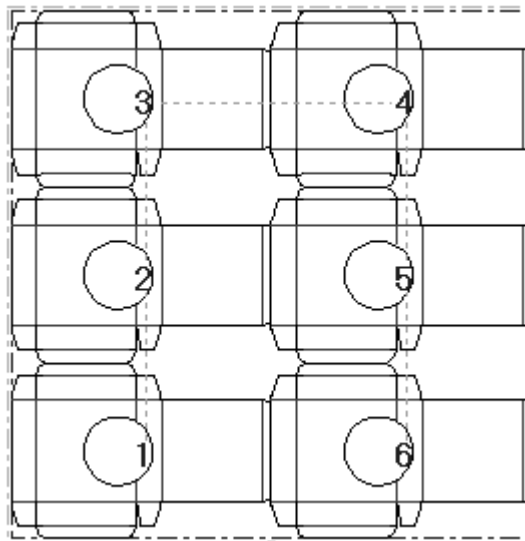

This tool works in the same way for resequencing counter layouts.

Note: Any sequencing done with this tool will be lost on Output if sequencing is enabled in the Output definition in Defaults. To check, open the Output definition in Defaults and look on the Processing tab. If the **Sequence one-ups in layout** option is checked, ArtiosCAD will discard the manual sequencing you specified when the layout is output. To deselect the checkbox, check the **Enable subrouted output** checkbox and clear the **Sequence one-ups in layout** checkbox. To check for a Sample output, look on the Sample Sequencing tab and clear the **Sequence one-ups in layout** checkbox.

How to create tooling

Tooling refers to the manufacturing elements in the presses that actually make the containers. Die boards, rubber, upper and lower stripping boards, and blankers are tooling. You can easily switch which tooling layers are turned on by clicking **Dieboard**, **Rubber**, **Stripping Boards**, or **Blanking** in the Layers dialog box.

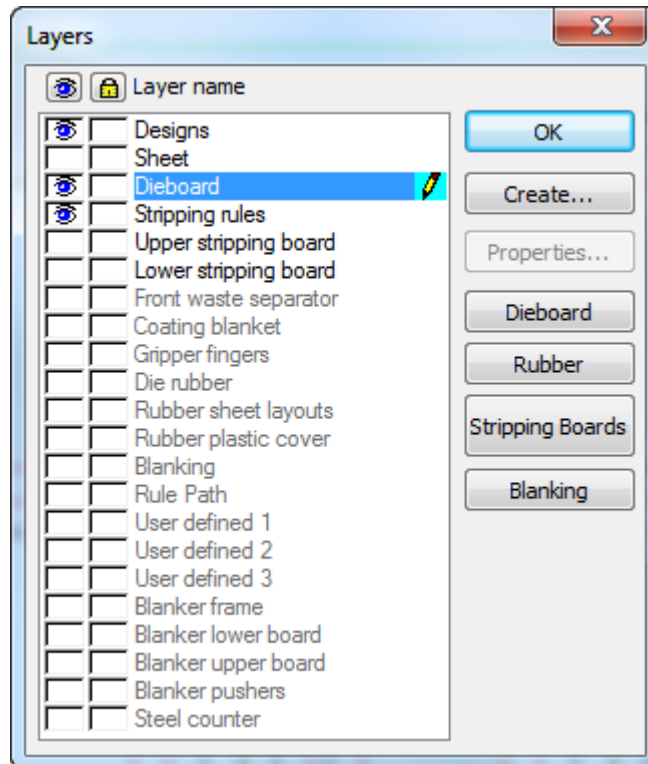



A note on Auto-repeat

 The **Auto-repeat** tool on the View bar automatically repeats elements such as stripping rules, holes, and pins throughout congruent areas of the layout. Clicking the tool turns it on and off.

Auto-Repeat has three different modes. The mode is set in the Auto-Repeat flyout toolbar opened by clicking the drop-down arrow next to the Auto-Repeat button on the View bar.



 **No Mirror** auto-repeats those elements, areas, or constructions that look exactly like the object of the current tool's action.

 **Mirror about Vertical** auto-repeats elements, areas, or constructions that match the object of the current tool's action either exactly or mirrored about the vertical axis (in effect horizontally).

 **Horizontal and Vertical Mirror** auto-repeats elements, areas, or constructions that match the object of the current tool's action exactly, mirrored about the vertical axis (horizontally), or mirrored about the horizontal axis (vertically).

Table: Tools using Auto-Repeat

Add Bridge	Add Interference	Add Nick	Strip Area
Add Tack	Add Upper Block	Add Upper Pin	
Add Upper Rule	Create Carrier Rule	Create Stripping Rule	
Delete (with manufacturing selection)	Delete Bridge	Delete Nick	
Delete Strip Area	Make Air Hole	Move Bridge	
Move Nick	Repeat	Repeat Strip Area	

Auto-Repeat works by comparing what items an object touches or crosses.

Table: Auto-Repeat Dependencies

Element	Auto-Repeated depending on
Stripping rules	Which designs they touch or cross
Air holes	
Lower holes	Waste areas
Pins	Lower hole or edge region they are in
Upper rules	

Element	Auto-Repeated depending on
Blocks	
Lower carrier rules	Which hole or edge region they cross
Block pins	Congruency of blocks contained in
Rule paths	Congruency of potential Rule paths

How to manipulate elements and designs

In order to geometrically manipulate elements (the non-design parts of a manufacturing file) and designs, you first have to select them. Selected items turn magenta. You can use the tools on the Adjust Outline toolbar to manipulate elements as well as the tools listed below.



The **Select Element** tool selects individual elements. Use this tool to select pins, pieces of rule, mounting holes, bars, etc. This tool cannot be used to select any part of a design. Hold down CTRL to make multiple selections.



The **Delete Element** tool deletes the selected element(s). This tool is available only when there is a current selection. This tool uses the settings in the Auto-Repeat dialog box.



The **Repeat Element** tool takes a single element and auto-repeats it throughout the manufacturing file. This tool is available only when there is a current selection. It mirrors according to the settings in the Auto-Repeat dialog box.



The **Select Oneups** tool selects a design. Hold down CTRL to make multiple selections.



The **Delete Oneups** tool deletes the selected design(s). This tool is available only when there is a current selection.



Creating the dieboard edge

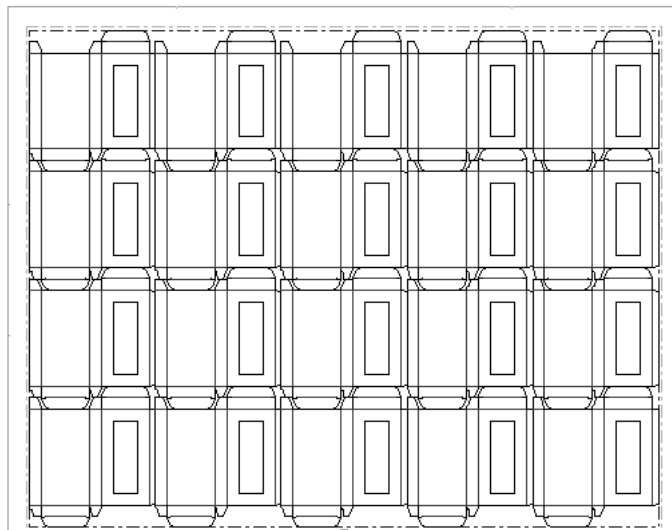
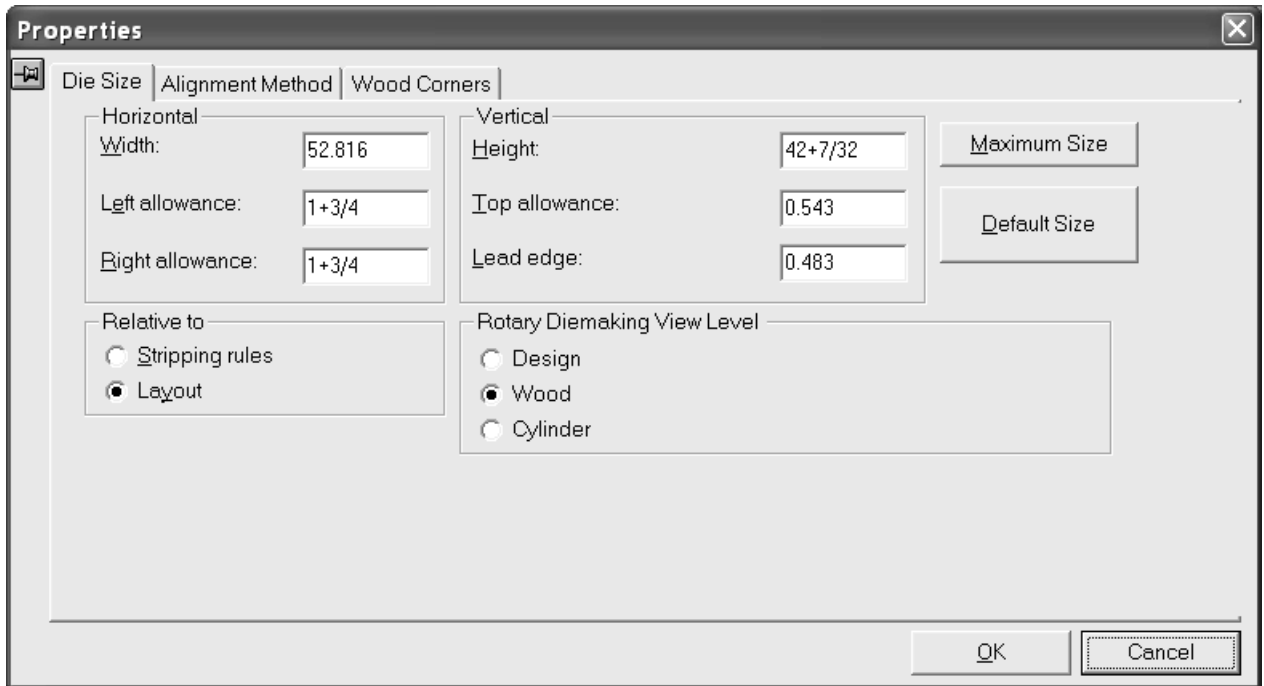

Once the designs are nested, create the dieboard edge. If necessary, switch to the Dieboard layer using the layer control on the View bar. Click the **Create Wood Edge** tool to automatically create a dieboard edge. If the die wood is not in the position you would like, select it and double-click it to access the Properties dialog box. You can then change the dieboard size, how it is aligned, the method for making the corners, and if it is a rotary die, the level at which the layout is viewed. Click **OK** to return to the layout.



Once the dieboard edge is created:

-  use the **Create Hand Hold** tool to add hand holds.
-  use the **Create Burn Name** tool to add a burn name, or use a Geometry Macro to add a more verbose burn name.
-  use the **Add Tack Bridge** tool and the **Delete Bridge** tool to add and remove tack bridges. Click the **Add Tack Bridge** tool and click the point on the die wood edge where you want the tack bridge. Click the **Delete Bridge** tool and indicate the tack bridge to delete.
- Double-click the dieboard edge with a **Select** tool to change its properties.

How to create scrap knives

Scrap knives chop the waste into evenly sized rectangles. Where the waste meets the design, the waste follows the contour of the design but fits into the grid of scrap knives on its other edges.

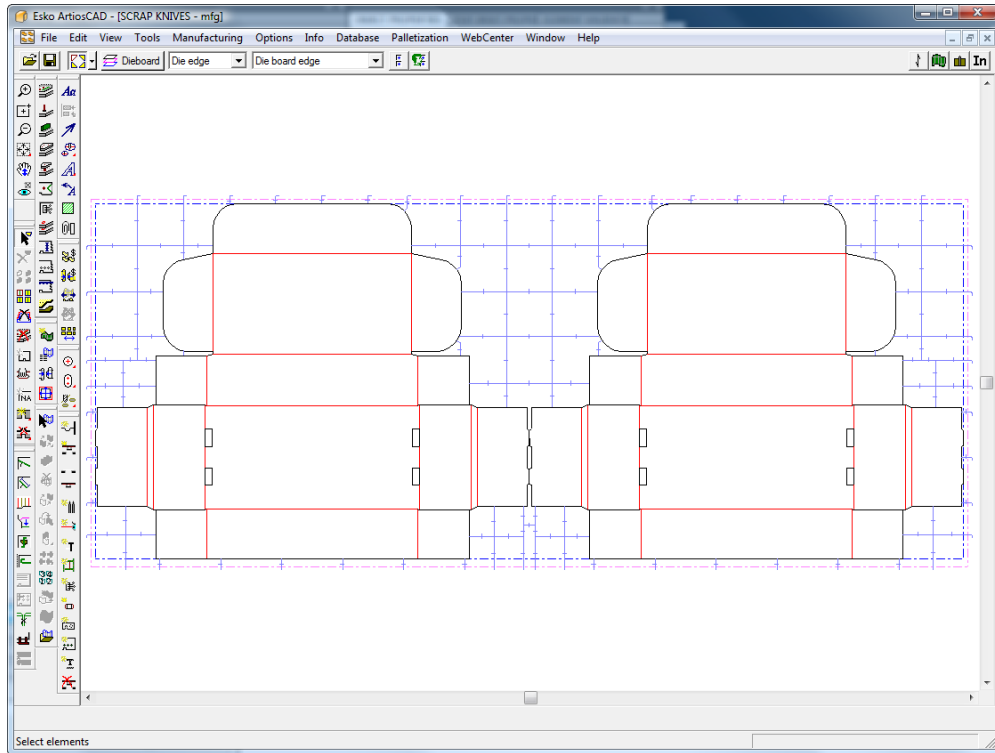

Scrap knives use the same stripping edge and hook parameters as **Create Stripping Rule**.

Scrap Knives dialog box

When you create scrap knives, the Scrap Knives tool first opens the Scrap Knives dialog box so you can set how ArtiosCAD will create them.

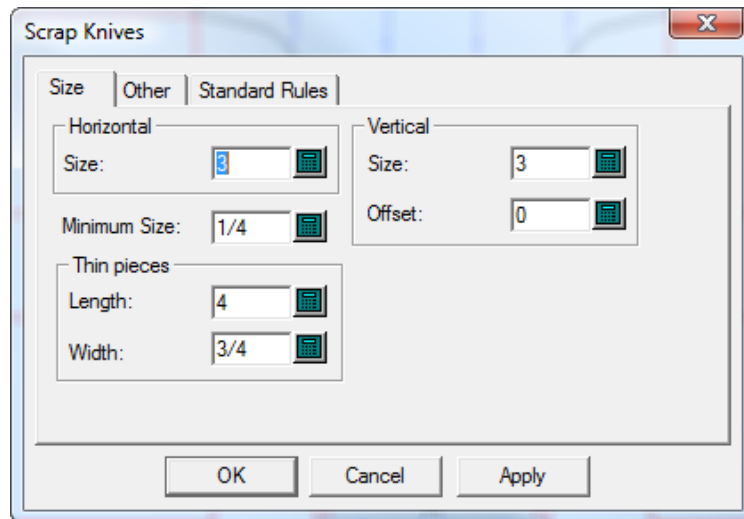

The values in **Horizontal** and **Vertical** set the size of the pieces. If **Offset** is set to a non-zero value, the vertical lines zig-zag by that amount. There can be slight exceptions to these sizes to compensate for corner offsets and bend lengths.

Thin pieces of waste can be a little longer than the nominal width or height of normal scrap pieces. In the **Thin Pieces** group, set the size limits for such pieces. ArtiosCAD chops pieces of scrap whose width is less than or equal to the thin width into pieces whose length is less than or equal to the thin length.

The Other tab of the Scrap Knives dialog box is shown below.

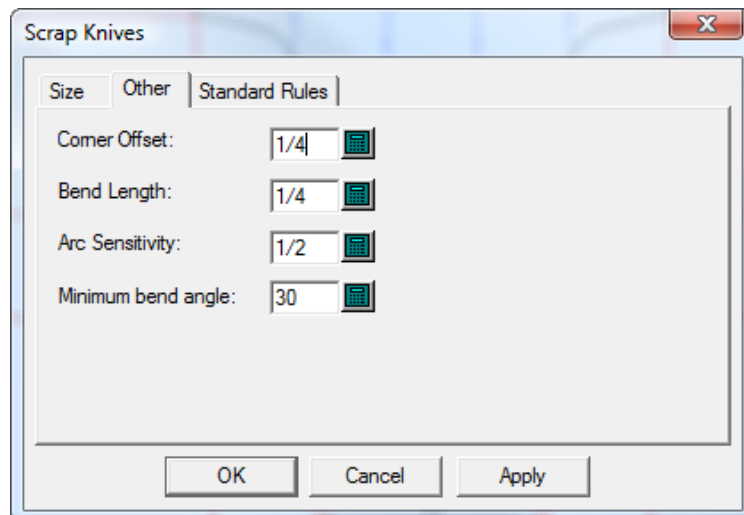

Corner Offset sets how far scrap knives must be from a corner. For optimal results, the corner offset should be less than 1/5 the horizontal and vertical size.

ArtiosCAD will bend a scrap knife to meet the design perpendicularly if the angle at which it meets the design is more than the **Minimum bend angle**. The value in **Bend Length** sets the length of the segment that is perpendicular to the design.

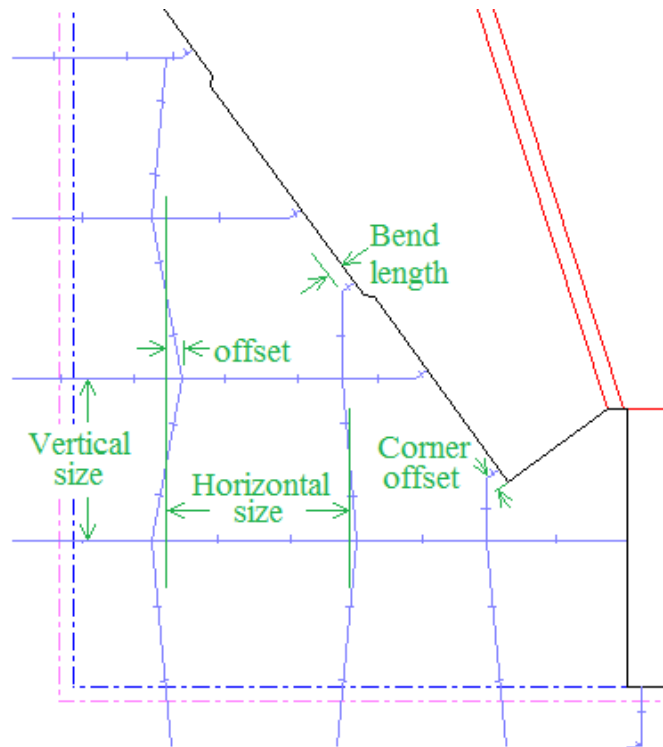

ArtiosCAD considers arcs larger than the value in **Arc Sensitivity** to be blends. Scrap knives generally do not meet arcs and are positioned away from them by the amount of the corner offset. But if an arc is large enough, a scrap knife can meet it.

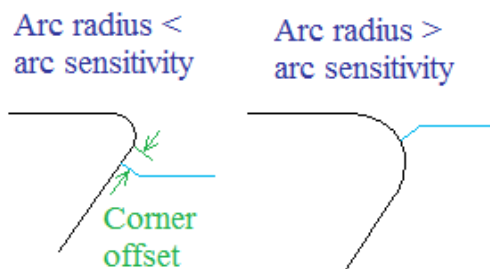

Some diemakers use standard-sized pieces of rule with an optional hook on the end when a scrap knife extends off the sheet. Standard rules may be slightly shorter than the scrap knives they replace so that they do not go outside the stripping edge. These standard rules are defined on the Standard Rules tab of the Scrap Knives dialog box.

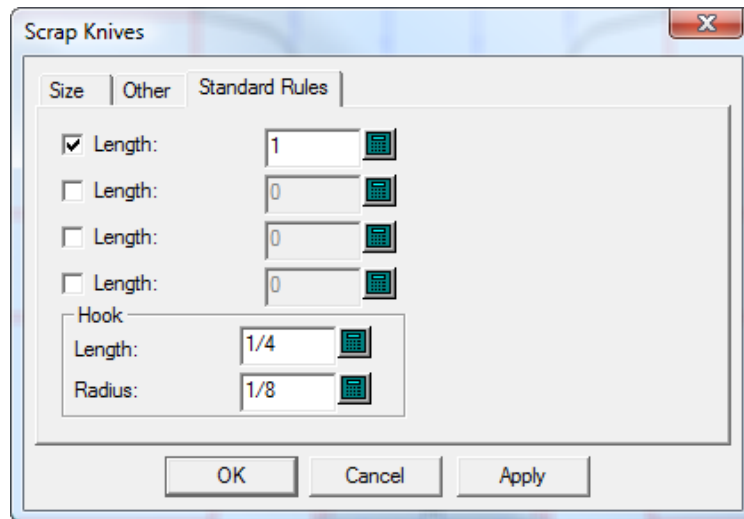

You can define four such pieces of rule in Defaults (**Options > Defaults > Die Press parameter sets > Your press > Scrap knives > Standard Rules**). Check the checkboxes for the standard pieces of rule to use and change the **Length** if desired. Change the **Length** and **Radius** for the hook if desired.

ArtiosCAD follows these rules when placing standard rules:

- If the length of the rule being replaced is between the lengths of two standard rules, it will use the shorter one.
- The length of the standard rule must be less than or equal to the length of the rule it replaces.
- The amount the standard rule passes the edge of the sheet minus the hook must be at least half as much as the rule it replaces.
- Standard rules on the leading edge do not get hooks, because there is usually no room to fit the hook in the die.

Adding scrap knives to a layout

To add scrap knives to a layout, do the following:

1. Create a layout in ArtiosCAD.
2. Click **Tools > Scrap Knives**.

The Scrap Knives dialog box appears.

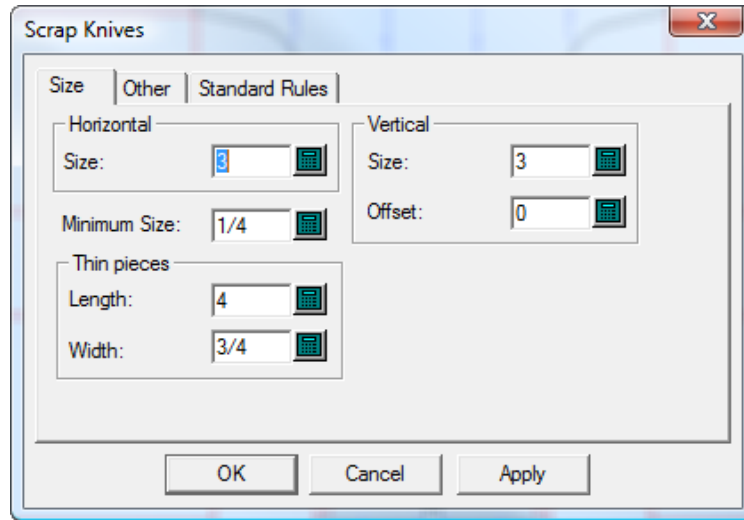

3. When you have finished setting the options on all the tabs of this dialog box as described previously, click **OK** to create the scrap knives.

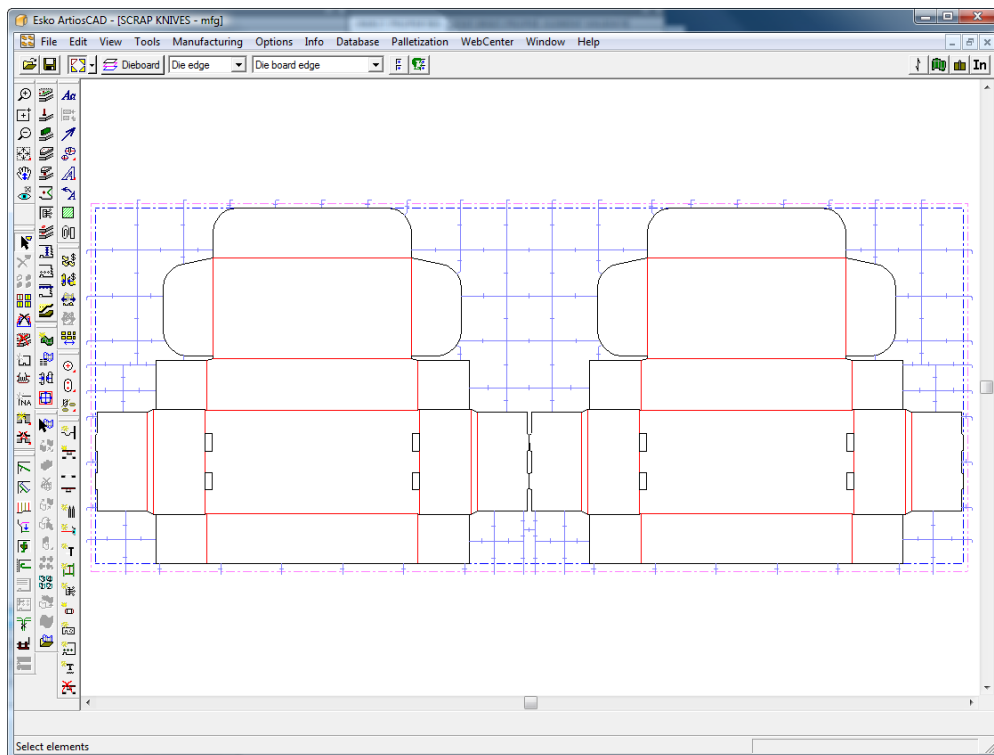

To make a corner be one continuous rule, add stripping rules at the corner before adding scrap knives.

How to create evenly-spaced scrap knives

 The **Evenly Spaced Scrap Knives** tool creates scrap knives in the waste to the side of an existing line, typically a stripping rule.

The **Evenly Spaced Scrap Knives** tool has two modes. The first mode is when a stripping rule is clicked as the first scrap knife and a freehand coordinate is clicked as the second point. The second mode is when a stripping rule is clicked as the first scrap knife, and then another stripping rule is clicked as the last scrap knife.

Shown below are the scrap knives created when the stripping rule on the left dust flap of the lid of the left design is chosen as the first scrap knife and the drag is moved to the right with the cursor being kept near the top of the sheet. The knives are evenly spaced until the drag is set, after which the **Number:** field becomes available for changing as desired. Once the **Size:** and the **Number:** fields are set, click **OK** to create the scrap knives.

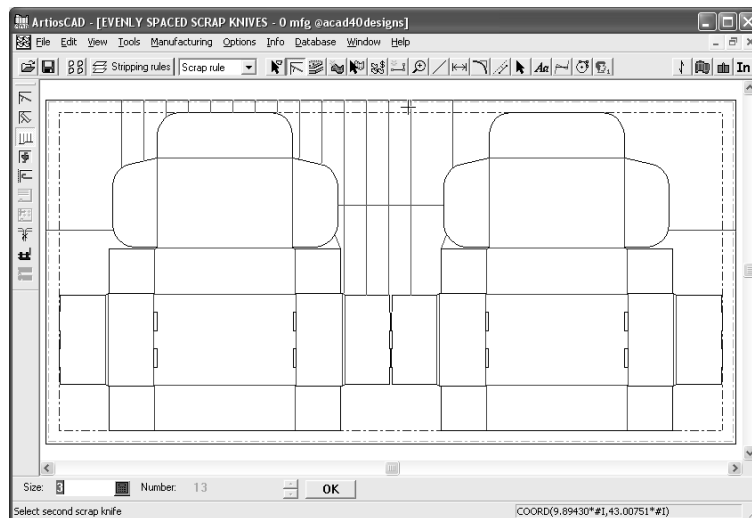

To use the tool in its first mode, do the following:

1. Create a layout and add stripping rules to it.
2.  Click the **Evenly Spaced Scrap Knives** tool.
3. Click a stripping rule from which the scrap knives will be offset.
4. Use the drag to set the number of scrap knives and click the mouse button somewhere that is not on a line.
5. Review the values in the **Size:** and **Number:** fields, changing them if desired.
6. Click **OK** to create the scrap knives.

To use the tool in its second mode, do the following:

1. Create a layout and add stripping rules to it.
2.  Click the **Evenly Spaced Scrap Knives** tool.

3. Click a stripping rule from which the scrap knives will be offset.
4. Next, click another parallel stripping rule as the final scrap knife.

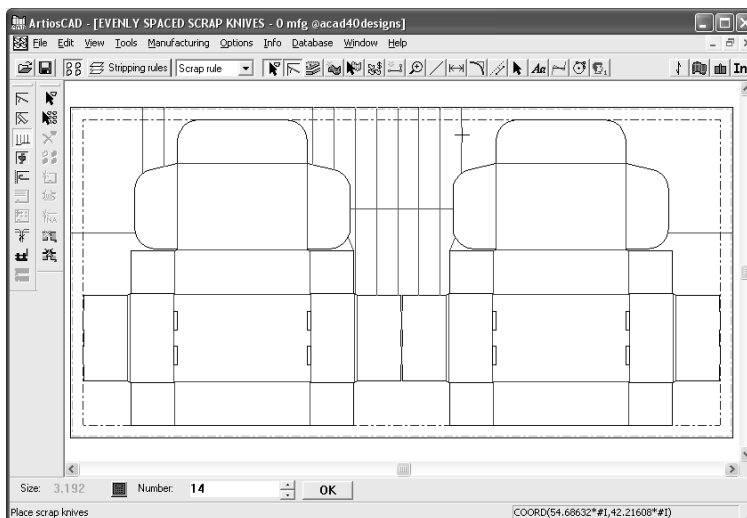

Note that the **Size:** field has changed so that a whole number of scrap knives can fit between the first stripping rule and the second stripping rule.

5. Adjust the value in the **Number:** field as desired and click **OK** to create the scrap knives. Note that the distance between each knife changes as the number of knives changes.

The drag for this tool is very sensitive. The tool can operate differently just by clicking a few pixels apart.

If you click another line as the last scrap knife, that has the effect of accepting the currently-shown scrap knives and restarting the tool with the selected line being the first scrap knife. This allows the quick and easy creation of several sets of chop knives.

Properties of evenly spaced scrap knives

Scrap knives created with the Evenly Spaced Scrap Knives tool are made with line type **scrap knives**.

They use default bridging and their default pointage is set in **Options > Stripping rules**.

Whether they have hooks on the end is set in **Options > Hook Defaults**.

For rotary dies, the bend length (or perpendicular offset) is set in **Tools > Scrap Knives > Other > Bend Length**.

If a scrap knife is made from more than one line, a group is created so it can be selected as one item.

The initial value for the **Size:** field is set in **Options > Defaults > Die press parameter sets > Parameter set > Scrap Knives > Size > Horizontal Size**. To change it on the fly, click **Tools > Scrap Knives** and set the **Size:** field in the **Horizontal** group.

How to move scrap knives

 Use the **Move Scrap Knife** tool to move a scrap knife or stripping rule that is not in the desired location.

When this tool is active, it has settings on the Status bar as shown below.



The first button sets the offset of the moved or copied scrap knife to be from the selected rule, while the second button sets the offset to be from the nearest end of a line.

Parallel controls whether or not the drag will only snap to positions parallel to the original scrap knife or if the drag will snap to positions perpendicular to the original alignment as well.

Copy makes a copy of the selected scrap knife instead of moving it.

Offset sets the offset distance from either the selected rule or the nearest end of a line according to which button is pressed.

To use this tool, do the following:

1.  Click the **Move Scrap Knife** tool and then click the scrap knife to move.
2. Drag the knife to the new position. If there is a bend on the start of the rule, it will be recalculated as needed. If you align the new scrap knife with an existing scrap knife, a dotted line will be drawn between the two to indicate alignment.

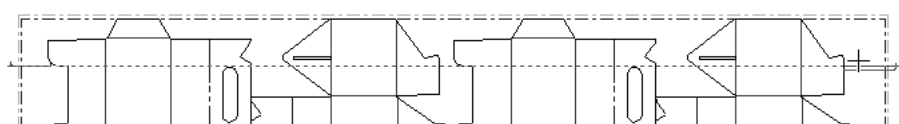

3. Click the put-down point for the new scrap knife.

How to add balance knives

 Balance knives are used to balance the die wood when the die wood has a lot of empty space on it. To use this tool, click it. Balance knives will be added according to the values in the fields in the Status bar. Shown below is a layout before adding balance knives.

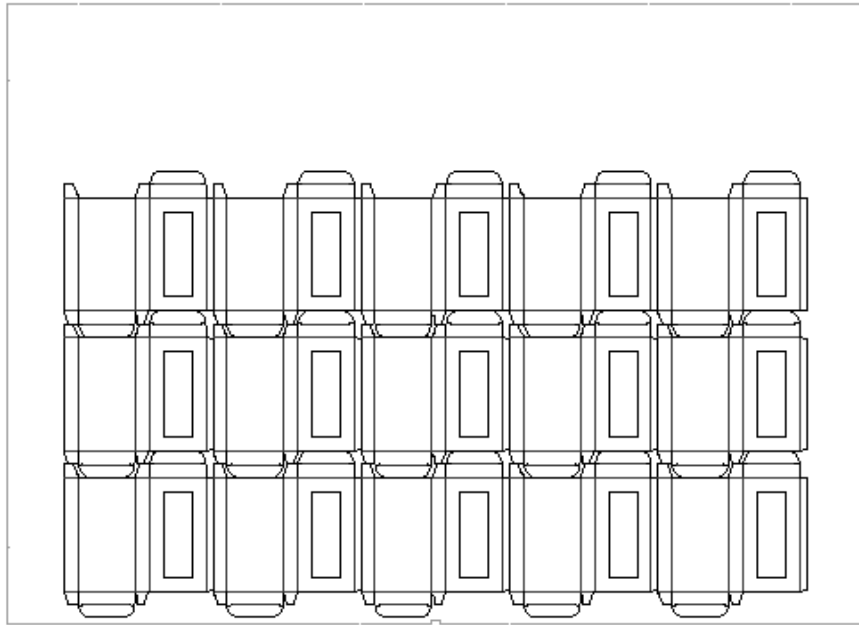

Shown below is the same layout after balance knives have been added.

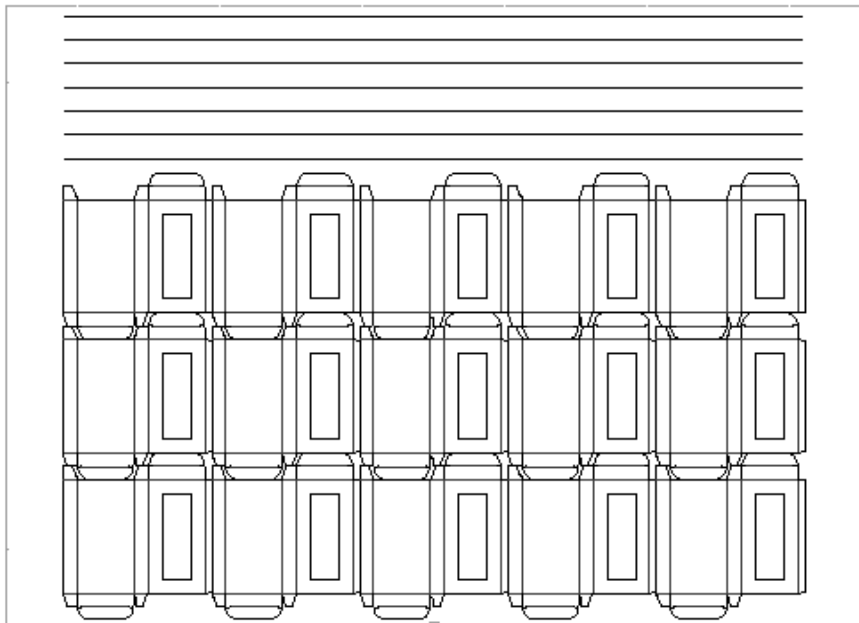



Edit the properties of balance knives by using the fields on the Status bar. **Distance between:** is shown only for reference and may not be changed.



Balance knife operation is defined in the Die Press parameter set in Defaults. The length of the rule can be calculated according to a rule-saver formula, which minimizes the rule needed, or the rule can be set to extend to the design blank edge or the stripping blank edge. Balance

knives are computed in the Rule Length dialog box as **Balance rule**. The **#BRLEN** expression calculates the length of the balance knives.

How to create stripping rules

  Two tools create stripping rules: the **Line/Edge** tool and the **Angle/Offset** tool. The **Line/Edge** tool creates a stripping rule from the point you indicate in the direction that you set until it intersects with another line or an edge. The **Angle/Offset** tool creates a stripping rule with the angle and offset end-point that you specify. Hooks are automatically added to the stripping rules on the trailing edge. The stripping rules are automatically repeated throughout the layout unless Auto Repeat is turned off.

Note: You cannot create exterior stripping if there is a full lower board.

When either of these tools are active, options which control their use appear on the Status bar.

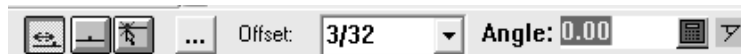

The three buttons on the left control the starting point of the stripping rule. The left most button is **Offset** from the end of a line, the middle button is **Center** of a line, and the rightmost button is **Anywhere**.

 **More options** lets you change the stripping rule options in the Stripping Rules Settings dialog box, also accessible by clicking **Options > Stripping Rules**, as shown below.

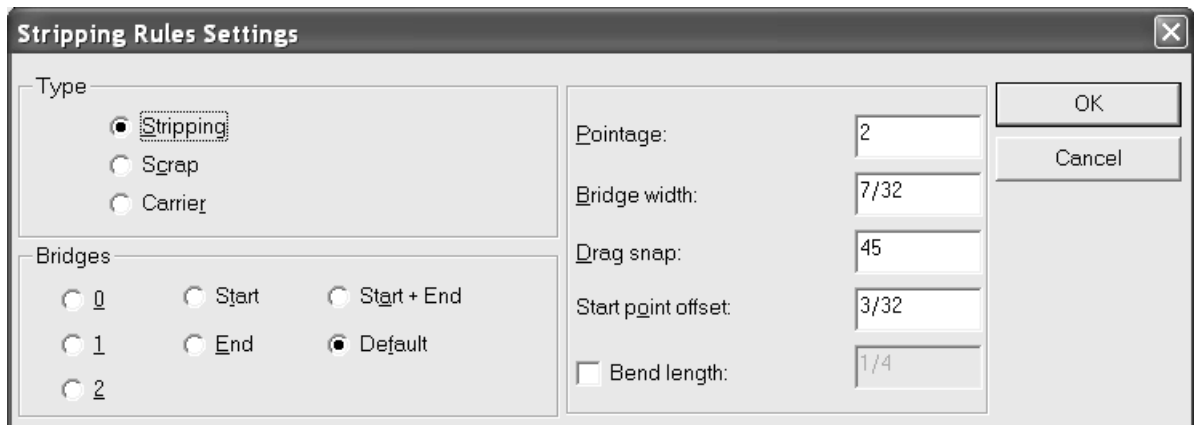

In the picture below, stripping rules extend from some of the dust flaps.

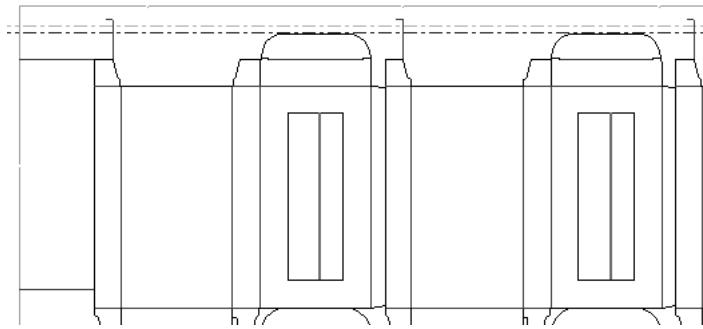

How to create carrier rules

 Use the **Create Carrier Rule** tool to create carrier rules. Carrier rules support gaps in the boxes through the press so that they do not snag and jam the press. To use this tool, click it, indicate the point at which the carrier rule starts, and then indicate the point where it ends. The flaps are added to carrier rules when you strip the carried area.

 To add carrier rules, click the **Create Carrier Rule** tool and indicate the start and end-points for the carrier rule. The Status bar shows the same start options for carrier rules as it does for stripping rules.

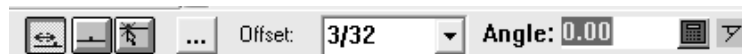

The three buttons on the left control the starting point of the carrier rule. The left most button is **Offset** from the end of a line, the middle button is **Center** of a line, and the rightmost button is **Anywhere**.

 **More options** opens the Stripping Rules Settings dialog box. Since these are carrier rules, you cannot change the type of rule being created. Set the number of bridges, pointage, bridge width, the snap angle for the drag, and the start point offset as desired. Click **OK** when done to return to the tool.



Once the carried areas are stripped, there are two ways to change the properties of a carrier rule.

The first way to set carrier rule properties is to use the **Select Element** tool in the Stripping Rules layer to double-click the carrier rule. This changes how the stripping rule that is a carrier rule is displayed in the Stripping Rules layer. A Properties dialog box appears with rule properties as shown below.

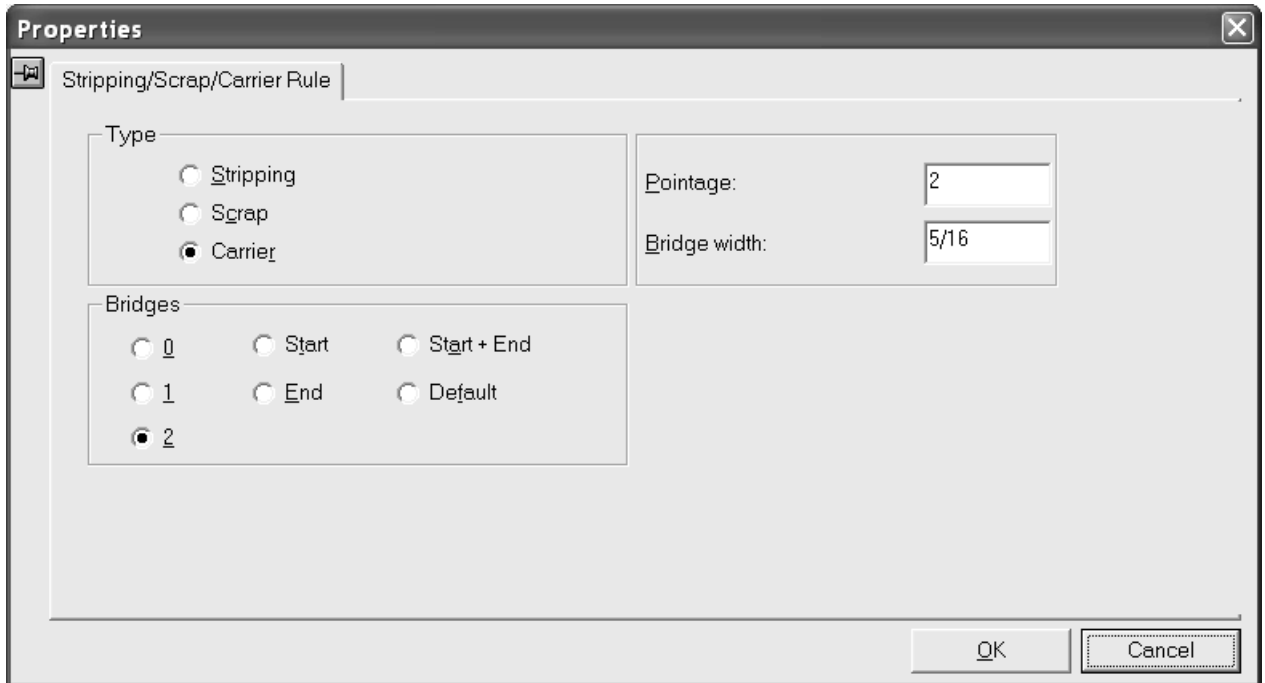

The second way to set carrier rule properties is by changing to the Lower Stripping Board layer and using the **Select Element** tool to double-click the rule. This changes how the rules are manufactured in the stripping board itself. The Lower Rule Properties dialog box opens as shown below.

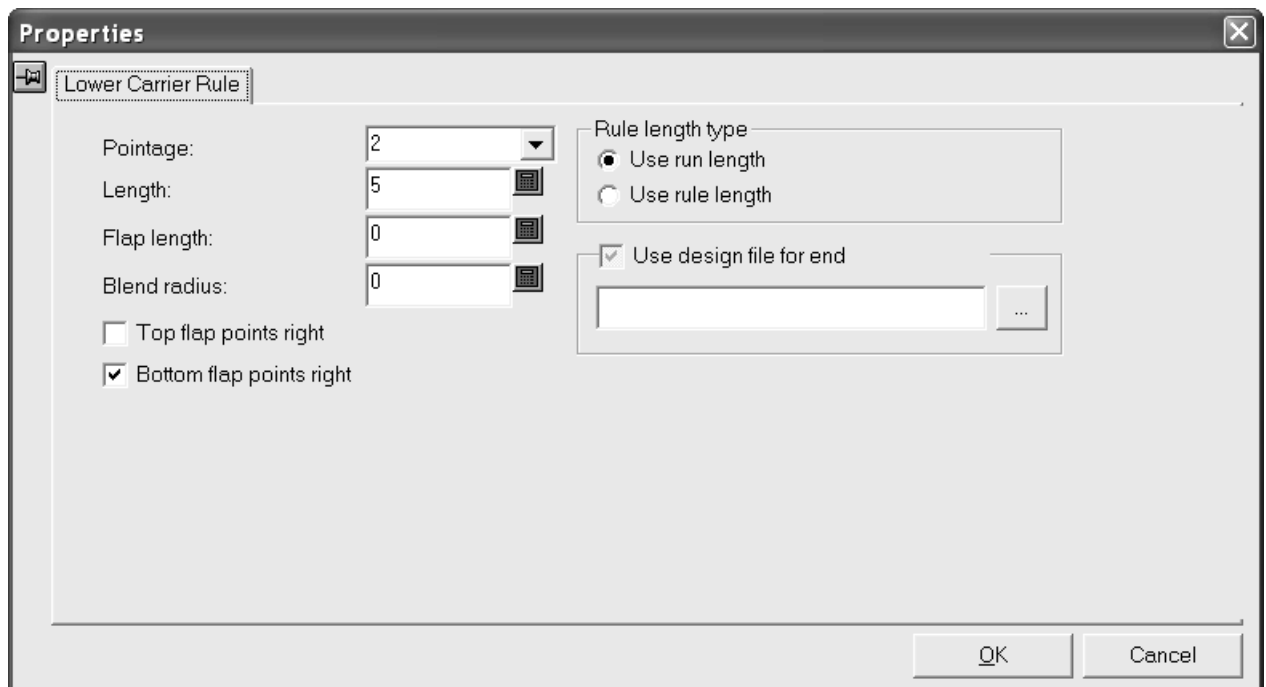

Change the pointage of the carrier rule by choosing a new value from the **Pointage** drop-down list box.

The length of the carrier rule shown in the **Length:** field depends on the option button chosen in the **Rule length type** group. **Use run length** shows the length of the rule without the flaps. **Use rule length** shows the length of all the rule.

Use design file for end lets you specify a custom flap end.

You can design any end as desired. In Designer, start at the origin and work to the upper right using line type **Unknifed lower** for rule and line type **Lower registration hole** for any holes. The origin will be the end point of the end of the carrier rule. Do not use line type Annotation5. Save the workspace to ServerLib and specify it in Defaults in the Carrier Rules entry in Automatic Stripping in a manufacturing parameter set.

The **Top flap points right** and **Bottom flap points right** checkboxes change the direction of the top and bottom flaps, respectively. The flaps are applied when the layout is stripped.

Change the properties as desired and click **OK**.

In the example below, one carrier rule was created manually. The rest of the designs have the carrier rule Auto-Repeated in them.

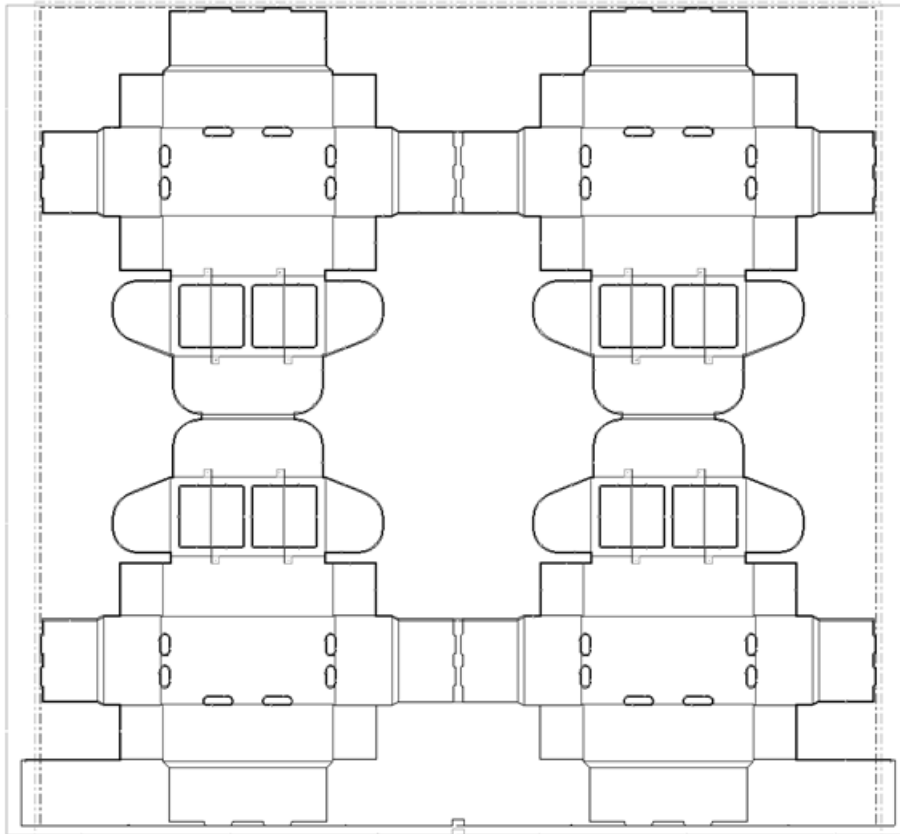

When an area containing a carrier rule is stripped, the rule between the edges of the hole is converted to an Annotation5 line type. This prevents the laser from burning a rule path in the material under the hole when the stripping board is created.

How to add hooks to stripping rules

 ArtiosCAD creates hooks on the ends of stripping rules by default. This can be changed, however, in the Hook Defaults dialog box accessed via the **Options** menu. If you have added stripping rules without hooks and later decide that you want hooks, use the **Make Hook** tool. To use this tool, click it, and then indicate the stripping rule that you want to have a hook. If Auto-Repeat is on, the hook will be created on all congruent stripping rules.

How to create a lower board mounting bar

 When making a stripping board that follows the layout edge, you must create a mounting bar for the lower stripping board. The mounting bar defines where to start stripping the edges. Use the **Add Lower Board Mounting Bar** tool to add the bar.

When this tool is clicked, options for it appear on the Status bar as shown below.

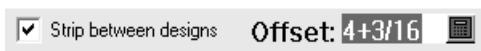

Strip between designs inserts stripping rules between single designs under the mounting bar. (They are only visible when the Lower stripping board layer is turned off.) **Offset** lets you specify the distance from the board edge to the mounting bar instead of setting it with drag.

To use this tool, click it, set the options on the Status bar as desired, and either specify an offset for the bar location or use the drag to set it. A sample mounting bar is shown below.

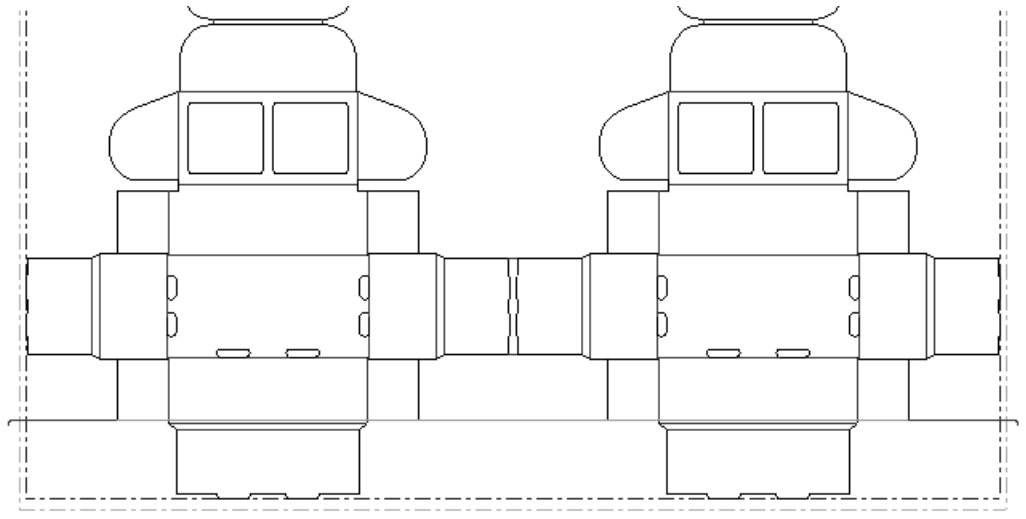

This tool uses the stripping rules settings and is consistent with **Move Scrap Knives**. To control if there are hooks on the ends, click **Options > Stripping Rules > Bend Length**.

How to add and work with mounting holes

 The **Add MHP Holes** tool adds Mounting Hole Pattern holes to the manufacturing workspace. When held down, it activates the MHP Tools flyout toolbar.



These tools are available only after the die wood edge has been created.

Add MHP tool

 The **Add MHP Hole** tool copies the mounting hole pattern workspace associated with the selected die press into the manufacturing file. Mounting holes can be either **good** or **bad** - bad holes are those that are too close to other manufacturing elements as defined by the T-nut Distance default.

There are two options in the Status bar: **Show all holes** and **Show only good holes**. Good holes are green and bad holes are red. Choose what kind of holes to see, and then hold down either SHIFT or CTRL and click each mounting hole to use. Click **OK** when all desired holes have been selected, and the selected holes will be created.

The side of the layout the pattern is applied to is defined in Defaults on the **Hole Patterns** page of the **Press Defaults** in the **Die press parameter sets** folder.

Select MHP tool

 The second button on the MHP Tools flyout toolbar activates the **Select MHP** tool. This tool redisplay the mounting hole pattern and lets you select more holes to add using the same procedure as the **Add MHP** tool. Pre-existing holes are automatically selected.

Delete All MHP tool

 The third button on the MHP Tools flyout toolbar activates the **Delete All MHP** tool. This tool deletes the current mounting holes. When clicked, ArtiosCAD prompts for confirmation; to delete the holes, click **OK**; to keep the holes, click **Cancel**.

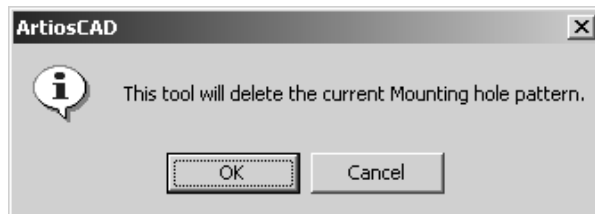

Adjust MHP Horizontally tool

 The fourth button on the MHP Holes flyout toolbar activates the **Adjust MHP Horizontally** tool. This tool shifts the layout horizontally in reference to the MHP to allow for more flexible die placement on the press. To use this tool, click it, click the pick-up point, drag the ghosted layout to its new position, and set the put-down point. Annotation lines for this tool appear only for rotary dies. The measurement indicates the offset from the original MHP placement point (either the Machine Reference Point or the bottom left of the dieboard).

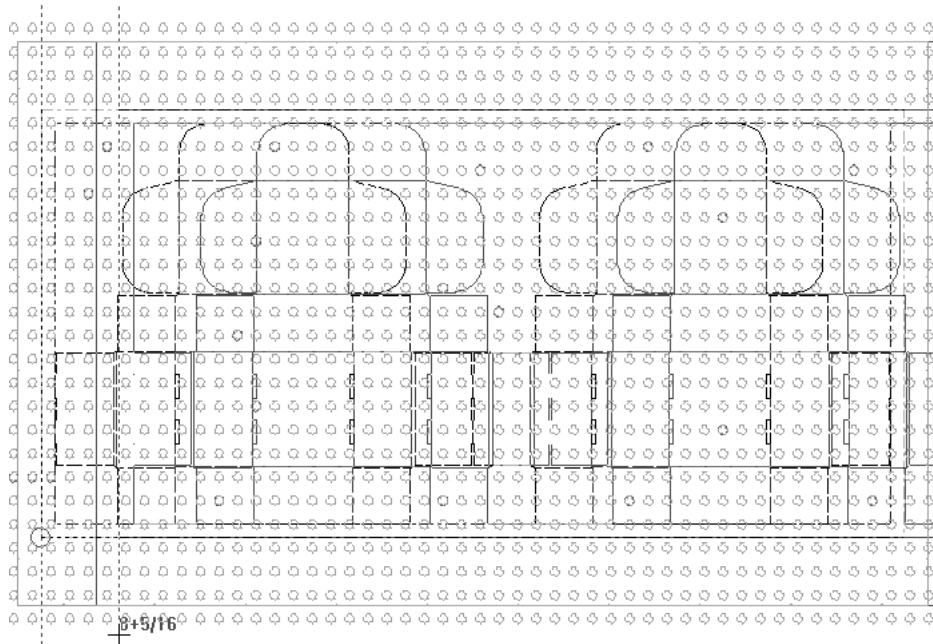

Adjust MHP Vertically tool

 The fifth button on the MHP Tools flyout toolbar activates the **Adjust MHP Vertically** tool. This tool shifts the layout vertically with respect to the MHP to allow for more flexible positioning of the die. To use this tool, click it, select a pickup point, drag the ghosted layout to its new position, and set the put-down point. Annotation lines for this tool appear only for rotary dies. The measurement indicates the offset from the original MHP reference point (either the Machine Reference Point or the bottom left of the dieboard).

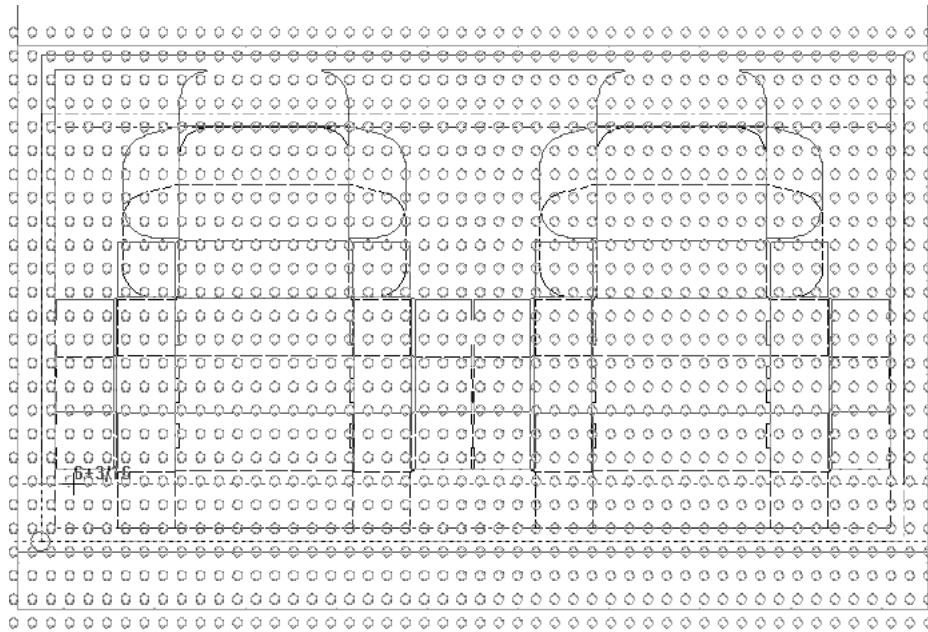

How to remove double knives



Double knives are created when cartons abut each other. To remove them, click the **Double Knife Removal** tool. In the Double Knife Removal dialog box, choose the option you'd like to perform.

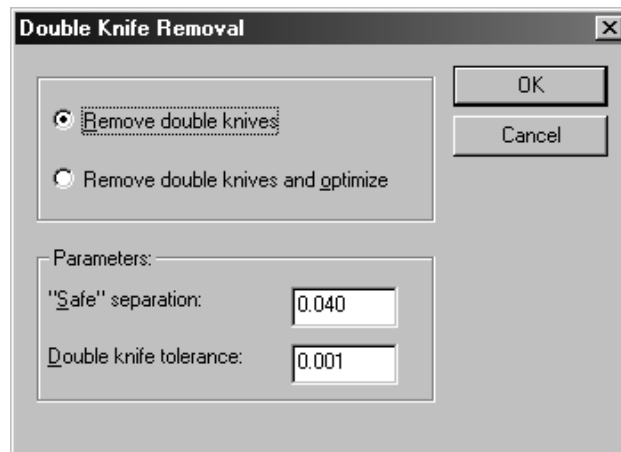

In the **Parameters** group, **Double knife tolerance** is the distance in current units that rules must be apart from each other to not be considered double knives. **“Safe” separation** is the minimum distance two lines must be from each other to be ruled individually. If you have lines that are closer than the “safe” separation distance but further than the Double Knife Tolerance, the following dialog box appears when you attempt double knife removal:

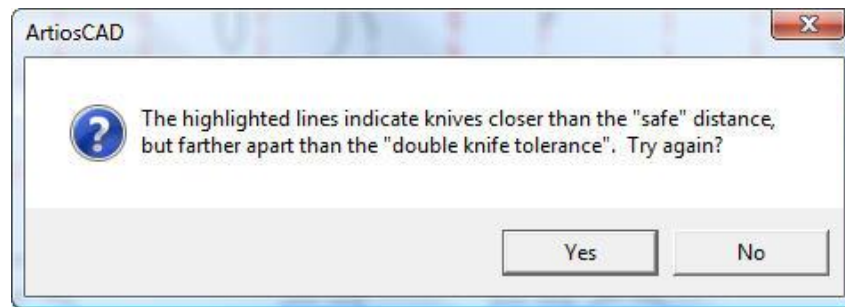

Click **Yes** to return to the Double Knife Removal dialog box or click **No** to return to ArtiosCAD to fix the error.

Nicks may move if double knives are removed after adding nicks.

Double knife removal does not remove special rules with nick sizes larger than 0 as they are considered special rule, not cut lines.

Undoing double knife removal puts back the original linetype if there is an example of it in the layout layer; otherwise, it puts back cut lines.

Double knife tolerance defaults are stored in **Options > Defaults > Shared Defaults > Startup defaults > Double Knife Removal**.

How to show gripper fingers



Click the **Add Gripper** tool to show gripper fingers for the die press.

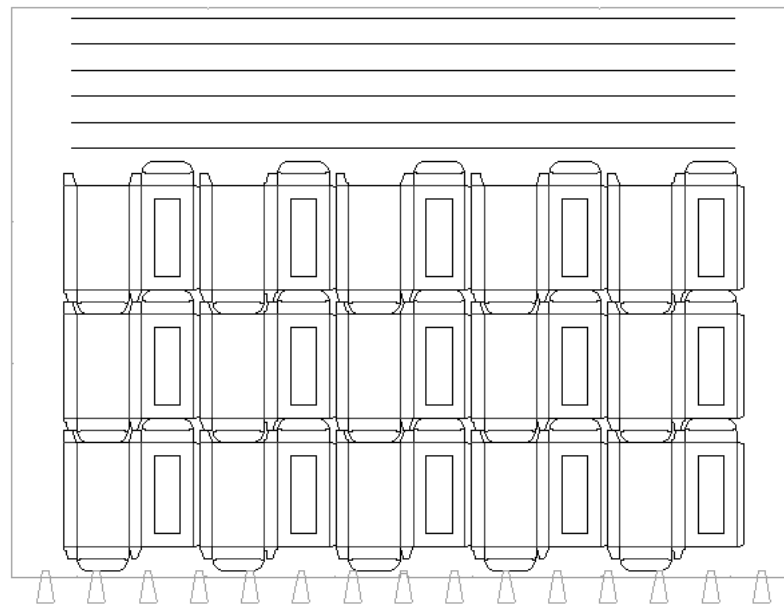

How to work with bridges, tack bridges, and nicks

Bridges, tack bridges, and nicks in Manufacturing use the same tools as in Single Design; see the *Designer* chapter for more information.

Nicks may move if they are added before removing double knives.

How to create internal and external stripping

Once a mounting bar or stripping rules have been added to the layout, you can add interior and exterior stripping just by clicking inside the area to strip. To ensure that the settings are correct, check the Stripping Board options by clicking **Stripping Boards** on the **Options** menu and reviewing the settings on the tabs. The default settings are set in the Automatic Stripping catalog of a manufacturing parameter set in Defaults.

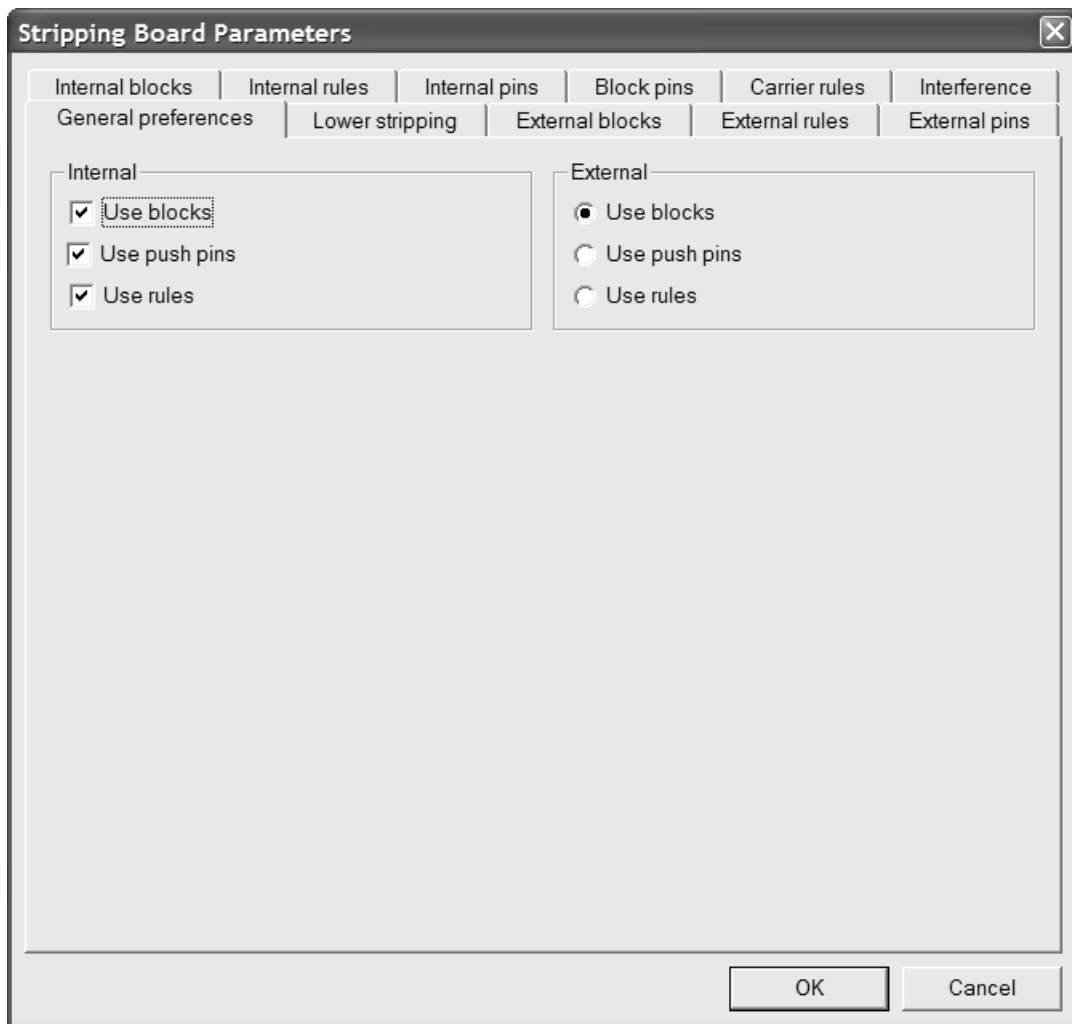

 If the settings on the tabs in the Stripping Board Parameters dialog box are acceptable, begin stripping the sheet using the **Strip Area** tool. This tool can create holes in the upper and lower stripping boards, add blocks, pins, and rules, make a guillotine, and add support pins. Blocks, pins, and rules are added in that order.

The option buttons on the Status bar determine what stripping tools are automatically created. The picture below is of the option buttons on the Status bar.



Lower, **Upper**, **Internal**, and **External** control which areas of stripping are created; select them as desired.

The  button (More Options) opens the Stripping Board Parameters dialog box as shown previously. **Recalculate all** deletes and recreates the existing stripping board edges and internal and external stripping.

Note: On the Lower Stripping tab of the Stripping Board Parameters dialog box, if you make the value in the **Offset below wing:** field different from the **Offset:** field with Auto-Repeat on, the repeated block has the wrong offset. The strip areas are considered to be congruent because they have the same shape, even though the blocks have different offsets.

Click inside an area of waste to strip it. Any congruent areas will be stripped according to current Auto-Repeat settings. You cannot strip areas that are part of a design unless they are windows or cutouts. Or, to perform all the stripping at once, activate the tool and click **Recalculate All**.

Click in the waste outside the design edge between stripping rules to strip the external waste. If slots in the external waste are divided from the exterior waste by scrap knives, carrier rules, stripping rules, or are narrower than the slot width parameter, they are stripped as if they were interior holes. Exterior blocks made this way follow stripping rules but ignore scrap knives.

Shown below is a layout before using **Strip Area**.

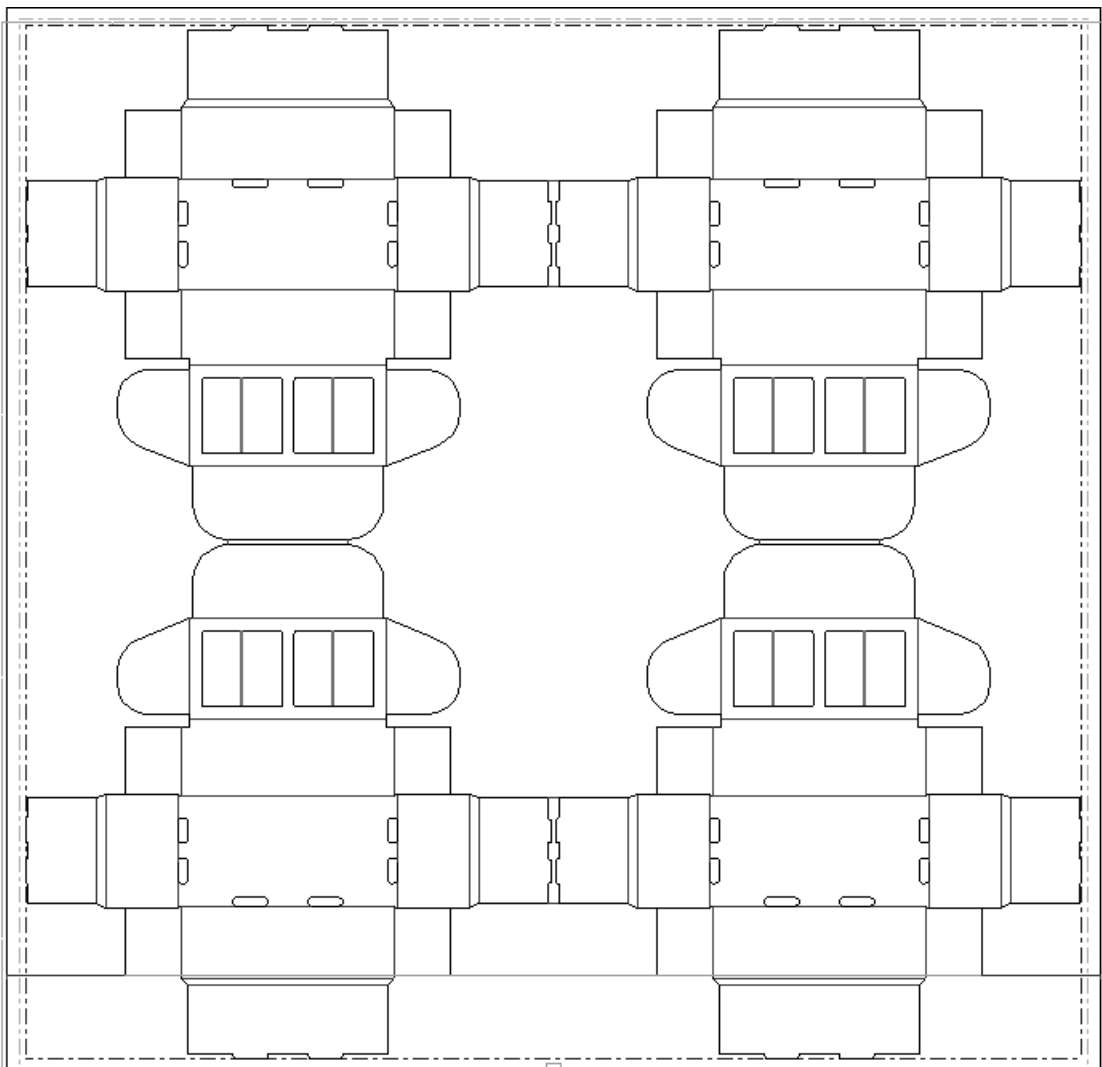

Shown below is the same layout after clicking the tool and then clicking **Recalculate All**.

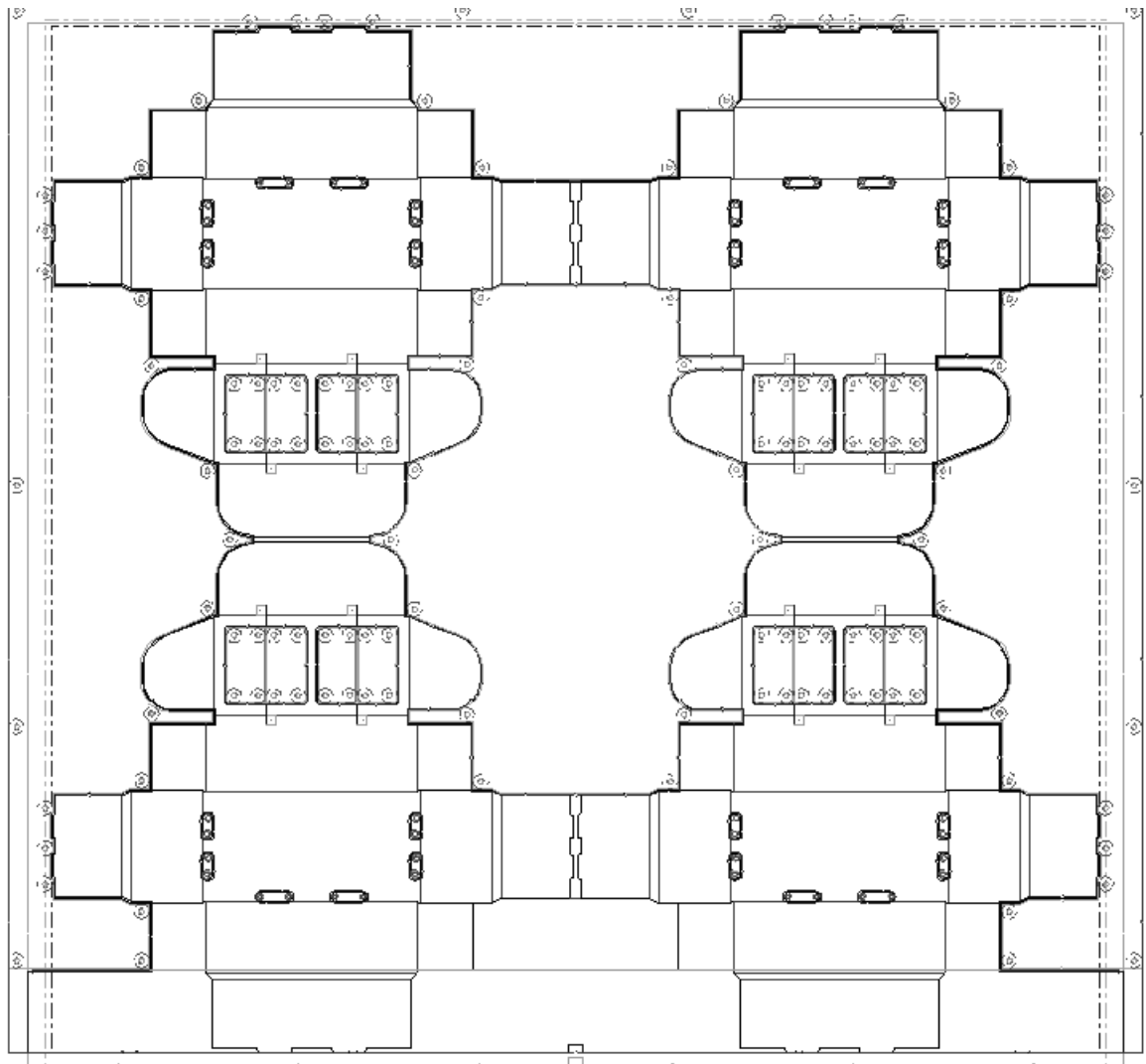

Shown below is a close-up of the lower stripping board.

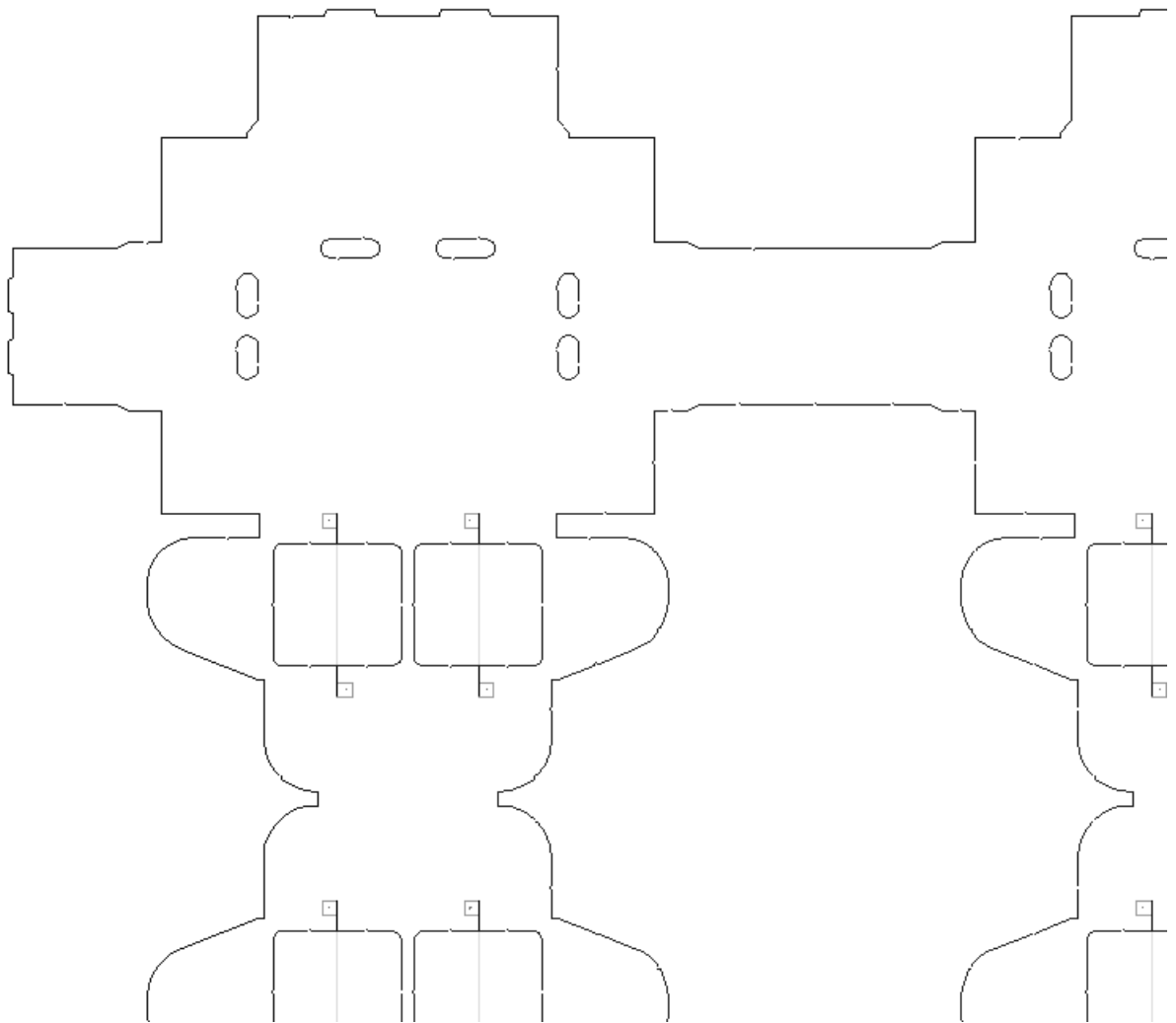

Shown below is a close-up of the upper stripping board.

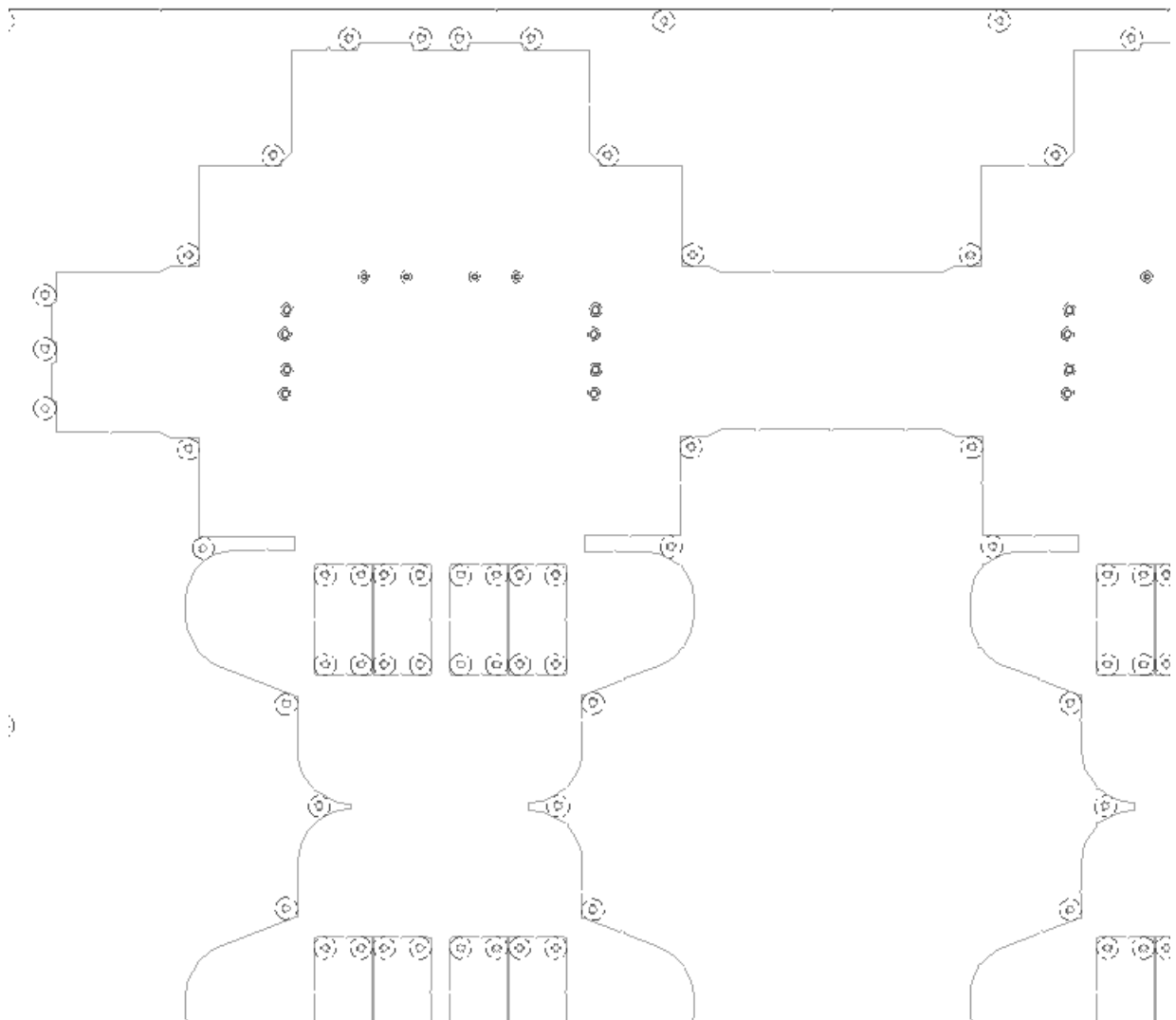

Stripping Inside a Hole

How **Strip Area** strips a hole divided by stripping or carrier rule depends on the following:

- Whether the **Upper** and/or **Lower** checkboxes are checked on the Status bar
- Whether the rule is stripping rule or carrier rule (ArtiosCAD ignores scrap knives)
- Whether the hole is symmetrical or asymmetrical
- Whether Auto-Repeat is turned on.

When you are making a lower hole, ArtiosCAD ignores carrier rules.

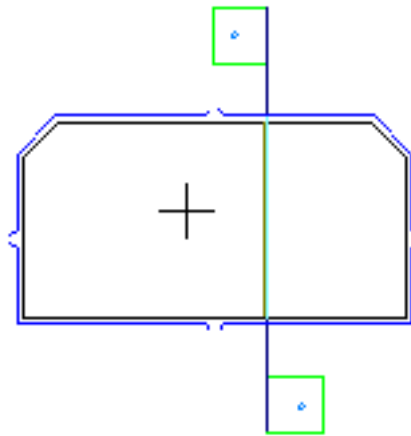

It does follow stripping rules.

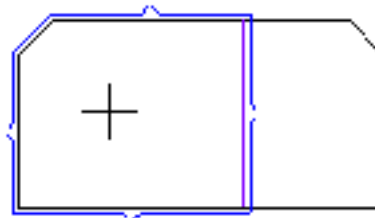

If you click on the other side of the stripping rule, ArtiosCAD merges the holes.

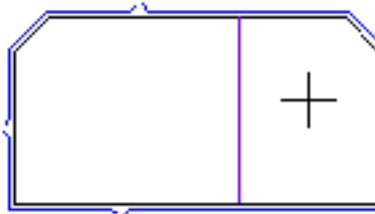

When you click in a symmetrical hole, with Auto-Repeat enabled, ArtiosCAD makes both sides of the hole and merge the holes if they overlap.

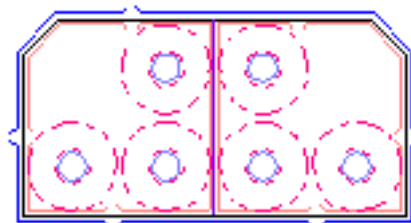

If you click in an asymmetrical hole, with **Lower** off and **Upper** on, ArtiosCAD fills that side of the hole.

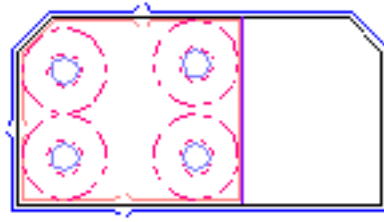

When you click on the other side of the rule (with **Lower** off and **Upper** on) ArtiosCAD fills that side and leaves the other side unchanged. By changing the options in **Options > Stripping Board Parameters > General Preferences > Internal**, you can, for example, use a block on one side and pins on the other.

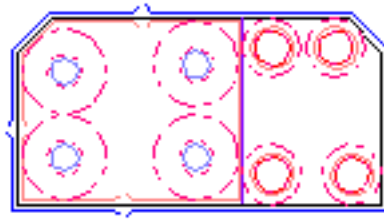

Hole type	Non-symmetric				Symmetric			
	Separated carrier by rule		stripping		carrier		stripping	
Lower checkbox	checked	not checked	checked	not checked	checked	not checked	checked	not checked
Click on side of rule / Upper board result	Both sides filled	Clicked-half filled	Clicked-half filled	Clicked-half filled	Both sides filled	Both sides filled	Both sides filled	Both sides filled

Note:

To add different upper parts to a hole split by multiple carrier rules, strip the hole with **Strip Area**, making sure that **Lower** is checked on the Status bar. Turn **Lower** off after you have stripped the hole. Change the stripping parameters as desired by clicking Properties (...) on the Status bar and clicking **OK** when done. Then click inside the areas of the hole to strip with those parameters. This will add upper parts to this part of the hole and leave the existing parts in other parts of the hole. Normally ArtiosCAD will not put small, thin blocks in thin areas where there is no room for support pins. To include small, thin blocks, change the minimum block area and slot width on the Internal blocks tab of the Stripping Board Parameters dialog box.

How to repeat changes in stripping to other areas



Use the **Repeat Strip Area** tool on the Manufacturing toolbar to repeat manual changes to a stripping area to other congruent stripping areas. A stripping area can be a hole, a block, or the external stripping area. For instance, if you add a rule to a stripping area using the Line tool, that change is not repeated because the Line tool does not use Auto-Repeat. The Repeat Strip Area tool supports Auto-Repeat; if it is on, stripping areas congruent to the destination stripping area are automatically changed as well.

To use the Repeat Strip Area tool, do the following:

1. Change the stripping area as desired.
2. Click **Repeat Strip Area**.
3. On the status bar, choose the boards in which to repeat the stripping area.
4. Click inside the stripping area to repeat (the source stripping area).
5. Click inside the stripping area to be changed (the destination stripping area).
6. Repeat step 5 as desired in other destination stripping areas. The tool remains active until another tool is selected.

Stripping components must have horizontal mirror symmetry in their alignment lines for them to use mirror repeating.

Color-coded stripping areas

If you turn on the **Stripping areas** checkbox in the View Mode dialog box in Manufacturing, different colors are shown to differentiate between the different stripping areas in the layout.

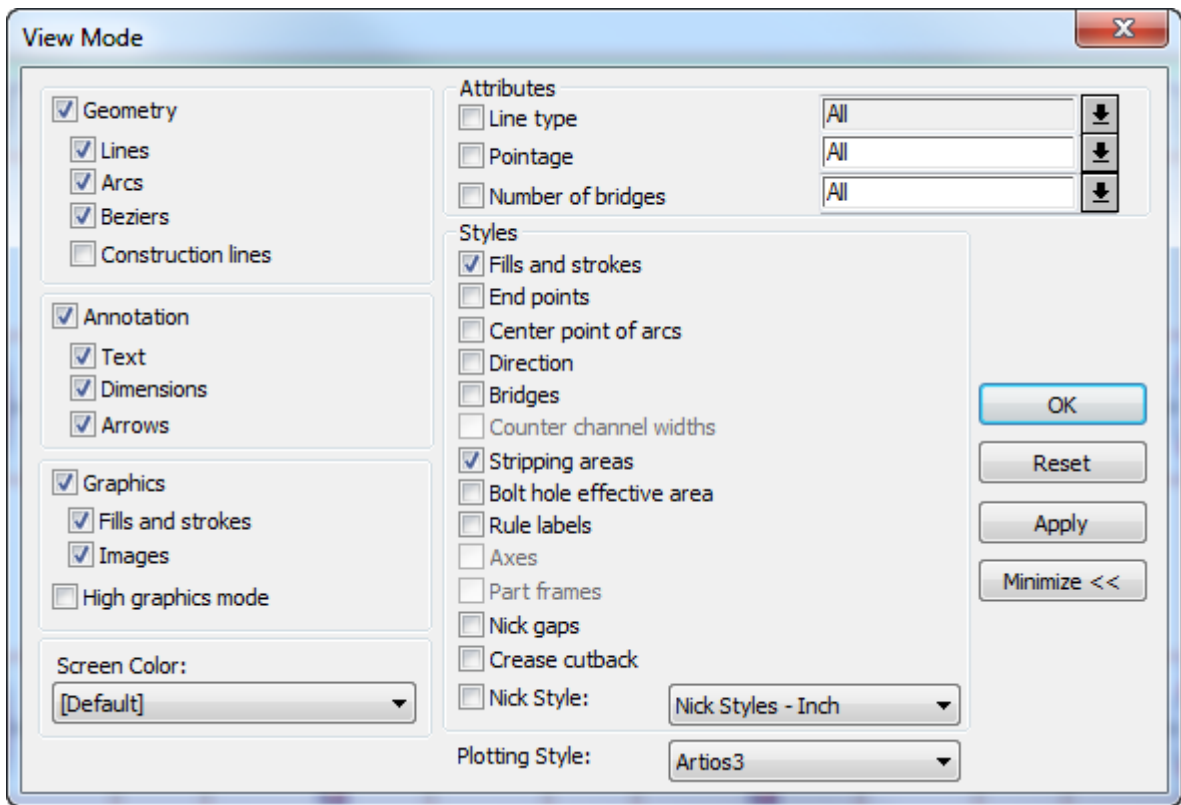

Shown below is a manufacturing file that has color-coded stripping turned on. (It will look much better on your screen as opposed to this grayscale print.)

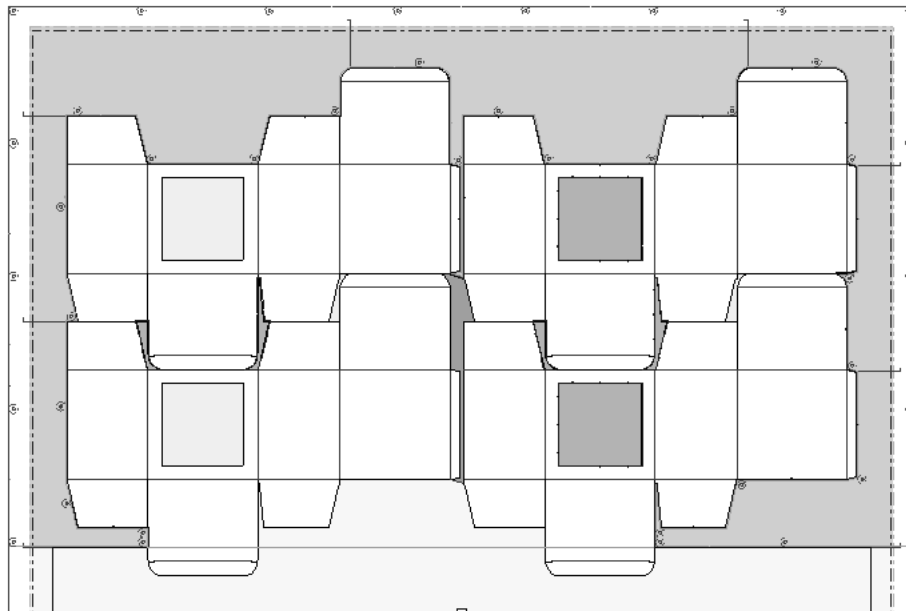

Green indicates a waste area with a lower hole and upper components. **Blue** indicates a waste area with a lower hole only. **Light blue** indicates a waste area with no lower hole. **Yellow**

indicates the waste is removed after the stripping station. **Pink** indicates ArtiosCAD could not find a consistent pattern to the waste and therefore could not decide its type.

Changing stripping boards

Use the tools on the Stripping Board toolbar to modify stripping boards.



You can also use **stripping components** to alter stripping boards.

How to change the edge of the lower stripping board

To change the edge of the stripping board, double-click it with the **Select Element** tool, adjust the fields on the different tabs as desired, and click **OK**.

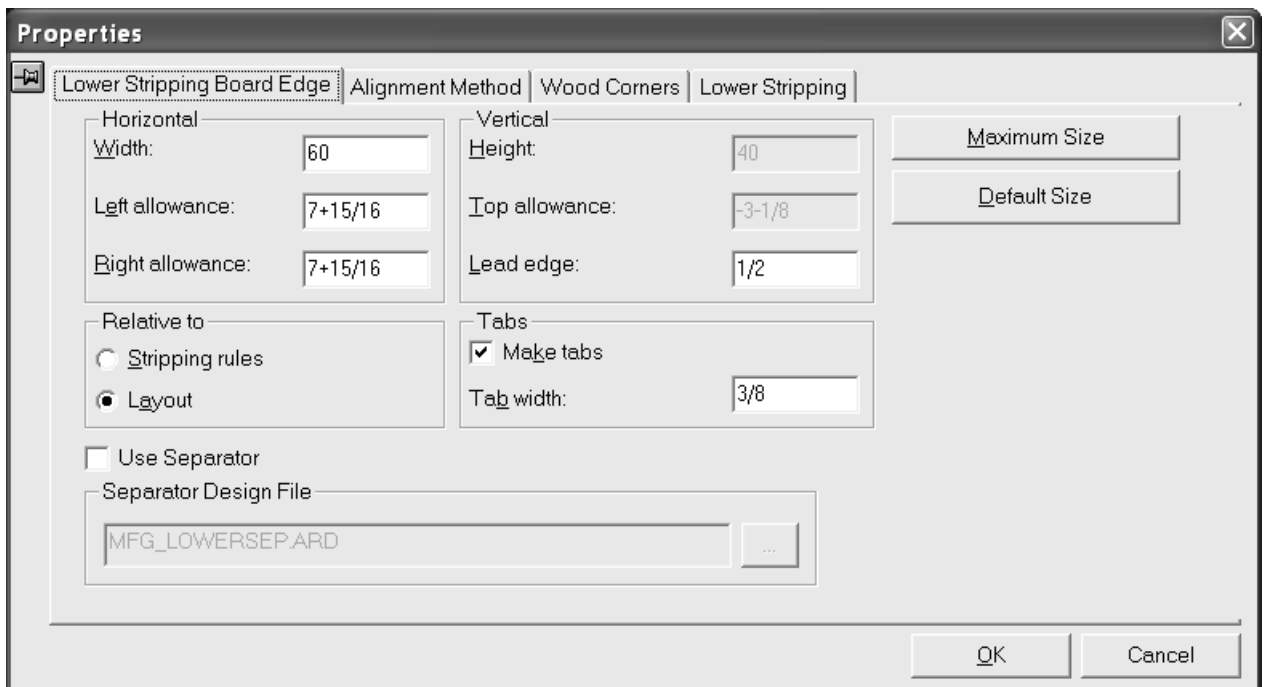

How to add an upper push pin

When you use the **Strip Area** tool to create both the upper and lower stripping boards, ArtiosCAD will automatically add pins, rules, and blocks. However, if you use the **Strip Area** tool to create only the lower board, you can manually add pins, rules, and blocks. The lower stripping board must contain holes before you can add upper push pins.



The **Upper Push Pin** tool adds a pin to the upper stripping board. When you click the tool, a Pin Size drop-down list box and a ... button (More Options) appear on the Status bar.



Clicking **More Options** opens a Stripping Boards Parameters dialog box with just the tabs for internal pins and external pins. These options are based on the settings in Automatic Stripping catalog for the manufacturing parameter set in Defaults. Change them as desired and click **OK**.

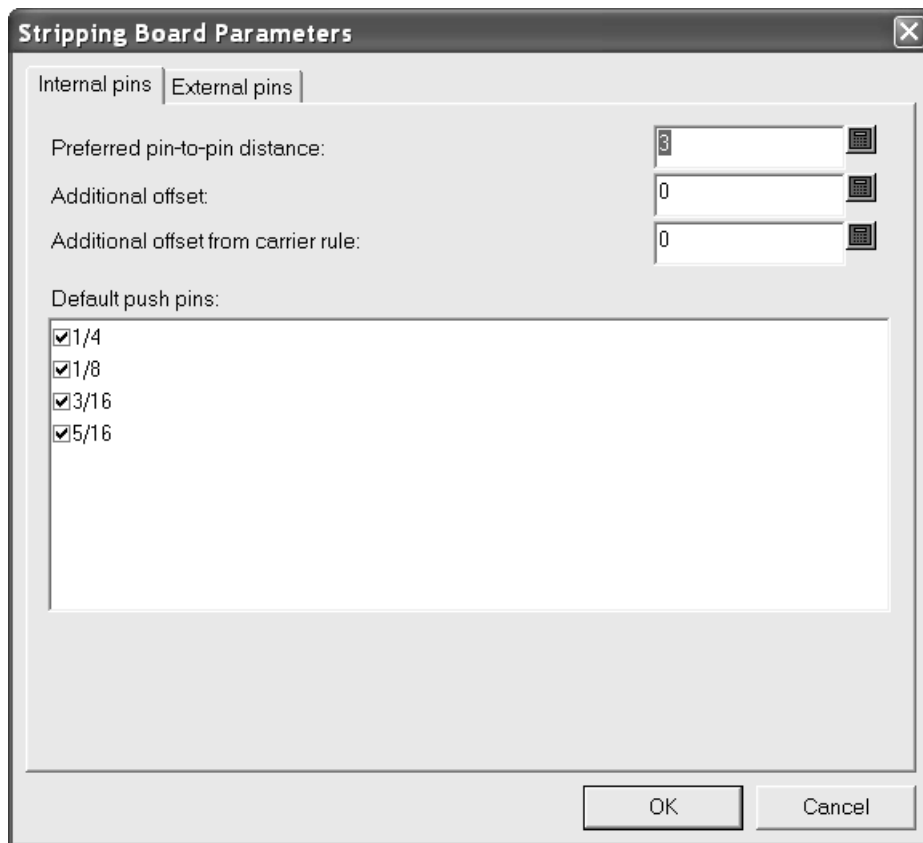

To add an upper push pin, do the following:

1. Make sure there are holes in the lower stripping board. Use the **Strip Area** tool if necessary.
2. Click **Upper Push Pin**.
3. Select the desired pin size from the **Pin size:** drop-down list box on the Status bar.
4. Use the drag to set the location for the pin and click to place the pin. Green drag indicates the pin is snapped to the outline of the hole; blue drag indicates that it is freehand, and red dashed drag represents an unavailable area for placement. If Auto-Repeat is on, the pin will be repeated accordingly. Additional offsets may be applied according to the options set in either Defaults or the Stripping Boards Parameters dialog box.

Shown below is adding a pin at the upper left corner of a hole.

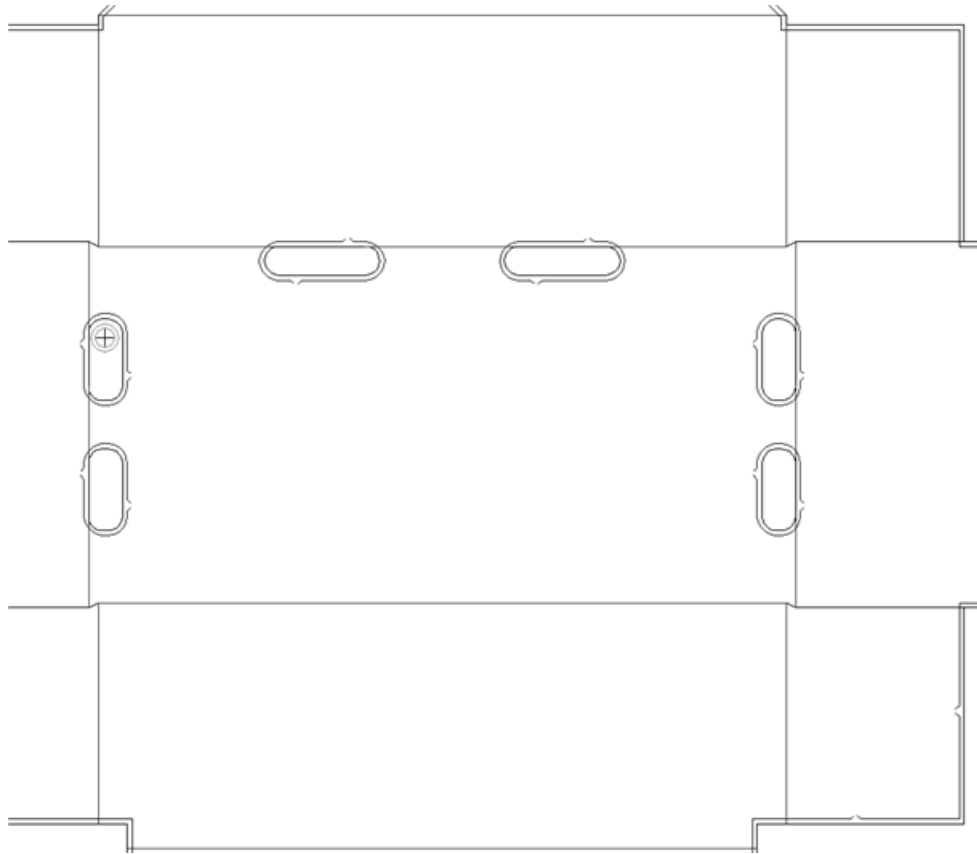

Shown below is the added pin which was Auto-Repeated.

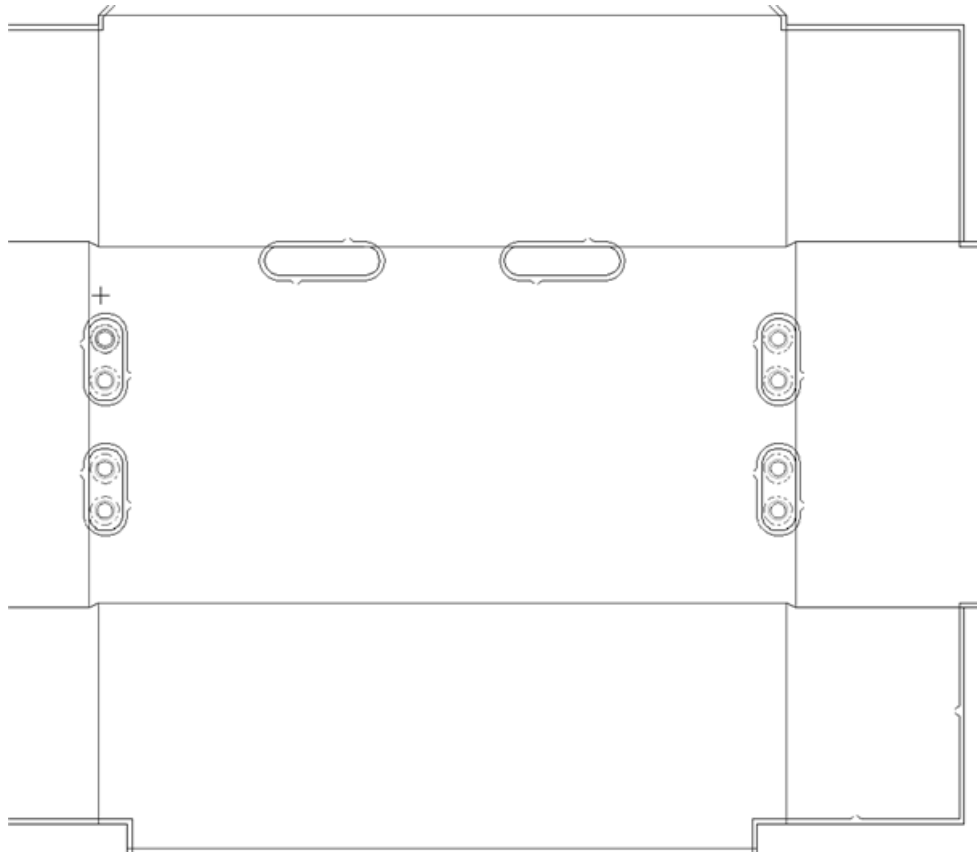

5. Repeat as desired to add more pins.

You can design custom push pins as geometry macros of type **Push pin component**. They must be circular.

How to add an upper rule

 The Upper Rule tool adds a piece of rule to the upper stripping board. As with the Upper Push Pin tool, you must click inside a hole in the lower board to add the rule. When you click the tool, a **Stripping Rules** drop-down list box, four snap positioning option buttons, and a ... button (More Options) appear on the Status bar.



On the **Stripping rules:** drop down list-box are Generic rule, which is just plain straight rule, and three geometry macros that offer special constructions: 20mm wave rule, 8mm Right rule (a stripping component), and Variable rule that has a 90-degree angle at its end. Your system may have different geometry macros available depending on how the system has been customized.

The four snap options on the Status bar after the Stripping rules: drop-down list box are listed below.

 **Dynamic Rule** lets you place rule and use the color of the drag for feedback. The drag for the guide lines changes color based on the intended position of the rule. Green drag indicates

the item is snapped to the edge of a hole; blue drag indicates it is being placed freehand; red drag indicates it cannot be placed at that position.

This option works with all the stripping rule types available in the drop-down list box.

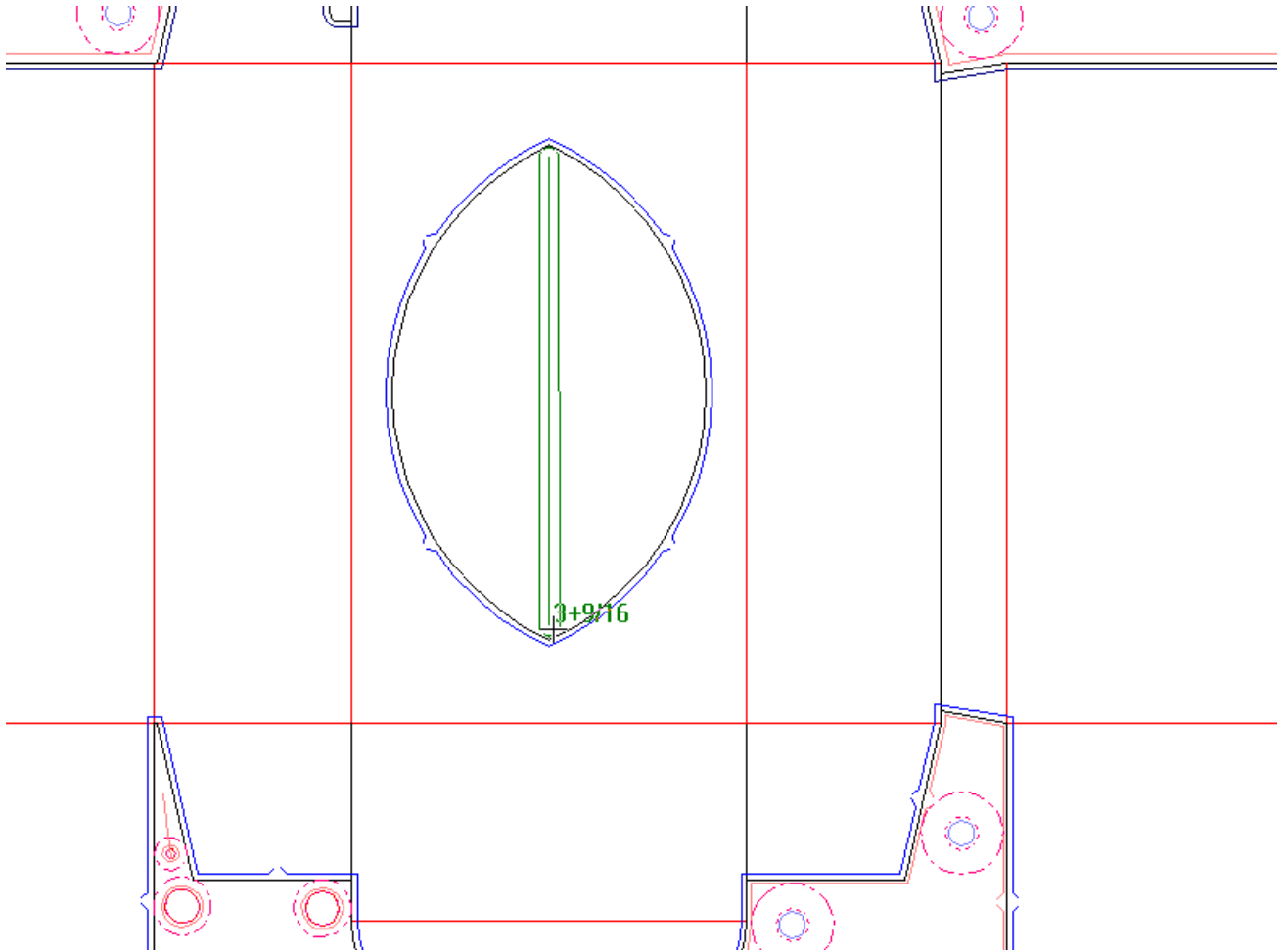

Snap to Middle Rule automatically snaps the rule in the middle of a slot. This option works with all the stripping rule types available in the drop-down list box.

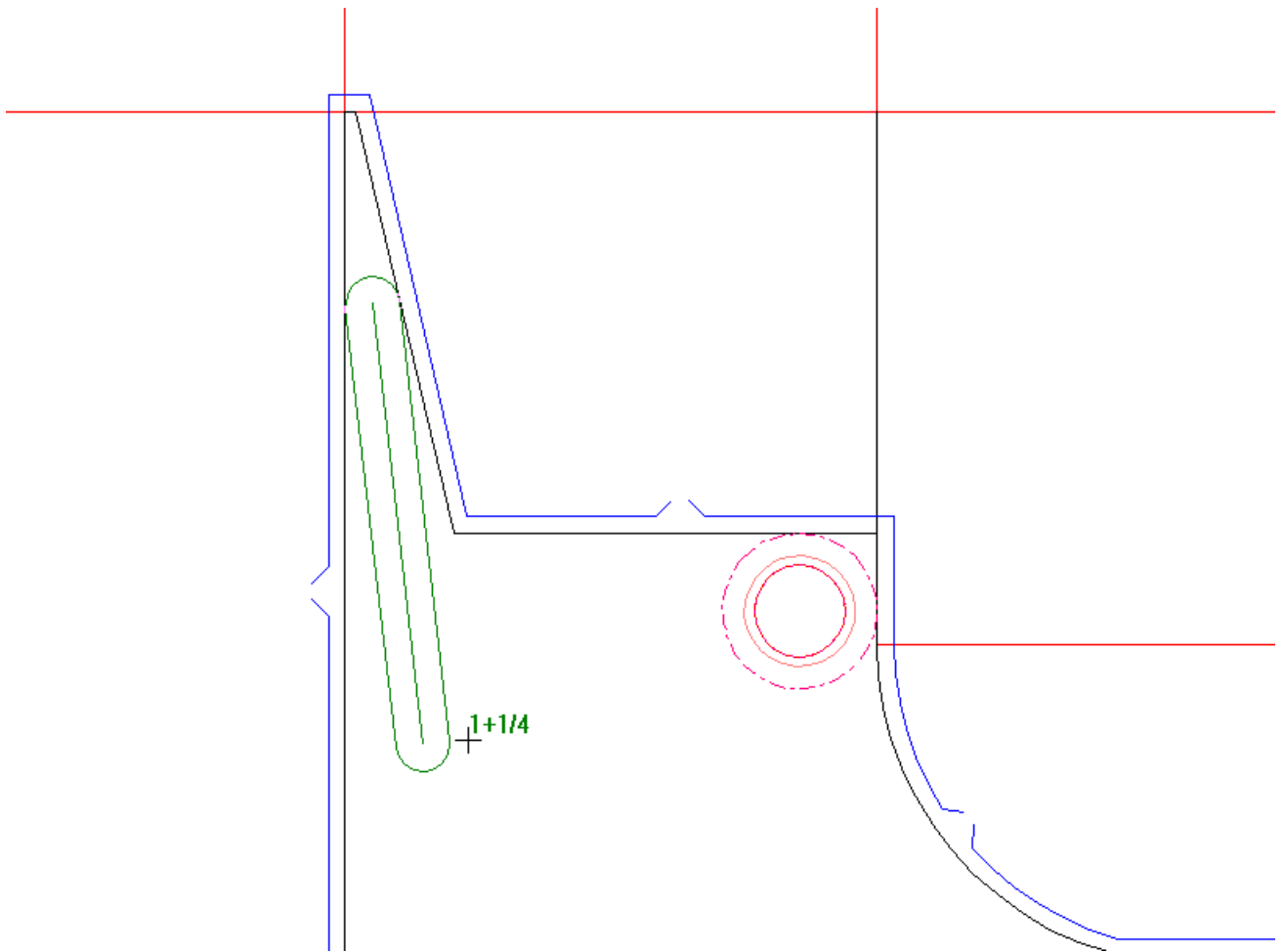

 **Generic Straight Rule** changes the type of rule in the drop-down list box to **Generic rule** and prompts you to indicate the start and end points of a straight piece of rule.

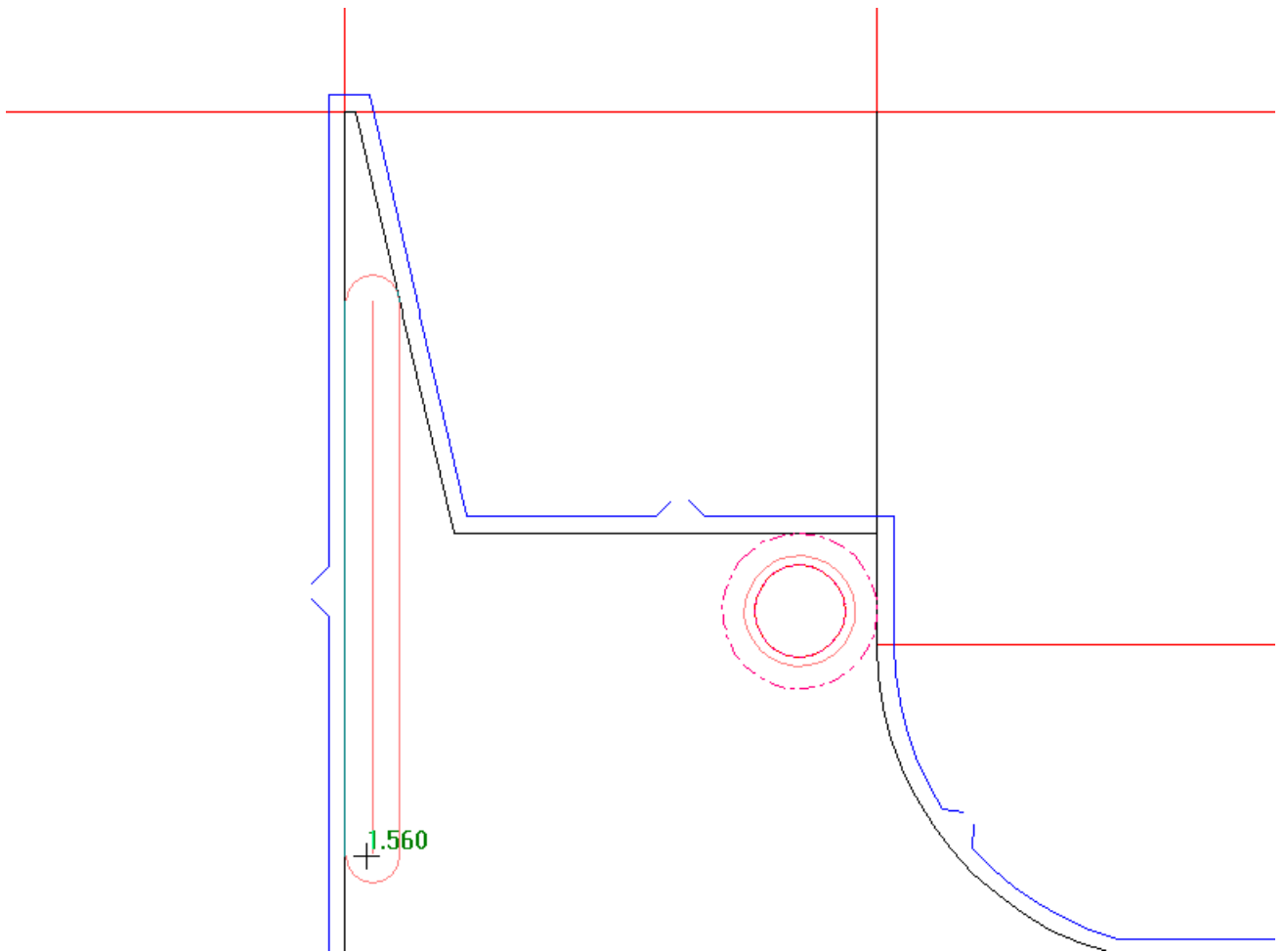

 **Generic Follow Rule** changes the type of rule in the drop-down list box to **Generic rule** and prompts you to indicate the start and end points of a piece of rule that follows the shape of the lower hole.

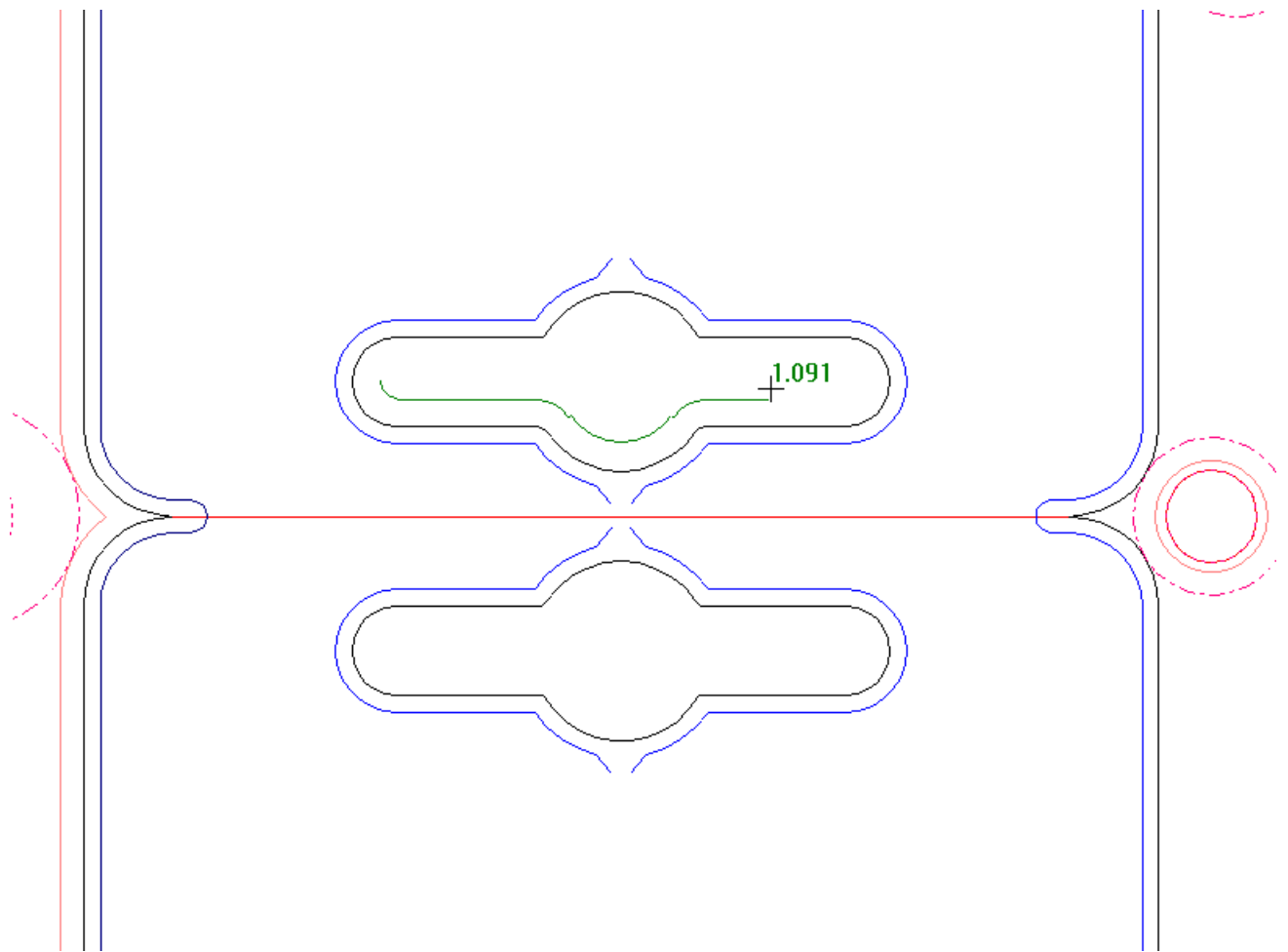

Clicking  **More Options** opens the Stripping Boards Parameters dialog box with the tabs for internal rules, external rules, and interference. These options are based on the settings in the Automatic Stripping catalog for the manufacturing parameter set in Defaults. Change them as desired and click **OK**.

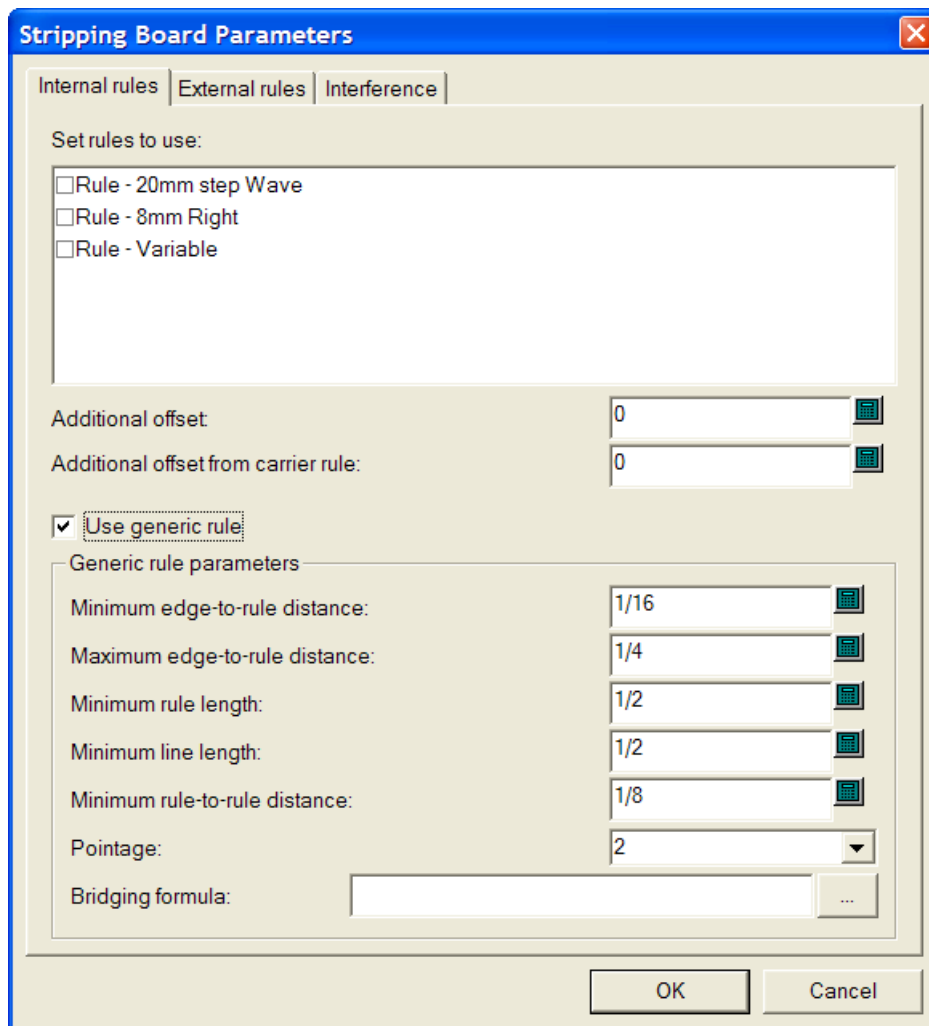

To add a piece of upper rule, do the following:

1. Make sure there are holes in the lower stripping board. Use the Strip Area tool if necessary.
2. Click the **Upper Rule** tool.
3. Select the type of rule to add from the **Stripping Rules:** drop down list-box.
4. Click the appropriate snap placement button. **Dynamic Rule** is selected by default.
5. Place the rule. If the rule selected on the drop-down list box is of variable length, click to set the start point, drag to extend it, and then click to set the end point.

If the rule selected on the drop-down list box is not variable, place it as desired.

Green drag indicates the item is snapped to the edge of a hole; blue drag indicates it is being placed freehand; red drag indicates it cannot be placed at that position.

When **Snap to Middle Rule** is the current placement method and the end point of the rule being added is a piece of existing generic rule, the new rule is intersected with the piece of existing rule.

Shown below is an example of setting the end point for a piece of 20mm step Wave rule with the clearance lines shown around it and **Snap to Middle Rule** selected as the placement method. The start point of the rule is at the right end of the slot and the drag is toward the left.

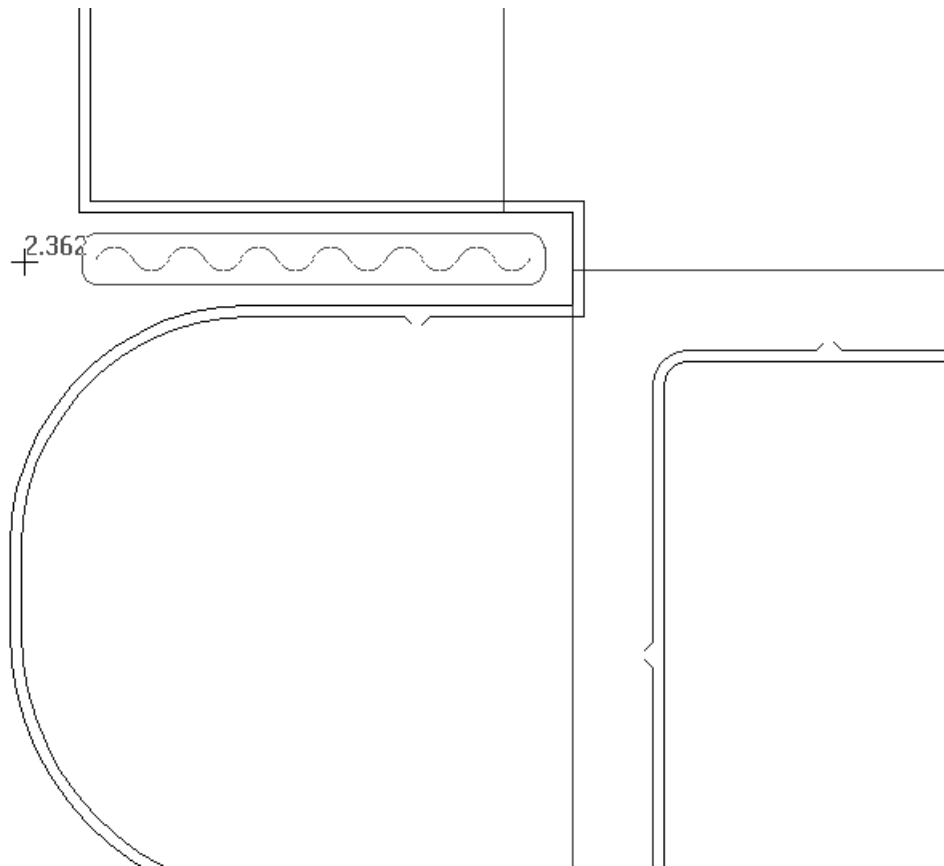

How to add an upper block



The **Upper Block** tool adds a block to the upper stripping board in the hole you indicate. As with the Upper Push Pin tool and the Upper Rule tool, you must click inside a hole in the lower board to add the block. When you click the tool, an **Add Block Pins** checkbox and a ... button (More Options) appear on the Status bar.

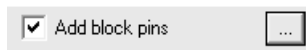

Clicking **More Options** opens a Stripping Boards Parameters dialog box with tabs for internal blocks, external blocks, and block pins. Modify the fields as desired and click **OK**.

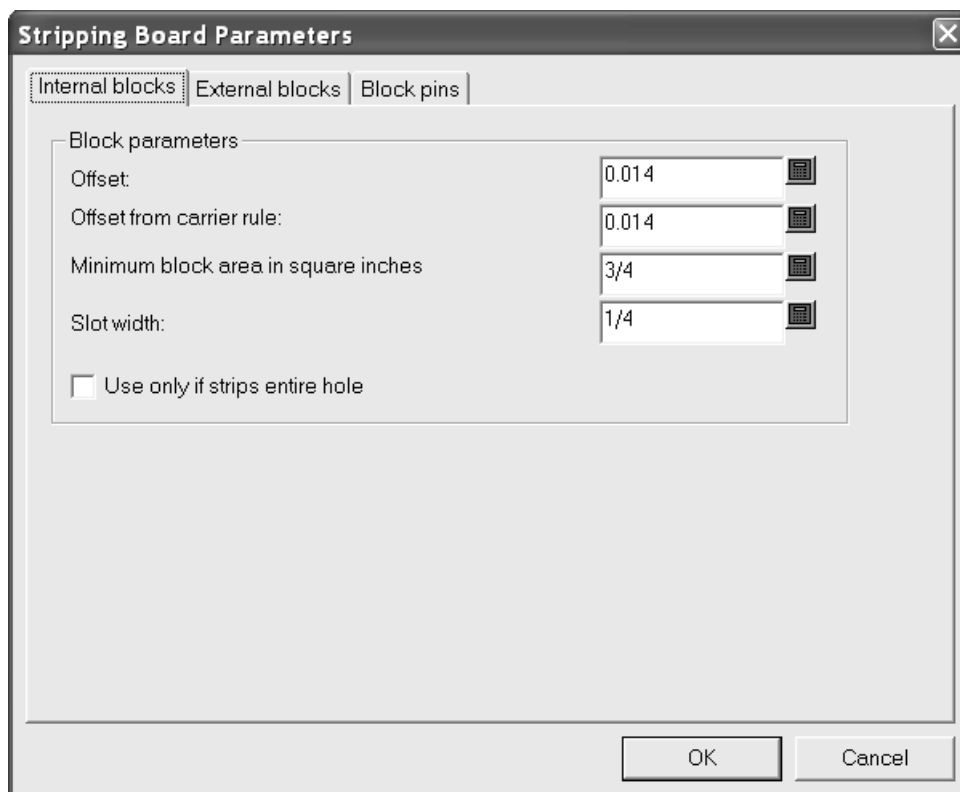

To add an upper block, do the following:

1. Make sure there are holes in the lower stripping board. Use the Strip Area tool if necessary.
2. Click the **Upper Block** tool.
3. Select or deselect the **Add block pins** checkbox on the Status bar as desired.
4. Click inside the hole for the new block. The block is created with or without pins and repeated according to the Auto-Repeat status as shown in the example below.

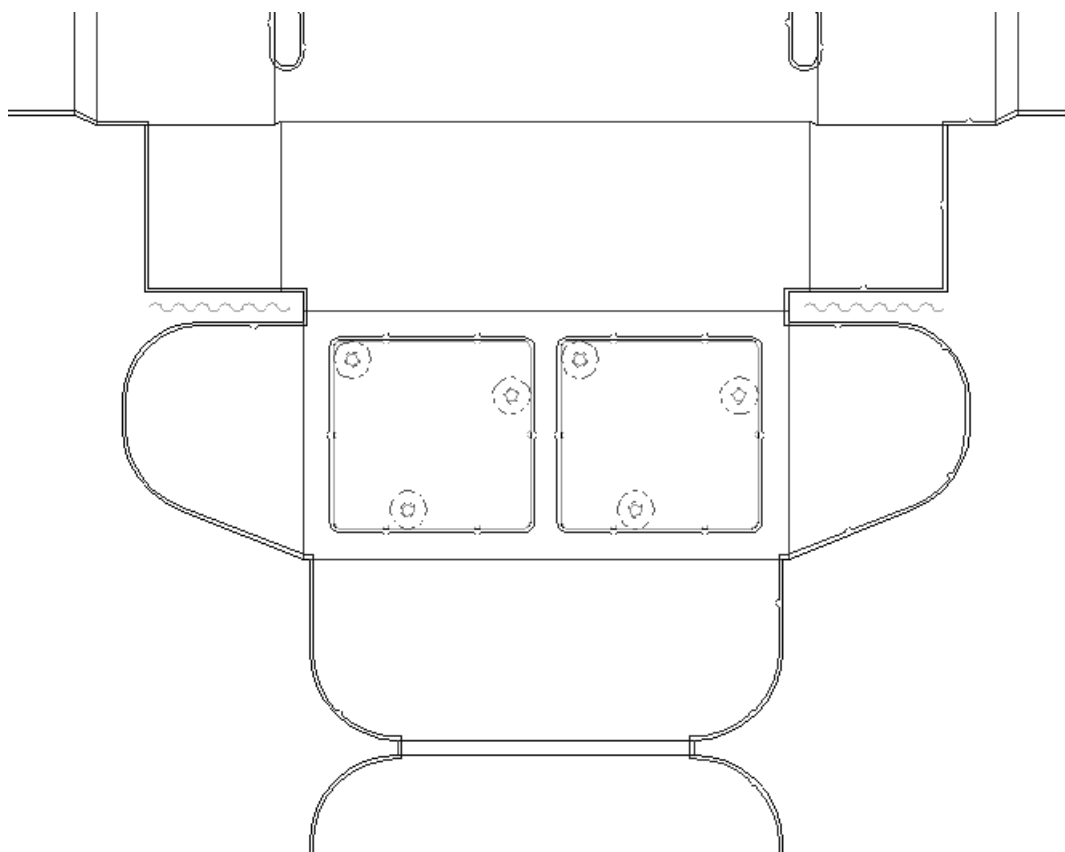

How to add an upper block pin

 The **Upper Block Pin** tool lets you add upper block pins manually. When you click this tool, a **Pin size:** drop-down list box and a ... (More Options) button appear on the Status bar.



Clicking **More Options** opens a Stripping Boards Parameters dialog box with a tab for block pins. Change the distance between pins or the default pin as desired and click **OK**.

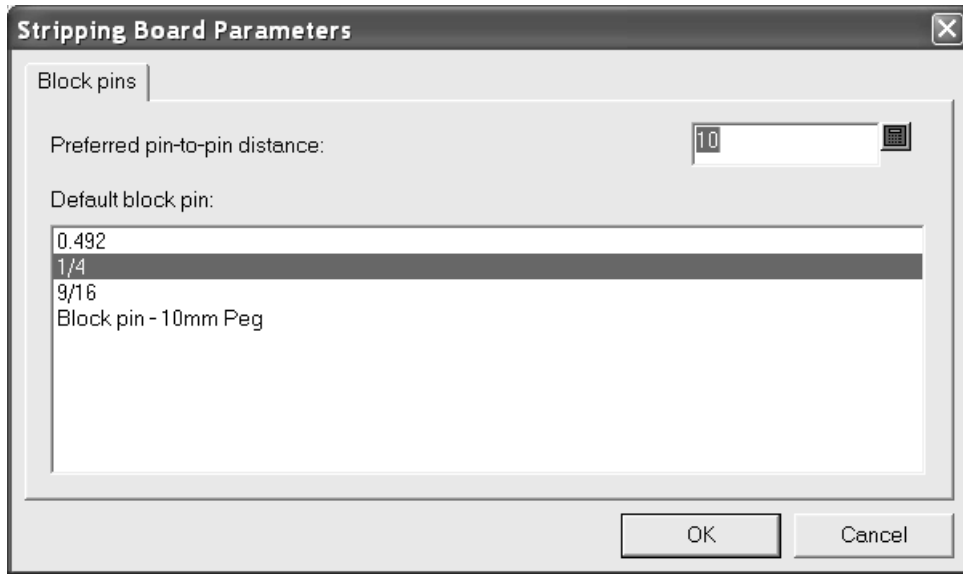

To use this tool, do the following:

1. Make sure you have an upper block created.
2. Click the **Upper Block Pin** tool.
3. Choose the upper block pin to use from the **Pin size:** drop-down list box.
4. Use the drag to place the pin as desired. Green drag indicates the pin is snapped to a hole edge; blue drag indicates it is being placed freehand; red drag indicates the desired position is unavailable. The example shown below uses the 10mm block peg.

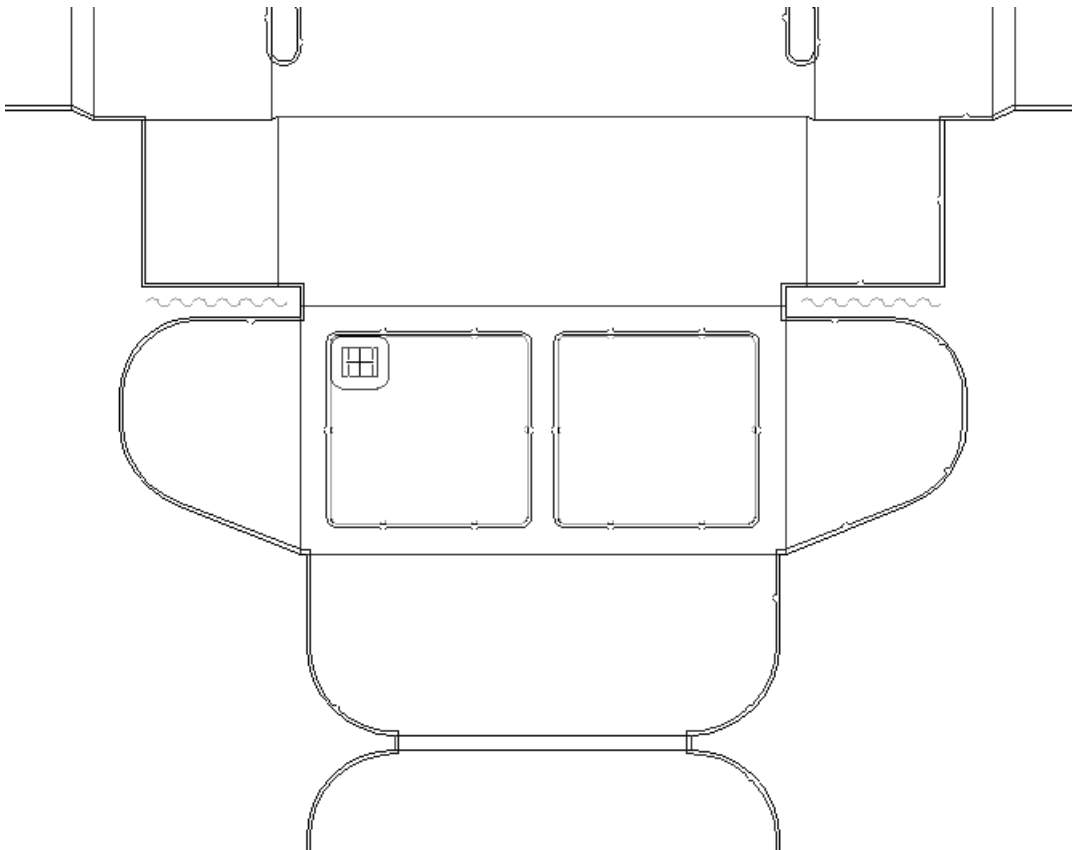

5. The pin is Auto-Repeated according to the current Auto-Repeat setting.

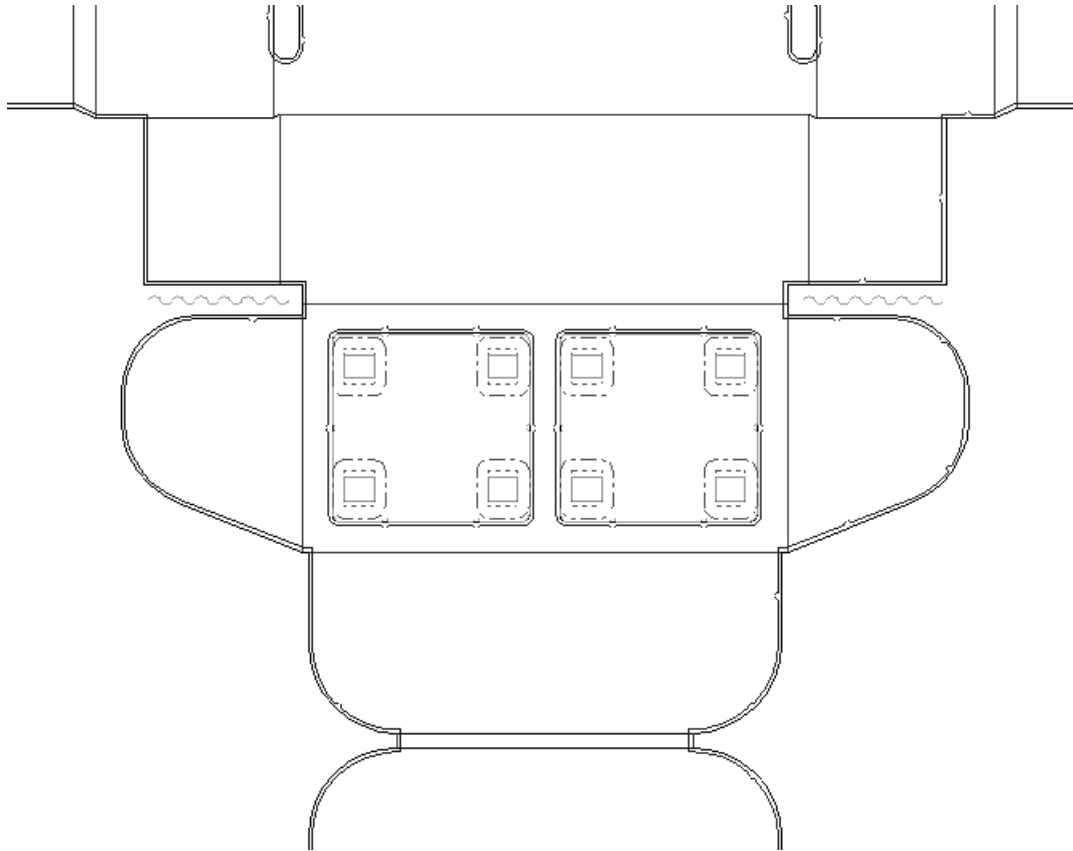

How to add interference

 Sometimes when a piece of waste is small (and therefore light), the partial vacuum in the press can suck the waste back up through the holes in the bottom stripping board. *Interference*, also known as power stripping, is the process of adding a little bump into the edge of a hole using inside modifier lines so that the waste stays where it is supposed to be and doesn't come back into the press. The **Add Interference** tool is one way to add interference. You can optionally add a pin in the top stripping board to force the waste through the now-smaller hole.

Options for this tool appear on the Status bar when the tool is clicked.



Round, **square**, and **chamfer** control the shape of the interference. **Width** sets the size of the interference. **Add pin** controls whether a pin is added to the upper board to force the waste through the modified hole. Interference added without a pin adds modifier lines to the lower board. Interference added with a pin adds the pin and modifier lines to the upper board. **Pin offset** sets the distance to the pin from the edge of the hole, and is available only when **Add pin** is selected. **Pin size** sets the size of the pin and is available only when **Add pin** is selected.

When interference with a pin is added, it goes into the upper board. When the interference is added without a pin it goes into the lower board. When a block is added to a hole with

interference, if the interference is in the lower board the block goes around the interference. If the interference is in the upper board it is deleted.

The **Repeat Strip Area** tool repeats the interference whether it is in the upper or lower board, according to the **Upper** and **Lower** checkboxes. It replaces any existing interference in the repeated holes.

You can specify additional offsets for interference on the Interference tab of the Stripping Board Parameters dialog box.

To use the tool, do the following:

1. Make sure there are holes in the lower board.
2. Click **Add Interference** and set the options on the Status bar as desired.
3. Use the drag to set the position along a lower hole edge for the interference. Green drag indicates the pin is snapped to a hole edge; blue drag indicates it is being placed freehand; red drag indicates the desired position is unavailable.

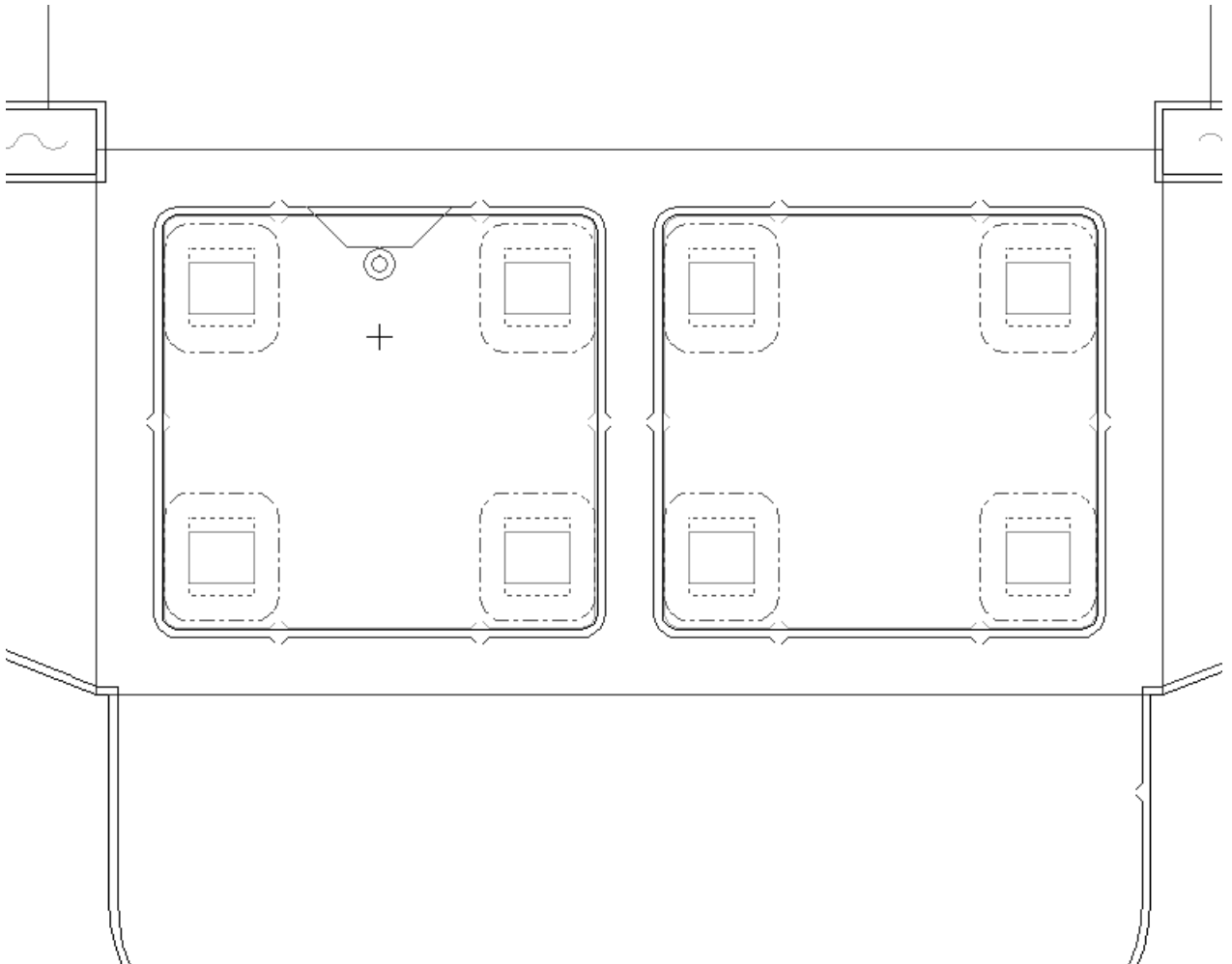

4. Click to place the interference. The interference is Auto-Repeated according to the Auto-Repeat settings.

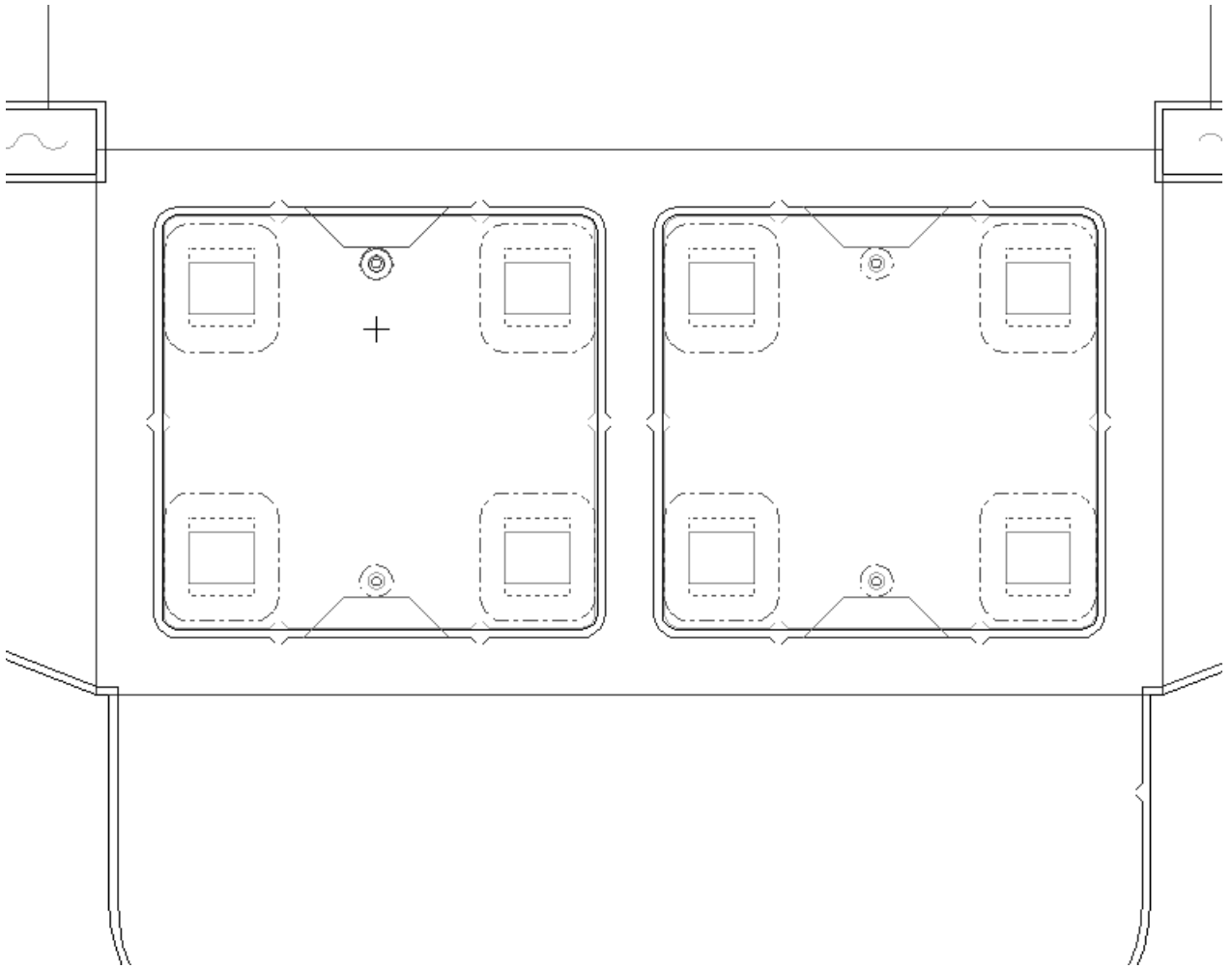

Set defaults for this tool in **Options > Defaults > Shared defaults > Manufacturing parameter sets > parameter set catalog > parameter set name > Upper stripping board > Interference Stripping.**

Another way to add interference is to create manual interference by adding lines of type **Hole inside modifier** that cross the edge of the hole to the **Inside modifier** sublayer of the **Lower stripping board** layer. Any pins, rules, or blocks added will follow the inside modifier lines. Select the inside modifier lines with **Select Element** and repeat them using **Repeat Element**. The shape of the lower hole will be modified on Output.

Manual interference is deleted if you use the **Strip Area** tool with the **Lower** checkbox selected after adding manual interference.

Shown below is an example of manual interference. A hole modifier line was drawn across the corner of a lower hole and was repeated, and then an upper block was added with pins and repeated. The edge of the upper block follows the lower hole inside modifier lines.

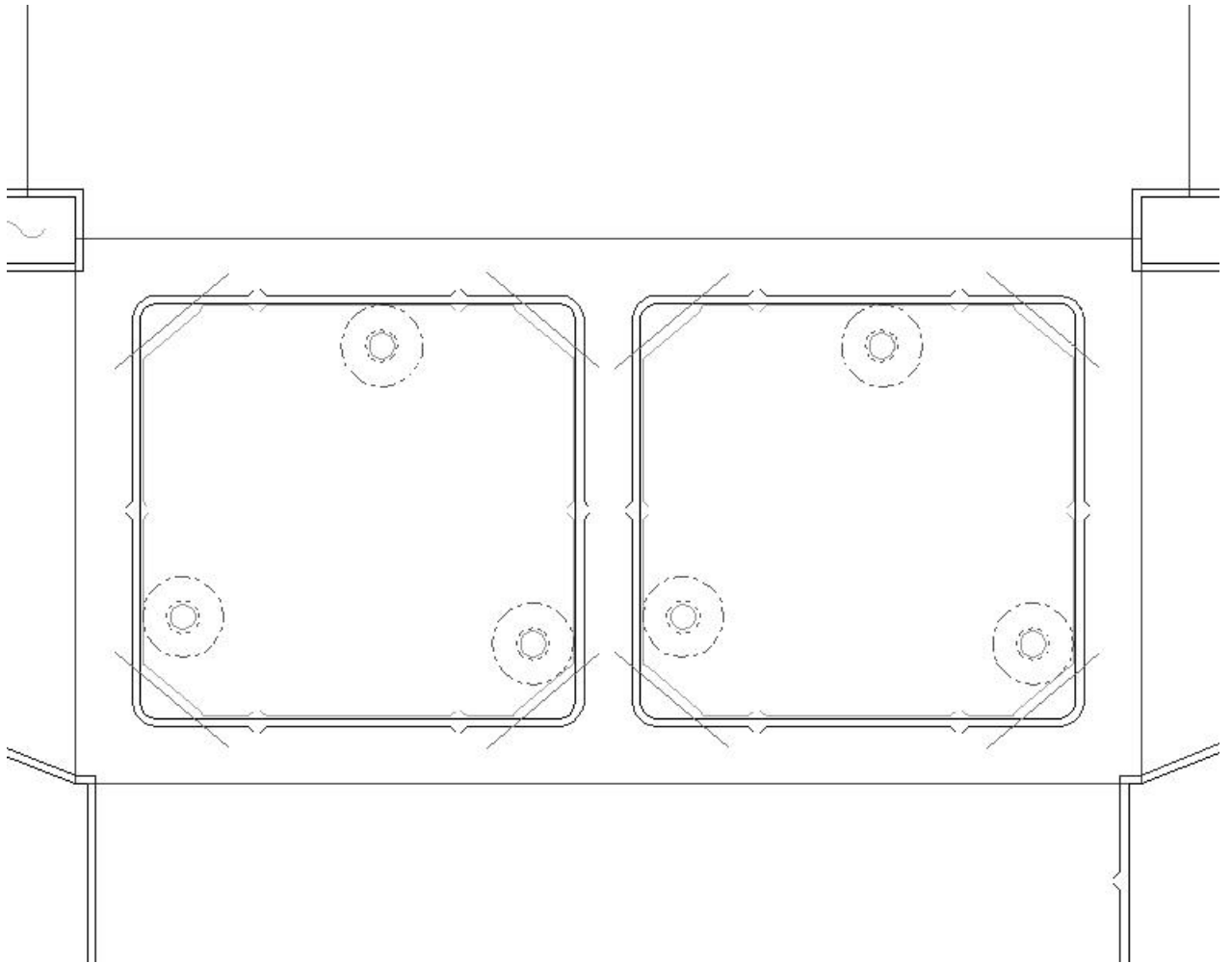

How to remove stripping

Two tools on the Manufacturing toolbar remove stripping.

 **Delete All** removes all stripping from the layout. When clicked, the Delete All dialog box appears. Choose the options as desired and click **OK** to remove the stripping.





Delete Strip Area removes stripping from individual stripping areas. When clicked, **Lower and Upper stripping** and **Upper stripping only** option buttons appear on the Status bar as shown below.



To use this tool, do the following:

1. Click **Delete Strip Area**.
2. Choose the appropriate option button on the Status bar.
3. Click inside the stripping area to delete. Deletions will be Auto-Repeated according to current Auto-Repeat settings.
4. Repeat in additional stripping areas as desired.

How to add an air hole



Modern presses operate so quickly that partial vacuums are sometimes created from the sheets rushing through them. These vacuums can ruin a press run by causing the machine to jam. Air holes made in the upper stripping board are one way to combat this problem.

Three options for the shape of the air hole appear on the Status bar when the tool is active.

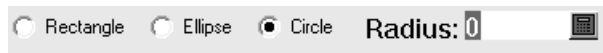

The **Radius** field appears only when the shape is set to **Circle**.

To use this tool, do the following:

1. Click **Make Air Hole**.
2. On the Status bar, choose the shape of air hole to create.
3. Click at the start point of the air hole and use the drag to set the end point.
4. The air hole is created and Auto-Repeated according to the current Auto-Repeat settings.

Shown below are examples of air holes.

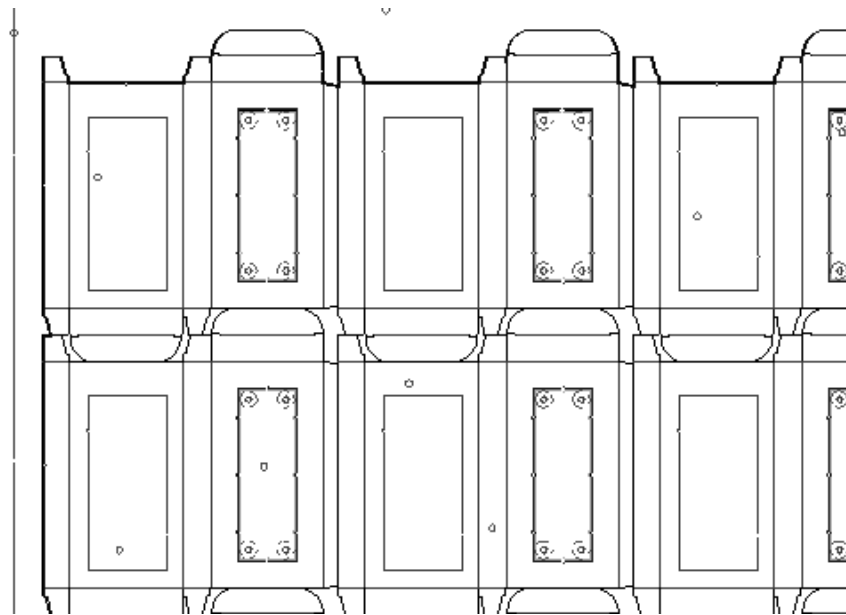

How to make an alignment hole



Alignment holes are used to quickly and easily align a set of manufacturing tools without resorting to measuring tapes. To make an alignment hole, click the **Make Alignment Hole** tool and click the location for the alignment hole.

How to add a support bar



The **Add Support Holes** tool adds support bar holes to the lower stripping board. The support bar holes always go into the lower stripper.

To use this tool, click it. Construction lines will appear in the recommended locations for the support bar. Use the drag to set the location of the support bar. Once the location is set, use the mouse to select the holes to be made for the support bar. When you have finished selecting holes, click **OK** on the status bar. Shown below is the tool drag prompting you to set the location.

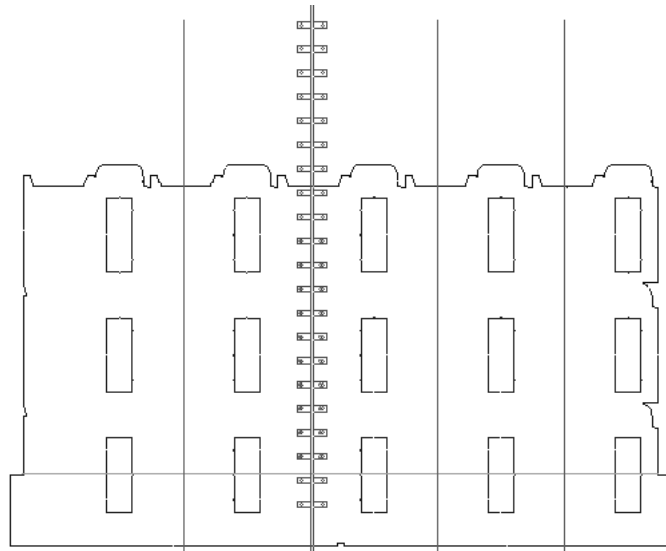

Shown below are the completed holes for the support bar.

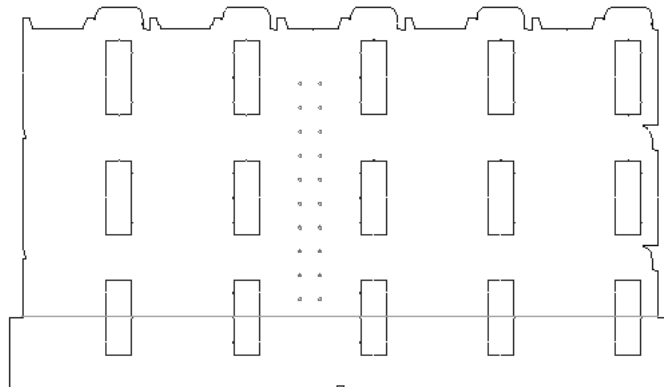

How to add registration holes



To add registration holes across the lower edge of the board, click the **Add Registration Holes** tool. Holes will appear across the bottom of the board, and two options in the Status bar allow you to select from all holes or from only good holes.

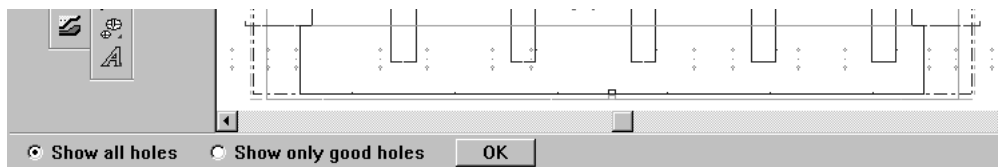

Select the holes to add and click **OK**. The holes will be added.

Shown below are the registration holes.

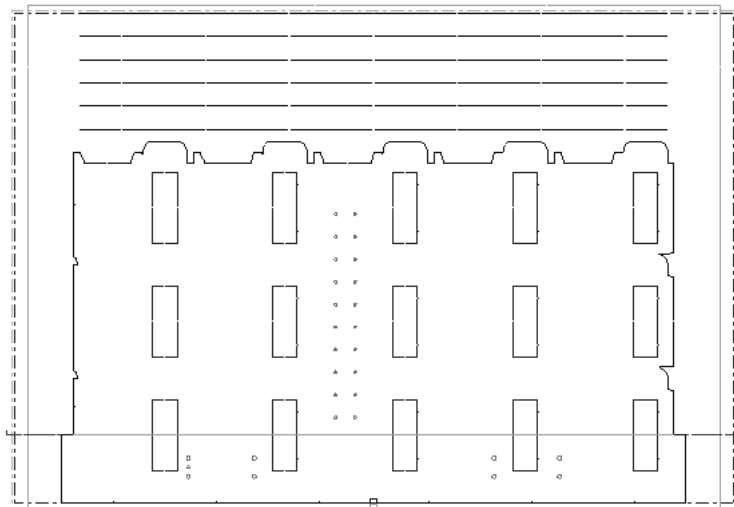

How to add a Front Waste Separator

A **Front Waste Separator** strips the waste from the lead edge of the layout. The separator is made of top and bottom stripping boards which follow the edges of the designs and any stripping rules.

The vertical edges of the Front Waste Separator are found by using the following points: the points at which the layout designs meet the usable edge of the sheet; where they meet the bottom-most stripping rules which intersect the vertical usable-sheet edge; or an existing bottom stripping board mounting bar. If none of these points are found, the separator edge just extends horizontally to the sheet edge.

The Front Waste Separator is placed into the Front Waste Separator layer when it is created.

Shown below is the edge when none of the points are found.

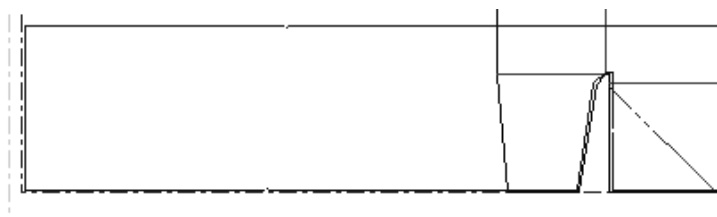

When there is a stripping rule:

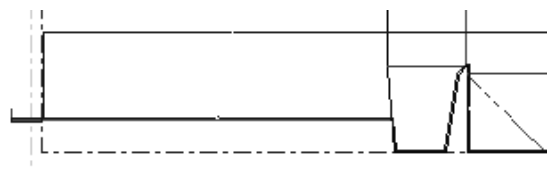

Notice how the stripping edge goes up along the edge of the tab and then runs along the stripping rule to the edge of the sheet.

When there's a bottom mounting bar:

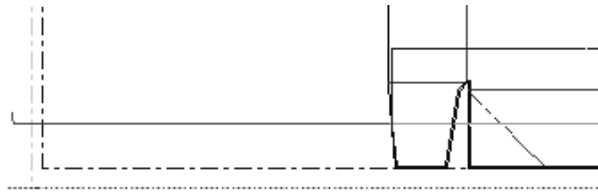

To use this tool, do the following:

1. Create a layout.
2.  Click the **Create Separator** button on the Stripping Board toolbar.
3. The Status bar will change:



4. Set the options on the Status bar.

The **Use Mounting Bar** checkbox controls if the Front Waste Separator is positioned based on the mounting bar. If there is no mounting bar, the separator is based on the lead edge.

Upper only creates the Front Waste Separator out of the upper stripping board. **Upper and Lower** creates the separator using both upper and lower stripping boards.

Offset controls the gap between the lead edge and the edge of the Front Waste Separator.

5. Click **Recalculate All**. The Front Waste Separator is created.

Make sure to click **Recalculate All** after each change you make to the options on the Status bar while the tool is active. Deactivate the tool by clicking another tool.

How to modify a Front Waste Separator

To modify a Front Waste Separator, activate the tool and choose different options on the Status bar, and then click **Recalculate All**.

You can also modify its properties by doing the following:

1.  Click the **Select Element** tool.
2. Choose the element to modify from the drop-down list box on the View bar.

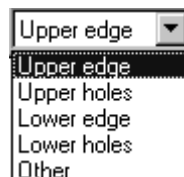

3. Double-click the element to modify, or select it and press ALT-Enter. The Properties dialog box for that element will appear.

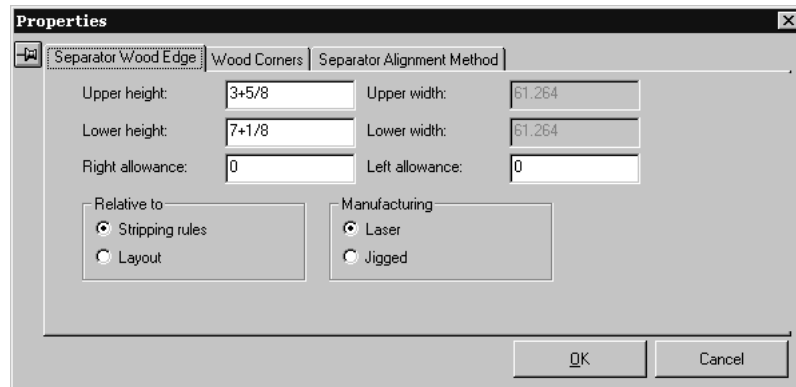

4. Set the options on the tabs as desired and click **OK** to make the changes or **Cancel** to ignore them.

Front Waste Separator defaults are stored in the Front Waste Separator section of the **Die press parameter sets** folder in Defaults.

The workspace containing the mounting hole pattern is ...InstLib\FWS_BOLT-HOLES.ARD. The name of this workspace is set in the **Hole Patterns** page of the **Press Defaults** in the **Die press parameter sets** folder in Defaults. On that page you can also set the side of the die the patterns are placed on to die knife side, die back side, or undefined.

Using stripping components

Stripping components are geometry macros which create space for a claw in the upper stripping board and a clip in the lower stripping board. During stripping, the board material is pressed by the claw against the clip, which flexes and traps the waste, thereby eliminating the need for lower stripping board pins.

Several predefined stripping component geometry macros come with ArtiosCAD, but you can make your own in Designer.

Shown below is a sample stripping clip.

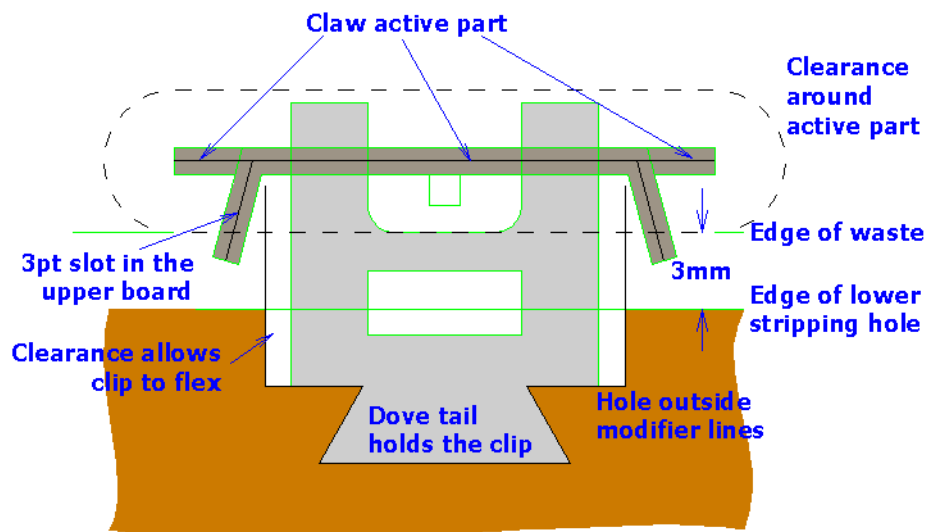

The predefined stripping components are on two customized toolbars as shown below. Use the Customized Toolbars Master Control to turn them on and off.



Adding a stripping component

Perform any stripping using the **Strip Area** tool before adding stripping components. Using the **Strip Area** tool will overwrite stripping components.

To add a predefined stripping component, do the following.

1. Make sure the customized toolbars are turned on and click the button for the component to add. The upper and lower boards will be turned on if they were not on already.
2. Drag for the component will appear under the cursor. Position it as desired, keeping the following placement options in mind when dragging:
 - **Close to the edge of a hole.** The stripping component is aligned with the edge of the waste (the cut lines) in the stripping hole or the lower board edge so that the alignment lines touch the inside of the hole. If the clearance lines do not fit inside the hole, the drag turns red.

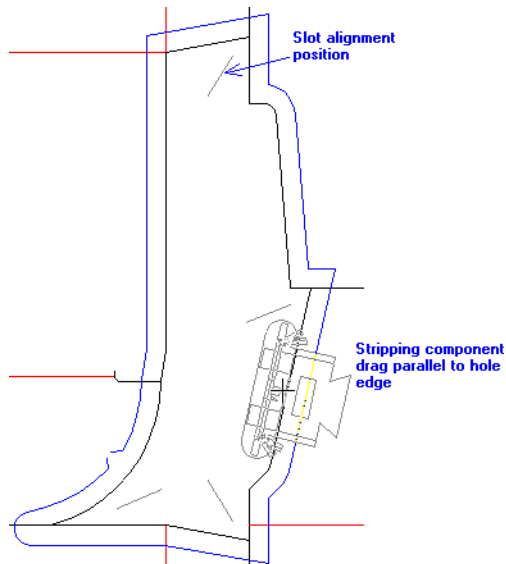

- **Close to a carrier rule.** This is the same as being close to the edge of a hole but a different offset is used - that of the distance between the regular alignment line and the carrier alignment line.

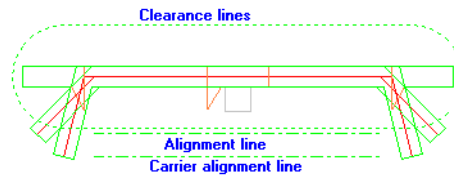

The stripping component is aligned with the carrier rule so that the carrier alignment lines touch the carrier rule. If there are no carrier alignment lines, the alignment lines are used instead. If the clearance lines do not fit, the drag turns red.

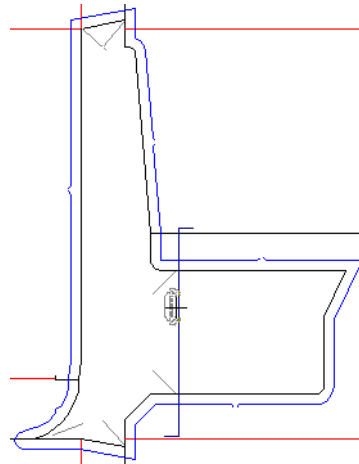

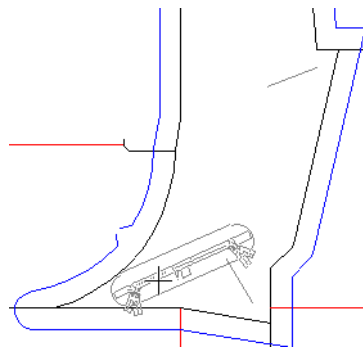

- **Close to a slot.** Select a slot by moving the mouse within snap tolerance of the slot alignment line. The stripping component is aligned so one end of the clearance outline touches the end of the slot depending on the side of the line closest to the mouse cursor.

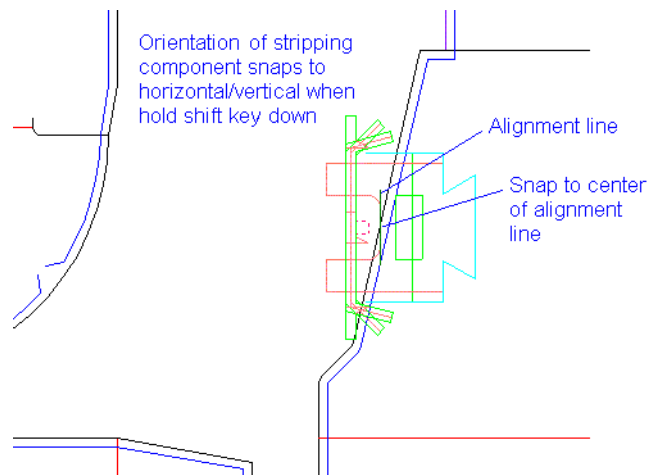

- **Not in a hole.** If the mouse is not in a stripping hole, or if the cut lines in the stripping hole or board edge do not form a loop, the Status bar prompt changes from **Place stripping component** to **Could not find the stripping hole** and the drag turns to dotted red. If you click outside a hole, the component will be placed wherever you click.
- **Holding down SHIFT.** When SHIFT is held down, the stripping component snaps to horizontal or vertical (whichever is closer, based on rotating around the center of the alignment line).



Modifying stripping components

To modify a stripping component, first select it with the  **Select** or  **Select Element** tool. Next, right click it to access its context menu.



Note: If you select more than one component by holding down SHIFT as you select, only **Delete**, **Replace**, **Replace All**, and **Properties** are available.

Note: If Auto-Repeat is active, changes made to one stripping component are repeated for similar components.

Note: Selecting multiple stripping components in the same hole with the **Select Element** tool will group them together. If you plan to change the positions of multiple components in the same hole, use only the **Select** tool to select them.

Select subgroup lets you select a subgroup of the component such as a clip or claw.

Move parallel moves the selected component parallel to the edge of the hole. However, you cannot move a component from one hole to another. To do this, delete the original component and add a new one.

Copy parallel does the same thing as Move parallel except it copies instead of moving.

Move perpendicular moves the selected component perpendicular to the edge of the hole. If the perpendicular offset from the edge of the hole has been changed, it will be maintained. If the component is rotated or aligned on a slot, the perpendicular offset is reset to zero.

Move freehand moves the selected component anywhere within the same hole.

Rotate 180 rotates the selected component 180 degrees about the center of the clearance lines.

Rotate prompts for an anchor point and rotates the selected component about the anchor point.

Delete deletes the selected component(s).

Replace lets you replace the selected stripping component with a new stripping component chosen from the Stripping Components catalog. The new stripping component is repeated according to the current Auto-Repeat setting. Shown below is the Stripping Components catalog.

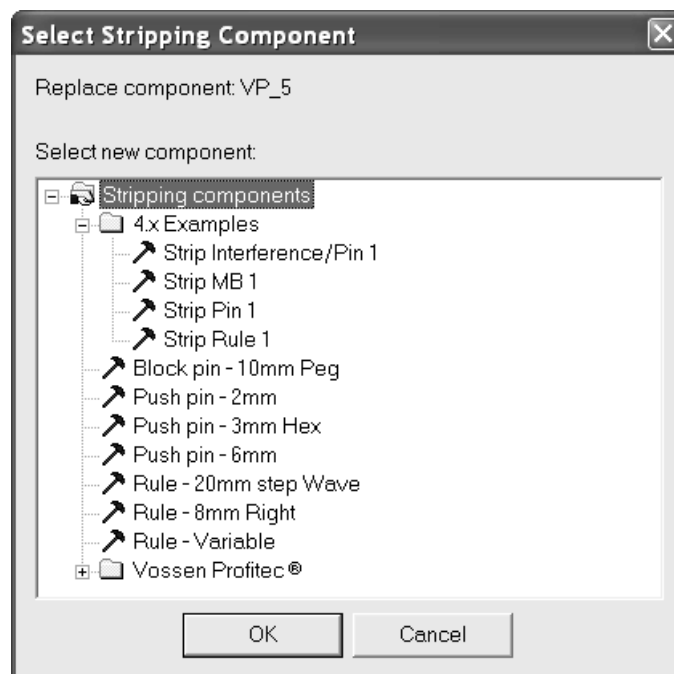

Select the new stripping component and click **OK** to use it as the replacement.

Replace All replaces all instances of the selected stripping component with a new stripping component.

Properties shows the workspace name and any subgroups for the component.

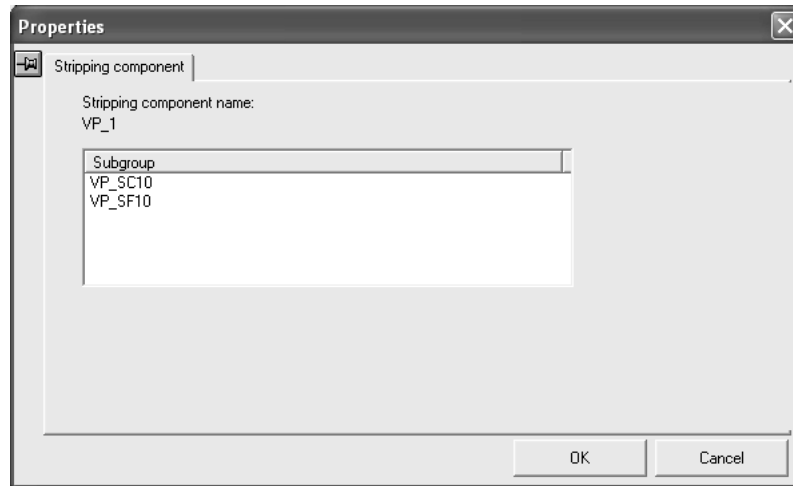

Outputting boards containing stripping components

In a stripping component, the hole outside modifier lines change the shape of the hole in the lower board when performing an Output.

The upper stripping rule and pusher base lines are burned in a CAM output that selects the **Upper stripping board**. The hole inside modifier and hole outside modifier lines are applied to the outline of the lower stripping board in a CAM output that selects **Lower stripping board with upper blocks**. CAM outputs ignore the other lines types such as **Pusher active part**, **Pusher clearance**, and **Stripping component alignment**.

Any tack bridges under a stripping component get moved on Output.

Show below is a portion of a layout containing several stripping components.

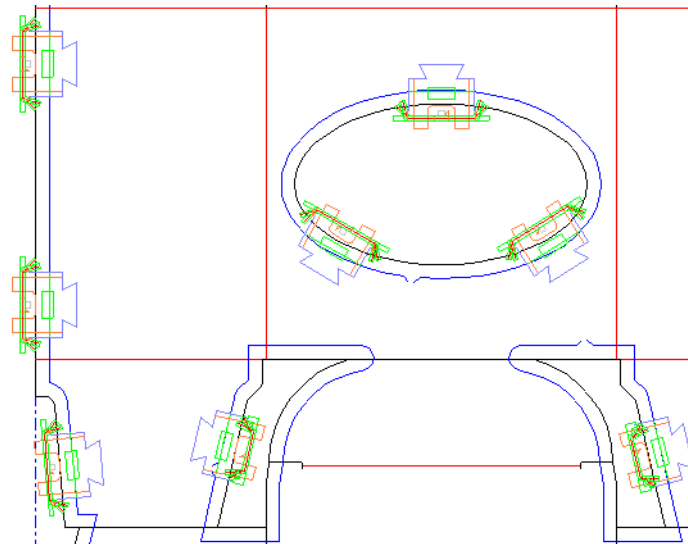

During an Output of the lower board, only the hole modifier lines are considered. Shown below is the lower stripping board for the same section of the layout as shown above.

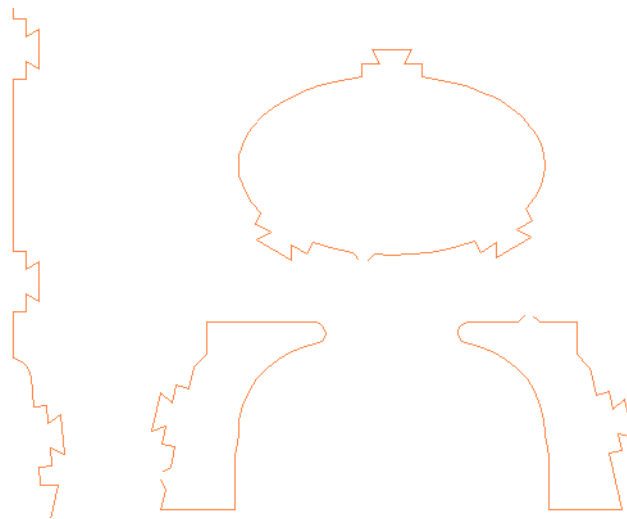

Shown below is the upper stripping board for the same section of the layout showing the stripping rule lines.

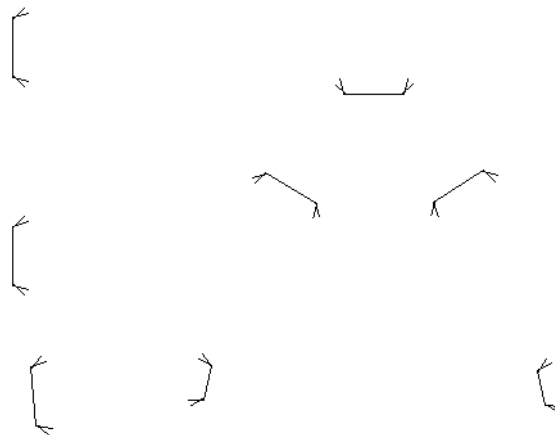

Creating your own stripping components

Use Designer to create your own stripping components. Save them as normal workspaces and copy them to **ServerLib**. Then add them to the Stripping Components Catalog in the Geometry Macro Catalog in Defaults, making sure to use the **Stripping hole component** placement type. Save the Defaults. If desired, create icons for them and put them on a customized toolbar.

Refer to the following table of line types when designing a stripping component. The line types are split between the Lower Board and Upper Board line type catalogs.

Table: Line types for stripping components

Line type name	Line type number	Category	Description
Annotation	0	Annotation	A line type used for drawing the component that does not burn.

Line type name	Line type number	Category	Description
Pusher active part	188	Annotation	A drawing of the active part, such as the clip or the claw. Does not burn.
Upper stripping rule	186	Rule	The base of a stripping rule that is burned as a slot in the upper board.
Pusher base	187	Inside edge	The outline of the base of the pusher element that is burned in the upper board.
Pusher shoulder	189	Annotation	The shoulder that stops the element from being pushed through the upper board.
Pusher clearance	190	Annotation	The effective size of the element. The stripping component is considered to fit inside the stripping hole if the clearance lines are inside the waste area defined by cut lines inside the stripping hole. Also defines slot placement.
Hole inside modifier	180	Inside edge	The inside edge of an interference extending partly into the lower stripping hole. This loop is combined with the lower stripping board to make the hole smaller.
Hole outside modifier	181	Inside edge	A slot in the edge of a lower stripping hole which holds the outside edge of a stripping hole element. The loop is combined with the lower stripping board to make the hole larger.
Stripping component alignment	203	Annotation	These lines touch the edge of the stripping hole to align the stripping hole component.
Stripping component carrier alignment	204	Annotation	These lines touch the carrier rule when the component is aligned near a carrier rule.

Shown below is an example of how these line types should be used.

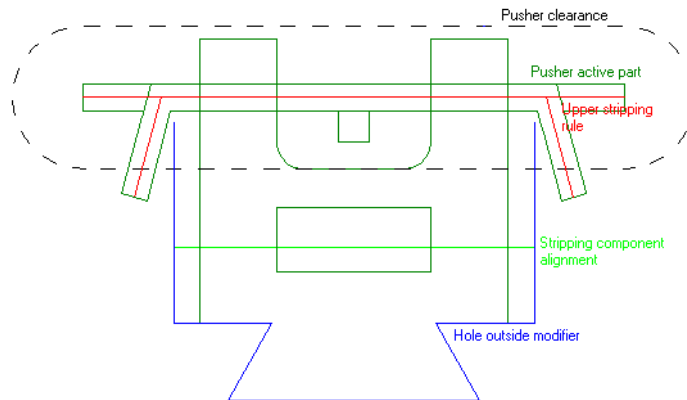

Clearances

For a stripping component that is wider than it is tall, the clearance perimeter should have both horizontal and vertical symmetry. The left or right end of the clearance is centered in a slot, depending on the position of the mouse cursor in relation to the side of the slot. Design clearances using the **Pusher clearance** line type in the Upper board line type catalog.

Shown below are alternate clearance shapes to show possibilities beyond an oval.

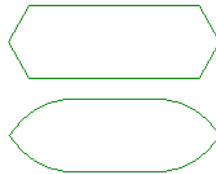

For a stripping component that is taller than it is wide, the clearance perimeter should have vertical symmetry. The bottom end of the clearance is centered in a slot.

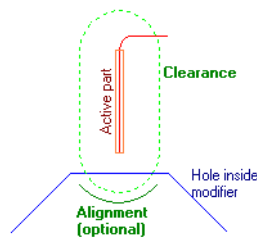

For a pin, the clearance should be circular. The alignment lines should be omitted as they would usually be the same offset as the clearance.



Clearance lines are shown in the drag but are invisible after the stripping component is placed. If there are no clearance lines, or if they do not form a loop, no slots are defined.

Alignment lines

Alignment lines determine how the stripping components are aligned with the edge of the waste. Design alignment lines using the **Stripping component alignment** line type.

Alignment lines:

- Should be a single set of connected line segments (but not a loop) below the lower edge of the clearance.

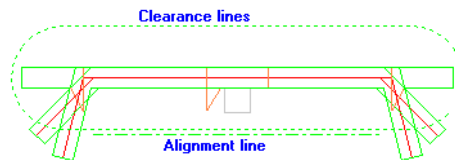

- Should be horizontal, they do not need to be straight - they can be arcs for use when the waste edge is curved.

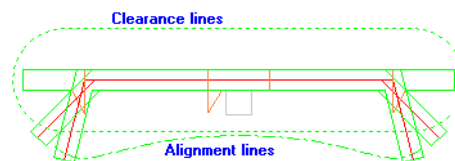

- Can be along the bottom edge of the clearance lines, but should not be within them.
- Are optional if the clearance lines are a loop, in which case the lower half of the clearance lines form alignment lines.

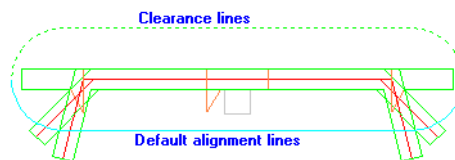

When designing a stripping component for use on carrier rules, add a horizontal carrier alignment line below the alignment lines, or below the clearance lines if using the default alignment.

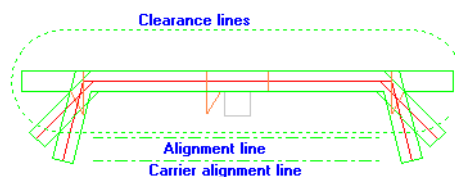

Listing stripping components on a Report

You can create a Report that lists the stripping components used in a stripping board by adding items of calculated text in the Stripping Component Information catalog in the Manufacturing / Layout catalog of calculated expressions.

When you first add a stripping component to a layout that does not have any, the stripping component gets assigned a number called its **index**. The index of the first stripping component is set to 1. If the stripping component is composed of subgroups, those subgroups also get

assigned an index number of their own. For example, if you have stripping component MBC Pin 1 which has three subgroups, the pin as a whole is set to index 1, and the three subgroups are set to indices 2, 3, and 4. The next pin would therefore have indices 5, 6, 7, and 8.

The calculated expressions work in terms of the index of an item or its name. Enter each as appropriate. Each calculated expression only lists information for the item corresponding with the index number you entered when prompted. If you only add one item of calculated text based on index 2 but have four stripping components, only information about the second index is included on the Report. Add multiple calculated expressions to result in multiple pieces of information about the stripping components.

Notes and warnings about stripping components

Hole modifier lines can be added manually to the upper and lower stripping boards, but they affect only the lower board on Output. If there are inside or outside modifier lines which do not cross a lower hole or the lower board edge, a warning dialog box is displayed.

If inside or outside modifier lines cross more than one hole, only the first hole will be affected. If modifier lines do not cross any holes, a warning will be displayed on Output.

When creating a composite stripping component out of smaller components, delete excess clearance and alignment lines so only one set remains.

Notes and warnings on manual stripping board modification

When ArtiosCAD makes stripping board holes, inside modifier lines are connected into a loop following the shortest route around the hole. ArtiosCAD then subtracts inside modifier loops, or adds outside modifier loops as needed. If the result has more than one piece, ArtiosCAD keeps only the largest piece.

A geometry tool like the line, rectangle, arc tool can put lines in any layer, so there is a potential for having lines in the wrong layers, or lines in the wrong order not forming loops.

When you switch to a lower/upper board tool, or open a manufacturing file, ArtiosCAD activates a fix stripping board function to move the lines to the correct layers, and fix the upper/lower board exteriors so they are counter-clockwise loops.

The stripping board functions, for example dragging a pin along the board edge, only work after the layers and loop direction have been fixed.

The fix stripping board function does the following:

- Forms loops out of the lower board edge and lower hole lines.
- Lower board edge and lower holes lines that do not form loops are moved into sublayer **Lower Other**
- Upper board edge lines that do not form loops are moved into sublayer **Upper Other**
- Moves the inside modifier lines to the lower board layer and makes loops if possible.
- Moves stripping components, pins, rules, blocks into an internal or external upper sublayer depending on if they are in holes or on the board edge.

- Makes loops out of air hole lines and moves them into the air holes sublayer

Using a Geometry Macro to add a burn name

There are three Name Tools in **Tools > Geometry macros > Manufacturing tools > Dieboard utilities**. These tools place information on the dieboard itself.

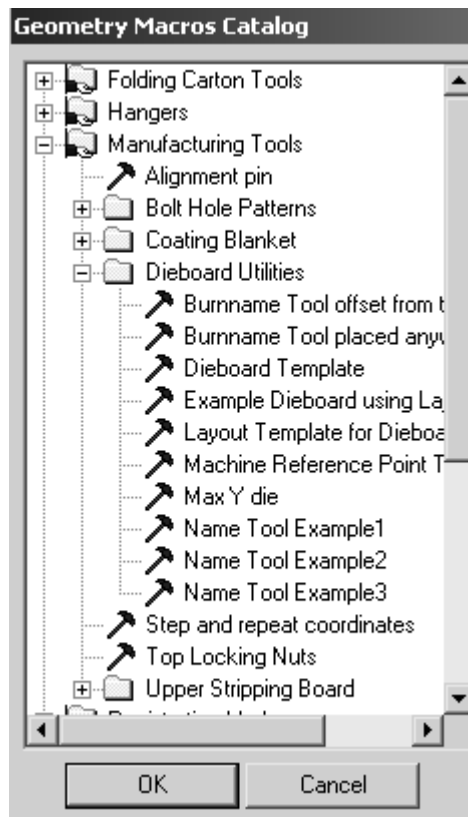

Name tool Example1 inserts a geometry macro containing the file name with no extension, the dieboard size, the customer name, and the manufacturing file description.

ARTIOSCAD MFG

File Name No Extension

Dieboard Size

Customer Name

MFG file description

Name tool Example2 inserts only the file name with no extension.

ARTIOSCAD MFG

File Name No Extension

Name tool Example3 inserts the filename with no extension in the INTERACT font.

ARTIOSCAD MFG
 File Name No Extension
 (Uses Interact Font)

Plastic counter layouts

Plastic counter layouts are used to make many counters at once on a countercutter.

A few notes about plastic counter layouts:

- Only the counter layer from each embedded design is shown. Manufacturing layers and design layers cannot be seen.
- Only manual layout tools are available.
- Plastic counter layouts are not tracked in the database.
- Side and grain are not applicable in plastic counter layouts. The top of the plastic counter is always shown. However, the grain direction for embedded designs is set to match that of the original designs.
- Plastic counter layout workspaces use the .CTL filename extension.

Creating a plastic counter layout

Before creating a plastic counter layout, you must have at least one design containing a plastic counter for inclusion in the layout.

To create a counter layout, do the following:

1. Start ArtiosCAD.
2. Click **File > New > Counter Layout**.

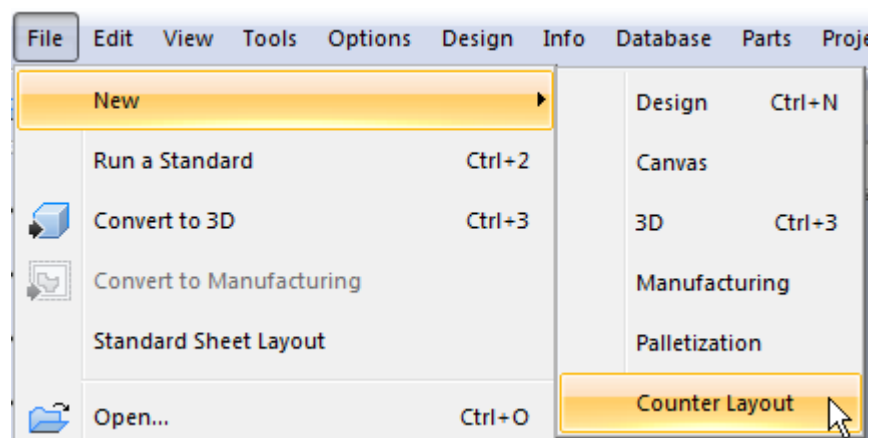

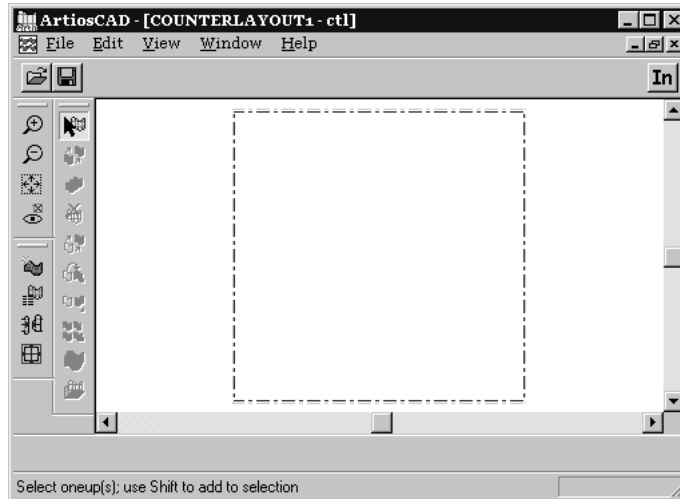

3. A new plastic counter layout will be created containing an empty sheet.

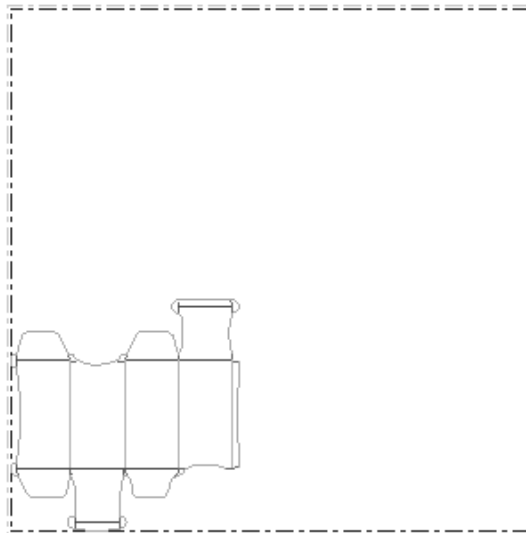

4.  Click the **Add Oneup** tool and then select the design(s) to add. Click **OK**.



5.  Click the **Select Oneups** tool and select the design you just added.
6. Use any of other Manual Layout tools to arrange the design on the sheet. The quickest and easiest way to do this is to set the gutter and then use one of the Nest tools to step the counters out on the sheet.

 To change the gutter between the counters when using one of the Nest tools, click the **Change Gutter** tool and enter the new gutter distance.



Use one of the tools on the Nest tools flyout toolbar. Shown below is a picture of an example counter layout using the **Straight Nest** tool.

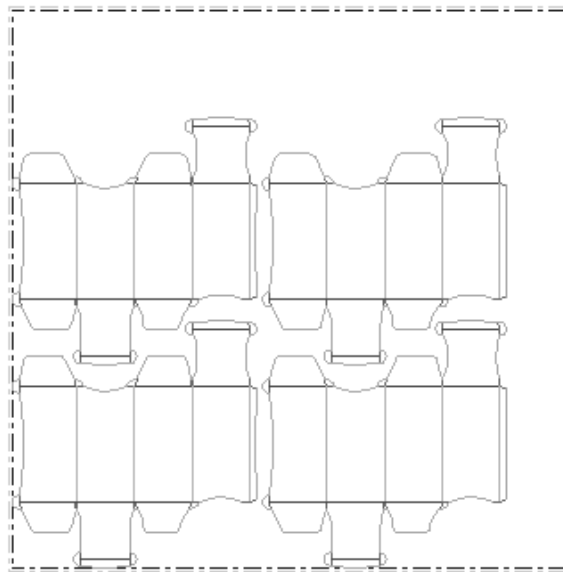

7. Output the plastic counter layout using a counter Output on the **File** menu. A preview of the output to a Kongsberg PentaCut is shown below.

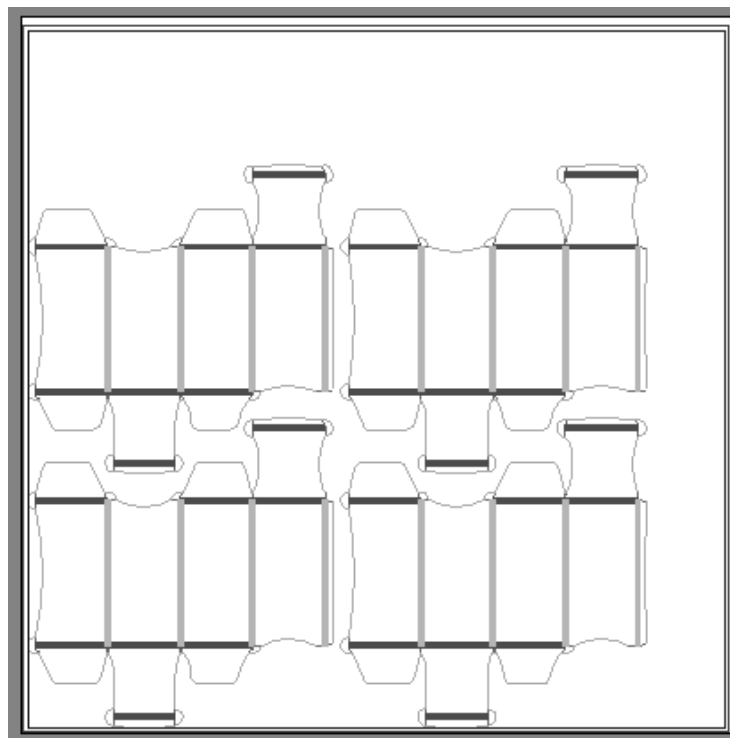

8. Complete the Output and save the layout.
The plastic counter layout is now complete.

Modifying a plastic counter layout

To modify the position of the design on the plastic counter layout, use the tools on the Edit Layout toolbar.

If the nested plastic counters don't completely fill the sheet, you may want to adjust the size of the sheet or the position of the plastic counters on the sheet.



Use the **Change Sheet Size** tool to do this.

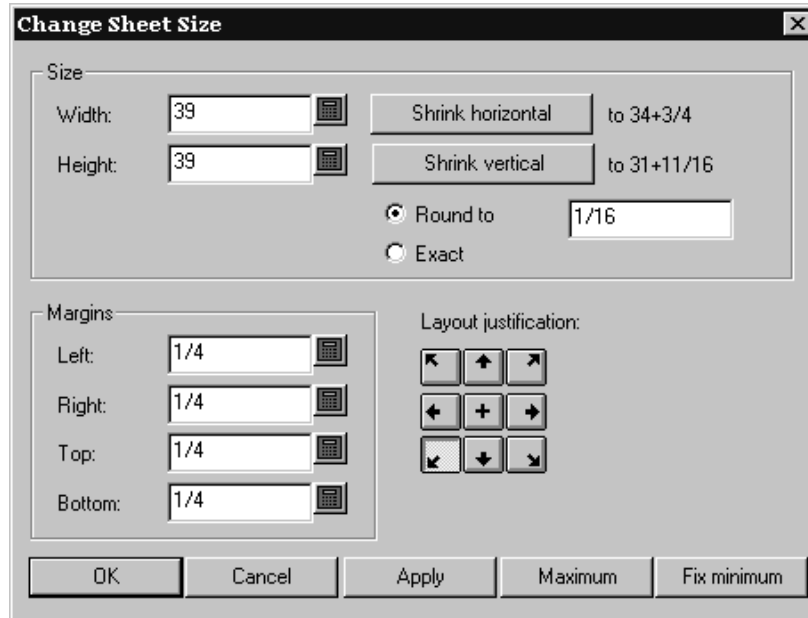

You must choose a layout justification method first. The buttons in the **Layout Justification** group move the group of designs so that the bottom center of the designs is aligned with the bottom center of the sheet, and so forth. Once a layout justification method is chosen, all the other fields become available and you can adjust the size of the sheet and its margins.

Steel counter layouts



Create or Rebuild Counter is the twelfth tool on the Manufacturing toolbar. In Manufacturing, ArtiosCAD creates counter layers in the embedded single designs and frame components in the counter layer of the manufacturing workspace. For a discussion of the general workflow, refer to the Intelligent Counters section of the Designer chapter.

If the embedded single design(s) already contain counter layers, ArtiosCAD prompts you to select the layers to rebuild.

If all the embedded design(s) will use the same parameters, make the counter in the manufacturing file. To have some embedded designs use different parameters, rebuild the counter separately for each embedded design (by opening each embedded design and using **Create or Rebuild Counter**), and deselect **Oneup(s) Counter Layer** when making the frame in Manufacturing.

The **Steel counter** entry in the Layers dialog box controls the counter layers both the manufacturing file and the embedded design(s) as well.

Frame tab of Create or Rebuild Counter tool

The Frame tab of **Create or Rebuild Counter** only appears when you use the tool in a manufacturing file. Activating the tool turns on the Steel counter layer in the manufacturing file and any counter layers in the embedded single design(s).

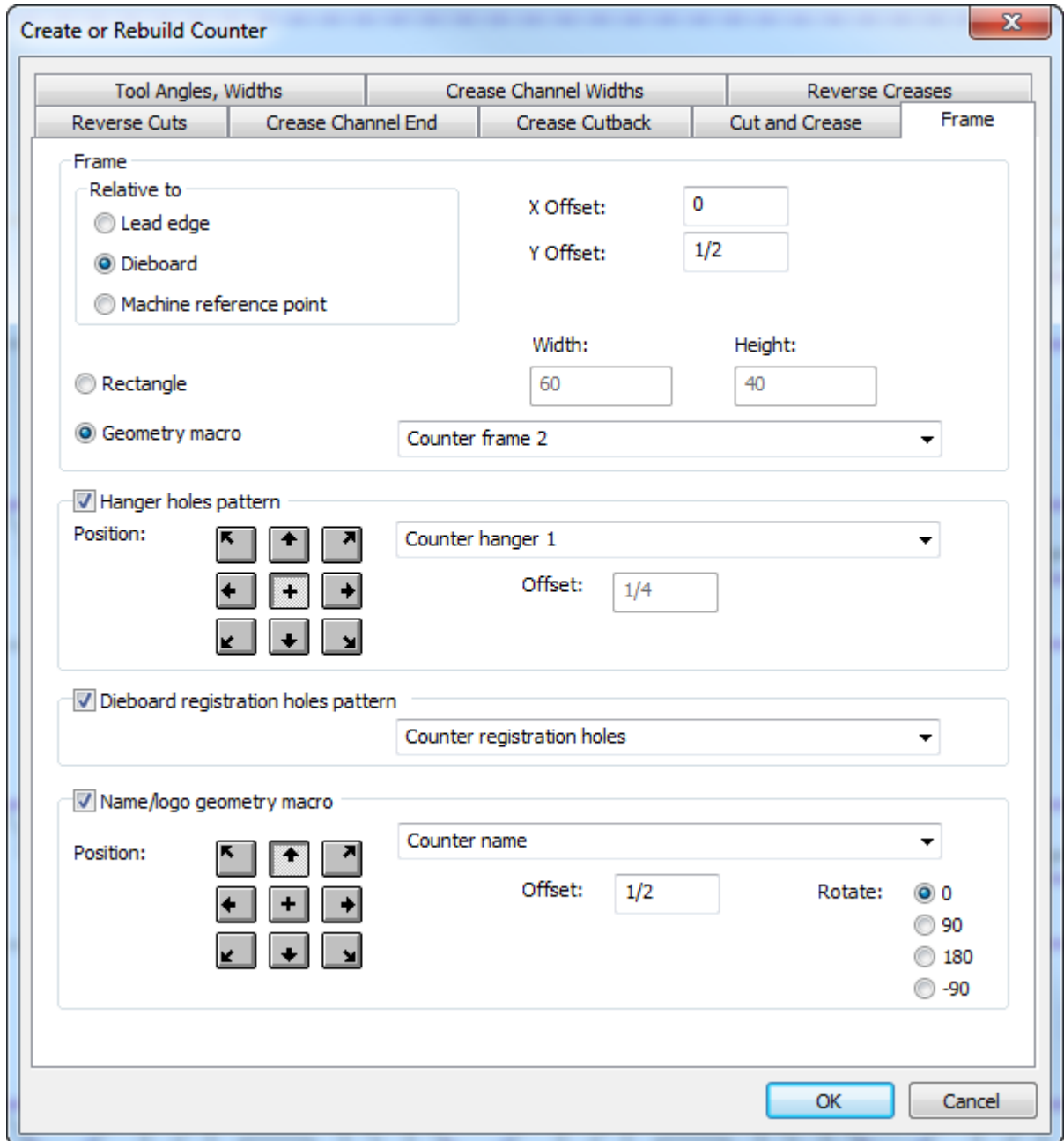

The **frame** is either a rectangle of a size you specify or a workspace contained by a geometry macro. It is centered horizontally on the blank size of the knives and stripping rules with the

specified offset from the choice you make in the Relative to group - either the lead edge, dieboard, or machine reference point. If you choose a geometry macro, the outline of the frame should be made out of lines with the Periphery tool line type, and any slots should be made of lines of type Counter slot. The slots must form complete loops. If some of the edges of the frame are on the edge of the steel plate and do not need to be cut, change those edge lines to type Size only. The combined Periphery tool lines and Size only lines must form a complete loop.

The **hanger holes pattern** is a single hole or two holes which are a fixed distance apart. These holes are used to hang the counter for storage. ArtiosCAD will adjust the pattern up to 3 inches for clearance around channels and milled areas, and will warn you if it cannot adjust the pattern for clearance.

The **dieboard registration holes pattern** contains laser positioning holes (holes in the dieboard made using line type Laser positioning holes or Laser positioning holes 2) and counter positioning holes in the counter (line type Positioning hole tool or Positioning hole tool 2). The pattern is generally centered on the frame, but you can choose its justification position as desired and any offset. The pattern can also be bigger than the frame, but any holes outside the frame are excluded. ArtiosCAD will automatically adjust individual holes up to 3 inches for clearance around channels, milled elements, and rules.

The **name/logo geometry macro** is a geometry macro meant to contain your company name and logo (which you should add to the geometry macro catalog in Defaults). Position it as desired, set an offset, and set a rotation. Make the macro rebuildable with a menu of type Precalculated Variables for a Geometry Macro, and add the text variables so that they have an expression initialized from variables in the manufacturing file. If desired, you can change the text running the geometry macro. When you Output this counter, ArtiosCAD converts the text to lines and arcs of line type Name tool depending on the options on the Output's Processing tab. If you make a logo in the geometry macro, use line type Name tool.

Coating blankets

Coating blankets, also called varnish blankets, are used to protect those areas of the sheet from having coating applied as the sheet moves through the printing press.

Coating blankets use the bleed or varnish layers in the single designs comprising the layout. If the designs do not have one of these layers, a coating blanket can not be made.

Making a coating blanket

To make a coating blanket, construct a layout of single designs containing bleed or varnish layers. Then, do the following:

1. Click **Tools**, and then click **Geometry Macros**.
2. Open the **Manufacturing Tools** folder and then the **Coating Blanket** folder by clicking the plus signs next to them.
3. Select the **Coating Blanket** geometry macro.

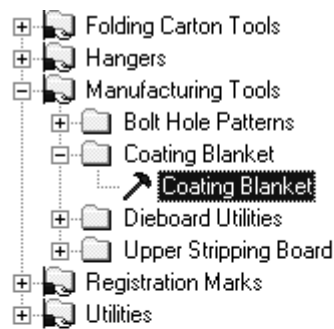

4. Click **OK**. As this is a geometry tool, it runs like a style in a Standards Catalog.



Cut Coating Free Areas and **Cut Coating Areas** control what is actually cut - those areas not being coated or those areas being coated. Use the former choice to make strips in the unused portion of the blanket.

The layer choices control which single design layer is used to make the blanket. There can be six separate coating layers.

Apply shrink and **Do not apply shrink** control if the tool automatically shrinks the blanket upon creation or upon output.

Use Coating Blanket and **Use Current Layer** control where the coating blanket is created. The former choice uses the predefined layer you chose earlier in the menu. The latter uses the current layer.

Select the desired options and click **Next**.

5. The Coating Blanket Options menu is where the coating blanket settings are configured.

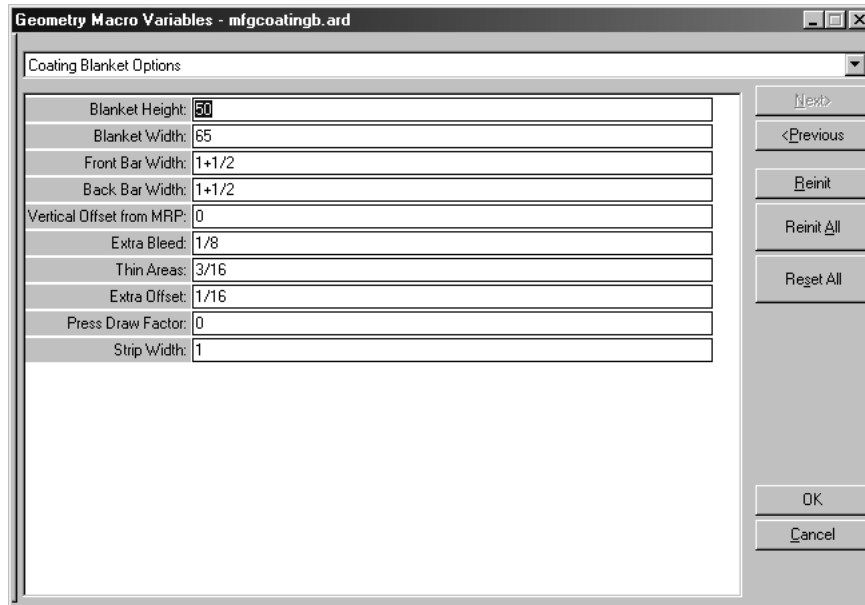

The variables in this menu are explained in the table below.

Table: Variables In The Coating Blanket Options Menu

Variable	Meaning
Blanket Height	Height of coating blanket.
Blanket Width	Width of coating blanket.
Front Bar Width	Height of the front bar.
Back Bar Width	Height of the back bar.
Vertical Offset from MRP	Offset of the coating blanket with respect to the front bar. A negative value moves the coating blanket down; a positive value moves the coating blanket up.
Extra Bleed	Extra bleed allowance to use when creating the blanket using coating-free areas.
Thin Areas	If a strip of coating material would be smaller than the width specified by this variable, it is discarded.

Variable	Meaning
Extra Offset	Extra offset to be applied to the coating blanket outlines
Press Draw Factor	Value that the interior of the blanket is shrunk in the Y direction to compensate for the blanket being mounted on a cylinder. This does not affect the bar widths or overall size of the coating blanket.
Strip Width	Width of the strips created.

Click **OK** once you have set these variables as desired.

- The coating blanket is created. See the following picture for an example of a coating blanket with all layers turned off except for the coating blanket. You may have to turn on the **Coating Blanket** layer in the Layers dialog box to see it.

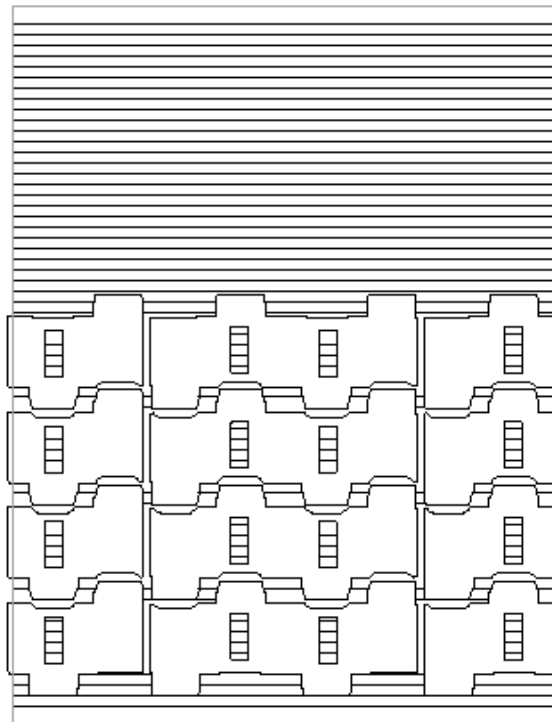

Modifying a coating blanket

Use any of the Designer tools to modify lines in the coating blanket.

To remake the coating blanket, turn off all the other overlays, select all the lines in the Coating blanket overlay, and delete them. Then rerun the geometry tool.

Configuring alternate coating blankets

The Coating Blanket geometry tool is contained in the workspace `..\InstLib\MFGCOATINGB.ARD`. To make alternate coating blankets with different default values, copy this workspace, modify the workspace variables of the new file, and then add the new workspace into the Geometry Tool Catalog in Defaults. Be very careful to not draw any lines in the workspace.

Rotary Diemaking

Instead of cutting containers out of material by using a cookie-cutter action on a stationary sheet, rotary diemaking uses rotating cylindrical dies on moving sheets. These dies can be made out of more than one piece of wood and are bolted to the machine cylinder.

The technology of rotary diemaking, while sharing many elements of flat diemaking, has special features, such as curved wood and notched rule, which are not applicable to flat diemaking. For that reason, it is a separate option from regular DieMaker.

In rotary diemaking:

- Tooling can be designed at three levels: the cylinder level, the wood level, and the rule level.
- Elements which are designed at one level are transformed (into a new size, shape, or both) when processed on another layer to compensate for the curve of the dieboard or rule.
- Tooling is made from single or multiple pieces of wood which contain mounting holes, steel rule paths, and other geometry which can be manufactured or drawn on the surface of the wood. Multiple sections can be output individually from ArtiosCAD.

The options on the **View Options** submenu of the View menu make it easier to work with rule paths. You can toggle the display of bridges, line direction, rule path ends, and construction lines. You can also assign these menu options to Shortcut keys for faster access.

Tools for rotary dies / DieSaw output

The **Rule Path Tools** toolbar, the **DieSaw** toolbar, and the **Registration Hole Tools** toolbar contain the tools for making rotary dies and/or outputting to the Kongsberg DieSaw.

The **Rotary Bolt Holes** tool is on the Dieboard toolbar.

Rotary Die Board tool



The **Rotary Die Board** tool on the Dieboard toolbar works with the following elements of a rotary dieboard:

- Bolt holes
- Splits
- Edges

Rotary Die Board is available only when the current press is a rotary press. Other mounting pattern tools are unavailable for workspaces using rotary presses.

It has five states, or modes of operation. Change states by clicking its button on the Status bar. Each state has different prompts and modes. Shown below is the initial mode of the Adjust Elements state when the manufacturing workspace does not have a hole pattern defined.

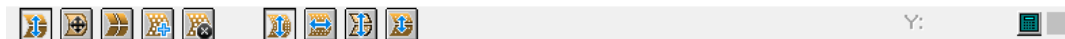

- **Adjust Elements.** Moves bolt holes, splits, and edges.
- **Adjust Die Edge.** Moves the die edge.
- **Adjust Die Splits.** Creates new horizontal or vertical die splits, moves existing splits, or deletes splits.
- **Add Bolt Holes.** Adds bolt holes from the mounting hole pattern to the workspace.
- **Delete Bolt Holes.** Deletes existing bolt holes from the workspace.

When you first start the tool, ArtiosCAD:

- Changes to the Dieboard layer. If that layer is locked, it changes to the Stripping Rules layer.
- If the dieboard does not exist, ArtiosCAD creates it, checks it for size, and creates a horizontal split 180 degrees from the top automatically if needed. The formula for the full shell size is $\text{Pi} \times (\text{cylinder diameter} / 2)$ or $\text{Pi} \times r$. You could have already created the dieboard with **Create Wood Edge** but it does not automatically add the split. If you use a geometry macro requiring placement to create the die board, ArtiosCAD shows the geometry macro controls as well as the Rotary Die Tool controls.
- If a pattern workspace does not exist, Adjust Elements and Add Holes states are unavailable, and the tool starts in Adjust Die Edge state. ArtiosCAD displays a warning.
- Displays the bolt hole pattern if no holes exist in the workspace. If holes already do exist in the workspace, cArtiosCAD enters the Add Bolt Hole state instead of the Adjust Elements state.

ArtiosCAD shows the entire bolt hole pattern trimmed to the die edge but with an extra row or column on each side. Good holes do not intersect geometry and are not too close to t-holes. They are green. Bad holes, those which intersect geometry or are too close to t-holes, are red. Circular holes have snap points in their centers. If the holes are aligned in rows and columns (see the next section on making a pattern workspace), there are extra snap points halfway between each row and column.

Making a Pattern Workspace

For the **Rotary Die Board** tool to work properly, you need to design a bolt hole workspace for your specific press. In that workspace, make circles representing the bolt holes using line type Die bolt holes. Optionally, you can add annotation circles to show the washer size, and any other annotation lines as desired to serve as pick-up points to position the pattern. The holes must have 0 degrees of difference between their centers horizontally and vertically for ArtiosCAD to recognize them as rows and columns when you select them using this tool.

ArtiosCAD considers all lines in layer classes Main, Windows and Cutouts, and Manufacturing as part of the hole pattern. Lines in layers of other classes are not considered part of the hole

pattern. For text, change it to Outline Text with the Annotation line type. ArtiosCAD copies the pattern workspace into the manufacturing workspace the first time you add holes; it does not copy from the pattern workspace on subsequent hole additions.

The holes should correspond with the holes on the bare cylinder itself, not the holes on a die already on the cylinder. The holes will be at cylinder level in single design, and ArtiosCAD stretches them to design level when it converts the pattern to manufacturing.

Make the pattern workspace large enough to cover the entire cylinder. ArtiosCAD will trim it automatically as needed. However, ArtiosCAD cannot expand the pattern if it is too small.

ArtiosCAD positions the pattern according to the settings in the die press parameter set. If the parameter set sets the MHP (Mounting Hole Pattern) on the center of the die board, the origin (0,0) of the pattern workspace is aligned with the center of the die board. If the die press parameter set sets the MHP at the machine reference point, ArtiosCAD aligns the origin of the pattern with the machine reference point. After that, if the workspace contains X or Y offsets for the MHP, ArtiosCAD adjusts the pattern accordingly.

Shown below is the sample ..\InstLib\MHP66OFFCENTER.ARD workspace. It has small horizontal annotation lines along the Y axis in between the rows for easier pick-up when moving the pattern.

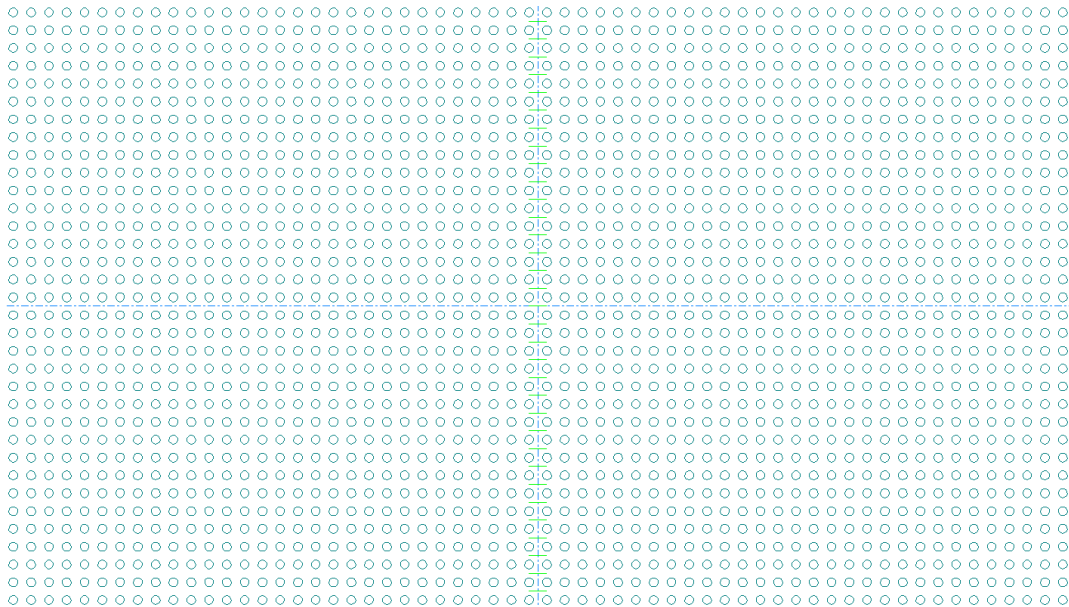

Adjust Elements state

The **Adjust Elements** state of the Rotary Die Board tool has these mode controls on the Status bar:



These modes do the following:

- **Move Holes Vertically.** Moves the hole pattern vertically (the default mode) and prompts for pick-up points.
- **Move Holes Horizontally.** Moves the hole pattern horizontally

- **Move Die Edge, Splits and Holes.** Moves the die edge, splits, and holes vertically
- **Move Splits and Holes.** Move splits and holes vertically.

Shown below is after you first start the tool with no existing holes. It is in Adjust Elements state, Move Holes Vertically mode. The hole pattern is on with good and bad holes marked.

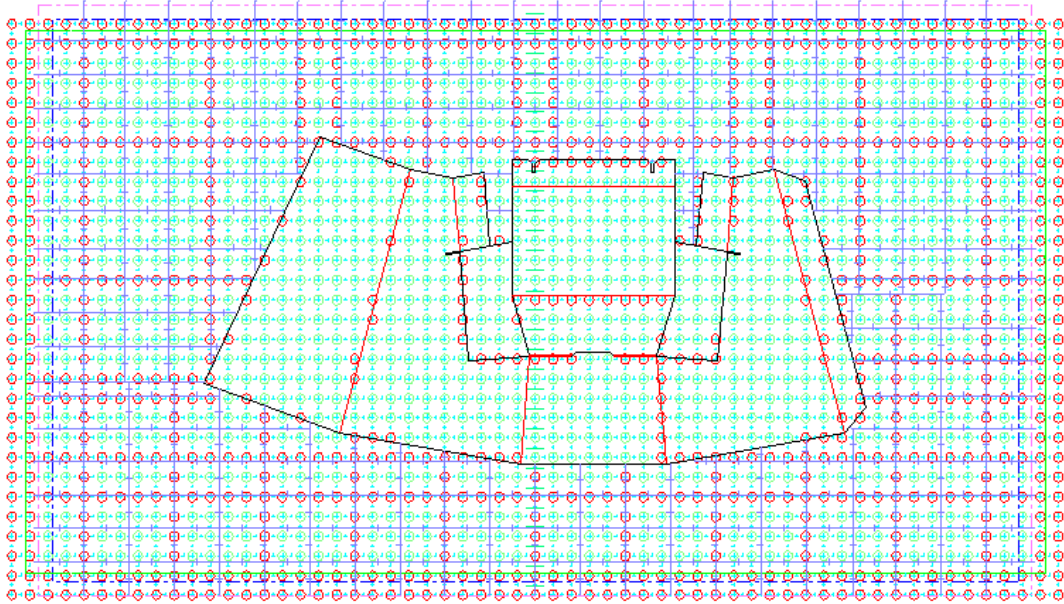

In Move Holes Vertically mode, do the following:

1. Click a pick-up point.
2. Drag the pattern by the desired offset.

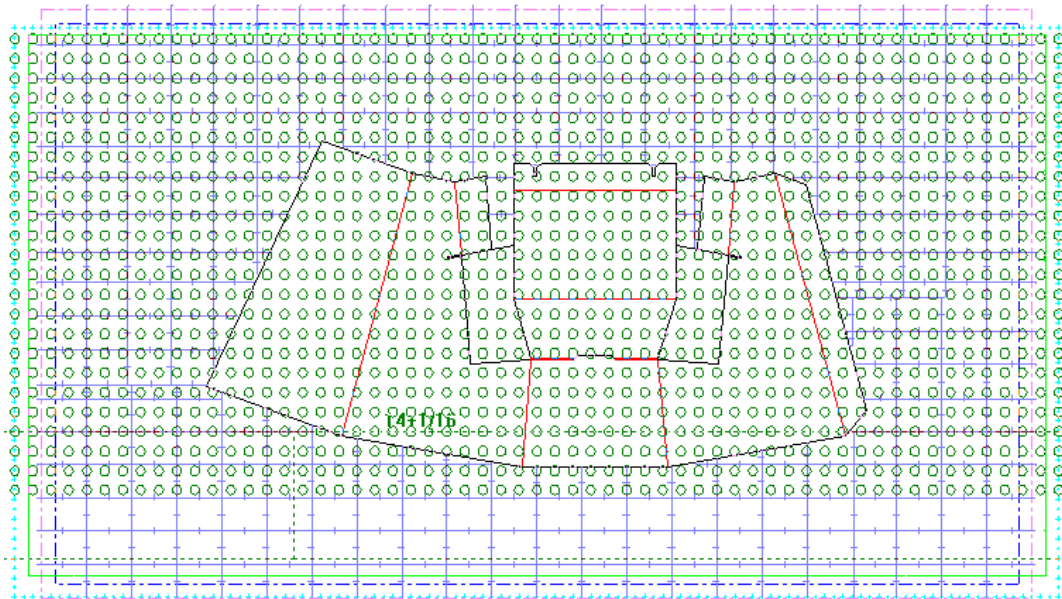

3. Click to set the put-down point.

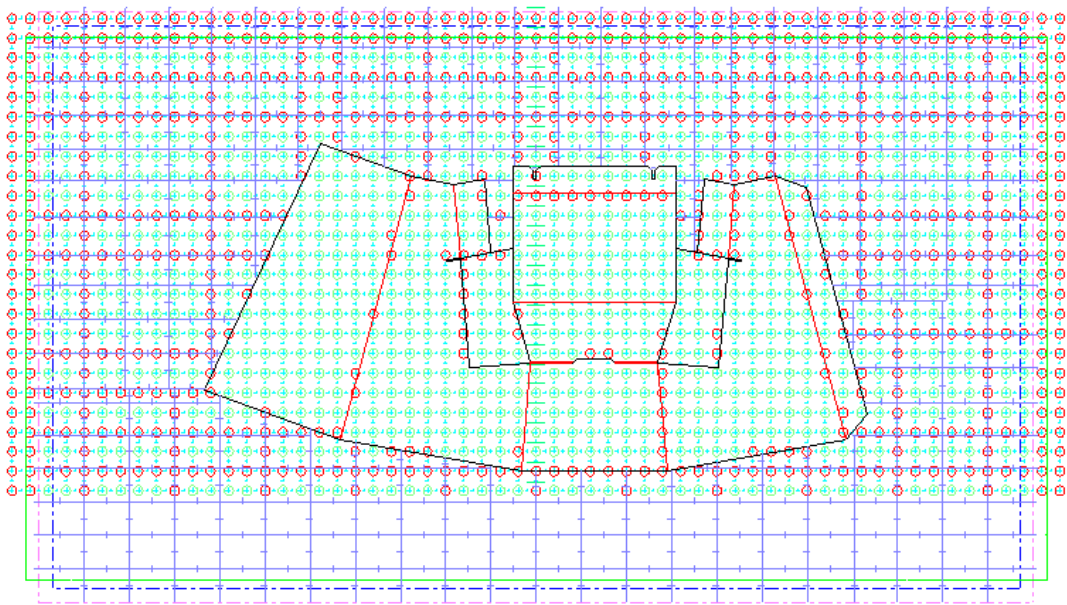

In Move Holes Horizontally mode, do the following:

1. Click a pick-up point.
2. Drag to set the offset.

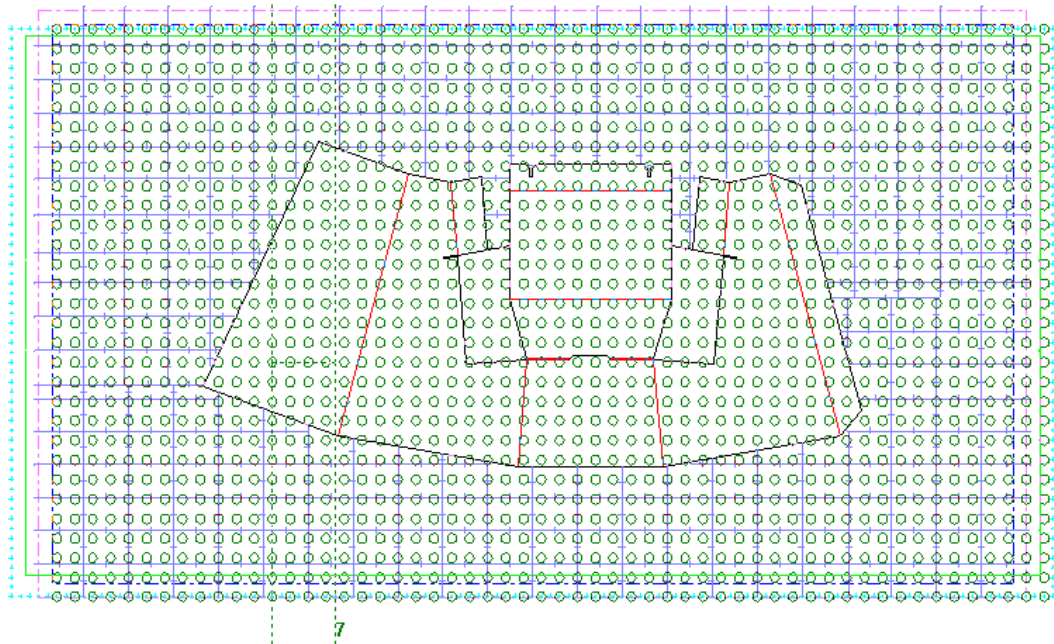

3. Click to set the put-down point.

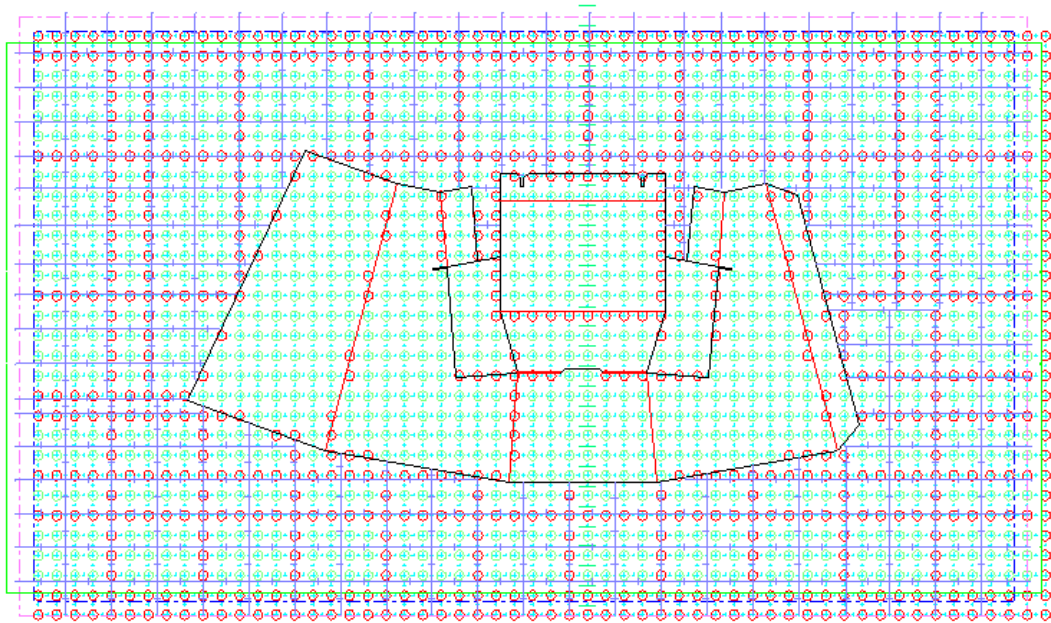

The other two modes, **Move Die Edge, Splits, and Holes**, and **Move Splits and Holes**, work the same way - pick up, drag, and put down.

Note: When using **Move Die Edge, Splits, and Holes** mode, the X and Y offsets are not changed if the MHP position is based on the die board center since you are moving the die board edge with the pattern. If the MHP position is based on a reference point, ArtiosCAD changes the Y offset of the pattern in workspace variables. If you did not delete the existing bolt holes when starting this state, ArtiosCAD adjusts the existing holes by the same offset as the MHP.

Move Splits and Holes mode has some additional features:

- Shows the height or angle as drag feedback depending on which field is active in the Status bar.
- When setting the height, the drag is the vertical offset from the pickup point to the cursor.
- When setting the height or angle, the current position is the split. It turns red if the shell is bigger than 180 degrees or one full shell height.
- When selecting the pickup point, the drag prompt depends on what is closer. Change the **Split measured from** control to change what you are dragging.

Adjust Die Edge state



The Adjust Die Edge state of the Rotary Die Board tool moves the die edges either horizontally or vertically, singly or doubly. It has these controls on the Status bar.



Move both sides is the default and moves the parallel edges.

Offset or **Height** (vertical edges only) or **Width** (horizontal edges only) controls what you are setting with the drag. However, both numbers are shown in the drag feedback, which turns

red when construction becomes impossible. **Height** mode also allows you to set the angle and gives drag for that if you select it on the Status bar.

The drag displays the offset from the pick-up point above the cursor, and the width/height below the cursor. If you are in Height mode and setting the Angle, the drag shows the angle instead of the offset.

If there is a die split connected to the edge you are moving, ArtiosCAD adjusts it automatically.

Shown below is the drag in Height-Angle mode when construction is not possible. ArtiosCAD also says **Construction not possible** in the drag when you are trying to make the dieboard too small or go across a split.

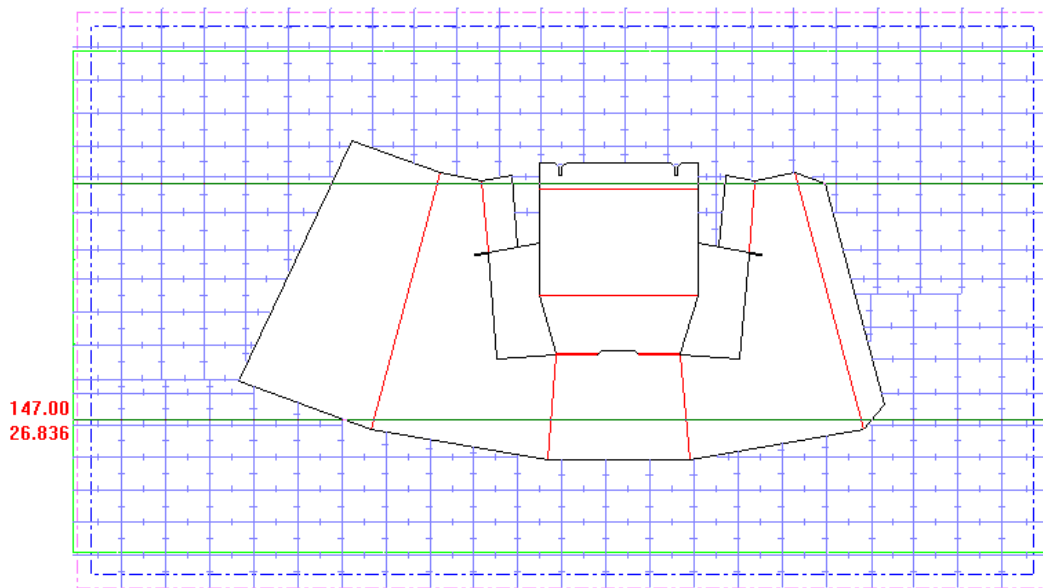

Adjust Die Split state

 The **Adjust Die Split** state of the Rotary Die Board tool creates a new die split, or for existing splits, moves or deletes them. It has no controls on the Status bar when adding a split, but has the same controls as the Adjust Die Edge state when moving a split.

To create a dieboard split, do the following:

1. Click an edge of the die that is parallel to the desired split.
2. Drag to set the position of the split. Change the controls on the Status bar to change where the split is measured from (the Bottom or Top) and what you are setting with the drag (Offset or Angle). The numbers next to the cursor change for different types of drag - distance from the top or bottom, or angle from the top or bottom. As with the other states, the drag turns red if construction is not possible. ArtiosCAD also says **Construction not possible** in the drag when you try to drag a split off the die.

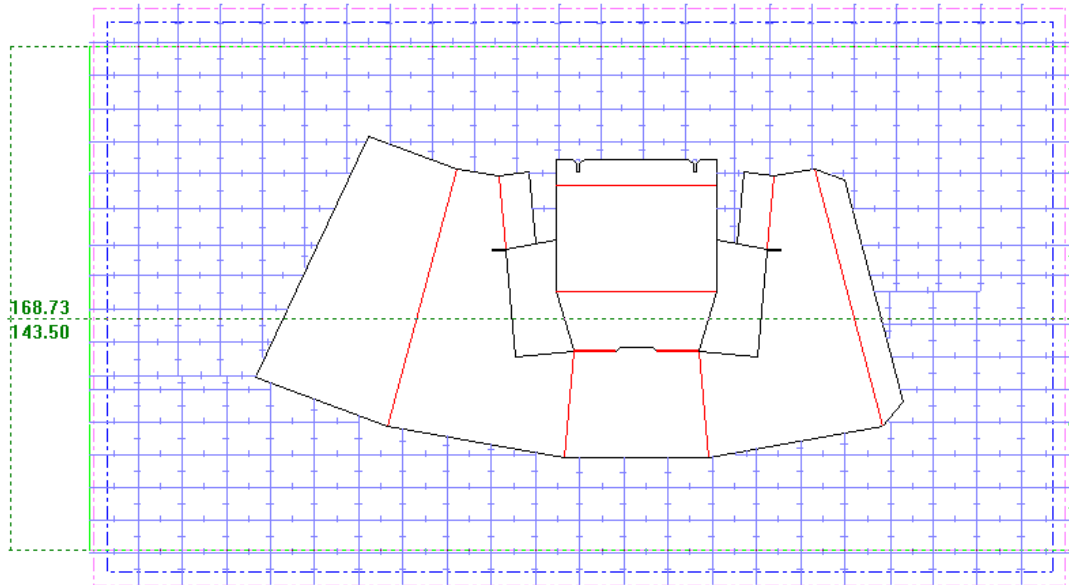

3. Click to set the position of the new split.

To move a die split, do the following:

1. Click the split to move.
2. Drag it, setting the drag controls on the Status bar as desired.

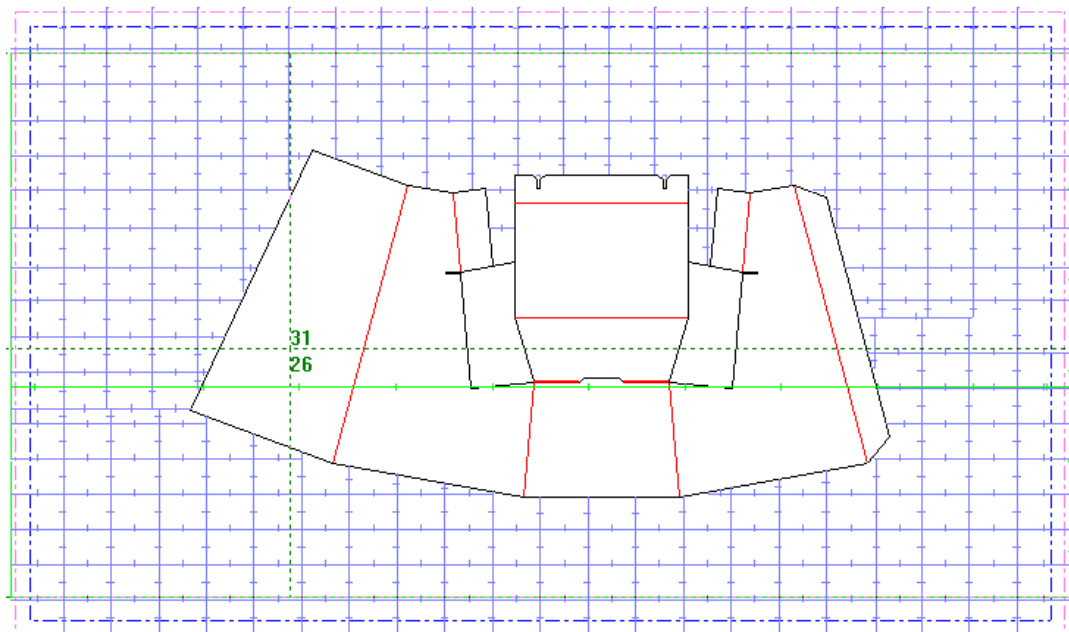

3. Click to set a put-down point.

To delete a die split, do the following:

1. Click the split to delete.
2. Drag it off the dieboard. The drag will change to **Delete split**.

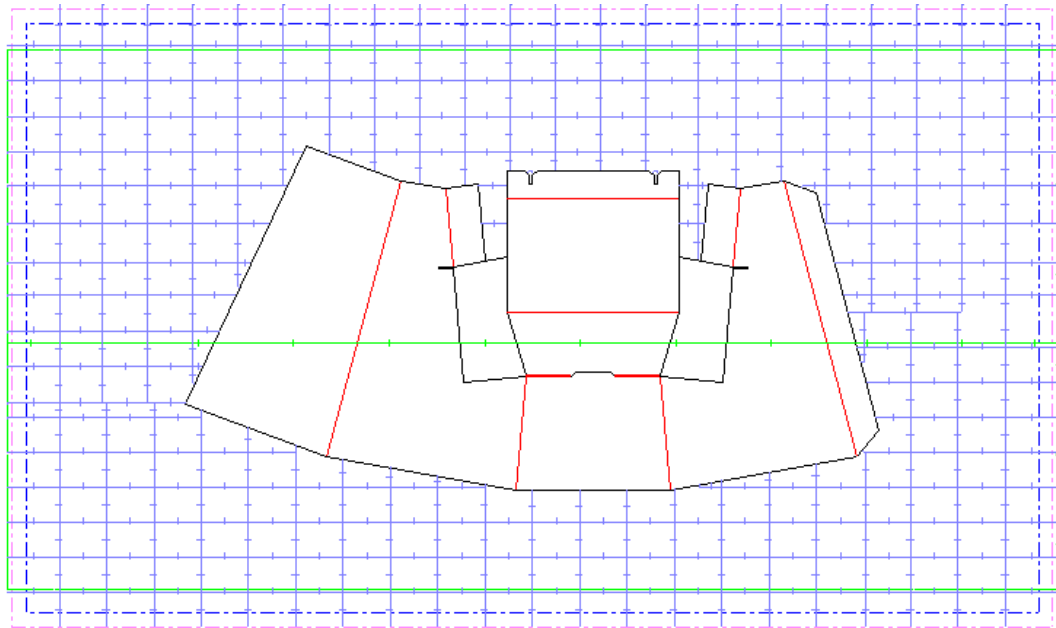

Delete split

3. Click to delete the split. You can also press the Delete key on the keyboard.

Note: Using this mode, you can move or delete complicated splits created by geometry macros, but you cannot add them. Re-run the geometry macro if needed.

Add Bolt Holes state

 The **Add Bolt Holes** state of the Rotary Die Board tool adds bolt holes from the mounting hole pattern to the workspace once you have the pattern positioned. It has the following controls on the Status bar.



The first control on the Status bar is **Show/Hide Bolt Hole Effective Area**. This shows the area of the die board up to a split that is held tight by the bolt as you select holes. The area is set in **Options > Defaults > Die Press Parameter Sets > Press name > Press defaults > Hole Patterns**. Viewing the bolt hole effective area is also an option in the View mode. Shown below is the effective area for the selected hole up to a split.

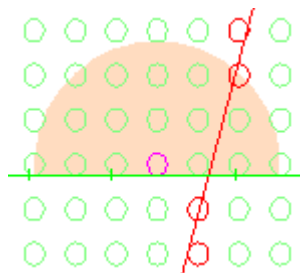

The next three controls on the Status bar control what you select with the cursor. The first is **Select Individual Holes**, then is **Select Row**, and last is **Select Column**.

- When selecting individual holes, click to select or deselect a hole, or click outside of a hole and drag to do a marquee selection, which toggles the current selected state. Selected holes turn magenta. This mode works with die board symmetry if that mode is enabled.
- When selecting by row, click on or inside a hole to mark holes in that row for selection. ArtiosCAD draws a magenta line through the row to show it is marked as shown below. Only holes that are at the intersection of marked rows and columns become selected. Click inside a hole in a marked row to unmark it. This mode does not work with die board symmetry so that mode is unavailable.

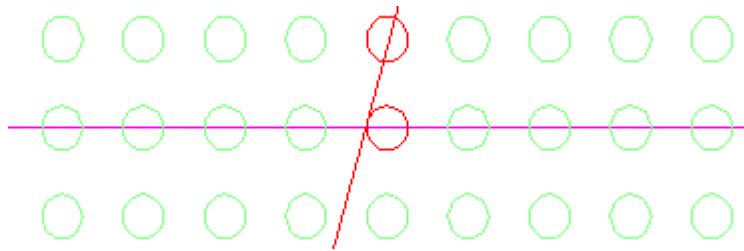

- When selecting by column, click on or inside a hole to mark holes in that column for selection. ArtiosCAD draws a magenta line through the column to show it is marked. Click inside a hole in a marked column to unmark the column. Only holes that are at the intersection of marked rows and columns become selected, as shown below by the one hole below with an area of effectiveness that indicates it is selected. This mode does not work with die board symmetry so that mode is unavailable.

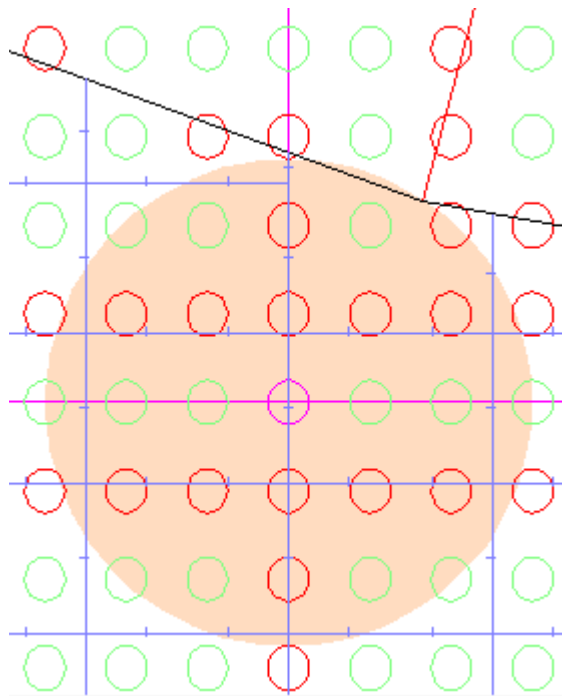

The next two controls are for **Show All Holes** and **Show Only Good Holes**. Good holes do not intersect with any geometry.

The next two controls are for **No Symmetry** and **Die Board Symmetry**, and these are available only for Select Individual Holes. No Symmetry means you select one hole per click. Die Board Symmetry means that you select symmetrical holes with a click within a given distance of a split and a hole at the same distance from that split on the other side of the split. These distances are set by the Split distance and Select tolerance fields in **Options > Defaults > Die Press Parameter Sets > Press name > Press defaults > Hole Patterns**.

Lastly, **Add** adds the selected holes to the workspace. When the current selection is by rows and columns, ArtiosCAD adds only those holes at intersections.

Note: To add individual holes as well as rows and columns, first work with rows and columns, then switch to individual mode to add or remove holes and click **Add**. When doing it the other way around, selecting individual holes before working with rows and columns clears the selection of individual holes when switching to rows or columns. Select individual holes first.

Note: This tool will preserve subtypes defined on the rotary bolt holes.

Delete Bolt Holes state

The **Delete Bolt Holes** state of the Rotary Die Board tool deletes bolt holes from the manufacturing workspace. It has no controls on the Status bar.

To delete bolt holes, do the following:

1. Activate the **Delete Bolt Hole** state.
2. Click an individual hole to delete, or click and drag to define a marquee selection. ArtiosCAD deletes the bolt hole(s) when you release the mouse button.

Rule Path tools

A **rule path** is the outline of the rule which is inserted into the dieboard. Diemakers strive for the most cost-efficient and structurally sound rule paths. Shown below is the Rule Path toolbar.



Other than the **Build Rule Path** tool, all tools on this toolbar are unavailable outside of the **Other** sublayer of the Rule Path layer. Also, while in the Rule Path layer, the tools on all other toolbars, except for those on the View toolbar and the Move tool, are unavailable so that the rule paths are not modified accidentally. You must change to another layer to use other tools.

The parameters by which rule paths are built are in the Rule Path Parameters dialog box on the Options menu in Manufacturing.

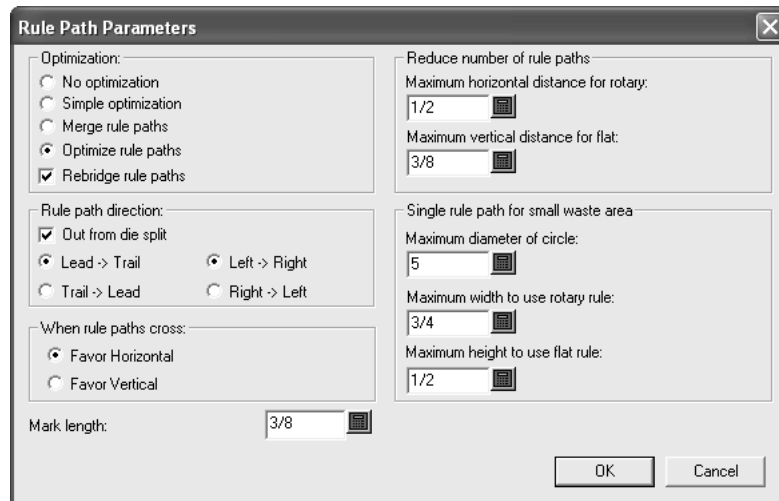

Build Rule Path tool

 The first button on the Rule Path toolbar activates the **Build Rule Path** tool. When held down, it displays the Build/Delete/Add Rule Path flyout toolbar as shown below.



When activated, it first checks to see if double knives are present; if so, it prompts for their removal. Once the double knives issue has been resolved, ArtiosCAD asks for confirmation to rebuild the rule path layer, as any existing rule paths and bridging changes will be deleted:

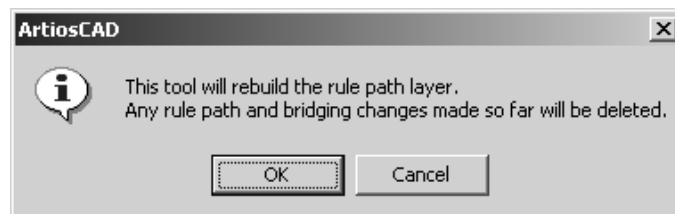

Click **OK** to continue the process of automatic rule path generation, or click **Cancel** to deactivate the tool. Once the rule mapping process is completed, the current layer will be changed to the **Other** sublayer of the **Rule Path** layer.

ArtiosCAD will prompt to map generic rules to specific special rules the first time it builds the rule paths. To do so, select the generic rule to map, click the drop-down list activator arrow at

the end of the **Rule Mapping:** field, and choose the appropriate special rule type from the list displayed. If the **Treat all cuts the same** checkbox is checked, all cuts are processed with the same rule. If it is clear, you can choose different rules for each type of cut.

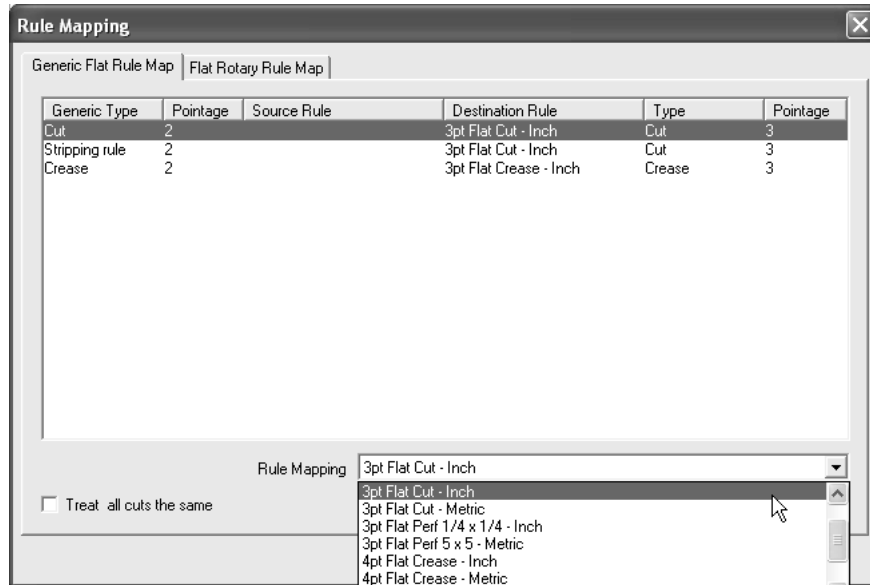

Any rule in the Special Rules Catalog which has a valid bridging formula is listed in the drop-down list box. If this is a flat die, click **OK** to proceed or **Cancel** to cancel building rule paths.

If this is a rotary die, flat rule must be mapped to rotary rule. Click the **Flat Rotary Rule Map** tab (which will only appear if this is a rotary die) as shown and verify that the mapping is correct. If the mapping is not correct, select the flat rule to change and choose a new rotary rule from the drop down list box in the **Rotary Rule:** field. If you choose a rotary rule with a different pointage from the flat rule, you will be warned and will have to click **OK** to proceed.

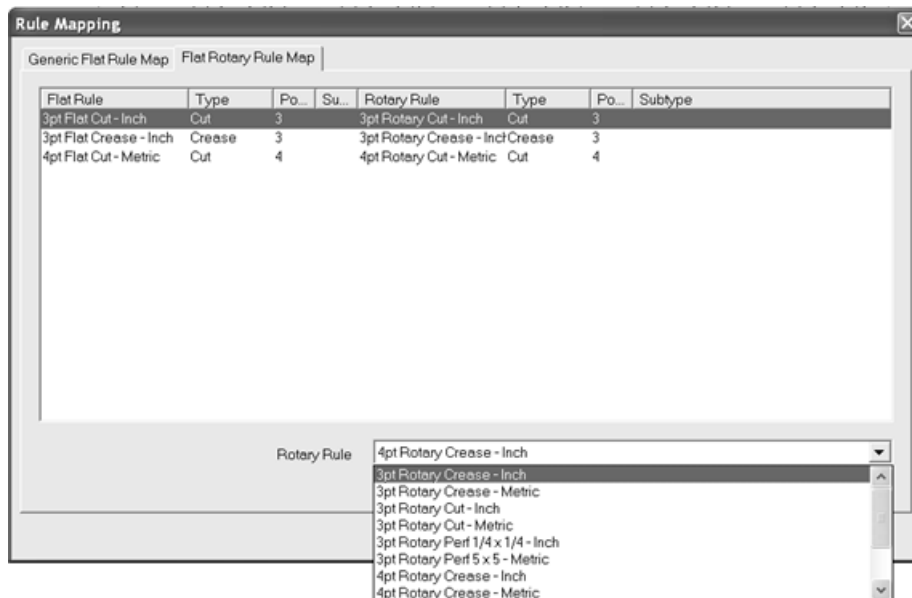

When you are done mapping rule, click **OK** to proceed with building the rule paths or **Cancel** to cancel. The Rule Paths layer is created and the rule paths are created in it. Rule path start

points are shown as green teardrops and stop points are shown as red triangles; both point in the direction of the rule path.

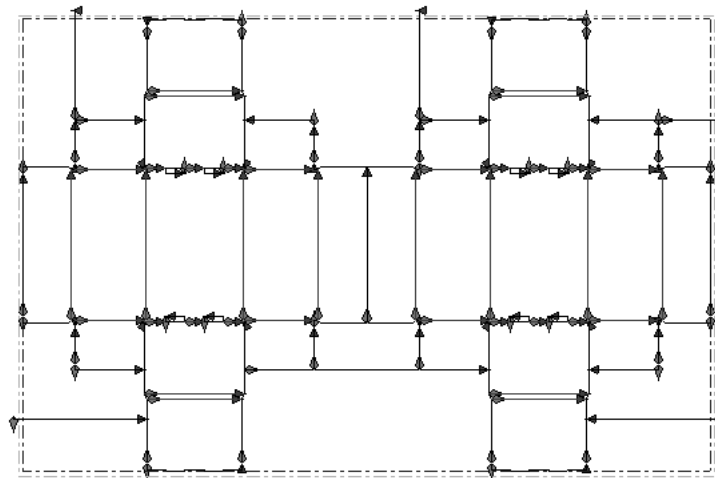

Notes on building rule paths

Rule paths are grouped by rule type and pointage.

A rule path follows the contiguous outline of a design instead of branching off onto a dead-end piece of rule.

Lines sharing a piece of rule (those made by Double Knife Removal) share a rule path as well.

Outlines of the same rule type which form a contiguous waste area are grouped into one rule path.

Defaults for rule paths are contained in the rule's entry in the Special Rule Types catalog and in the **Rule Path Params** entry in the selected Manufacturing parameter set.

When rule paths are created, the **Bridge from center** option is used for each rulepath which has a slot, overriding the option in the **Bridge from** group in the bridging formula for that special rule type.

If rule paths do not wrap as expected, make sure that **Optimize Rule Paths** is selected in the **Optimization** group of the Rule Path Parameters dialog box. Be especially wary of this situation when converting a flat die to a rotary die by changing the press definition after creating the layout.

If you have concerns about wrapping points for flat rule and rotary rule, see the discussion in the **Manufacturing tab for special rules** topic in the *Defaults* chapter.

When three or more rule paths meet, the following rules are used:

- **Separate rule paths for scrap knives.** Rule paths for horizontal and vertical scrap knives are separate. They do not join with each other or with cut lines in the design, except for a stripping rule at a corner.
- **Avoid joints at corners in the design outline.** A **joint** is a point where rules meet. With use over time, rules can bend at joints, leaving small gaps at the joints. ArtiosCAD places joints on horizontal or vertical pieces of rule by wrapping them around corners to minimize this problem.

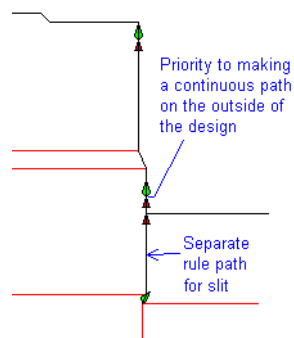

- **Avoid joints at corners in waste areas.** When two designs have no gap between them, there can not be a continuous outline. ArtiosCAD avoids joints at corners in the waste between designs.

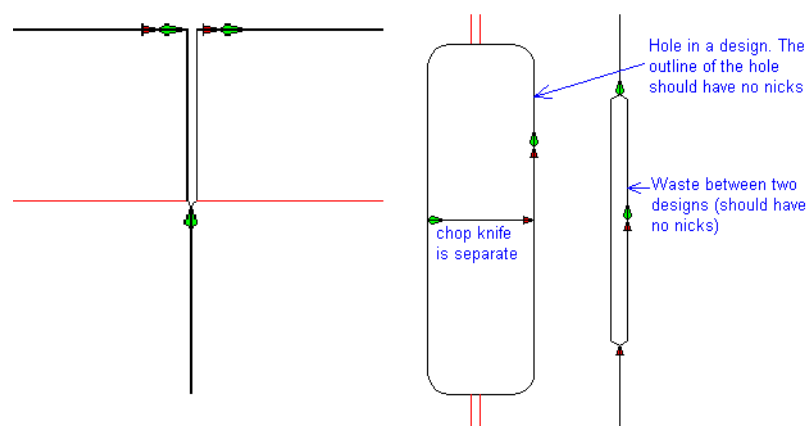

- **Stripping rules/scrap knives at a corner.** When a stripping rule or scrap knife touches a design at the corner, it is joined with the design. When there are stripping rules at the corner of a hairpin, they are joined to form one rule path.

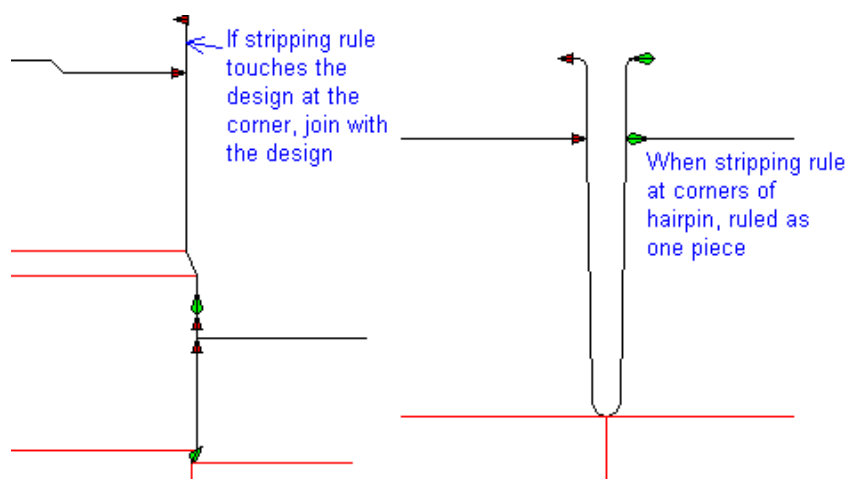

Delete Rule Path tool

 The second button on the Build/Delete/Add Rule Path flyout toolbar activates the **Delete Rule Path** tool. When clicked, you are asked to confirm the deletion of the layer and its contents:

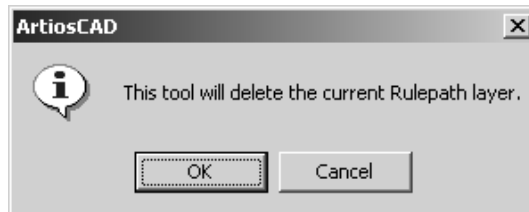

Click **OK** to delete the Rule Path layer and its contents, or click **Cancel** to keep the layer and its contents.

Add Rule Path tool

 The third tool on the Build/Delete/Add Rule Path flyout toolbar is the **Add Rule Path** tool. Use this tool when you have added lines to the layout after building the rule path layer and do not want to rebuild the entire layer. To use this tool, do the following:

1.  Use the **Select** tool on the Single Design Edit toolbar to select the lines to make into rule paths.
2.  Click **Add Rule Path**.
3. In the Rule Mapping dialog box, map the line type conversion for these new rule paths in the same way as when the layer is first built and click **OK**.
4. The Rule Path layer will be entered and the new rule paths created.

Select Rule Path tool

 The second button on the Rule Path toolbar activates the **Select Rule Path** tool. As its name implies, when the tool is active, click the mouse button to select a rule path. To select more than one rule path, hold down the CTRL or SHIFT key while clicking.

When you select a rotary rule path, ArtiosCAD shows the teeth, bridges, bridge start indicator, and end points of the rule path as shown in the following diagram.



A flat rule path only shows bridges and the start and end of the rule path.

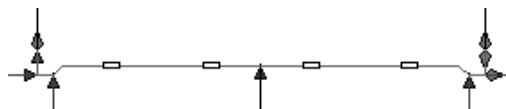

Right-clicking a rule path once stops the current tool and activates the **Select Rule Path** tool. Right-clicking a rule patch twice activates a context menu as shown below:



The tools on this menu are also on the Rule Path toolbar, and are explained as the chapter progresses.

Changing rule path properties

To change the special rule type a rule path is based upon, or to rebridge a rule path, do one of the following:

- Activate the **Select Rule Path** tool and double-click the rule path(s) to change;

- Activate the **Select Rule Path** tool and select the rule path(s) to change and press ALT-Enter;
- Activate the **Select Rule Path** tool, select the rule path(s) to change, and click **Edit > Properties**.

Note: Do not change the properties of a rule path by using the **Select** tool to make a multiple selection of it along with other types of manufacturing elements. The Properties dialog box will show **Can not display properties for mixed selection of rule path and other items** instead of properties for the selected items.

The Properties dialog box will appear. Rules with teeth have different properties than rules without teeth.

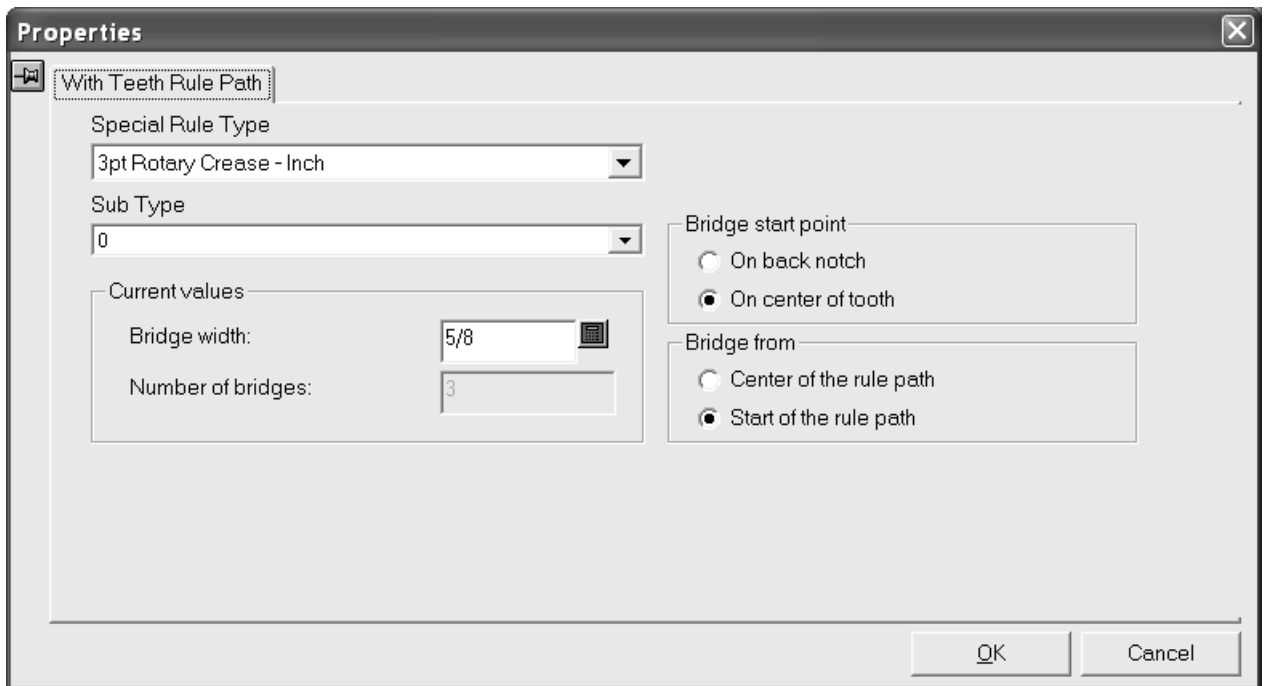

Clicking the drop-down list activator arrow in the **Special Rule Type** field displays a list of available special rule types. Click the new special rule type for the rule path. If you select a special rule type which does not have a teeth bridging formula defined, the dialog box will change to the Without Teeth Rule Path Properties dialog box shown on the next page.

Clicking the drop-down list activator arrow in the **Sub Type** field displays a list of available subtypes. If desired, choose a subtype for the rule.

The options in the **Bridge start point** group control the position of the start of the bridge in the direction of the rule. When this option is changed, the bridges on the rule path are moved by half a tooth.

The options in the **Bridge from** group controls the position at which bridging starts. When this option is changed, the bridge start position is moved and the rule path is rebridged. This option applies only to rule paths without slots.

To change the bridge width on the selected rule(s), enter a new value in the **Bridge width:** field. If the bridge width is changed to zero and then another value, the rule path is rebridged and the bridge start point will be set according to the default bridging formula for that special rule type.

The number of bridges on a rule with teeth cannot be changed manually.

When a special rule type without teeth is selected, the Without Teeth Rule Path Properties dialog box is shown:

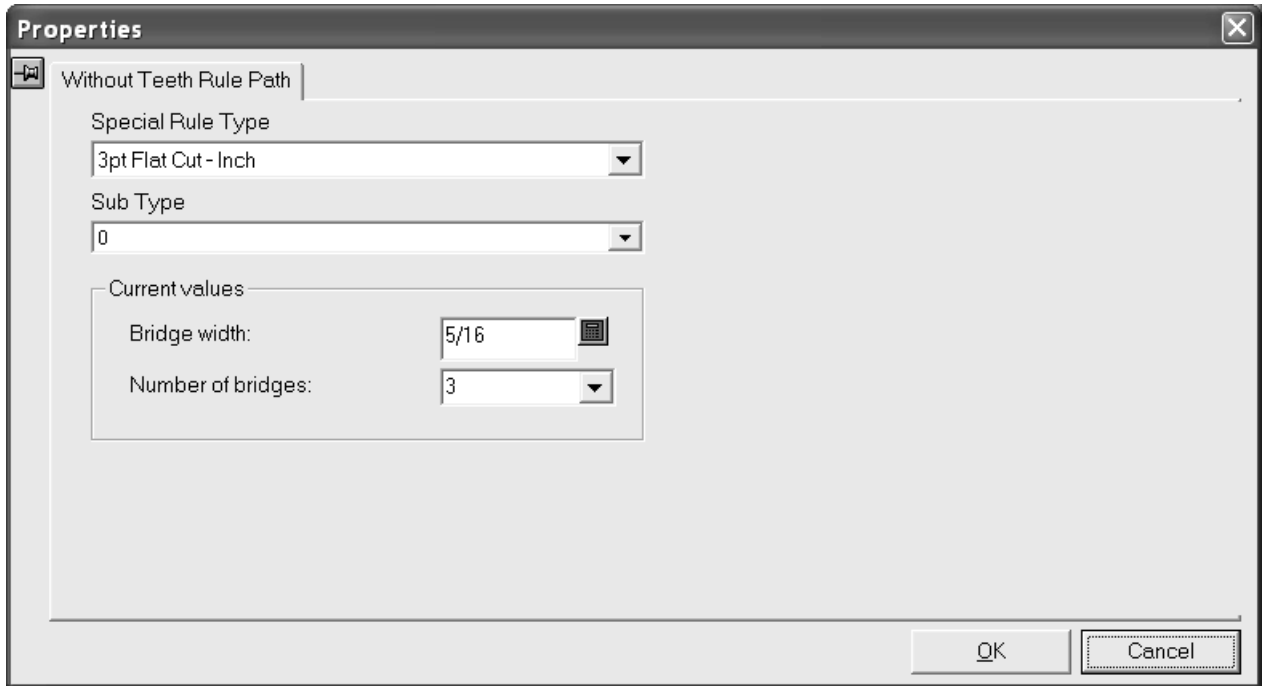

Clicking the drop-down list activator arrow in the **Special Rule Type** field displays a list of available special rule types. Click the new special rule type for the rule path. If you choose a rule which has a teeth bridging formula defined, the dialog box will change to the With Teeth Rule Path Properties dialog box shown previously.

Clicking the drop-down list activator arrow in the **Sub Type** field displays a list of available subtypes. If desired, choose a subtype for the rule.

Change the bridge width and number of bridges by changing the values in the **Current values** group. If the number of bridges is set to zero, the bridge width is also set to zero. If you change the number of bridges to zero and then to some other number, the bridge width is calculated from the default formula for that special rule type, and the new bridge width is displayed in the **Bridge width:** field. If the bridge width is changed to zero and then to some other number, the number of bridges is set to one and the new bridge will be placed in the middle of the longest line in the rule path.

Click **OK** to make the changes indicated in the Properties dialog box, or click **Cancel** to discard them.

Split Rule Path tool

 The third button on the Rule Path toolbar activates the **Split Rule Path** tool. It is also on the Select Rule Path tool context menu. When this tool is activated, it displays the following controls on the Status bar.

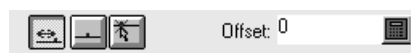

The first button, **Offset**, splits the rule at the nearest start/end point of the rule path with the offset specified in the **Offset:** field. **Center**, the second button, splits the selected rule path at its center. The third button, **Anywhere**, splits the rule at the nearest coordinate to the mouse click.

Choose a placement method and then click the rule to split.

Shown below is a rule path before and after being split at its center.



Join Rule Path tool



The fourth button on the Rule Path toolbar activates the **Join Rule Path** tool. It is also available on the context menu of the Select Rule Path tool. To use it, click it, indicate the first rule path to join, and then indicate the second rule path to join. The lines on which the rule paths are based must share an endpoint. The resulting rule path will be the same special rule type as the first path selected.

Only rule paths in the same section of the dieboard can be joined. Rule paths can not be joined across dieboard splits.

Move Bridge Start Point tool



The fifth button on the Rule Path toolbar activates the **Move Bridge Start Point** tool, and when held down, activates a flyout toolbar containing this tool and the **Reverse Rule Path** tool.



The **Move Bridge Start Point** tool moves the start point of the bridging on the rule path. To use it, click it, select the rule path to modify, and then drag the start marker to its new position.

Changing the bridge start point will automatically cause ArtiosCAD to rebridge the rule path using the rule path's bridging formula defined in Defaults.

Reverse Rule Path tool



The second button on the flyout toolbar activates the **Reverse Rule Path** tool. This tool exchanges the start of the rule path with the end of the rule path. This will also change the current bridge start point from one end of the rule path to the other if the special rule path is defined to not start bridging at the center of the rule path.

Only rotary rule paths can be reversed.

Move Bridge Start Point to Center tool



The sixth button on the Rule Path toolbar activates the **Move Bridge Start Point to Center** tool. To use this tool, click it, and then click the rule path to change. It is intended to be used on rules with teeth; if you select a rule without teeth, **Bridge start point is not defined** appears in the Status bar and the tool continues to operate until you choose a rule with teeth or another tool.

Change Wrap Point tool



The seventh button on the Rule Path toolbar activates the **Change Wrap Point** tool. It is also available on the context menu for the Select Rule Path tool. This tool moves the wrap point, which is the junction between flat rule and rotary rule.

To use this tool, do the following:

1.  Click the **Change Wrap Point** tool.
2. Click the wrap point to move. When three or more rule paths meet, you can select the wrap point either by a single click on the wrap point or by clicking each rule path separately. Shown below is a selected wrap point centered on the suggested wrap margin, with another suggested point on the other side of the corner.



3. There will be drag markers of new snap positions shown at the wrap distance before and after each bend in the rule.

If the bridge start point is the same as the current wrap position, the bridge start point will move with the wrap point. If the bridge start point is not at the wrap point, suggested snap positions are shown for each back notch position measured from the bridge start position.

Move the drag of the wrap point to the new position.

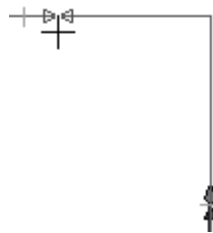

4. Click the mouse to set the position of the new wrap point.



You can also use this tool to move the start point of a looping rule path without changing the bridge starting point.

Add Bridge on Rule Path tool

 The eighth button on the Rule Path toolbar activates the **Add Bridge on Rule Path** tool, and when held down, activates a flyout toolbar containing it, the **Re-bridge Rule Path Layer** tool, and the **Add Mark to Rule Path** tool.



To use this tool, click it and then click the position for the new bridge. The rule path will be selected and the new bridge will appear. Click another position along the rule path to add another bridge.

If a rule path needs to have bridges of different widths on it, that rule path must be split first, and bridge width changed on each piece of rule separately.

Re-bridge Rule Path Layer tool

 The second button on the flyout toolbar activates the **Re-bridge Rule Path Layer** tool.

When you click this tool, ArtiosCAD displays a warning dialog box:

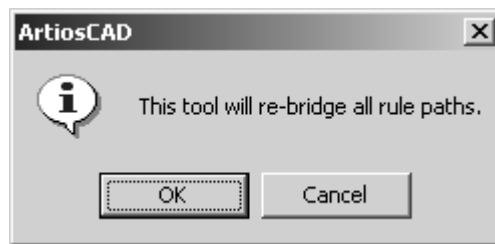

Clicking **OK** deletes all the bridges and re-bridges the rules according to their bridging formulae configured in Defaults. Clicking **Cancel** returns you to Manufacturing.

Add Mark to Rule Path tool

 The third button on the flyout toolbar activates the **Add Mark to Rule Path** tool. This tool adds a mark to a rule path and snaps to any of these points: the rule path start position, the bridge start position, and back notch positions. Marks are added as grouped lines and can be selected by the **Select** tool.

To use this tool, do the following:

1.  Click the **Add Mark to Rule Path** tool.
2. Select the shape of the rule mark to add by clicking its button on the Status bar. You can change the size of the mark about to be added in the **Mark length:** field.



3. Click the rule to which the mark will be added.
4. Drag the mouse to position the mark as desired. If the marker is not symmetrical, it is drawn on the same side of the line as the cursor. Click the point at which to add the marker.

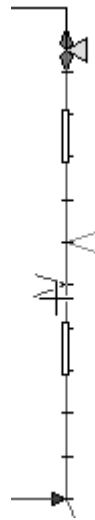

5. To continue adding marks, repeat steps 3 and 4.

To change the mark length for new marks when not using the tool, change the **Mark length:** field in the Rule Path Parameters dialog box on the Options menu in Manufacturing.

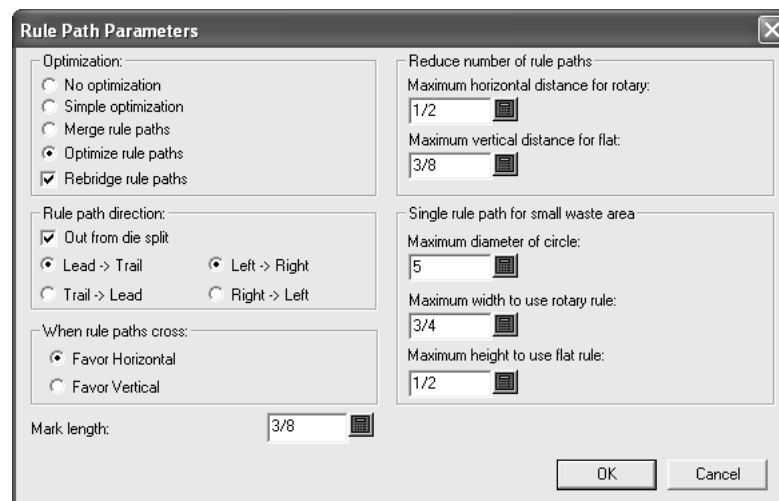

To change the default mark length, change the **Mark length:** field in the Rule Path Params section of the Manufacturing parameter set.

Delete Bridge on Rule Path tool



The ninth button on the Rule Path toolbar activates the **Delete Bridge on Rule Path** tool. The viewing of bridges is automatically turned on when this tool is activated.

To delete a bridge, select it with the Select Rule Path tool, then click the **Delete Bridge on Rule Path** tool and click the bridge to delete. Click the **Select Rule Path** tool again, select the rule, and note that the bridge is gone.

Move Bridge on Rule Path tool

 The tenth button on the Rule Path toolbar activates the **Move Bridge on Rule Path** tool, and when held down, activates a flyout toolbar containing it and the **Align Bridge on Rule Path** tool.

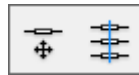

The viewing of bridges is automatically turned on when this tool is activated. To use the **Move Bridge on Rule Path** tool, click it, then click and drag the desired bridge to its new position.





This tool can also add and delete bridges. To add a bridge, click a bridge and hold down CTRL while dragging it. To delete a bridge, click it and press Delete on the keyboard.

Align Bridge on Rule Path tool



The second button on the Bridge Position flyout toolbar activates the **Align Bridge on Rule Path** tool. This tool aligns bridges either horizontally or vertically with bridges in other rule paths. Aligning bridges is made much easier by turning bridges on in the View Mode dialog box

To use this tool, click it, indicate the bridge to align others with (called the **anchor bridge**), and then indicate the other bridges.

DieSaw / Leader Hole Tools toolbar

The DieSaw / Leader Holes Toolbar contains tools for making leader holes. Leader holes are used by the DieSaw when it is sawing a dieboard, upper stripping board, or lower stripping board. The toolbar is shown below.



Leader hole creation is configured in the Kongsberg DieSaw group on the Processing page in an Output definition. The physical tool they are created with is configured in the CAM Tooling Setup Catalog.

Note: If you are outputting to a DieSaw and you have not made any leader holes yourself (for example, if you know you will not need to adjust them), they are created automatically during the output procedure and deleted when the output is done.

Generate Leader Holes tool

 The first tool on the DieSaw / Leader Hole Tools toolbar activates the **Generate Leader Holes** tool. This tool automatically generates leader holes. After you click **Generate Leader Holes**, ArtiosCAD will prompt you to select an Output so that it can read the leader hole parameters stored in the Output definition. Only those Outputs configured to generate leader holes are listed. Select an Output and click **OK** to proceed, or click **Cancel** to cancel.

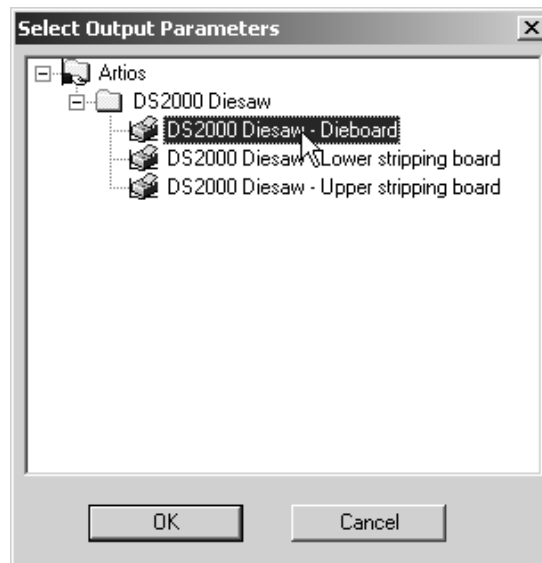

Once you click **OK**, ArtiosCAD changes to the layer specified on the View tab of the Output definition (Dieboard, Upper stripping board, or Lower stripping board), creates a DieSaw sublayer, copies the contents of the appropriate layer to the DieSaw sublayer and changes them to the appropriate Manufacturing-class line types, and creates leader holes in that sublayer. The lines created are in the Manufacturing category of the plotting style. Shown below is a magnified view of a dieboard with leader holes.

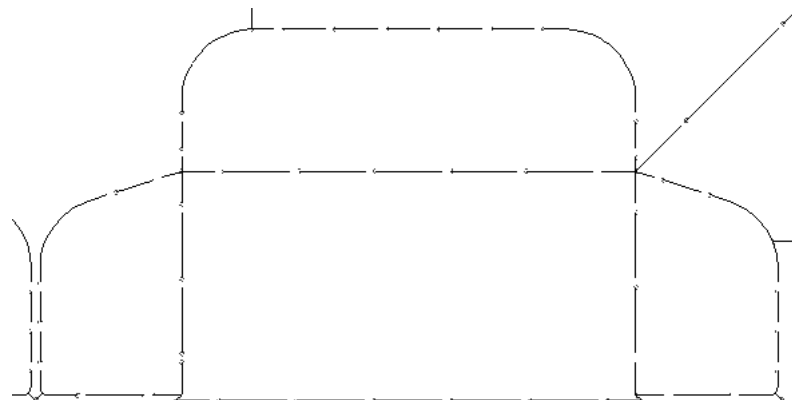

Leader Hole error checking

ArtiosCAD performs a series of checks on the structure of the manufacturing file before generating the leader holes. If there are problems, an error dialog box appears listing the error(s). Possible errors are:

- Drill hole is not a circle;
- Inside edge lines do not form a loop;
- Outside edge lines do not form a loop;
- Mill outline does not form a loop;
- Cannot offset inside edge lines;
- Cannot offset outside edge lines;
- Cannot offset mill outline;
- Cannot offset side bevel lines;
- DieSaw output with no SAW tools defined;
- Die split lines do not connect to the dieboard edge;
- Saw lines have no leader hole;
- Enveloped corner with saw not recommended;
- Lines enveloped with saw.

In the Output Processing Errors dialog box, you can choose to view the problem and not generate the leader holes by clicking **Show Selected Error**, or ignore the problems and generate the leader holes anyway. Clicking **Ignore** causes the offending lines to not be included in the layer, so use this option carefully.

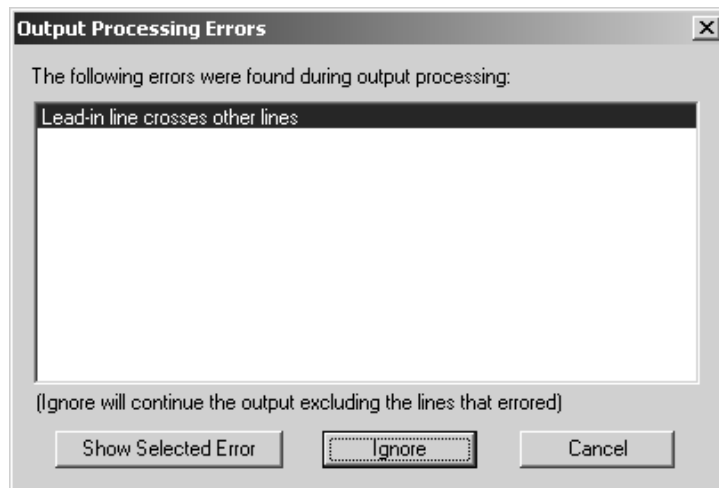

If you have already generated leader holes in this manufacturing file, you will be prompted to overwrite the existing ones. To overwrite the existing holes, click **Yes**; any manual changes you made to the leader holes will be lost if you click **Yes**. Clicking **No** initiates no changes.

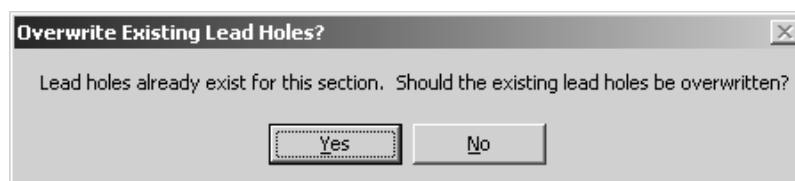

Add Leader Hole tool

 The second button on the DieSaw / Leader Hole Tools toolbar activates the **Add Leader Hole** tool. To add a leader hole, click the tool, and then click the location of the desired leader hole.

If the location clicked is within the snap distance of an end point of a rule, the leader hole snaps to the end point; otherwise, the cursor changes to a cross-hair and you have to drag along the rule to set the position of the leader hole as shown in the picture below. Drag away from the rule to create a lead-in line.

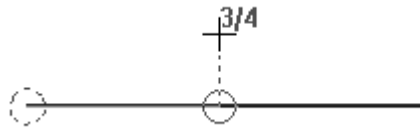

Note: No checks are performed when adding leader holes manually to ensure that they do not interfere with each other.

Delete Leader Hole tool

 The third button on the DieSaw / Leader Hole Tools toolbar activates the **Delete Leader Hole** tool. To delete a leader hole, click the tool, and then select the leader hole to delete.

All rules that used the deleted leader hole will be reversed and a leader hole will be added at the other end if needed.

If the deleted leader hole had a lead-in line, the lead-in line will be deleted as well.

Reverse Cut tool

 The fourth button on the DieSaw / Leader Hole Tools toolbar activates the **Reverse Cut** tool. This tool reverses the sawing direction of the rule and moves the leader hole to the other end of the rule.

If the rule segment shares a leader hole with another rule segment, the leader hole will move to the other end of the selected rule segment and the shared leader hole will be kept.

If the leader hole for the segment uses a lead-in line, the rule segment will reverse and add a leader hole at the opposite end from the current leader hole and not include a lead-in line.

Delete DieSaw Layer tool

 The fifth button on the DieSaw / Leader Hole Tools toolbar activates the **Delete DieSaw Layer** tool. When clicked, this tool will ask for confirmation, and if you click **OK**, it will delete the contents of the DieSaw layer. If you click **Cancel**, nothing will happen.

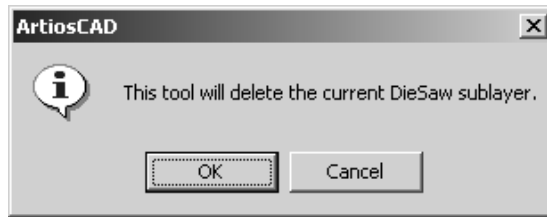

Notes on Leader Holes

If there is a milling area at the intersection of lines which would otherwise share a leader hole, the rules are reversed so that each line has an individual leader hole and cuts into the area that is milled.

Dieboard Split tools

The Dieboard Split tools are on the Dieboard toolbar. They are active only when the **Dieboard** layer is the current layer.

Horizontal Split tool

 The ninth button on the Dieboard toolbar activates the **Horizontal Split** tool, and when held down activates the Dieboard Split Tools flyout toolbar.



To add a horizontal split, click the tool, drag the ghost split to the desired position, and click to set it in place. Tack bridges are created on the lines forming the split.

The options on the Status bar will let you choose either the Top or the Bottom edge of the die to measure the **Offset** from. The **Angle** refers to the angle **through the center of the cylinder** that this split creates.

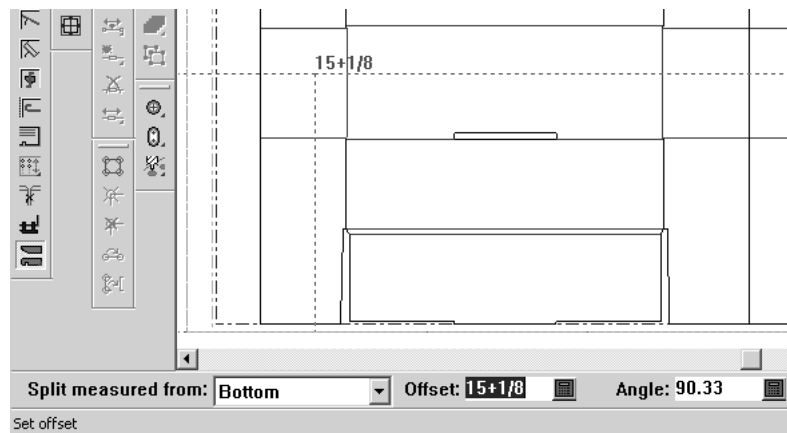

Vertical Split tool

 The second button on the Dieboard Split Tools flyout toolbar activates the **Vertical Split** tool. This tool works similarly to the Horizontal Split tool except the split is measured from the left or right side of the die depending on the selection in the Status bar. Tack bridges are created on the lines forming the splits.

Vertical splits are not at an angle, so no angle is displayed.

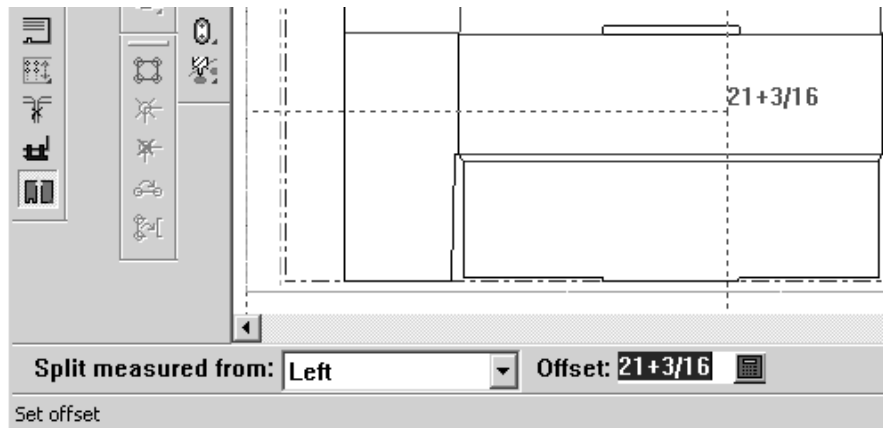

Delete Split tool

 The third button on the Dieboard Split Tools flyout toolbar activates the **Delete Split** tool. When clicked, this tool asks for confirmation, and if OK is clicked, it deletes the contents of the Die Splits sublayer. Click **Cancel** to keep any dieboard splits.

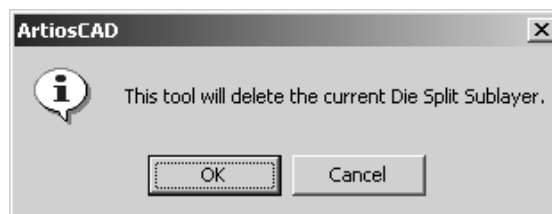

Registration Hole Tools toolbar

The **Registration Hole Tools** toolbar contains the tools necessary for adding holes to the workspace.



Add Hole tool

 The first button on the Registration Holes toolbar activates the **Add Hole** tool, and when held down, activates the Add Holes flyout toolbar.



To add a hole, click **Add Hole**. The Status bar will change to show hole creation options.



Choose the type of general hole to add from the drop-down list box. Click More options (...) to invoke the Properties dialog box for the hole, where you can modify the hole parameters before adding it.

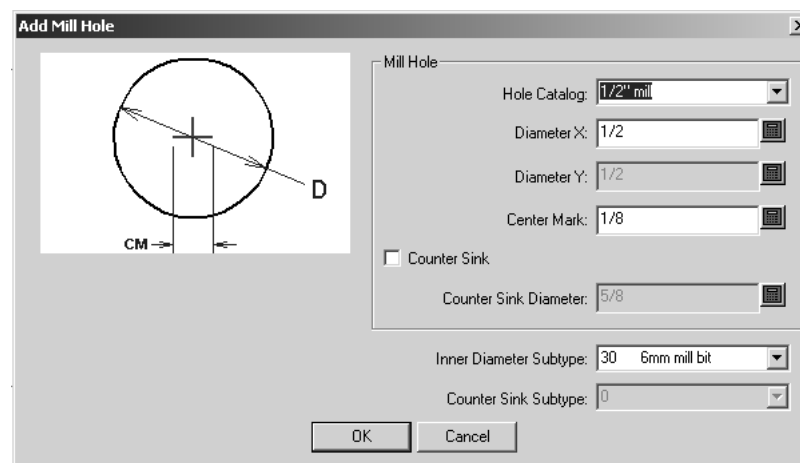

When you are done modifying the properties for the hole, click **OK** to save the changes and return to Manufacturing, or click **Cancel** to discard the changes and return to Manufacturing. To set the position of the hole, click at the desired location. The tool repeats until you click **OK** or select another tool.

Add Countersunk Hole tool

 The second button on the Add Holes flyout toolbar activates the **Add Countersunk Hole** tool. This tool works in the same fashion as the Add Holes tool except it adds holes which are defined as countersunk. Select the type of hole to add from the drop-down list box on the Status bar, modify its properties if necessary by clicking the More options (...) button, click the

locations at which to place a hole, and click **OK** to end the tool. Shown below is the Properties dialog box for an example countersunk hole.

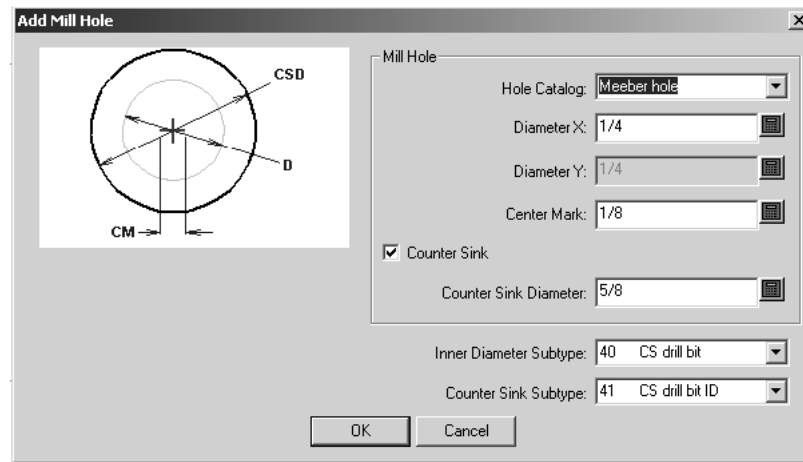

Add Oblong Hole tool

 The second button on the Registration Hole Tools toolbar activates the **Add Oblong** Hole tool, and when held down, activates the Add Oblong Holes flyout toolbar.



This tool adds a non-circular hole to the workspace. It works the same way as the other hole tools except you can specify different X and Y diameters for the hole diameter.

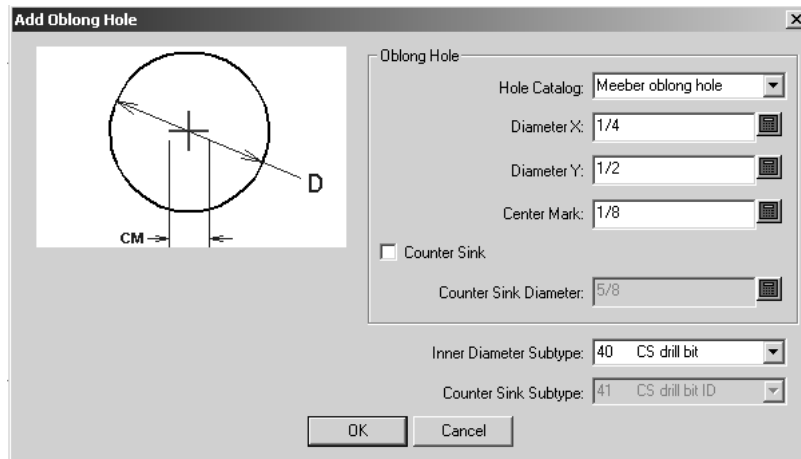

Add Countersunk Oblong Hole tool

 The second button on the Add Oblong Holes flyout toolbar activates the **Add Countersunk Oblong Hole** tool. Its method of operation is similar to the other Add Hole tools, except that it is countersunk.

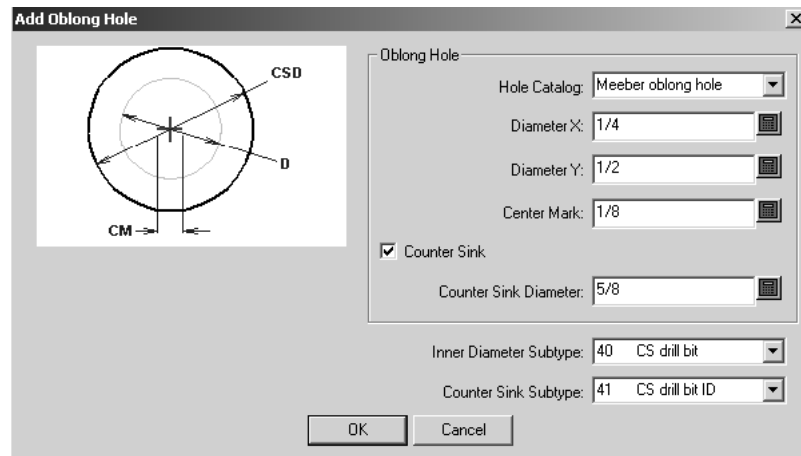

Add Drill Hole tool

 The third button on the Registration Hole Tools toolbar activates the **Add Drill Hole** tool, and when held down activates the Add Drill Hole Tools flyout toolbar.



This tool works the same as the other hole tools, except on its Properties page, you can only change the type of hole being made. No other configuration options are available when adding the hole.

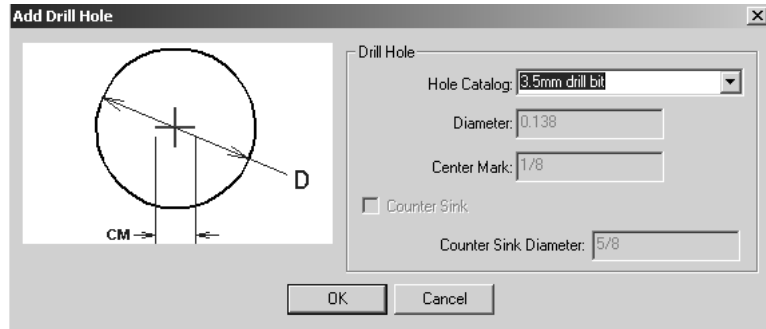

Add Countersunk Drill Hole tool

 The second button on the Add Drill Hole tools flyout toolbar activates the **Add Countersunk Drill Hole** tool. Its mode of operation is the same as for the Add Drill Hole tool. Using the **Hole Catalog** drop-down list box, only the type of hole being made can be changed on its Properties page; the **Diameter**, **Center Mark**, **Countersink checkbox**, and **Counter Sink Diameter** fields are unavailable.

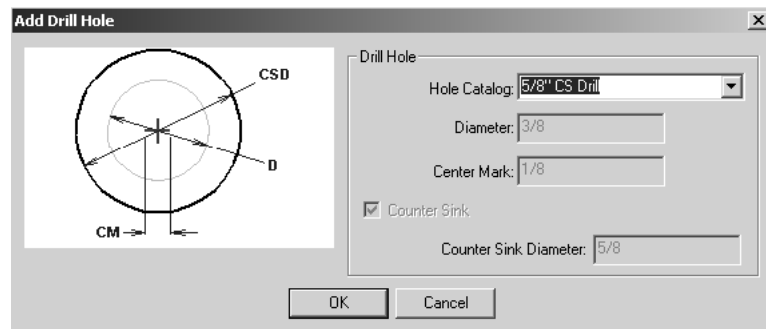

Rotary Diemaking Workflow

This is a flowchart of a possible workflow, followed by a step-by-step explanation using the tools described earlier in the chapter.

Rotary Diemaking Workflow

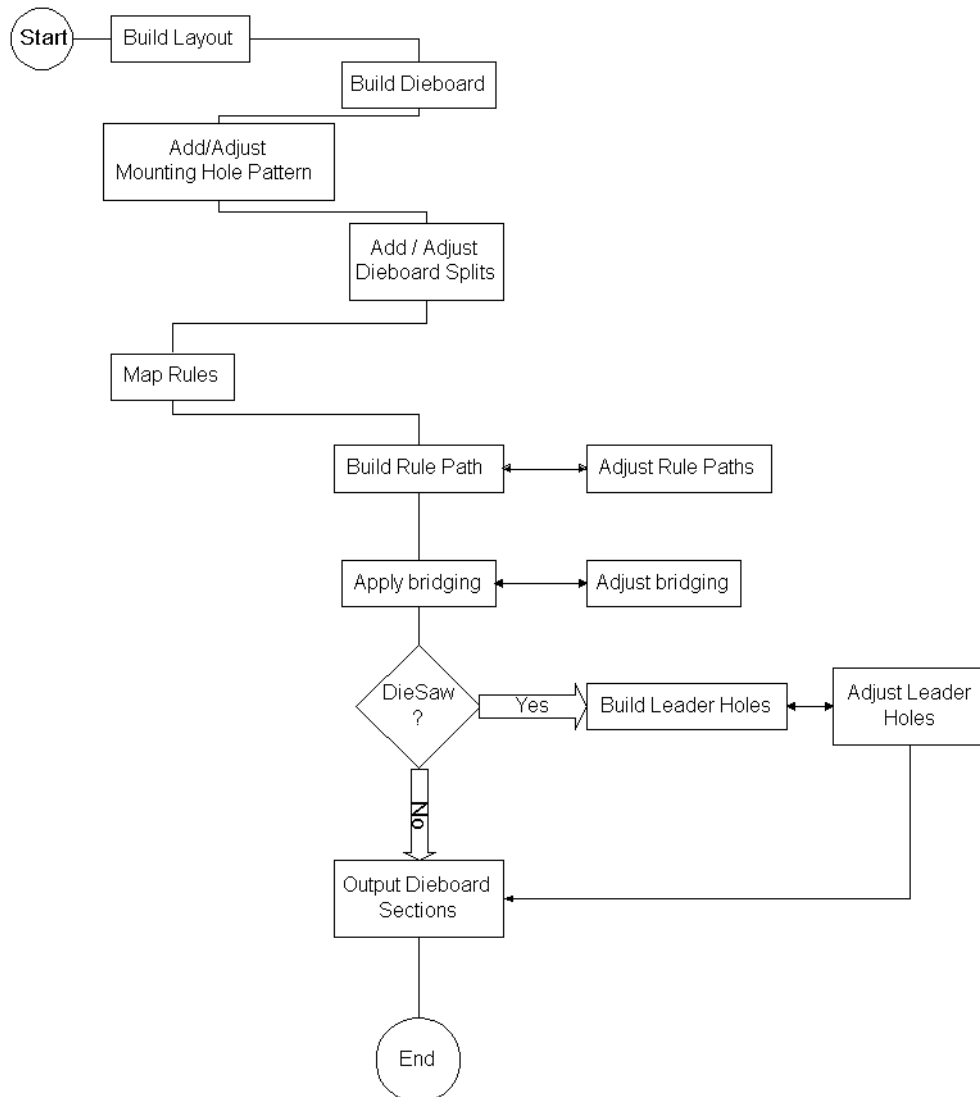

1. Design and save the single design(s) to include in the manufacturing file.
2. Create the manufacturing file and arrange the designs as desired.
3. Create the dieboard and stripping rules.
4. Add the mounting holes and adjust if necessary.
5. Add the dieboard splits and adjust if necessary.
6. Map the flat rules to rotary rules.
7. Build the rule path and adjust if necessary.
8. Apply the bridging and adjust if necessary.
9. Is the dieboard being made with a DieSaw? If so, build the leader holes and adjust them if necessary.

10. Output the dieboard sections.

Prerequisites

To follow the sample workflow, ArtiosCAD must have the following Defaults defined:

- A Bridging On Teeth formula set up and saved;
- Rotary rules created and saved in the Special Rules Catalog;
- A rotary press defined;
- A dieboard which uses an alignment method other than notch;
- Sheet allowances on side-to-side, but 0 on front-to-back;
- An Output defined for rotary dieboards, which on the View tab has the Rule Path layer being output at the Wood level;
- A Mounting Hole Pattern (MHP) defined.

Most of these defaults have example entries. Copy the examples and modify them with your specific information.

Using Layers

When you change layers, the active tool stops and no new tool starts. This prevents putting elements in the wrong layer.

The layers that are displayed when a manufacturing file is opened depends on the setting in **Options > Defaults > Shared Defaults > Design Defaults > Default View Mode**. You can choose to display the layers as they were when the manufacturing file was saved, or you can choose to always display the same set of layers.

Default layers in Manufacturing

You can specify layers that will be created in new manufacturing files and in existing manufacturing files when they are opened. See the *Defaults* chapter for more information.

Move to Layer tool

 The **Move to Layer** tool in Manufacturing works similarly to its namesake in Single Design, but it offers greater functionality as objects can be moved into layers within included designs as well as layers in the manufacturing file.

To use this tool, select the object(s) to move to another layer using the Select tool on the Single Design Edit toolbar, and click the tool, located on the Move tools flyout toolbar on the Single Design Edit toolbar. The enhanced Move To Layer dialog box will appear similar to the one shown below.

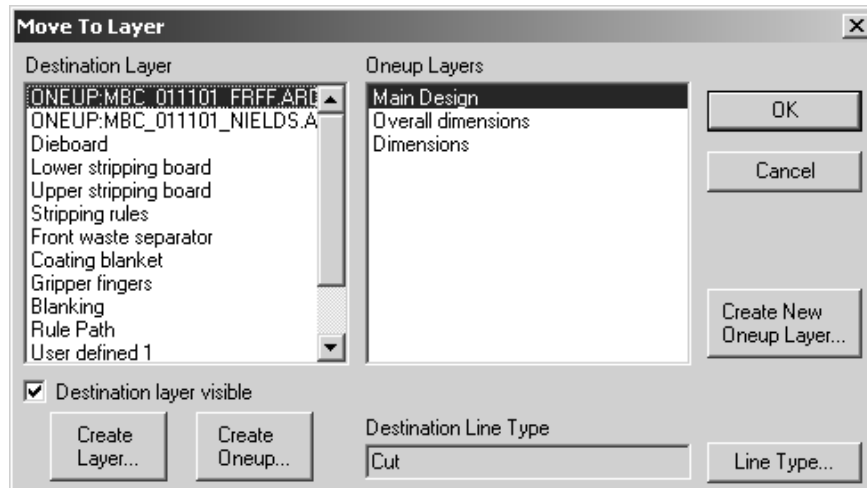

Only unlocked layers are listed.

To move the objects into a different layer of the manufacturing file, pick the layer in the **Destination Layer** pane, and then pick the sub-layer in the right pane. To create a new layer in the manufacturing file, click **Create Layer**, enter the name for the layer in the resultant field, and click **OK**.

To move the object(s) into an existing single design embedded in the manufacturing file, select the single design in the left pane (its name will be preceded by the word ONEUP), and then select the desired layer of the selected single design in the right pane. Click **OK** to perform the move.

To create a new embedded single design in the manufacturing file, click **Create Oneup**, enter its name, and click **OK**. The new single design will appear in the list of destination layers. You can then select it and create new layers in it if desired.

To create a new layer in the single design, click **Create New Oneup Layer**, name the layer, select its class, and click **OK**.

The **Destination layer visible** checkbox turns the selected layer in the ArtiosCAD window on or off while the Move To Layer dialog box is open.

The line type that the selected object(s) will be changed to upon moving is shown in the **Destination Line Type**: field. Clicking **Line Type** lets you change the destination line type. If more than one item is selected, and they are all the same type, that type will be shown in this field. If they are of different types, UNCHANGED is shown.

When the selected Destination Layer is a manufacturing element, the Destination Line Type shown is the default line type for that element, and the Line Type button is unavailable. For example, when the Destination Layer is the **Dieboard** and the Manufacturing Element is **Hand hold**, the **Destination Line Type** is **Die registration hole** and the Line Type button is unavailable.

When moving items, if an entire group is being moved, it will remain a group after the move. If only part of a group is moved, those items will be removed from the original group and ungrouped when moved. The rest of the original group will remain a group.

Clicking **Cancel** dismisses the dialog box and does not move the selected items. However, any layers or single designs that have been created using **Create Layer**, **Create Oneup**, or **Create New Oneup Layer** will remain.

Designer's Fix-It

Designer's Fix-It is a tool on the **Manufacturing** menu in Manufacturing and the **Design** menu in Single Design. It cleans up and reorganizes geometric data imported into ArtiosCAD from other sources.

Designs may look fine on the surface, but errors called *anomalies* can lurk below and ruin a resultant tooling set and production run.

The general workflow is to import the data, use the **Move To Layer** tool to create single designs out of the oneup data, open those embedded designs and run Designer's Fix-It, and then run Designer's Fix-It in Manufacturing to clean up the non-embedded-design data.

When you start Designer's Fix-It, a toolbar appears to the right of the drawing area.

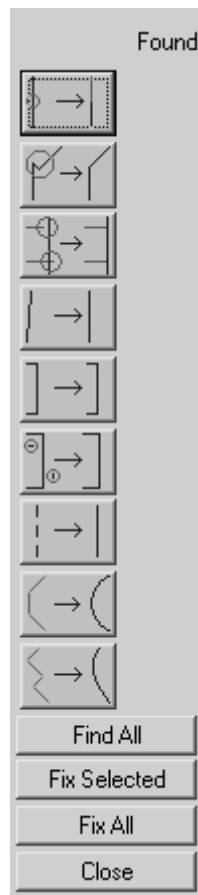

Clicking an icon on the toolbar invokes the particular tool. If the tool finds no anomalies, a dash is displayed in the **Found** column. If the tool finds anomalies, the total is shown in the **Found** column, and the anomalies are highlighted in the workspace.

To find all anomalies at once, click **Find All**.

Anomalies which can be fixed are dark blue when the screen background is light, and light blue when the screen background is dark. Anomalies which cannot be automatically fixed are light blue when the screen background is light and dark blue when the screen background is dark.

To select an anomaly, click it; to select more than one, hold down SHIFT and click the individual anomalies, or hold down CTRL and use a selection window. Selected anomalies will turn magenta.

To fix the selected anomalies, click **Fix Selected**. To fix all the anomalies, click **Fix All**.

Some of the tools in Designer's Fix-It have parameters which appear in the Status bar. These parameters let you adjust what is an anomaly and what is not.

Note: The tools in Designer's Fix-It do not search for anomalies in any of the Graphics layers. Also, the tools work on lines and arcs only; if there are beziers in the workspace, select them all and convert beziers to arcs as desired using **Tools > Adjust Outline > Change Beziers to Arcs** in Single Design. Using Designer's Fix-It in an existing ArtiosCAD workspace disables StyleMaker. You will be prompted to save the design before proceeding, disable rebuild and proceed without saving, or to exit from the selected feature.

Tool descriptions and uses

Split Lines tool

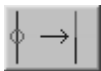

Split lines. These are lines that intersect other lines at points not at the end of the line. When you click the icon, the tool intersects each line in the workspace with every other line, and searches for intersections which are not at the end-points of lines. ArtiosCAD performs the intersections invisibly.

Shown below are intersections that do not occur at two end-points. However, these are acceptable anomalies based on the basic structure of the carton.

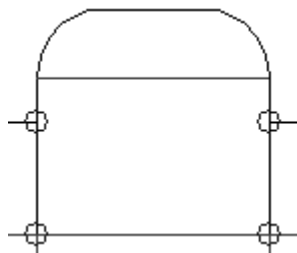

Merge Points tool

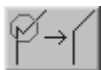

Merge Points. When multiple lines have end-points which are very close to each other, they should be combined into a common end-point. The direction and amount of moving of the multiple end-points into one end-point depends on the type of lines involved and the angle of the lines forming this anomaly. Horizontal and vertical lines take preference over non-horizontal and non-vertical lines, and creases take preference over cuts.

The **Merge Points** tool has one parameter: **Size**. The value in the **Size:** field on the Status bar sets the maximum gap between points for two points to be considered an anomaly.

Size: 0.25 

The design below may look normal:

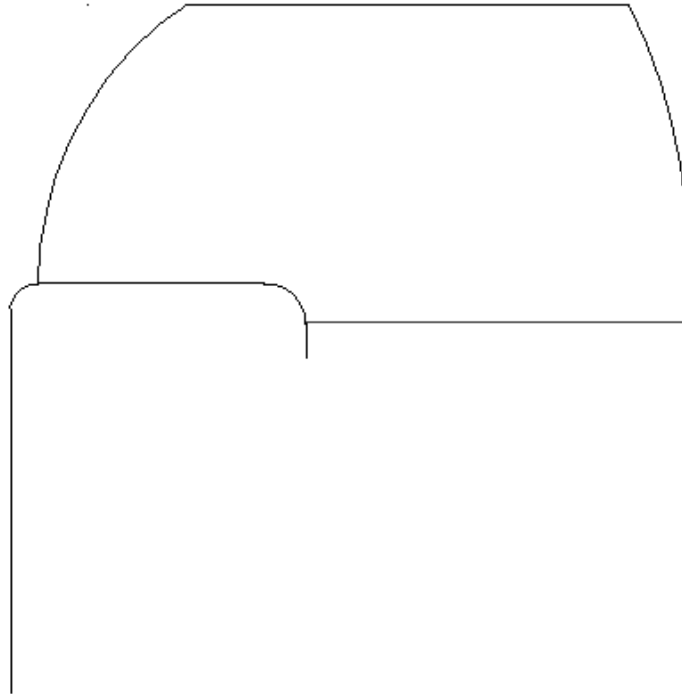

However, when the **Merge Points** tool is run, it finds these anomalies:

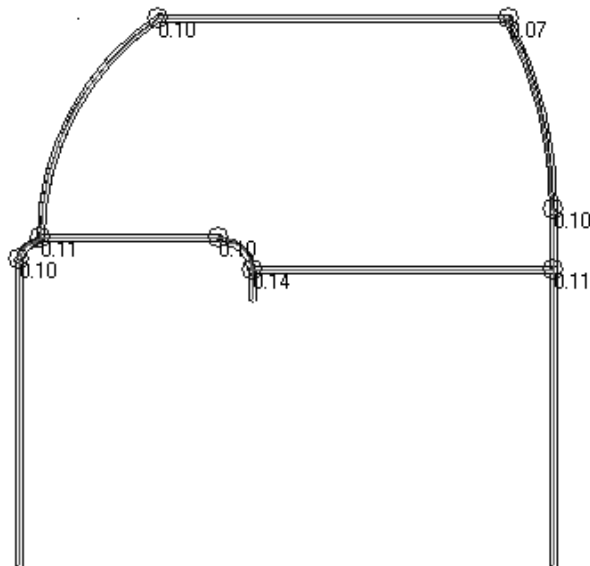

Every intersection in the design shown above is wrong. The numbers in the picture above are in millimeters; the gap at the top left intersection is one-tenth of a millimeter. When the point is zoomed in upon, it looks like this:

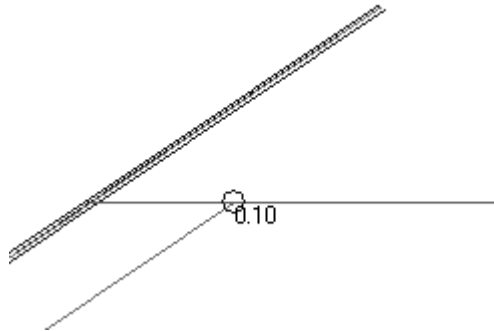

To fix these intersections, select them and click **Fix Selected**.

The anomaly shown above is shown fixed below.

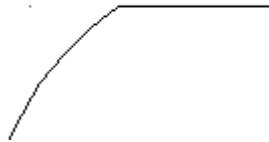

Overruns - Underruns tool



Overruns - Underruns. An **overrun** is when a line extends slightly beyond its intersection with another line. An **underrun** is when the endpoint of a line falls slightly short of causing its line to intersect with another line. Anomalies of this type are displayed with their size next to them.

This tool has two parameters - **Size** and **Minimum Angle**. **Size** sets the maximum distance between the end-point of a line and another line that is considered an anomaly; overruns or underruns larger than this value are ignored. **Minimum Angle** sets the minimum angle at which the two lines must intersect in order for them to be checked for overruns and underruns; if they intersect at an angle smaller than the value specified, any overrun or underrun is ignored.

The layout below, while appearing normal, has Overrun - Underrun anomalies in the stripping rules:

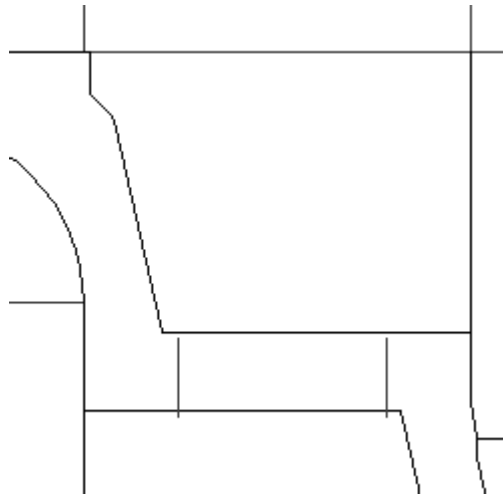

Clicking the **Overrun - Underrun** tool results in these anomalies being displayed:

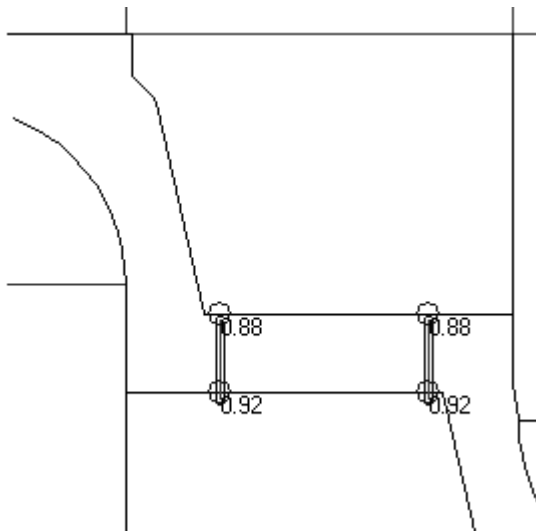

Nearly Horizontal or Vertical tool

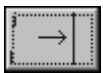

Nearly Horizontal or Vertical. This tool searches for lines which are nearly horizontal or vertical. The **Size:** parameter prompts for the minimum length of the line, and the **Maximum Angle:** parameter sets the largest angle of deviance from horizontal and vertical that the tool will find.

This tool only highlights anomalies - you must fix them manually by leaving Designer's Fix-It and using the Edit tools.

Shown below is what looks to be perfectly orthogonal geometry.

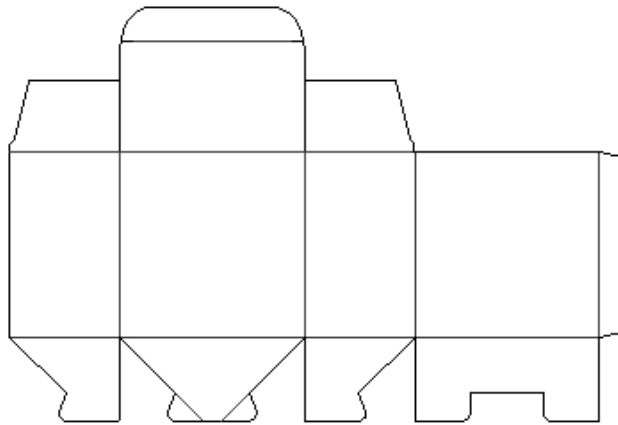

When the **Nearly Horizontal or Vertical** tool is run, however, anomalies are found:

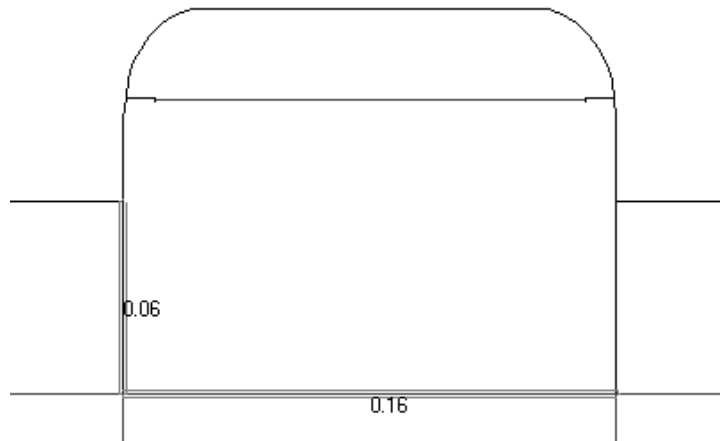

The anomalies are shown below with the aid of perfectly horizontal and vertical construction lines and the Measure tools. Use the Edit tools to fix them.

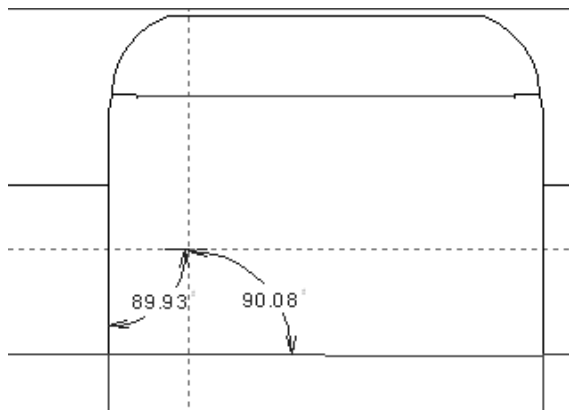

Double Knives tool



Double knives. This tool searches for lines that are either on top of each other or are separated by a tiny gap and nearly parallel. The **Size:** field sets the minimum length of lines to

be checked for duality and the **Maximum Angle:** field sets the maximum angle between lines to check against.

Shown below is a design with some Double Knife anomalies. The number indicates the distance between the double lines.

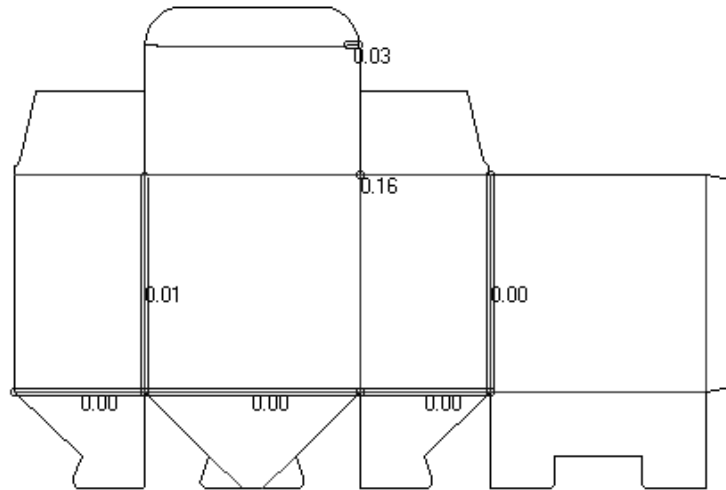

Fixing the double lines is an invisible process.

Short Lines tool

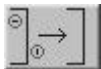

Short Lines. A Short Line anomaly occurs when a single line has both endpoints within the distance set by the **Size:** parameter. To be considered an anomaly, the short line cannot be connected to another line. Shown below is a design plotted using **Scale To Fit.**

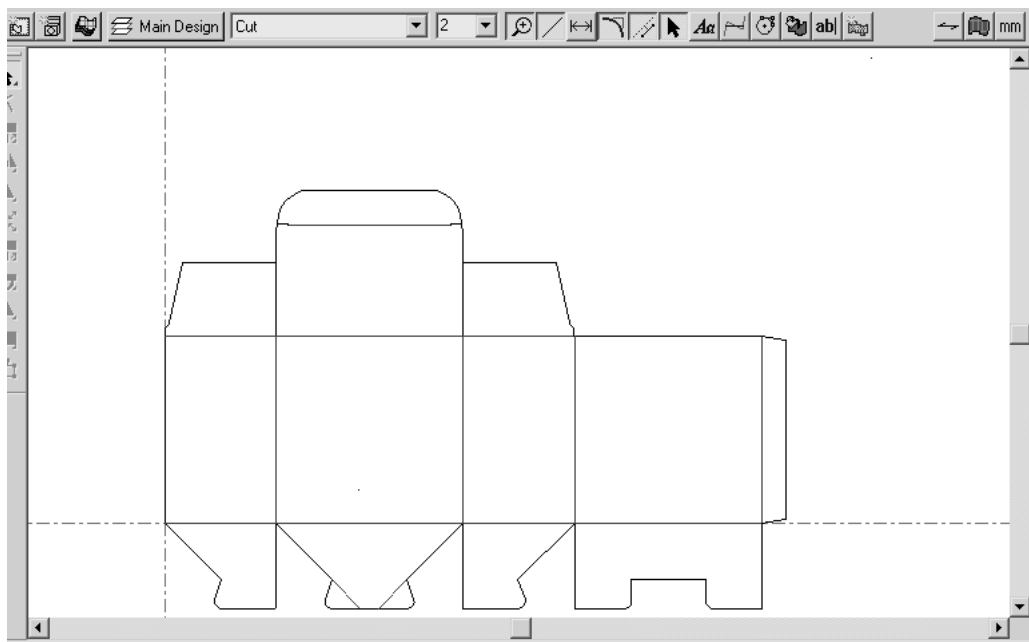

Note that even though Scale To Fit was used, the design does not fill the drawing area. Using the **Short Lines** tool reveals that there are two short lines.

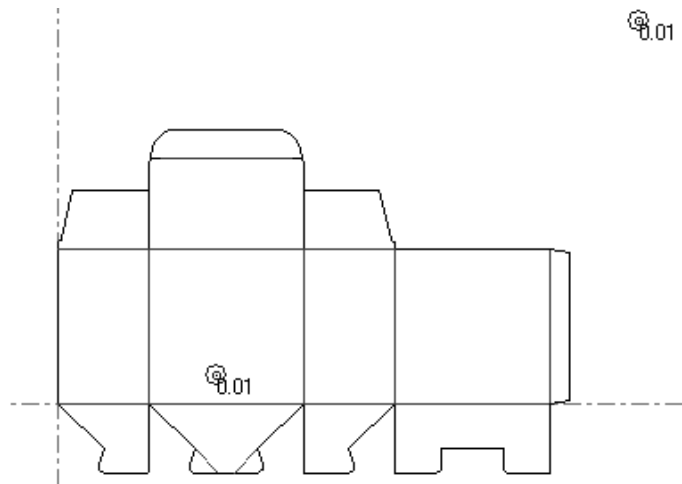

The number next to the anomaly indicates the size of the short line.

Line - Gap Sequence tool

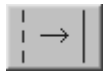

Line - Gap Sequence. This tool finds collinear sequences of lines and gaps that should be turned into one line with bridges. Shown below is a design with what looks like normal bridging.

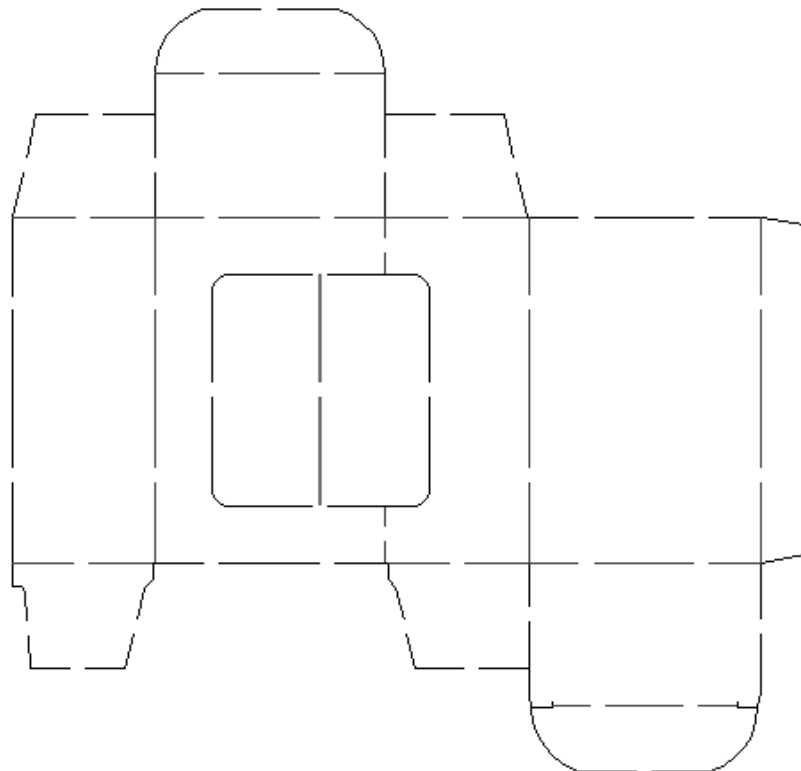

Using the **Line - Gap Sequence** tool reveals that nearly all of the lines and gaps could be converted into lines with bridges:

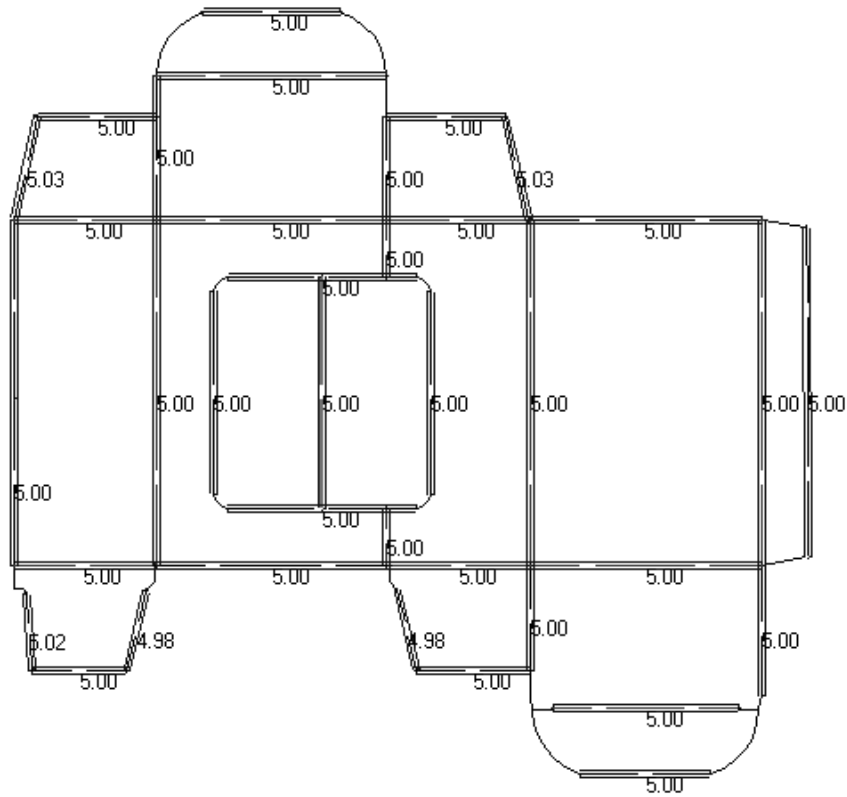

Magnifying the left most line of the sleeve body, one can see that there are actually two lines that can be combined into one if the **Width tolerance** and **Shift Tolerance** are adjusted accordingly. Also, the fact that the bridge width indicator is not centered on the line is a sure giveaway that there is more than one line present.

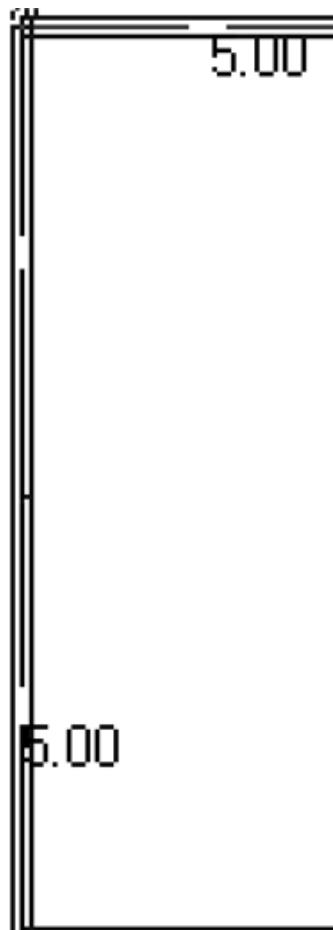

Three parameters on the Status bar control the size of gaps that are considered anomalies, and how those gaps can be manipulated to make one line.



The value in the **Size:** field sets the maximum size of individual lines and gaps to consider as anomalies.

The **Width Tolerance** lets the tool compare gap sizes. If the gap sizes are the same, plus or minus the Width Tolerance, then the gaps can be considered bridges in the new line.

The **Shift Tolerance** lets the tool move the gaps by up to the specified amount along the line to try to distribute them evenly so that they can be considered bridges.

The two parameters work together to let the tool make a bridged line out of a series of lines and gaps when there is a slight discrepancy in the size of the gaps and their positions relative to the line segments.

Clicking **Parameters** opens the Line-Gap to Bridge Parameters dialog box as shown below:



The **Width Rounding Value** rounds the size of the variously-sized gaps so they are exact fractions of the unit system being used.

The **Make All the Same Width** checkbox and the **Change All to Width** field instruct the tool to change all the gaps into bridges of the size specified.

The **Keep Present Bridges** checkbox instructs the tool to keep any defined bridges in the lines contained in the line-gap sequence.

The lines and gaps must be all in the same layer and the lines must be of the same line type for this tool to consider them anomalies.

Arc from Lines tool



The **Arc from Lines** tool converts a chain of line segments approximating an arc into an arc. The replacement arc's end-points are the same as those of the beginning and ending line segments.

The **Size:** parameter sets the maximum size of the line segments to be considered anomalies.

Note: This tool works with lines and arcs only. If the design contains beziers, you will be prompted to convert them to arcs or to cancel the tool. If the beziers are contained within an embedded design, they cannot be converted to arcs, and the **Smooth Lines** and **Arc from Lines** tools will be disabled.

Shown below is a corrugated box with a cutout in its lid.

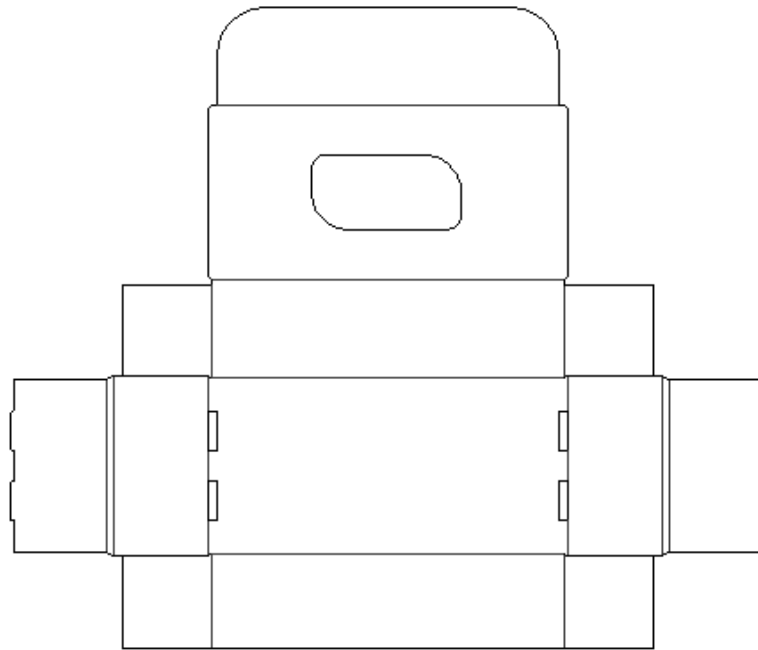

Using the **Arc from Lines** tool reveals that the cutout in the lid is not what it appears to be:

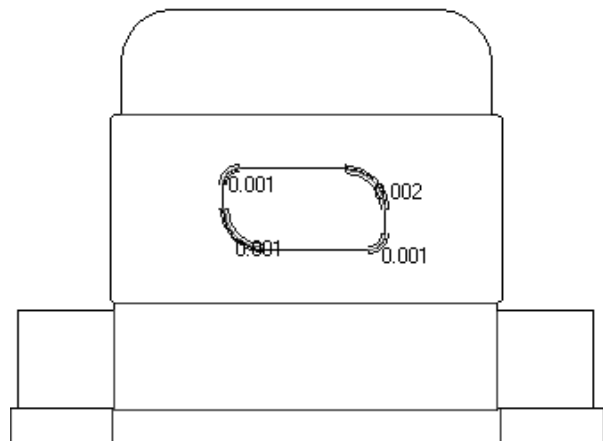

Magnifying an anomaly and using the Measure tool reveals a series of small lines:

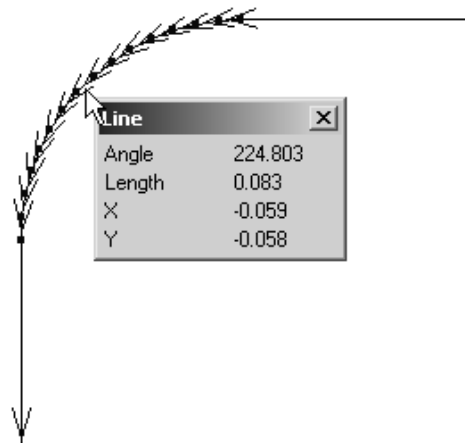

Fixing the anomaly results in a single arc.

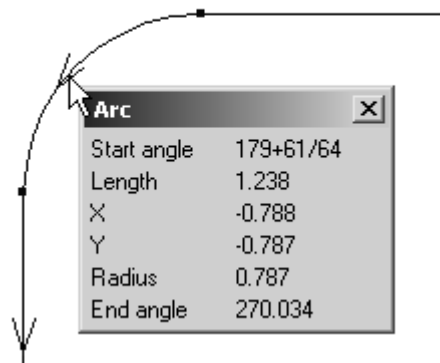

Smooth Lines tool



The **Smooth Lines** tool converts a chain of small connected line segments into a line or arc that best approximates the outline of the original lines. The chain of line segments must not branch or intersect with any other lines, must be in the same layer, and must be of the same line type.

The **Size**: parameter controls the size of the line segments considered anomalies. The **Smoothing Limit**: controls how far the new geometry will stray from the path of the original geometry.

Note: This tool works with lines and arcs only. If the design contains beziers, you will be prompted to convert them to arcs or to cancel the tool. If the beziers are contained within an embedded design, they cannot be converted to arcs, and the **Smooth Lines** and **Arc from Lines** tools will be disabled.

Shown below with endpoints on in View Mode is a piece of text that was converted to lines before being imported into ArtiosCAD:

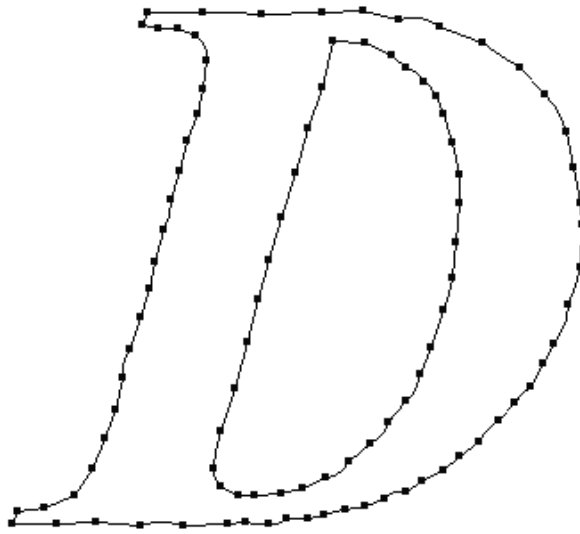

Clicking the **Smooth Lines** tool results in the following anomalies being shown:

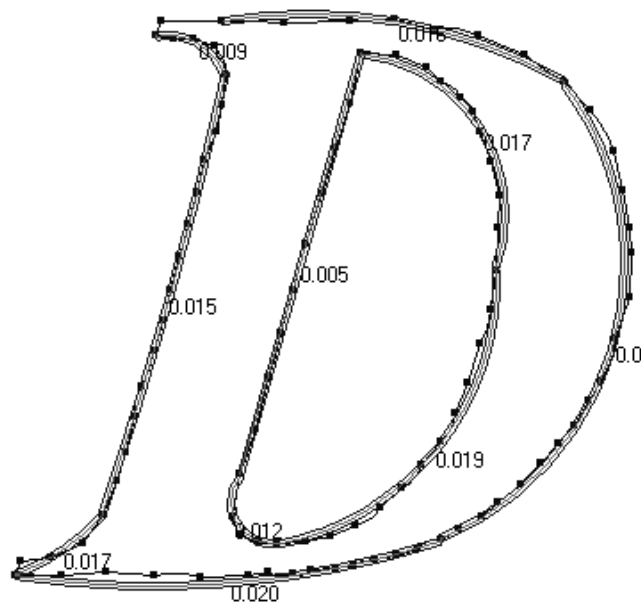

Making both the **Size:** and the **Smoothing Limit:** larger results in a more circular proposed fix:

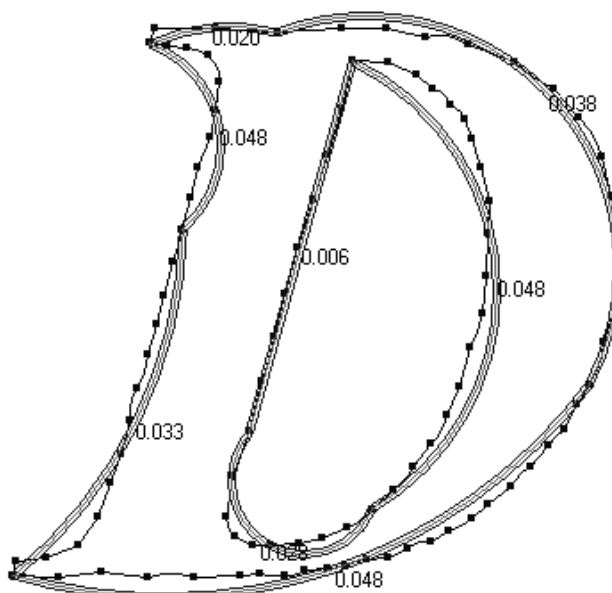

Finally, having reset the parameters to their initial values, selecting all the anomalies and fixing them results in:

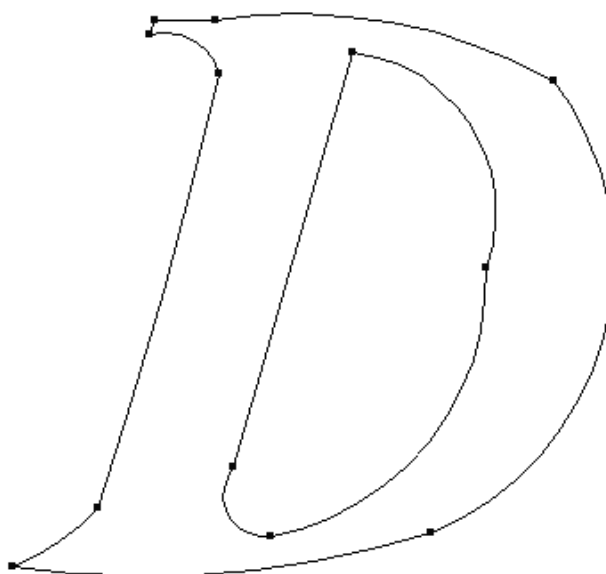

Designer's Fix-It defaults

Designer's Fix-It uses the Designer's Fix-It Defaults catalog. In it, you can set the defaults for all the tool parameters.

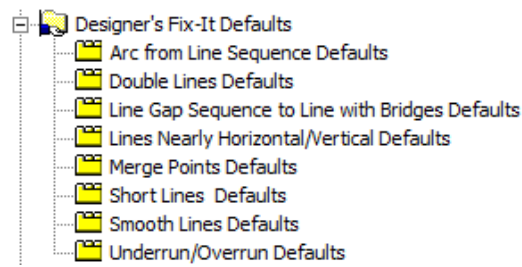

As with other defaults, double-click the entry to modify and change the values accordingly.

Dieboard Dropout Check

Dieboard Dropout Check on the Manufacturing menu checks for common errors that can cause problems when you manufacture the dieboard:

- Areas with no bridges that will drop out of the dieboard
- Areas without enough bridges
- Areas with bridges that are too small.

It also checks for:

- Rules that meet on the same rule path having different pointages (if **Check pointage** is selected)
- Zero-length lines
- Double lines.

Note: ArtiosCAD only checks dieboards, not stripping boards or other manufacturing tools.

When you do a check, ArtiosCAD displays the Dropout Check dialog box and highlights the first type of error it finds.

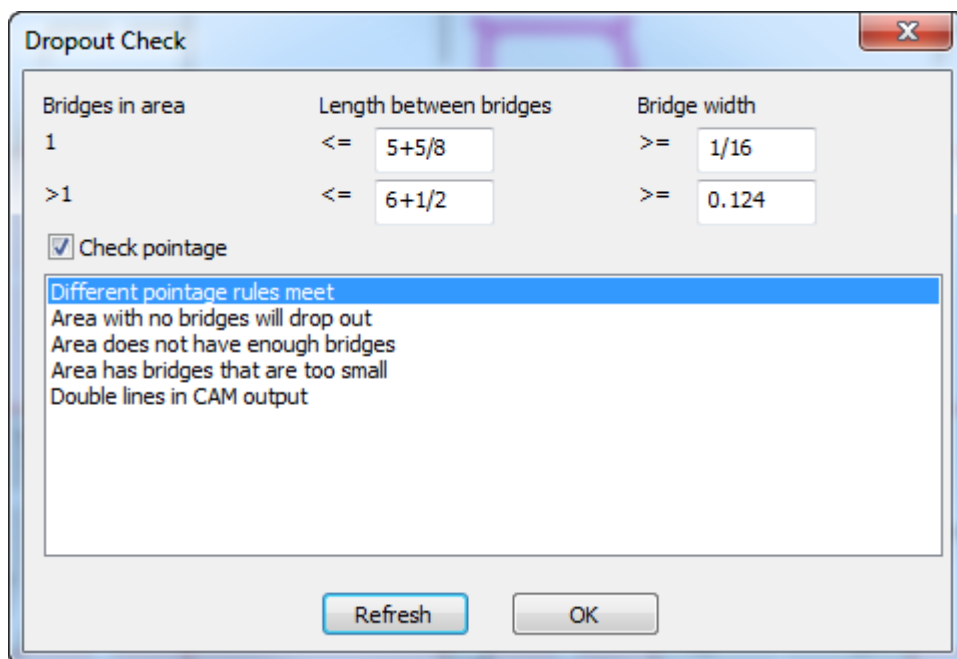

Change the parameters of the checks as desired. In the first row, the check is for if there is only one bridge in an area, what the maximum distance between bridges should be, and the minimum size of the bridges. In the second row, the check is the same for when there is more than one bridge in an area. Once you have changed the parameters, click **Refresh** to re-run the checks and update the display.

When you click a type of error in the list, ArtiosCAD highlights those errors in the workspace.

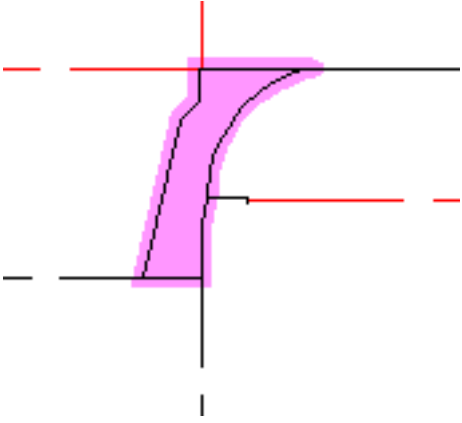
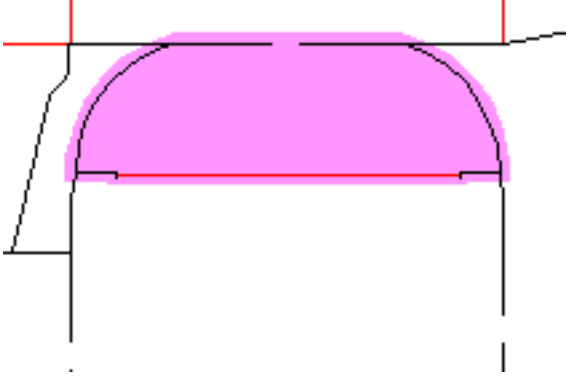
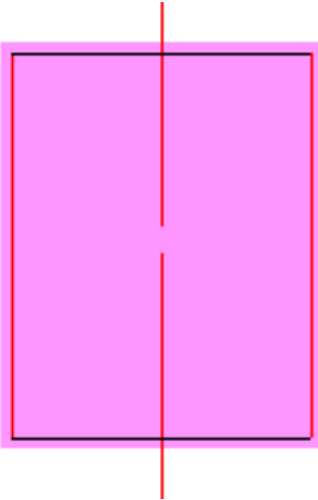
Type of error	Example
Area with no bridges that will drop out	
Area with only one bridge	
Two different areas joined by one bridge that will drop out	

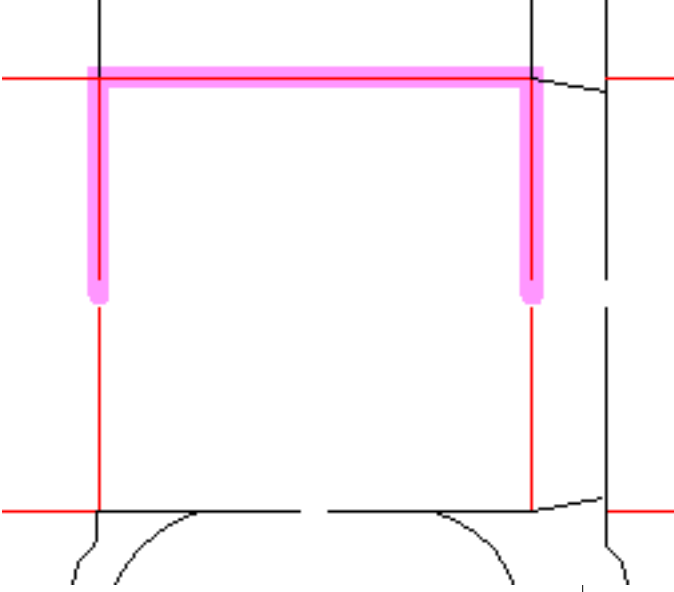
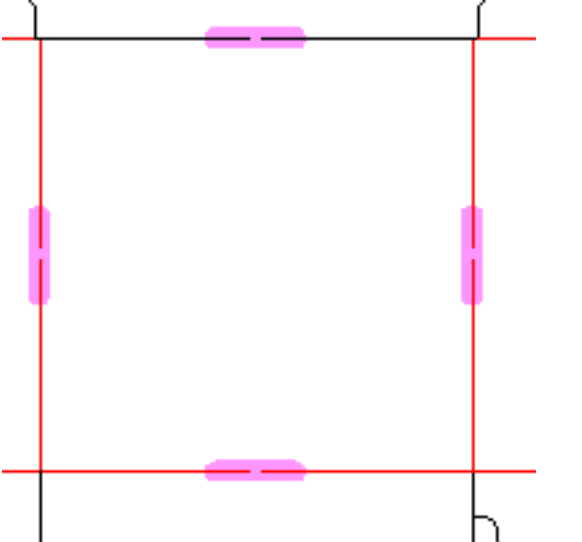
Type of error	Example
A long path without a bridge	
Small bridges	

To show more than one error type at once, hold down SHIFT and click the desired error types in the list.

These checks are also run when you make an Output of the Designs layer or Rule path layer with bridges on. Any errors appear in the Output Processing Errors dialog box.

Note: Set the defaults for this feature in **Startup Defaults > Dropout Check Options.**

Rubbering

Introduction to rubbering

Some diemakers put strips and pieces of rubber on the dieboard. The **Rubber Design** module provides tools to create rubber pieces that follow the contours of the design lines in the layout. The **Rubber Design and Layout** module enhances that further by efficiently nesting the rubber pieces on rubber sheets, which can then be output to a rubber-cutting device. The Rubber Design and Layout module requires an additional USB security key.

Different types of rubber are used for different purposes on the dieboard. Profile/strip rubber comes pre-cut in strips to be placed by hand so it is generally not included in Outputs. Other types of rubber are cut out of larger sheets. These modules are designed to work with the types of rubber cut out of the larger sheets, but you can also place profile/strip rubber on the dieboard so that the places for profile/strip rubber are indicated when the dieboard is plotted.

Both of these modules are options which must be purchased.

Generic special rule and zero pointage rule are ignored; generic cut/crease is treated as a crease. Change generic special rule to specific special rule and set a pointage for all rule before using any rubbering tools.

ArtiosCAD includes a sensible example table of rubber types, example rubber parameter sets, and example rubber Outputs, but you should review them and modify them to fit your needs before using the Rubbering features for production. See the *Defaults* chapter for more information.

Rubber workflow overview

A general Rubbering workflow could be as follows:

1. Create a manufacturing workspace, perform double knife removal, and save the workspace.
2. Add stripping rules (also called *breaker knives*) where appropriate, both on the exterior and interior of the designs. If waste areas are large and **Make Splits** is checked in the parameter set, ArtiosCAD creates pseudo temporary stripping rules to break up large pieces of rubber for easier manufacture.

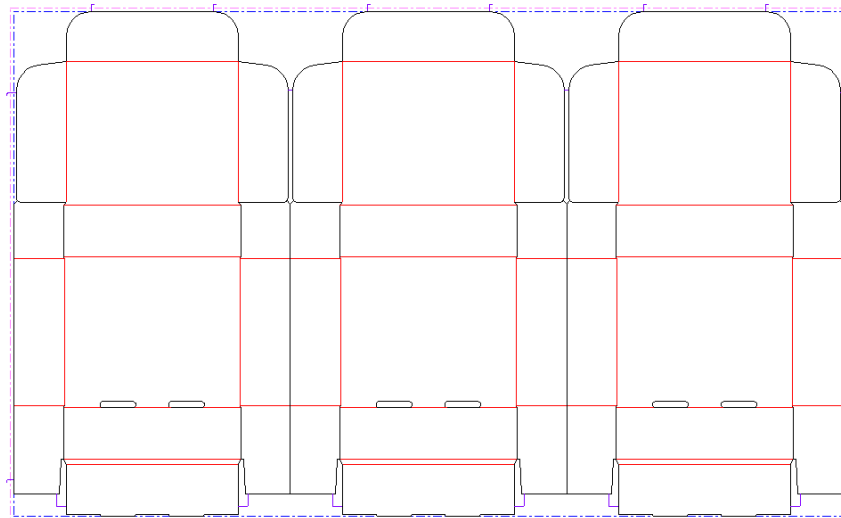

3.  Click **Rubber area** on the Rubbering toolbar.
4. Click **Recalculate all** on the Status bar. ArtiosCAD adds rubber to the layout according to the values in the Rubber parameter set selected in the Manufacturing parameter set. Different types of rubber have different colors.

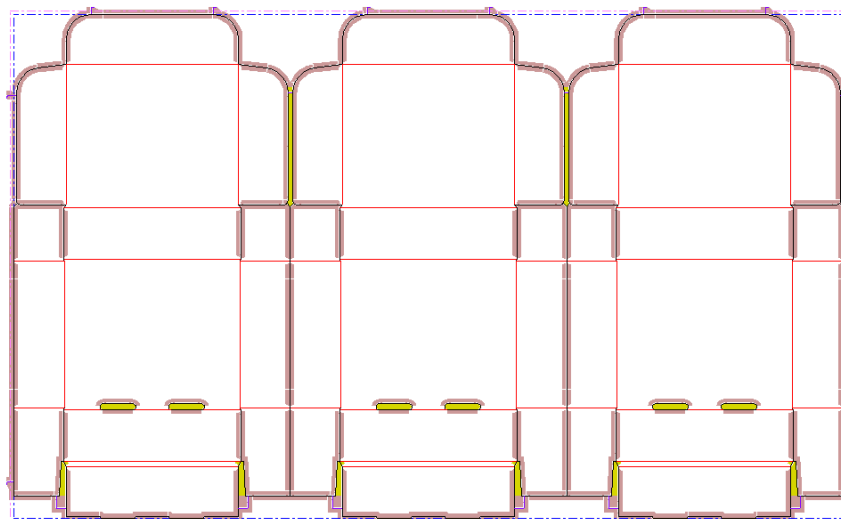

5. Use the manual edit tools to refine the rubber layout, adding joins, splits, and fills where necessary. Shown below is the result of a Recalculate All before editing.

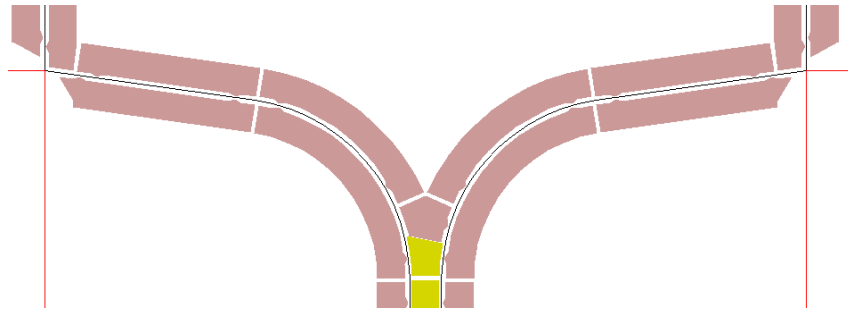

The same area after editing:

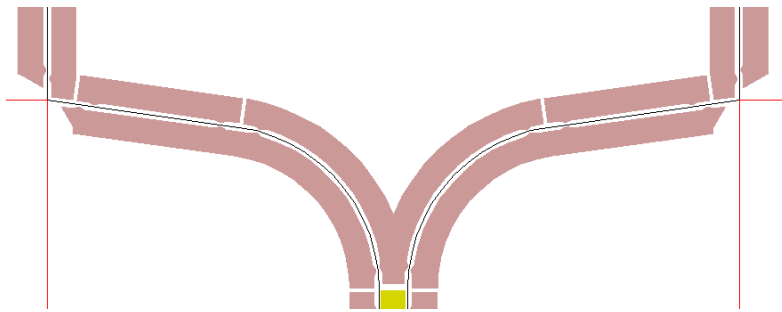

6.  Once you have adjusted the rubber as desired, use the **Layout Rubber** tool to nest it together on rubber sheets. (This requires the optional Rubber Design and Layout module.)

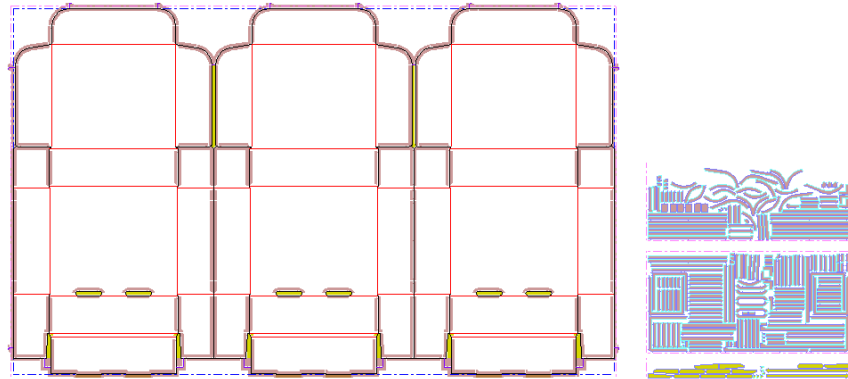













7. Next, make an Output. There are many example Reports in **File > Outputs > Artios > Rubber**. To output the rubber sheets themselves to HPGL files for use by a rubber cutter, use **File > Outputs > Artios > Rubber > Rubber sheet output**. Each tile of this Output is an individual rubber sheet.
8. Finally, save and close the workspace, and move on to the next task.













Rubber tools

The Rubber tools are on two toolbars, the **Rubbering** toolbar and the **Rubber view options** toolbar. The tools on the Rubbering toolbar require the Rubber Design license, while the tools on the Rubber view options toolbar can be used by anyone with a Connection license.

Shown below are the Rubbering toolbar with its fly-outs expanded, and the Rubber view options toolbar beneath it, along with a description of each tool's function. Tools with more complex workflows are further described in their own sections after the overview.









Table: Rubbering tools overview

Tool	Name	Description
	Rubber Area	Automatically applies rubber to the lines in the area where you click, or rubbers the entire layout by clicking Recalculate all on the Status bar.
	Repeat Rubber Element	Repeats the last rubber element made in the area where you click.
	Delete All Rubber	Deletes the die rubber, rubber sheet layouts, and top plastic cover depending on the items you select in the Delete All Rubber dialog box.
	Delete Rubber Area	Deletes the rubber in the area where you click.
	Select Rubber	Selects the piece of rubber under the cursor. Hold down CTRL while clicking to select more than one piece at a time.
	Split Rubber	Splits a piece of rubber where you click.
	Join Rubber	Joins two pieces of rubber when you click near a split. If the two pieces of rubber are different types, click the piece of rubber whose type you want to keep.
	Move Rubber Split	Move a rubber split to the point you click.
	Trim Rubber	Trims a piece of rubber against another or against a counter.
	Add Rubber	Creates or adds to existing rubber using a loop of design lines.
	Subtract Rubber	Subtracts an area of looped design lines from existing rubber.
	Fill Rubber Area	Fills a small area formed by looped design lines with rubber. Not for use with large areas; use Rubber Area for those.
	Add Separator	Adds a separator between the edge of the rubber and the rule.

Tool	Name	Description
	Remove Separator	Removes a separator from rubber where you click.
	Move Separator (on fly-out toolbar)	Moves a separator to where you click.
	Add Open-out	Adds a cut in the rubber so that it can be spread flat on the sheet for easier cutting.
	Delete Open-Out (on fly-out toolbar)	Deletes the open-out cut where you click.
	Subtract Bolt Holes	Removes areas of rubber covering bolt holes in the dieboard.
	Update Plastic Cover	Updates the plastic cover to match changes in the slot rubber. Use this tool if you change the slot rubber after already having created the plastic cover with the Rubber Area tool. Click ... on the Status bar to adjust the cover parameters or click Recalculate All to completely regenerate the cover.
	Group Rubber	Groups selected adjacent rubber or plastic cover pieces together so that they are nested on the sheet as a group. This allows easier finding of pieces that go near each other on the dieboard.
	Ungroup Rubber (on fly-out toolbar)	Ungroups rubber or plastic cover pieces.
	Layout Rubber	Creates nested sheets for some or all rubber types. Requires optional Rubber Design and Layout module and additional USB security key.
	Highlight Rubber with Repeat	Shows matching pieces of rubber on the dieboard and on the sheet for easy identification and placement assistance.
	List Rubber Elements	Opens a dialog box listing the rubber elements in which you can click entries and have them highlighted in the layout and sheet (if available).
	Rubber View Options	Sets options for the view such as fill, color by type or by number, show element numbers, and so forth.

In addition to the tools listed above, other tools are particularly useful for working with rubber.

Table: Other tools useful for rubbering

Tool	Name	Purpose
	Delete Element (or the DEL key on the keyboard)	Deletes pieces of rubber selected with a Select tool.
	Merge Lines Straight	Adjusts the rubber shapes as needed and auto-repeats.
	Merge Lines Arc	Adjusts the rubber shapes as needed and auto-repeats.
	Merge Lines to Intersection	Adjusts the rubber shapes as needed and auto-repeats.
	Stretch Point	Adjusts the rubber shapes as needed and auto-repeats.
	Stretch by Polygon	Adjusts the rubber shapes as needed and auto-repeats.
	Line tools	Creates custom-shaped looped design lines that then can be used with Add Rubber or Subtract Rubber .
	Auto-Repeat	Controls if manual changes are repeated in congruent geometry.

Rubber Area tool

 The **Rubber Area** tool automatically adds or updates rubber in the area in which you click after activating the tool. If the **Rule Path** layer has rules in it, the rubber is applied to those rules; otherwise, the rubber is applied to lines in the **Designs, Dieboard, and Stripping Rules** layers. When the tool starts, it turns on the **Rubber, Designs, Dieboard, and Stripping Rules** layers, and the Status bar includes the following controls:

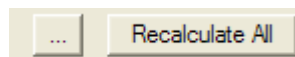

The ... button leads to the Rubber Parameters dialog box, which lets you set or change all the values in the Rubber parameter set associated with the parameter set for this layout.

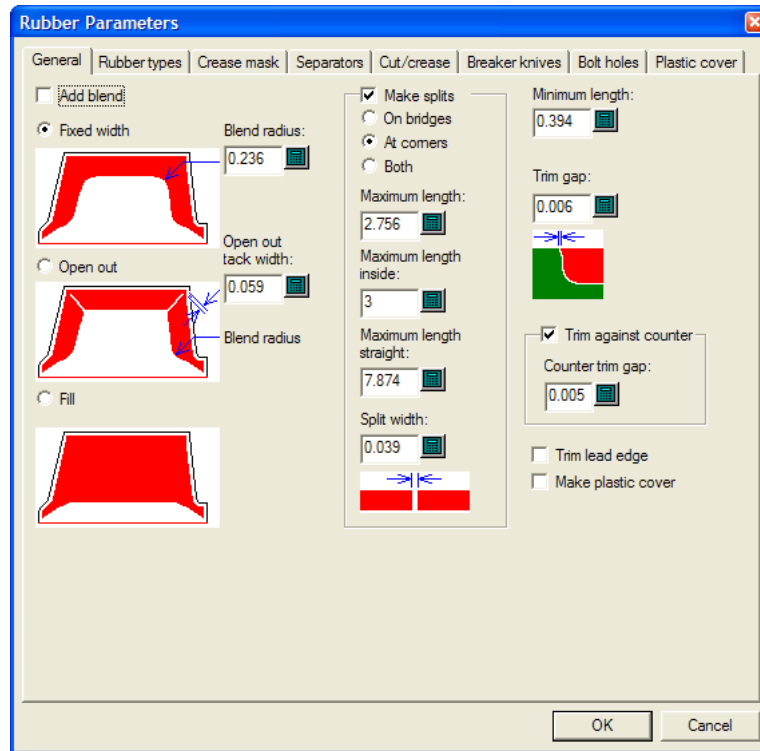

For more information about setting these values, refer to the *Defaults* chapter.



Repeat Rubber Element tool

 The **Repeat Rubber Element** tool repeats the selected pieces of rubber in congruent locations when Auto-Repeat is turned off.

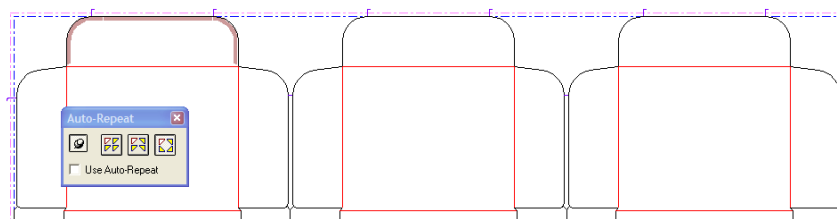
Shown below is a layout with rubber created using the **Rubber Area** tool and Auto-Repeat turned off.



To use the tool, do the following:

1.  Select the pieces of rubber to repeat, either individually or by a marquee selection.
2.  Click **Repeat Rubber Element**.
3. ArtiosCAD creates rubber in congruent areas.

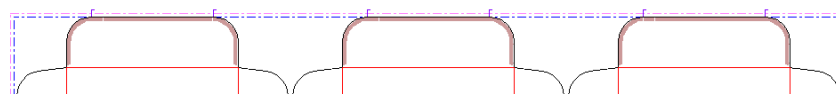

Split Rubber tool

 The **Split Rubber** tool splits a piece of rubber perpendicularly if its sides are parallel; otherwise, the split is roughly perpendicular, snapping horizontally or vertically if the **Horizontal/Vertical** checkbox is checked on the Status bar. The width of the split is set by the value in the **Split Width:** field on the Status bar. Shown below is when the **Horizontal/Vertical** checkbox is selected.

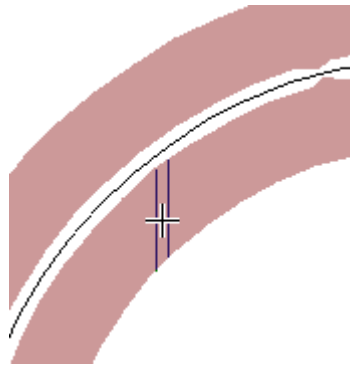

When the **Horizontal/Vertical** checkbox is not selected, the direction of the split is perpendicular to the side of the rubber closest to the cursor:

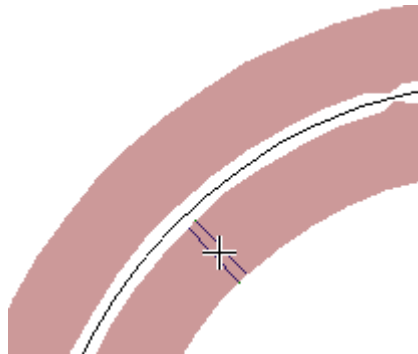

The split position snaps to corners, midpoints, and bridges, and also to construction lines in the **Die rubber** layer.

After splitting a piece of rubber, if appropriate, the smaller piece is changed to the type of rubber type used in narrow areas.

Add Open-out tool

 The **Add Open-out** tool creates a cut in a corner of a piece of rubber so that it may be unfolded flat on the rubber sheet for less waste, and to accommodate rubber-cutting machines that can make a bevel in one direction only. To use this tool, activate it and then click in the corner of a piece of rubber. Shown below is a rubber layout with no open-outs and its corresponding rubber sheet.

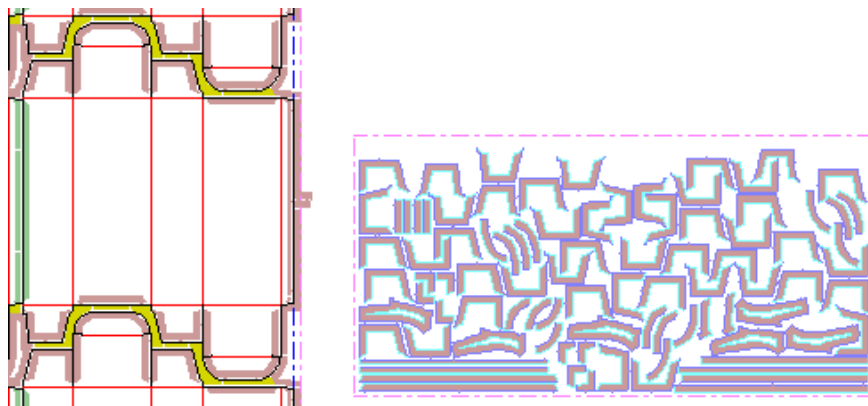

After adding open-outs to the corners of the U-shaped pieces of rubber in the four flaps, the regenerated rubber sheet looks like this. Note the open-outs in the layout.

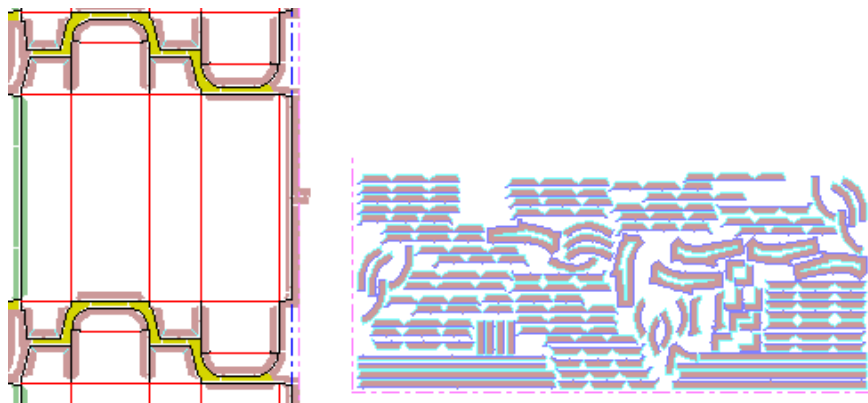

Subtract Bolt Holes tool

 The **Subtract Bolt Holes** tool removes the areas of rubber that cover die bolt holes, die registration holes, and laser positioning holes in the die. The parameter set may be set to remove these areas automatically (but this affects auto-repeat); it is when that option is not selected that this tool becomes necessary.

To use this tool, activate it, enter the desired offsets in the Subtract Bolt Holes dialog box, and click **OK**. The Subtract Bolt Holes dialog box will show if rubber pieces need changing or not as shown below.

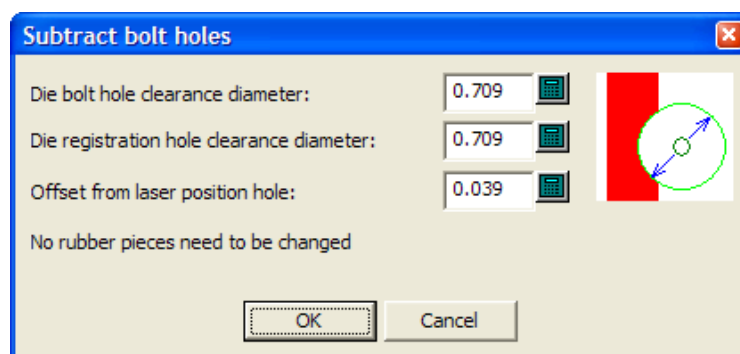

Often the bolt holes are far away enough from the rubber so that this tool does nothing.

Layout Rubber tool



The **Layout Rubber tool** efficiently nests the rubber elements together on sheets that can then be output to files for a rubber-cutting machine. Note that this tool requires a license which must be purchased, and also has an additional USB security key. When activated, the tool opens the Make Rubber Layout dialog box, shown below in its initial state before a layout has been made.

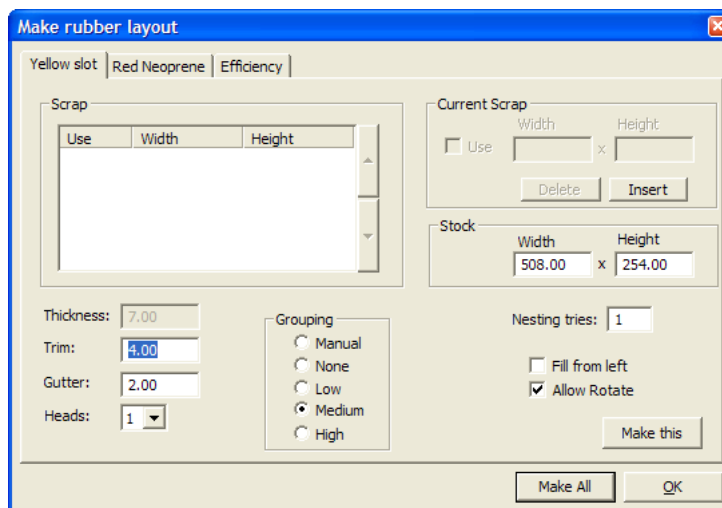

Each type of rubber used in the layout (except for premade strip/profile rubber) has its own sheet created, and correspondingly has its own tab in the Make Rubber Layout dialog box.

Trim is the distance from the edge of the rubber sheet to the edges of the rubber elements, and **Gutter** is the distance between each rubber element.

Some rubber cutters have more than one cutting head so that more than one sheet of rubber can be cut at a time. In this case, specify the number of heads in the **Heads** drop-down list box. If you specify two or more heads when making rubber sheet layouts, this reduces the number of copies output of each piece. For example, if there are 11 copies of a piece, ArtiosCAD might place five copies on a sheet cut twice and one on a sheet cut once. The sheets that should be cut twice are labeled **x2** both in the rubber sheets layer (at the top left of the sheet) and in the Output.

ArtiosCAD automatically groups pieces of rubber on the sheets based on their shapes. The five choices in the **Grouping** group control how the instances of each rubber element are grouped together on the sheets. **Manual** means that the grouping will be taken from the values set in the List Rubber Elements dialog box. **None** means that each item will be considered its own group. **Low** means only straight items will be grouped together. **Medium** will do an intermediate level of grouping, but **High** will group together as many instances of the element as possible. These controls are meant to let you find the balance between making pieces easy to find and wasting the least rubber.

You can define up to six sheets of scrap rubber to use instead of fresh sheets. To add a scrap sheet, click **Insert** in the **Current Scrap** group, enter its dimensions, and check the **Use** checkbox. Click **Delete** to delete the selected piece of scrap from the list.

Increasing the value in the **Nesting tries:** field causes ArtiosCAD to try more nests, but this takes more time.

Fill from left tells ArtiosCAD to fill the sheet in a left-to-right sequence. When this is off (the default), the sheet is filled from the bottom to the top.

Allow Rotate allows the nesting process to use angles other than 180 when trying potential nests.

Make This generates a sheet of rubber for the current tab.

Make All generates sheets of nested pieces of rubber according to their types. More than one sheet per type is generated if necessary.

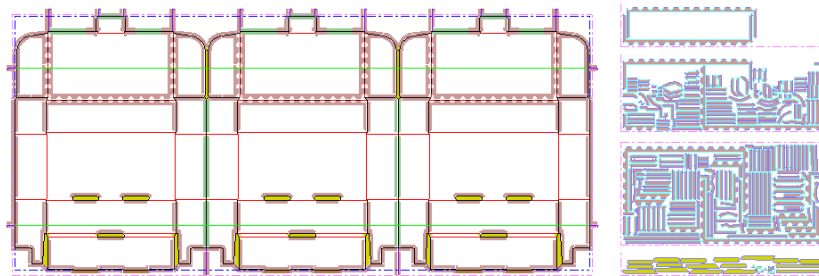

Clicking **OK** makes nothing and returns to ArtiosCAD.

Once you have made a rubber sheet layout, ArtiosCAD populates the Efficiency tab of the Make Rubber Layout dialog box as shown below. For each sheet of rubber, ArtiosCAD lists the sheet's rubber type name, the dimensions of a rectangle containing all nested pieces (always including one full sheet dimension), the percentage of the area in the rectangle that is actually used, and the size of the rectangular sheet that is remaining when the nested rectangle is removed.

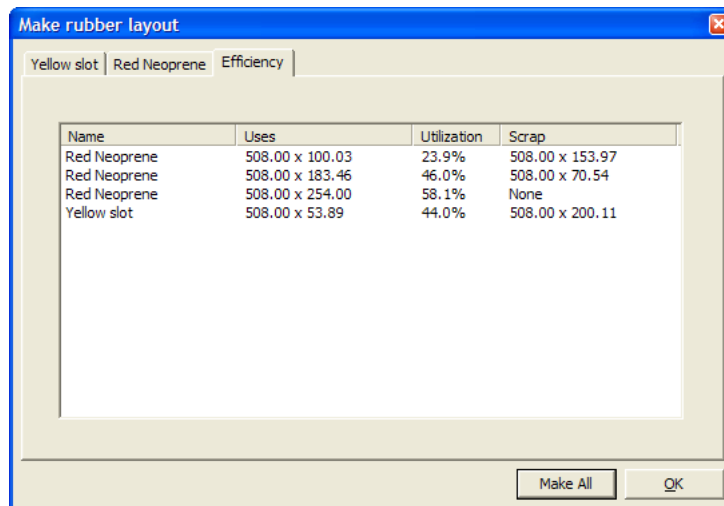

List Rubber Elements tool

 The **List Rubber Elements** tool opens a dialog box in which you can select rubber elements and see them highlighted on the dieboard and rubber sheets (if they have been generated). Some elements of the dialog box are unavailable without the Rubber Design and Layout option.

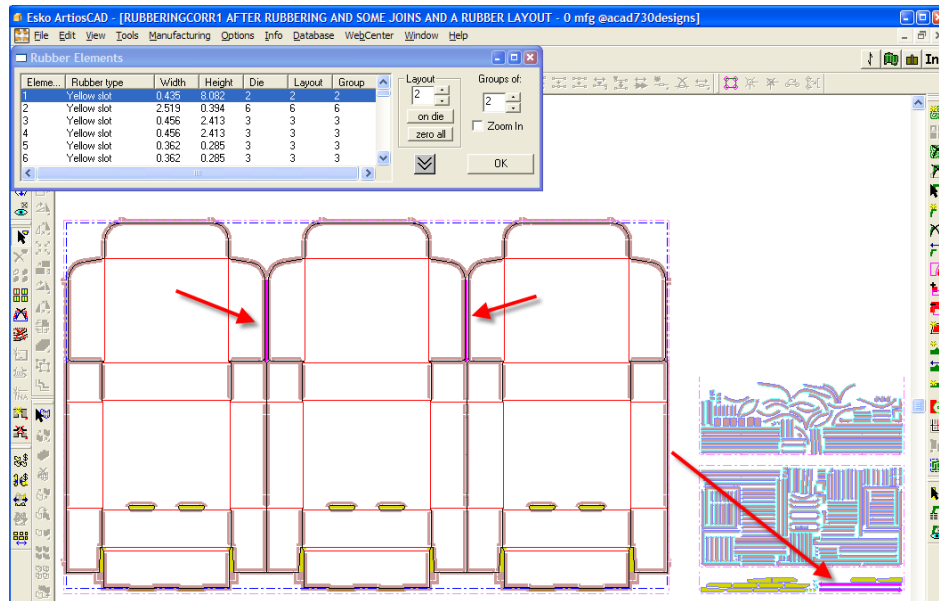

Shown below is the Rubber Elements dialog box in greater detail.

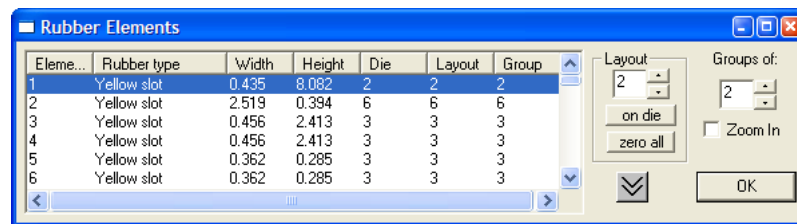

The left side of the dialog box shows the list of all the rubber elements, ordered by rubber type and then element size. The **Die** column lists the number of pieces on the dieboard, while the **Layout** column lists the number of pieces in the rubber sheet layout (these numbers are the same initially by default). The **Group** column indicates the maximum number of groups containing this element in the sheet layout (with 1 being no groups).

The down-arrow chevron expands the dialog box to the bottom of the monitor, and the up-arrow chevron it changes to when clicked shrinks the dialog back to its previous size.

In the **Layout** group, the value listed shows how many instances of the current selection are in the sheet layout. You can change this number to make more or less of the current selection if you regenerate the layout. This is so that if you need to produce a few more pieces of a delicate item, you can do so easily. **On die** resets the number of elements in the layout to the number of elements on the dieboard, while **Zero all** resets all the elements on the sheet to zero. (You would then select the few pieces to make again, set their numbers in the Layout field to the desired numbers, click **OK**, and regenerate the layout with the **Layout Rubber** tool.)

For example, suppose you need 20 more of these, of which you currently have 3:



You would increase the number in the **Layout** field to 23, regenerate the Yellow Slot rubber sheet, and arrive at the layout shown below:

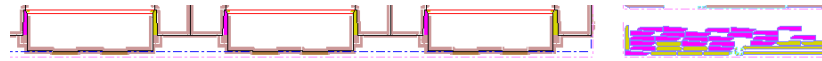

The **Groups of:** group controls how many instances of the same rubber piece are placed near each other on the sheet. For example, if there are 12 instances of the same element, the **Group** column is initially set to 12 so that they are all together on the sheet, but by changing the **Groups of:** value to 2 and regenerating the sheet, you would have up to 6 groups of 2 scattered throughout the sheet. However, more than 2 pieces may still be grouped near each other if that results in greater efficiency.

When you change the number in the **Groups of:** field, the **Grouping** option button in the Make Rubber Layout dialog box changes to **Manual** so that your change to the layout method is preserved if you regenerate the rubber sheet layout.

Zoom in zooms in on the selected rubber element so that it fills the window. Deselecting it performs a Scale to Fit to show the entire workspace.

Making manual changes to a rubber layout

To design your own rubber shapes, draw them in the **Die Rubber** layer of the layout and then use the Add Rubber tool as shown in the steps below.

1. Change to the **Die Rubber** layer of the layout, turn on the appropriate toolbars, and draw the desired geometry. Make sure to draw a loop of lines.

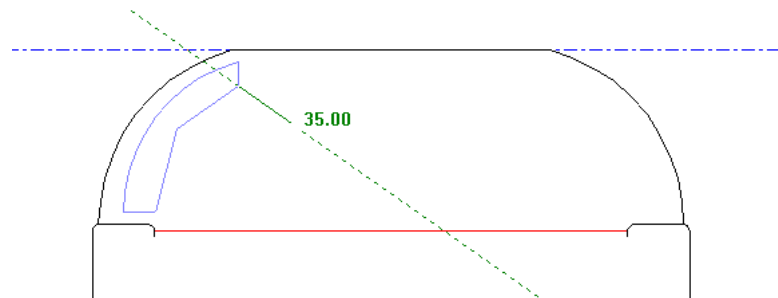

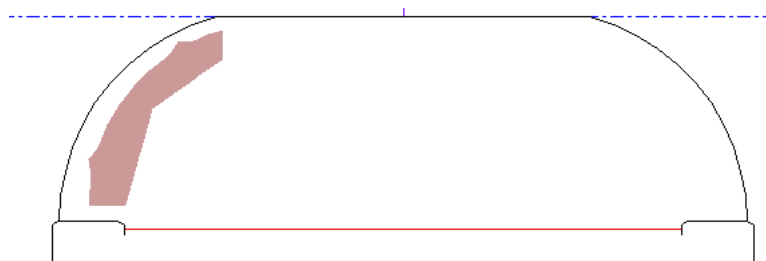

2.  Click **Add Rubber**, select the just-drawn geometry either by clicking it or by using a marquee selection, and set the Status bar options as desired. If the lines do not form a loop, OK remains unavailable. Click **OK** when it is available.
3. The geometry is changed to a piece of rubber and is auto-repeated in congruent areas if Auto-Repeat is enabled.

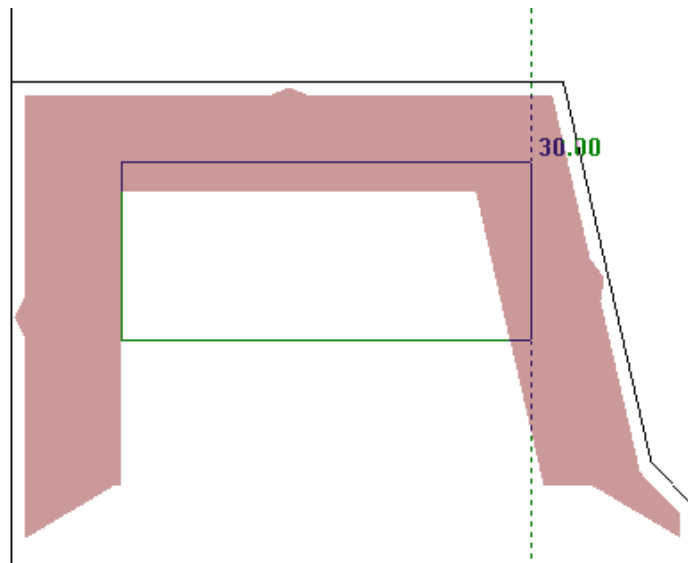

To add to an already-existing piece of rubber, do the following:

1. Change to the **Die Rubber** layer of the layout, turn on the appropriate toolbars, and create a loop of lines that overlaps the desired piece of rubber.



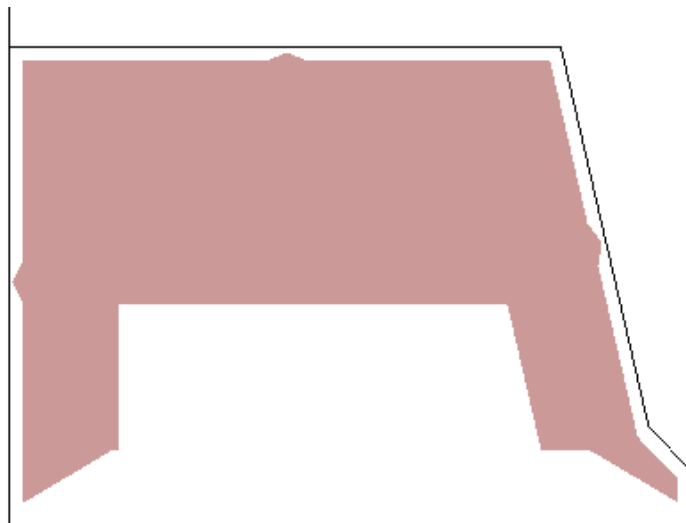

2.  Click **Add Rubber**, select the geometry either by clicking it or by using a marquee selection, and set the Status bar options as desired. Click **OK**.
3. ArtiosCAD adds rubber to the area within the looped lines that did not have rubber before, and these changes are auto-repeated to congruent areas if Auto-Repeat is enabled.

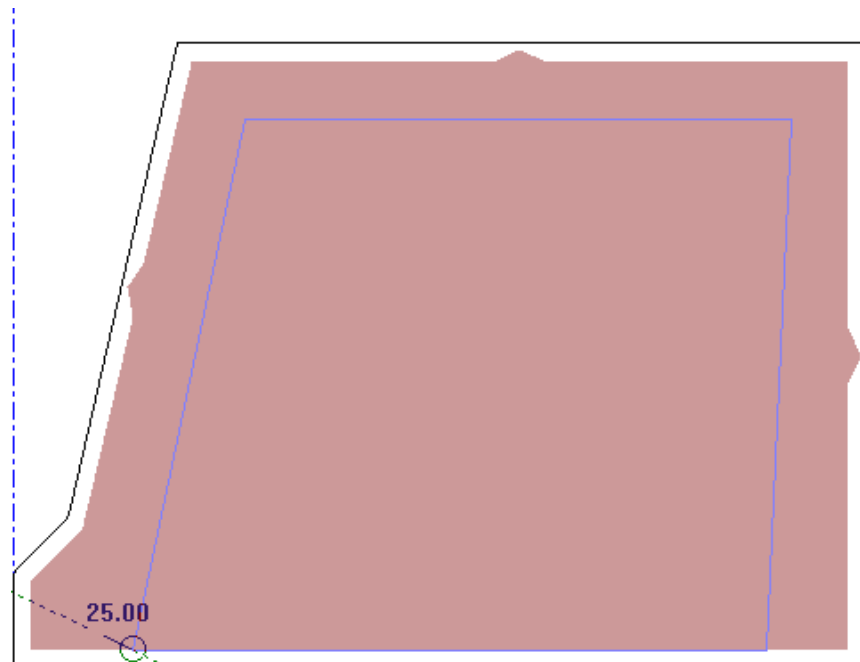

To remove rubber, use the **Subtract Rubber** tool in the same way as the Add Rubber tool.

1. Change to the **Die Rubber** layer of the layout, turn on the appropriate toolbars, and create a loop of lines in the shape of the rubber to remove.



2.  Click **Subtract Rubber**, select the geometry either by clicking it or by using a marquee selection, and set the Status bar options as desired. Click **OK**.
3. ArtiosCAD removes rubber from the area within the looped lines that had rubber before, and these changes are auto-repeated to congruent areas if Auto-Repeat is enabled.

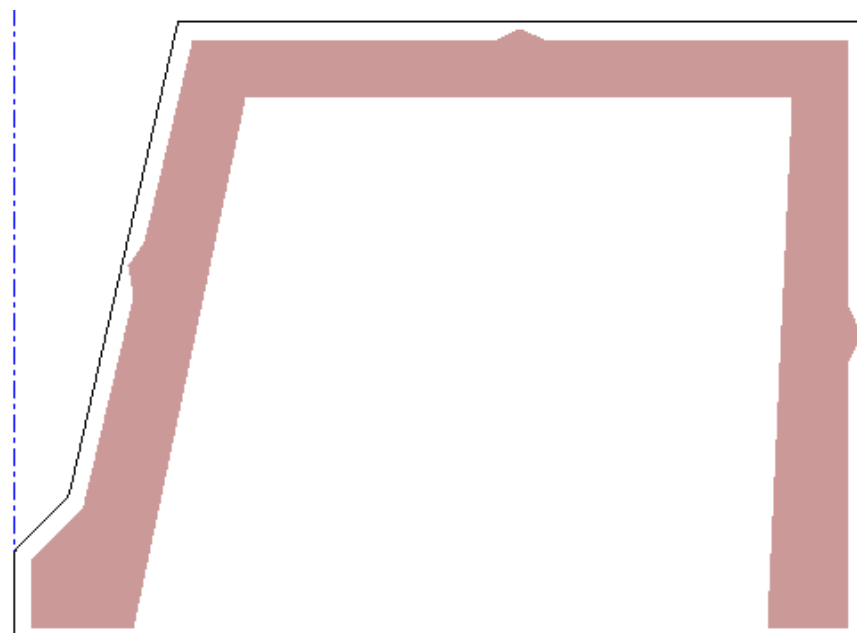



To make small changes to the rubber layout, use the **Select**, **Move**, and **Rotate** tools. However, avoid using the **Copy** tools with rubber elements as this could lead to unpredictable results.

Use the tools on the Adjust and Adjust Outlines toolbars to adjust the outline of rubber pieces. **Merge Lines Straight**, **Merge Lines into Arc**, and **Merge Lines to Intersection** can all adjust

the outlines of rubber pieces in two to three clicks. **Stretch Point** and **Stretch by Polygon** are also handy. These tools work with Auto-Repeat if it is enabled.

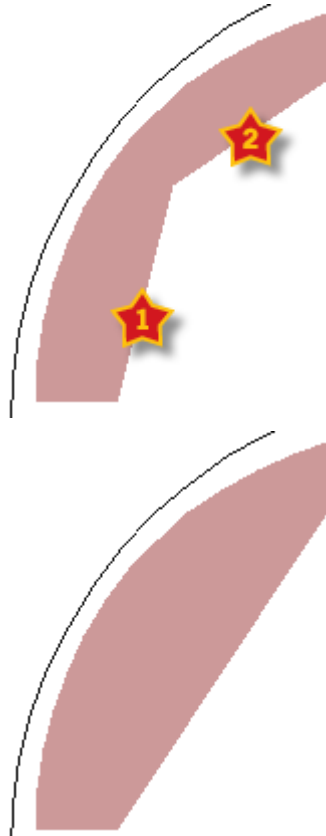
 **Merge Lines Straight** straightens a series of lines, and when used with rubber, changes the shape of a piece of rubber. Activate the tool and click lines 1 and 2 to produce the second picture.



 **Merge Lines Arc** works similarly; activate the tool, indicate the lines to merge, and then set the radius of the arc:

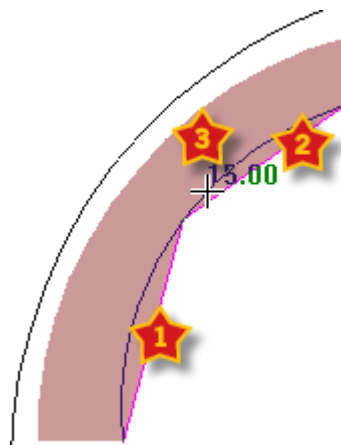

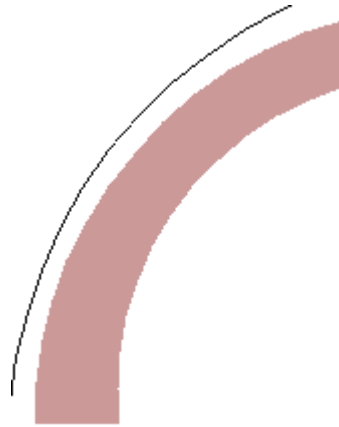

The rest of the previously-mentioned tools work the same way and all reapply separators.

Changing rubber properties

To change the type of a piece of rubber or its separator type, do the following:

1.  Click the **Select Rubber** tool and double-click the piece of rubber to change; or, to change more than one piece of rubber at once, hold down CTRL while selecting pieces and then press ALT-Enter.
2. The Properties dialog box appears as shown below.

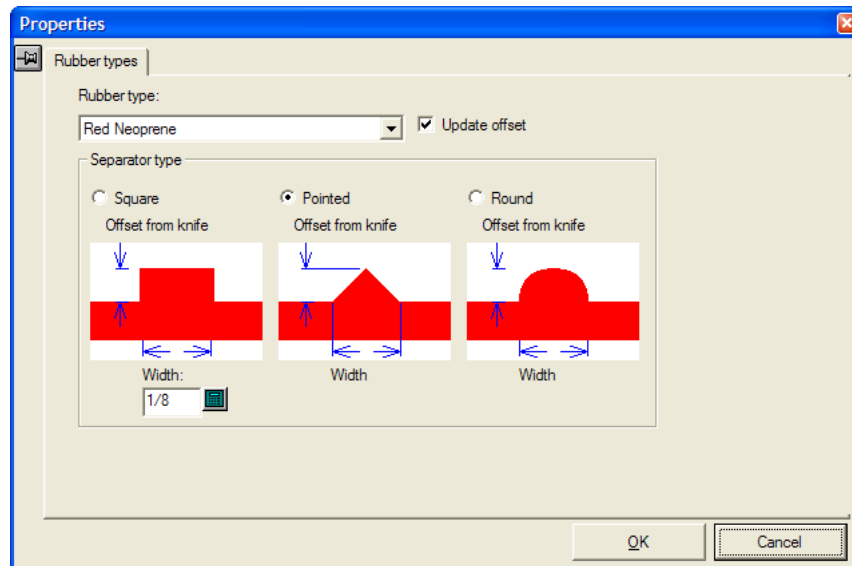

3. In the dialog box, use the **Rubber type**: drop-down list box to change the type of the rubber. **Update offset** is selected by default so that ArtiosCAD updates the offsets since they may differ between types of rubber. In the **Separator type** group, change the shape and size of the separators as desired. Slot and strip/profile rubber pieces do not have separators made for them. Changes made in this dialog box are immediately applied to the layout.
4. Click **OK** to resume working with the layout.

Blanking

Blanking is the process of removing the cartons/boxes (called blanks) from the sheet as it travels through the die press. Blocks and pins on the upper board push the blanks through holes in the lower board into stacks on the pallet. The rest of the sheet moves out of the press as waste. Having the press separate the blanks from the waste reduces the time needed to complete jobs and also reduces the risk of error.

Before using the tools described in this section, you should have a thorough understanding of your company's best practices for blanking. If you are unfamiliar with blanking, good places to start learning are in the documentation for your press and at your press manufacturer's website.

Blanking defaults are contained in the Blanking parameter sets. To review or change them, click **Options > Defaults > Blanking machine parameter sets** and **Blanking parameter sets**.







Blanking tools list









Turning on the Blanking Toolbar

Before you can use the blanking tools for the first time, use the Toolbar Master Control for Manufacturing (**View > ArtiosCAD Toolbars**) to turn on the Blanking toolbar. It will appear as a floating toolbar the first time you turn it on; after that, dock it or leave it floating as desired.



Tools on the Blanking Toolbar

Button	Function
	Add Grid Bar
	Include Strip Rules
	Generate Blanking Tools
	Adjust Blank Holes
	Adjust Pushers
	Add Non-stop Swords
	Add Photocells

Button	Function
	Add Jogger Guides
	Add Support Bars
	Add Air Holes
	Add Blanker Pusher Pins
	Add Hardware
	Add Tie-bolts
	Add Pressers
	Delete Blanking

Blanking Elements

Use the blanking tools in ArtiosCAD to create these blanking elements. If no blanking layers already exist in a manufacturing workspace, using these tools creates them.

The context menu commands are available when you right-click an element. The validation describes what ArtiosCAD checks when placing an element. Some blanking elements have multiple shapes that may differ from those shown here.

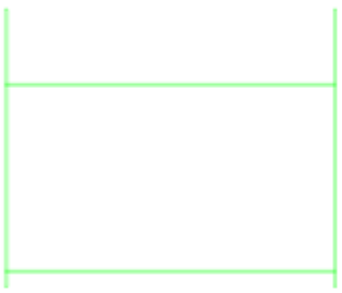
Blanking Element	Purpose	Context menu commands	Validation
<p>Frame</p> 	Holds the lower tool in the press	Delete	None
<p>Blank holes</p>	Separates the blanks from the sheet.	Delete Smooth (works on point blends)	None

Blanking Element

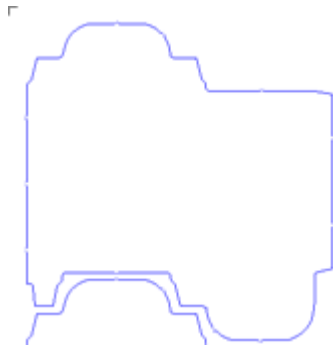

Purpose

Context menu commands

Unsmooth
(works on corner and slot bends)

Retack

Smooth and **Unsmooth** use the values from the Blanking Parameter Sets dialog box in the Generate Blanking Tools tool

Validation commands

Grid bars



Separates the blanks from the sheet

Delete

Repeat

Trim/Extend
(uses values from the Blanking Parameter Sets dialog box in the Add Grid Bar tool)

Must not overlap the center line of any other grid bar

Note:

This validation means that grid bars do not repeat when **Trim to grid** is turned off in the Blanking Parameter Sets dialog box.

Non-stop swords

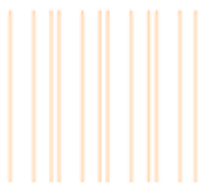

Supports the blanks as the stack underneath is removed from the press

Delete

Must not overlap any joggers or other non-stop swords

Photocells



Detects when the stack of blanks is too high and needs to be removed from the press

Delete

Optionally must be within press limits
Must not overlap any joggers or other photocells

Joggers

Guides the blanks to

Delete

Must not overlap any other joggers

Blanking Element



Purpose

the correct position on the pallet

Context menu commands

Validation

Must not overlap any lines in the lower board

Component active part lines must not overlap photocells, support bars, or non-stop swords

Support bars

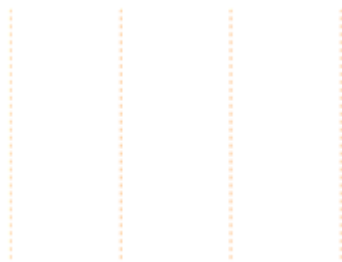

Reinforces the lower tool

Delete

Must not overlap joggers

Should not overlap any other support bars

Pusher edge

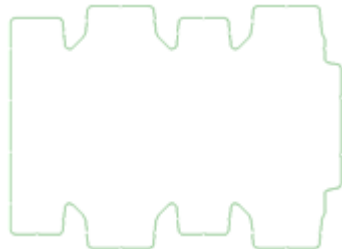

The outer edge of a pusher

Delete

None

Smooth
(works on point blends)

Unsmooth
(works on corner and slot bends)

Retack

Smooth and **Unsmooth** use the values from the Blanking Parameter Set dialog box for the Generate Blanking Tools tool.

Blanker pusher pins, also called stand-off pins (SOP)



Attaches the pushers to the upper board

Delete

Must not overlap other blanker pusher pins, pusher ID text items, pusher edges, tie-bolts, or pusher air holes

Blanking Element	Purpose	Context menu commands	Validation
Pusher ID text	Labels each pusher for easier assembly	Delete	Must not overlap any blanker pusher pins or pusher edges
Pusher board air hole and Upper blanking board air hole	Reduces suction caused by board movement in the press	Delete	Must not overlap any blanker pusher pins, pusher ID text items, or any pusher edges
Pressers	Holds the sheet waste as the the blanks are separated	Delete	Must not be in optional machine-restricted zones, or overlap other pressers or upper board air holes
Hardware	Varies. Grid clamps attach the grid bars to the frame. Plastic film acts as joggers.	Delete	None
Tie-bolt	Attaches the upper board to the press	Delete	Must be within the upper board Must not overlap any other tie-bolt hole, upper board air hole, or blanker pusher pin in the upper board
Lower blanker board	Guides the blanks into	Delete Properties dialog box	None



Blanking Element	Purpose	Context menu commands	Validation
	the proper position	with Alignment Method and Wood Corners tabs	
Upper blanker board	Pushes the blanks through the lower board	Delete Properties dialog box with Alignment Method and Wood Corners tabs	None

Blanking Congruency

Congruency is the property of two or more elements being identical except for physical placement. For blanking, ArtiosCAD uses contour congruency and layout congruency to determine where to put elements when Auto-Repeat is enabled.

Note:

Many factors affect congruency in unanticipated ways. Use caution when Auto-Repeat is enabled and always check that elements are placed correctly before performing an Output. Each element created with Auto-Repeat is checked for validity (except for those created with the Add Hardware tool) but in some cases the checks are not as effective as your experienced eye.

ArtiosCAD determines layout congruency based on the position of an element relative to the layout. If an element is contained within a blank, that element is repeated within all similar blanks. If an element crosses blank boundaries, it is repeated where that same group of blanks appears. For those imported workspaces where manufacturing components are actually subprograms - treated as if they were part of the manufacturing workspace but truly are not - blanking Auto-Repeat will not work correctly.

Two or more elements have contour congruency if they can be transformed into each other by mirroring or rotation. When Auto-Repeat is enabled, if a change is made to an element, ArtiosCAD applies that change to all other elements having contour congruency.

The table below lists the blanking tools and their congruency method.

Layout Congruency	Contour Congruency
Add Grid Bar	Generate Blanking Tools
Add Non-stop Swords*	Adjust Blank Holes

Layout Congruency	Contour Congruency
Add Support Bars*	Adjust Pusher
Add Jogger Guides	Add Blanker Pusher Pins
Add Air Hole	Smooth/Blend Contour
Add Hardware	Edit Contour
Add Presser	
*does not support mirrored blanks	

Frame Creation

Most of the blanking tools require the frame to exist, so if the frame does not exist, ArtiosCAD prompts you to create it before starting the tool you clicked.

ArtiosCAD bases the frame size on the **Frame Size** parameter in the Frame catalog of a blanking parameter set.

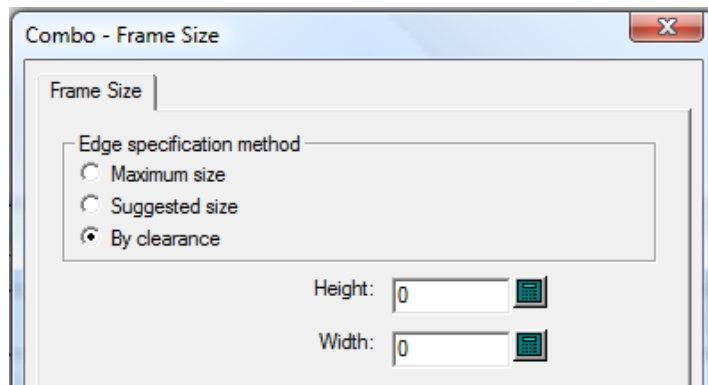

It can be:

- **Maximum size**, which takes the frame size from the **Vertical Pieces > Length**, **Horizontal Pieces > Maximum length**, and **Max Size Restrictions** fields defined in the Frame catalog of the blanking machine parameter set. **Min to inner** specifies the positioning of the lower horizontal bar when using either Maximum size or Suggested size.

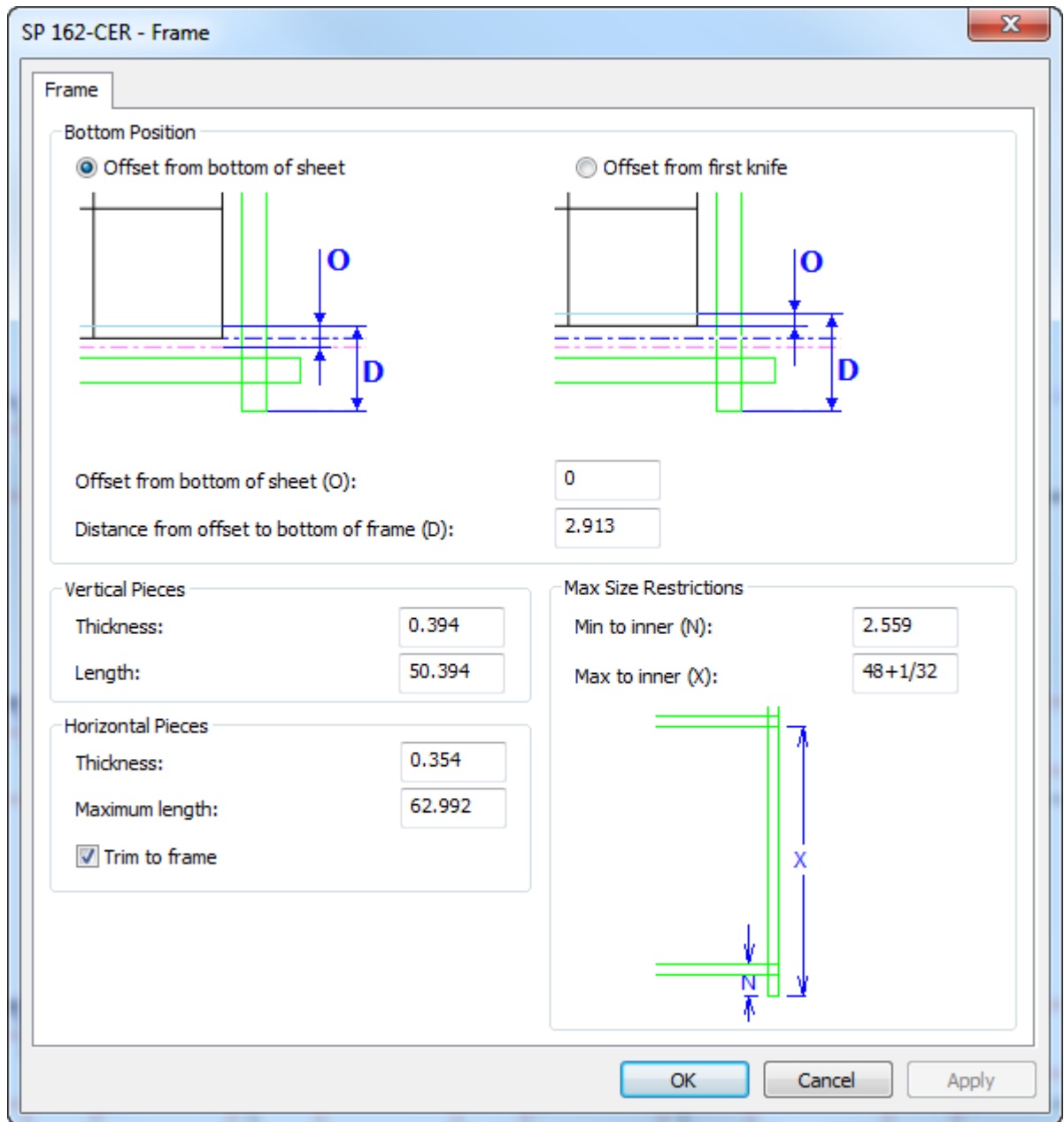

Note that you can also control the size of the horizontal pieces with **Trim to frame**.

- **Suggested size**, which uses the Height and Width field values you specify on the Frame Size tab of the blanking parameter set.
- **By clearance**, which calculates the proper size from the clearances you supply in the Frame Allowances dialog box that appears when you create the frame.

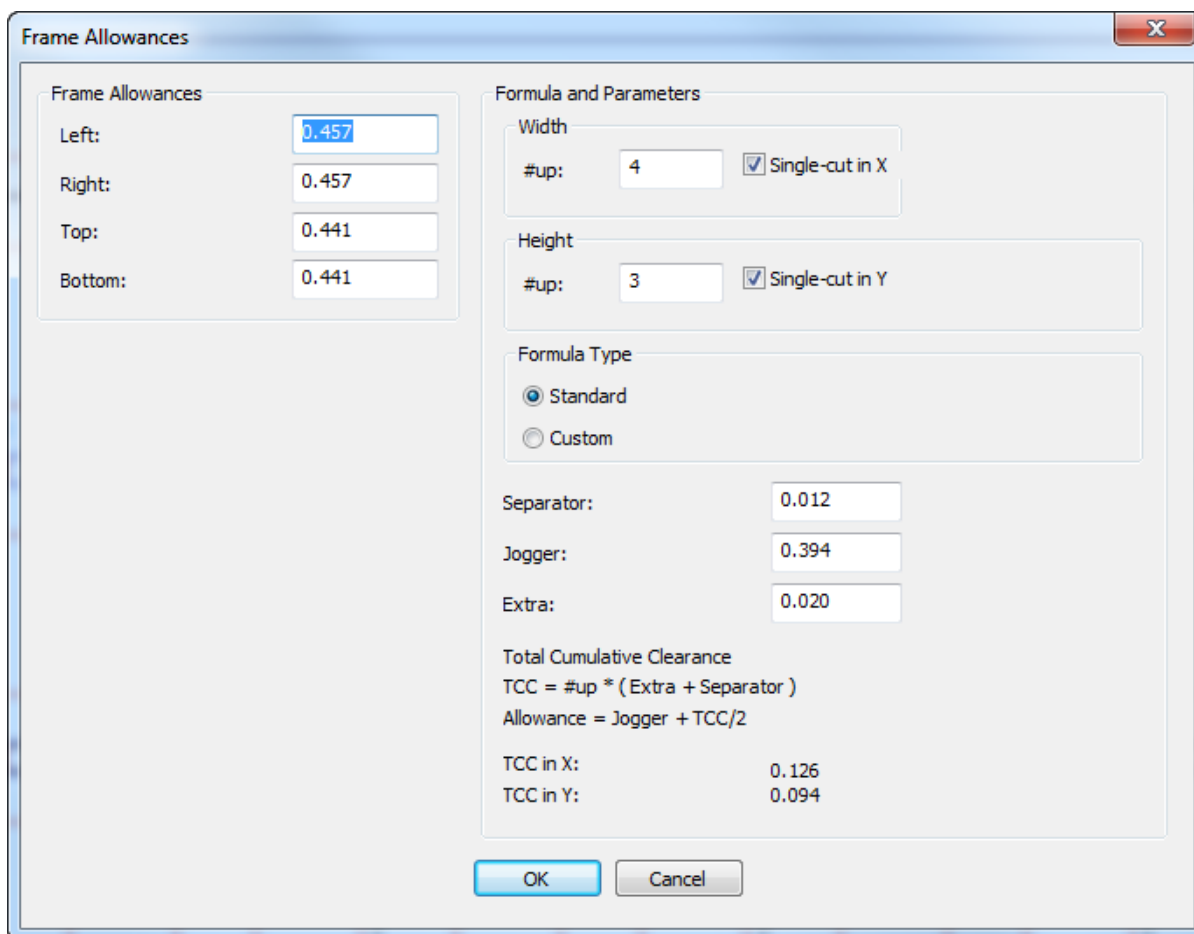

ArtiosCAD calculates the allowances on the left using the values in the **Formula and Parameters** group on the right, but you can manually enter any desired allowances in the appropriate fields.

In the **Width** and **Height** groups, if you deselect a **Single-cut** checkbox, the #up field becomes unavailable and ArtiosCAD computes the allowances as if the number were 1.

When using **By clearance**, follow the recommendations of your press manufacturer for the values to supply for clearances: **Separator**, **Jogger**, and **Extra**. One leading press manufacturer recommends adding a half millimeter plus the thickness of the separator for every blank for single-cut layouts. For double-cut layouts, the layout is treated as one large blank since the blanks are not connected.

For **Standard** formula type layouts, ArtiosCAD calculates the clearances based on the information you supply and creates the blanking frame accordingly. For **Custom** formula type layouts, the controls change to specifying a library function to calculate the left, right, top, and bottom clearances.

An example of a library function to calculate a clearance is:

```
param &nup &jog &sep &extra
! In:
! &nup = number of designs
! &jog = the jogger clearance in current units
! &sep = the separator clearance in current units
! &extra = the extra clearance in current units
!
! Returns the allowance
dset &ret &jog+&extra+((&nup-1)*&sep)/2
```

The library function for the separator clearance on the BSI Grid type of blanking tool set is `bsi_blk_clearance.txt` and contains:

```
param &nup &jog &sep &extra
! In:
! &nup = number of designs
! &jog = the jogger clearance in current units
! &sep = the separator clearance in current units
! &extra = the extra clearance in current units
!
! Returns the allowance
if (&nup=1)
dset &ret &jog+&nup*(&extra+&sep)else
dset &ret &jog+&nup*(&extra+&sep)/2
endif
```

Blanking Example Workflow: Lower Grid

A common blanking method is using a grid as the lower blanking board. Here is one way to make a grid.

1. Design a layout in ArtiosCAD.
2. If desired, create stripping tools for the layout. Use **Include Strip Rules** to tell ArtiosCAD which stripping rules to respect when creating the blanking tools.



3.  Click **Add Grid Bar** on the Blanking toolbar.
4. Choose a blanking machine parameter set in the Choose Blanking Machine Parameters dialog box and click **OK**.

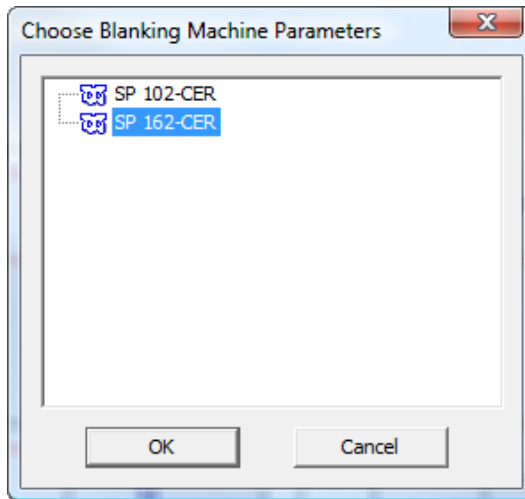

5. Choose a blanking parameter set in the Choose Blanking Parameter Set dialog box and click **OK**. For this example, choose **Grid**.

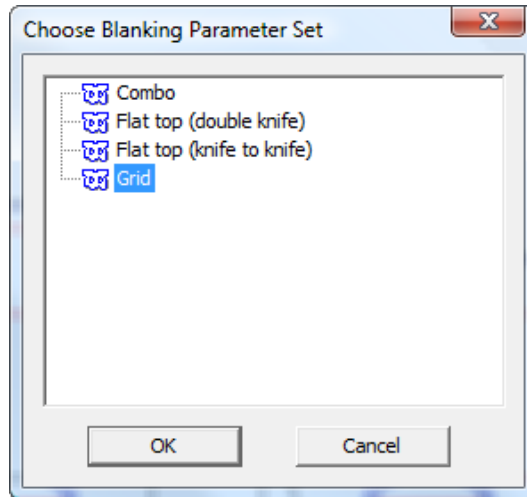

6. In the Frame Clearance dialog box, change any values as desired and click **OK**.

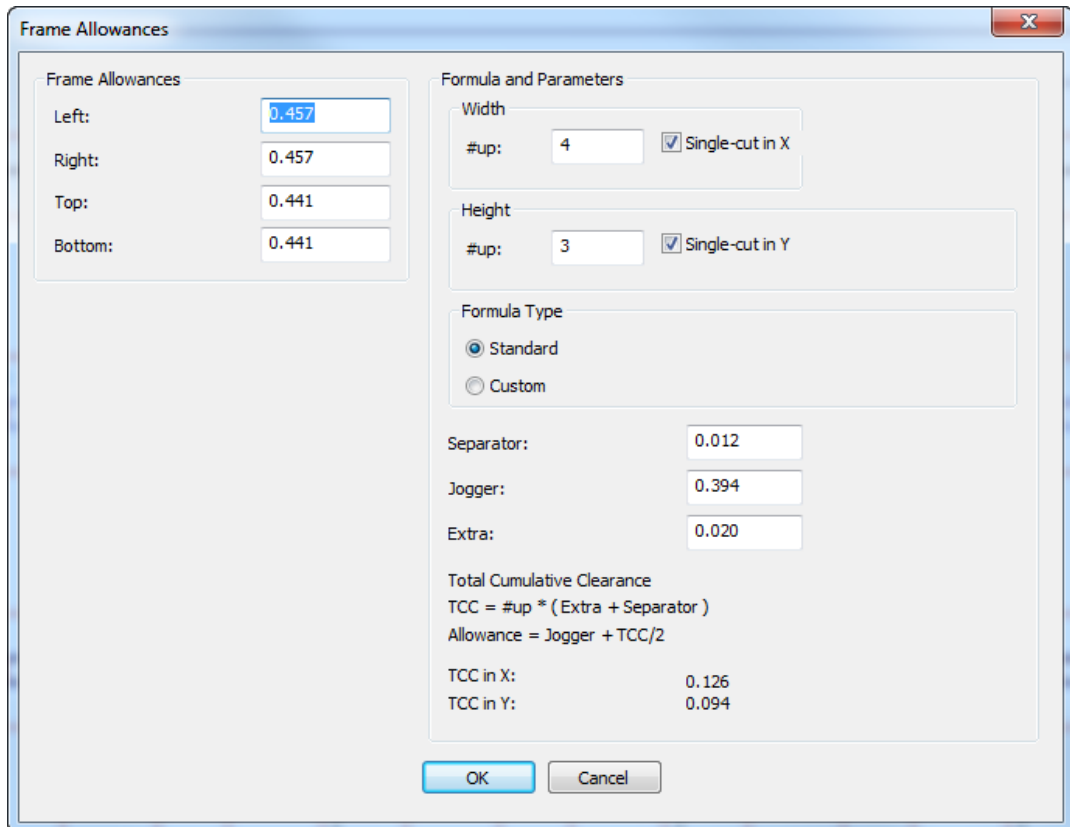

ArtiosCAD creates the grid frame, which is represented as double green lines around the layout.

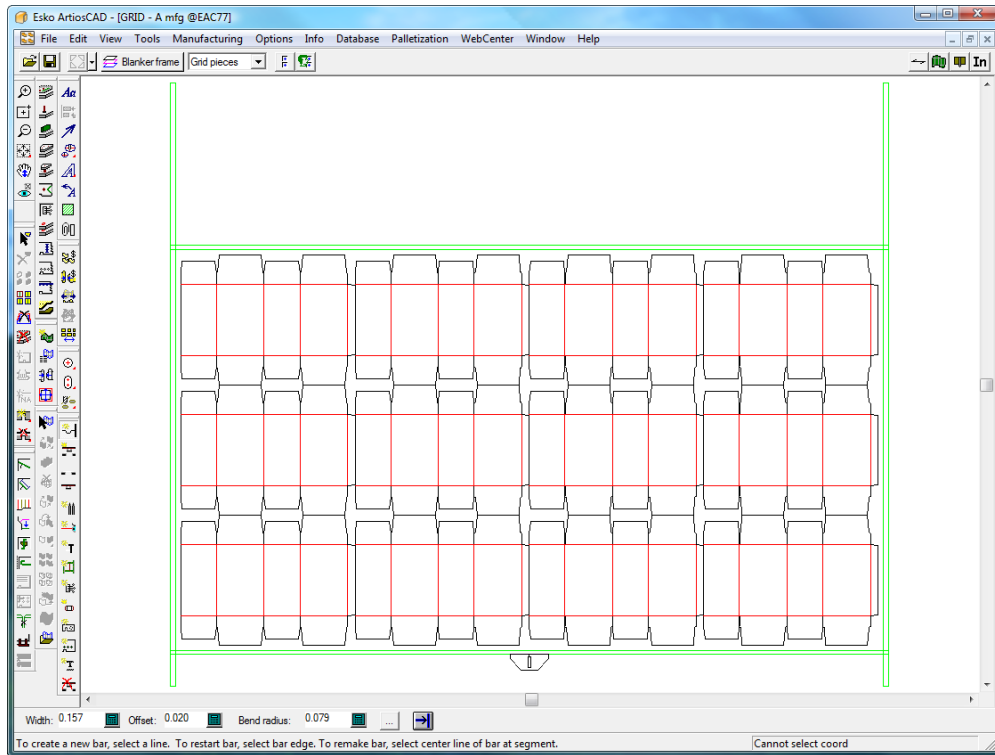

7.  Use **Add Grid Bar**, **Add Jogger Guides**, and **Add Hardware** to construct the grid. More information about how to use them is later in this guide.

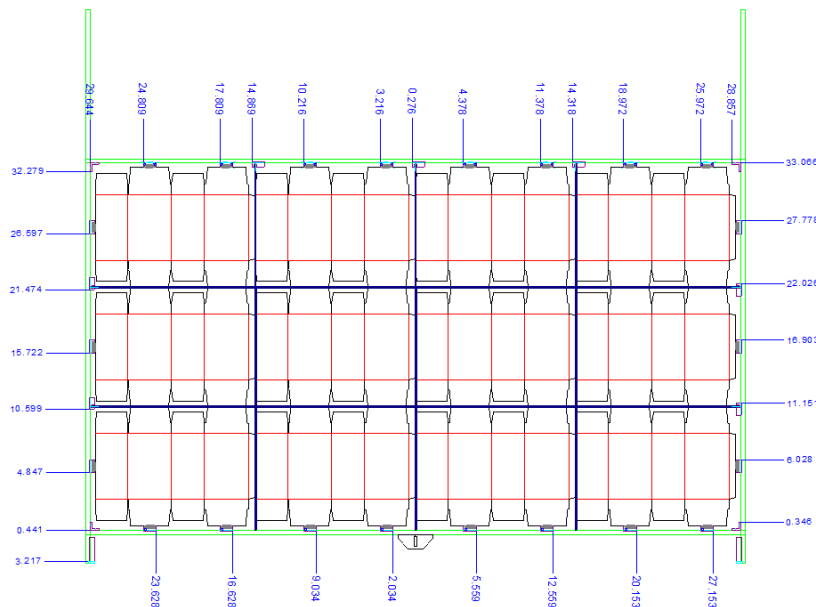

8.  Use **Add Non-Stop Swords** and **Add Photocells** to add those parts.

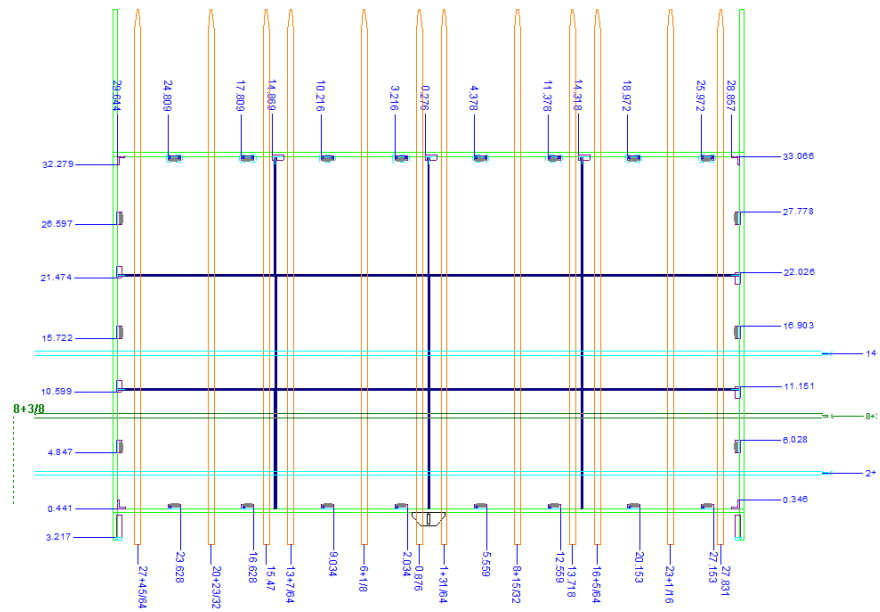

9.  Use **Generate Blanking Tools** to create the pushers and the upper board.

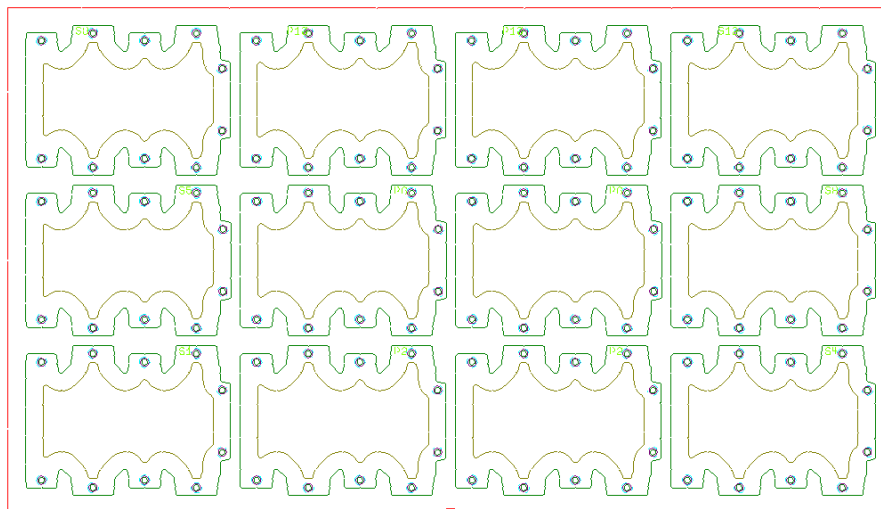

10.  Use **Adjust Pushers** to adjust the offsets from the pusher edge to the grid and/or design edge.

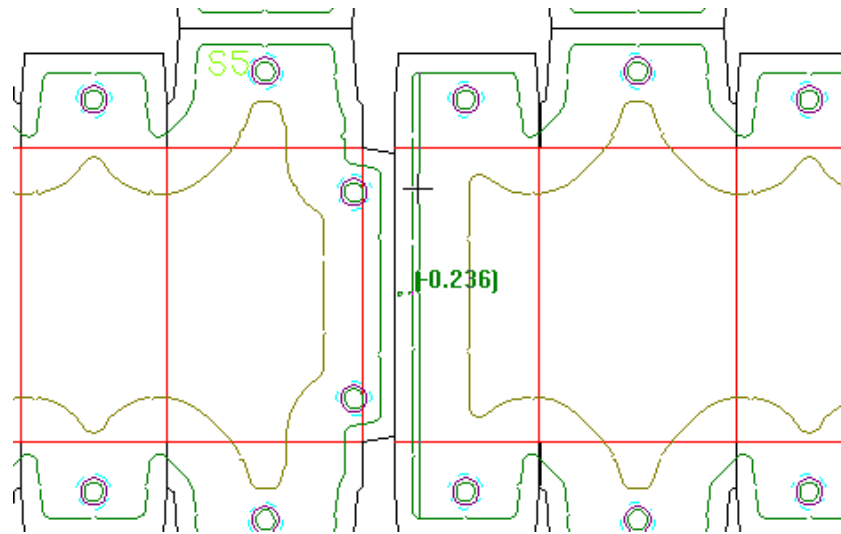

11.  Finish the upper board by using **Add Tie-bolts** and **Add Pressers** to add the pressers.

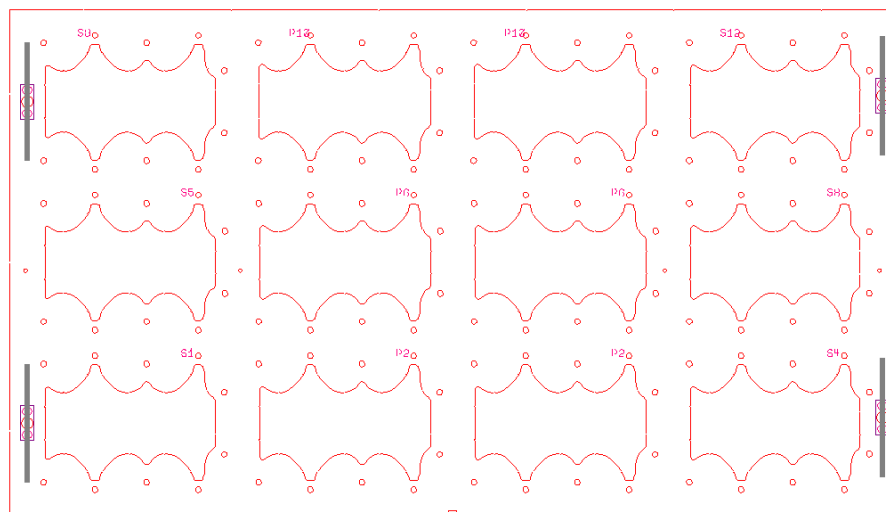

12. Save the workspace and run a blanking Output such as the Blanking Parts Report shown below, or one of the grid bar reports.

Blanking Parts Report

File: GRID.MFG
 Date: 05/23/2011
 8 - Front jogger 10mm
 8 - Rear jogger 10mm
 6 - Side jogger 10mm
 7 - Grid Clamp for frame tool
 4 - M6
 4 - Long presser 6mm
 120 - SOP 10mm rnd

Blanking Example Workflow: Lower Board

Another common blanking method is using a lower board with holes in it for the blanks to be pushed through by the upper board. Here is one way to make a lower board blanking tooling set.

1. Design a layout in ArtiosCAD.
2. If desired, create stripping tools for the layout. Use **Include Strip Rules** to tell ArtiosCAD which stripping rules to respect when creating the blanking tools.

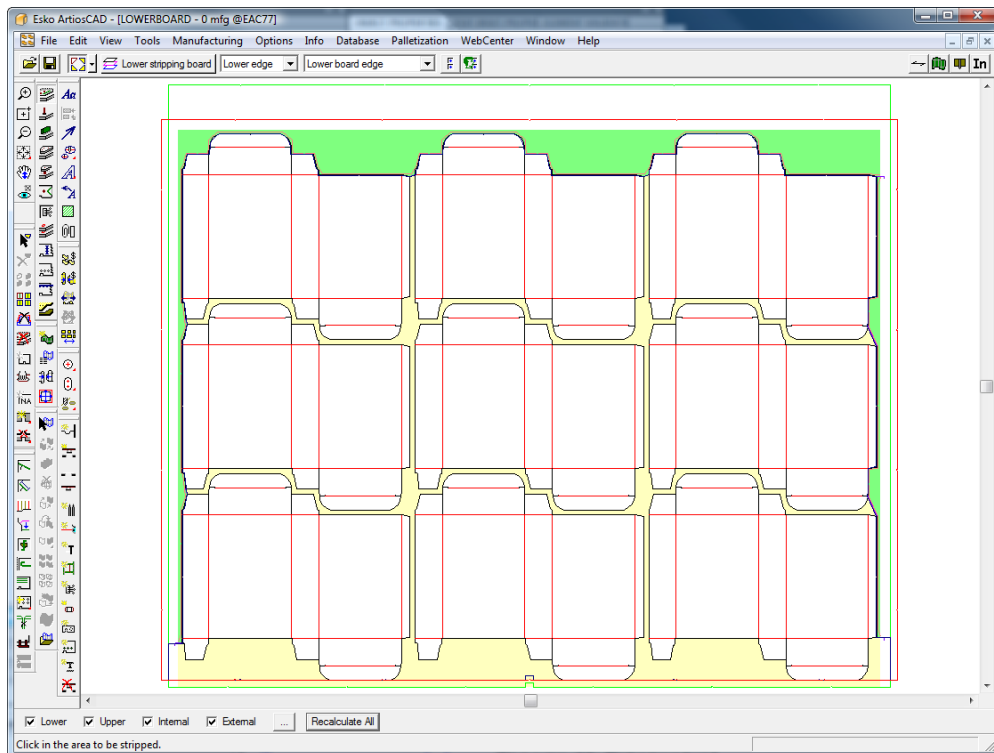

3.  Click **Generate Blanking Tools** on the Blanking toolbar.
4. Choose a blanking machine parameter set and click **OK**.

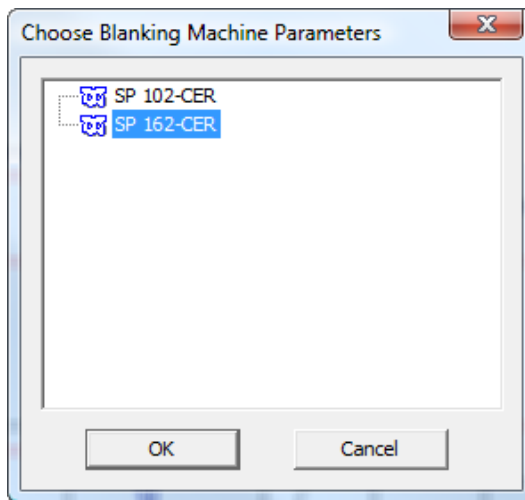

5. In the Choose Blanking Parameter Set dialog box, depending on if your layout is double-cut (the designs have a gutter between them) or single cut (the designs share common knives on their exteriors), choose either **Flat top (double knife)** or **Flat top (knife to knife)** and click **OK**.

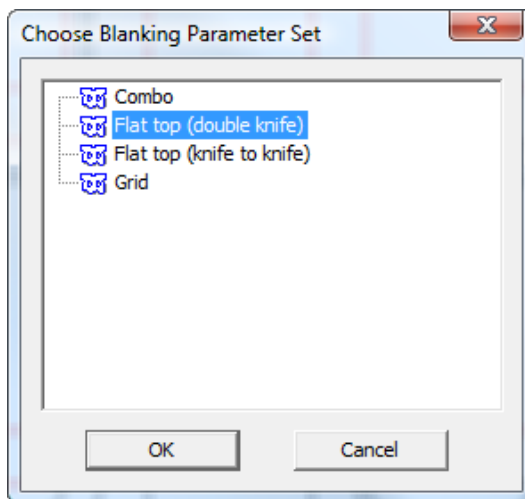

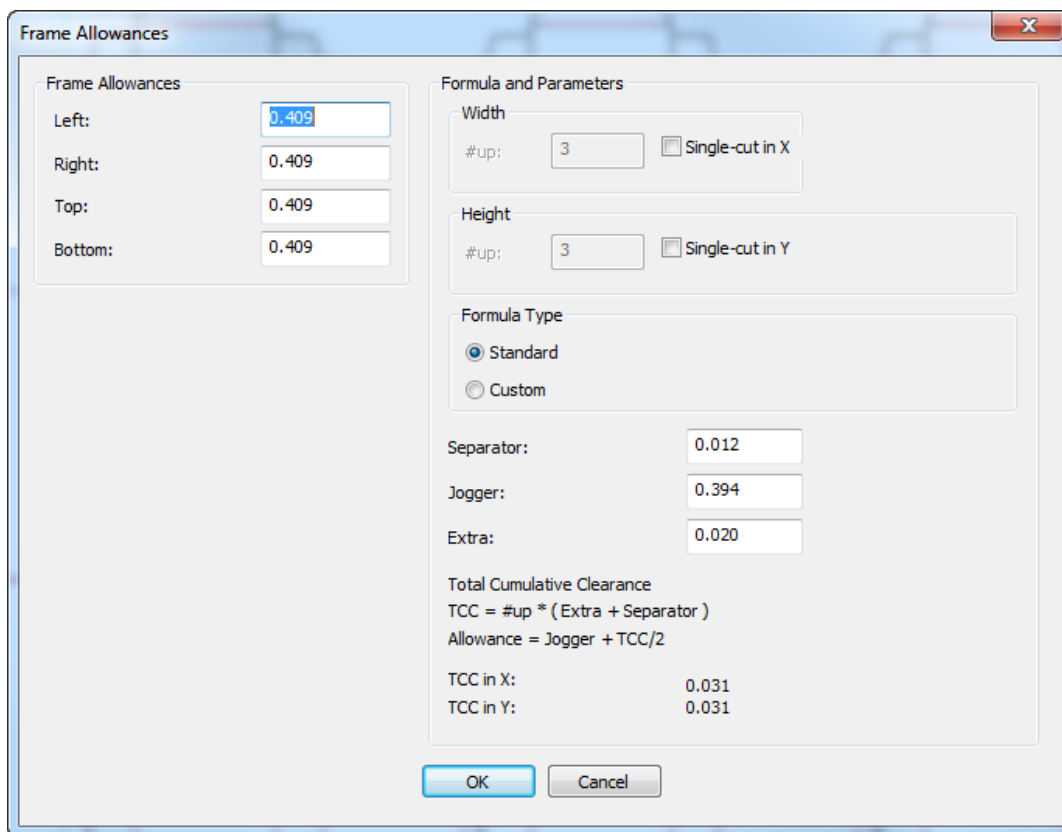

6. In the Frame Clearance dialog box, change any values as desired and click **OK**.



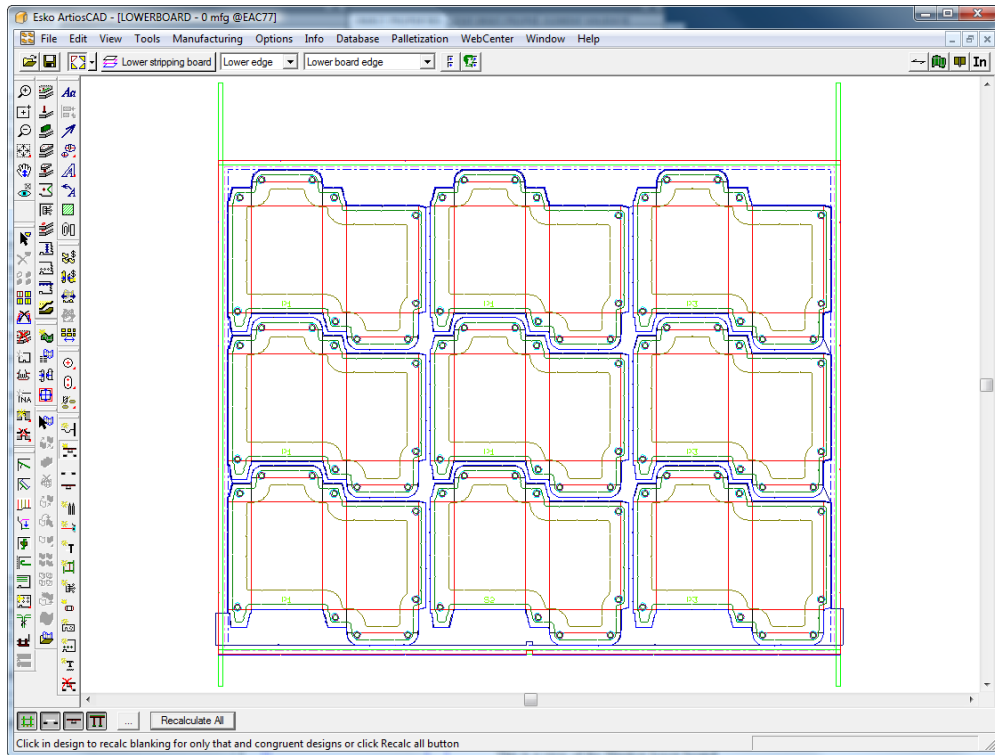

7. Make sure all four mode selection buttons are selected and click **Recalculate All** on the Status bar.

ArtiosCAD automatically generates the frame, holes, and pushers for the layout.

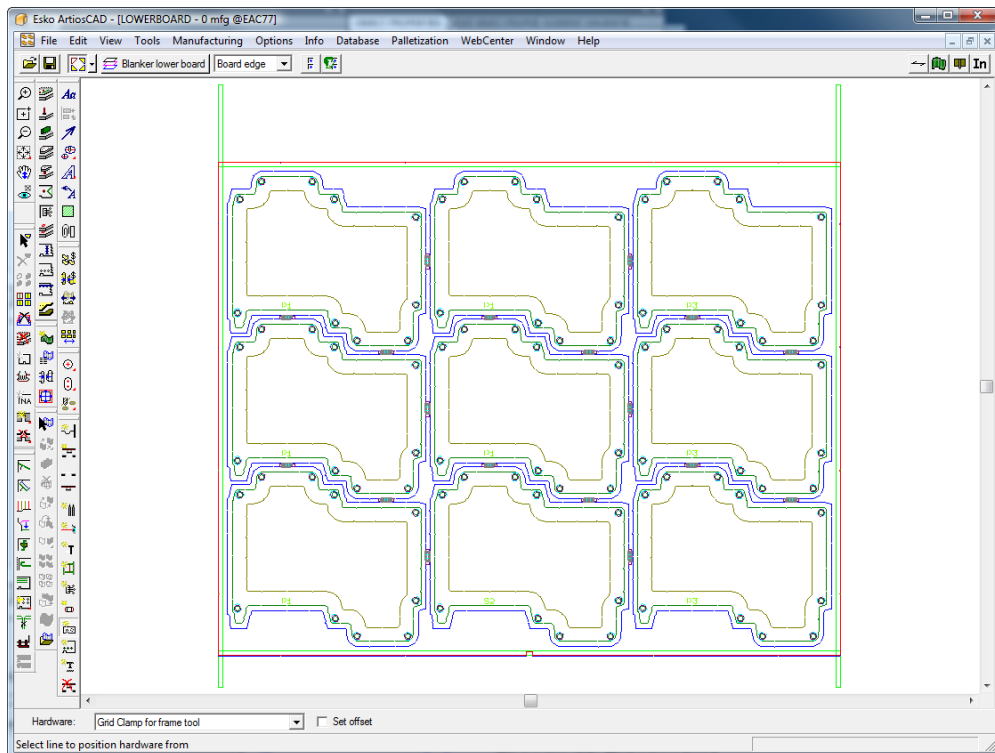

8.  Use **Add Jogger Guide** and **Add Hardware** to add more hardware. More information about how to use them is later in this guide.



9.  Use **Add Non-Stop Swords** and **Add Photocells** to add those parts.

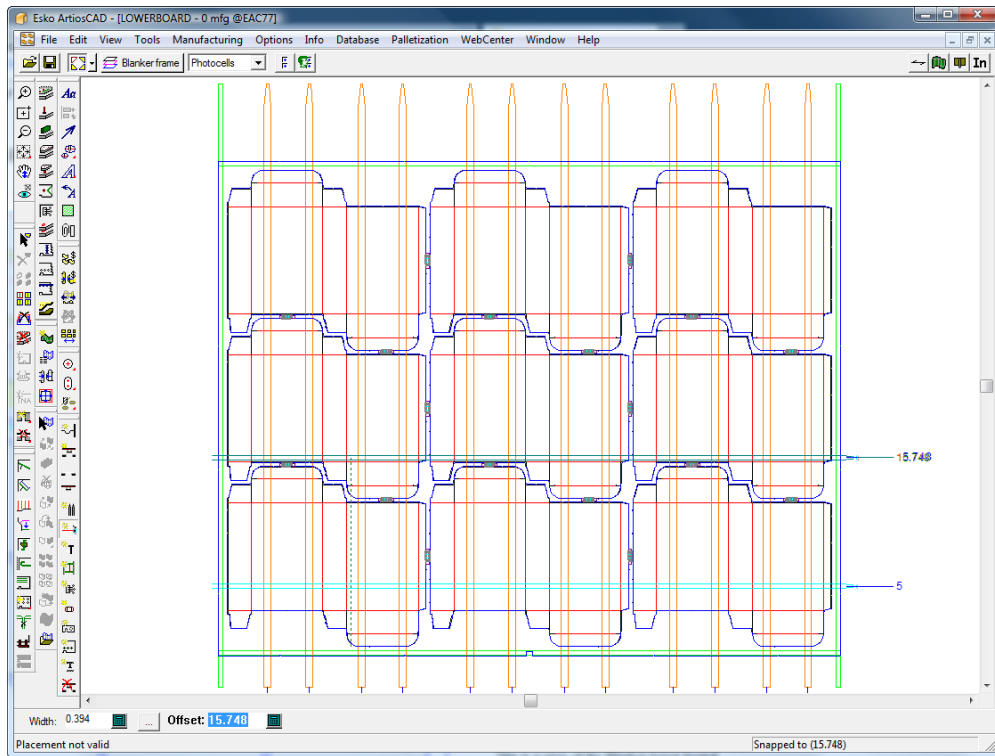

10.  If desired, use **Adjust Pushers** to adjust the offsets from the pusher edge to the hole and/or design edge.

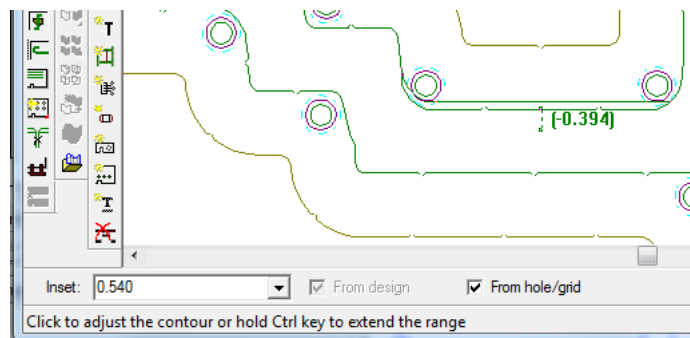

11.  Finish the upper board by using **Add Tie-bolts** and **Add Pressers** to add the pressers.

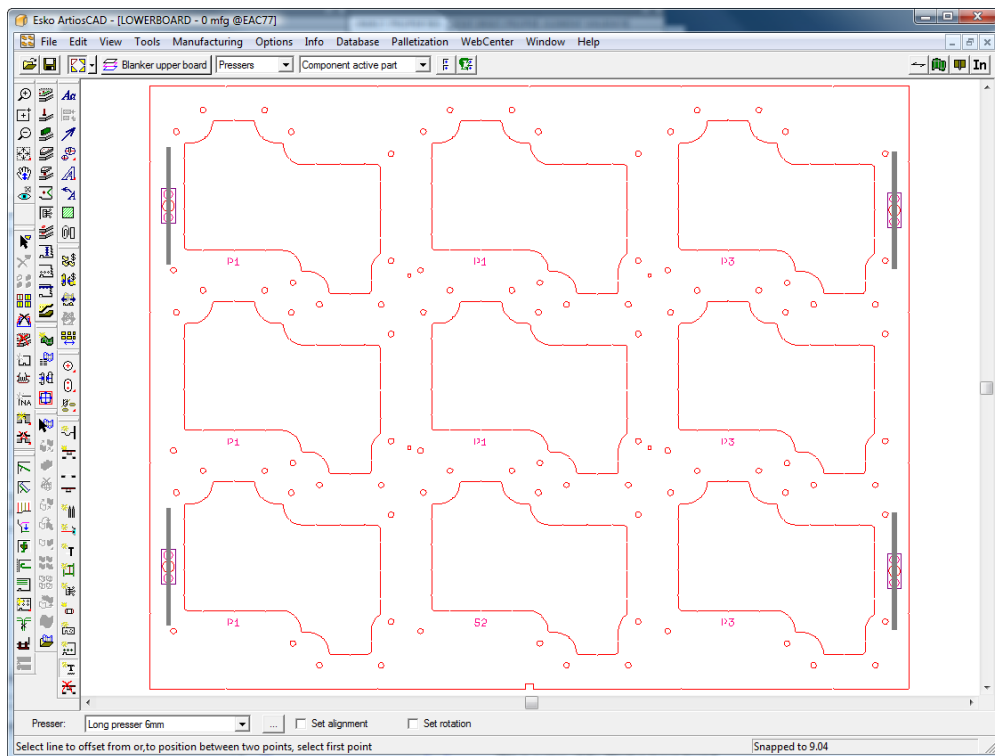

12. Save the workspace and run a blanking Output such as a Blanking Parts Report.

Blanking Tools Reference

This section explains how to use each tool on the Blanking toolbar.

Add Grid Bar tool

 The **Add Grid Bar** tool lets you add grid bars when constructing a grid-type lower blanker board. Grid bars separate the blanks as they are pushed through the grid. Use this tool to follow the contours of a blank and ArtiosCAD will construct the grid bar to match.

When this tool is active, the Status bar looks as follows.

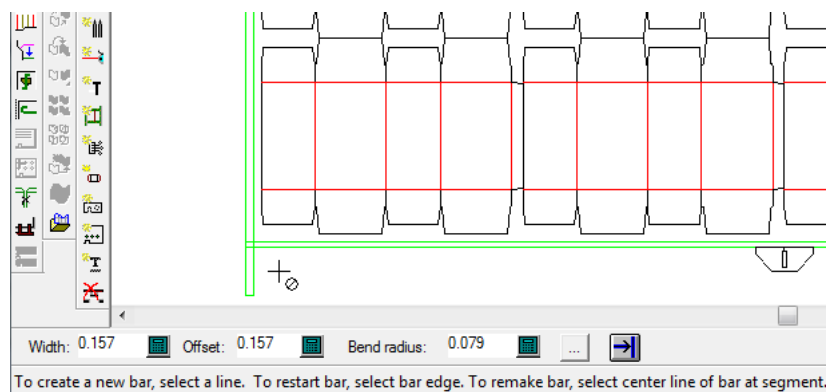

The **Width**, **Offset**, and **Bend radius** fields all control the dimensions of the grid bar. The **Properties (...)** button opens the Blanking parameter sets dialog box.

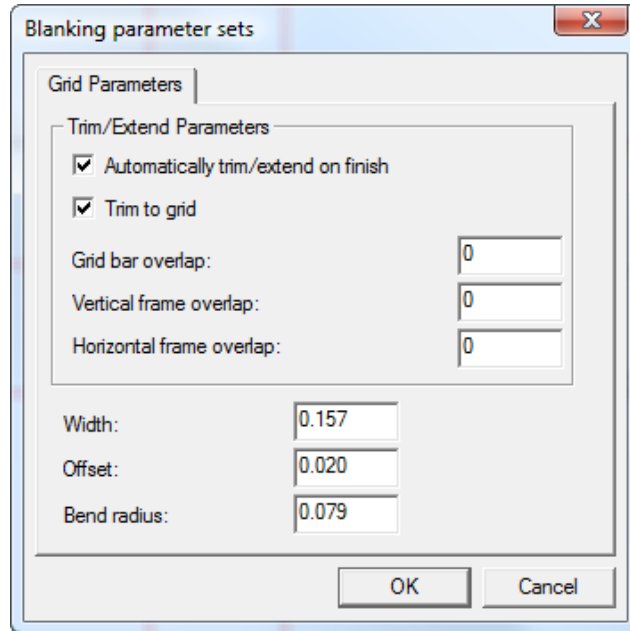

These parameters are explained by the following diagram, with the green lines being the frame edge and the triple black lines being a blanking grid bar (with **Fills and strokes** in the Styles group of the View mode turned off and **End points** turned on). The rectangle with the point is the blank.

Note:

These parameters are saved with the manufacturing workspace.

Automatically trim/extend on finish trims or extends the grid bar so that it meets the frame when you click **Finish** on the Status bar, and **Trim to grid** trims the grid bars against each other.

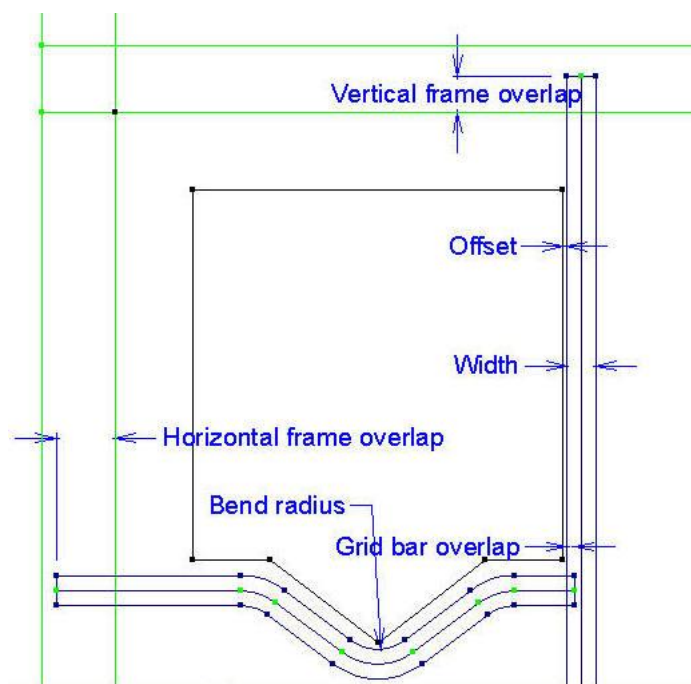

In the diagram above, the grid bars are not filled and the end points are visible. To see just the edges of the grid bars, turn off **Fills and strokes** in the Graphics section of the View Mode; to see the edges and middle of the grid bars, turn off **Fills and strokes** in the Styles section of the View Mode but leave it on in the Graphics section.

 **Finish** extends the grid bar to the closest frame edge if **Automatically trim/extend on finish** is enabled in the Grid Parameters dialog box, and if Auto-Repeat is enabled, repeats the grid bar to congruent sections of the layout. ArtiosCAD restarts the tool so you can create a new grid bar.

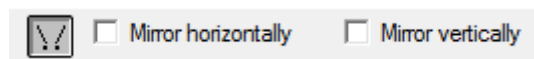



Copy Pickup/Putdown mode lets you copy a grid bar as you create it and optionally mirror it horizontally or vertically as desired.

To create a new grid bar, do the following:

1.  In a layout, click **Add Grid Bar** on the Blanking toolbar. If no blanking has been done so far, ArtiosCAD prompts you to select a machine and a parameter set, and creates the blanking frame.
2. Click the line in the blank closest to the grid frame against which the grid bar is offset. Drag will appear from the grid frame allowing you to position the grid bar either on top of the line or offset from it depending on where you position the cursor - either to the left or right of the line. Hold down **CTRL** to set the offset halfway between the line and the cursor as indicated by the drag. To center a grid bar between two points (instead of offsetting it from a line), click those two points. The cursor has a circle with a slash through it when you are not close enough to a line.
3. Click the next lines in the blank to follow, using the position of the cursor to determine the offset, or click a point to offset the segment halfway between the point and the line. Click the line itself to center the grid bar on the line. Use **Copy Pickup/Putdown** mode to aid construction where possible. Copy Pickup/Putdown mode is available as you are

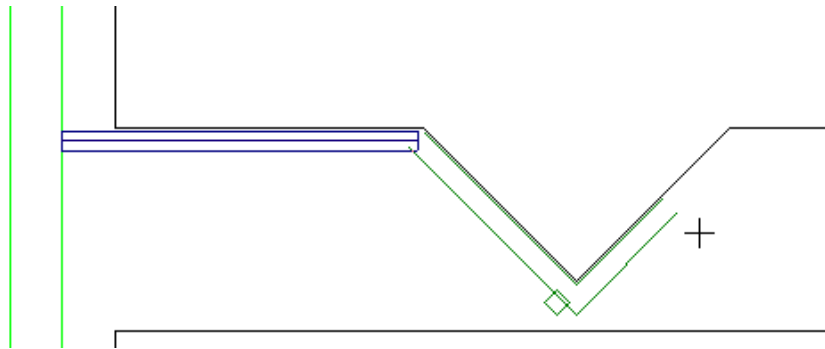
constructing grid bars. First click the button on the Status bar, then select the grid segment to copy, and then click the pick-up point and the put-down point.



4. Continue constructing grid segments, using **Undo** and **Redo** to correct mistakes.
5.  When you have rounded the last bend before the frame, click **Finish** to extend the grid bar to the edge and Auto-Repeat it to congruent areas if Auto-Repeat is enabled.
6. Create the other grid bars in the same way. The example below was created by following the blank lines horizontally but using the two points on adjoining blanks to construct the vertical segments.

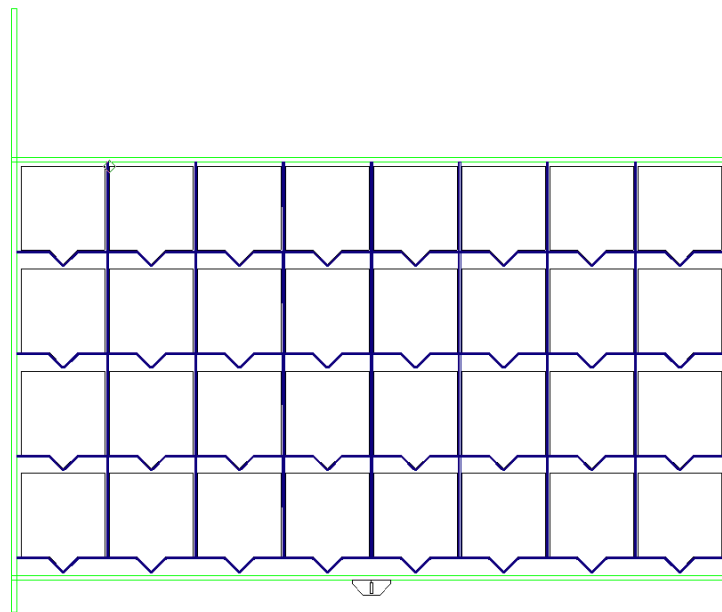

To see which end of a grid bar is the start and which is the end, turn on **Direction** in the View Mode.

To restart a grid bar, click the edge of the end of the bar.

To reverse the direction of a bar and recreate it, click the edge of it near its start and click **Yes**.

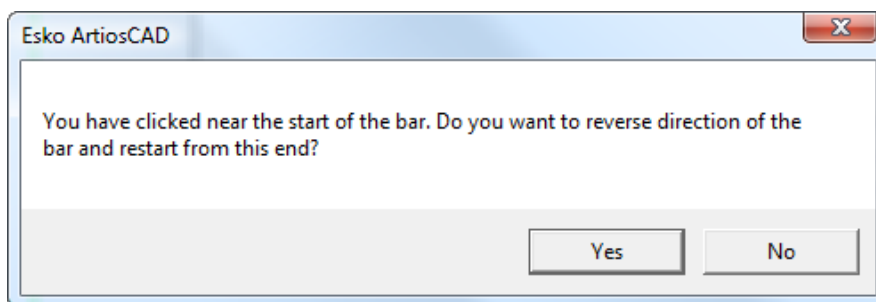

Include Strip Rules tool

 The **Include Strip Rules** tool allows you to mark stripping rules to be respected during blanking tool generation to result in merged blanks. It indicates how double-knife blanks should be blanked together by having you select the stripping rules that join their outlines. It can modify the lower hole and pusher contour, or just the lower hole. It works only with stripping rules, not carrier rules or scrap knives.

When you activate the tool, ArtiosCAD:

- Shows all lines as gray except for stripping rules
- Changes the current layer to Lower Blanker
- Turns off the other blanker layers
- Turns off the Sheet layer
- Turns on the Design layer
- Turns on the Stripping layer
- Deletes any existing respected stripping rules that do not overlap a stripping rule and displays the remaining ones (in case you have made changes to the stripping rules since last running the tool)

This tool has the following controls on the Status bar:



Clear all clears all stripping rules from being included in blanking calculations, and **Lower only** only merges the holes in the lower board, and does not merge the pushers.

Note: If **Lower only** is checked, checking **Merged pusher** on the Pusher Edge tab when generating blanking tools has no effect.

If you did not use this tool, ArtiosCAD would generate blanking tools like the ones shown below this layout:

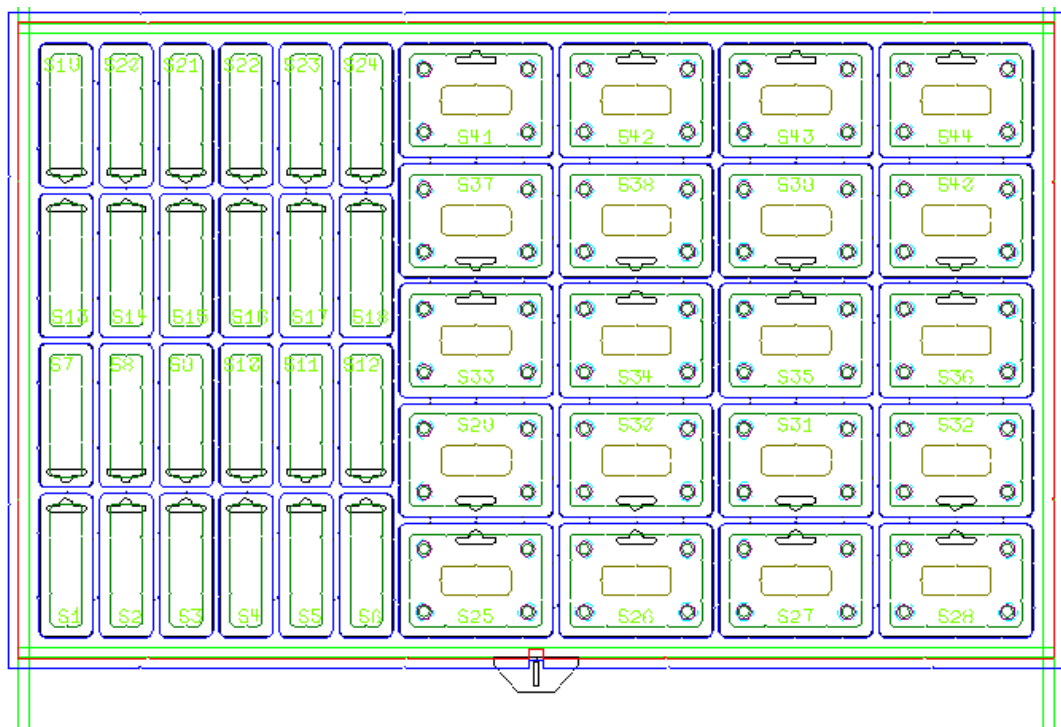
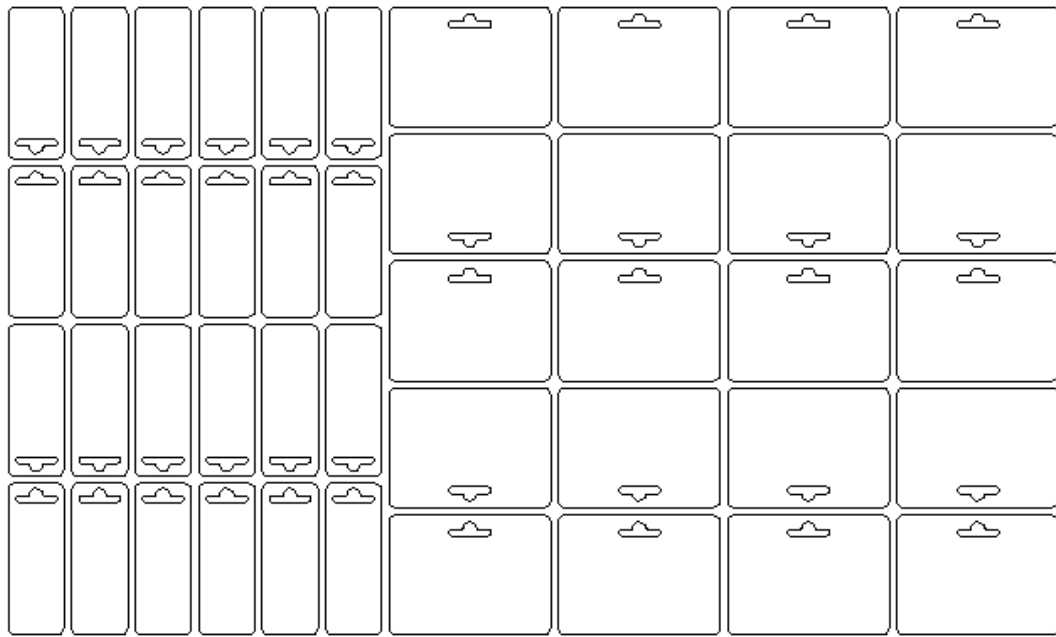

To use this tool, do the following:

1. Create the layout as desired and add striping rules between stations to make a merged outline.
2.  Click **Include Strip Rule**.
3. Hover over a striping rule to respect for blanking. The cursor changes to an arrow with a plus sign.

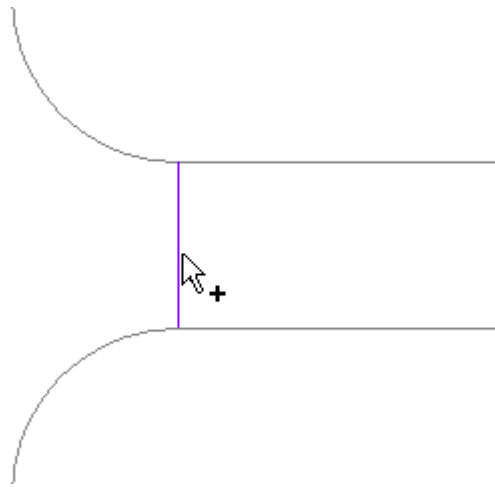

4. Click the rule. It turns green.

Note: To select or deselect many rules at once, hover away from a rule, and click and drag to define a marquis selection. If congruency is on, any congruent lines outside the selection window are also selected.

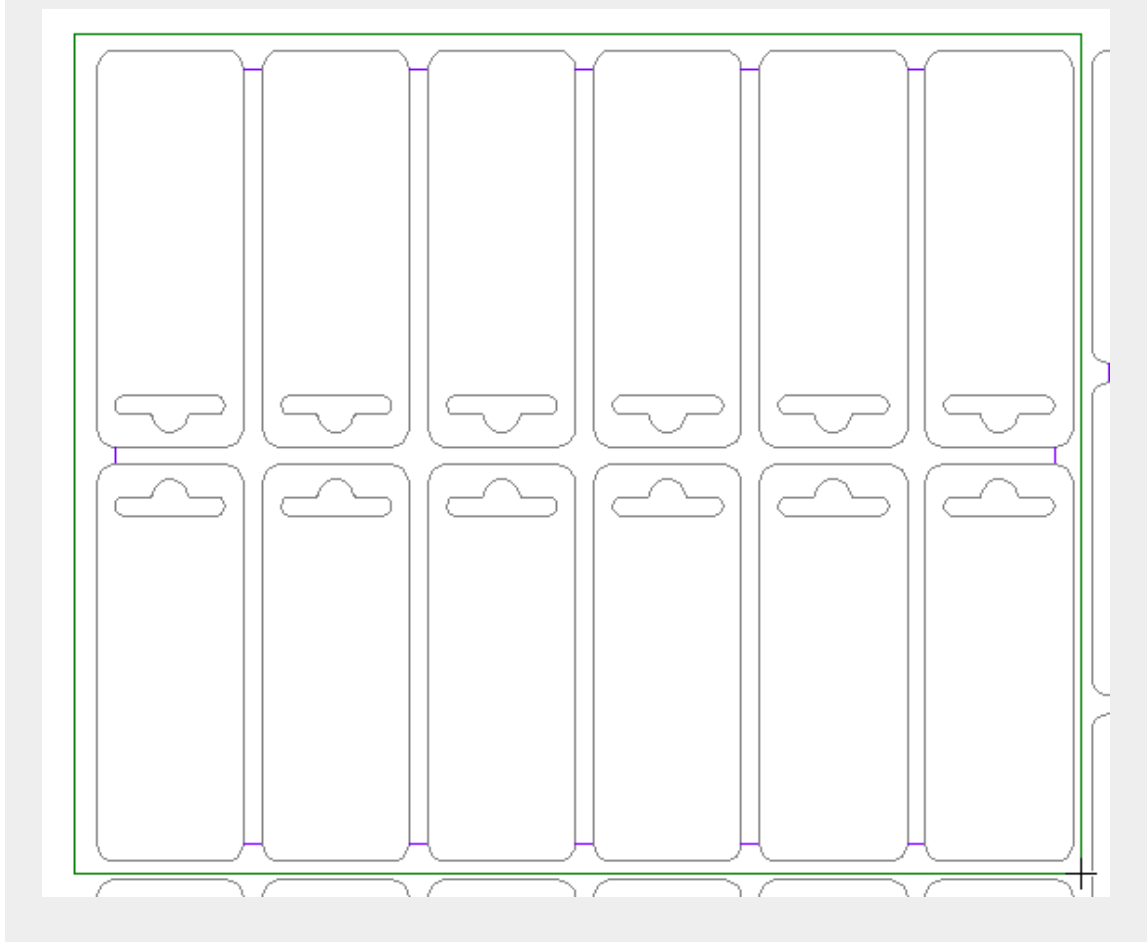

- To revert a respected rule back to a normal stripping rule, click it again. The cursor will change to a minus before you click.

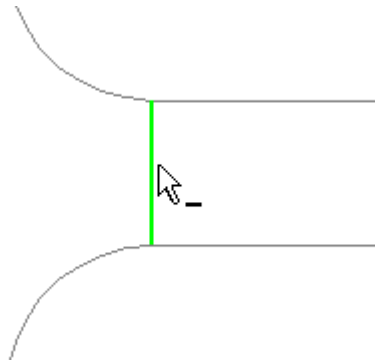

- Repeat the process of selecting rules to respect.

After using this tool, generating the blanking tools should result in blanking tools similar to these:

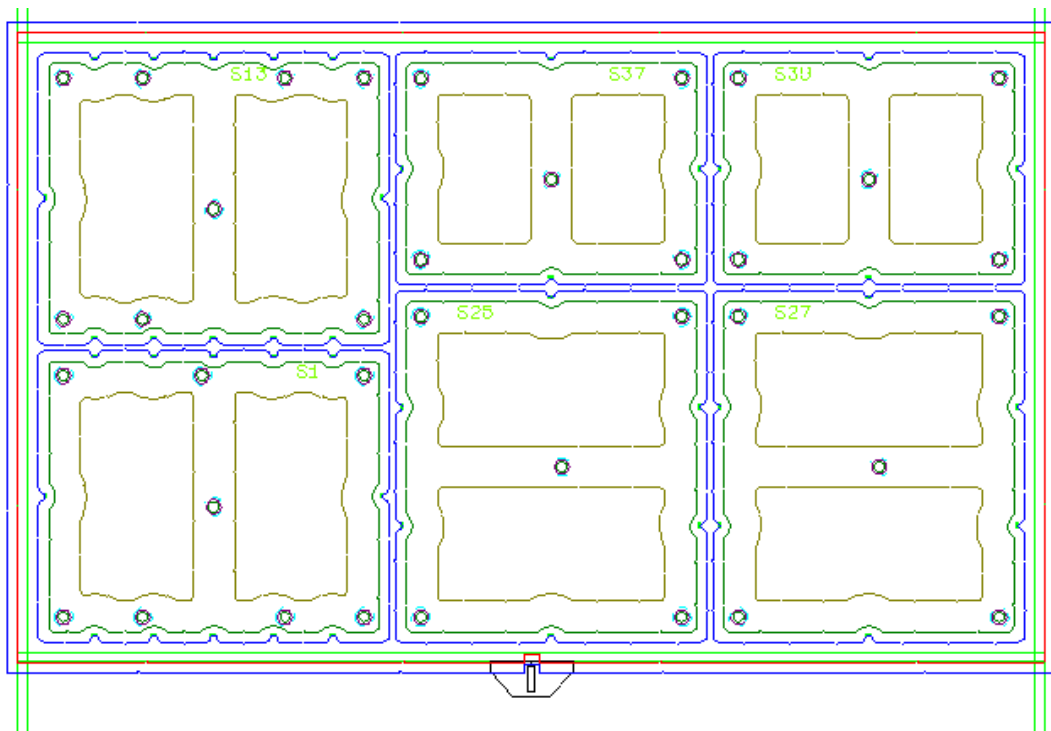



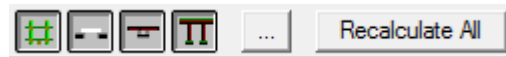

Generate Blanking Tools tool

 **Generate Blanking Tools** is a one-click method to create blanking tools. It can create the frame, generate blank holes in the lower board (if used), generate pushers, and so on depending on the parameter set you choose. It does not create grid bars.

This tool has the following controls on the Status bar:



Control	Generates
	The blank frame
	The blank holes - creates blank holes and the lower board wood edge
	The pusher contours - creates pushers and upper board wood edge
	The pusher details

The initial states of these controls are determined by which layers contain anything or are turned on. These controls are independent from each other; click the ones corresponding to the blanking elements for ArtiosCAD to generate. Hold down CTRL to toggle the state of the other controls as you click one.

Clicking the Properties button (...) opens the Blanking Parameter Sets dialog box whose contents are based on the controls selected for generation on the Status bar.

Clicking **Recalculate All** generates the selected tools with the parameters from the Blanking Parameter Sets dialog box. To generate the tools for just one blank, click inside the single design for that blank.

Your Blanking Parameter Sets dialog box may not have the same tabs as the example shown below.

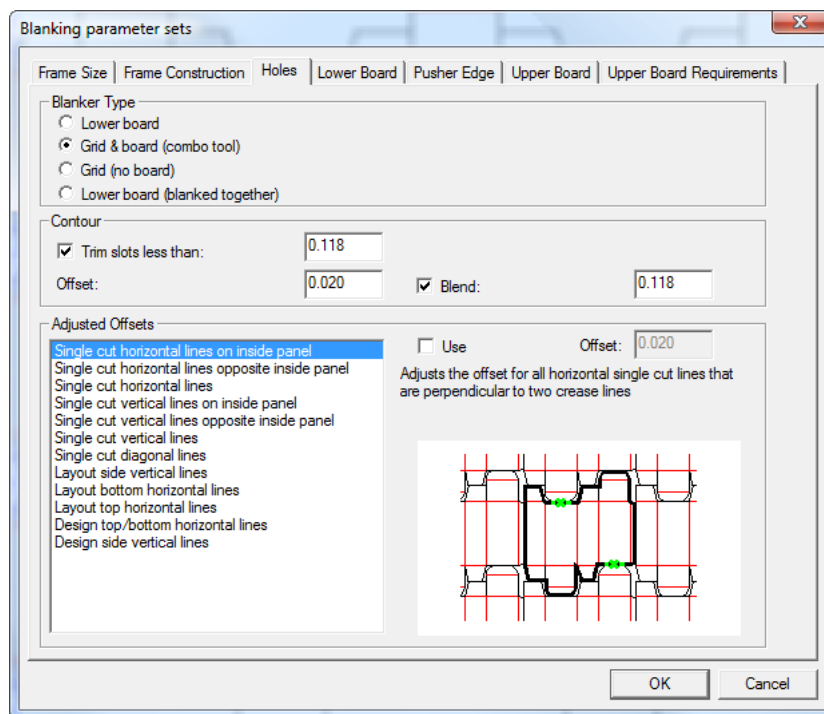

Set the allowances and clearances for the frame on the **Frame Size** tab:

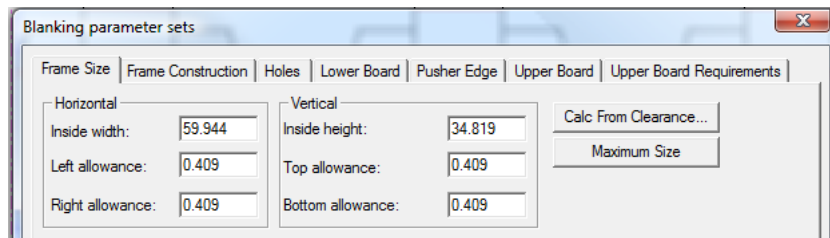

The frame allowances are relative to the layout size. **Calc From Clearance** opens the Frame Allowances dialog box discussed in the Frame Creation section. When you close the Frame Allowances dialog box, the values on the Frame Size tab are updated accordingly.

Clicking **Maximum Size**:

- sets **Inside width** and **Inside height** to their maximum values allowed by the machine
- leaves **Bottom allowance** unchanged
- resets the **Top allowance** to (Maximum height - layout height - Bottom allowance)
- recalculates the **Left allowance** and **Right allowance** to (Maximum width - layout width/2).

Set the positions and sizes for the frame pieces on the **Frame Pieces** tab.

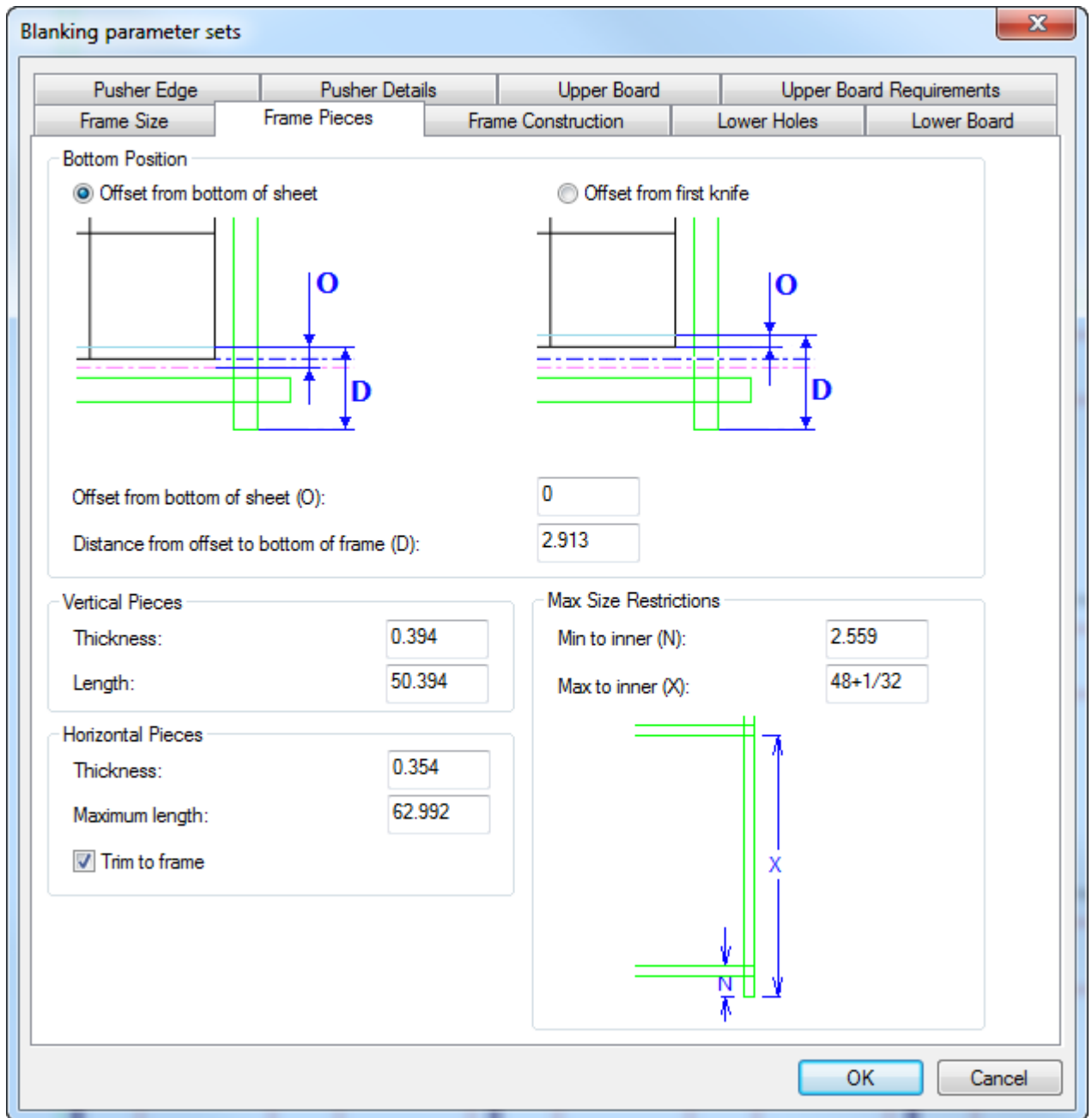

In the **Bottom Position** group, choose how to calculate the distance to the bottom of the frame - from the bottom of the sheet or from the first knife. The location of the first knife is sometimes called P13.

Set the sizes of the frame pieces in the **Vertical Pieces**, **Horizontal Pieces**, and **Max Size Restrictions** groups. **Trim to frame** lets you choose to trim the horizontal pieces to fit this frame or to keep them full-size for use with other frames.

Set the parameters for the frame's construction on the **Frame Construction** tab.

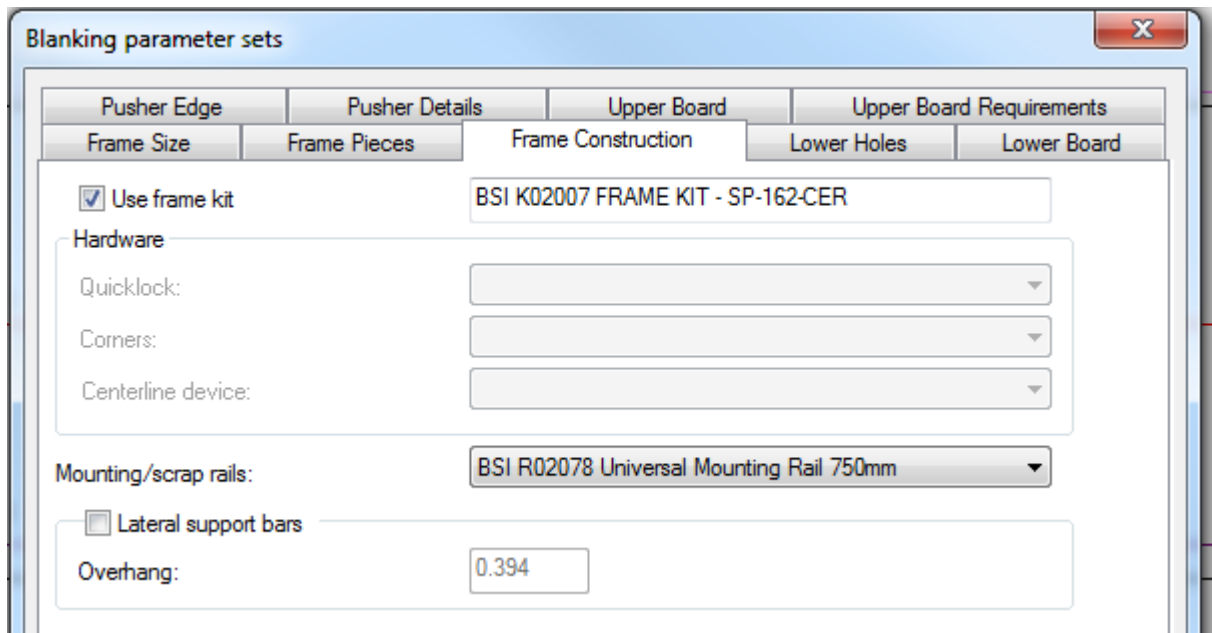

If you will be using a BSI frame kit for this set of blanking tools, check **Use frame kit**. It is associated with the Blanking machine parameter set and cannot be changed when you are generating the blanking tools.

If you are not using a BSI frame kit and thus **Use frame kit** is not selected, choose the type of hardware to use on the frame from the drop-down list boxes in the **Hardware** group. You can make your own custom hardware as geometry macros and add them to the Blanking catalog in the Geometry Macro catalog in Defaults.

If desired, choose the type of BSI mounting or scrap rails to use from the **Mounting/scrap rails** drop-down list box. ArtiosCAD draws them as red rectangles with screw holes on top of the green frame pieces. If you need to trim the stock rails, ArtiosCAD draws a line across the left one and shows the dimension to which you must trim it (and the right one) for the job.

If you will be using lateral support bars, check **Lateral support bars** and specify the **Overhang** distance.

The fields on the **Lower Holes** tab control how the holes are made in the lower board (if applicable). The **Adjusted Offsets** are available for all blanker types except **Grid (no board)**.

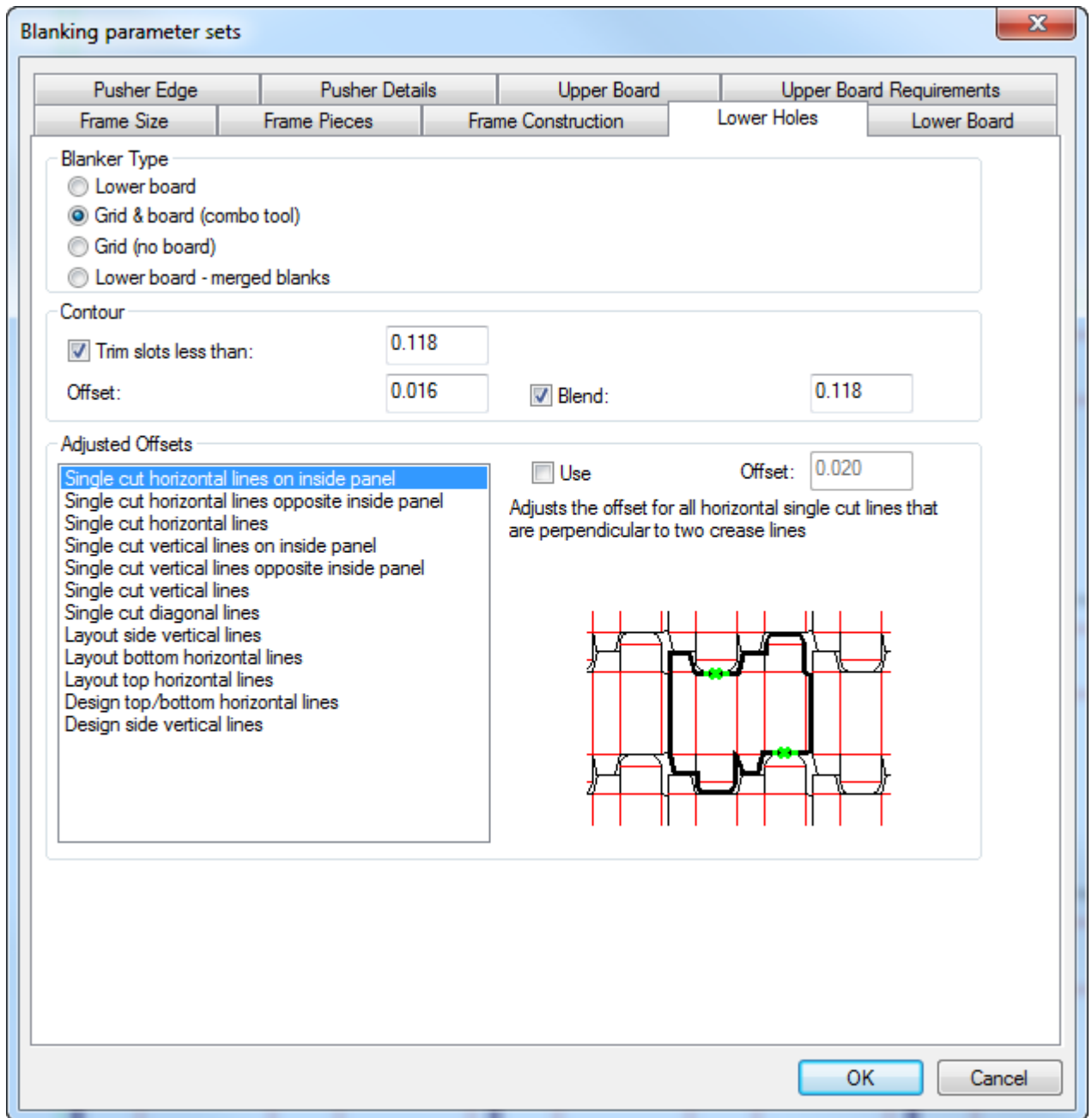

In the **Blanker Type** group, choose the type of blanking for the tool to perform. This should be pre-selected from the parameter set.

In the **Contour** group, set the values for the paths in the layout which ArtiosCAD will follow to create holes in the lower board.

In the **Adjusted Offsets** group, choose the type of lines that require adjusted offsets for their corresponding hole contours. The preview picture shows each type of offset. Make sure to check **Use** for each desired offset while it is selected, and adjust the size of the offset as needed in the **Offset** field. ArtiosCAD marks each in-use offset with an asterisk in its name. You can specify adjusted offsets for all blanker types.

As the size of the lower board is determined from the frame size, not the layout, the only fields on the **Lower Board** tab are for the allowances. The **Left, Right,** and Top allowances can be measured relative to the inner frame, outer frame, or the bar extent. The Bottom allowance can be measured relative to all of those and the bottom of the sheet. Each allowance defaults to the inner frame.

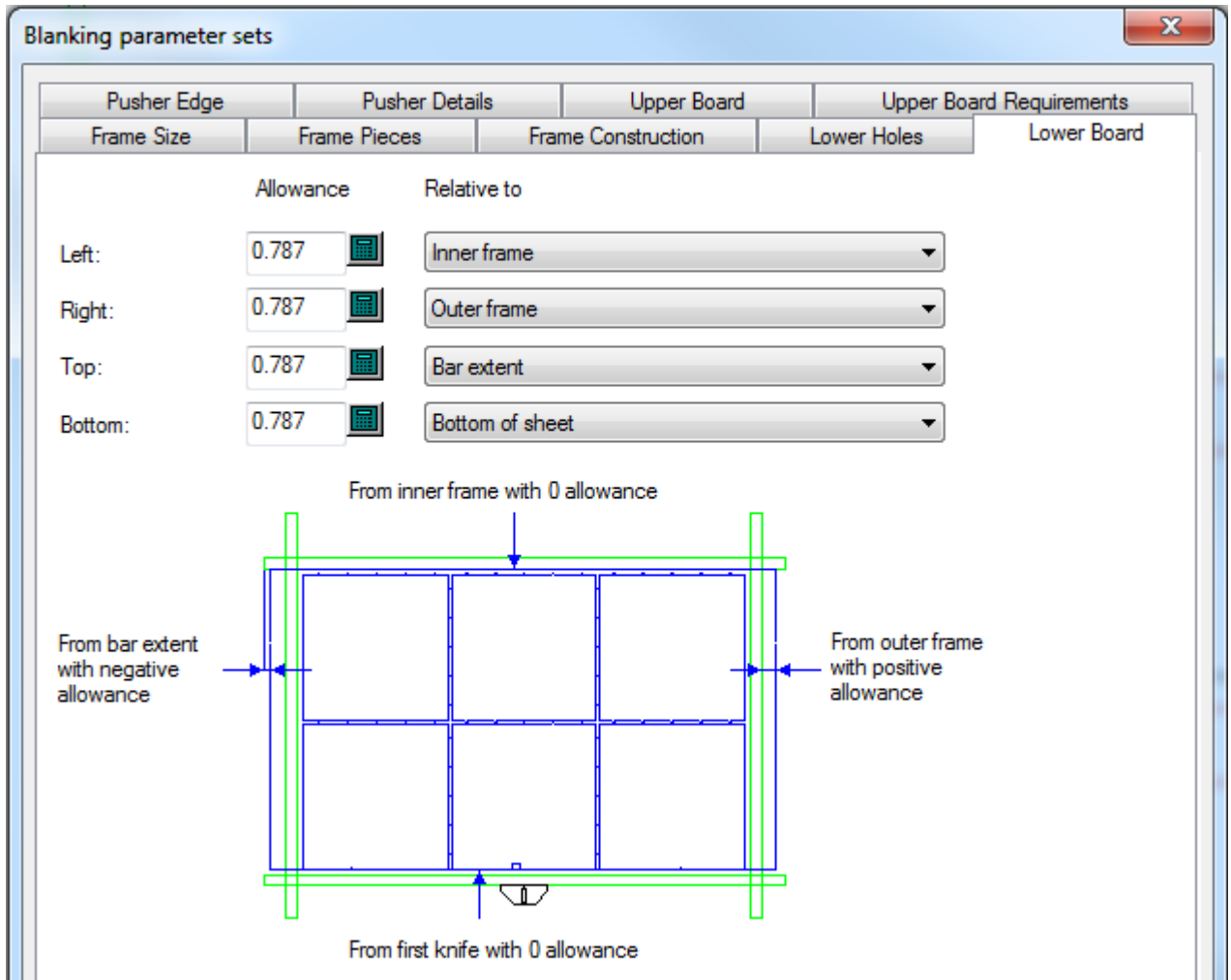

To adjust the lower board's alignment method and corner shape, right-click its edge after it is created and click **Properties** on the context menu.

The size of the upper board is based on the layout size, not the frame size. To adjust the upper board's alignment method and corner shape, right-click its edge after it is created and click **Properties** on the context menu. On the Upper Board tab, adjust the size and allowances as desired. Alternately, click **Maximum size** to make it as large as possible using the parameters from the **Upper Board Requirements** tab.

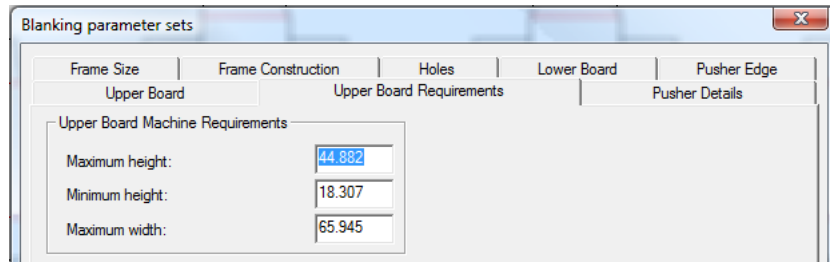
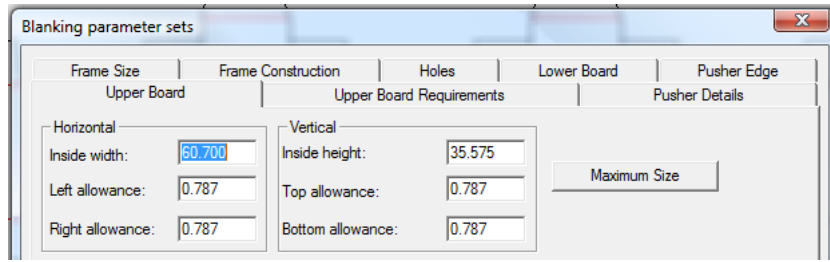

The **Pusher Details** and **Pusher Edge** tabs control the creation of the pushers on the upper board.

Settings for the air hole, blanker pusher pins, and pusher identification text are on the Pusher Details tab as shown below.

Blanking parameter sets

Frame Size	Frame Pieces	Frame Construction	Lower Holes	Lower Board
Pusher Edge	Pusher Details	Upper Board	Upper Board Requirements	

Air Hole

Inset from edge:

Duplicate in upper board

Merged hole

Reinforce large holes

Inset from edge:

Corner blend:

Slot blend:

Maximum size (M):

Bar thickness (T):

Blanker Pusher Pins

Distance from edge:

Preferred pin-to-pin distance:

Blanker pusher pin:

Pusher Identifier Text

Font:

Font size:

Duplicate in upper board

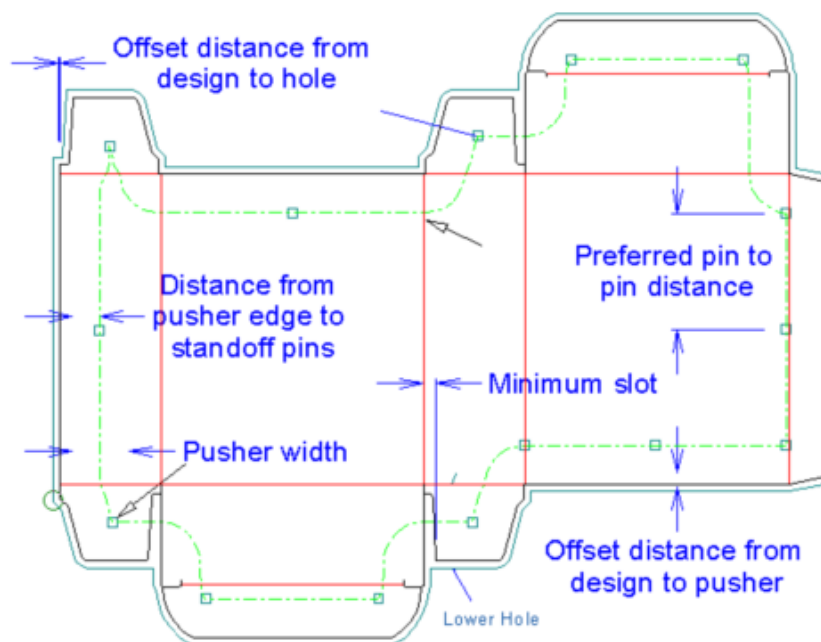

In the **Air Hole** group, set the options to control how ArtiosCAD makes the air holes in the pushers. When checked, **Merged hole** creates one air hole per pusher; deselect it to create one air hole per design. To make bars across large holes to reinforce them, check **Reinforce large holes** and set the **Maximum size** of each sub-hole and the **Bar thickness**.

Note: ArtiosCAD does not automatically place in the areas between non-merged air holes.

As with the frame, you can create your own blanker pusher pins as geometry macros and add them to the **Stand off pins** sub-catalog in the **Blanking** catalog of geometry macros in Defaults.

The pusher ID text is either an **S#** or a **P#** where # is a number, S stands for station, and P stands for pusher. The **P#** form indicates that there may be one or more other identical pushers. The **S#** form uniquely identifies the pusher in the layout. For example, if you have a double-knife layout of one design with Auto-Repeat enabled, then when you generate the pushers, all the pushers should have the same **P#** ID text. If you then disable Auto-Repeat and make an adjustment to a pusher, then that pusher will use the **S#** form.

The **Pusher Edge** tab controls how ArtiosCAD shapes the pushers. The options in **Adjusted Insets** work the same as the Adjusted Offsets do on the **Lower Holes** tab - select an inset, check **Use**, and set the inset in the field. Only insets with asterisks are used when ArtiosCAD generates the blanking tooling.

Note: **Merged pusher** has no effect if the **Lower only** checkbox is on when using Include Strip Rules.

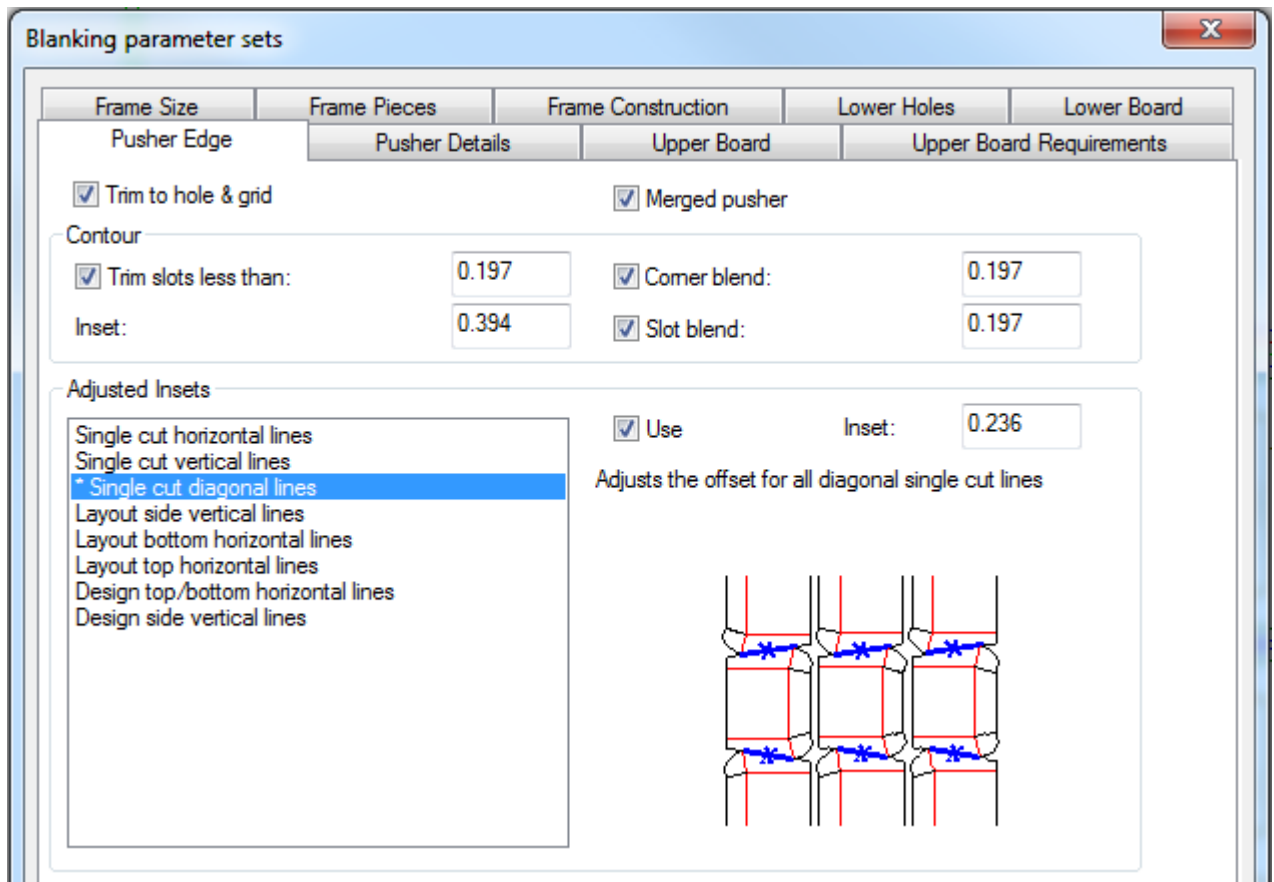

Once you have set the parameters on all the tabs as desired, click **OK** to return to using the tool.

To use this tool, do the following:

1. Create a layout in ArtiosCAD.
2.  Click **Generate Blanking Tools** on the blanking toolbar.
3. Choose the machine and parameter set.
4. Set the frame parameters in the Frame Allowances dialog box and click **OK**.
5. On the Status bar, choose the items to generate.
6. Click the Properties button (...) to open the Blanking parameter sets dialog box. In it, review the settings on each tab ArtiosCAD will use to generate the tools. Click **OK** when done.
7. Click **Recalculate All** on the Status bar.

Shown below is a set of blanking tools with everything generated.

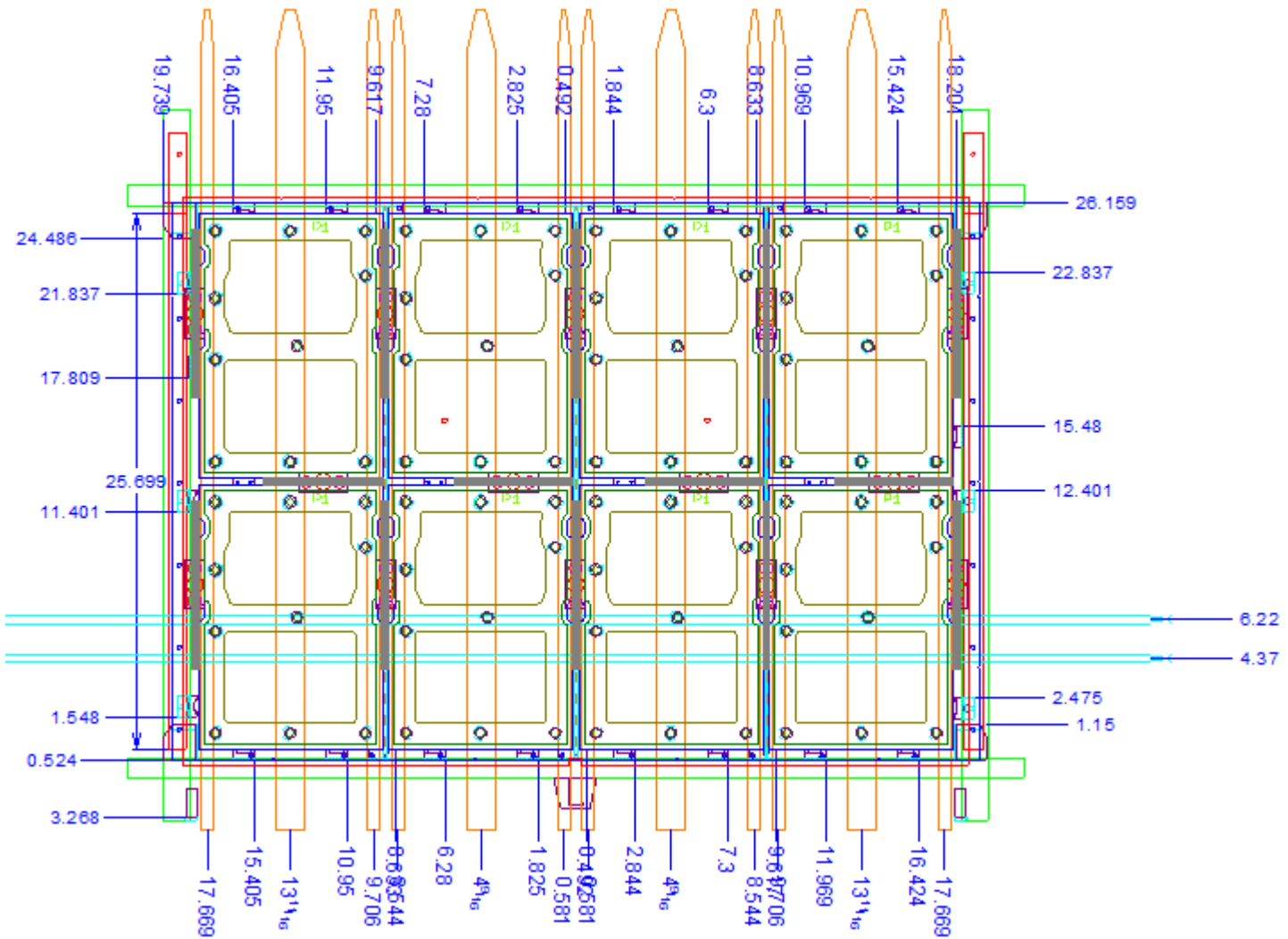

Adjust Blank Hole tool

 The **Adjust Blank Holes** tool on the Blanking toolbar allows you to adjust the shape of a blank hole in the lower board. If Auto-Repeat is enabled, ArtiosCAD modifies all congruent blank holes.

When you click this tool, ArtiosCAD turns on the Blanker lower board layer, turns off the other blanking layers, and puts an **Offset** drop-down list box on the Status bar:

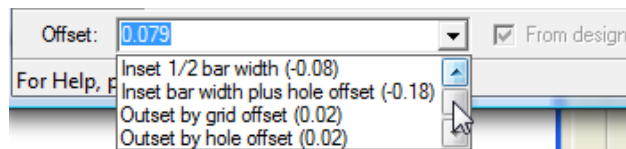

You can either type a value or expression in the **Offset** field or choose a value from the drop-down list. A positive number offsets the hole outside the blank; a negative number insets it inside the blank.

From design is unavailable, but when it is checked, it indicates that the current offset of the line or arc is the distance perpendicularly from the midpoint of the line to the design.

To use this tool, do the following:

1. Create a layout in ArtiosCAD and generate the lower blanking board.
2.  Click **Adjust Blank Holes**.
3. On the Status bar, adjust the offset as desired.
4. Move the cursor close to the line to change. The drag will indicate the adjusted offset while the number in the drag is the current offset. To change more than one line, hold down CTRL and drag to the next connected line.

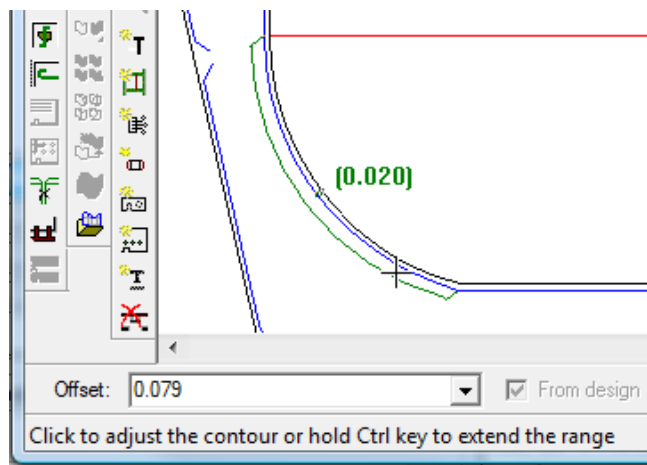

Note:

Only change one or two lines at a time as the adjustment's start angle is set by the first line you choose. Choosing more than two lines at a time may result in incorrect adjustments.

5. Click the line to change. To change more than one line at once, click the last line in the sequence.
6. ArtiosCAD adjusts the hole edge.

Adjust Pushers tool

 The **Adjust Pushers** tool changes the shape of the pushers on the upper board. When you click this tool, ArtiosCAD makes the Blanker pushers layer active and turns off the other blanking layers.

This tool has the following controls on the Status bar:



Inset is the distance the current pusher edge is from the hole edge or grid bar. A positive value moves the pusher edge further from the hole or grid; a negative value brings it closer. Any values you type in this field will appear on the drop-down list for later use in this session.

From design is unavailable, but when it is checked, it indicates that the current offset of the line or arc is the distance perpendicularly from the midpoint of the line to the design.

To use this tool, do the following:

1. Create a layout in ArtiosCAD and generate the blanking tools.
2.  Click **Adjust Pusher**.
3. On the Status bar, adjust the inset as desired.
4. Move the cursor close to the line to change. The drag will indicate the adjusted inset while the number in the drag is the current inset. To change more than one line, hold down CTRL and drag to the next connected line.

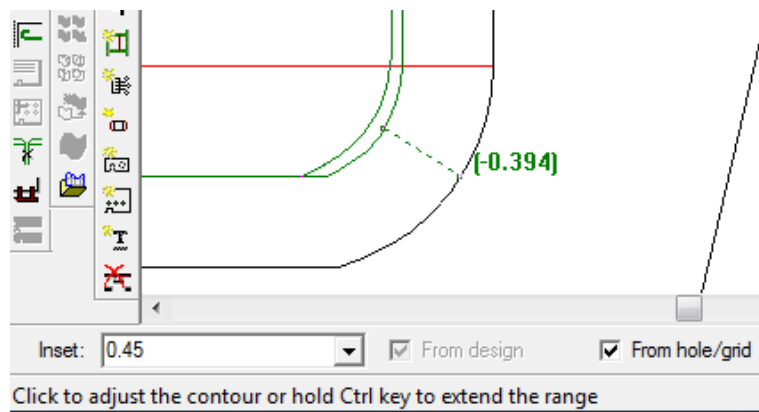

Note:

Only change one or two lines at a time as the adjustment's start angle is set by the first line you choose. Choosing more than two lines at a time may result in incorrect adjustments.

5. Click the line to change. To change more than one line at once, click the last line in the sequence.
6. ArtiosCAD adjusts the pusher edge.

Add Non-stop Swords tool

 The **Add Non-stop Swords** tool on the Blanking toolbar lets you indicate where the non-stop swords will go on the press. They may not overlap other swords or joggers. When you click this tool, ArtiosCAD turns on the Blanker frame layer and turns off the other blanking layers.

This tool has the following controls on the Status bar:

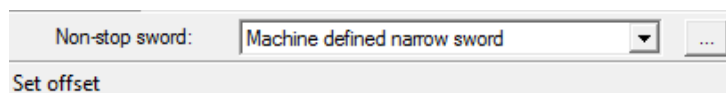

In the **Non-stop sword** drop-down list box, you can choose to add a machine-defined narrow sword, a machine-defined wide sword, or a custom sword.

Clicking Properties (...) opens the Blanking parameter sets dialog box where you can set the availability, number of prongs, and width of the swords.

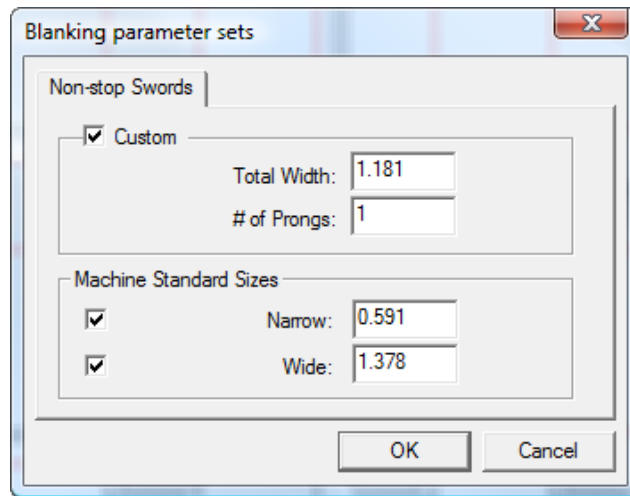

Click **OK** when you have set the values as desired.

To use this tool, do the following:

1. Create a layout in ArtiosCAD and generate the blanking tools.
2.  Click **Add Non-stop Swords** on the Blanking toolbar.
3. Select a line or point from which to offset the leftmost sword. Cut lines display their points when you place the cursor near them for easy placement, but you can select any design line. If you select a line, ArtiosCAD prompts you for the offset for the sword, which you can set with drag or by entering a value in the **Offset** field. If you select a point, ArtiosCAD prompts you for another point or freehand coordinate (by holding down CTRL) and places the sword halfway between that and the first point.

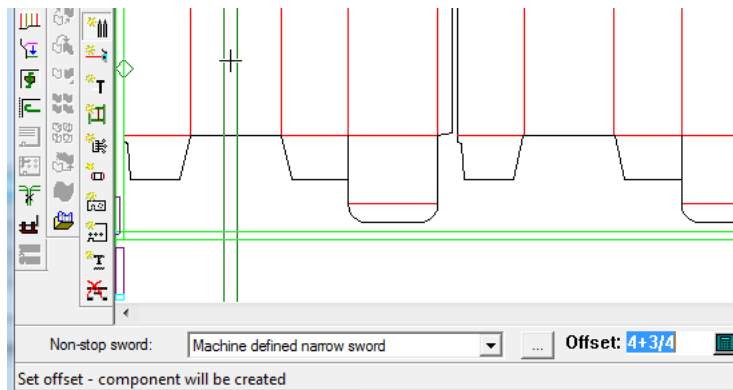

4. If Auto-Repeat is enabled, ArtiosCAD repeats the sword to congruent areas.
5. Continue adding swords as desired. The drag is green for valid positions and red for invalid positions.

Add Photocells tool

 The **Add Photocells** tool lets you add photocells to the blanking tooling. Photocells signal the press when the stack of blanks needs to be removed from the press to make room for new

blanks to accumulate. Photocells must not overlap joggers or other photocells. When you click this tool, ArtiosCAD turns on the Blanker frame layer and turns off the other blanking layers.

This tool has the following controls on the Status bar:



In the **Width** field, set the width of the photocell beam. This field is preset from the values in the Blanking parameter sets dialog box opened by the Properties (...) button. Use the drag to set the **Offset** or enter a value in the field manually. The drag is green for valid positions and red for invalid positions.

Shown below is the Blanking parameter sets dialog box.

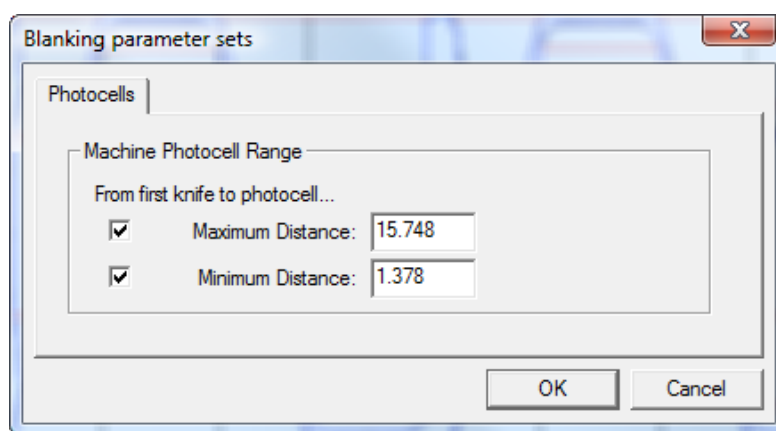

The **Maximum Distance** and **Minimum Distance** fields control the range of placement for the photocells. The checkboxes before them enable their limits; for example, to be able to set the photocell anywhere in the frame after the minimum distance, deselect **Maximum Distance**.

Click **OK** when you have set the values as desired.

To use this tool, do the following:

1. Create a layout in ArtiosCAD and generate the blanking tools.
2.  Click **Add Photocells** on the blanking toolbar.
3. If desired, change the width of the photocell in the **Width** field.
4. Use the drag to set the offset for the photocell's position, or enter it manually in the **Offset** field.

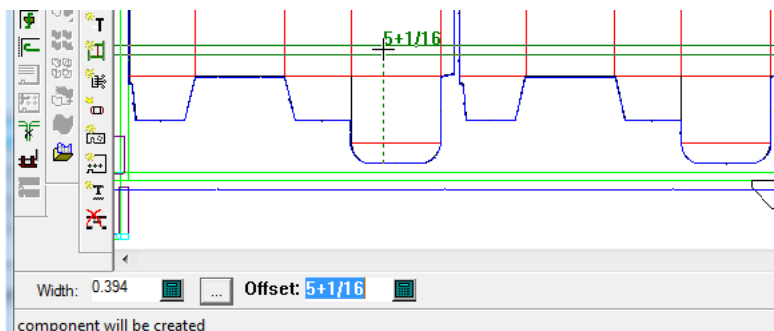

5. Continue adding photocells as desired. The drag is green for valid positions and red for invalid positions.

Add Jogger Guides tool



The **Add Jogger Guides** tool lets you position joggers, the hardware that helps guide the blanks as they are separated from the sheet. When you click this tool, ArtiosCAD turns on the Blanker frame layer and turns off the other blanking layers.

Joggers must not overlap other joggers, photocells, or non-stop swords. ArtiosCAD checks three parts of the jogger for interference: below the board (the active part), at the board level, and above the board.

This tool has the following controls on the Status bar:



Select the jogger to use from the **Jogger** drop-down list box. In the **Offset** drop-down list box, select **0**, **Midway between 2pts**, or enter a custom value. Check **Set alignment** so that when you click to add a jogger, you first place the jogger on a line and then click a point with which to align it.

To use this tool, do the following:

1. Create a layout in ArtiosCAD and generate the blanking tools.
2.  Click **Add Jogger Guides** on the Blanking toolbar.
3. Choose the jogger and offset from the drop-down list boxes on the Status bar.
4. Place the jogger in the desired position in the layout by clicking where you want it along a line in the frame or a design edge. ArtiosCAD will measure the offset of the jogger edge from the center of the blanking frame for joggers placed along the frame. You can achieve different positioning by holding down SHIFT or CTRL as you click; follow the prompts on the Status bar. The drag will be green for valid positions and red for invalid positions. If you want to align the jogger with a point, check **Set Alignment** on the Status bar before clicking its position. If Auto-Repeat is enabled, ArtiosCAD repeats the jogger to congruent areas.

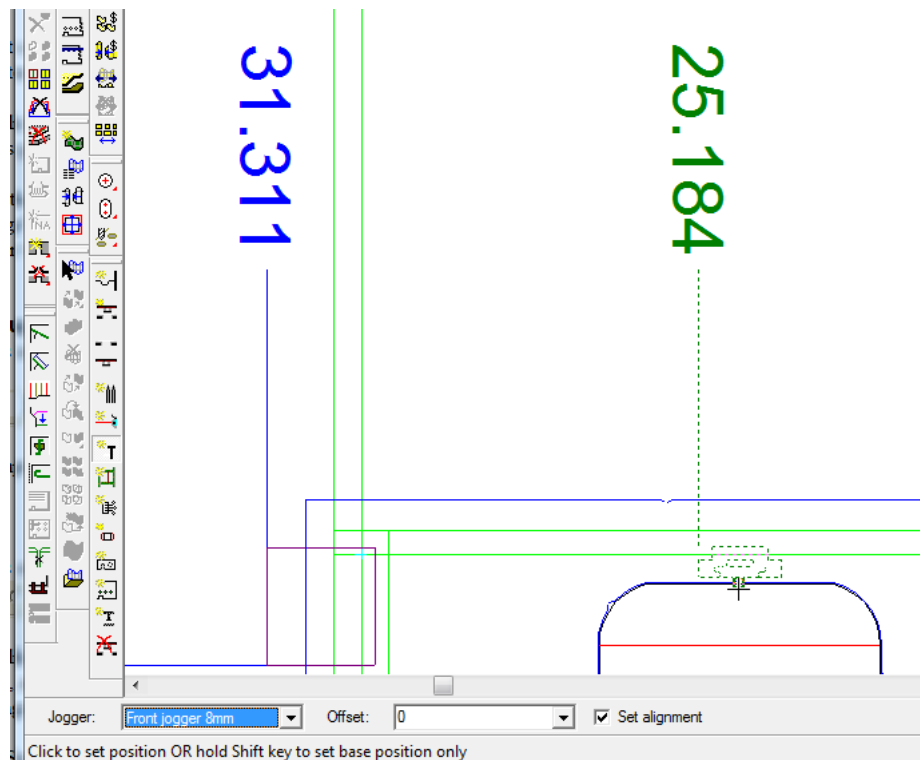

5. Continue adding joggers as desired.

Add Support Bars tool



The **Add Support Bars** tool lets you add support bars to the lower blanking board for reinforcement. When you click this tool, ArtiosCAD turns on the Blanking frame layer and turns off the other blanking layers.

This tool has the following control on the Status bar:

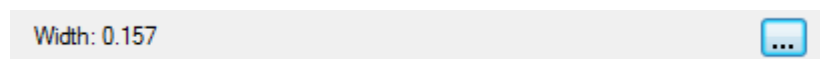

Set the absolute width of the support bar in the **Width** field. The initial value is part of the blanking parameter set. Click More Options (...) to open the Blanking parameter sets dialog box and change to defining the support bar by components within the parameter set.

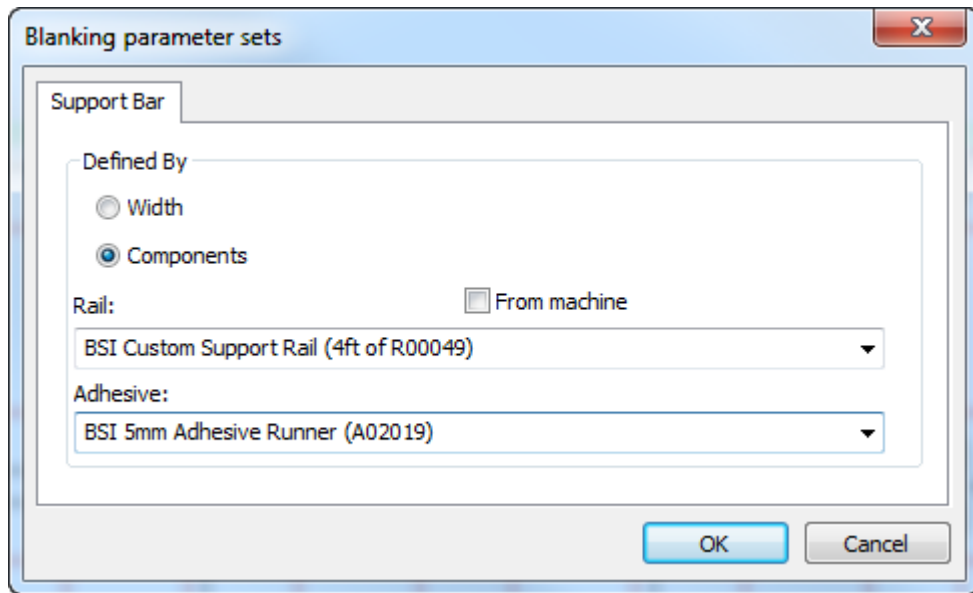

Click **From machine** to limit the choices in the **Rail** drop-down list box to those defined by the machine. Similarly, choose an adhesive strip for the top of the rail from the **Adhesive** drop-down list box. If you choose to define the support bar by components, the Status bar shows those components.

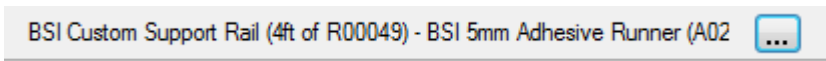

ArtiosCAD determines the support bar offset from the inner frame by the offset from the origin in the geometry macro workspace containing the component bar. All BSI components in ArtiosCAD use an offset of 4 millimeters. Similarly, ArtiosCAD determines the adhesive position by the position of the geometry in the geometry macro workspace. All BSI adhesive components in ArtiosCAD use an overlap of 2.5 millimeters. ArtiosCAD uses the same offset to trim the geometry at the top of the frame.

To use this tool, do the following:

1. Create a layout in ArtiosCAD and generate the blanking tools.
2.  Click **Add Support Bars** on the Blanking toolbar.
3. ArtiosCAD positions support bars midway between two points. Click the first point.

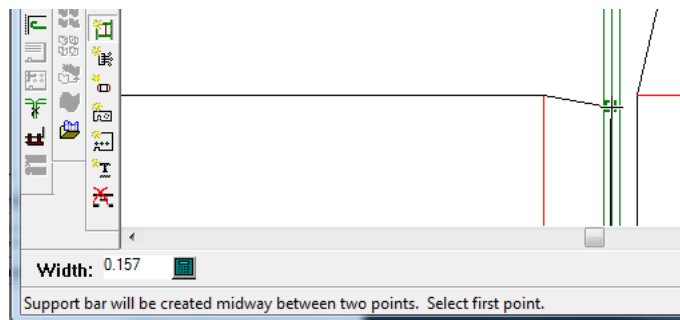

4. Click the second point or hold down CTRL and click a freehand point.

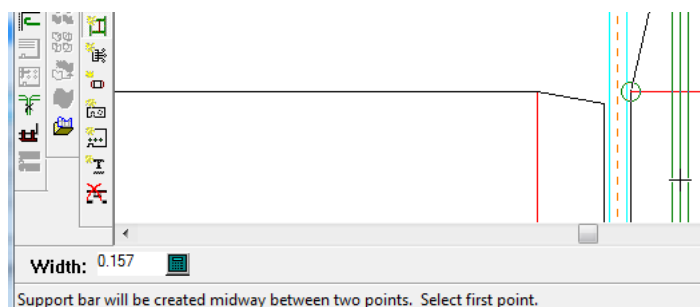

5. Continue adding support bars as desired.

Annotation marks in component support bars show the location of photocell holes.

If you choose to make your own component support bars out of geometry macros, there are these restrictions:

- You may not bend custom support bars.
- ArtiosCAD does not check that the bar is big enough for the frame.

ArtiosCAD does not have BSI part H03002 Spring Clip (a screwless support rail), but you can make a geometry macro for it and place it using **Add Hardware**.

Add Air Holes tool

 The **Add Air Holes** tool lets you add air holes in the pushers, the upper blanking board, or both. Air holes reduce the suction created by the movement of the tooling. When you click this tool, ArtiosCAD turns on the Blanker upper board layer and turns off any other blanking layers.

This tool has the following controls on the Status bar:

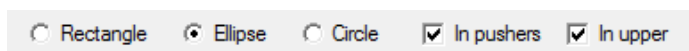

Choose the shape of the air holes from the option buttons and choose the objects in which to create the air holes from the checkboxes.

To use this tool, do the following:

1. Create a layout in ArtiosCAD and generate the blanking tools.
2.  Click **Add Air Holes** on the Blanking toolbar.
3. Choose the shape of air holes to add and the objects in which to create them.
4. Follow the prompts on the Status bar to create a hole. If Auto-Repeat is enabled, ArtiosCAD will use layout congruency to repeat it.

Note:

There is no validation to ensure that hole edges do not cross each other or pusher edges. Be careful with your construction.

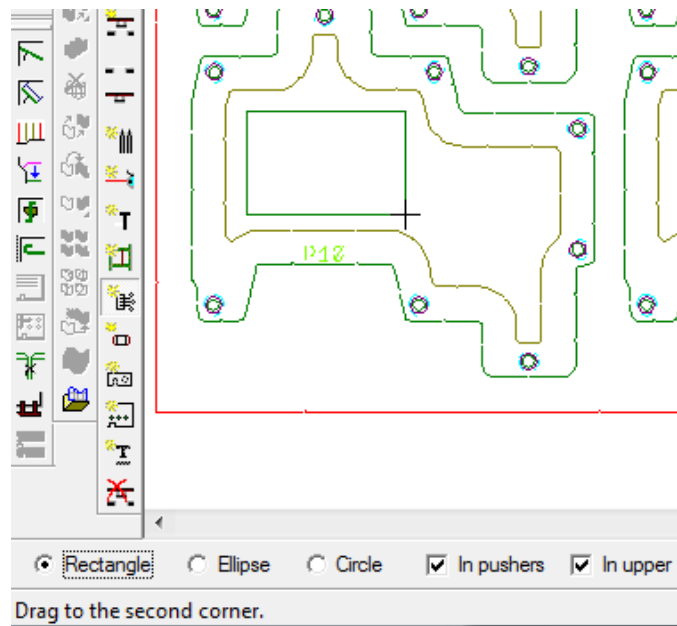

5. Create more holes as desired.

Add Blanker Pusher Pins tool

 The **Add Blanker Pusher Pins** tool adds the pins that attach the pushers to the upper blanking board. These are also called stand-off pins (SOP). When you click this tool, ArtiosCAD turns on the Blanker upper board and Blanker pusher layers and turns off the other blanking layers.

This tool has the following controls on the Status bar:

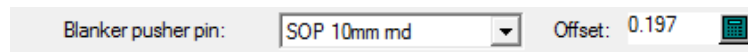

Choose the pin to add from the **Blanker pusher pin** drop-down list box. The **Offset** field sets the distance from the pusher edge to the pin. The initial value is part of the blanking parameter set.

To use this tool, do the following:

1. Create a layout in ArtiosCAD and generate the blanking tools.
2.  Click **Add Blanker Pusher Pins** on the Blanking toolbar.
3. Choose the type of pin to add from the list in the **Blanker pusher pin** drop-down list box.
4. If desired, change the offset for the pin in the **Offset** field.
5. Click the position inside the pusher edge where you want to place the pin. The cursor snaps the pin drag to the inside edge of a hole when it is inside a hole. ArtiosCAD adds pins with congruency but does not remove them with congruency.

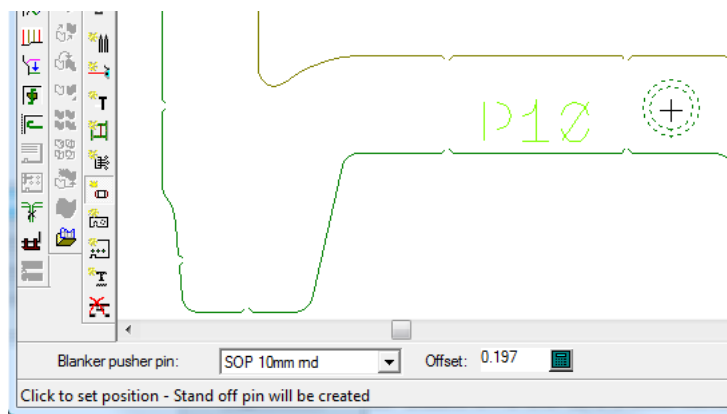

6. Continue adding pins as desired.

Add Hardware tool



The **Add Hardware** tool lets you add pieces of additional hardware to any of the blanking layers. You can design your own pieces of hardware, add them to the appropriate geometry macro catalog, and use this tool to add them to the blanking tooling.

This tool has the following controls on the Status bar:

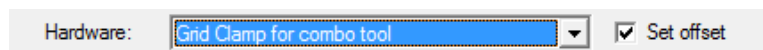

Choose the hardware to add from the **Hardware** drop-down list box. To be prompted for an offset after selecting the hardware's alignment point, check **Set offset**. Lines of blanker lower board types are copied to that layer, lines of blanker upper board types are copied to that layer, lines of blanker pusher types are copied to that layer, and the rest remain in the Blanker frame layer.

To use this tool, do the following:

1. Create a layout in ArtiosCAD and generate the blanking tools.
2.  Click **Add Hardware** on the Blanking toolbar.
3. Choose the hardware to add from the **Hardware** drop-down list box and click **Set offset** to be prompted to set an offset after aligning the hardware.
4. Place the hardware by clicking a line to place it against using drag and click to set its alignment point. If you are using BSI blanking kit hardware, please refer to the next section for notes about how to place specific pieces of hardware.
5. If you selected **Set offset** before placing the hardware, set the offset either with drag or by typing a value in the **Offset** field.

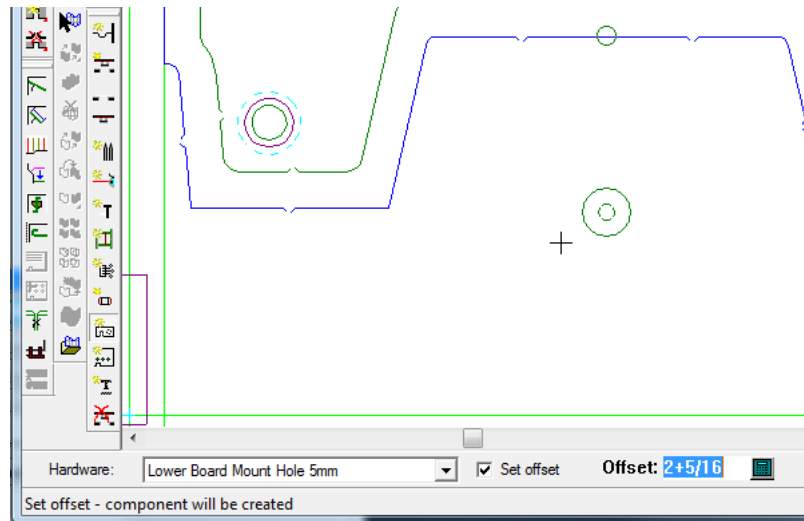

6. Continue adding hardware as desired.

Placing BSI hardware

If you are using a BSI blanking kit, some of the hardware has positioning notes.

Table: BSI Hardware Positioning Notes

BSI Hardware Part	Positioning Notes
A03010 Lower Board Support Assembly	Click an inside frame line, then click on a point to align with (or CTRL-click to place freehand).
A02023 Lower Board Support Body	Click an inside frame line, then click on a point to align with (or CTRL-click to place freehand).
C01015 Support Rail End	Select front or rear inside frame line, then select point on center of support bar.
Clamps	
C01013 Front/Rear Reusable	Select an inside front or rear frame line, then click a point on the side of the grid bar so that the green arrow points toward the bar.
C01019 Front/Rear Weldable	Select an inside front or rear frame line, then click a point on the side of the grid bar so that the green arrow points toward the bar.
C01028 Grid Mounting Bracket	Select the middle line of a grid bar, then click on a point to align with, (or CTRL-click to place freehand). This component should not intersect the frame rails.
C01012 Parallel Clamp	Click on the back of a side jogger or clamp, then click on the corner of the jogger so that the parallel clamp aligns with the jogger.

BSI Hardware Part	Positioning Notes
C01014 Side Clamp Reusable	Select an inside left or right frame line, then click a point on the side of the grid bar so that the green arrow points toward the bar.
C01020 Side Clamp Weldable	Select an inside left or right frame line, then click a point on the side of the grid bar so that the green arrow points toward the bar.

The parts appear on the Blanking Parts List in Outputs.

Blanking Parts Report

File: Flat top tool layout.MFG
Date: 09/15/2014

- 14 - BSI H01002 5x10 Special Socket Head Cap Screw
- 1 - BSI K02002 FRAME KIT - SP-104-ER
- 1 - BSI K02009 Lower Quick Lock Kit
- 2 - BSI R02078 Universal Mounting Rail 750mm
- 8 - BSI J03015 UNIVERSAL - SIDE
- 16 - BSI J03003 UNIVERSAL - FRONT/REAR
- 8 - BSI J03011 SOLID DROP JOGGER (8.0mm)
- 6 - BSI C01018 PARALLEL CLAMP
- 6 - BSI C01015 SUPPORT RAIL END
- 10 - Long presser 6mm
- Medium presser 6mm- 4
- M6- 2
- SOP 10mm rnd- 80

The report includes quantities for the component support bars, hardened pins, screws needed for the support bars that overlap the lower board, and adhesive runners.

Add Tie-bolts tool



The **Add Tie-bolts** tool lets you add holes for the bolts that attach the boards to the press. When you click this tool, ArtiosCAD makes the Blanker upper board layer active and turns off the other blanking layers.

This tool has the following controls on the Status bar:

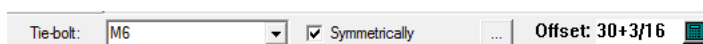

Choose the tie-bolt to use from the **Tie-bolt** drop-down list box. To add a corresponding bolt on the other side of the center line, leave **Symmetrically** checked. Set the offset of the tie-bolt either with drag or by entering a value in the **Offset** field. Clicking Properties (...) opens the Blanking parameter sets dialog box as shown below.

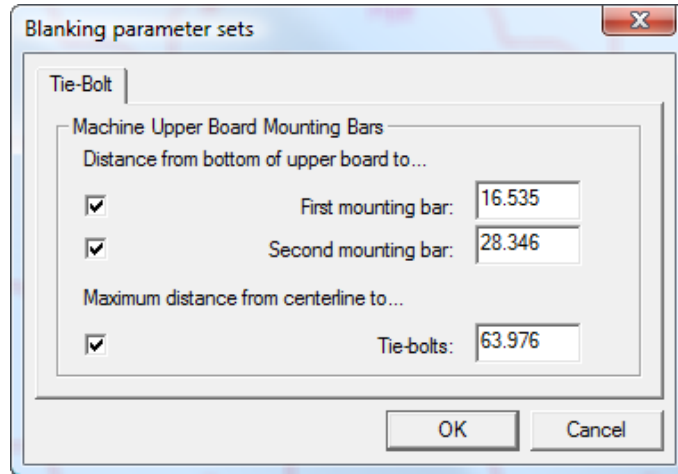

Set the distances as desired. The checkbox for a distance controls if you can add a mounting hole to that support bar, while the checkbox for the maximum distance enforces a limit on the offset distance from the centerline.

To use this tool, do the following:

1. Create a layout in ArtiosCAD and generate the blanking tools.
2.  Click **Add Tie-bolts** on the Blanking toolbar.
3. Choose the tie-bolt to use from the **Tie-bolt** drop-down list box.
4. Use the drag to set the **Offset** field. Depending on which mounting bars are enabled in the Blanking parameter sets dialog box, the drag snaps to show the bar for which you are adding a hole; you must use drag to choose the bar for the hole. The drag is green for valid positions and red for invalid positions. If **Symmetrical** is checked on the Status bar, then a corresponding tie-bolt hole is shown in the drag mirrored around the center line.

Shown below is drag for the first bar and then for the second bar. Once you have set the offset, click to add the hole.

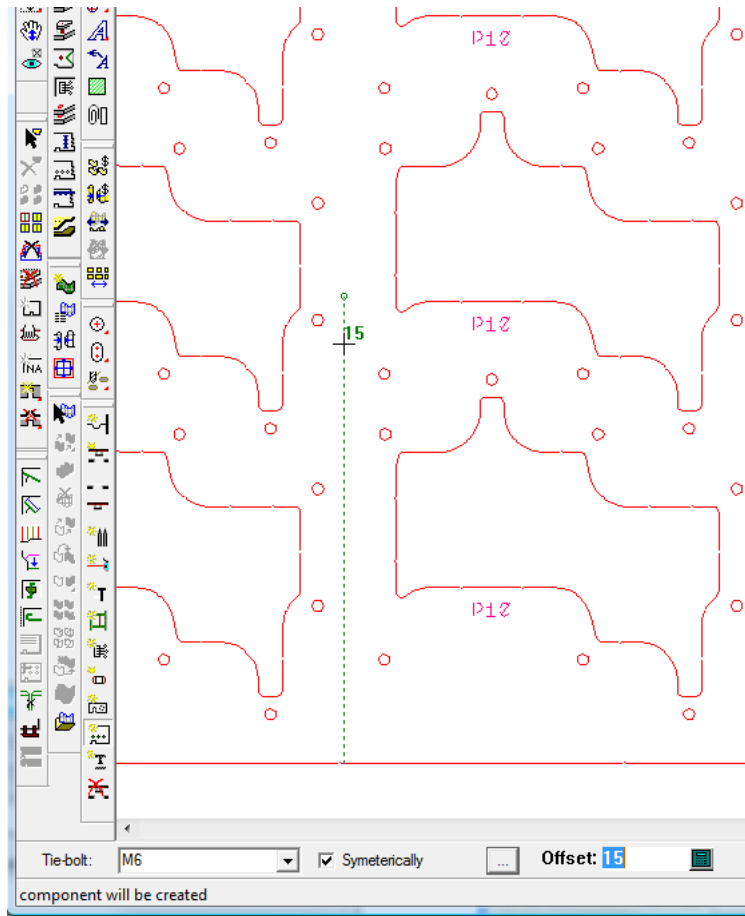

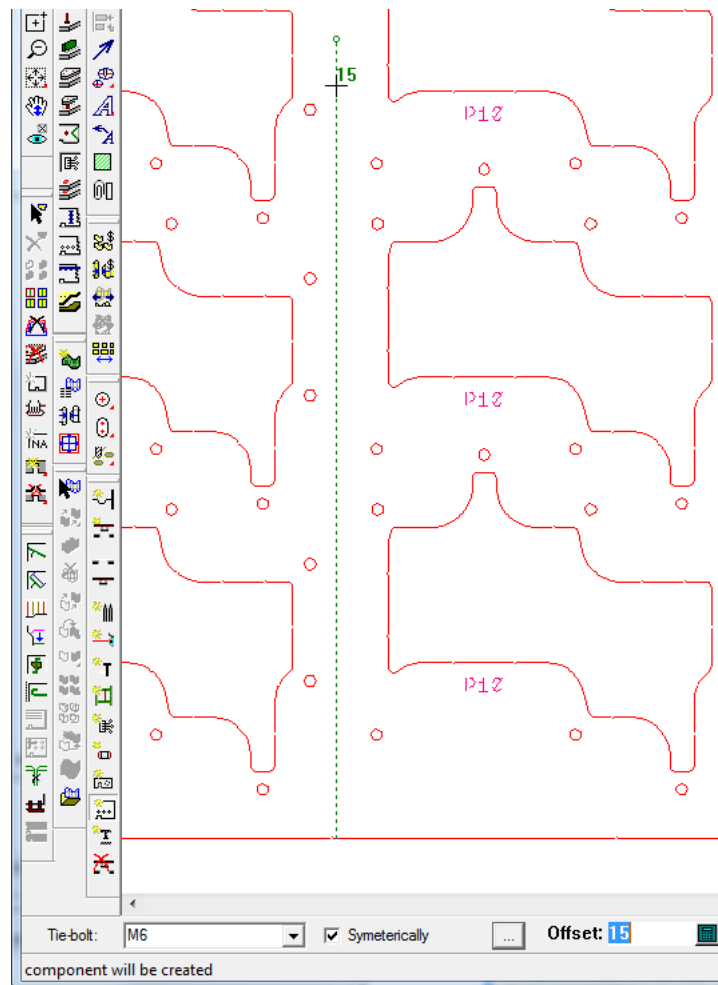

5. Continue adding tie-bolt holes as desired.

Add Pressers tool



The **Add Pressers** tool adds pressers to the upper board. Pressers are essential for holding the waste while the blanks are separated from the sheet. When you click this tool, ArtiosCAD turns on the Blanker upper board layer and turns off the other blanking layers.

This tool has the following controls on the Status bar:



Choose the presser to use from the **Presser** drop-down list box. **Set alignment** and **Set rotation**, when checked, allow you to set an alignment point after choosing the placement and to set a rotation angle on the presser before clicking the final position. The Properties (...) button opens the Blanking parameter sets dialog box as shown below.

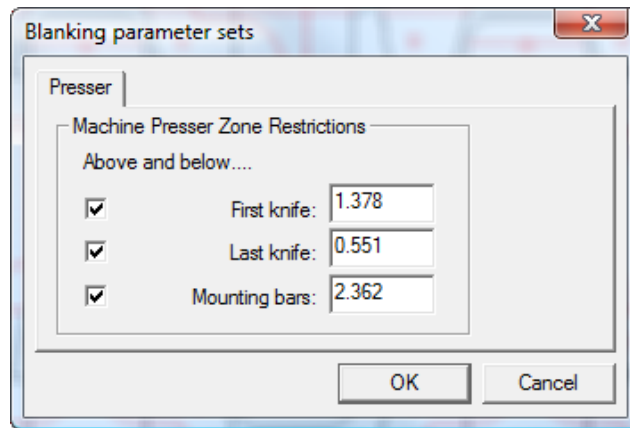

The checkboxes control enforcement of the restrictions for placement of the pressers relative to the first knife, last knife, and mounting bars. The values in the fields come from the blanking parameter set; change them if desired.

To use this tool, do the following:

1. Create a layout in ArtiosCAD and generate the blanking tools.
2.  Click **Add Pressers** on the Blanking toolbar.
3. Choose the type of presser to add from the **Pressers** drop-down list box.
4. Check **Set alignment** and **Set rotation** as desired.
5. Place the presser by clicking the design line from which to offset the presser, or click two points to position it between. Use drag to position it, or enter a value in the **Offset** field on the Status bar. The drag will be green for valid positions and red for invalid positions. Hold down CTRL to place the presser freehand.

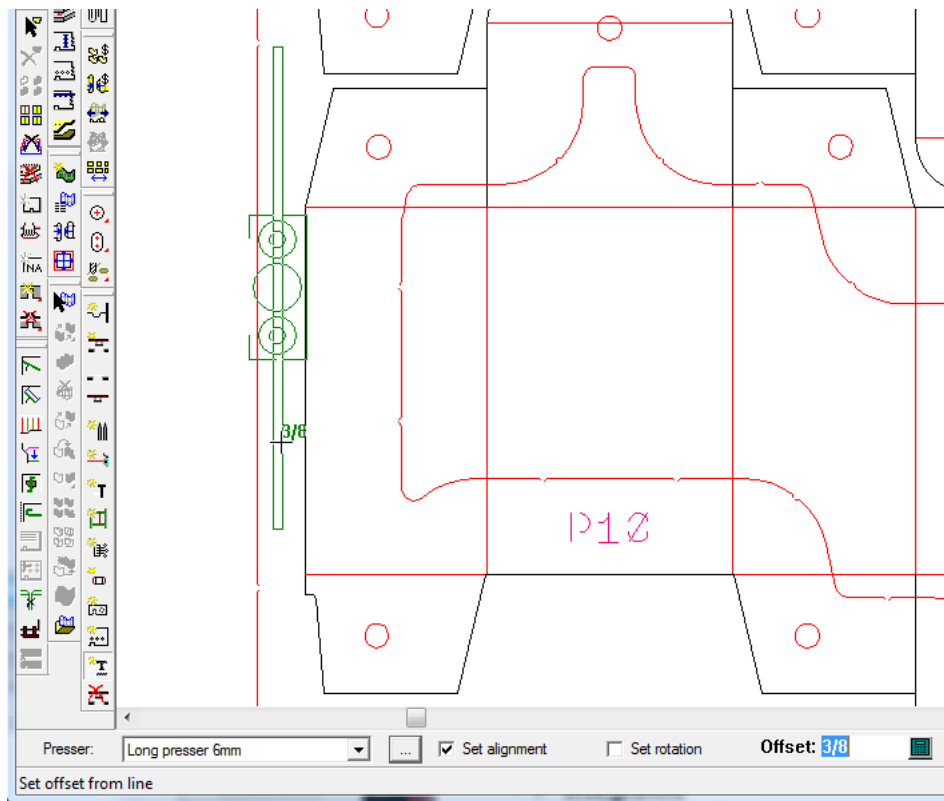

If you checked **Set alignment** or **Set rotation**, ArtiosCAD prompts you to set the alignment and rotation before creating the presser. If Auto-Repeat is enabled, ArtiosCAD repeats the presser using layout congruency.

6. Continue adding pressers as desired.

Delete Blanking tool

 The **Delete Blanking** tool lets you quickly delete entire categories of blanking elements. When you click this tool, ArtiosCAD turns on all the blanking layers.

To use this tool, do the following:

1. Create a layout in ArtiosCAD and generate the blanking tools.
2.  Click **Delete Blanking** on the Blanking toolbar. The Delete Blanking dialog box opens as shown below.

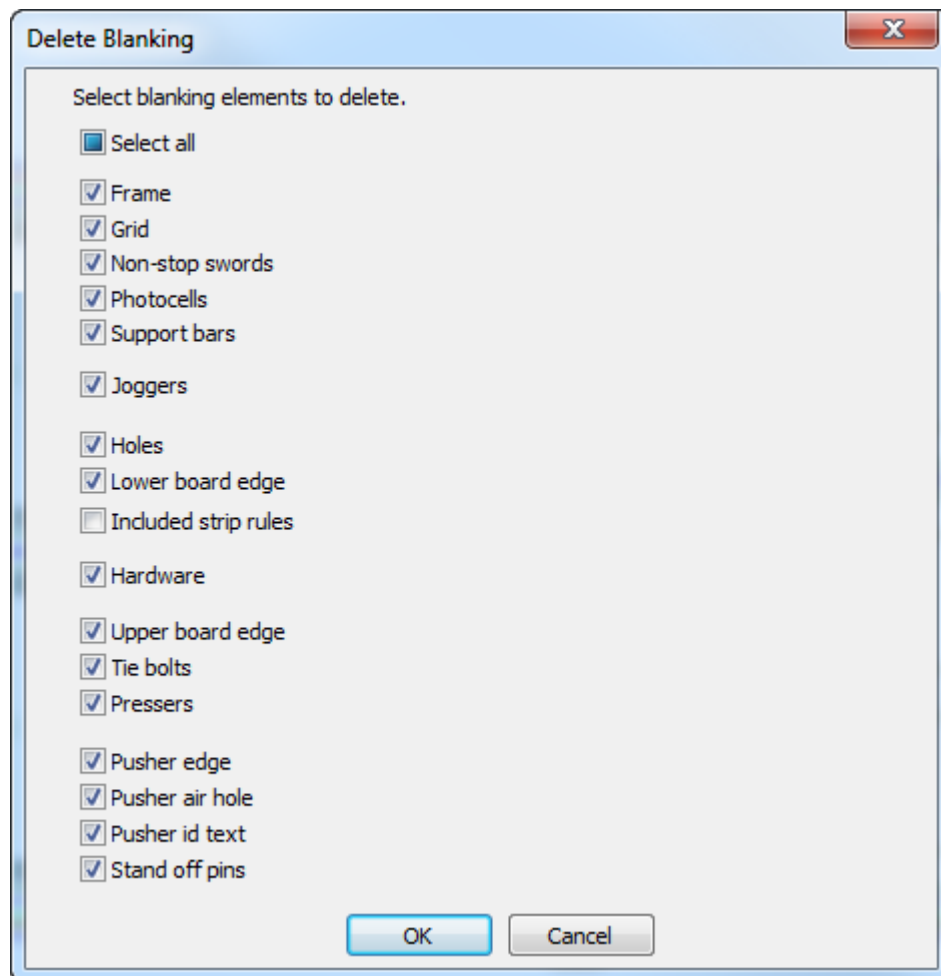

3. Select the checkboxes in front of the blanking elements to delete. All checkboxes are turned on by default. To toggle their states simultaneously, change the state of **Select all**. It defaults to an intermediate state because everything but included strip rules are selected by default.
4. Once you have clicked the checkboxes for the elements to delete, click **OK**.
5. ArtiosCAD deletes the selected blanking elements.

Note:

If you have locked any of the blanking layers, you cannot delete elements that have components in those layers as their checkboxes will be unavailable. Unlock those layers to enable deleting elements in them.

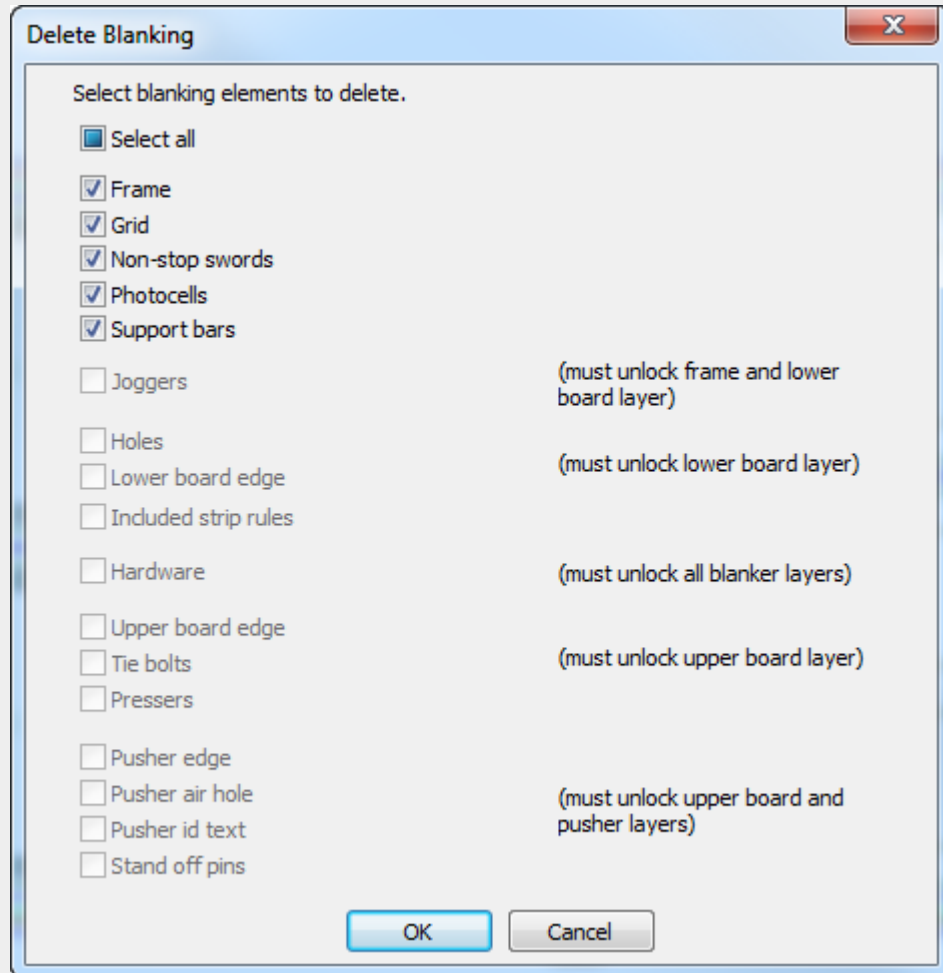

 To delete individual blanking elements, use the **Select Element** tool and the DEL key on the keyboard.

Smooth/Blend Contour tool

The **Smooth/Blend Contour** tool is on the context menu when you are adjusting the contour of a lower hole, pusher edge, or pusher air hole. It lets you blend contour corners or smooth the entire contour.

This tool has the following controls on the status bar:

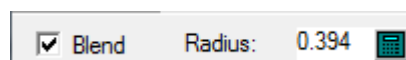

Blend blends the corner between two segments by the value specified in the **Radius** field.

To use this tool, do the following:

1. Create a layout in ArtiosCAD and generate the blanking tools.
2. Use a tool to add or adjust a lower hole, pusher, or pusher air hole.
3. While one of those tools is active, right-click the contour and click **Smooth/Blend Contour** on the context menu.

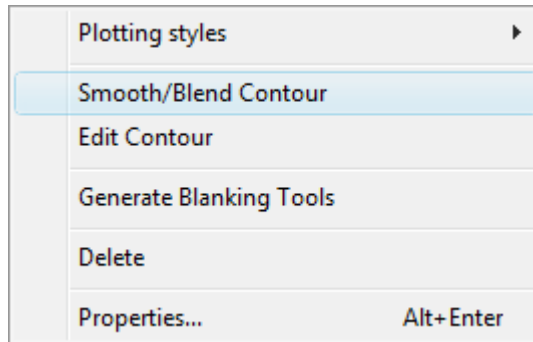

4. On the Status bar, check **Blend** to blend two segments together by the amount in the **Radius** field.
5. Either click the first and second lines to blend, or hold down CTRL to blend the whole contour at once. If Auto-Repeat is enabled, ArtiosCAD uses contour congruency to repeat the changes to matching elements. Shown below is a rectangular air hole that had all its corners blended at once by using this tool while holding down CTRL.

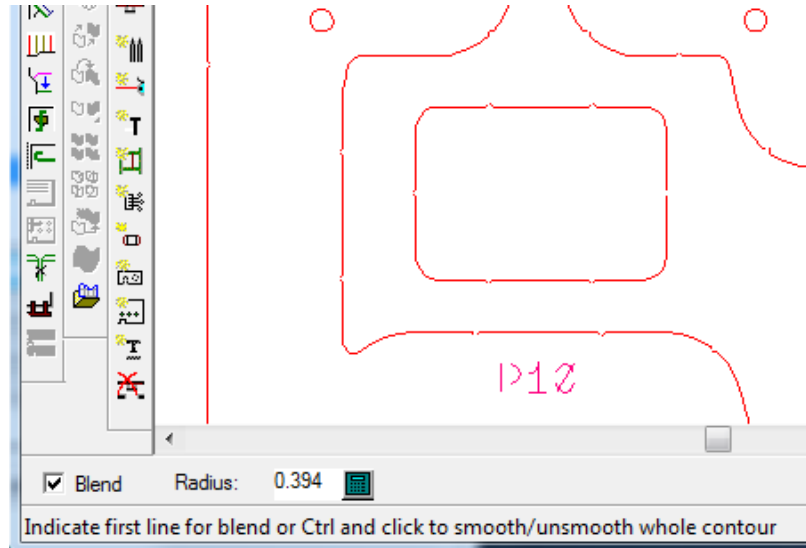

Note:

This tool smooths only the inside corners of lower holes.

Edit Contour tool

The **Edit Contour** tool is on the context menu when you are adjusting the contour of a lower hole, pusher edge, or pusher air hole. It lets you change the shape of the contour.

To use this tool, do the following:

1. Create a layout in ArtiosCAD and generate the blanking tools.
2. Use a tool to add or adjust a lower hole, pusher, or pusher air hole.
3. While one of those tools is active, right-click the contour and click **Edit Contour** on the context menu.

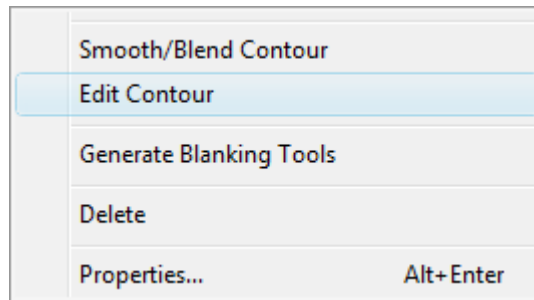

4. Click the point to move or the line to split. Use the Stretch Point technique if you click a point or the Split Line technique if you click a line. If Auto-Repeat is enabled, ArtiosCAD uses contour congruency to repeat the changes to other elements. Shown below is a point being dragged.

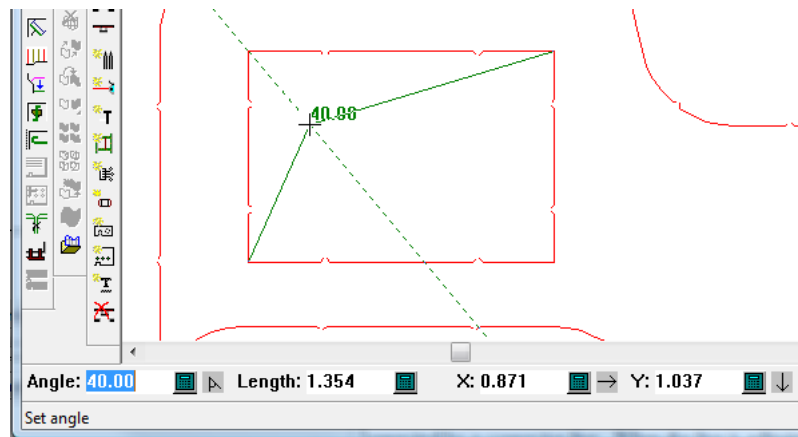

5. Continue editing the contour as desired.

14. 3D

Introduction to 3D

3D has three modules that provide different abilities for viewing how the design will look in the real world. **3D** allows you to fold flat single designs in three dimensions. With the **3D Animation** module, you can create a movie of how the design folds. With **3D Designer**, you can import a model of the object being packaged, make intersecting pieces of board through any cross section, and then run a standard style of box to contain the assembly. The examples and procedures in this chapter may reference options and features that are not part of your system.

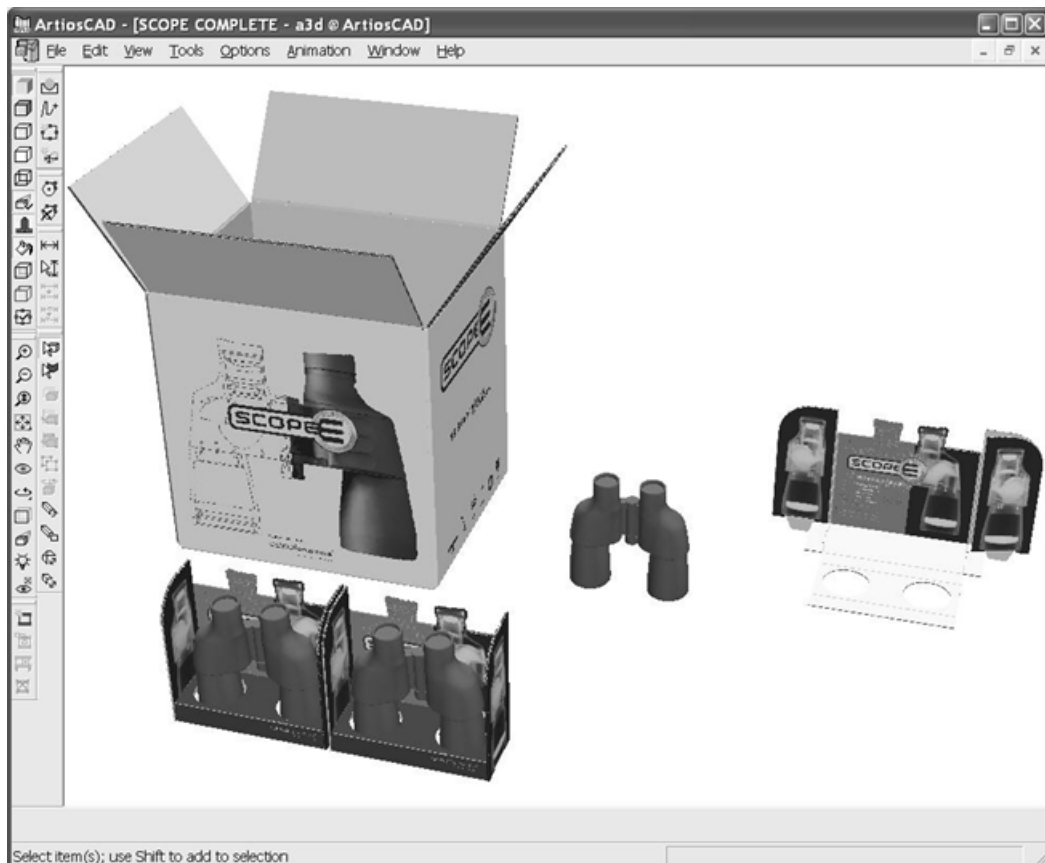

Concepts and Ideas in 3D

3D is simple to use, but very powerful. Before you use it, you should understand the basics.

In 3D:

- You work in three dimensions using the X, Y, and Z axes. Those axes can optionally be displayed in the lower left corner of the design window.
- You import flat designs and then fold panels along straight creases (or similar lines such as perfs) so that the edges of the panels meet to form an image of the box as it looks in real life.
- You pick which panel of the box will remain fixed. All the other panels will fold around this one, called the base face.
- Lines in a design that are invisible in real life can be made invisible in 3D.
- You can see board thickness and corrugation if your system has the Graphics option.
- Multiple designs can be in one workspace, and multiple workspaces can be open at once. For example, in one workspace, boxes can be placed in trays that rest upon display bases.
- The viewing angle of the workspace can be changed at any time so that you can see your workspace from any side.
- Individual designs can be grouped together for easier manipulation.
- You can change the position of the light source to change the intensity of any graphics.
- You can animate a fold sequence and export it as a VRML file, viewable in any Web browser with a VRML plug-in. (This ability must be purchased.)
- You can make a solid of revolution by defining its vertical cross section and horizontal cross sections in the single design workspace, adding labels and shrink-wrap graphics if desired, to create a 3D model.
- You can import 3D models from other applications depending on the ArtiosCAD options purchased.
- You can copy a workspace to the Windows Clipboard with graphics and lines for use in Single Design or other applications, or export it as a PNG or JPG file for greater resolution and transparency support (PNG only).

Workflow in 3D

The core of using 3D for a folding container is shown below.

1. Make a single design in ArtiosCAD.
2. Start 3D by clicking the Convert to 3D button  on the View bar.
3. Select a base face for the flat design to fold around.
4. Fold the panels as desired, capturing animation frames as desired.
5. Add more designs to the workspace as needed.
6. Adjust the viewing angle, elevation, light sources, and perspective as desired.
7. Add a background image as desired and align the designs with the background image.
8. Turn on shadows as desired and adjust the light sources as needed.
9. Save the workspace.
10. Print or export the workspace.

Snap

The availability of pick-up and put-down points for objects in 3D are controlled by the Snap Options dialog box on the Options menu. In addition to the same options as in Single Design, **Snap to solids** enables snapping to any point in a solid (of which there are many because

of the number of polygons used to make the solid); this checkbox is off by default. **Snap to cartons** enables snapping to midpoints and endpoints in corrugated or folding carton containers; this option is on by default.

Tools in 3D

There are two types of tools in 3D. The first requires one or more designs to be selected before that tool can be used. The second does not require a design to be selected. Any tool that manipulates the physical position of a design requires the design to be selected first.

Table: Tools and Selection Status

Tools requiring design to be selected	Tools not requiring design to be selected
Move Point to Point	Zoom Rectangle
Move Designs	Zoom Out
Move Designs in X, Y, Z	Center-Point Zoom
Duplicate Designs	Pan/Zoom
Duplicate Designs in X, Y, Z	Next View
Rotate Designs	Previous View
Group	Scale to Fit
Ungroup	View Mode tools
	Select Designs
	Fold Angle
	Fold All
	Fold 1 to Meet
	Fold 2 to Meet
	View Angle
	Perspective
	Light Source
	Dimension
	Select Dimensions
	All of the Animation tools
	Extend
	Clear Extend
	Convert to 2D

For example, if you want to move a design, it must be selected before the Move Design tool can be activated. The same applies to the **Move Point to Point**, **Duplicate Designs**, and **Rotate Design** tools.

Notes and warnings in 3D

3D workspaces created in this version of ArtiosCAD may not be opened in pre-6.5x versions of ArtiosCAD. In 6.5x there will be no board textures, no background image, and animations will not Scale to Fit.

The **3D View** toolbar must be turned on for flyout toolbars to work.

The amount of graphics in a workspace, the number of designs in a workspace, the smoothness selected for solids of revolution, and the number of workspaces open all affect the performance of your system and 3D. To keep your system running at the fastest possible speed, turn Graphics off in the View Mode dialog box (if that option is available) and keep the number of open workspaces to a minimum.

Multi-piece single designs without creases (such as words made of cut lines) are limited to having a maximum of 300 pieces when converted to 3D.

There is a limit of 29,900 graphic elements on a face in 3D. Each panel of a container is a face. Each fill or stroke is a separate graphic element; grouping them does not merge them for the purposes of circumventing this limit. Text that is converted to an outline has one or two fills per letter.

Performance will be slow with more than 100 holes per face.

Likewise, ArtiosCAD will not render more than 100 perf segments per panel. It will still tear or fold as required, however.

Curves in board face edges are converted to straight lines in order to draw their edges.

Faces may be divided by gaps up of up to 1.5 mm. Designs that have intentional gaps larger than this are not supported and may have unexpected faces.

When a design with no creases is opened in 3D, the Select Base Face dialog box is skipped as there is only one face.

If nothing happens when you turn on board thickness, there might not be a board defined in the workspace. The best way to turn on board thickness for 3D workspaces created in earlier versions of ArtiosCAD is to choose a new board for that workspace in the Properties dialog box.

When a crease is folded, it folds in the middle of the board as ArtiosCAD assumes the inside loss is half a caliper. It is often more accurate to fold in this manner because the inside loss in the board table is often rounded.

The VRML Export Options dialog box in Defaults (**Options > Defaults > Outputs-3D > Artios > VRML**) has a checkbox to control whether or not corrugations are exported to VRML from 3D.

Do not make a handle with a gap between the edge of the handle and the main body of the design on single designs you intend to convert to solids of revolution. Solid handles attached to the designs with no gap are constructible as long as the cross sections are defined correctly, or you could make a handle as a separate design with a large board thickness and add it to the 3D workspace.

When working with the High or Maximum settings in high graphics mode, only have one 3D workspace open at a time. There is no error message when the video adapter runs out of memory, so if parts of the graphics are missing, try High or Medium.

When folding a design, all edges of coplanar flaps may not be shown. Change the View Mode to **Solid with edges** to see the flap edges. Alternately, change the fold angle(s) by a degree or two.

A PS/2 laptop mouse may not have correct middle mouse button functionality. If you have such a mouse and the middle mouse button functionality does not work properly, try an external USB mouse.

Solid with Edges View mode in 3D now responds faster than it did in previous versions. It does this by drawing all the fills without graphics as a single bitmap and grouping all the lines together. In previous versions, the panels were independent of each other and the fills without graphics were drawn as separate pieces.

If you frequently use **Copy** and **Paste** between 3D and Single Design, you may notice this changed way of working more than users who do not frequently copy and paste between the two modules.

OpenGL provides sharper results when copying and pasting between modules because of its larger limit on bitmap size than Direct3D. Try using OpenGL if Direct3D does not meet your needs.

If you need your creases to be black when printing, create a plotting style with black crease lines and use it as needed.

A 3D workspace may have up to 30,000 individual designs in it.

Most special rules can fold and tear. Curved rules can tear or fold per the table below, but cannot both tear and fold.

Special rule type	Fold	Tear
Crease, partial cut, reverse partial cut	Yes	Yes
Perf, cut/crease, partial cut/crease, all perf types	Yes	Yes
Multi-perf	Yes	Yes
Zipper rule	Yes	Yes
Wave or zig zag with non-zero nick size	Yes	Yes
Wave or zig zag with zero nick size	No	No
Scallop rule (has no nicks)	No	No

Special rule type	Fold	Tear
Staggered perf, S-rule, echelon perf	Yes	Yes

3D Rendering Options

3D can use two different rendering (display) methods, **OpenGL** (the default) and **Direct3D**. Which method will perform better for you depends on the display adapter in your system. The main difference between the two methods is how data is transferred between main system memory and the display adapter. Other differences include:

- Shininess appears to work better when using Direct3D.
- ArtiosCAD using Direct3D takes longer to open a 3D workspace initially but once open draws it faster than when using OpenGL.
- Using OpenGL allows the export of bitmaps with more pixels than with Direct3D.
- In wire frame view mode, OpenGL seems to be able to display more lines.
- When ArtiosCAD and the Cortona VRML viewer both use Direct3D and are open at the same time, they compete for resources and unpredictable results may occur. Change the rendering method in one of them for better results. Closing ArtiosCAD may also help Cortona to work more predictably.

To switch between rendering languages, click **Options > 3D Rendering Options**, choose the desired language, and click **OK**.

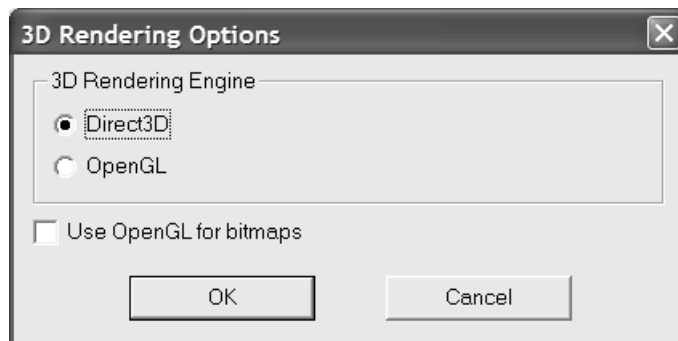

Use OpenGL for bitmaps enables ArtiosCAD to output bitmaps using OpenGL regardless of the screen rendering method chosen. OpenGL supports the output of larger bitmaps than Direct3D.

Defaults are updated automatically with the selections made in this dialog box.

Understanding the Basics of 3D

Creating a new 3D workspace

To create a new 3D workspace from an existing flat design, do the following:

1. Open the design in ArtiosCAD.
2.  Click **Convert to 3D** on the View bar. If there is a 3D workspace open already, the Convert to 3D dialog box appears as shown below. If there is no 3D workspace open, skip to the next step.

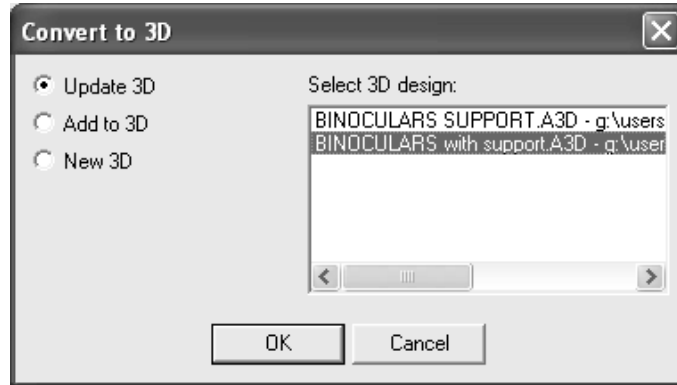

Update 3D is enabled if you are modifying a design contained in one of the open 3D workspaces. Choose the 3D workspace to update and click **OK**.

Add to 3D adds the design being converted to the selected 3D workspace. Click **OK**.

New 3D creates a new 3D workspace. Click **OK**.

Click **Cancel** to cancel the conversion to 3D.

3. The Add Unfolded Design(s) dialog box appears. ArtiosCAD checks the design for gaps in the perimeter as well as for creases that do not meet other cuts or creases to form panels. ArtiosCAD fills the design in gray and colors the base face (if already defined) in a light purple. If the entire design doesn't fill, that means there's a gap or improper line (such as a cut that should be a crease) somewhere that you need to fix. Any error messages or instructions are shown in the box beneath the picture of the design.

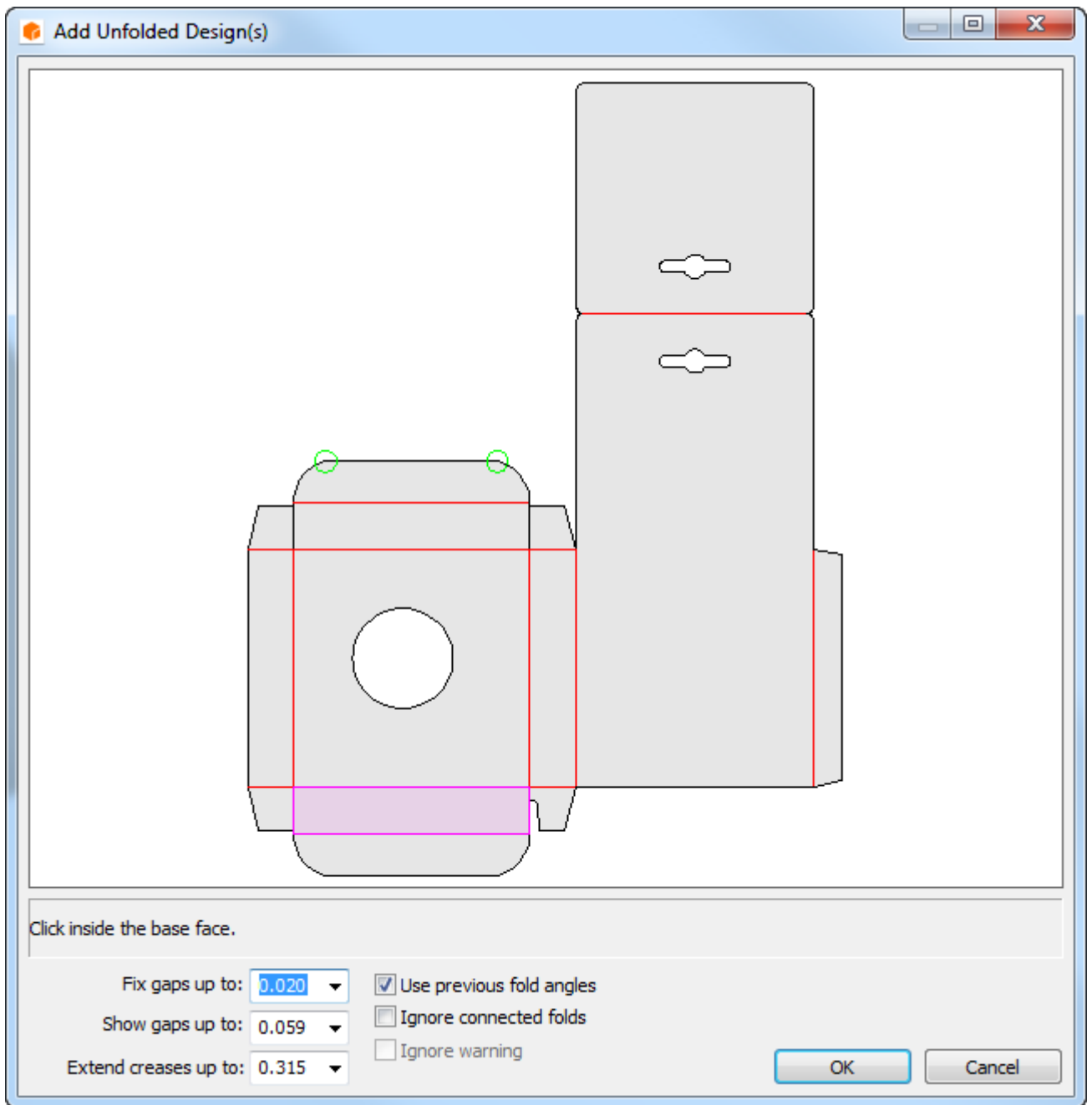

Any perimeter gaps smaller than the value in the **Fix gaps up to:** field are automatically fixed and are indicated by green circles. Gaps between the size to be shown and the size to be fixed are indicated by red circles. If the perimeter has gaps in it, ArtiosCAD does not fill the design

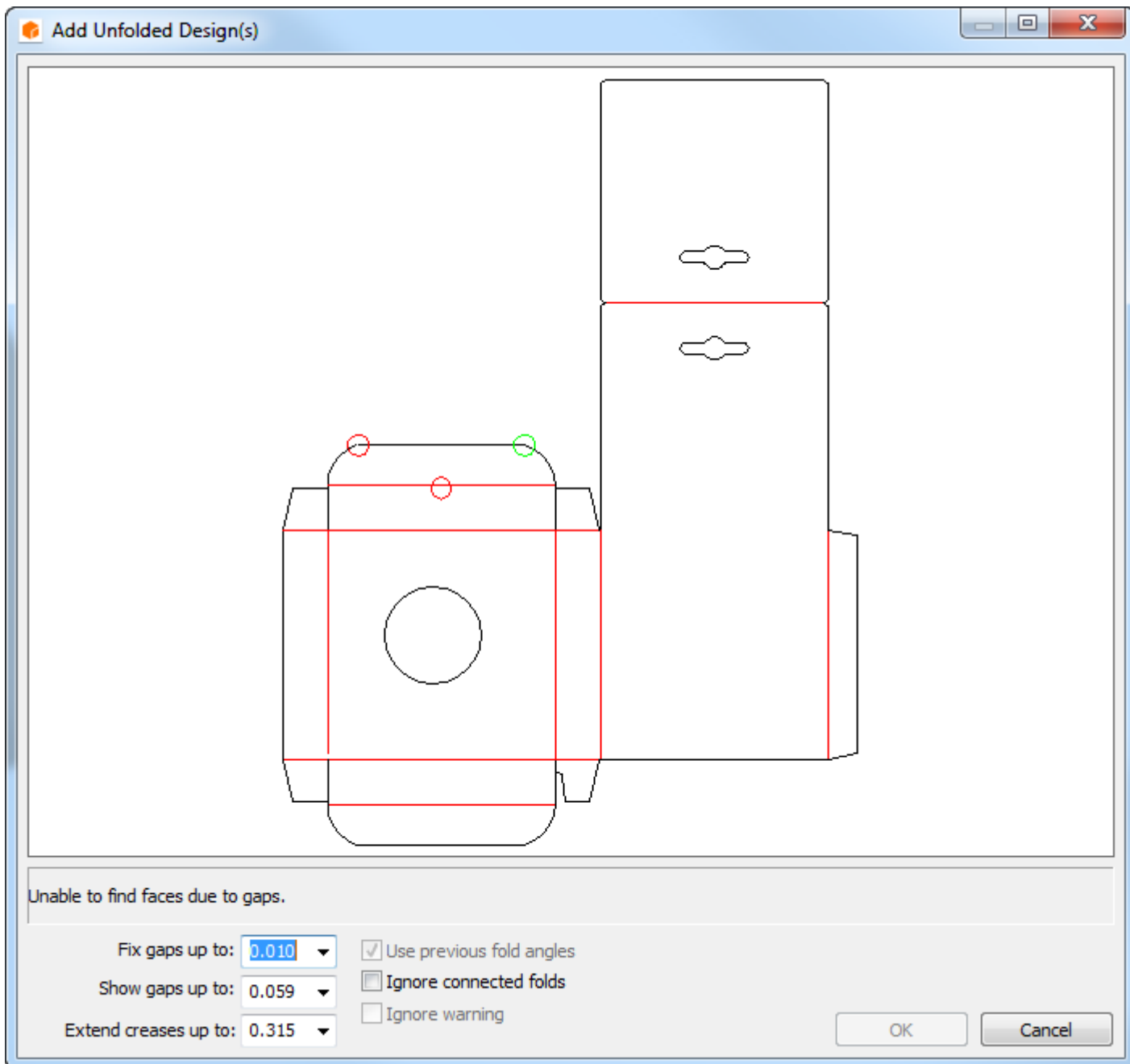

ArtiosCAD extends cut-back creases up to the amount selected in the **Extend creases up to:** drop-down list box so that they meet other cuts and creases. Creases will be extended at least 3mm. If the crease reductions were intentional, decrease the value in this field to prevent ArtiosCAD from extending the creases. Creases which do not completely form panels are shown as perfs.

Ignore warning is available when creases cross more than one panel or when cut lines do not form an outline. Checking this checkbox enables the **OK** button. Ignoring warnings may lead to unintended consequences as shown below.

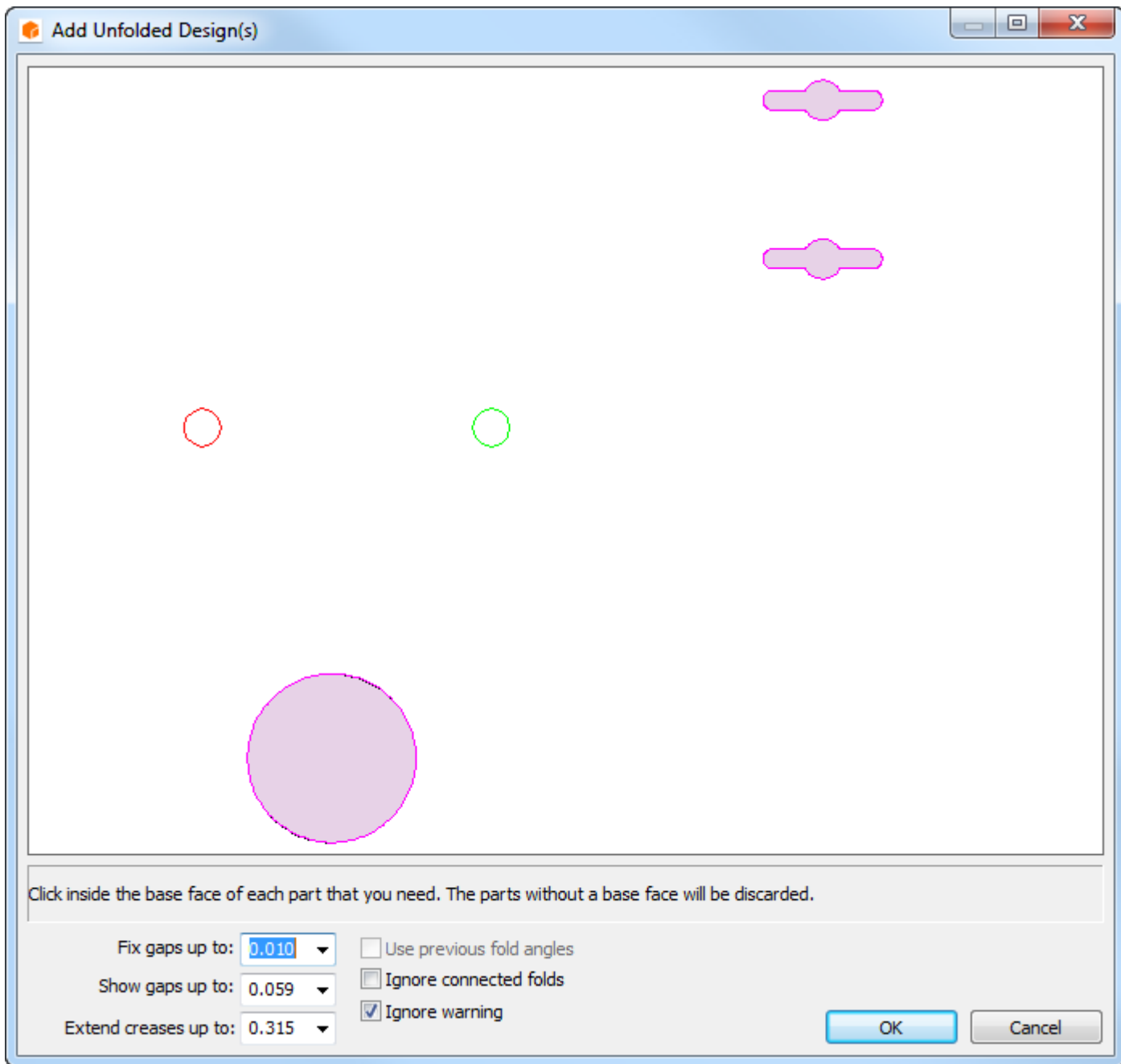

4. Once any issues are resolved, click inside the base face when prompted. This is the panel that all other panels will fold around. If the single design contained fold angles, **Use previous fold angles** is available; check it if desired.
5. Click **OK**.
6. The design will be opened in 3D and you can start to fold it. If any graphics layers for the print item were turned on in Single Design before converting the design, they are all brought into 3D.

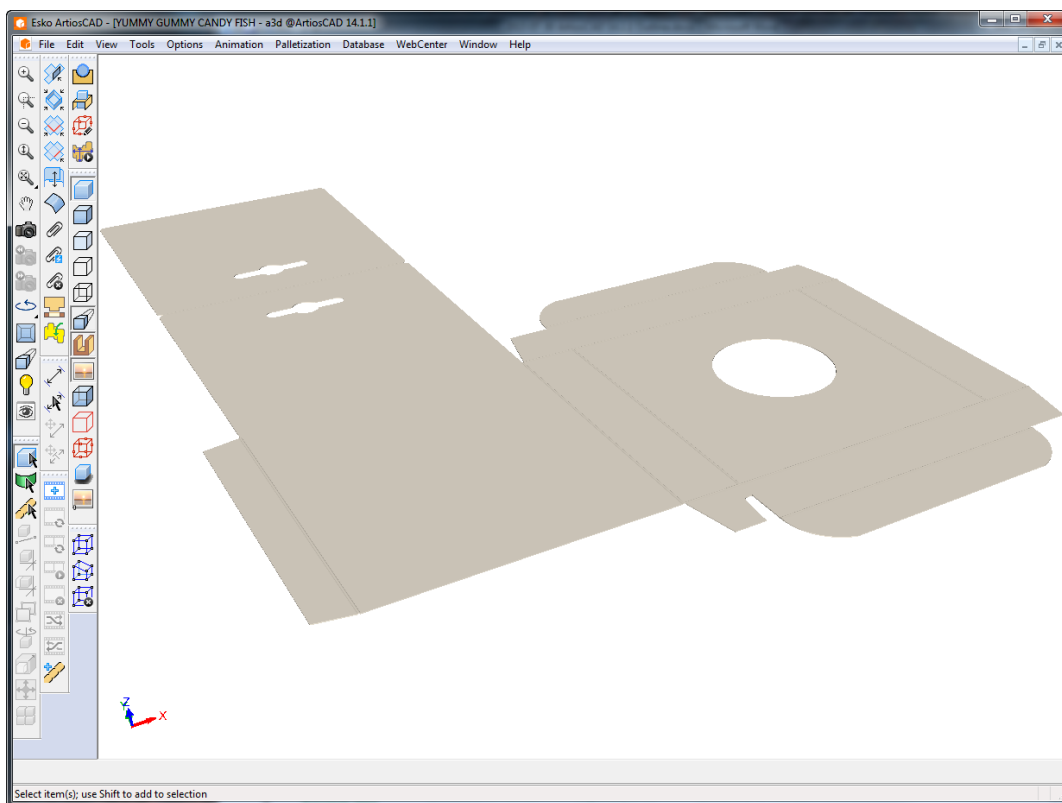

Note: If it will take longer than a minute to render the edges when creating a new 3D workspace, edges will be turned off if they are on in the current view. You may turn them back on manually by changing the View Mode.

Defaults for the gap tolerances and the crease extension allowance are set in **Options > Defaults > Shared Defaults > Startup defaults > 3D Tools Defaults**.

To create a completely new 3D workspace, click **File > New > 3D**. You can then use **File > Add a Design** to add designs or solids to the new workspace.

When converting a flat design to 3D, line types are processed as shown in the table below.

Table: Line types when converting to 3D

Line type	Resulting action
Cut	Form the outside edge of the design or holes in the interior.
Crease, Second height crease, Reverse crease	Straight creases between panels can be folded. Curved creases will cause an error message. Creases that do not connect cut lines are treated as perfs.
Perf, Reverse crease, Partial cut, Reverse partial cut	Straight lines between panels can be folded. Lines that do not connect cuts are shown as thin slots. The number of

Line type	Resulting action
	such slots able to be processed is limited; do not use with text outlines.
Print image, Annotation	Ignored. Use graphics such as strokes or fills instead.

If you are reconverting a canvas to 3D and it already contains hardware parts, ArtiosCAD positions the hardware based on the hardware placement lines in the 2D design. Note that the placement lines are not mates and do not force the hardware to stick to the design.

Opening an existing 3D workspace

To open an existing 3D workspace, do the following:

1. Click **File > Open**.
2. Navigate to the desired resource or directory, select the file from those listed, and click OK. If your 3D design does not have the .A3D extension, enter the full name of the workspace in the filename box, or change the listed file type to All Files and then select the file.
3. The workspace will be opened.

Note: If it will take longer than a minute to render the edges when opening a design, edges will be turned off if they are on in the current view. You may turn them back on manually by changing the View Mode.

Remembered fold angles and base face

3D saves fold angle and base face information. If you convert a design to 3D, fold it, save it, and then make changes to the original flat design, when you convert the changed flat design to 3D, 3D gives you the option of reusing the folded angles and the base face from the previous version of the folded design. If you want to choose a new base face, click inside it, and clear the Use previous fold angles checkbox to select new fold angles. This feature only works on designs that have been saved as it uses the design name to link the 3D workspace to the flat ArtiosCAD design.

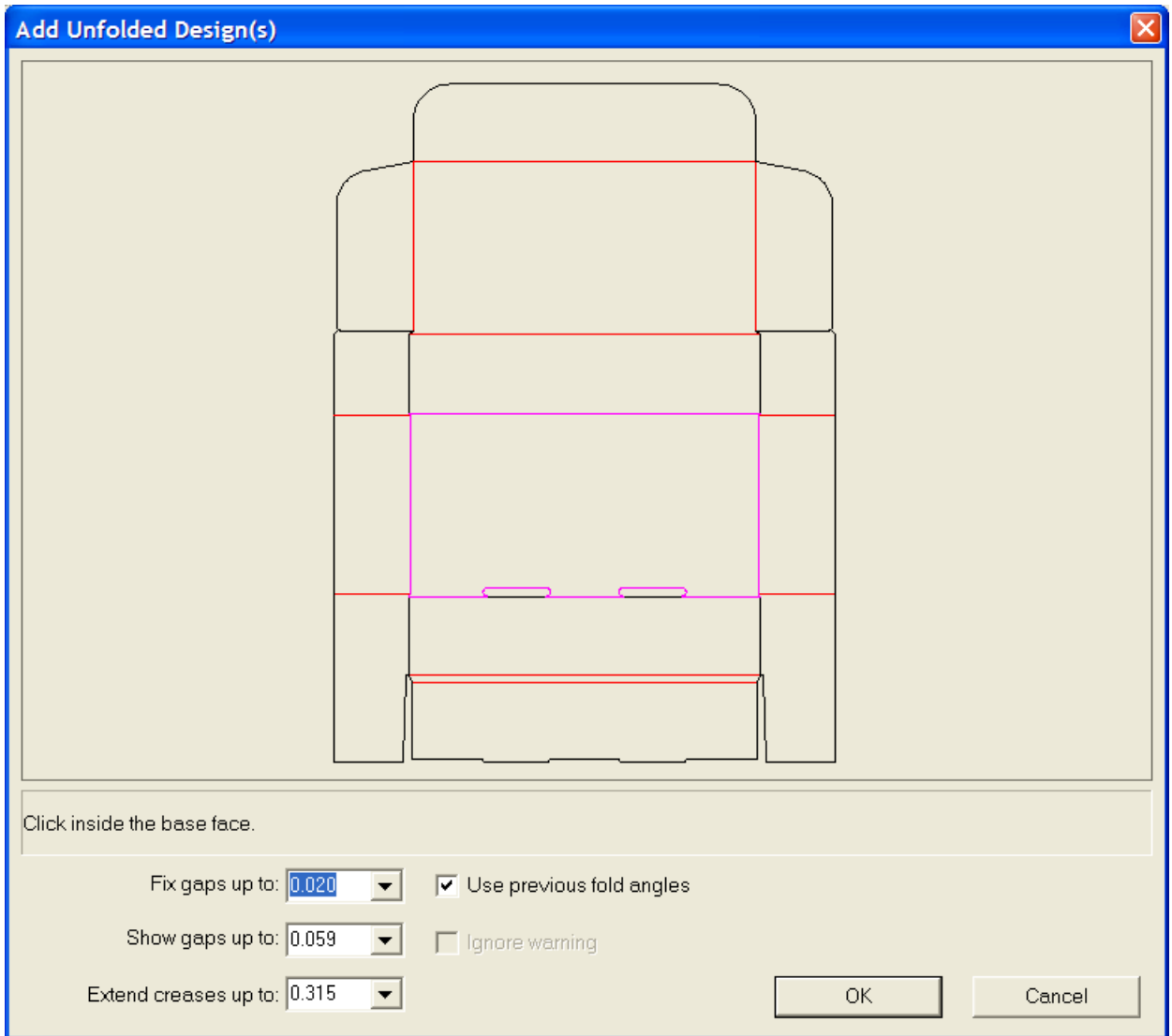

Pre-defined fold angles in designs created from standards

When you create a standard and fold it, the fold angles are stored in the standard workspace when it is saved. When a single design is then based on that standard, the fold angles and base face are remembered when the new single design is converted to 3D.

Shown below is a single design based on a standard.

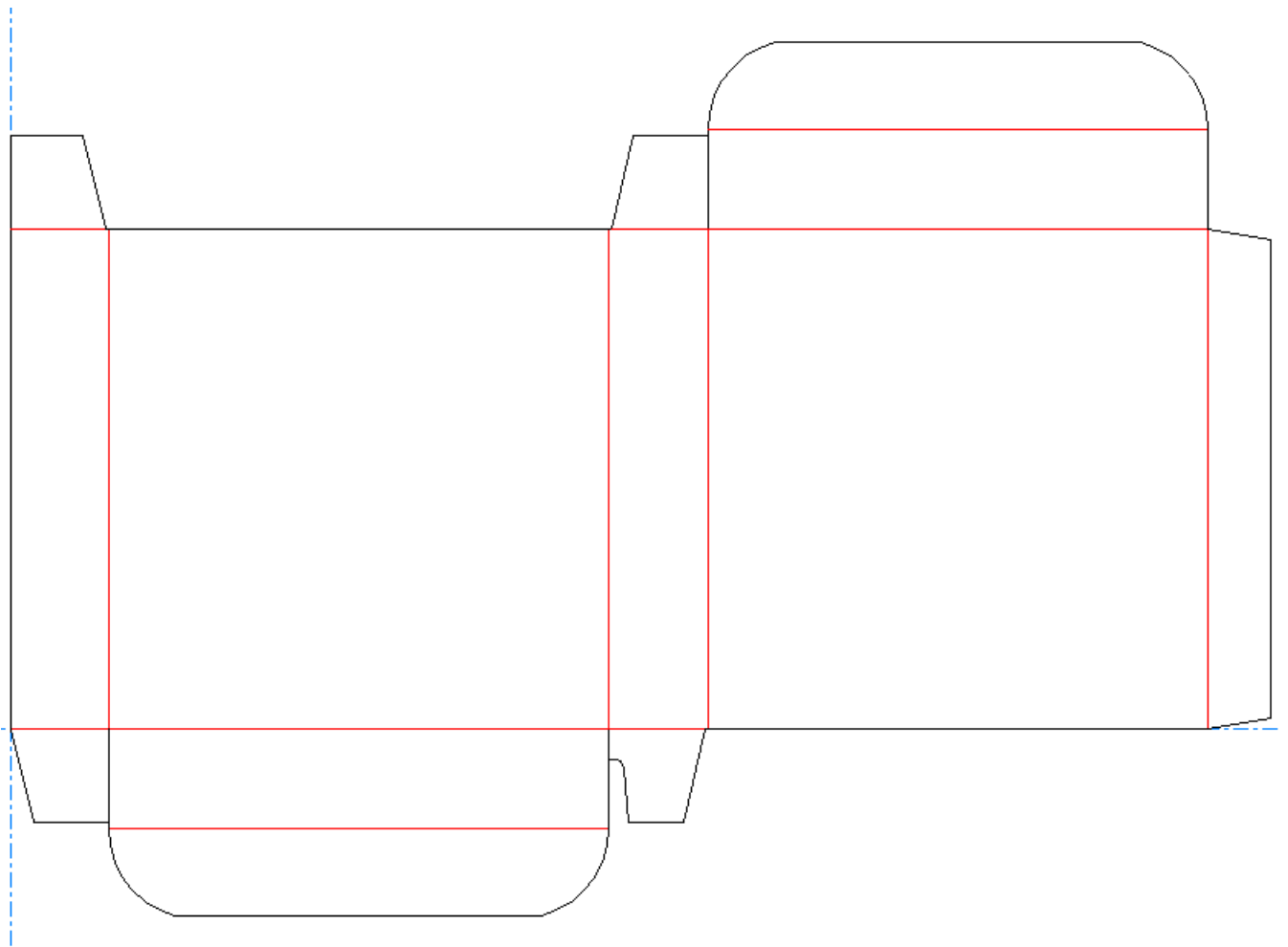

When the **Convert to 3D** button is clicked on the tool bar, the Add Unfolded Design(s) dialog box opens. The base face is preselected and the **Use Previous Fold Angles** checkbox is selected.

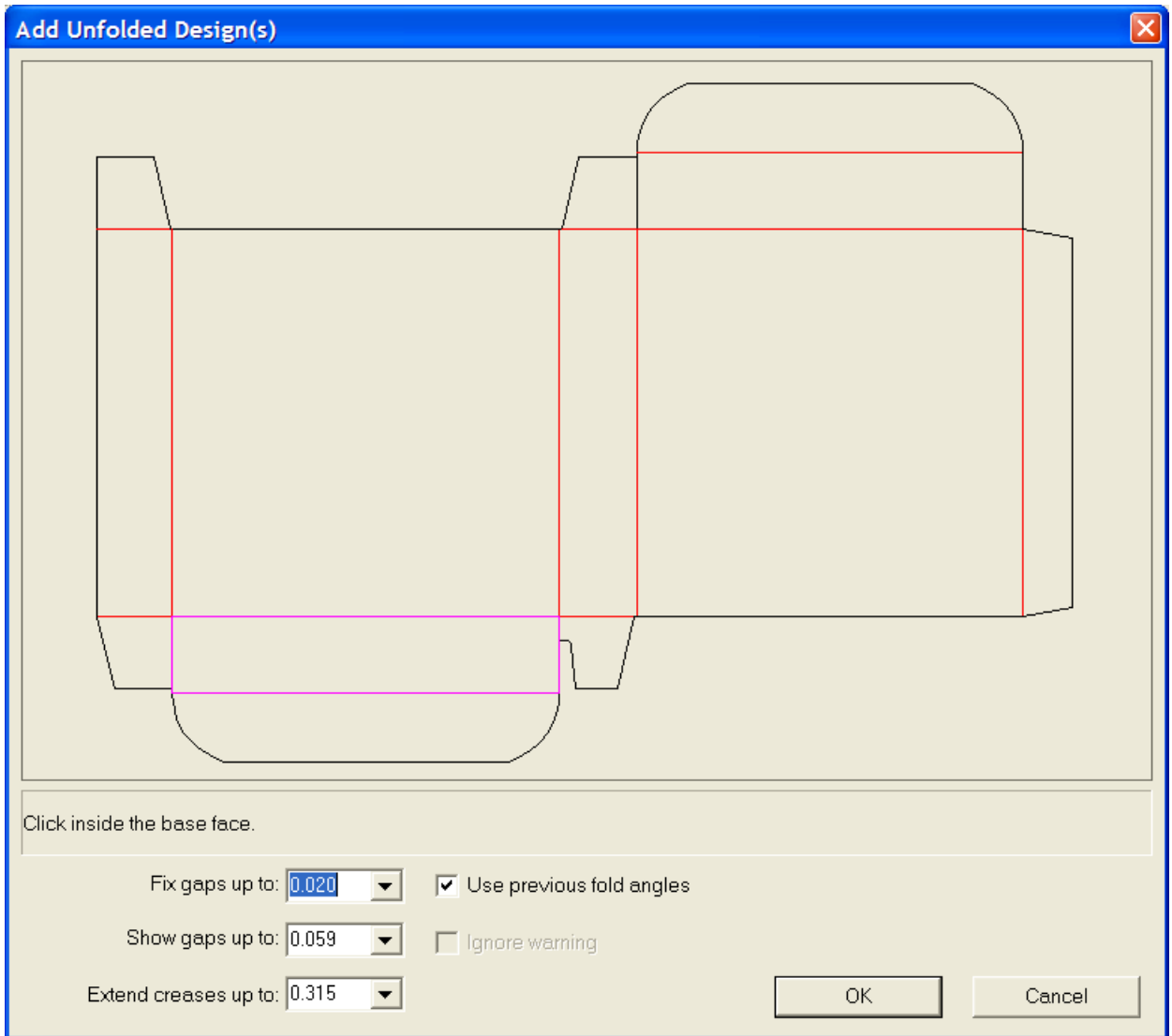

Note: When using multi-part designs, fold angles are remembered for only one of the parts.

When you click **OK** to accept the default base face and use the previous fold angles, the design will appear fully folded.

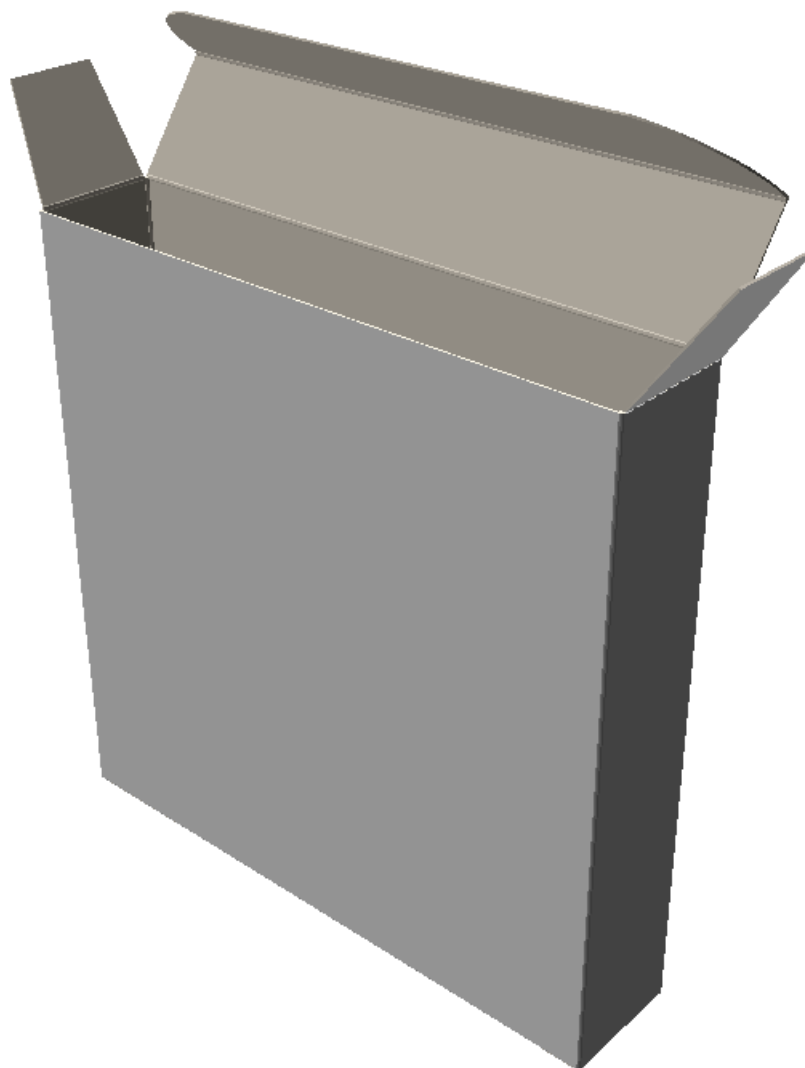

Folding all creases in a design at 90 degrees

To fold all creases at 90 degrees, do the following:

1.  Click the **Fold All** button.
2. Select a crease in the design you want to fold. If you want to fold more than one design, hold down the SHIFT key and select a crease in each design.
3. Select **90** from the list box for the **Angle** field.
4. All the creases in the selected designs will be folded at 90 degrees.

You may need to click **Scale to Fit** to reset the view of the design.

Folding individual angles

To fold angles individually, do the following:

1.  Click the **Fold Angle** button.
2. Select the crease or other foldable line to fold. To fold more than one crease at once, hold down the SHIFT key and select additional creases, or hold down CTRL while dragging to make a window selection.
3. Set the angle using the slider or the list box.
4. The angles will fold.

You may need to click **Scale to Fit** to reset the view of the design.

Adding another design to a 3D workspace

To add another design or import another file to your workspace, do this:

1. Click **File > Add a Design**.
2. Make sure the drive, directory, and file type settings are correct.
3. Double-click the name of the desired file.
4. Repeat steps 1 through 3 as desired.

Note: The ability to import certain 3D file types is controlled by the licenses purchased for the system. Your system will not be able to import 3D files of certain types without corresponding licenses. Contact your Esko salesperson for more information on purchasing licenses for importing 3D files. If it will take longer than a minute to render the edges when adding another design, edges will be turned off if they are on in the current view. You may turn them back on manually by changing the View Mode.

Add to Open 3D tool

The **Add to Open 3D** tool on the **Tools** menu lets you add one 3D workspace to another, avoiding the intermediate step of saving the first workspace and then using **Add a Design** in the second workspace.

To use this tool, do the following:

1. Start ArtiosCAD and create, open, or convert at least two 3D workspaces.
2. On the **Window** menu, select the source workspace (the one to add to another workspace).
3. Click **Tools > Add to Open 3D**.
4. If you have more than two 3D workspaces open, select the destination workspace in the dialog box and click **OK**. If there are only two workspaces open, ArtiosCAD automatically selects the destination workspace.
5. ArtiosCAD adds the source workspace to the destination workspace in front of the contents of the destination workspace.

Converting a multi-part design to a 3D workspace

To convert a multi-part design to 3D, do the following:

1. Put all the parts together in one Single Design workspace, and then convert it to 3D. Up to 50 parts can be touching; if there are more than 50 touching parts, separate them into arrangements of 50.
2. Click inside the base face for each part to convert to 3D. Any part with creases that does not have a base face selected will be discarded. When there are many parts touching, it is not clear which parts are useful and which parts are waste. ArtiosCAD discards pieces thinner than 20 mm as waste; specifically deselect larger waste pieces.

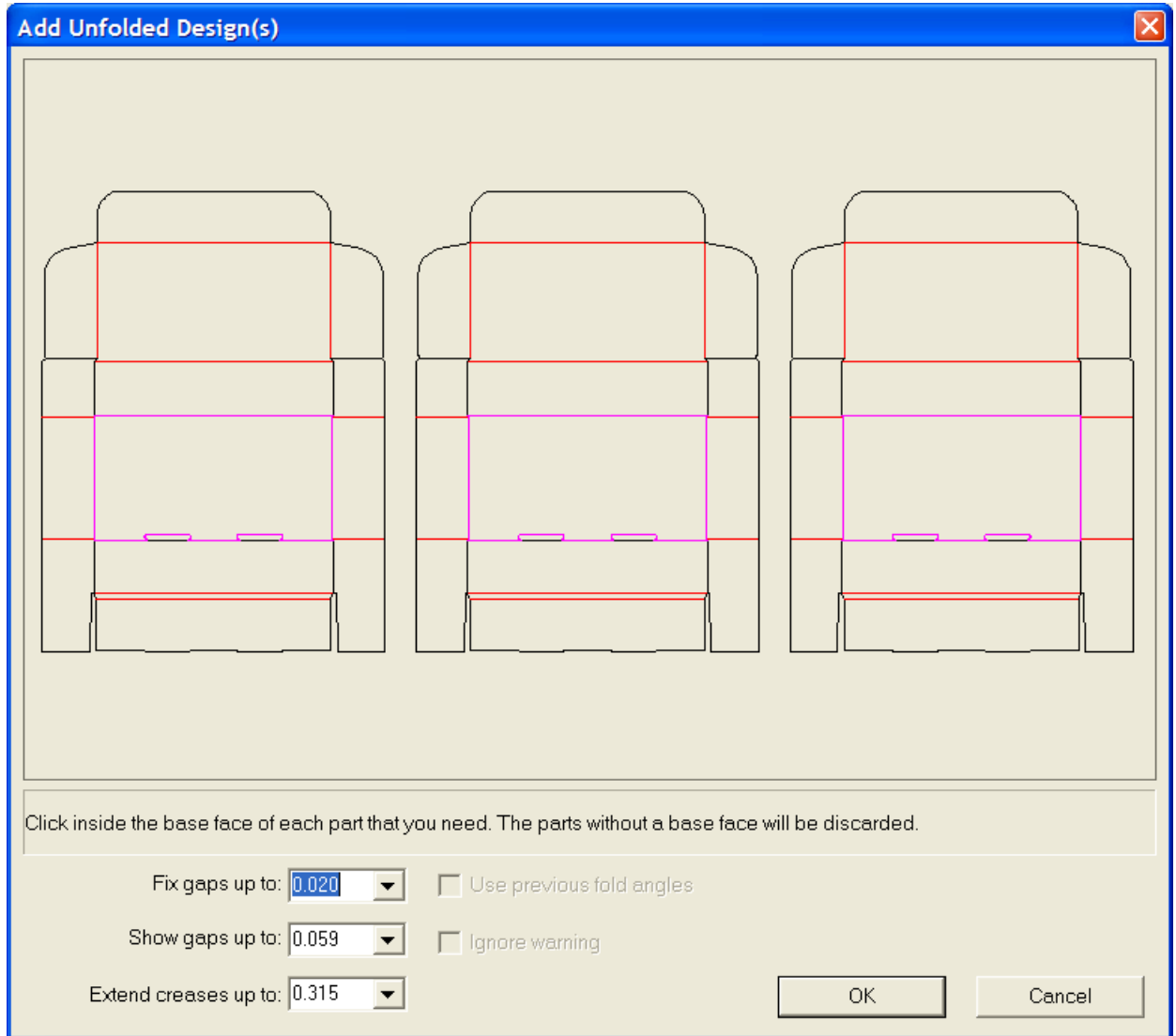

3. Click **OK** to convert the multiple parts to 3D.

Note: Multi-piece single designs without creases (such as words made of cut lines) are limited to having a maximum of 300 pieces when converted to 3D.

Converting a canvas to 3D

To convert a canvas to 3D, do the following:

1.  In the canvas, click **Convert to 3D**.
2. In the Add Unfolded Design(s) dialog box, ArtiosCAD shows the parts. All the parts should be shaded gray to indicate they have no gaps or problems. ArtiosCAD shows designs without a base face that it will not convert to 3D in white. Panels that ArtiosCAD does not fill in will not be in the 3D workspace, so cancel the conversion and fix the problems.

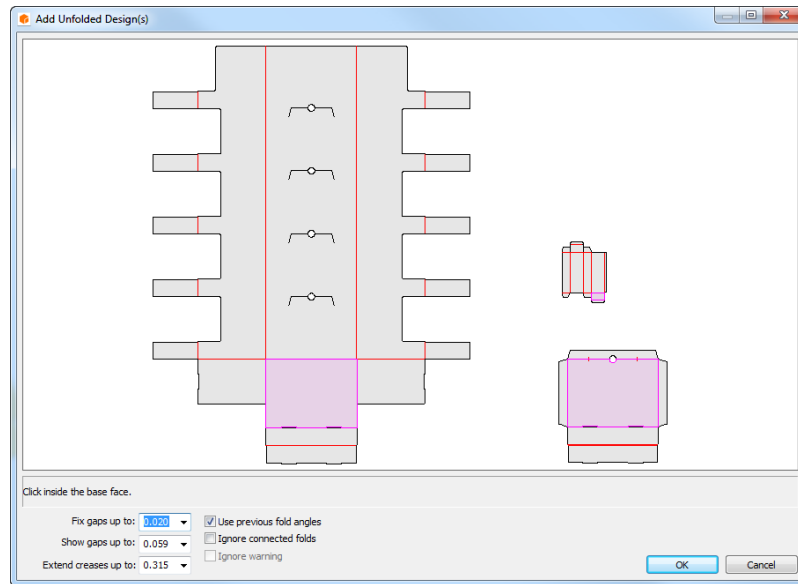

3. Click inside the base face for each part; it will turn light purple. To deselect a part so it is not added to the 3D workspace, click inside it so it turns white. ArtiosCAD automatically selects one-panel parts.
4. Click **OK** to create the 3D workspace. If this canvas used standards or parts that had already been converted to 3D, there should be remembered fold angles.

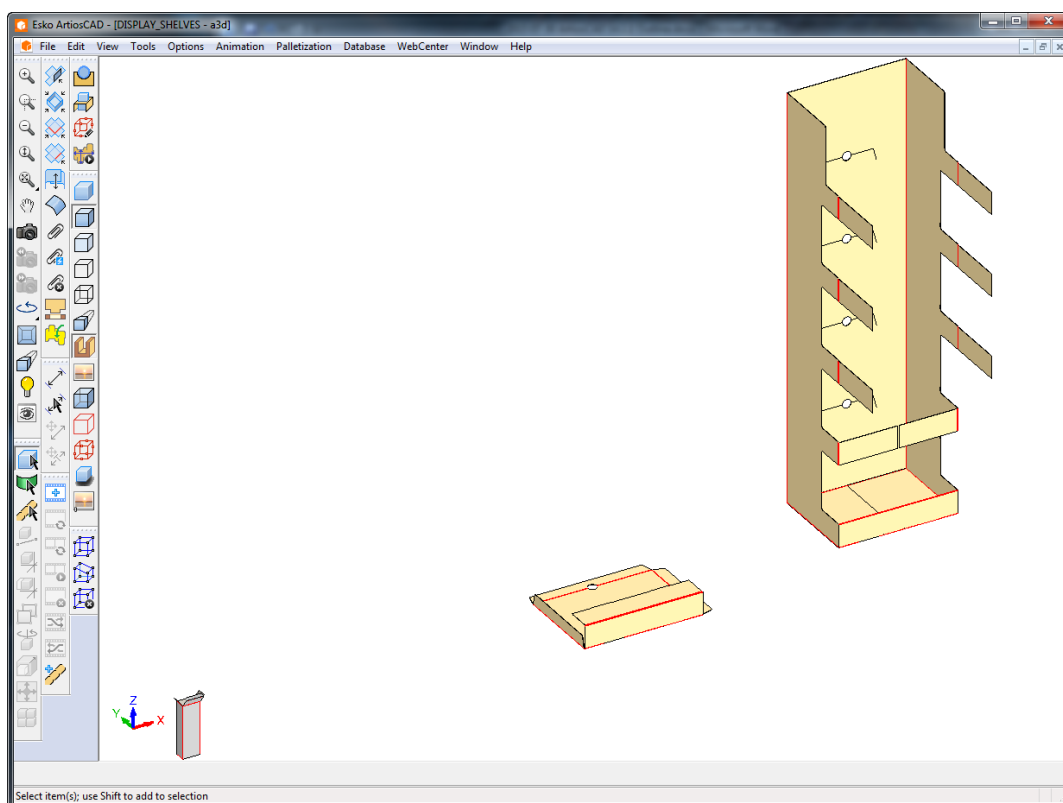

5. Fold and position the parts as desired.

ArtiosCAD compares part counts between the canvas and any saved 3D information in the workspace if **Use previous fold angles** is enabled. If there is a conflict, ArtiosCAD prompts you to choose which part counts to use.

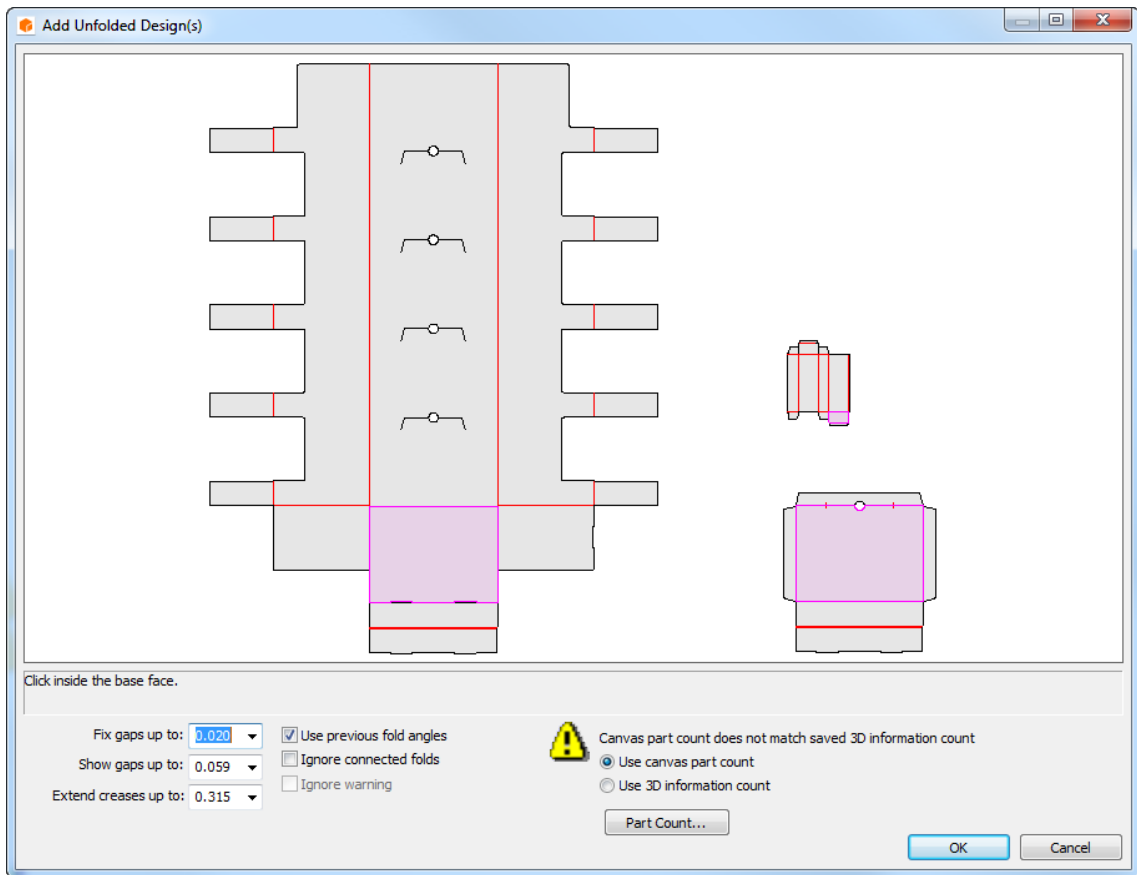

Click **Part Counts** to see the conflicting counts.

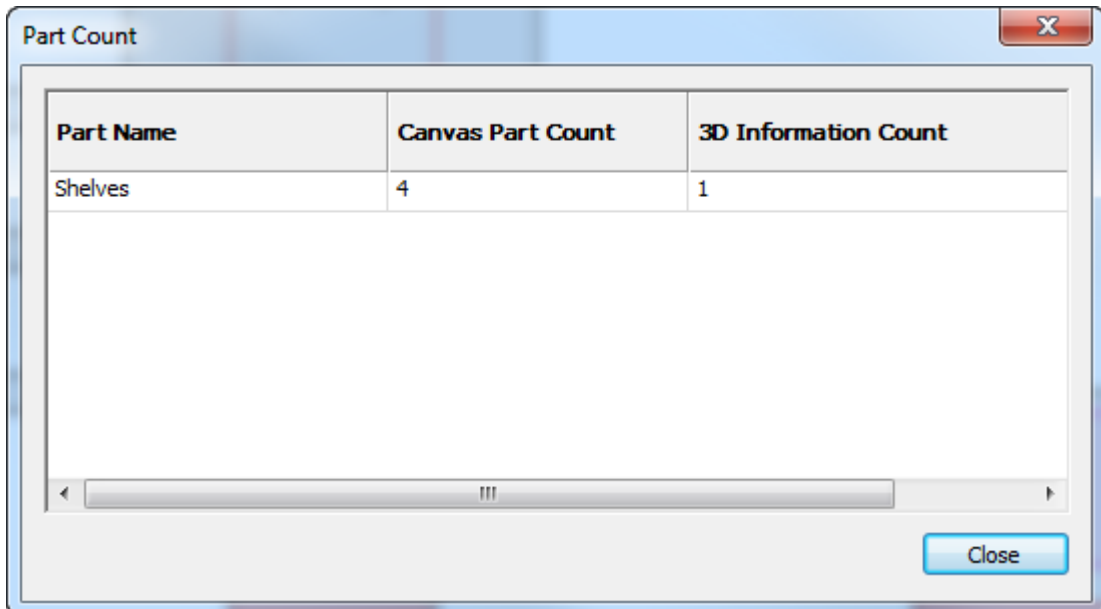

If the count number increases in the 3D workspace, ArtiosCAD stacks the new copies in a grid in front of the scene. In the example below, the eight shelves were the count from the canvas

after deleting all of the shelves from the open 3D workspace and reconvertng the canvas to 3D.

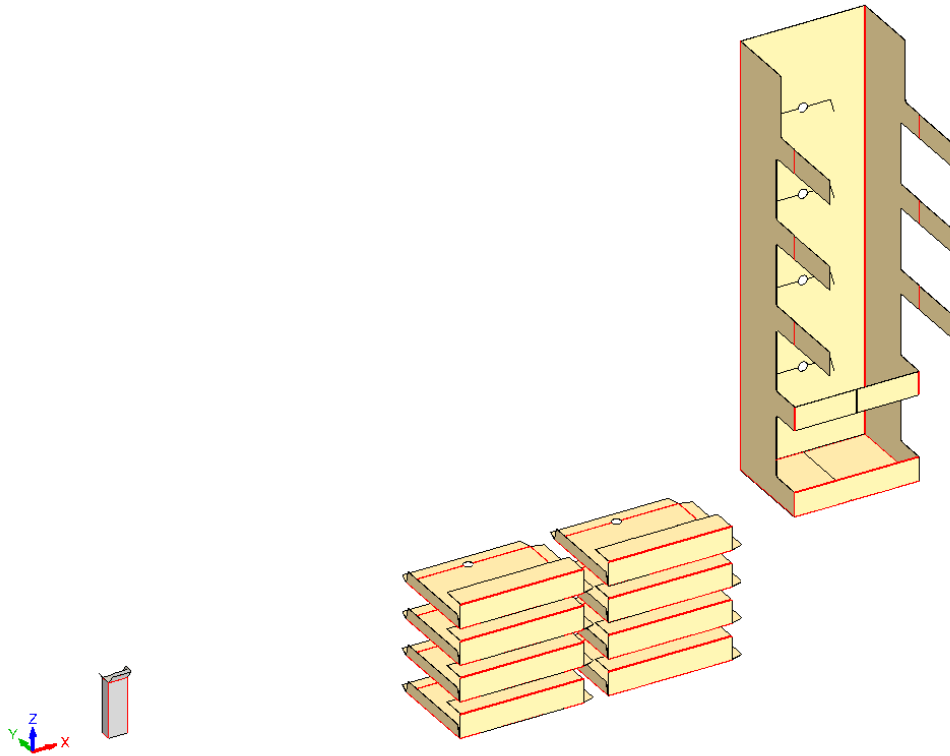

If the canvas already contains hardware parts and you are reconvertng it to 3D, ArtiosCAD positions the hardware based on the hardware placement lines in the 2D design. Note that the placement lines are not mates and do not force the hardware to stick to the design.

ArtiosCAD warns you if it cannot find the hardware workspace or if holes are missing. However, ArtiosCAD does not warn you if you changed the hole shape in 2D.

Changing the view of a workspace in 3D

To change how a workspace is viewed, do the following:

1.  Click the **View Angle** tool.
2. Drag the sliders for **Angle**, **Elevation**, and **Roll Angle** to the desired positions, or type in the values in their boxes, or select predefined values from the list boxes. You may also click and drag inside the drawing window to change all three angles simultaneously. To change only the Roll angle, hold down CTRL while dragging from to the left or right. The View angle will change according to the settings in the View Mode dialog box.
3. The view changes appropriately.

You may need to click **Scale to Fit** to reset the view of the design.

Changing the base face

The base face is the panel of the design around which all other panels fold. Imagine the container resting on a table. The base face is the panel on the table. To change the base face, do the following:

1.  Select a design using the **Select Designs** tool.
2. Click **Change Base Face** on the **Tools** menu.
3. Click inside the new base face and click on **OK**.
4. The base face will be changed. You will not see a difference until you change fold angles.

Printing a folded workspace

To print a workspace, do the following:

1. Click **Print** on the **File** menu.
2. Change any values as appropriate (for example, to make two copies, set the number of copies to 2).
3. By default, one copy of the workspace will be printed in portrait mode at the largest scale that can fit on one page.
4. Click **OK**.

For more information about performing other Outputs from 3D, see the section about 3D Outputs.

Saving a workspace in 3D

Before saving the design, ensure High Graphics mode is not set to **Maximum** in the View Mode dialog box, as this may cause the preview to not be generated correctly.

To save a workspace, click **Save** on the **File** menu. The workspace will be saved with the name and database resource (if applicable) shown in the title bar of the workspace window. If the 3D workspace was created from a flat workspace which is still open, the fold angles from the 3D workspace are saved to it.

If this is the first time you have saved the workspace, you will be brought to the Save As dialog box, where you will be prompted to enter a name for the workspace.

If you have already saved this design, a current copy of the workspace will overwrite the saved file.

If you want to save the design under a different name and keep working on the original file, click **Save Copy As** and enter a name for the copy. If you want to save the workspace under a different name and not under the current name, click **Save As** on the File menu and enter the new name. If you did not save the workspace with the old name, it will be lost.

The full pathname of the source file for each design in the workspace is retained. When using tools that act upon the individual designs and require filenames, the full paths are shown in the **Filename:** field.

For more information about performing file-based Outputs from 3D, see the section on 3D Outputs.

Saving fold angles changes

When you close a 3D workspace and its associated single design or canvas is still open, you can choose whether or not to save the fold angles, view settings, and board code changes back to the single design or canvas.

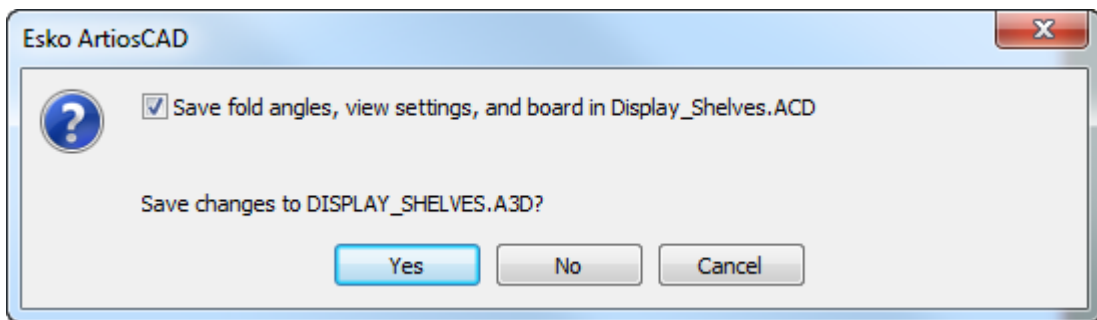

To not save the fold angles, view settings, and board code changes back to the single design or canvas, clear the **Save fold angles, view settings, and board in design name** checkbox. ArtiosCAD only updates the board in a single design if all 3D designs from the same single design workspace are changed to the same board in 3D.

Then click **Yes** or **No** to save the changes to the 3D workspace.

Note:

These are two separate actions. Clearing the checkbox only applies to the saving of the fold angles, view settings, and board code changes, not to the saving of the changes you made in the 3D workspace.

Saving part count changes

If ArtiosCAD detects that the part counts do not match between a 3D workspace and a canvas when you save or close the 3D workspace, it shows you the discrepancy.

To save the part count changes, do the following:

1. Save or close the 3D workspace.
2. ArtiosCAD will prompt you as shown below. Review the information in the dialog box.

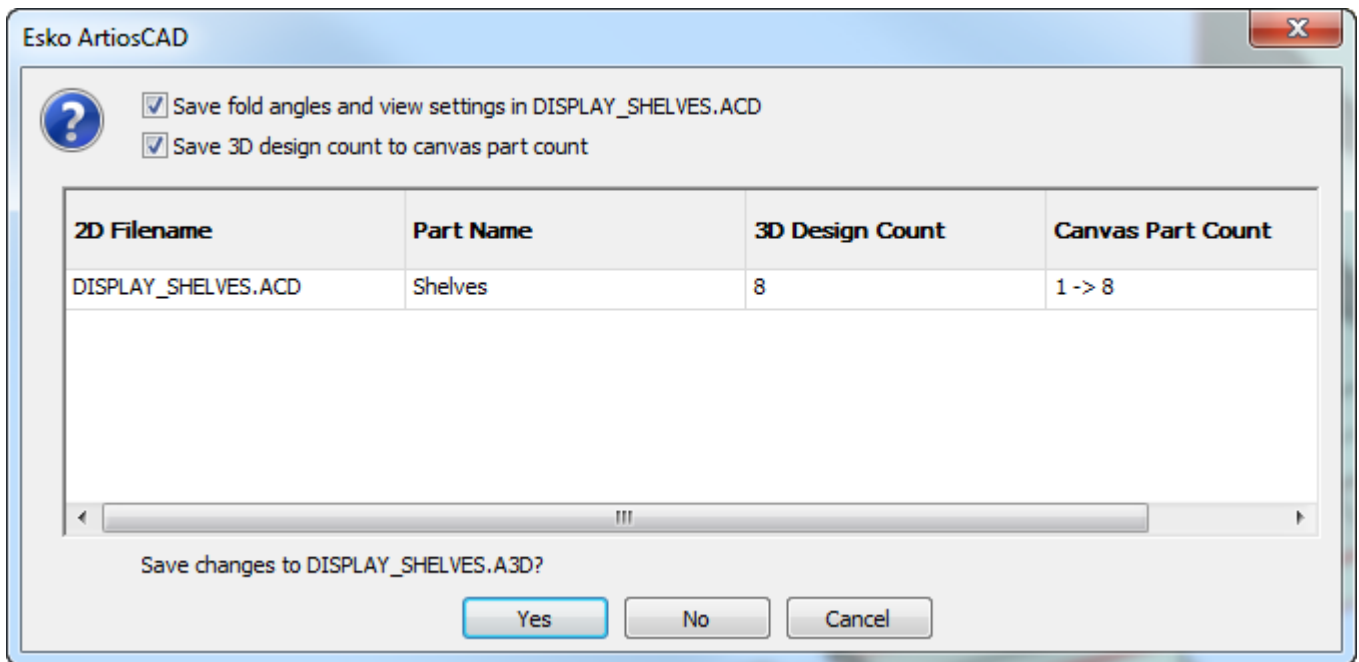

3. Check **Save 3D design count to canvas part count**.

4. Click **Yes**. ArtiosCAD saves the workspace.

Make sure to save the updated canvas as well.

Note: Unlike using **Update 2D**, closing a 3D workspace does not remove hardware placement lines from the 2D workspace if the hardware no longer exists in the 3D design.

Copying a 3D workspace to the Windows Clipboard

To copy a low-resolution picture of the workspace onto the Windows clipboard, click **Edit > Copy as Bitmap**. Transparency is not supported. A better workflow is to export the workspace as a JPEG or PNG file using **File > Outputs-3D** and then import the JPEG or PNG file as desired into other applications.

To copy line information for use in Single Design, click **Copy > Copy as Enhanced Metafile**. This copies the workspace to the clipboard as both a low-resolution bitmap and as lines (also called *vectors*). The colors of the lines are set by the plotting style.

Using **Copy as Enhanced Metafile** is a way to make assembly drawings - copy views in 3D and then paste them into a Single Design workspace as desired, fixing any hidden line anomalies with the Select or Trim/Extend tools.

Elements included when performing a **Copy as Enhanced Metafile** include cartons and solids, board thickness, inside and outside graphics and board textures, the background image (if defined), and dimensions (which are converted to text and arrows for scalability). Bounding boxes are not included.

Notes and warnings

In complex workspaces, hidden line removal may not perform optimally. Any stray lines are easily removed in Single Design.

Depending on the capabilities of your system, this command may take several minutes to finish when there are more than 10 cartons in a workspace or for solids with more than 10,000 polygons. To show the number of polygons, click **Help > Diagnostics > List Embedded Designs**.

If there are too many polygons to render in less than a minute, a warning dialog box will appear asking you to choose to copy the design as a bitmap only, or continue and render as vectors. Choose the desired option and click **OK**, or click **Cancel** to cancel the copy to clipboard.

Copy as Enhanced Metafile includes edges even if they are not turned on in the current view.

Exiting 3D

To exit 3D, click **Exit** on the **File** menu. If you have changed your design since last saving it, you will be asked if you want to save it again. If the 3D workspace was created from a flat workspace which is still open, the fold angles from the 3D workspace are saved to it. Click **Yes** to save the 3D workspace, or click **No** to exit without saving. **Cancel** returns you to the workspace without exiting 3D.

This also exits ArtiosCAD. To exit the 3D module alone, close any open 3D workspaces.

Moving, duplicating, and rotating objects in 3D

The tools in this section affect the physical placement of objects in the workspace.

Working with different simultaneous view angles

Sometimes different simultaneous view angles make moving or copying elements of the workspace easier. Using a CloseUp window allows you to work with different angles and avoid tool restarts caused by clicking between design windows. To create different viewing angles using a CloseUp window, do the following:

1. Set the view angle as desired in preparation for the first view angle.
2. Click the middle mouse button at the location of the center of the first view angle, or press CTRL-Space and click the left mouse button in that location. This creates the first CloseUp window.
3. Click the magnifying glass icon in the title bar of the CloseUp window and deselect **Dynamic**. Move the CloseUp window as desired.
4. Change the view in the main ArtiosCAD window as desired to create the second view angle.
5. Use a Select tool to select the object(s) to move or copy.

6. Use a move or copy tool to pick-up in the CloseUp window and put-down in the ArtiosCAD window.

3D Extend tools

The **Extend** and **Clear Extend** tools on the 3D Extend Tools toolbar create and remove bounding boxes around objects in 3D. Turn on the toolbar by clicking **View > Toolbars**, clicking the button next to **3D Extend**, and clicking **OK**.



The bounding boxes create 20 points than can be used as pick-up and put-down points. They make it easier to move, copy, and place objects.



The **Extend** tool creates a bounding box. To use it, click the tool, and the click the object to extend. The bounding box will appear, with selectable points at the corners and midpoints of each line. More than one object can have a bounding box. Bounding boxes remain visible until they are removed with the **Clear Extend** tool. Shown below is a bounding box for the outer box.

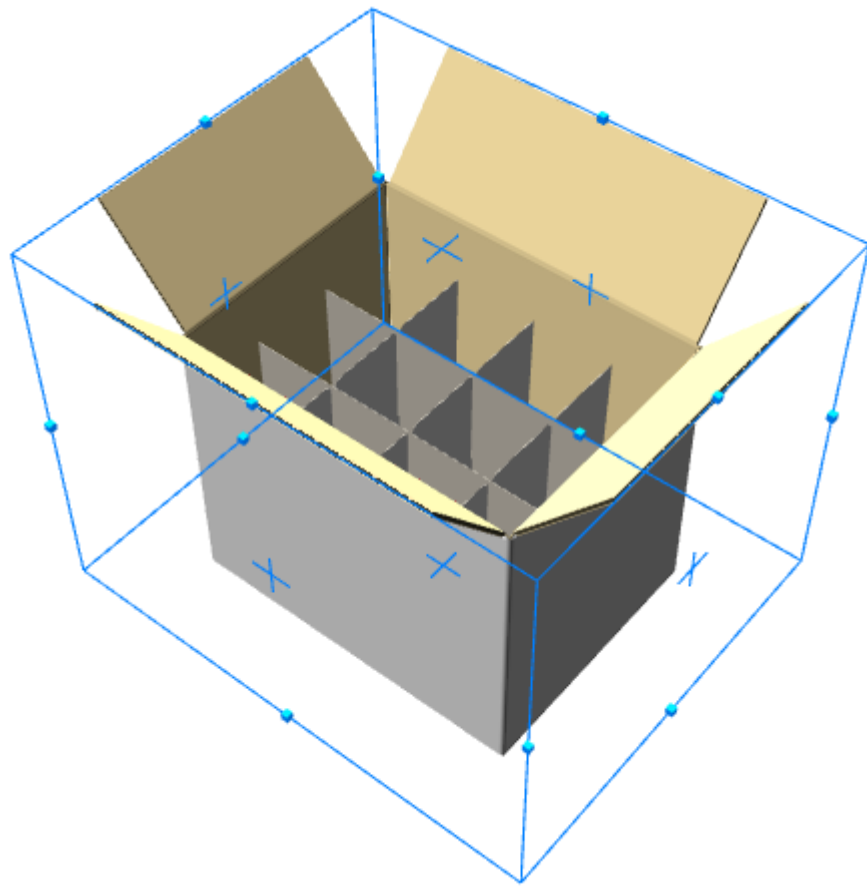

The **Extend Design** tool shows extend points instead of a bounding box.

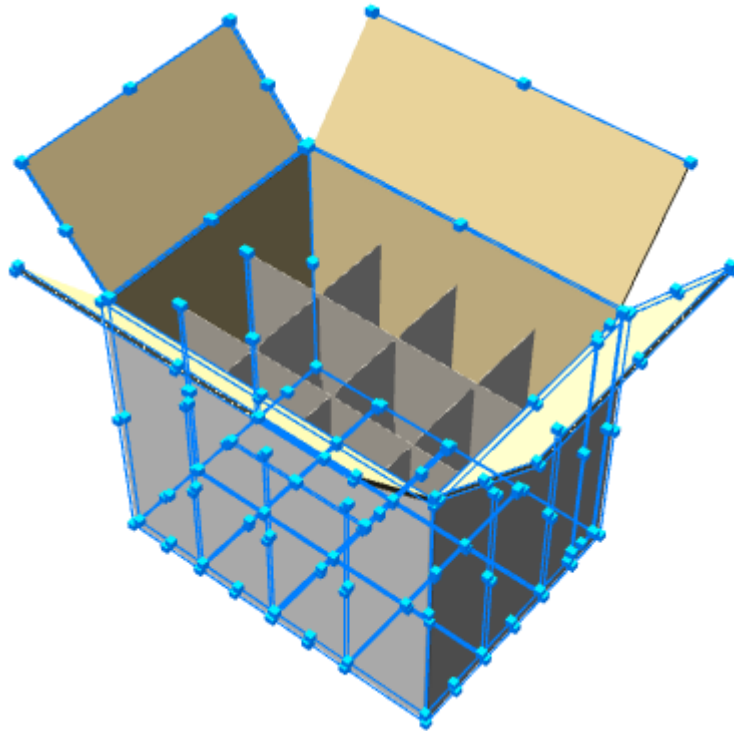

The **Clear Extend** tool removes all bounding boxes and extend points. To use it, click it, and all bounding boxes and extend points disappear.

Select Designs tool



The **Select Designs** tool is used to select one or more objects. Selected objects can then be moved, rotated, copied, or deleted. Delete objects by selecting them and pressing Delete on the keyboard.

Click the **Select Designs** tool, then click on any line in a design. To select more than one design, hold down the SHIFT key as you select the designs. Selected objects will turn magenta to indicate they are selected.

Move Point to Point tool



The **Move Point to Point** tool moves two designs together so that the pick-up point of the first design is aligned exactly with the put-down point of the second design.

1. Select a design using the **Select Designs** tool.
2. Click the **Move Point to Point** tool.
3. Select the pick-up point in the design you just selected.

4. Select a put-down point in another design. The first design will move so that the pick-up and put-down points are aligned.

Move Designs tool

The **Move Designs** tool is the first tool on the Move Designs flyout toolbar. This tool moves one or more designs in one direction.

1. Select one or more designs using the **Select Designs** tool. It will turn magenta to show it is selected.
2.  Click the **Move Designs** tool.
3. Select a pick-up point. There are pick-up points on the inside and outside of lines. The three directional axes will appear centered on the pick-up point.



4. Click an axis or line to set the direction in which to move the selected designs.
5. Move the mouse to move the selected designs in the direction indicated in step 4, or enter a distance on the Status bar.

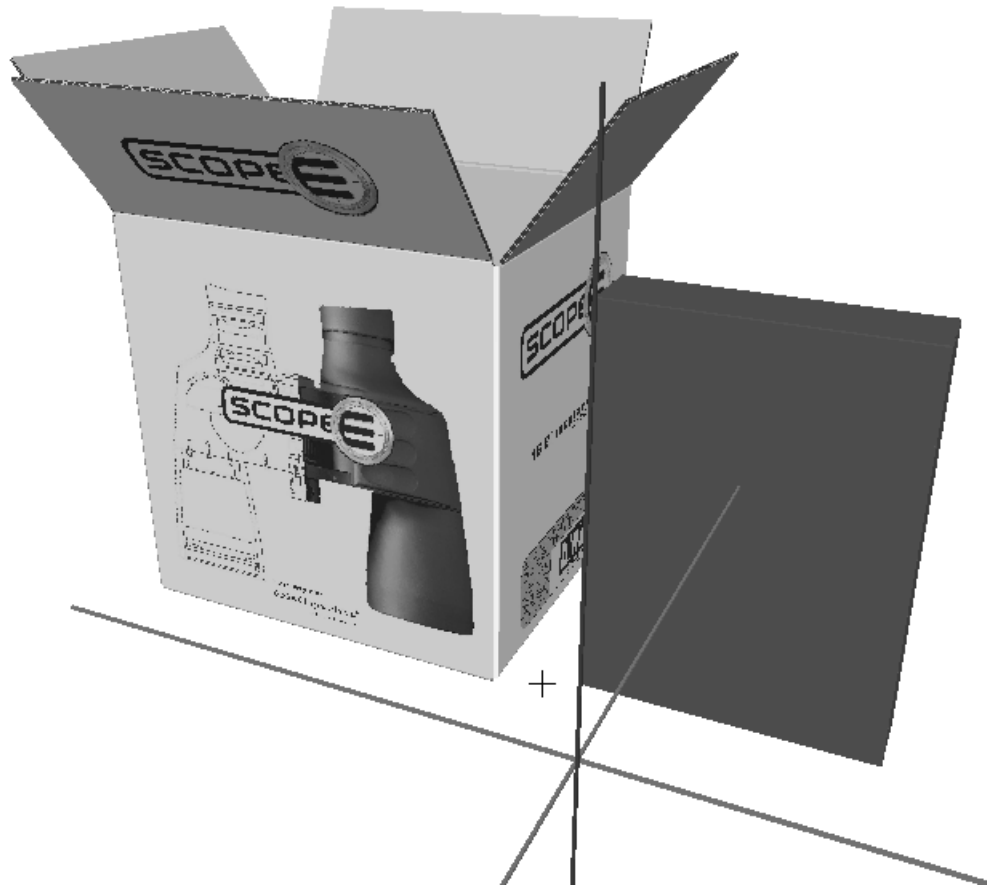

6. Click to set the put-down point of the selected design, or click an existing point to align the put-down point with it. Hold down CTRL while clicking to add another offset before setting the final put-down point. The Move tool remains active with the current selection so that another move may be performed without having to reselect the tool and pick-up point. Shown below is the moved design.



If you check **Check collisions** on the Status bar, the object you are moving stops when it hits another object, and the object it hits turns red.

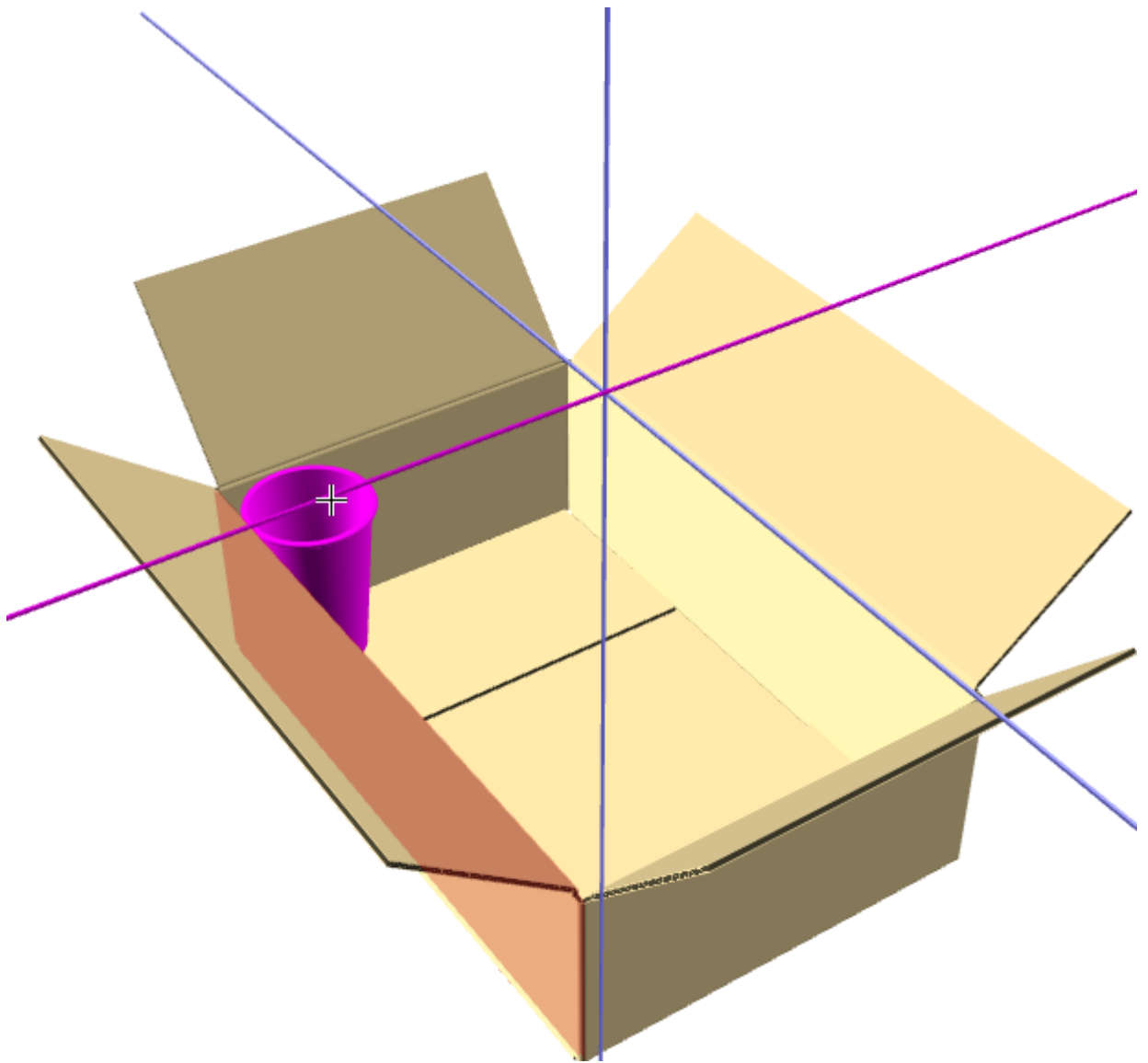

If you continue dragging, the object you are moving moves through the interfering object once it is far enough away to not collide with it.

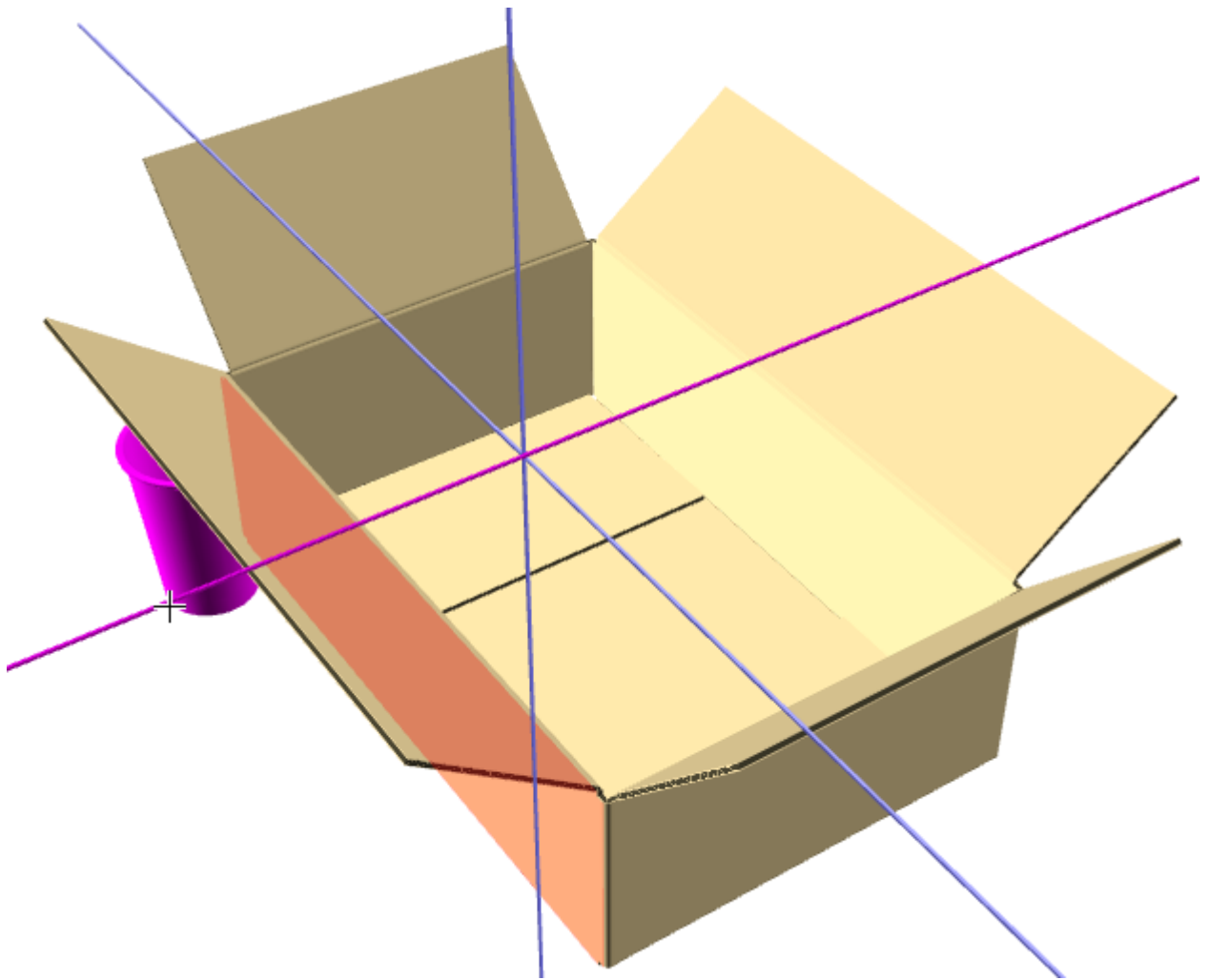

Clicking **Gutter** and entering a value in the field sets a gutter between the edge of the moving object and the interfering object. Shown below is the same example with a gutter of one inch.

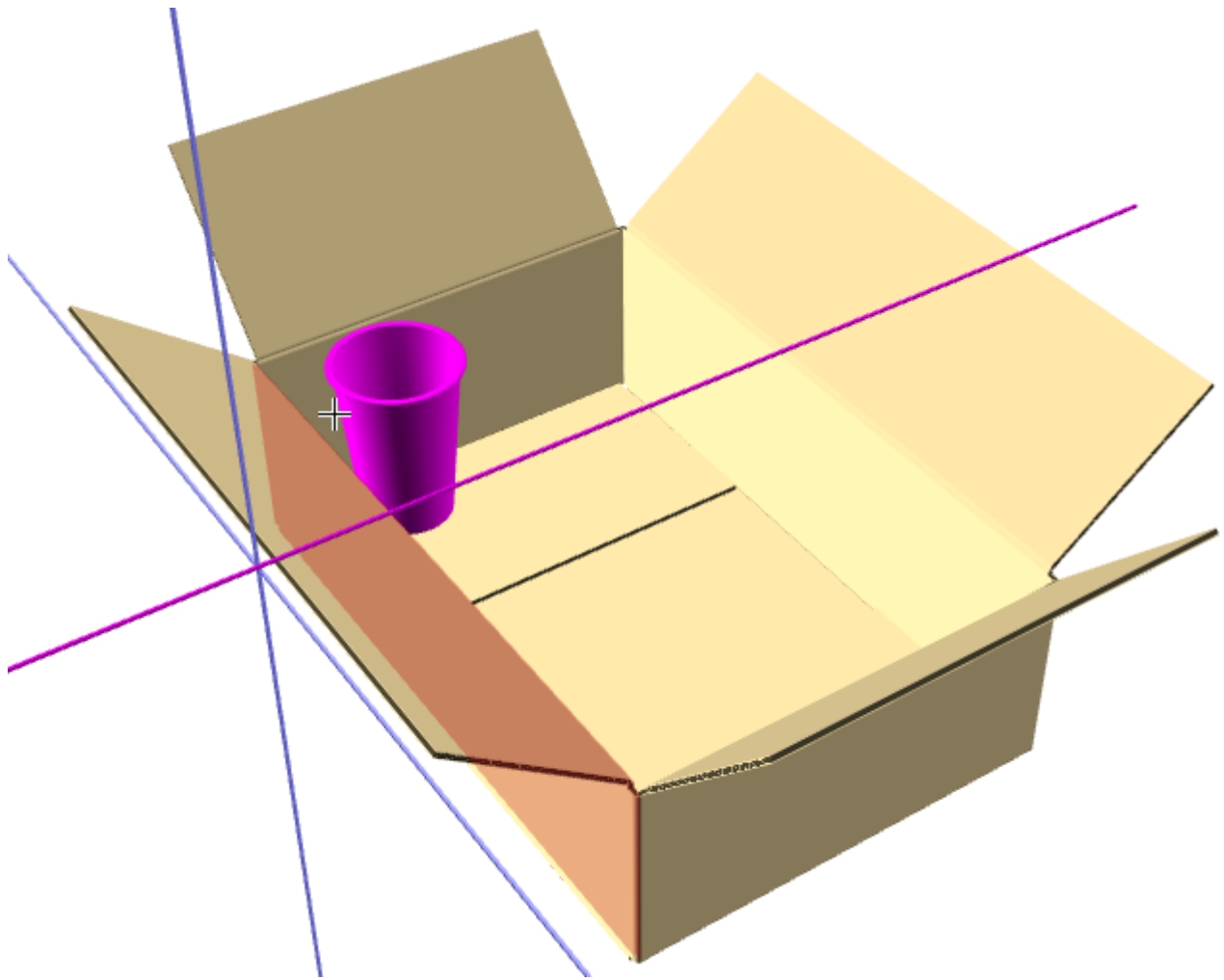

Fit tolerance

Fit tolerance on the **Move Design** tool's Status bar in 3D lets you squish together designs which would take some effort to fit together in the real world. The option works by shrinking the moving design by the amount you specify in the Fit tolerance field in both directions perpendicular to the movement axis. ArtiosCAD does not change the size of the selections in the direction in which you are moving them; that is controlled by the gutter.



1. Create a 3D workspace with components that do not quite fit together.
2.  Use **Move Design** to fit them together and discover the inner carton is slightly too large to fit into the outer box, but you know you could shove it in the real world and it would fit.

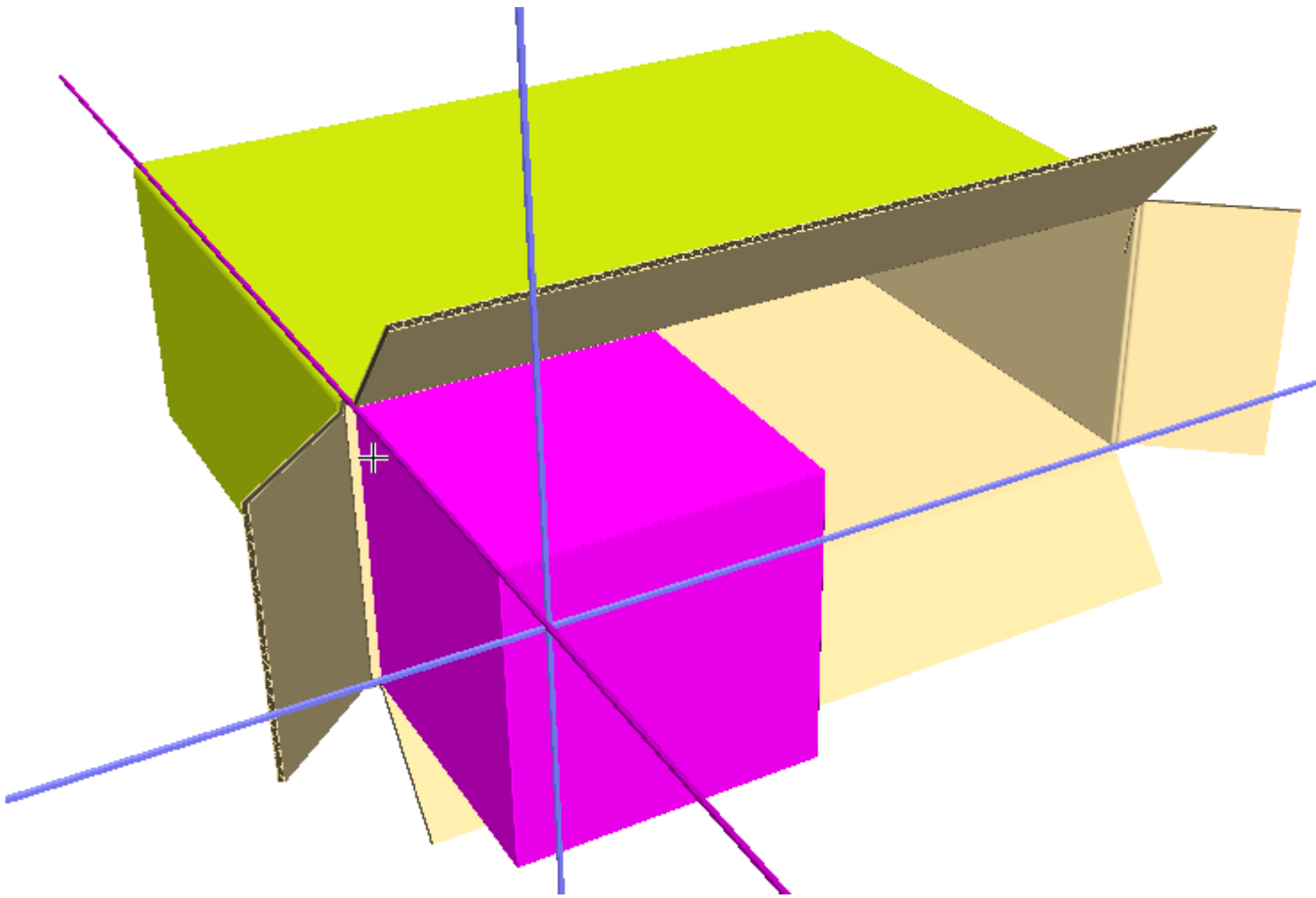

3. Check **Fit Tolerance** on the Status bar and enter a value in the field. The default is 1/16" or 1.5mm.
4. The inner box will now move inside the outer box. Shown below is it colliding with the farther edge of the outer box.

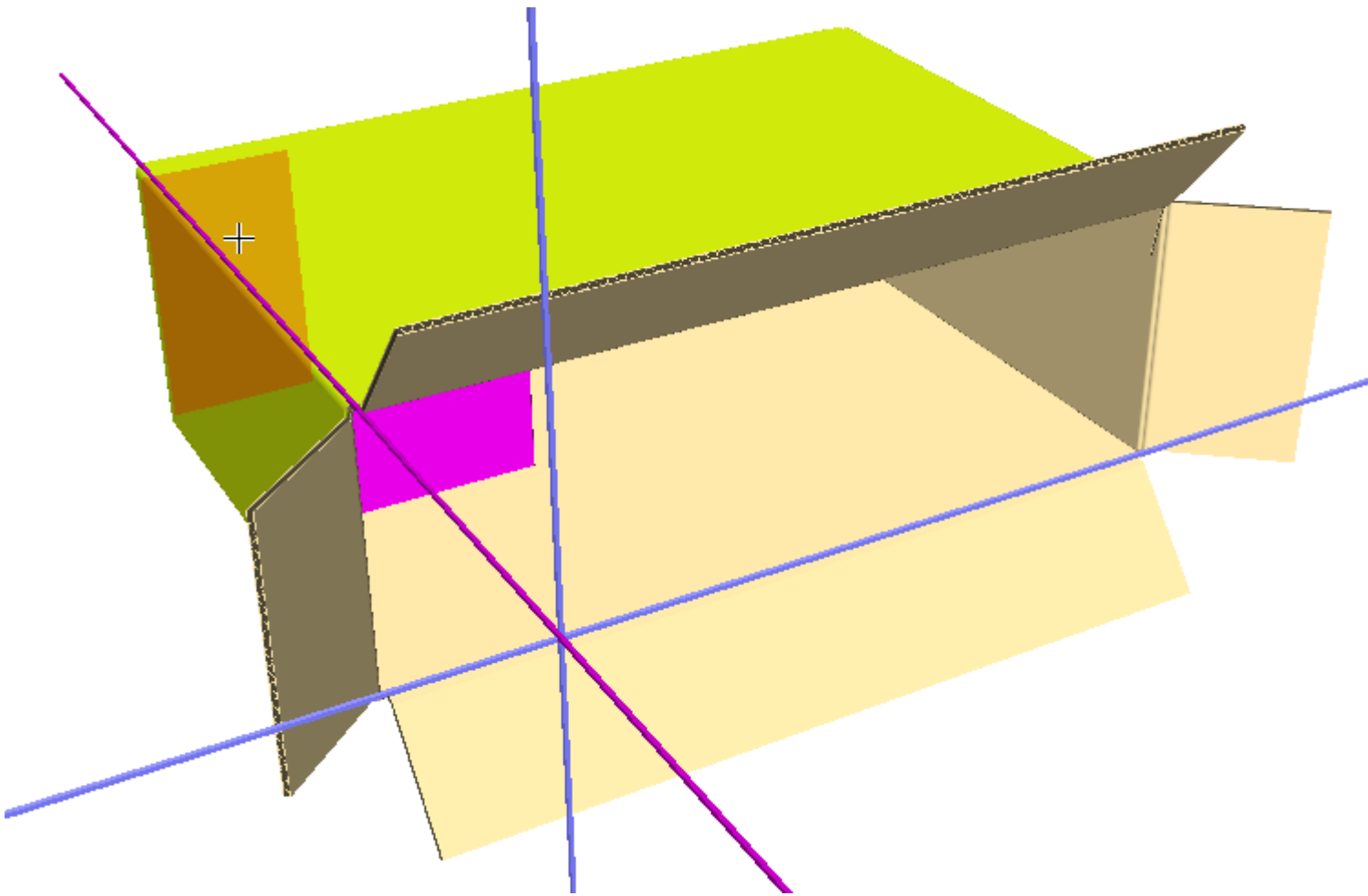

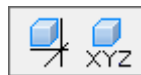

Move Designs X, Y, Z tool

 The **Move Designs X, Y, Z** tool is the second tool on the Move Designs flyout toolbar.



It moves the current selection in any or all of the three dimensions at once.

To use this tool, do the following:

1.  Click the **Select Designs** tool and select the design(s) to move or copy.
2.  Click the **Move Design in X, Y, Z** tool.
3. Click the pick-up point. There are pick-up points on the inside and outside of lines.
4. Use the drag to set the X offset, or enter a value in the **X:** field on the Status bar.

5. Once you have set the drag for the X offset or entered a value, the Y offset becomes active. Set it using drag or by entering a value in the **Y:** field on the Status bar.
6. Once you have set the drag for the Y offset or entered a value, the Z offset becomes active. Set it using drag or by entering a value in the **Z:** field on the Status bar. If you set the Z offset using drag, the design will move when you click the mouse button. If you entered the Z offset on the Status bar, click **OK** and the design will move.

Duplicate Designs tool

 The **Duplicate Designs** tool makes one or more copies of the currently selected designs. It is the first tool on the Duplicate Designs tools flyout toolbar.



1. Select the design or designs to copy.
2. Click the **Duplicate Designs** tool.
3. On the Status bar, enter the number of copies to make in the **Number of copies:** field.
4. Select a pick-up point. There are pick-up points on the inside and outside of lines, and on the bounding box if it is turned on using the **Extend** tool.
5. Select an axis or line that indicates the direction to move the duplicates.

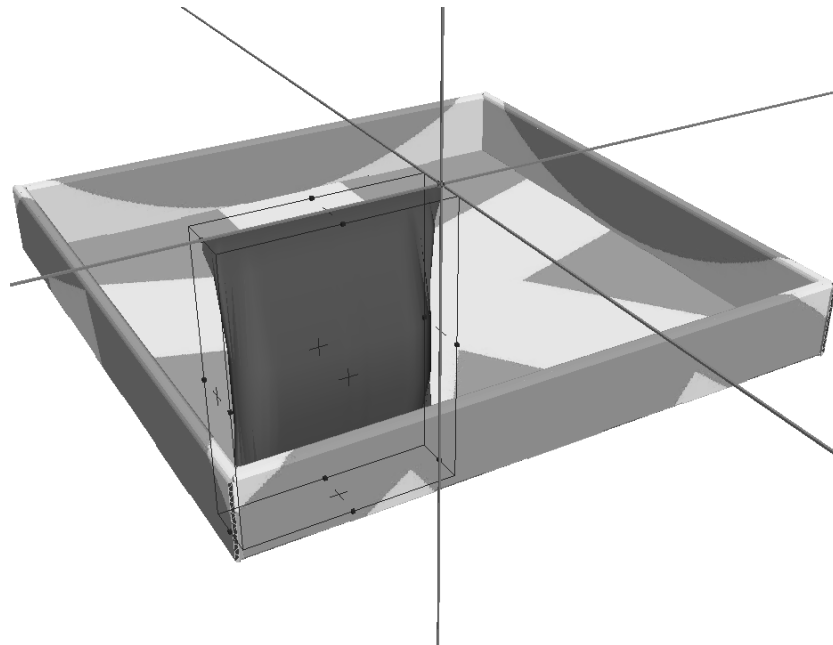

6. Indicate the distance to move the duplicates either using drag or by entering a number in the **Distance:** field on the Status bar. The copies will move with the mouse cursor.

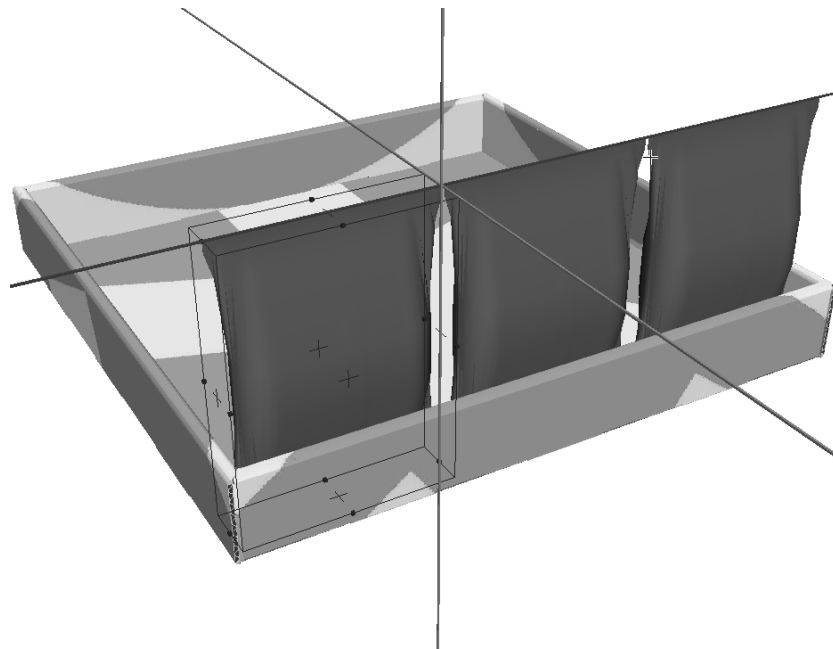

7. Click the mouse button to set the put-down point of the outlined designs. Hold down CTRL while clicking to add another offset before setting the final put-down point. The designs are duplicated. Repeat as desired.



Shown below is the finished product, with the row of three bags duplicated 10 times.





Note: When an object in 3D is duplicated, all duplicates are instances of the original object for more efficient memory usage. The duplicates may have different fold angles than the original, but the material properties of the duplicates are the same as those for the original. If you select fewer than all the copies and try to change them, ArtiosCAD prompts you to change all instances of the first copy or to make a separate copy to which the new properties would then be applied. If you choose to make copies, the amount of memory used and disc space required will increase accordingly.

Duplicate Designs X, Y, Z tool



The second tool on the Duplicate Designs tools flyout toolbar is the **Duplicate Designs X, Y, Z** tool. It works the same way as the Move Designs X, Y, Z tool, except it acts on a duplicate of the current selection.

To use this tool, do the following:

1.  Click the **Select Designs** tool and select the design(s) to copy.
2.  Click the **Duplicate Design in X, Y, Z** tool.
3. Click the pick-up point. There are pick-up points on the inside and outside of lines, and on the bounding box if it is turned on using the **Extend** tool.
4. Use the drag to set the X offset, or enter a value in the **X:** field on the Status bar.
5. Once you have set the drag for the X offset or entered a value, the Y offset becomes active. Set it using drag or by entering a value in the **Y:** field on the Status bar.
6. Once you have set the drag for the Y offset or entered a value, the Z offset becomes active. Set it using drag or by entering a value in the **Z:** field on the Status bar. If you set the Z offset

using drag, the design will move when you click the mouse button. If you entered the Z offset on the Status bar, click **OK** and the duplicated design(s) will move.

Group tools



The Group tools flyout toolbar contains the **Group Designs** and **Ungroup Designs** tools. They work the same way as they do in other modules.



To group items together, select them, and click the **Group Designs** tool. The items will be grouped together and the bounding box for the group will be turned on.

Whenever any grouped design is selected, the entire group is selected. You can nest groups within groups, but only the last-created group can be selected. When a grouped design is copied, the copy has the same group structure as the original.



To ungroup a group, select it, and click the **Ungroup Designs** tool. The group will be ungrouped into its elements.

Rotate Designs tool



The Rotate Designs tool rotates the selected designs.

1. Select the designs to rotate.
2. Click the **Rotate Designs** tool.
3. Click the line or axis to rotate the design around:

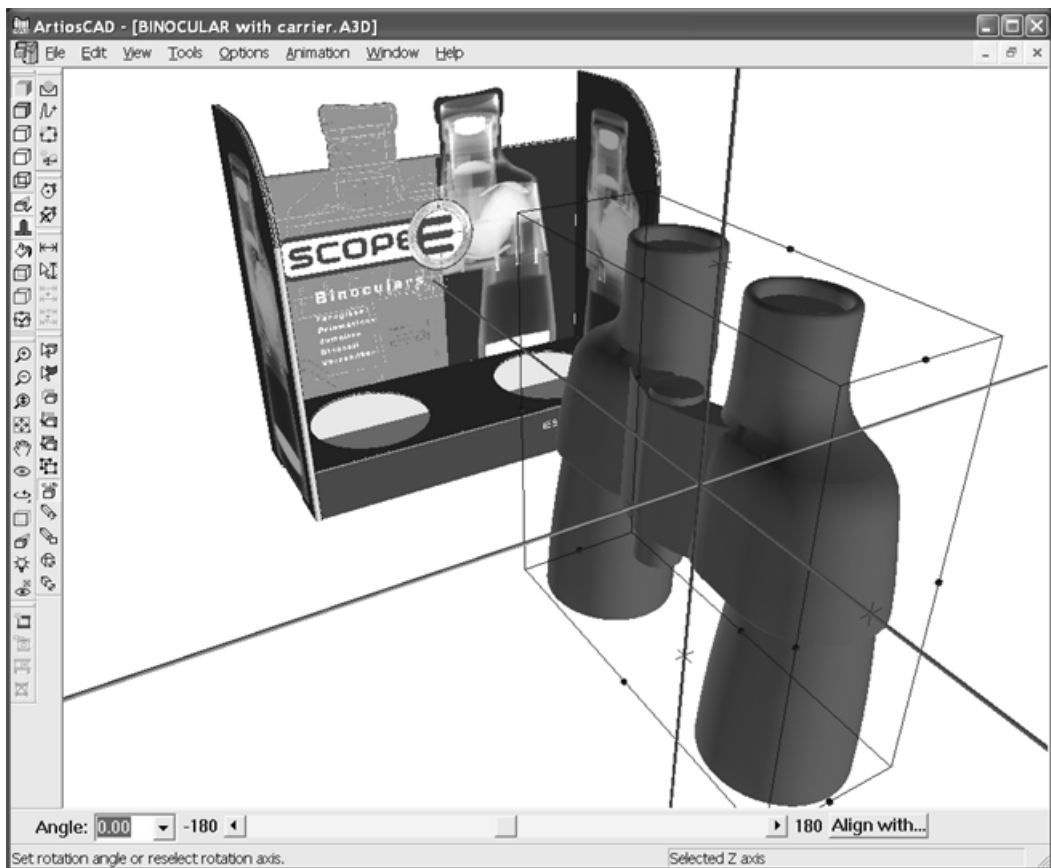

4. Select a rotation method:

- Enter an angle in the **Angle** field or select one from the drop-down list box;
- Use the slider to set the rotation angle;
- Double-click an axis to rotate by 90 degrees, or to the next increment of 90 degrees if you have used the slider;
- Click the **Align with** button. Select a line in the design(s) you are rotating, and then select either an axis or a line in another design to align with.

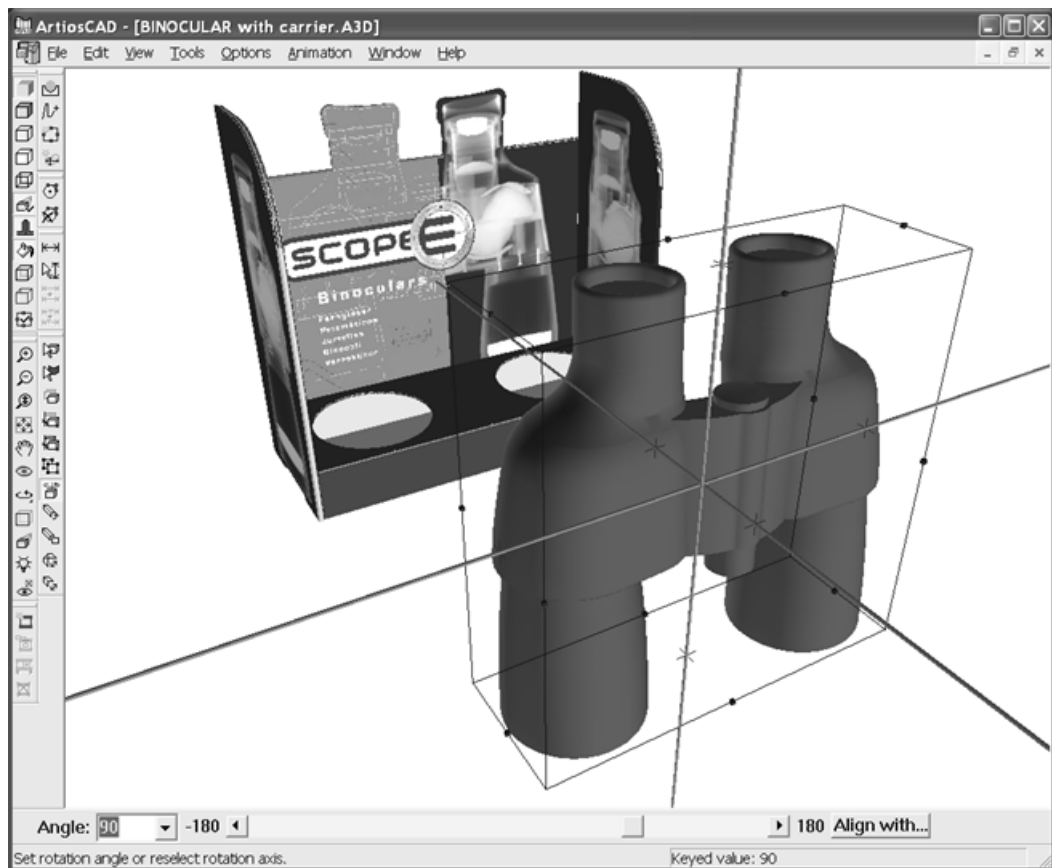



If you use Orthogonal view, the axis coming toward you is represented as a circle.



Drag on Plane tool

Drag on Plane lets you easily move an object onto a surface. Use it also to drag the current selection around the scene freehand.

1. Create or restore a 3D workspace containing the object(s) to move and the surface onto which to move it.
2.  Use **Select Design** to select the object(s) to move.
3.  Click **Drag on Plane**.

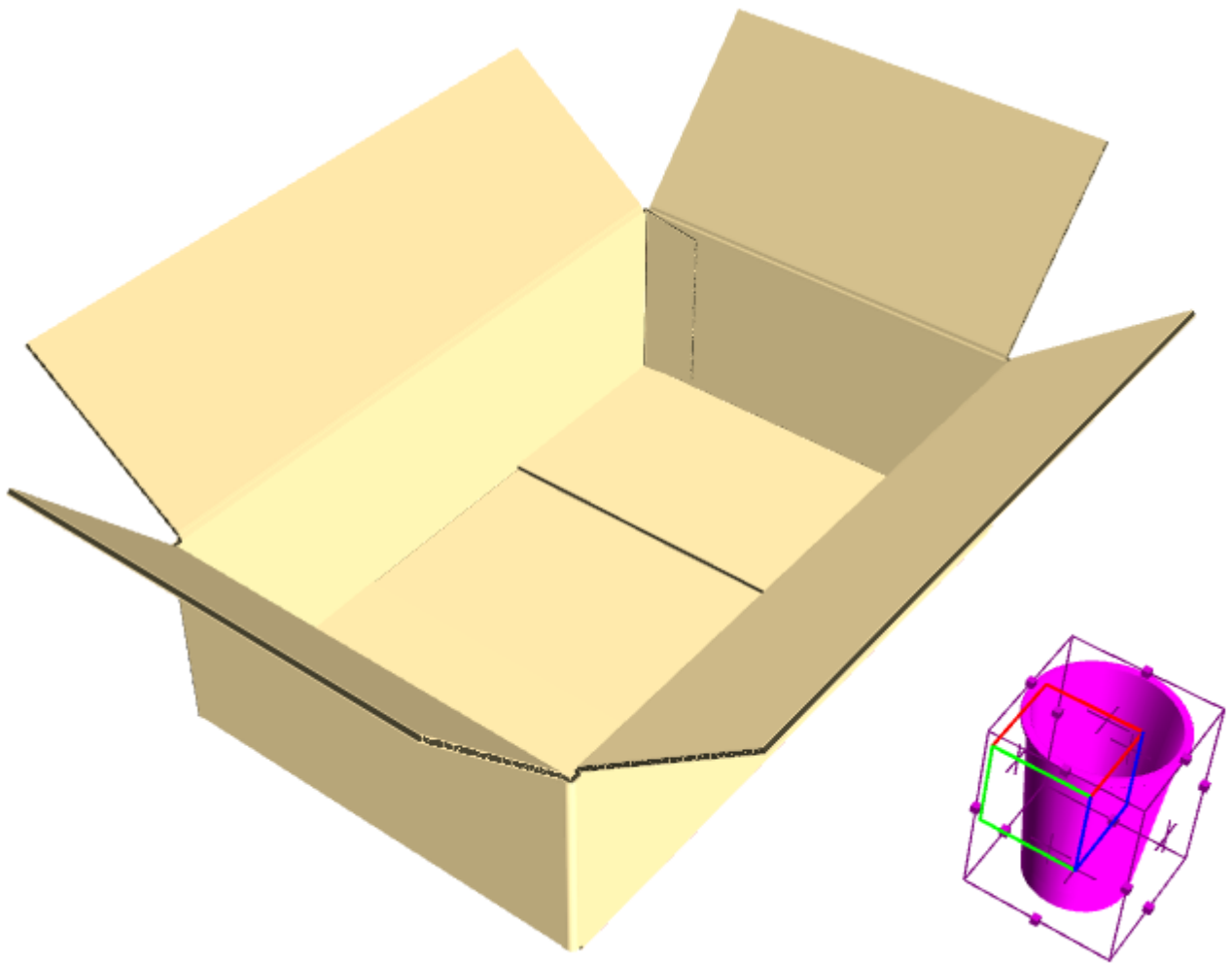

4. On the Status bar, check **Check collisions** if it is not already checked. If desired, check **Gutter** and enter a value to set a gutter between the surfaces that might collide with the object(s).



5. Click the surface onto which to move the selection. If **Check collisions** is checked, a green rectangle defines the area inside which you can move the selection. Note that the cursor is outside the box, yet the cup remains inside it.

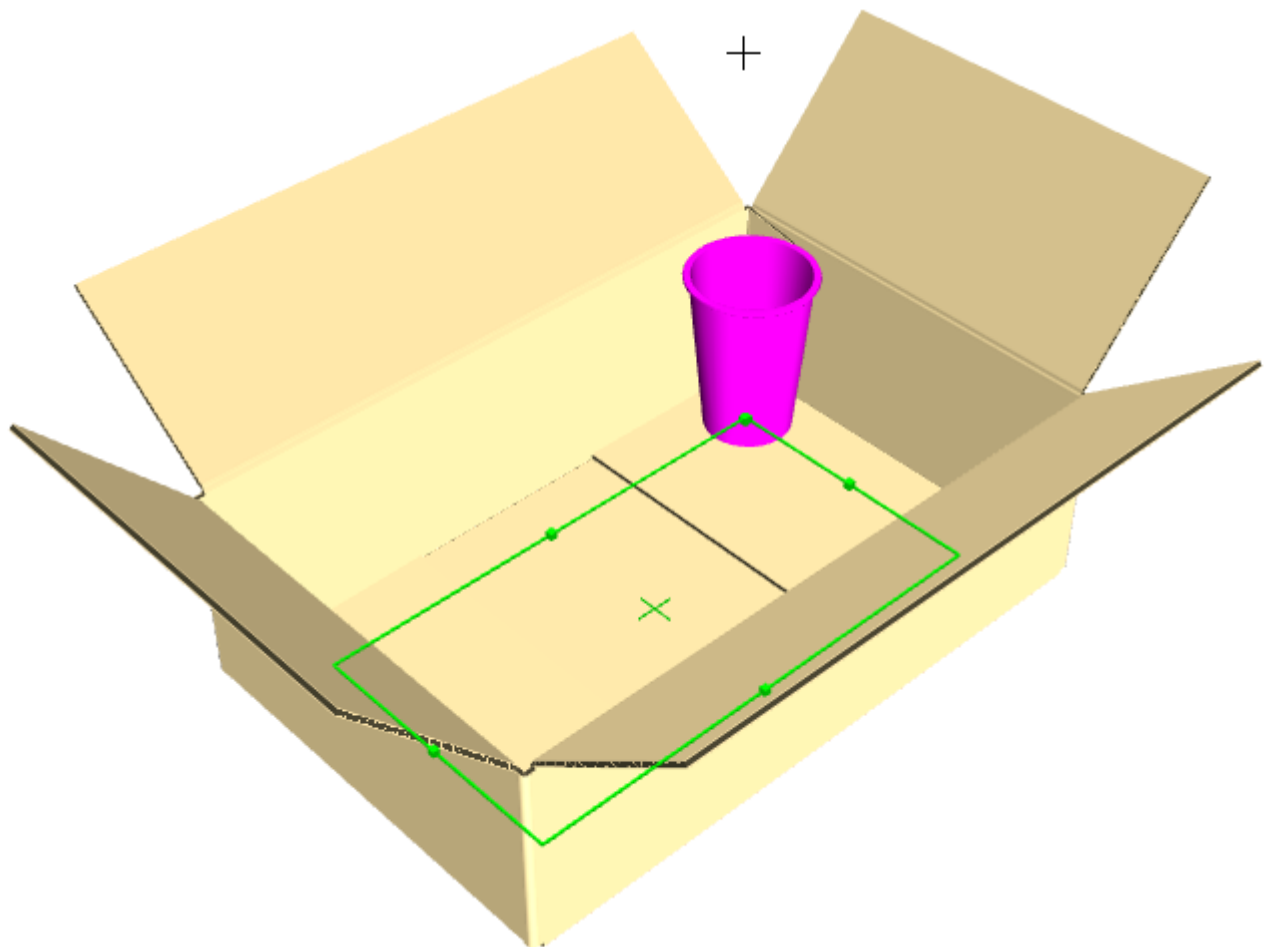

6. Click inside the green rectangle to set the put-down point of the selection. The selection remains selected so that you can easily do something else to it, like using **Array Copy**.

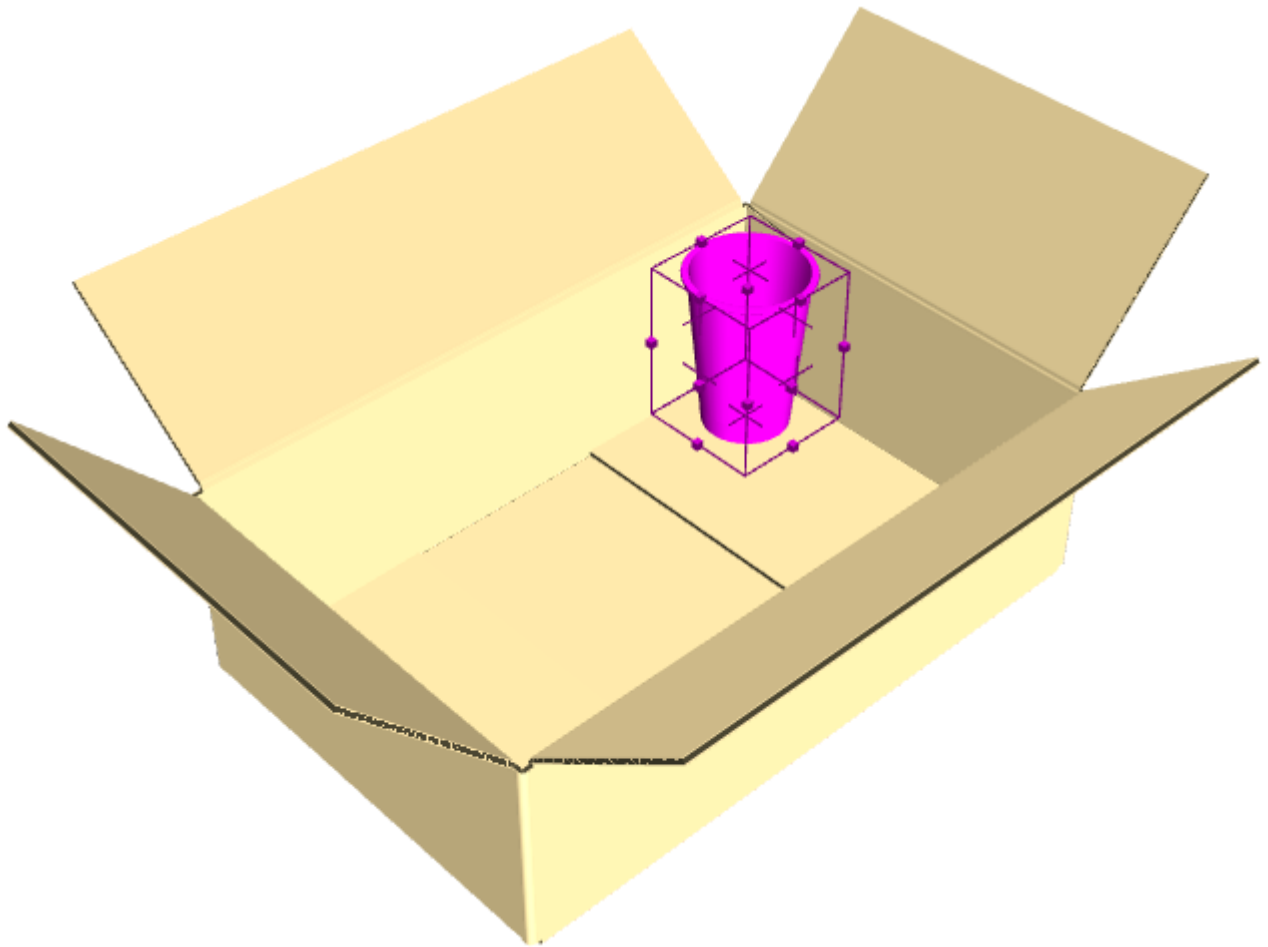

If you do not check **Check collisions**, you can drag anywhere in the plane of the surface after clicking it.

Check collisions impacts performance; use it before making many copies. Also, it is designed to work with flat sides and angled sides; curved sides may cause it to behave unpredictably.

The surface onto which you move the selection must be one piece. If you have trouble placing the selection, group the pieces of the surface together.

Array Copy Tool for Filling



Use **Array Copy** to copy the same design (or group of designs) multiple times in X, Y, and/or Z. It can also fill flat containers with objects. The example below took fewer than 10 clicks to make.



Before using **Array Copy** for filling, make sure the objects are aligned using the **Rotate Designs** tool **Align with** option. Also before using it for filling, group any different surfaces together (such as planks on a pallet top). If filling a box, if the flaps are closed within one caliper, the tool considers it a continuous surface. Lastly, the tool does not fill curved surfaces, only flat ones.

When you activate this tool, the Status bar appears as follows:

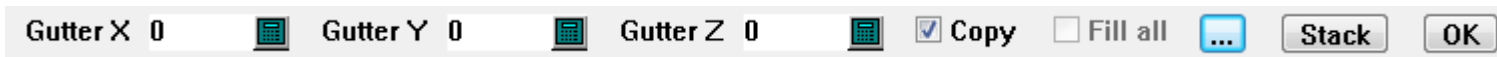

Enter any desired gutter in the Gutter fields. Clicking More Options (...) opens the Array Copy Properties dialog box.

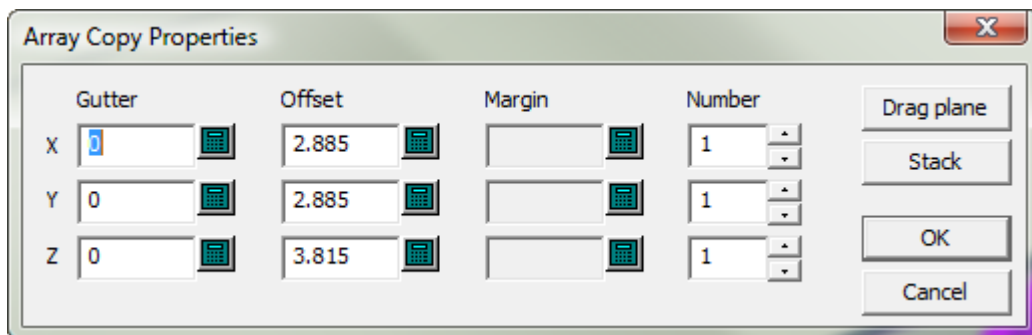



Any gutter you entered on the Status bar seeds the **Gutter** fields in this dialog box. Each **Offset** is the size of the bounding box for the object(s) you are copying. **Margin** lets you set a margin between the object(s) you are copying and the object you are filling. **Number** lets you set the number of copies and is limited to 100 to prevent inadvertently making too many

copies. **Drag plane** lets you immediately drag out the number of copies in X and Y in the design window without being constrained by the object you are filling. **Stack** lets you drag out the number of copies in the Z axis without being constrained by the object you are filling. Back on the Status bar, **Copy** makes a copy of the current selection that remains after the copy. **Fill all** is unavailable until you click in the tray, at which point if ArtiosCAD detects partitions, it becomes available.

Clicking **OK** on the Status bar finalizes the copy.

To use this tool for filling, do the following:

1. Create or restore a 3D workspace containing the object(s) to copy and an object to fill.
2.  Use the **Align With** mode of the **Rotate Designs** tool to align the object you are copying with the object you are filling.
3.  Use **Select Design** to select the object(s) to copy.

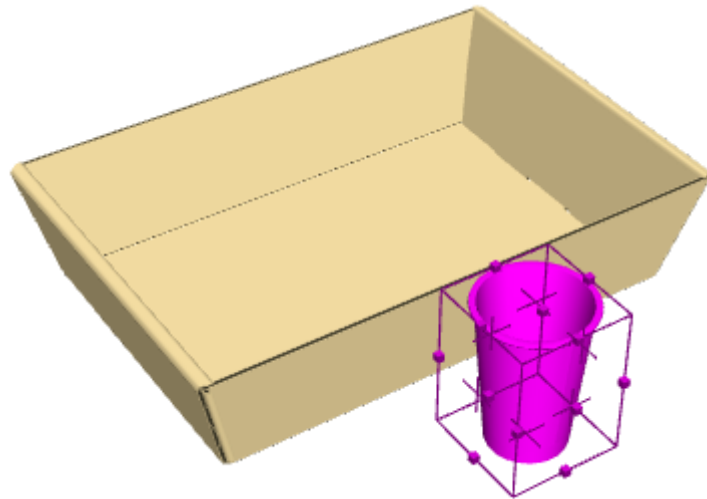

4.  Click **Array Copy**.
5. Click the surface to fill.



6. Click **OK** on the Status bar to finalize the copy.



Array Copy Tool for Filling Partitions

 **Array Copy** also works with partitions.

1.  Select the object to fill the tray and click **Array Copy**.

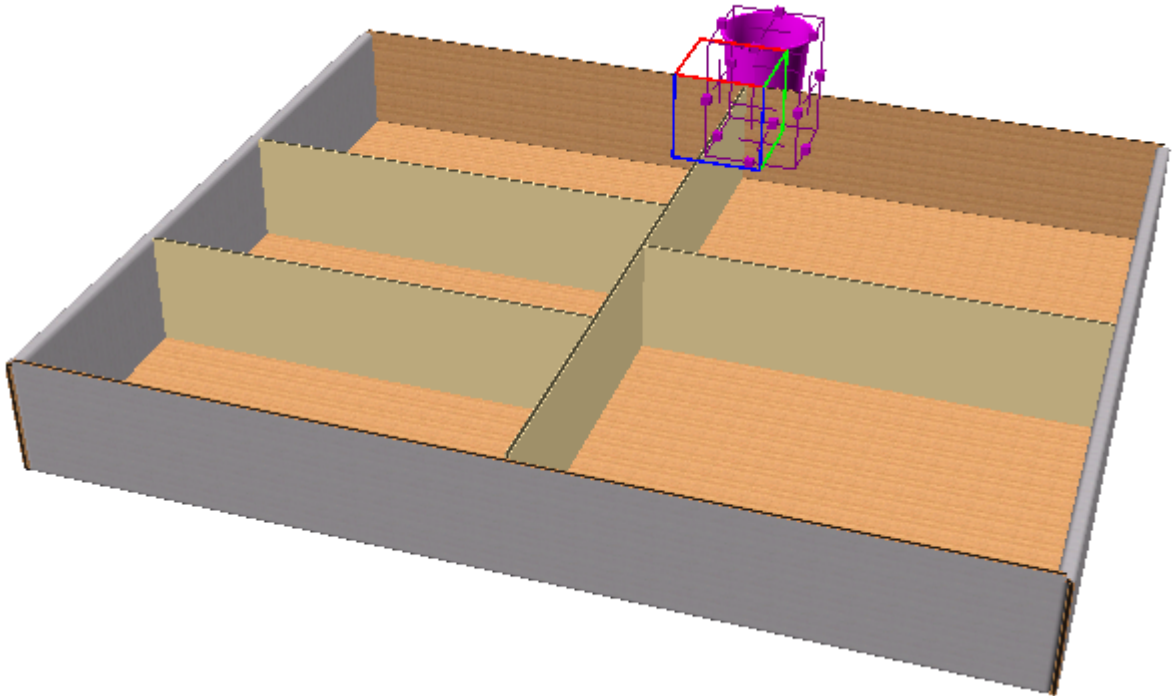

2. Click inside a partition in the tray. ArtiosCAD turns on **Fill All**, fills the partitions, and outlines the partitions in green.

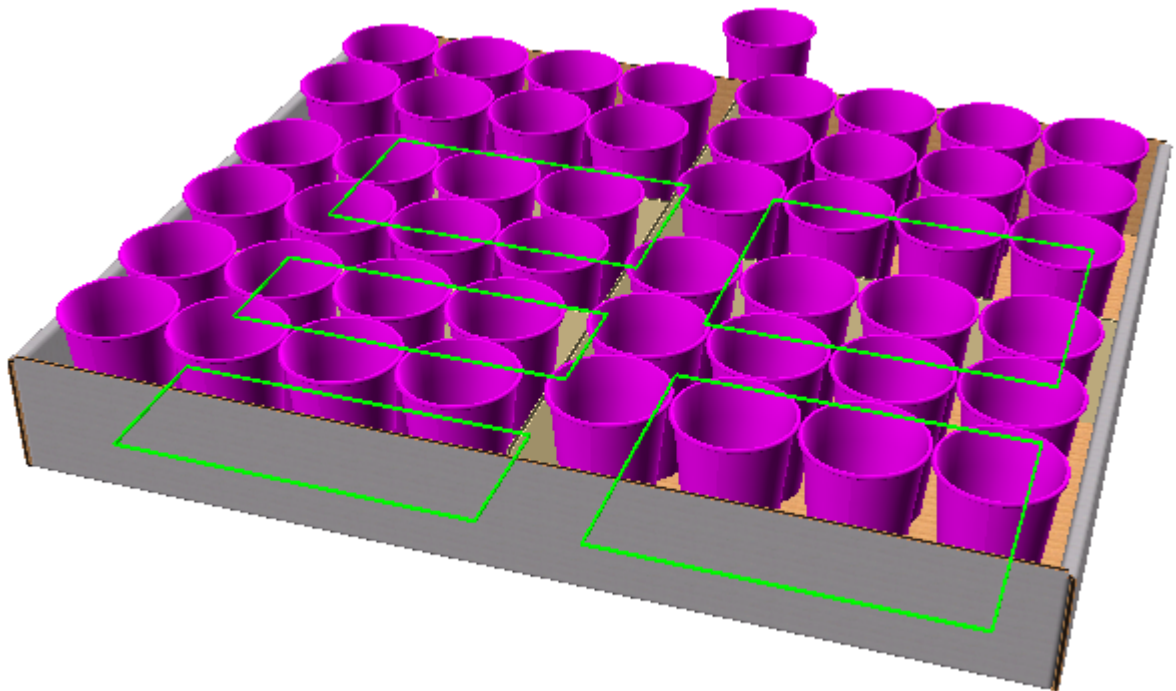

3. To only fill the partition you clicked in, deselect **Fill All**.

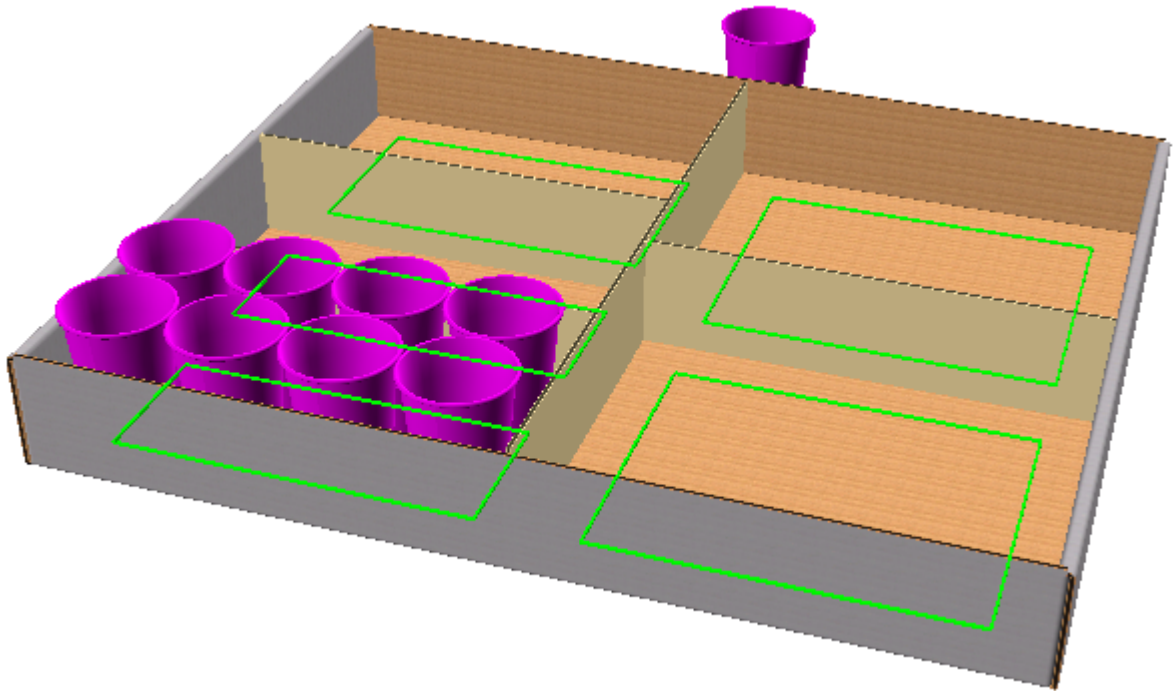

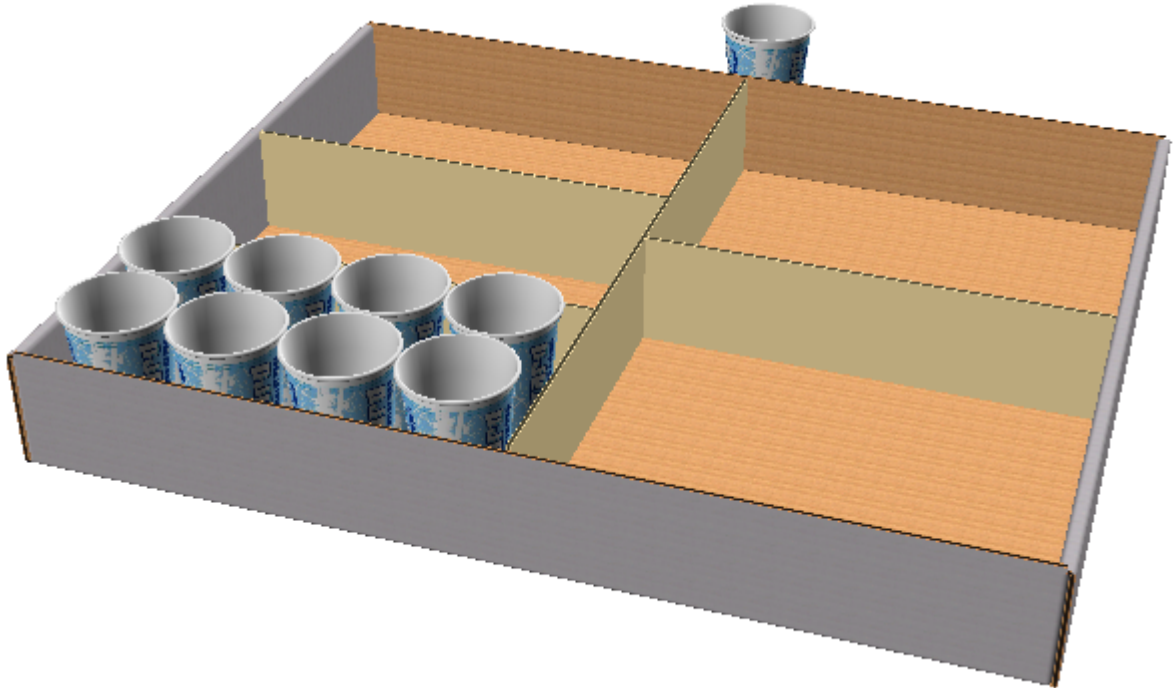

4. Click **OK** or click again inside the tray to finish. Note that since **Copy** was checked, the original cup remains.



5. Repeat as desired to fill other partitions individually.

Array Copy Tool for Stacking

To use the Array Copy tool for stacking, do the following:

1. Create or restore a 3D workspace containing the object(s) to copy.
2.  Use **Zoom out** to make room for the drag you will use with this tool.
3.  Use **Select Design** to select the object(s) to copy.
4.  Click **Array Copy**.
5. Click inside the red top of the cube to copy horizontally.

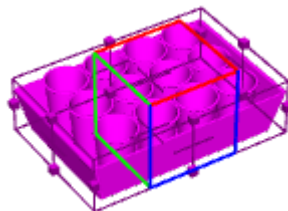

6. Drag the desired number of copies in X and Y and click to set the number. The drag is limited to 20 copies in each direction; to make more, click **More Options** and set the number of copies in the Array Copy Properties dialog box.

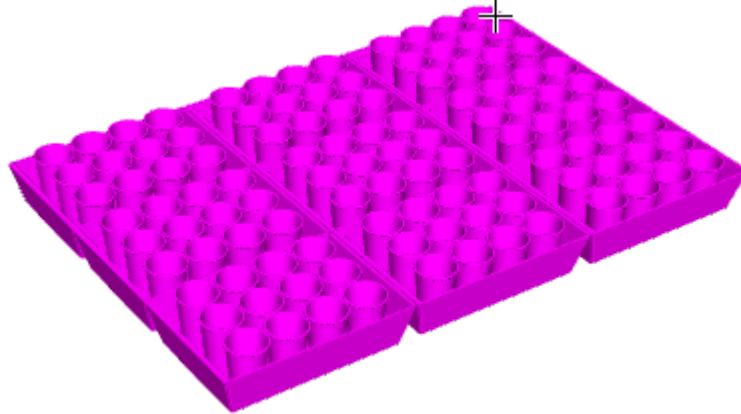

7. Click **Stack** on the Status bar and drag the height of the stack.

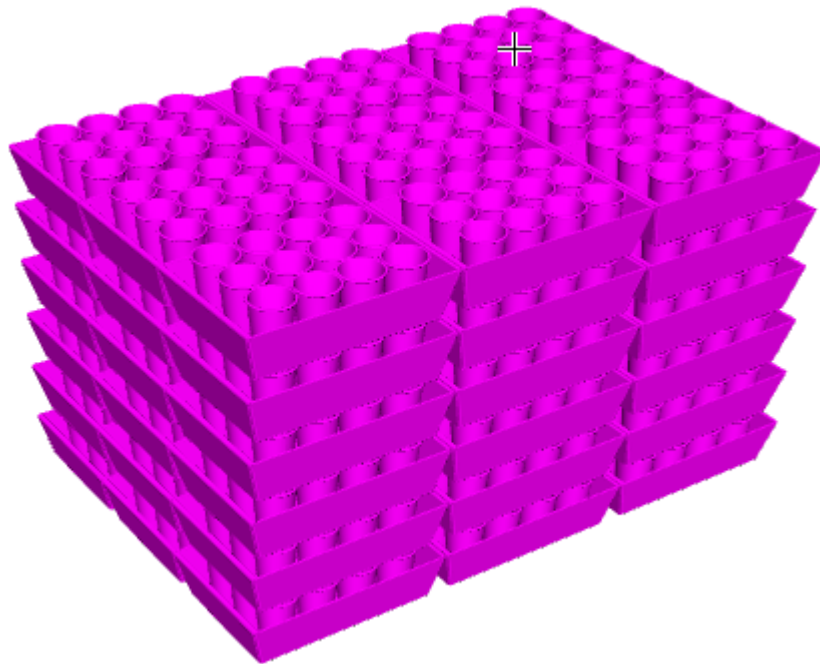

8. Click **OK** on the Status bar to finalize the copies.

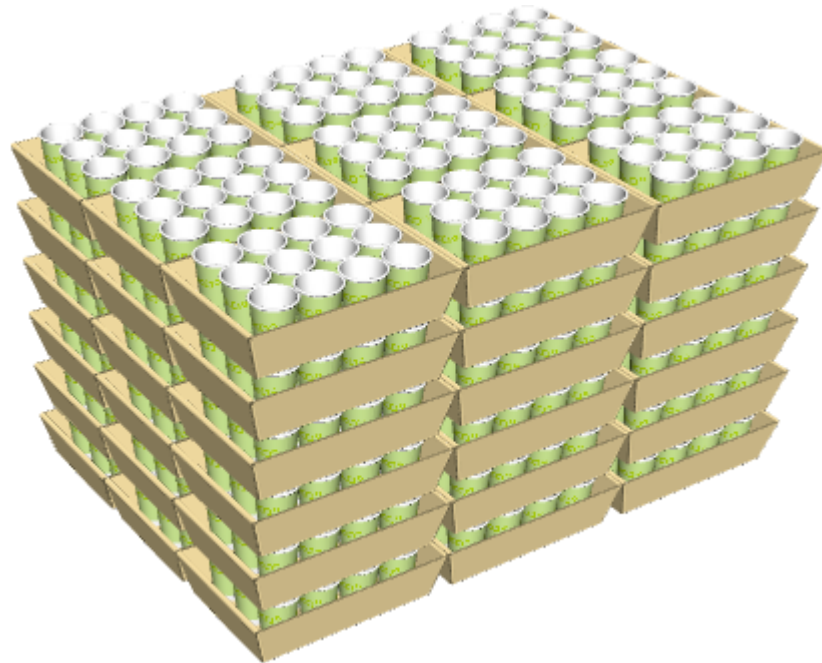

Folding designs

Use the tools in this section to fold a design in 3D.

Fold Angle tool



The **Fold Angle** tool allows you to fold designs along selected creases (or other line types).

1. Click the **Fold Angle** button.
2. Select the crease, bend, perf, cut & crease, reverse crease, 50% cut, or hidden crease lines to fold. If you want to select more than one line at a time, hold down **SHIFT** as you select lines, or hold down **CTRL** and make a window selection.
3. Now select one of three methods to specify the fold angle:
 - Enter an angle in the **Angle** field, or select a predefined angle from the list box.
 - Drag the slider to set the angle. The view updates as you drag the slider; performance is directly related to the capabilities of the display adapter.
 - Click **Same As** and indicate a crease that already is folded at the desired angle.

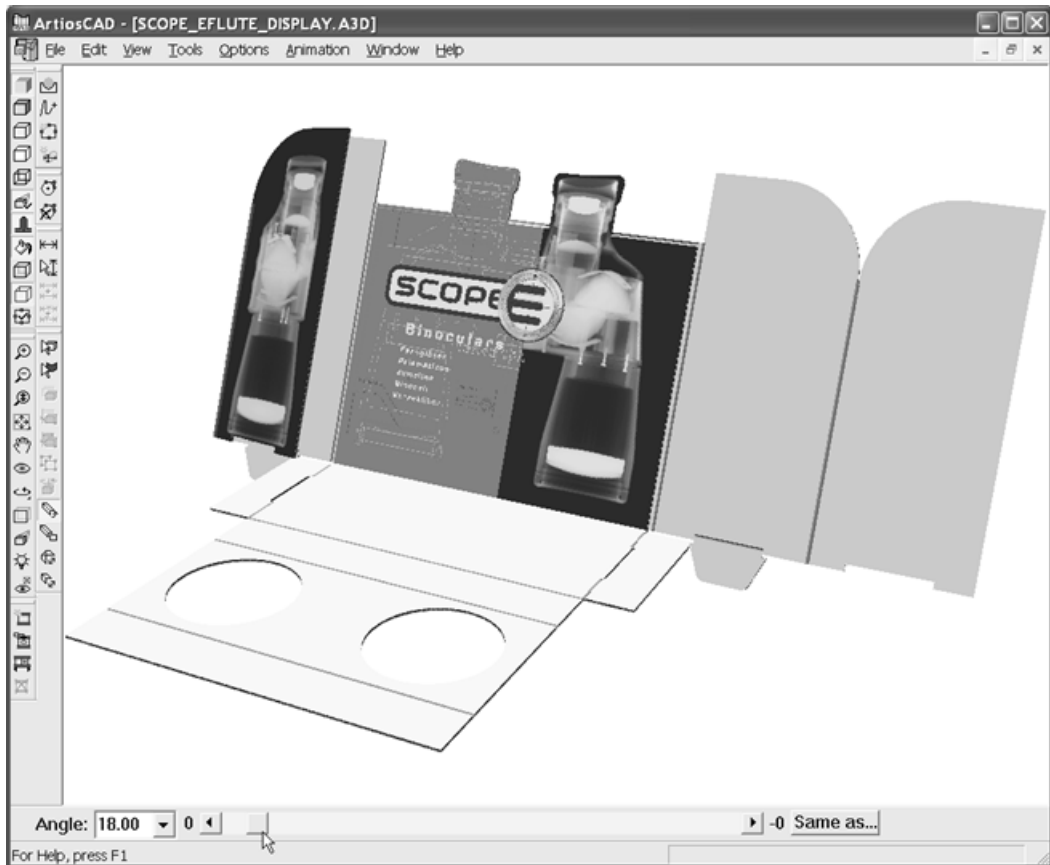

You may need to click **Scale to Fit** to reset the view of the design.

Fold All tool



The Fold All tool folds all creases (or other foldable lines except bends) in a design at once.

1. Click the **Fold All** button.
2. Select one foldable line in the design you wish to fold. All the foldable lines that are not bends will turn magenta to indicate they are selected. To select additional designs, hold down the SHIFT key and select the desired designs.
3. Select one of three methods to specify the fold angle:
 - Enter an angle in the Angle field, or select a predefined angle from the list box next to the Angle field.
 - Drag the slider to set the angle. You will see an outline of what is being folded.
 - Click the **Same As** button next to the slider and indicate a line that already is folded at the desired angle.

Shown below is a flat design.

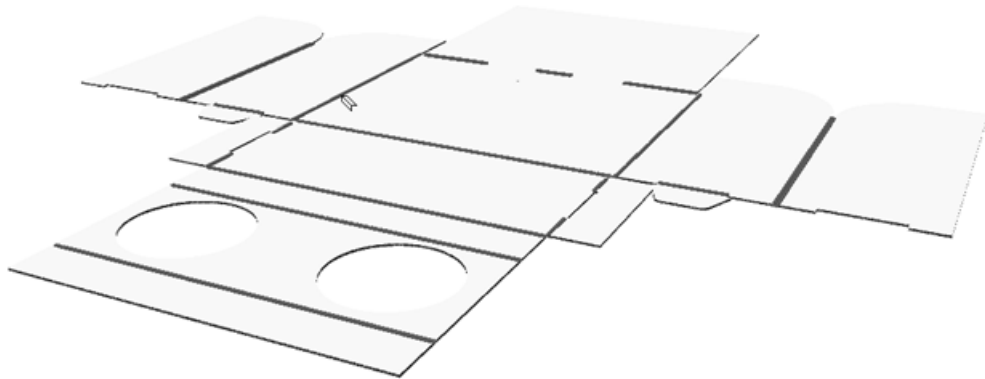

Next is moving the slider to adjust all the fold angles.

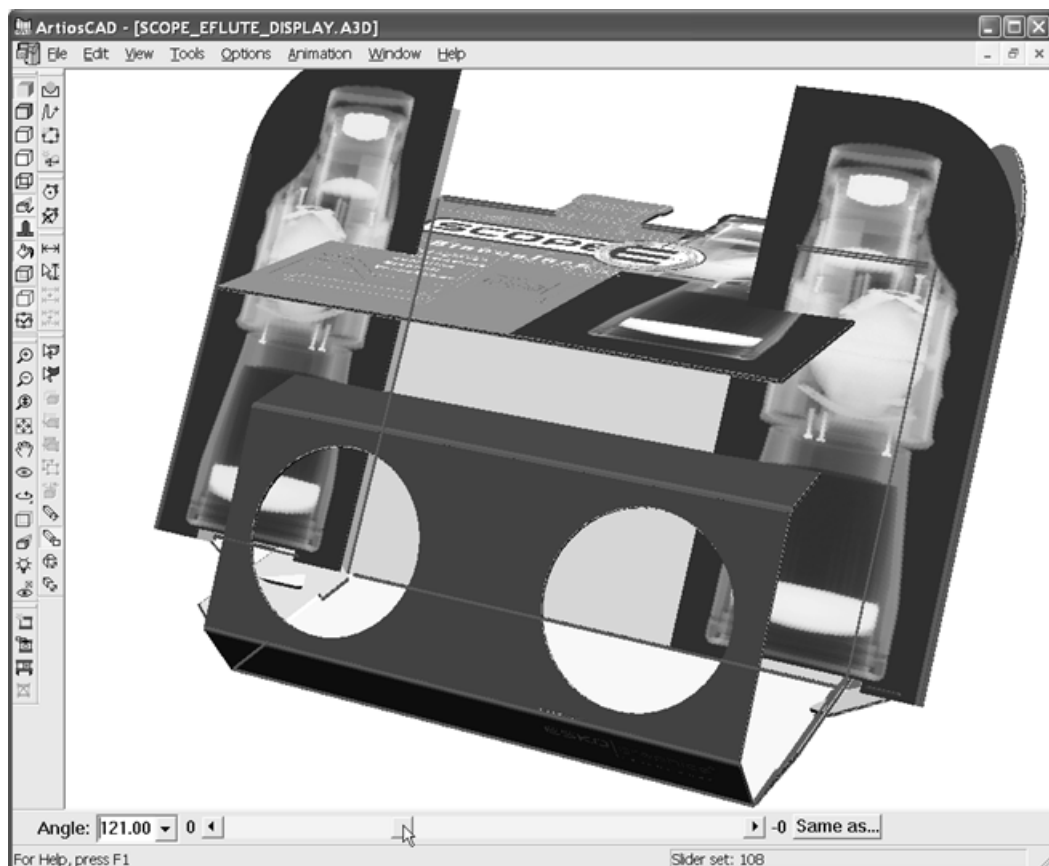



Finally, all creases are folded at 90 degrees.



You may need to click **Scale to Fit** to reset the view of the design.

Fold 1 to Meet tool

 The **Fold 1 to Meet** tool allows you to change angles of folds to make two lines meet. This feature is used for designs that do not fold at 90 degrees, such as trapezoids.

1. Decide which line to move that will meet another.
2.  Click **Fold 1 to Meet**.
3. Click the line that will meet the second line.
4. Click the foldable line whose angle will change so that the lines will meet (the front crease below).
5. Click the line that the first line will meet.

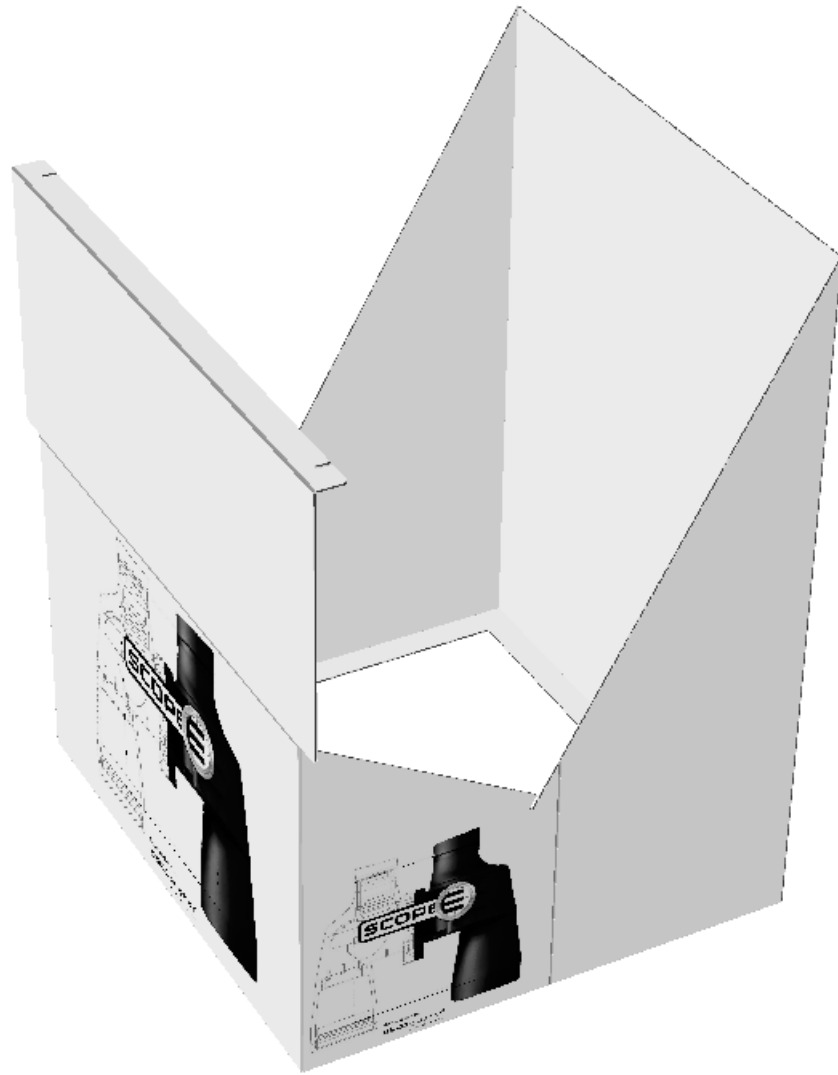

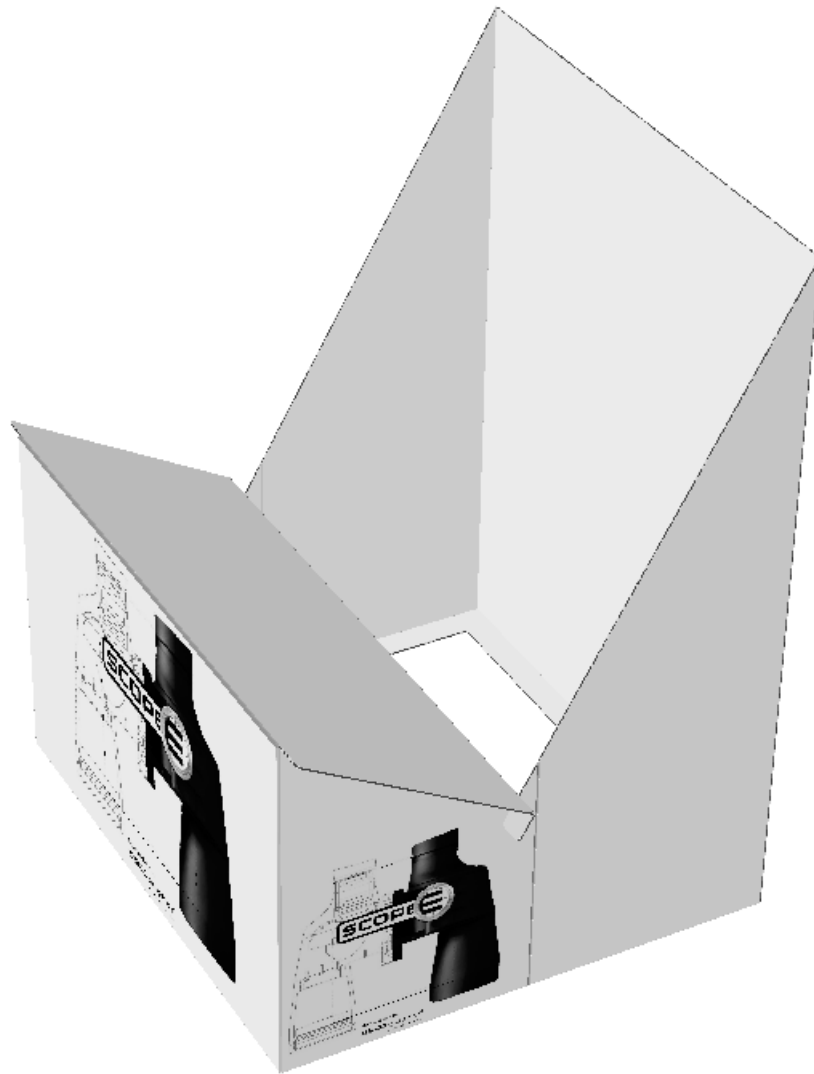

Shown below is the display after using the tool.



You may need to click **Scale to Fit** to reset the view of the design.

Fold 2 to Meet tool

 The **Fold 2 to Meet** tool works the same way as Fold 1 to Meet, except that it changes two foldable lines at once.

1. Decide which lines should meet after folding.
2.  Click the Fold 2 to Meet tool.
3. Click the first line that will move.
4. Click the foldable line whose angle will change in order to move the first line.
5. Click the foldable line whose angle will change in order to move the second line.
6. Click the second line that will move.

You may need to click **Scale to Fit** to reset the view of the design.

Flap Priority tool





Flap Priority lets you shuffle flaps on a closed box to let ArtiosCAD know which flap is visible on top. It does this by stretching the flap's crease by half a caliper. ArtiosCAD removes the stretch when you change the fold angle.

To use this tool, do the following:

1. Create or restore a 3D workspace.

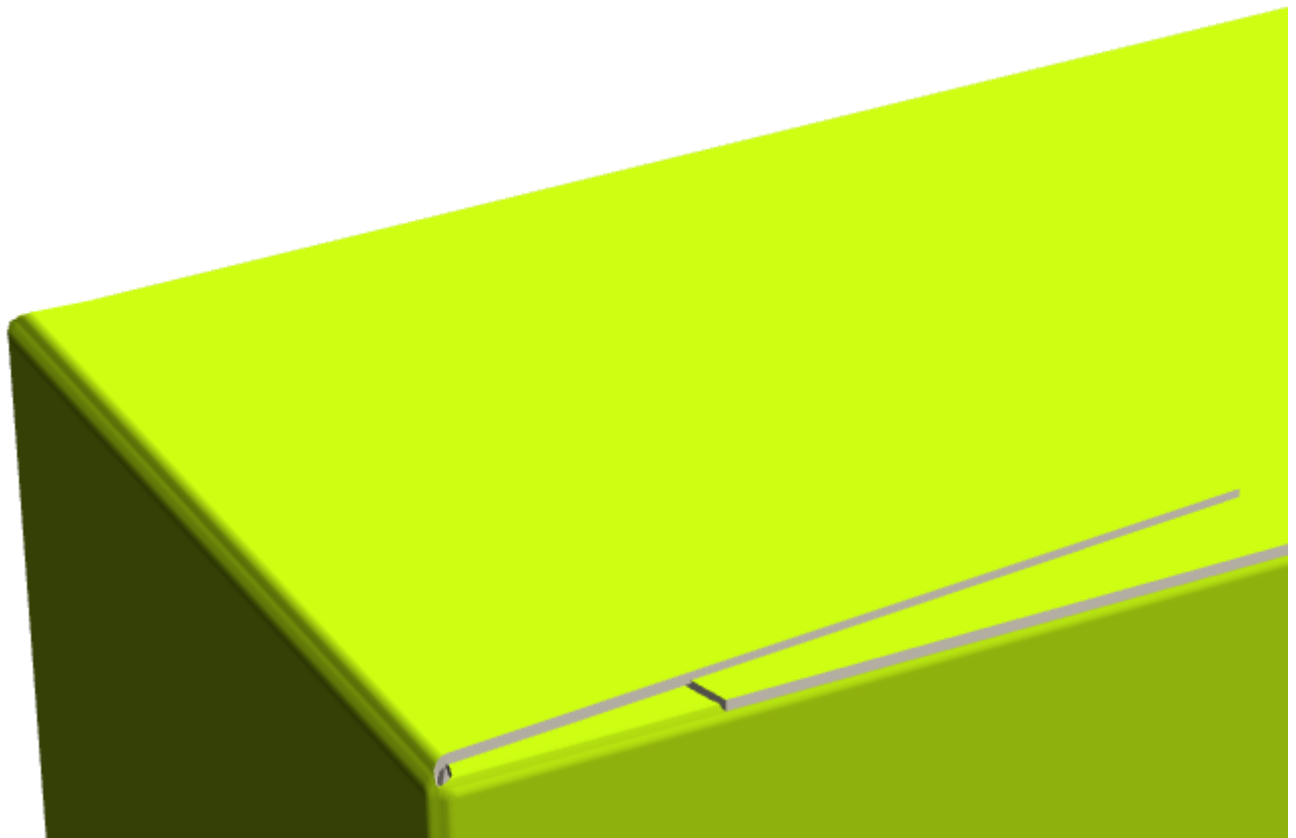
2.  Use one of the **Fold** tools to close the design. The flaps may not be in the correct order.

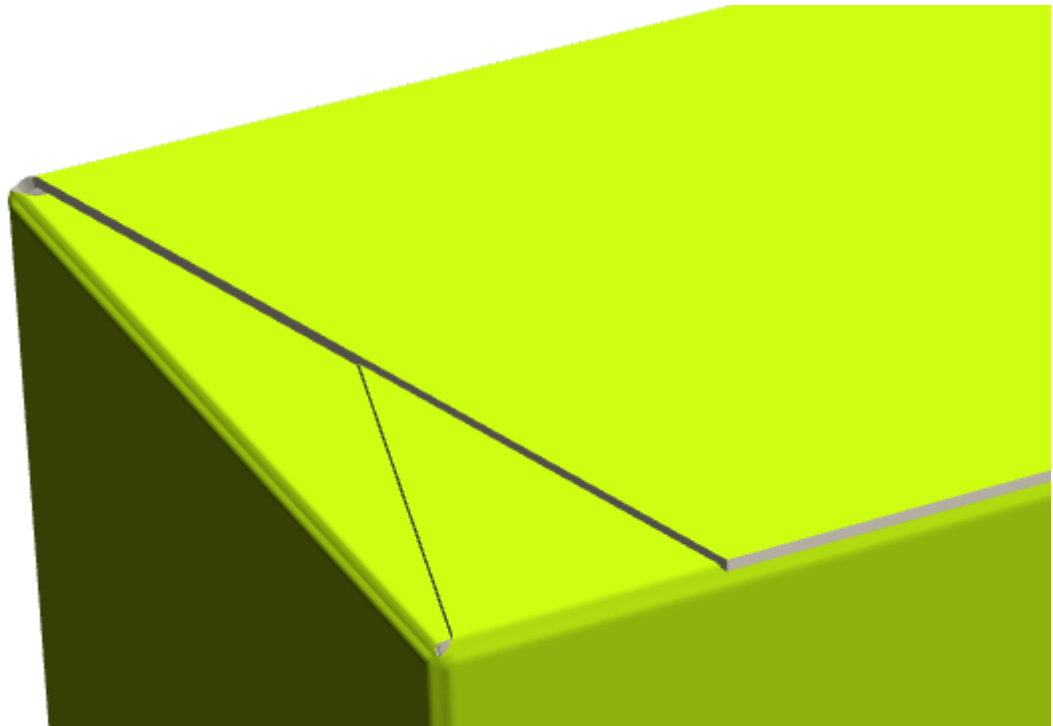

3.  Click **Flap Priority** on a flap to move it to the top. Repeat as desired.

**Note:**

If you will be using this design with Plato, make sure to set the default in the single design parameter set for the Bleed/Coating Offsets so that **Use 3D flap overlap** is checked. This ensures that Plato gets the correct information.

Folding designs with curved creases

ArtiosCAD can fold designs with reasonable curved creases using patented (U. S. patent #8830223) technology.



Linked folds

ArtiosCAD recognizes different types of folds as being connected in that you cannot fold one crease without the other creases folding at the same time.

In the examples below, the arcs meet or almost meet and have a similar radius. Both will fold at the same angle.

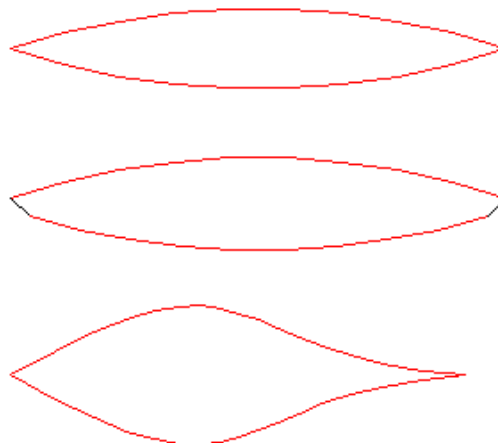

In the examples below, there are pairs of arcs in-line with straight lines. The angles of the arcs follow the angle of the straight fold.

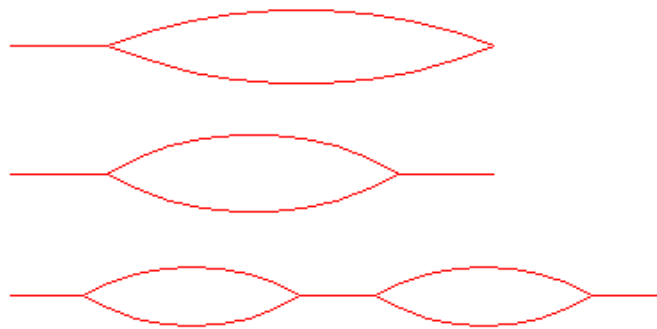

In the example below, the creases are parallel between two faces and fold together.

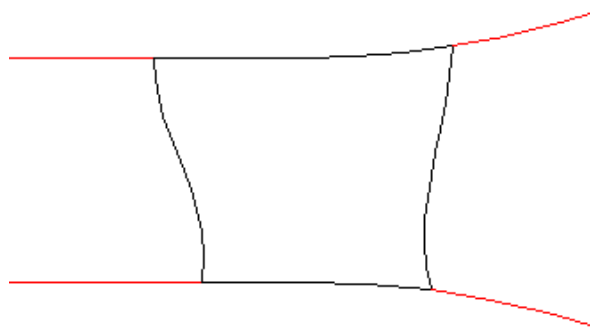

In the example below, the parallel folds between the same two faces are treated as one fold.

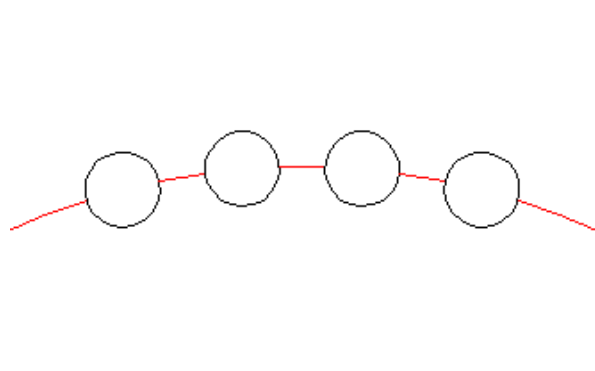

Curved perf behavior in 3D

ArtiosCAD tries to tell the difference between perfs that fold and perfs that tear, but as there is no property to identify this behavior, it has to guess. The figure below shows how ArtiosCAD may behave in some situations.

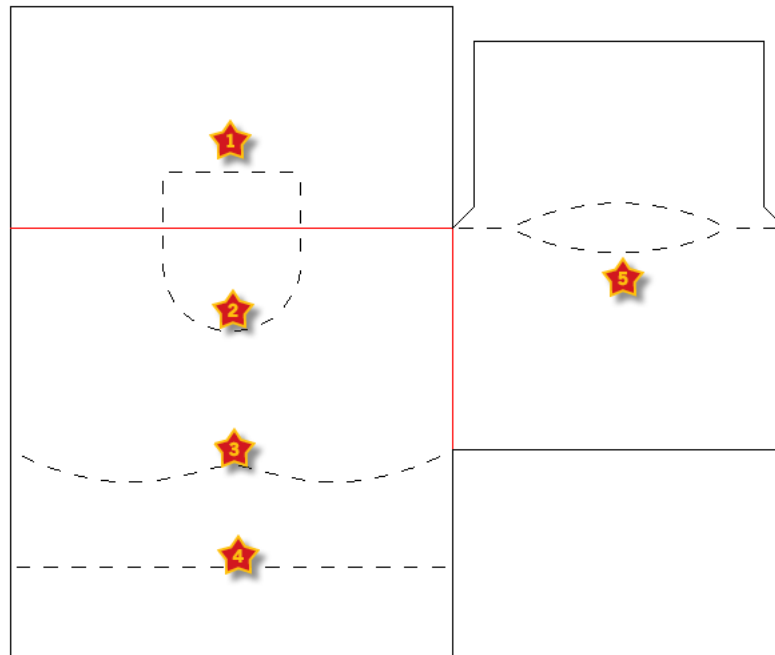

Number	Result
1	Perf with sharp angles treated as separate lines. One of the perf folds; the others are broken.
2	The arc has too large an angle to fold so it is treated as a cut.
3	Smooth curved perf that folds properly.
4	Straight perf that folds properly.
5	Diamond fold made from perf lines that folds properly.

Unsupported 3D designs and workarounds

Designs with curved creases that do not convert to 3D usually rely on features that are not supported, such as:

- Folds in a place where there is no crease, such as across the face of a panel
- Relies on twist as an essential part of construction.
- Has an arc angle of more than 110 degrees. If the fold angle is bigger than this, the distortion is too great and the fold is ignored.

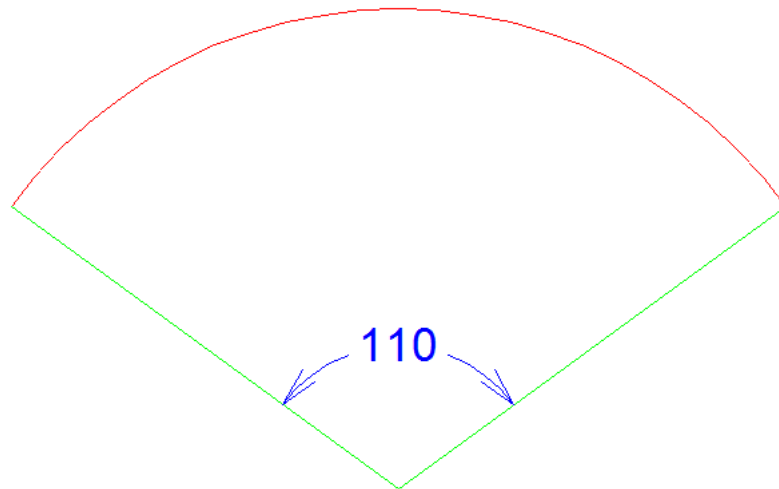

Sometimes these restrictions can be overcome by:

- Adding a crease or a bend line where there isn't one presently
- Breaking creases automatically when there are more than five connected creases
- Adding bend lines to simulate a twist.

Examples of supported curved crease designs

Shown below are unfolded and folded examples of supported types of curved crease designs. Graphics are turned off to emphasize the structure of the designs.

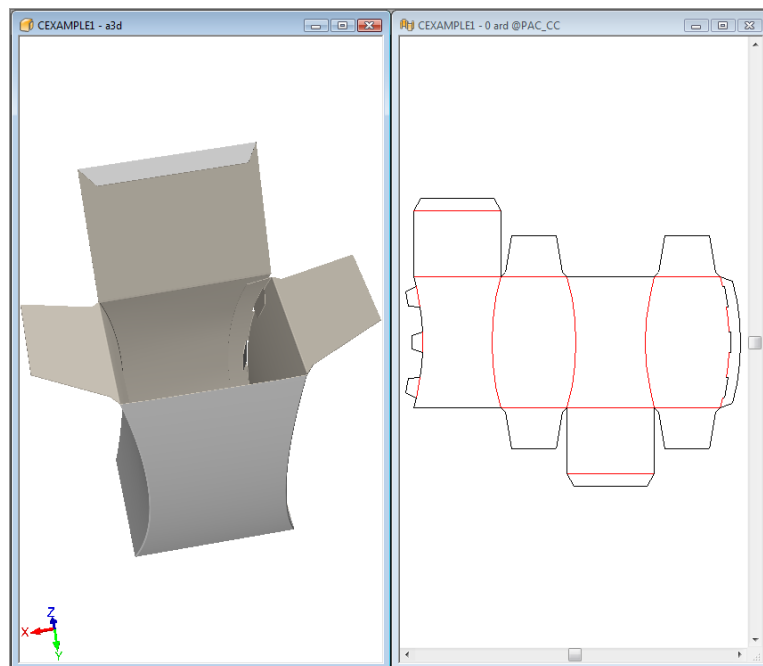

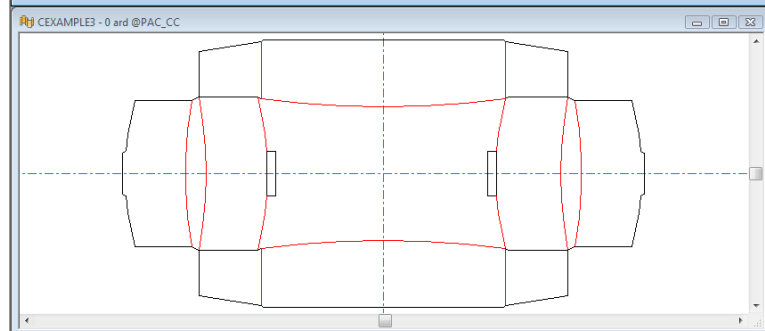
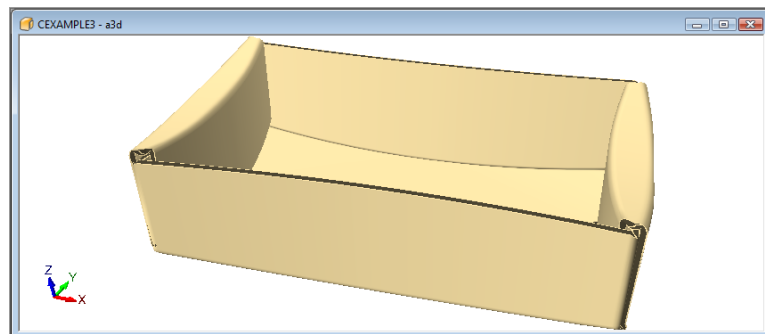
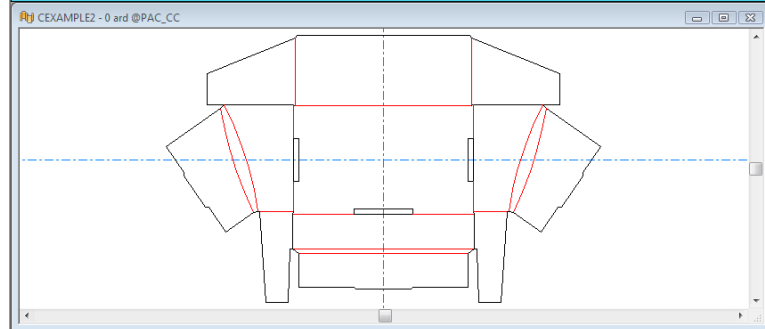
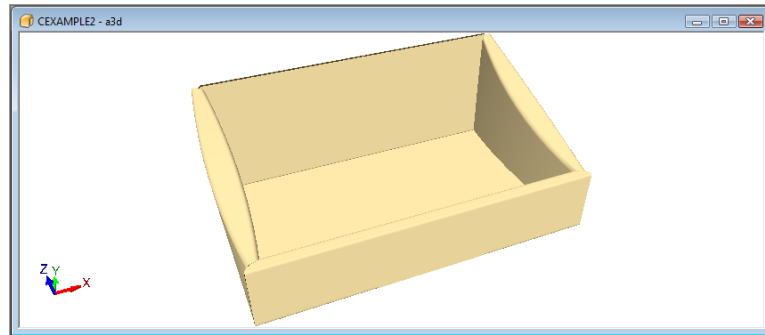

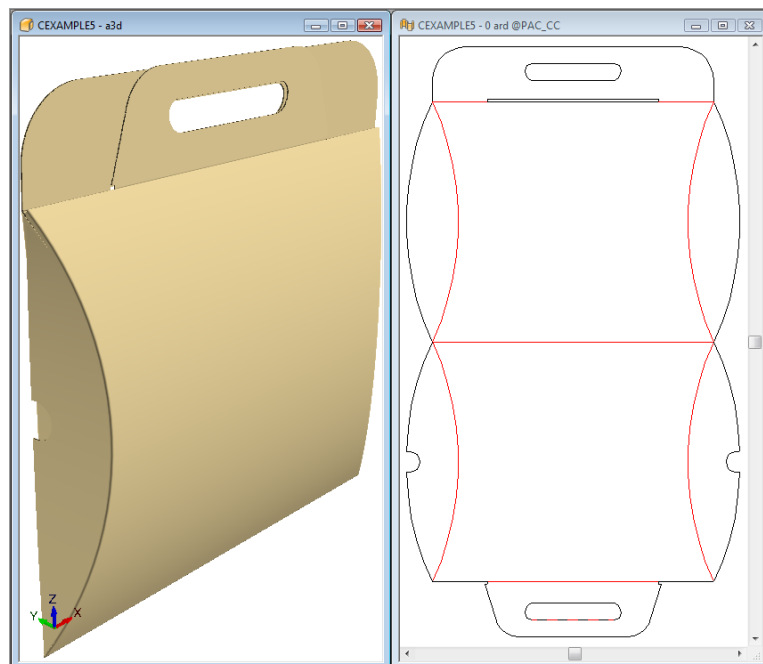
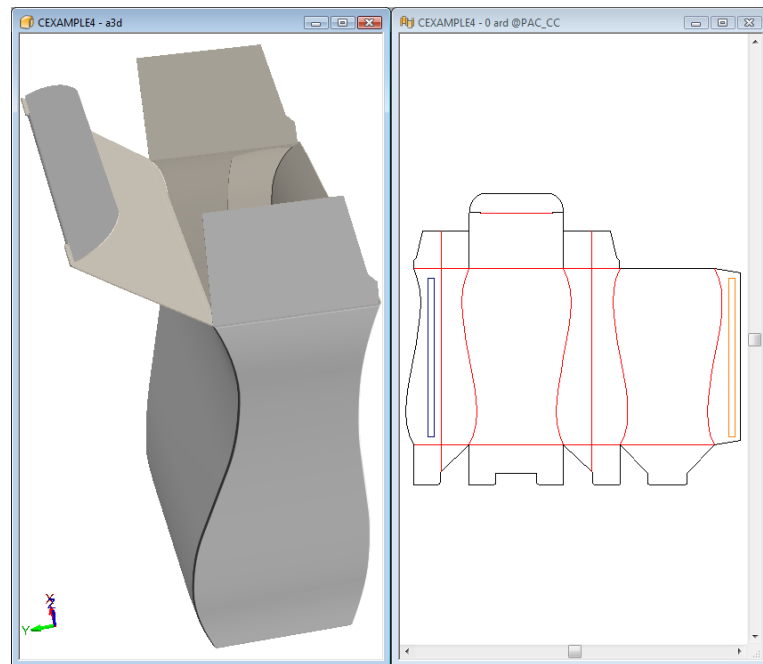

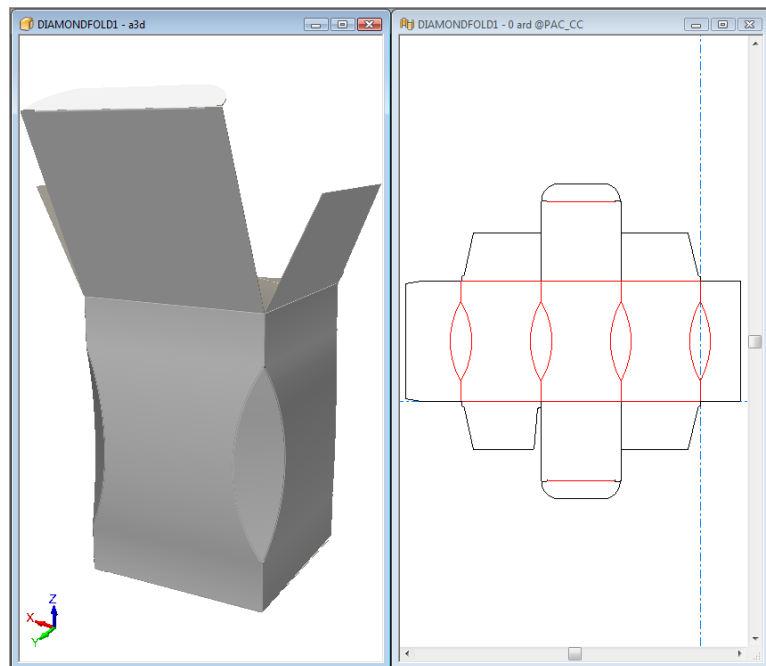
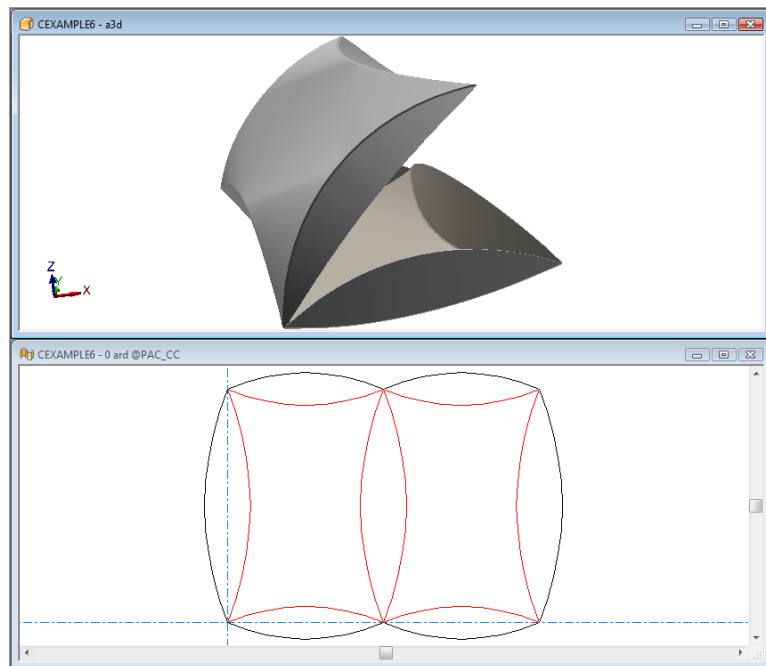

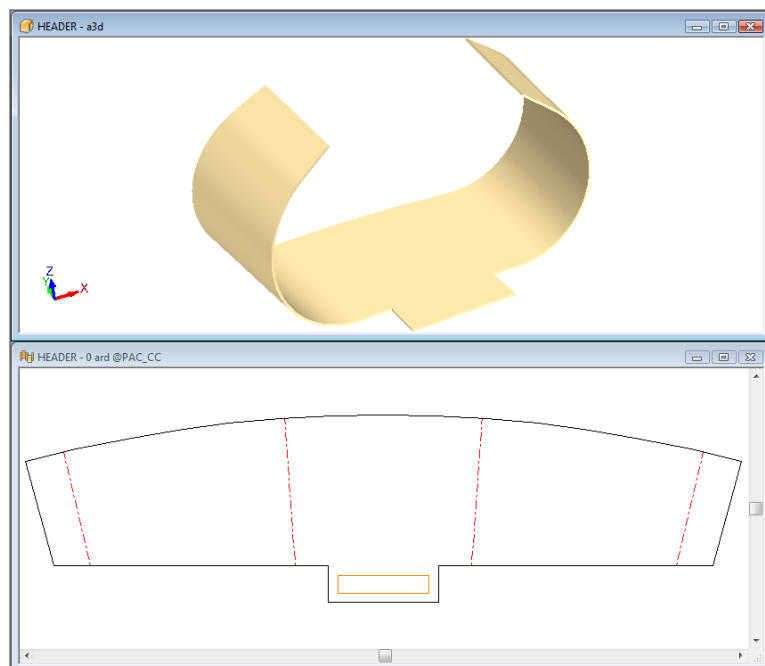
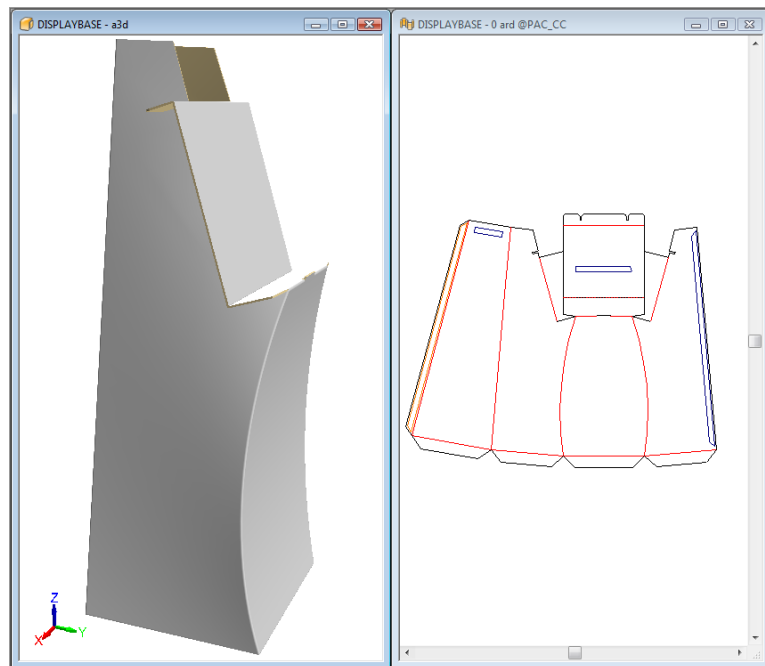

Folding designs with V-notch lines for Re-board®

ArtiosCAD accurately displays V-notch lines with angles from 5 to 60 degrees in 3D.

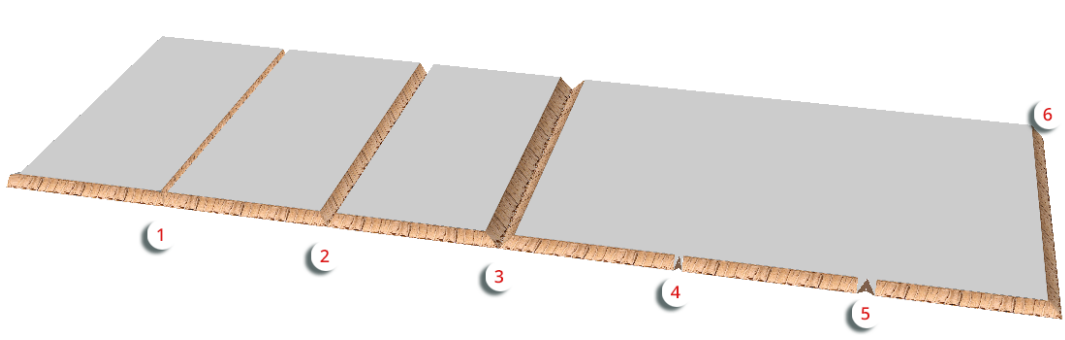

Line	Type
1	15 degree V-notch crease
2	30 degree V-notch crease
3	45 degree V-notch crease
4	15 degree reverse V-notch crease
5	30 degree reverse V-notch crease
6	45 degree V-notch cut

When folded, the above example looks like this:

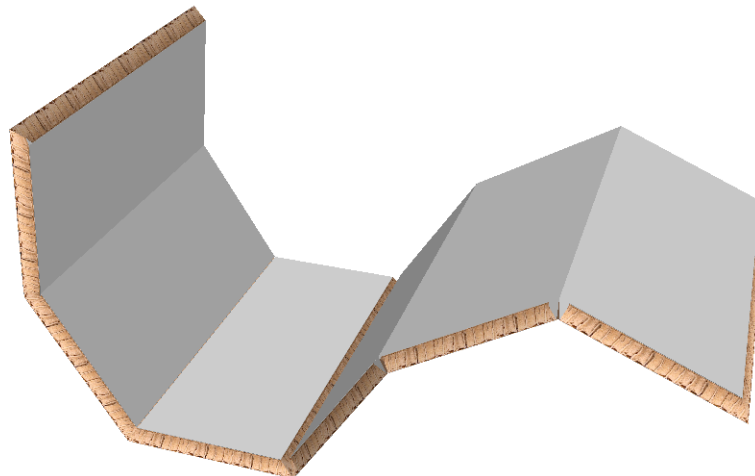

Note:

ArtiosCAD ignores the inside loss of the board when folding V-notch creases and partial cuts.

Partial cuts for Re-board®

When using Re-board®, a partial cut or reverse partial cut across a panel folds in the same way as a partial cut folds when using corrugated or foam. A partially cut hole is formed when the partial cut lines form a loop. The examples below show how partial cuts look.

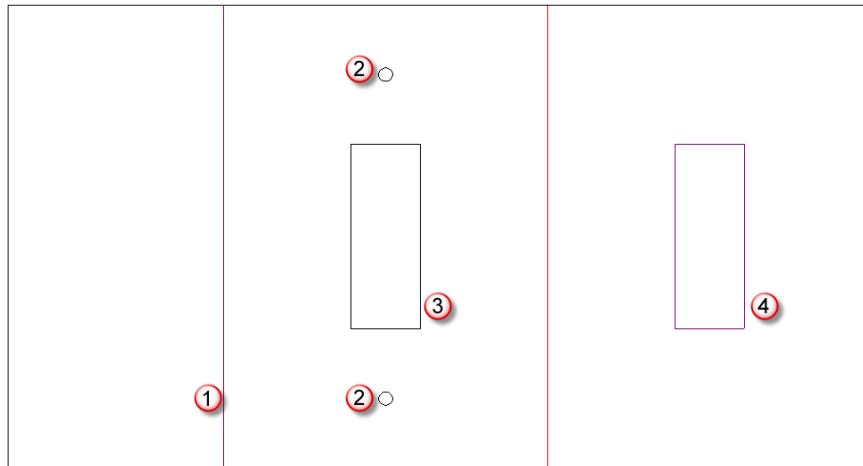

Line	Type
1	Partial cut
2	Drill hole
3	Full-depth hole made with cut lines
4	Partial-depth hole made with partial cut lines

The flat design looks like this in 3D:

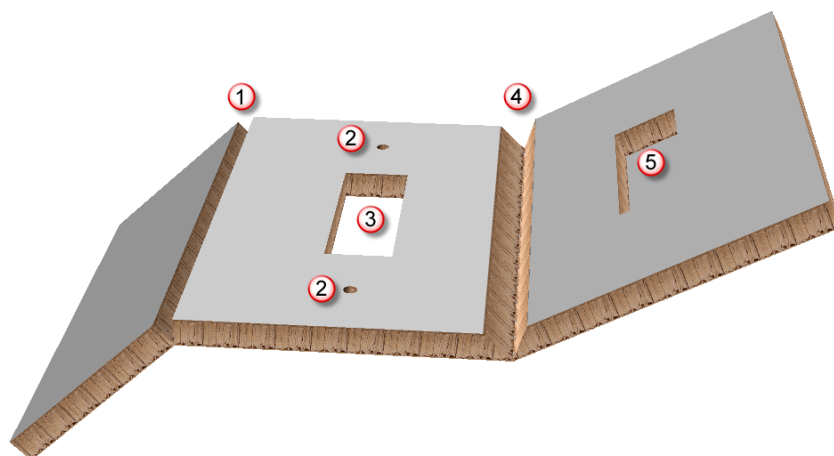

Object	Construction
1	Partial cut
2	Drill holes
3	Full cut hole
4	V-notch cut
5	Partial-depth hole

Folding Re-board® designs using the Snap Tab/Slot tool

 Designs made with Re-board® typically use slots and tabs for assembly. The **Snap Tab/Slot** tool eases this assembly in 3D.

Consider the five-piece single design below. Tab 1 fits into slot 2, tab 3 fits into slot 4, slot 5 fits into slot 6, and so on.

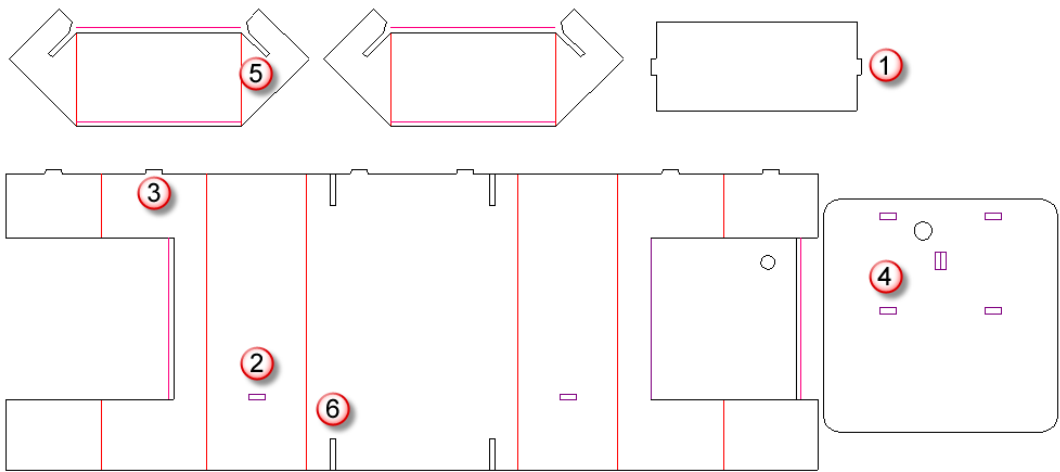

One way to assemble this design is as follows:

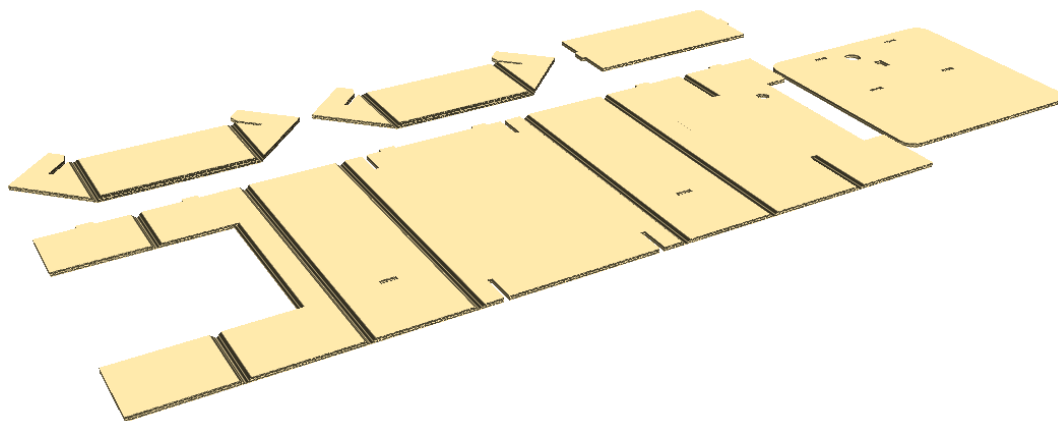

1.  Convert the design to 3D.



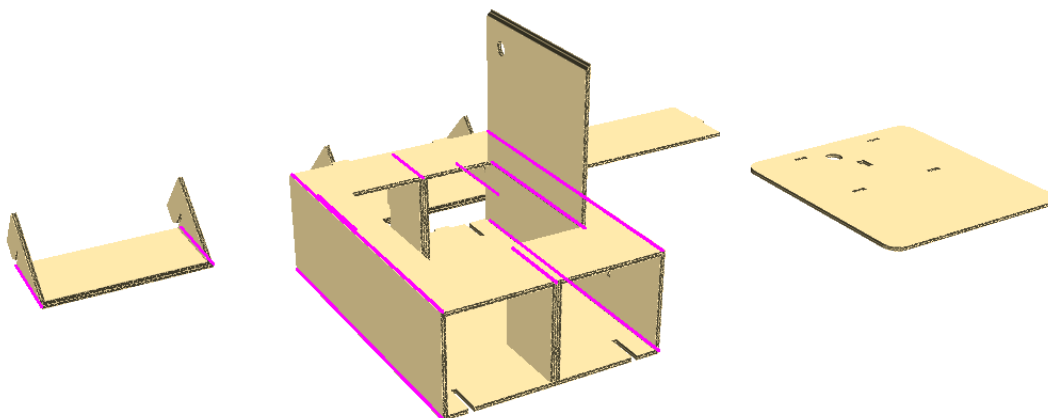

2.  Click **Fold All**, select all the V-notch creases with a marquee selection, and set the fold angle to 90 degrees.

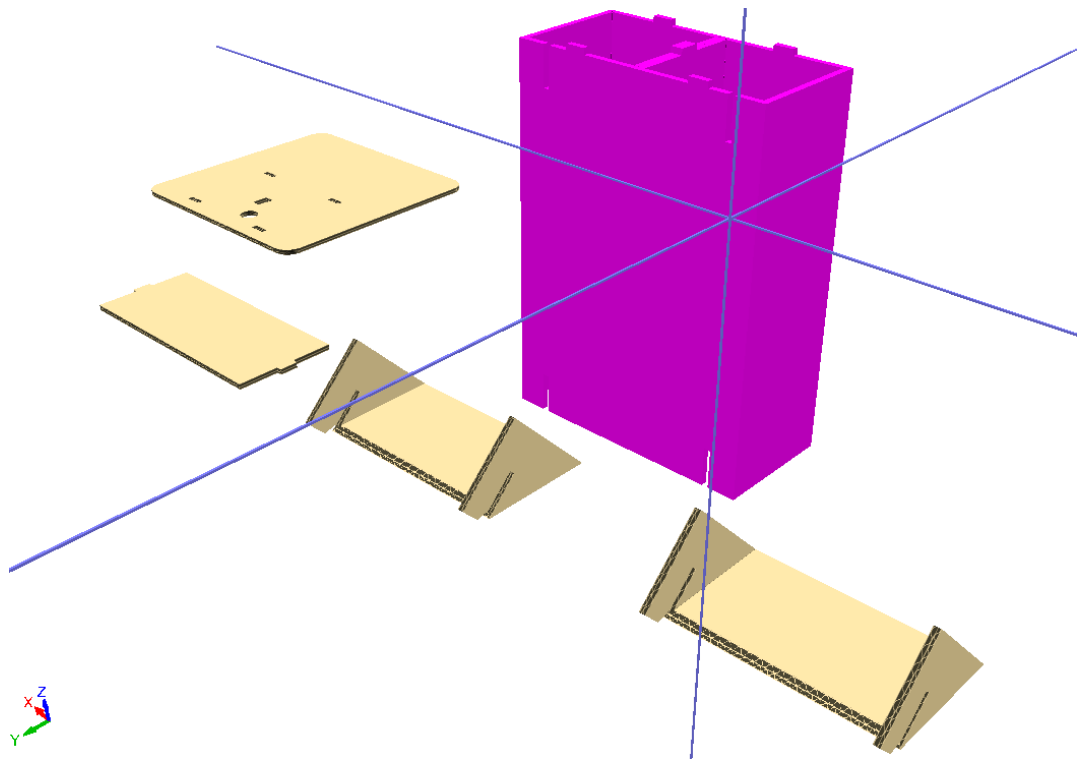

Do not close the door yet, as you will need it open to place the final piece.

3.  Use **View Angle** to change the view to the other side.
4.  Use **Select Design** to select the base.
5.  Use **Rotate Design** to rotate the base upward. Double-click the horizontal axis to quickly rotate it by 90 degrees.



6.  Click **Snap Tab/Slot**, click slot 1, and then click slot 2 to join the bottom support to the base.

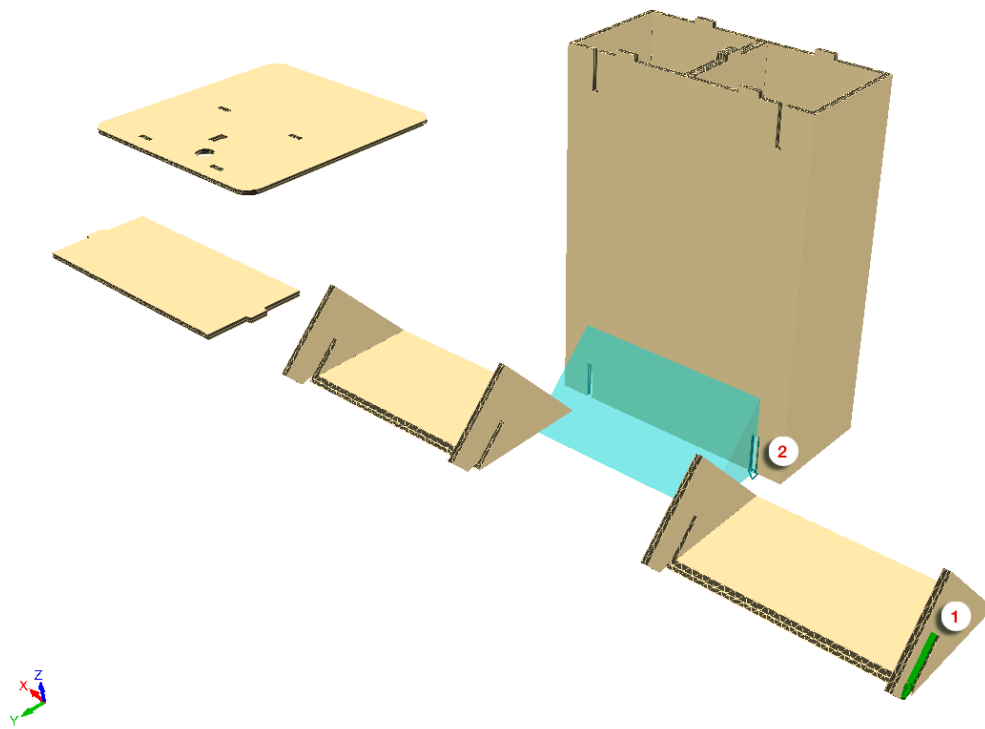

ArtiosCAD assembles the pieces.

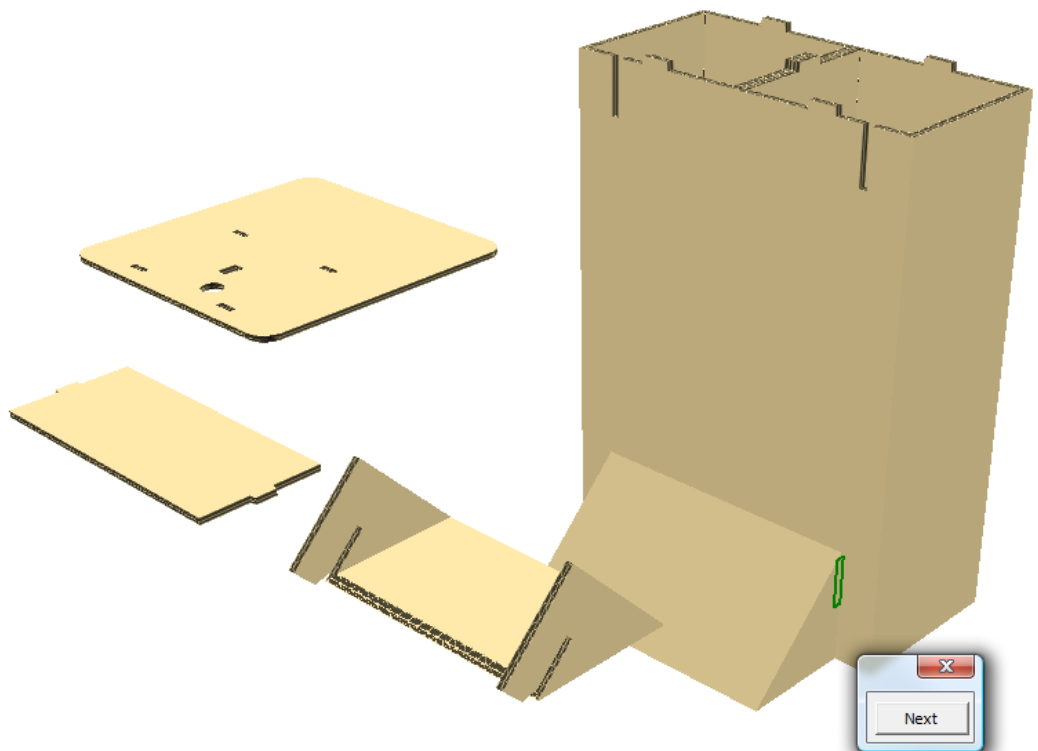

7. With **Snap Tab/Slot** still active, click slot 1, and then click slot 2 to join the top support to the base.

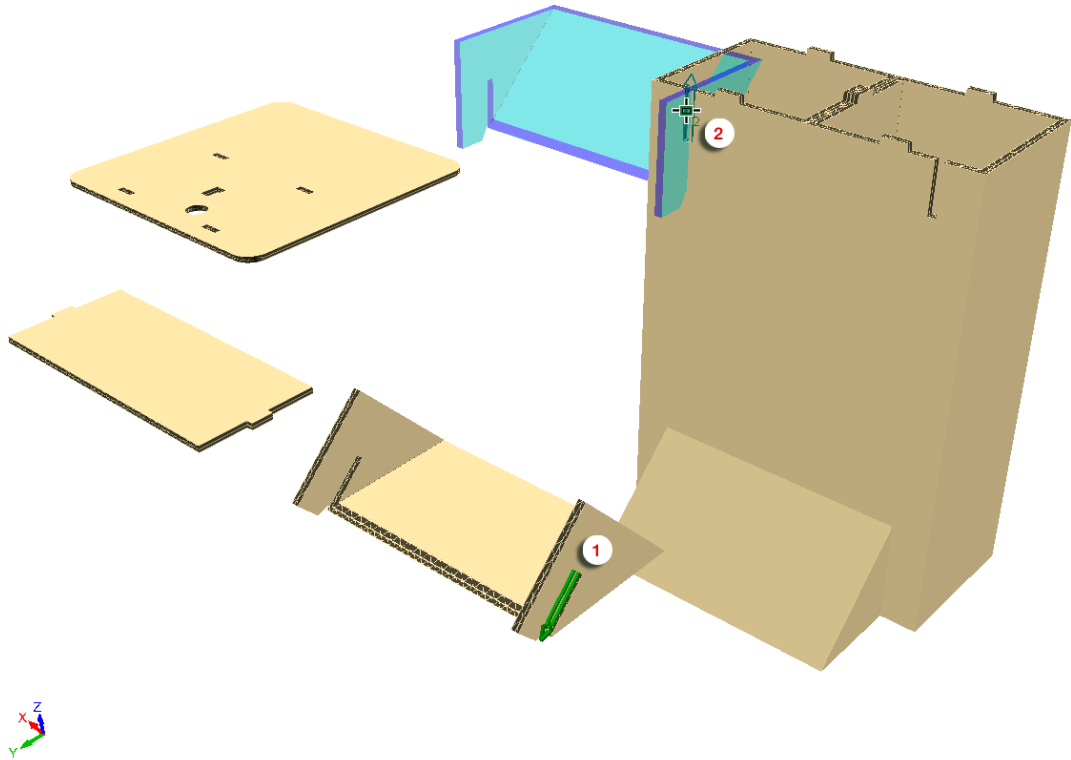

ArtiosCAD joins the top support to the base, but aligns it improperly.

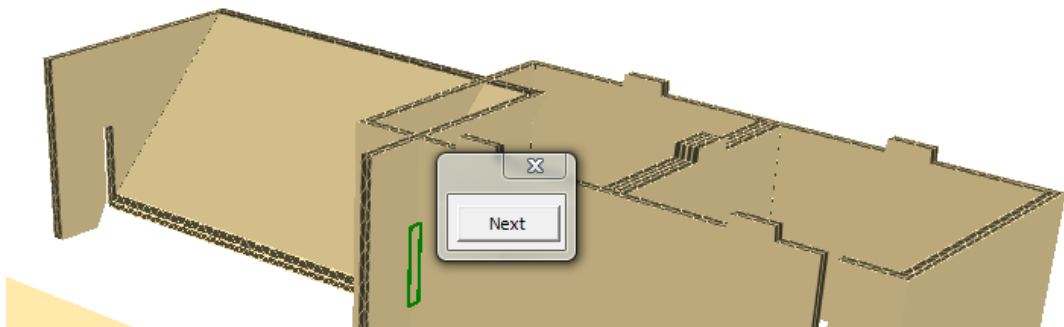

8. Click **Next** to choose the proper alignment, or use the left and right arrow keys on the keyboard.

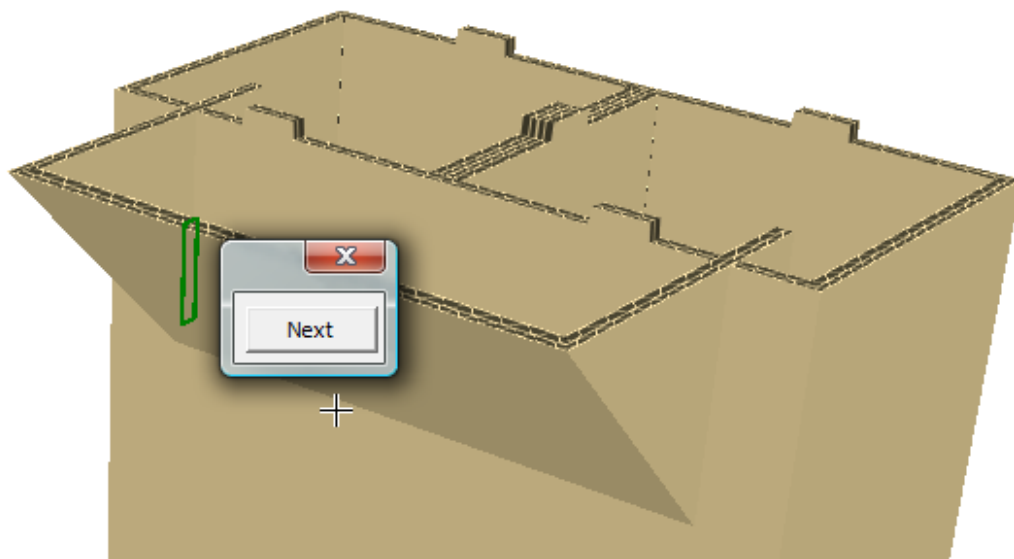

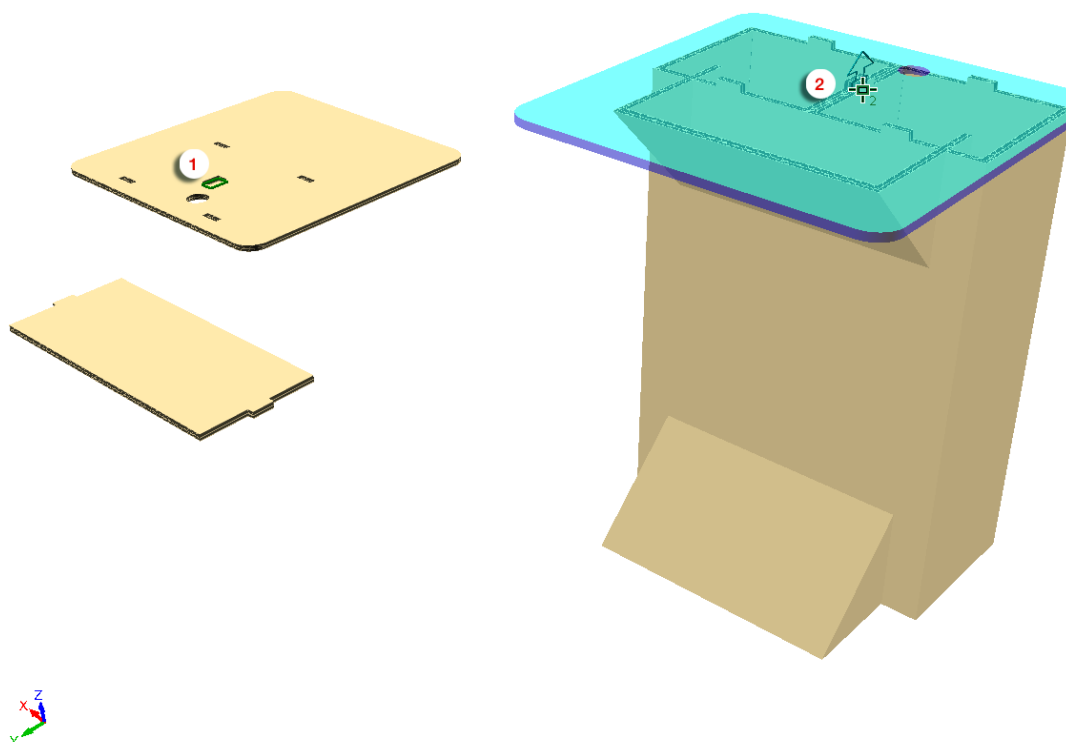

- 9. Click **X** to close the alignment selector.
- 10. With **Snap Tab/Slot** still active, click slot 1, and then click tab 2 to join the top to the base.

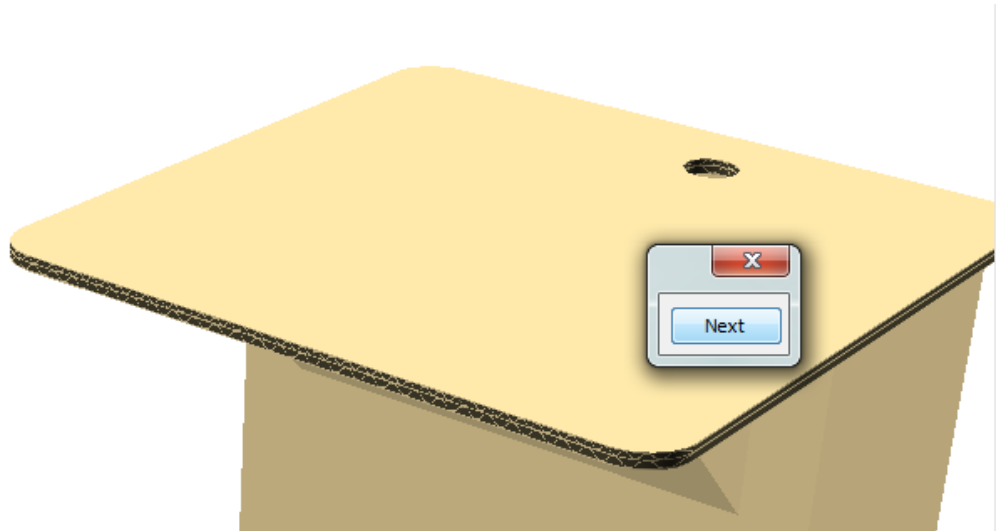

- 11. Click **Next** to choose the proper alignment, or use the left and right arrow keys on the keyboard.



12. Click **X** to close the alignment selector.
13.  Use **View Angle** to change the view to the other side.
14.  Click **Snap Tab/Slot**, click slot 1, and then click slot 2 to join the shelf to the base.

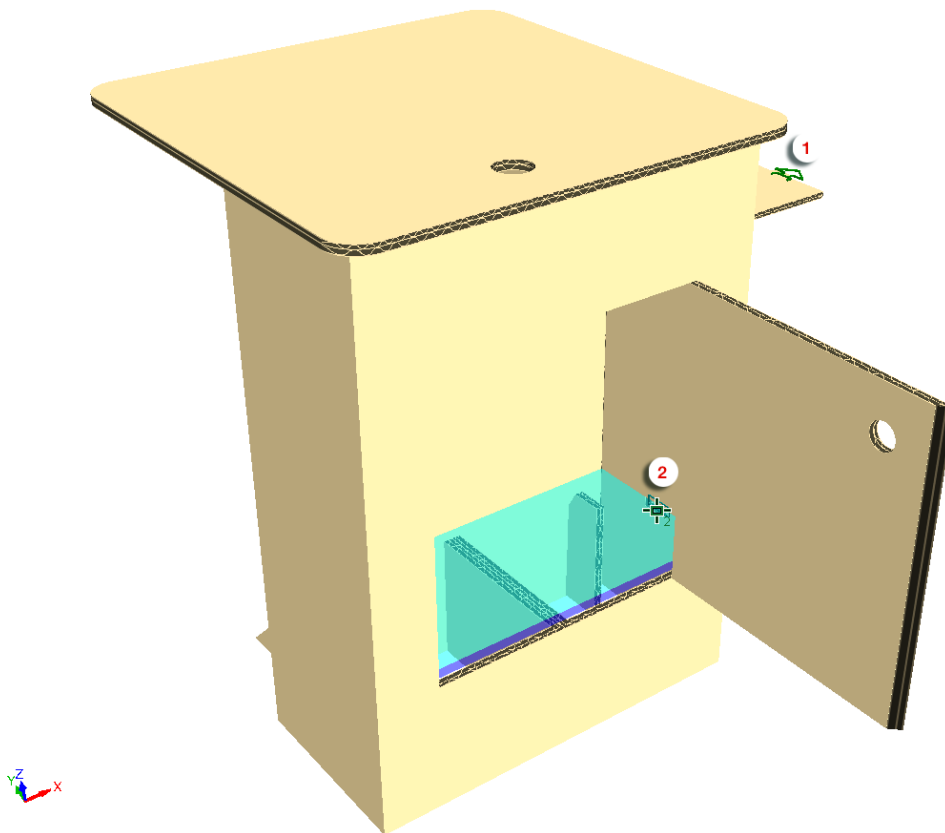

15. Click **X** to close the alignment selector.

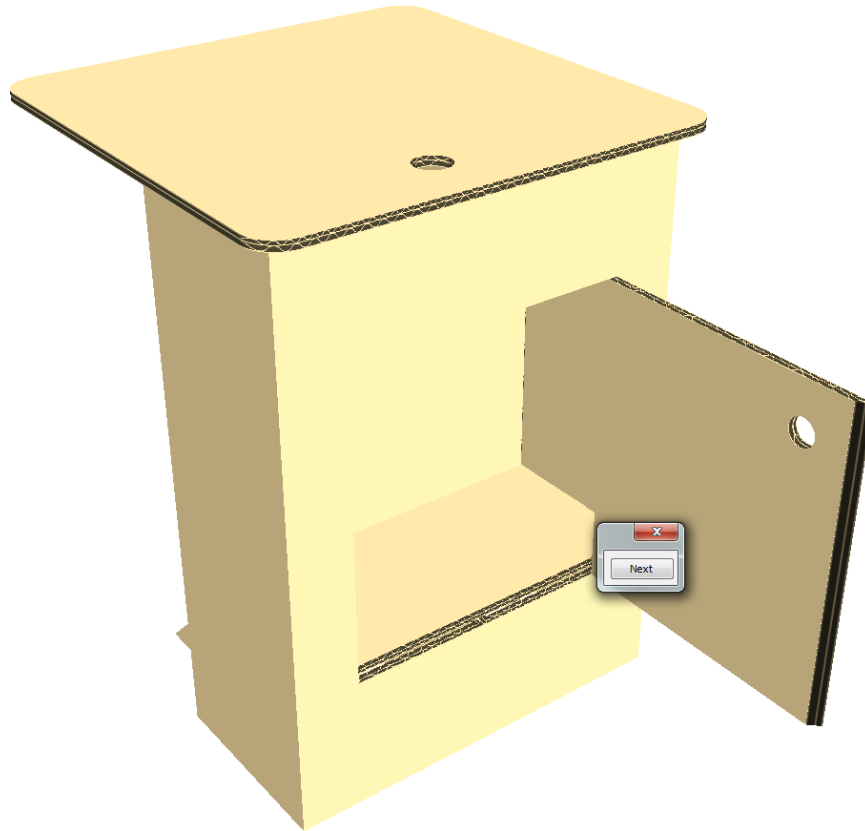

16.  Use **Fold Angle** to shut the door on the base.

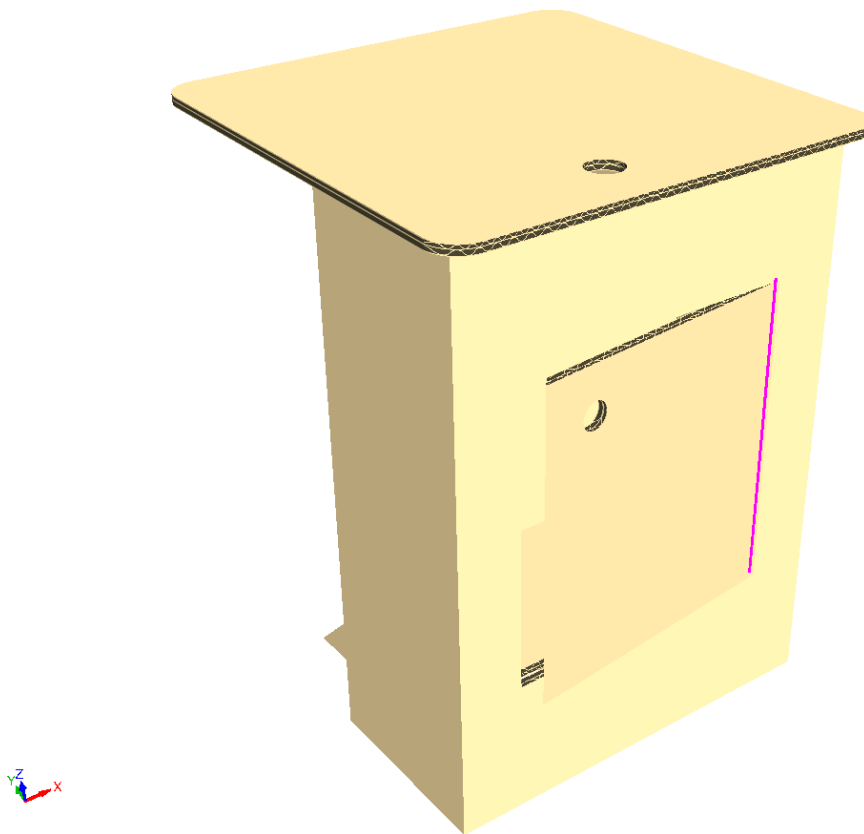

17. Save the completed assembly and Output it as desired.

Using Mates with the Snap Tab/Slot Tool

Use the **Add Mate** checkbox on the Status bar of the Snap Tab/Slot tool adds mates to the slots and tabs as you use the tool for easier connections later should you change the design. It is enabled by default.

If the associated 2D design is also open, ArtiosCAD adds connected mates to it.

To add mates while using this tool, do the following:

1.  Click **Snap Tab/Slot** on the Fold in 3D toolbar.
2. **Add Mate** Select **Add Mate** on the Status bar if it is not already selected.
3. Use **Snap Tab/Slot** as usual. Note that you cannot select a slot that is already occupied or already has a mate. You will see that after each use, ArtiosCAD shows green connected mates next to each connection, one for each.

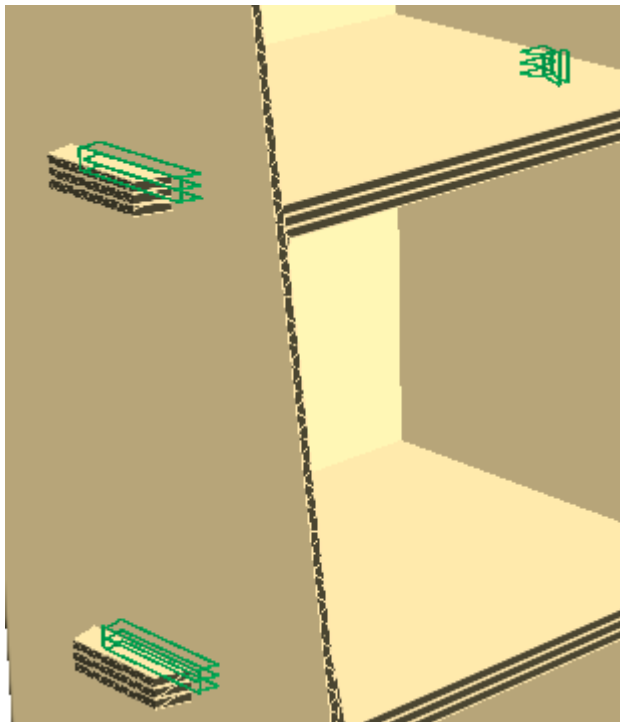

Note:



If you Undo the snapping of a tab into a slot, ArtiosCAD undoes the mate in 3D, moves designs to their original positions, and removes the mates from the 2D design if it is open. If you modified the 2D design independently of the 3D so that it is no longer synchronized with the 3D workspace, ArtiosCAD does not change the mates and issues a warning.

Snap Tab/Slot tool notes



The **Snap Tab/Slot** tool supports many shapes of tabs and slots.

The table below shows the types of tabs and slots ArtiosCAD supports.

Tab/Slot	How it is recognized	How to use it
 Tab	Top is partially flat and shoulders are parallel	Fits in a hole slot or partial depth slot
 Hole slot	Rectangular hole of cut lines	Tab fits in either side
	Rectangular hole of partial cut lines	Tab fits on the inside

Tab/Slot

Partial depth slot

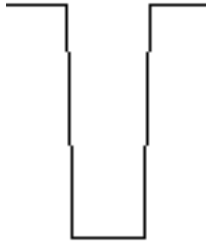

How it is recognized

Sides must be close to parallel

How to use it

Fits in another edge slot or dual-edge slot

Edge slot

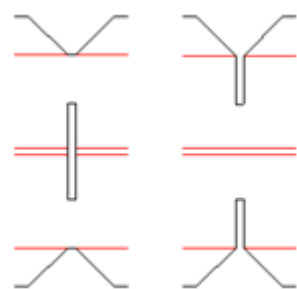

After folding angles at 90 degrees, two parallel edge slots act as one slot

Fits in another edge slot or dual-edge slot

Dual-edge slot



Slot on a crease

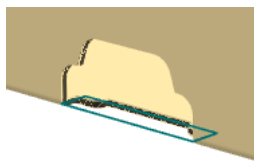

Cut lines interrupting a crease

Tab fits inside the slot

Cut lines interrupting a crease

Tab fits inside the slot. Meant for stacking boxes. It must have a crease that meets it somewhere above the baseline cut and be folded around 90 degrees.

Stepped-cutback stacking slot

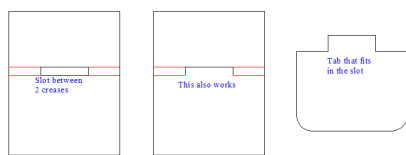

Between two creases each folded at 90 degrees

Slots between two creases

Between two creases each folded at 90 degrees

Tab/Slot

How it is recognized

How to use it

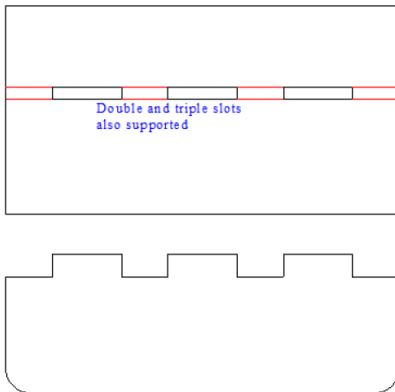

Note:

ArtiosCAD will warn you if the selected tabs and slots are substantially different sizes.

ArtiosCAD supports the following tab shapes:

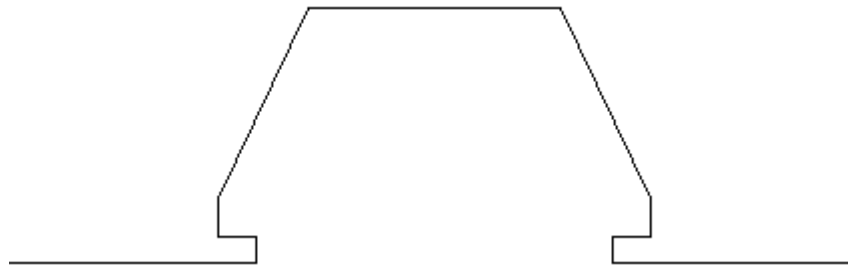
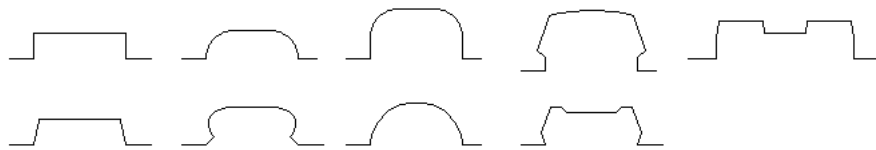

However, there are limits to the tab shape as shown:

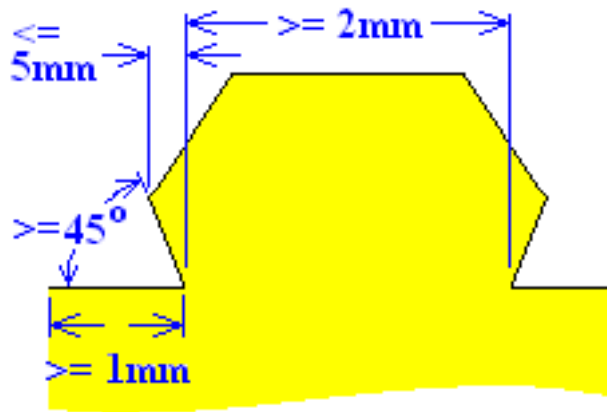

- The parallel lines before and after the tab must be at least 1mm long.
- The tab must be least 2mm wide.
- The start angle of the tab must be at least 45 degrees.
- The side of the tab cannot overhang the base by more than 5mm.

ArtiosCAD recognizes a tab within another tab in the following cases. You can choose either the main tab or the tab-within-a-tab.

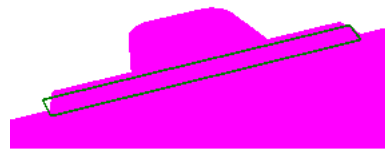

Main tab

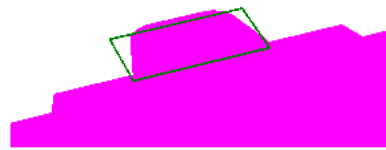

Tab within tab

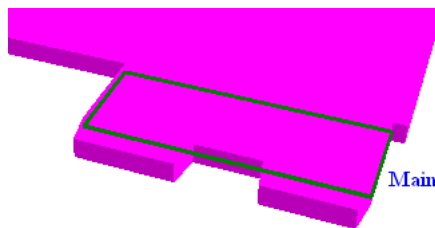

Main tab

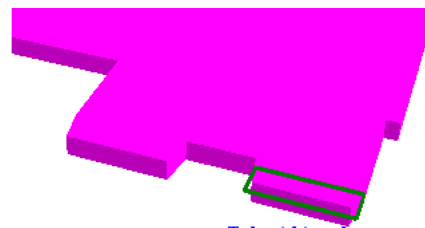

Tab within tab

ArtiosCAD treats two tabs side by side as one tab.

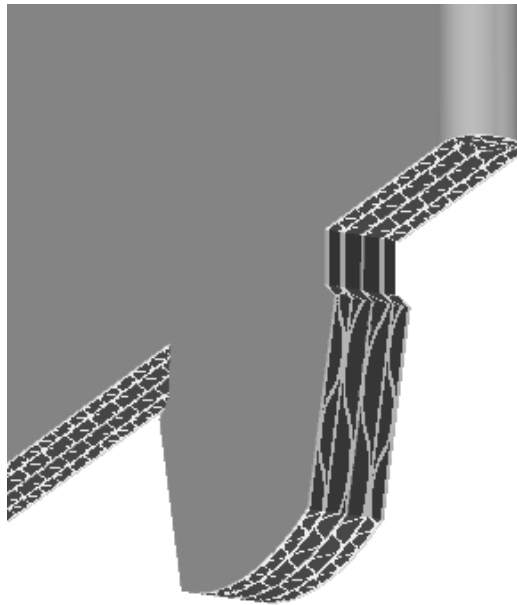

ArtiosCAD supports the following hole shapes for a tab to fit into:

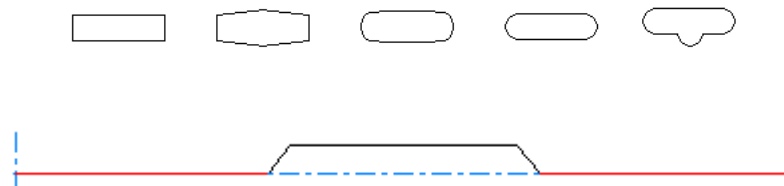

Use the following considerations when designing a hole:

- Make the hole roughly rectangular.
- Make the hole with 4 to 12 lines.
- Make the hole longer than it is wide.
- Make the hole at least 2mm long.
- Make the sides of the hole approximately parallel.

The Snap Tab/Slot tool also supports dual slots:

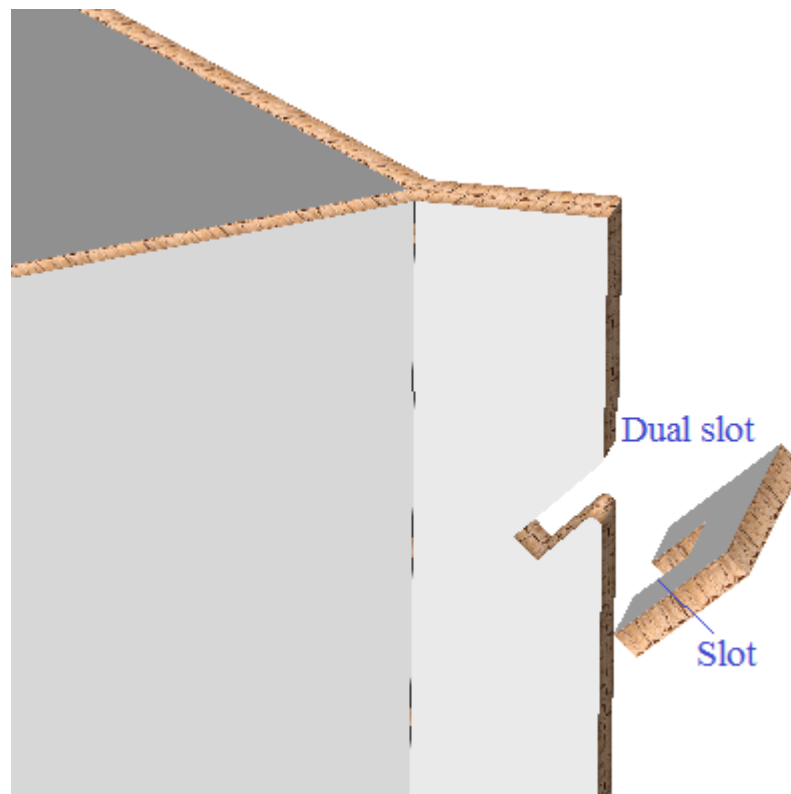

The Snap Tab/Slot tool also supports paired slots in partitions:

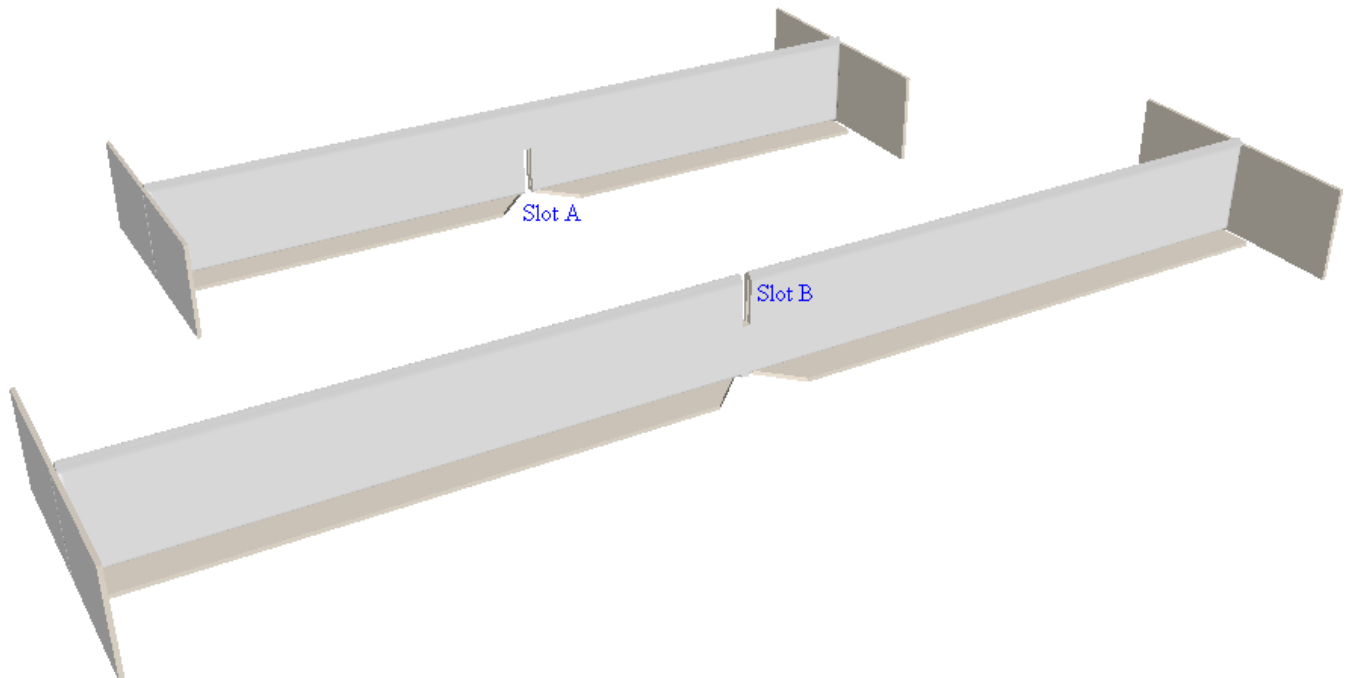

Note:

The Snap Tab/Slot tool aligns slots and tabs in separate pieces of designs. It does not fold a tab into a slot in the same piece of a design.

Drag

This tool uses drag to indicate different situations.

Tab

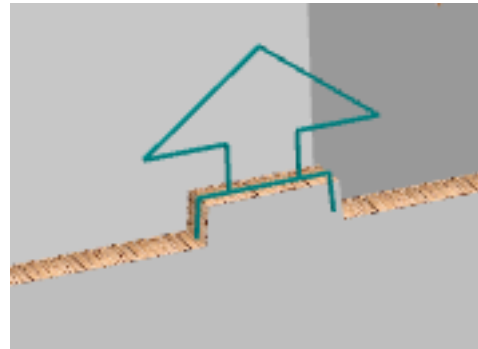

Hole Slot

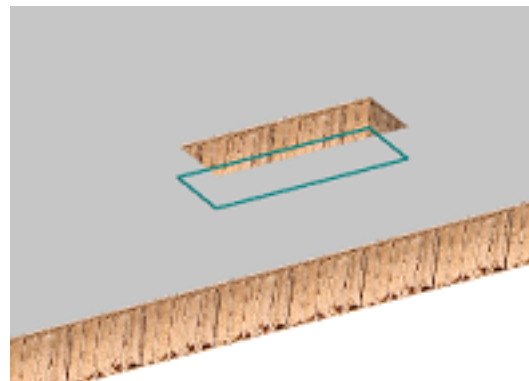

Slot

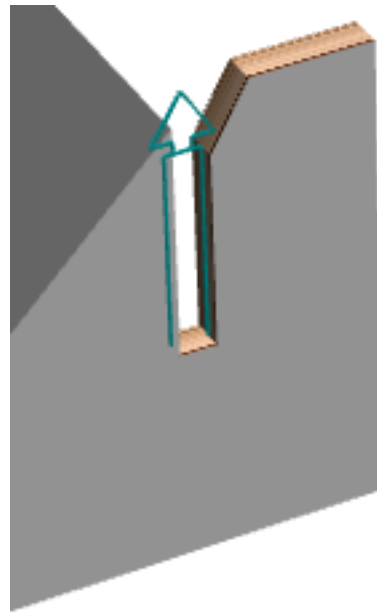

Crease Slot

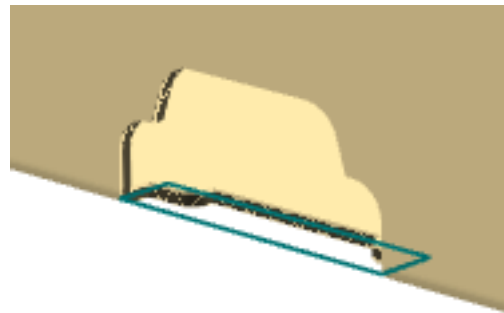

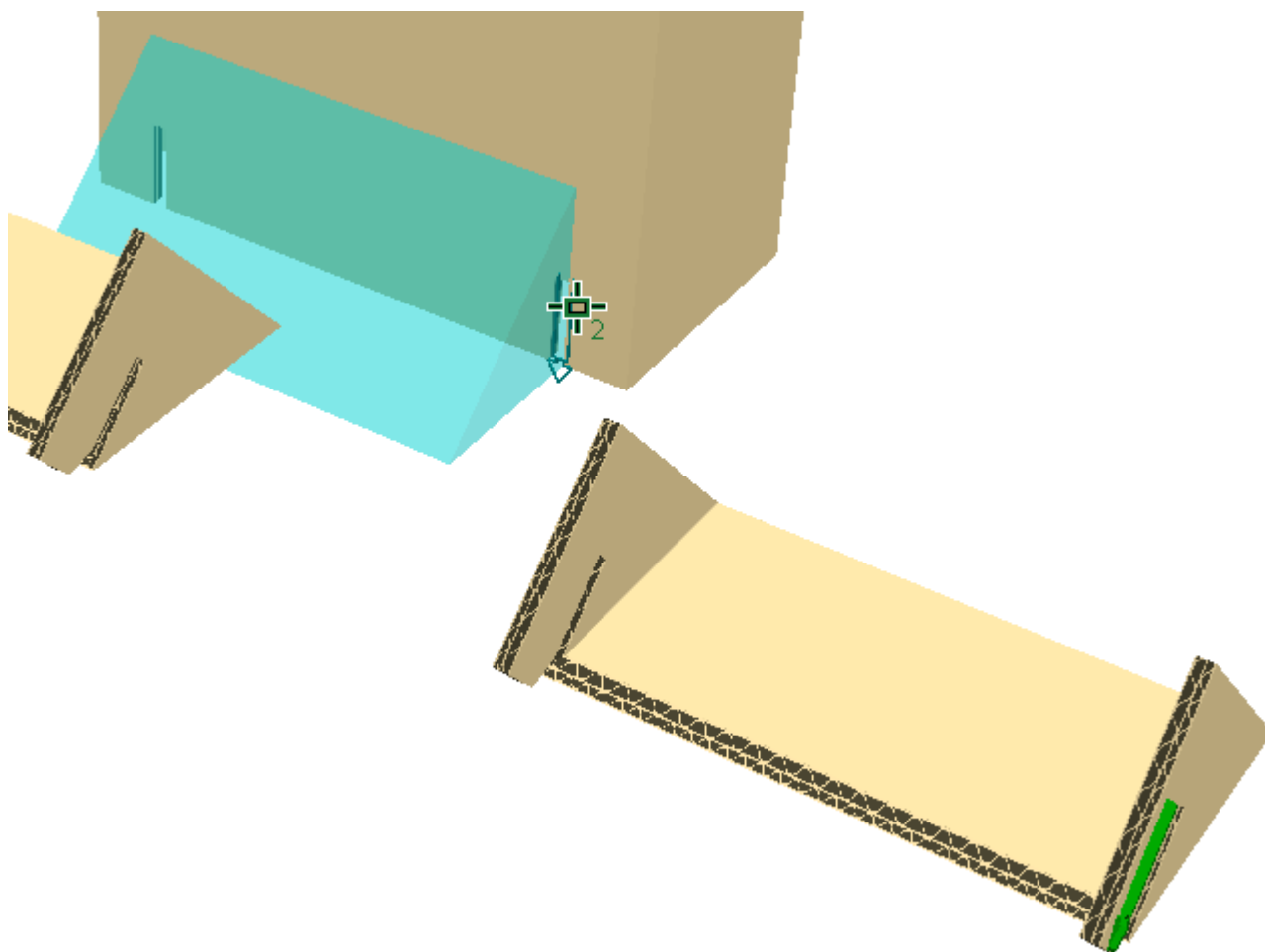

When using this tool, the cursor changes to a cross-hair depending on whether the cursor is over a tab or slot and whether the tab and slot will fit together, which is visible in the example for the next paragraph.

The tool also shows a drag preview showing the destination of the selected design.



Snapping a Stack of Tabbed Pieces into a Slot

 **Snap Tab/Slot** can snap a stack of congruent tabbed pieces into the same slot, provided there is room for them in the slot. ArtiosCAD. It supports up to six layers of material.

 Use **Move Point to Point** to stack the congruent pieces.

 Click **Snap Tab/Slot** and hover over one of the tabs. ArtiosCAD shows a larger arrow comprising the cumulative size of the tabs.

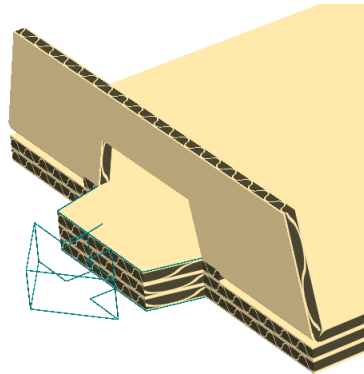

As you can see, the pieces do not have to be identical; they just have to be congruent. Shown below are the tabs snapped into the same slot and the mates ArtiosCAD

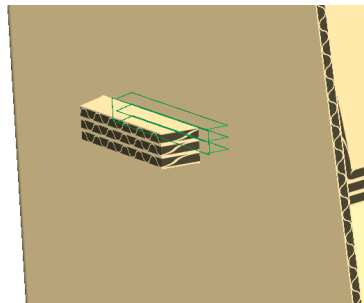

Note:

If the 3D workspace was converted from a canvas, and you have more than one stack of congruent parts, and each stack has different numbers of the same canvas part, you must have a separate canvas part for each stack in 3D workspace.

You cannot select a slot that is already occupied or has a pre-existing mate.

Folding Retail-Ready Containers

Once you have designed your retail-ready package and made sure to set all the tearing lines' 3D properties correctly, convert it to 3D as usual.

Select Tear Away Part tool

 The **Select Tear Away Part** tool lets you select the part of a design that is separated from the main part of the design. Once it is selected, you can move or rotate it as desired.

1.  Click **Select Tear Away Part** on the 3D Tools toolbar.
2. Click the tear-away part of the design. It turns magenta to show it is selected.



3. Change the position of the part as desired.



Rejoining the Parts

To rejoin the torn-away part to the base of the design as it was originally, do the following:

1.  Click **Select Tear Away Part**.
2. Click a part that was torn away.
3. In the Select Tear-away Part dialog box, choose **Switch from the tear-away parts back to the initial design**.

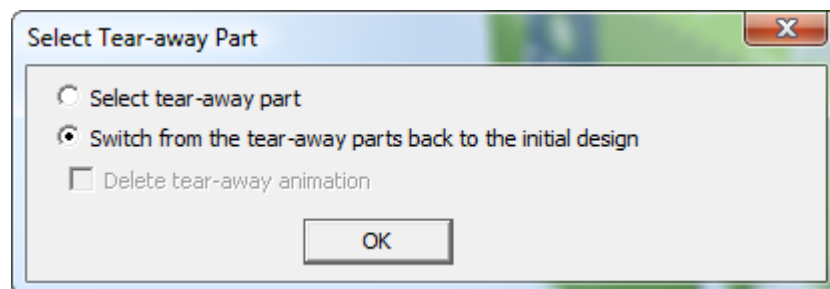

4. Click **OK**.

ArtiosCAD rejoins the parts.

Bend tool concepts

Bend panels differ from curved crease panels in that the panels themselves bend around something, not just the creases. Bend panels:

- Are defined by one or two bend lines, which in the default plotting style are red dot-dashed lines
- Have an angle changed by the **Bend** tool
- Do not have curved creases.

Bend lines divide the design into panels, and have fold angles in 3D the same as creases, but:

- They are not real creases
- Are not structural and can be hidden in the 3D Assist layer. (You will get a warning about the lines not being appropriate for the layer type but you can ignore that.)
- Do not have a crease bead
- Are not intended to be folded at a sharp angle.

In the design below, bend panels are marked 1 and bend lines are marked 2.

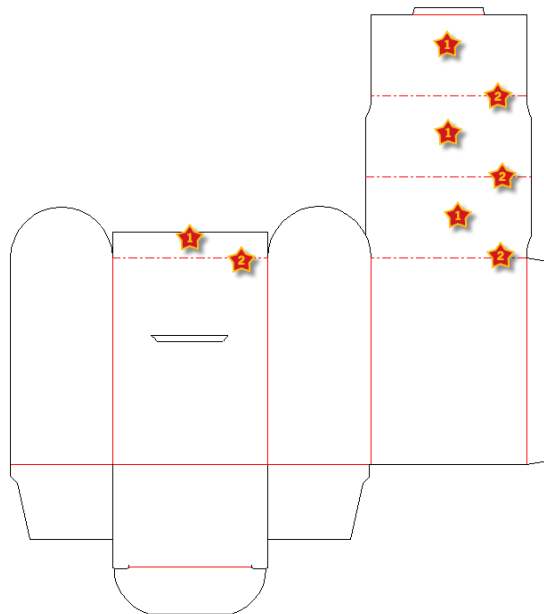

Types of bend panels

There are two types of bend panels: a cylindrical bend panel and a conical bend panel.

The bend panel is cylindrical if there is just one bend line or the bend lines are parallel.

The bend panel is conical if there are two bend lines that are not parallel. The bend lines should not meet.

In the example below, the left panel is a cylindrical bend, and the right panel is a conical bend.

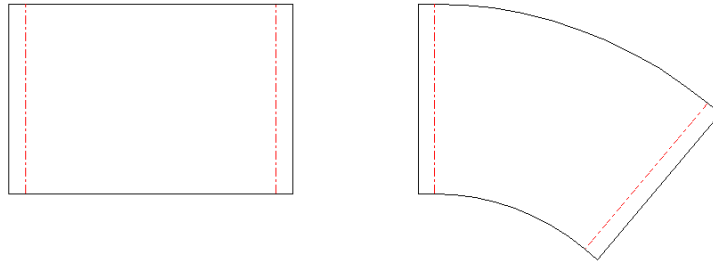

In 3D, they become:

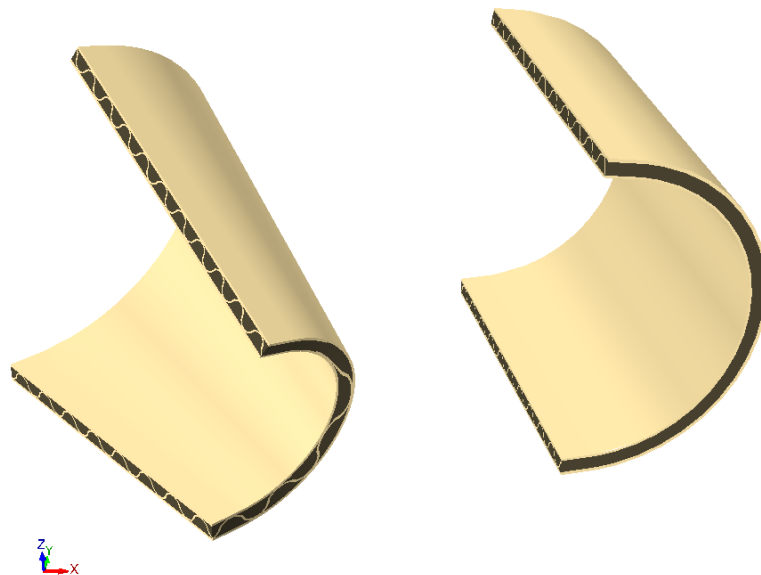



Using the Bend tool in 3D

To use the Bend tool in 3D, do the following:

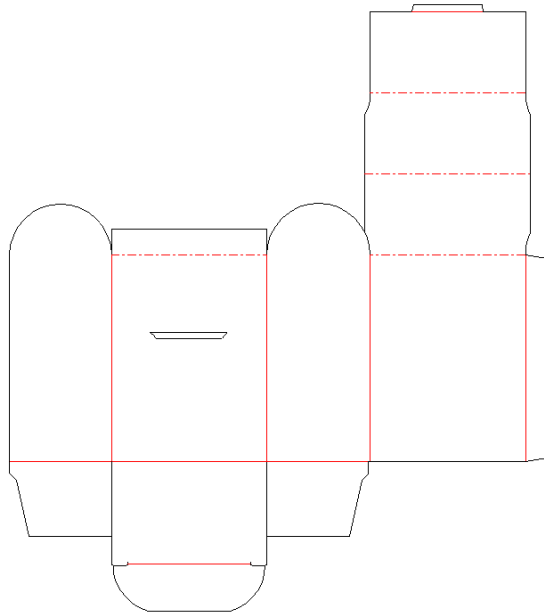
1. Create a single design or open an existing one with bend lines in its 3D Assist layer.



2.  Click **Convert to 3D** on the Tool Rack.
3. In the **Add Unfolded Design(s)** dialog box, click inside the base face and click **OK**.
4.   Use the **Fold Angle** or **Fold All** tool to fold the creases in the design.

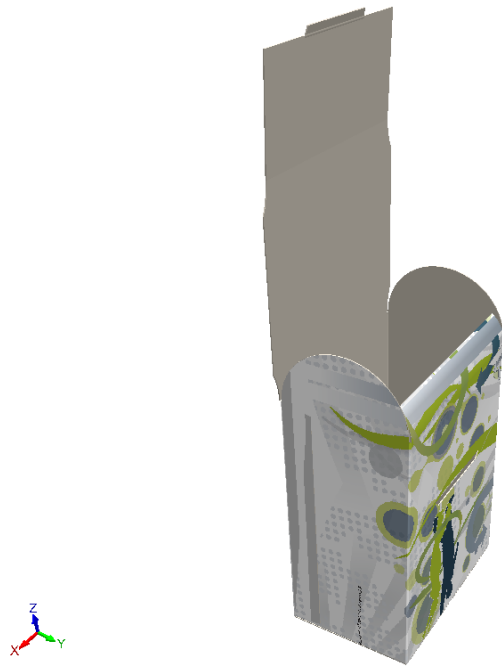

5.  Click **Bend Panel** and then click one of the bend panels.
6. The bend panel turns magenta to indicate it is selected and an **Angle** field and slider appear on the Status bar, along with a **Radius** field.

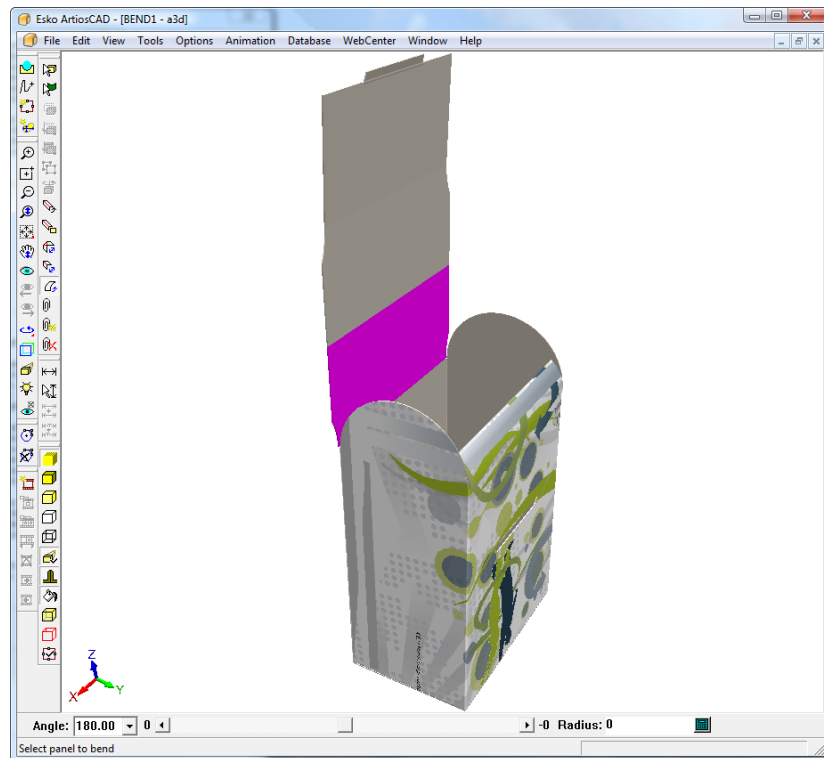

7. Change the **Angle** for the bend by either entering a value in the field, choosing a preset value from the drop-down list box, or by using the slider as shown below. You can also change the bend by entering a value in the **Radius** field.

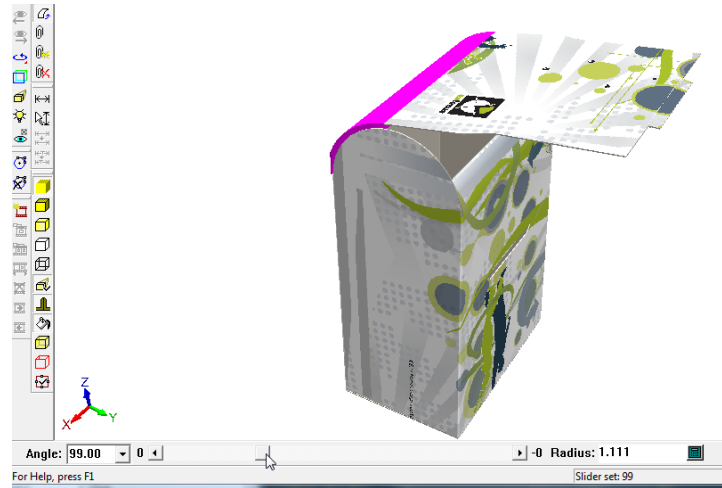

8. When you are satisfied with the bend of the first panel, click the second panel and adjust its bend, and repeat for the remaining panel(s).

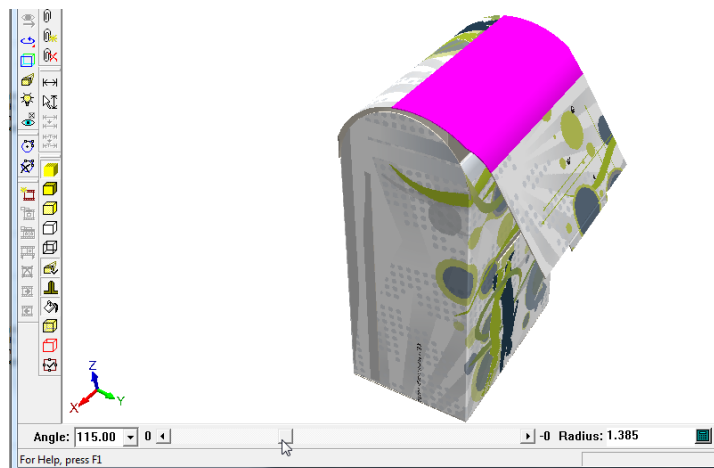

9. Shown below is the completed bend sequence.

**Note:**

A bend angle of 180 means it is flat. A positive bend angle has the print side on the outside of the bend, while a negative bend angle has the print side on the inside of the bend.

Glue/mate area concepts

The Glue/Mate area tools are designed to make it easier to connect designs together in 3D, and to indicate where glue will be applied to a carton as it is manufactured.

You define mate and target areas in Single Design and then when you convert to 3D, ArtiosCAD can automatically join the two areas, or you can join the areas manually. The rules for finding the matching area are:

- A mate/glue area mates with a target area. They must each be completely inside a panel.
- You can click either the mate or the target after starting the **Make Mate** tool.
- The mate/glue area must have the same name as the target, but the name may be blank.
- The mate/glue area and the target area must have identical lines, but they may be oriented differently or mirrored.

Rectangles are sufficient to define most mate areas, but for really specific needs, use an asymmetric shape (such as a rectangle you moved a point on to have a diagonal side).

Mate types:

- *Dynamic mates* are on cartons based on 4-panel sleeves with flaps, or those on cartons made of two pieces that form 4-sided tubes. Once these types of mate areas are mated in 3D, the cartons behave as if the folds are connected, and adjusting fold angles on their creases affects the connected panels.

- *Static mates* glue two designs together without affecting fold angles. If you attach two designs outside to outside or inside to inside, the target should be a mirrored copy of the mate area. The smaller design moves to mate with the larger design.



You can also add mates automatically when using **Snap Tab/Slot** by enabling **Add Mate** on its Status bar.

ArtiosCAD shows unconnected mates and targets in blue and red, and connected mates in green. Turn them on using **Show mate areas** in the View Mode.

For glue areas, you define them in Single Design the same way as you would a mate area (except specifying **Glue** as the **Type** in the **Mate Properties** dialog box) and then ArtiosCAD automatically shades that area in 3D when mate areas are turned on in the View Mode.



If your 3D workspace has many pieces with mate and target areas defined, click **Mate All** to mate them all together with one click. It will only connect mates automatically if it finds no conflicts. ArtiosCAD warns if it finds multiple targets and prompts you to use the **Mate** tool to connect mates.



To disconnect a mated area, click **Disconnect Mate**, and then click inside a green mated area. You may have to turn on mated areas in the View Mode beforehand. ArtiosCAD disconnects the mate and target areas and turns them blue and red. If there are multiple copies of designs and all the mates are connected to all designs, ArtiosCAD disconnects only the mates you click and leaves the others connected.

ArtiosCAD moves mated designs as a group in the **Move**, **Rotate**, and **Drag on Plane** tools, but not in the Copy tools, where ArtiosCAD treats them singly.

Deleting a design with mates turns off the mates in other designs that were connected to mates in the deleted design.

The mate tools recognize matching mate and target areas on stacks of designs. The designs do not need to be stacked as long as all the designs and mate areas are not mated to other target areas.

ArtiosCAD saves information about copies of canvas parts mated to other parts to the associated open canvas so that if you convert the canvas to 3D again, the parts mate together as before.

Note:

3D workspaces with mates are not recognized by pre-16.1 versions of ArtiosCAD. 2D workspaces prompt pre-16.1 versions of ArtiosCAD to find an unknown command in the logfile and the mate does not appear in the file when it opens.

Defining Mate and Target areas

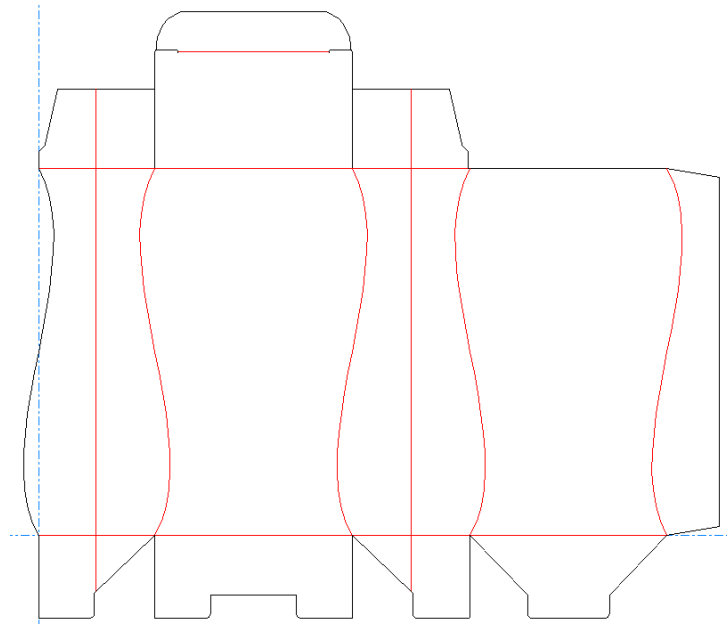

To define mate and target areas in a single design, follow this recommended workflow:

1. Create a new single design or open an existing one as desired.



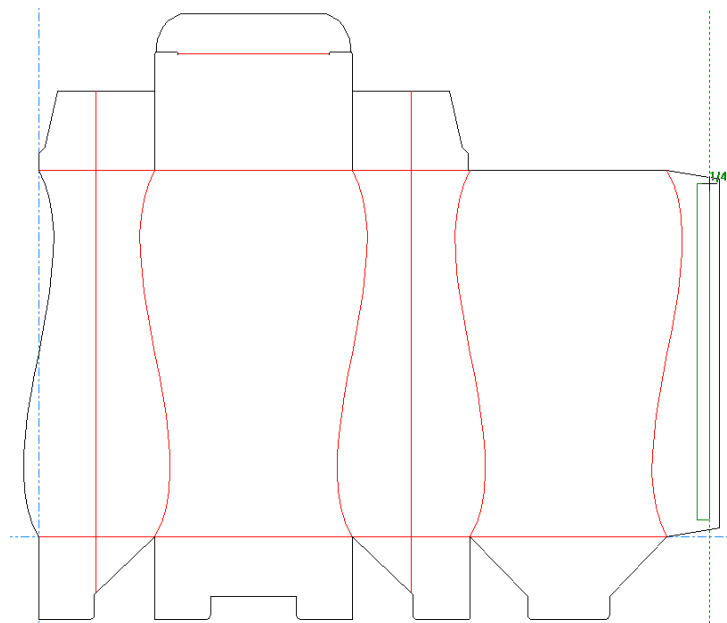

2.  Use the **Rectangle** tool to draw the Mate area.

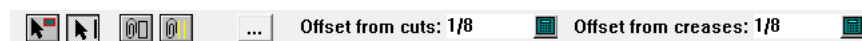

3.  Use the **Select** tool to select the lines comprising the rectangle.
4.  Click **Define Mate Area**. The tool starts and the following controls appear on the Status bar.



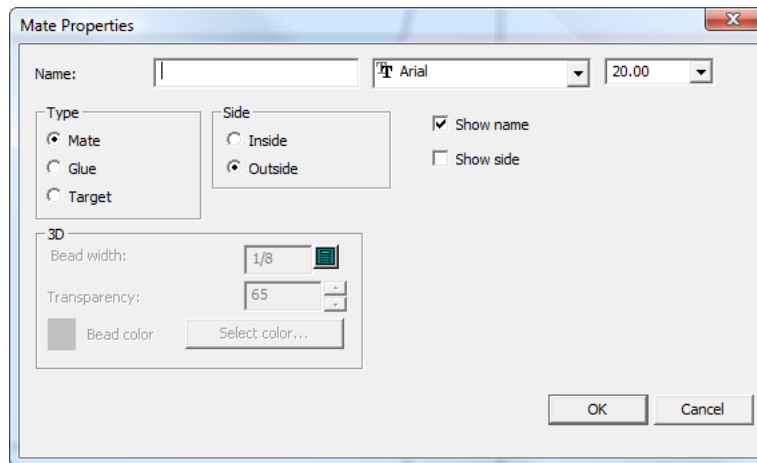

5.  Click **Make Mate** on the Status bar. The rectangle changes color and is moved to the 3D Assist layer automatically.
6.  Click **Properties**.

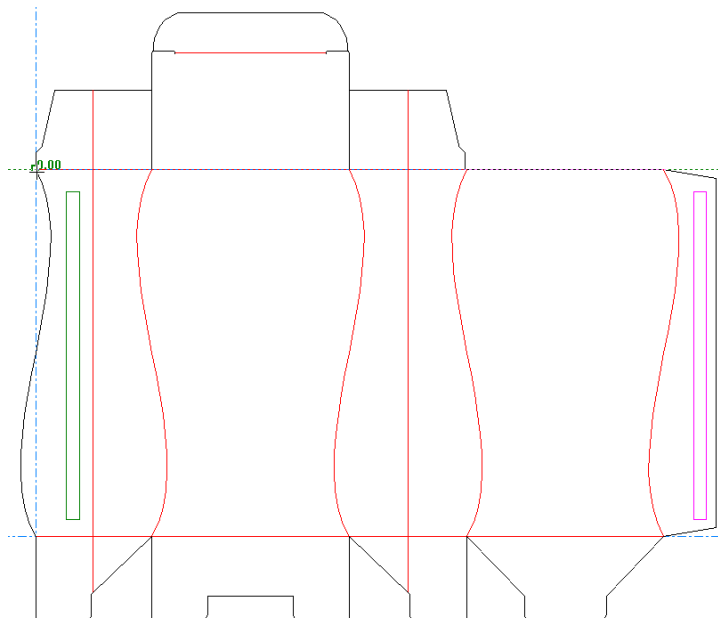

7. In the **Mate Properties** dialog box, assign a name such as area1 in the **Name:** field. The name of each mate and its target must be the same, but the name can be blank. Set the font and size for the label as desired. In the **Type** group, select **Mate**. In the **Side** group, select **Outside**. Select **Show name** and **Show side** as desired. Click **OK** to close the **Mate Properties** dialog box.
8.  Use the **Copy** tool to copy the rectangle to the target panel.



9.  Once the copy is placed, click **Define Mate Area**.

10.  Click **Mate Properties**.
11. In the **Mate Properties** dialog box, set the Type to be **Target**, set the Name to be the same as the name you specified for the Mate (such as area1), set the side to be the **Inside**, set the font and size fields as desired, and check or clear **Show name** and **Show side** as desired.
12. Click **OK** to close the Mate Properties dialog box.
13. Save the design.
14. The design now has mate and target areas defined and can be folded in 3D either automatically or manually.

Folding a design with a mate and target area

Once you have a design with a mate and target areas defined, convert it to 3D. For the purposes of these instructions, make sure to deselect **Use previous fold angles** if it is selected when converting to 3D.

Once the design is in 3D, do the following:

1.  Click **Mate**. The mate and the target areas on the design become visible; the blue area is the mate and the red area is the target.

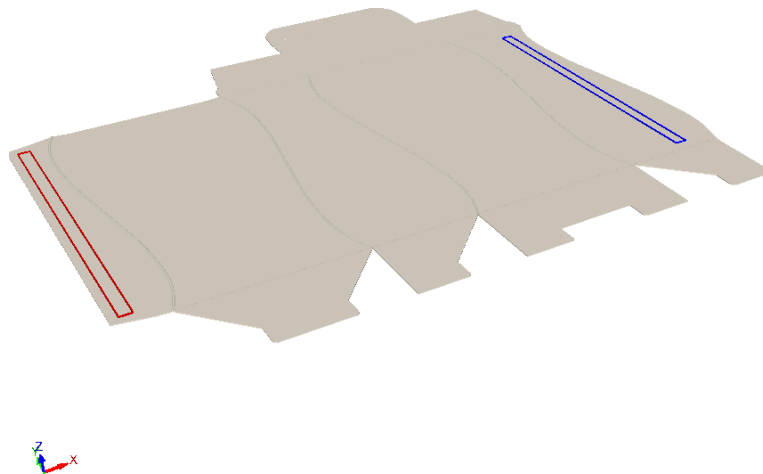

2. Click inside either the mate (blue) or the target (red) area.
3. ArtiosCAD joins the mate and target areas and turns them green. Since this is a dynamic mate due to the carton being based on a 4-panel sleeve, the panels behave as if they are connected to each other. When you adjust fold angles affecting one of the joined panels, the other panels move as well, just as they do in real life. Note that there are no limits on this movement and you may unexpectedly encounter less than optimal results.

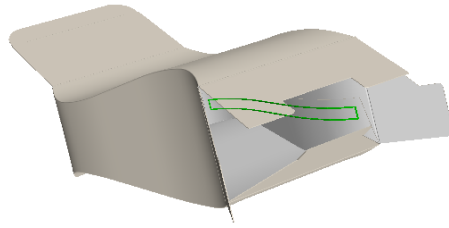

4. Change the View Angle and continue working on the design as desired.

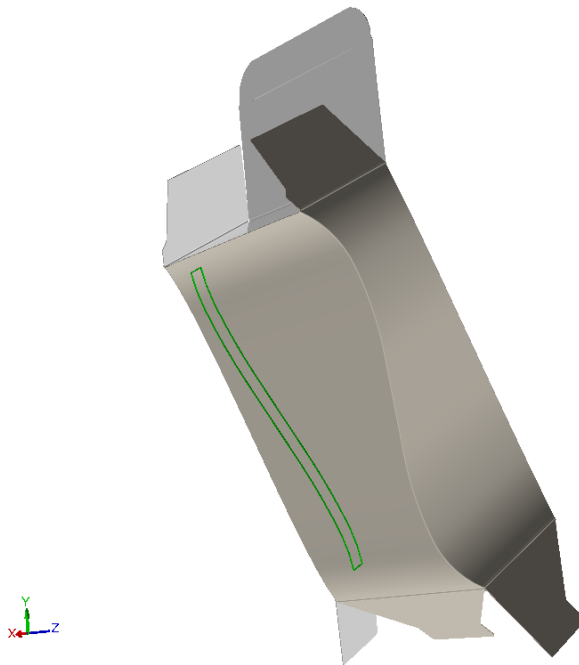

Attaching two designs in 3D using Mate and Target areas

This is an example of another dynamic mate. Attaching these two pieces together forms a four-sided sleeve.

1. Create the two pieces in Single Design that will be mated together in 3D.
2. As there are two attachment points, create two mate areas and copy them to two target areas.

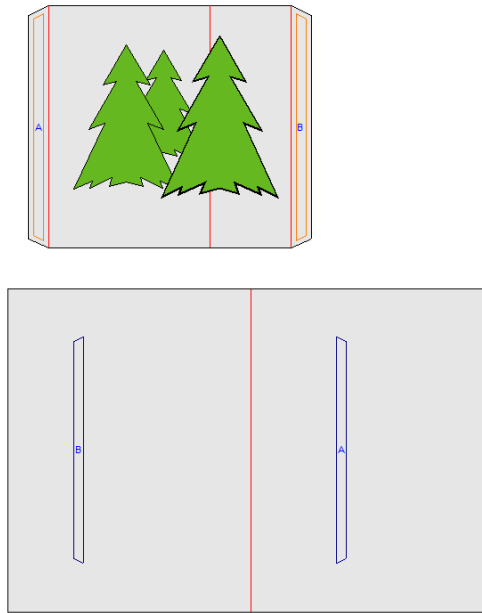

3.  Click **Convert to 3D** on the Tool Rack.
4. In the **Add Unfolded Design(s)** dialog box, click inside each base face and click **OK**.

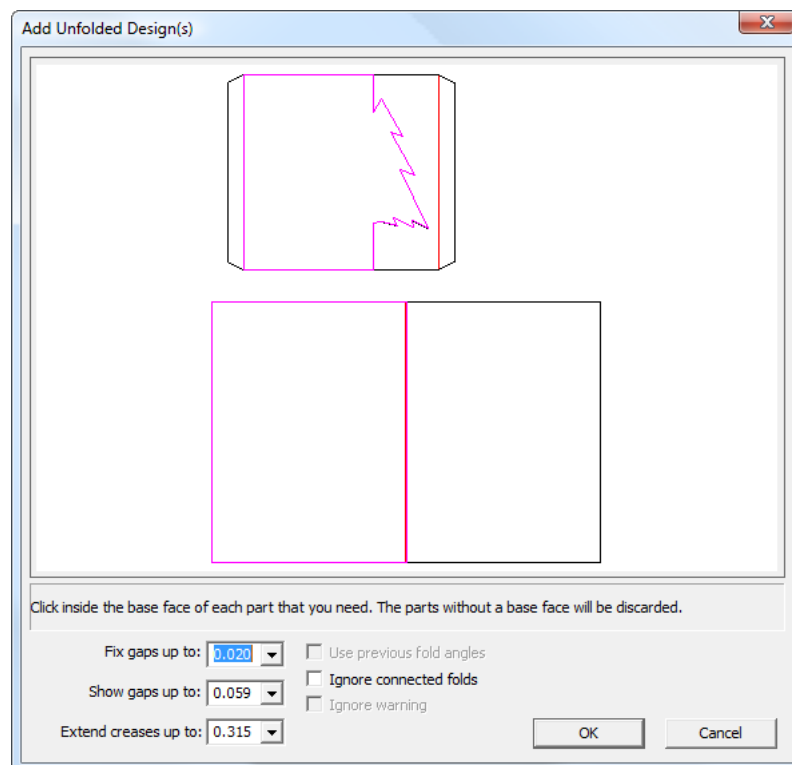

5. The two designs are brought into 3D.

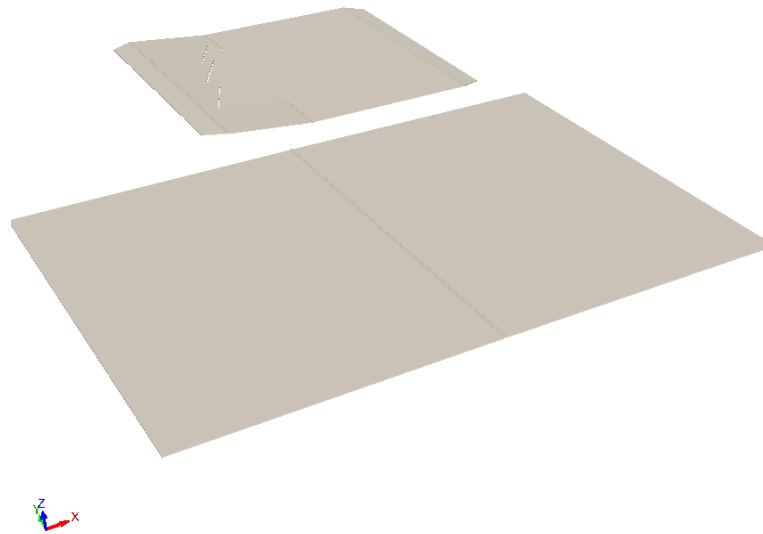

6.  Click **Mate All** in 3D. The two pieces join together at their mate areas; turn on **Show mate areas** in the View Mode and they both will be green to indicate that the mates and targets joined successfully.

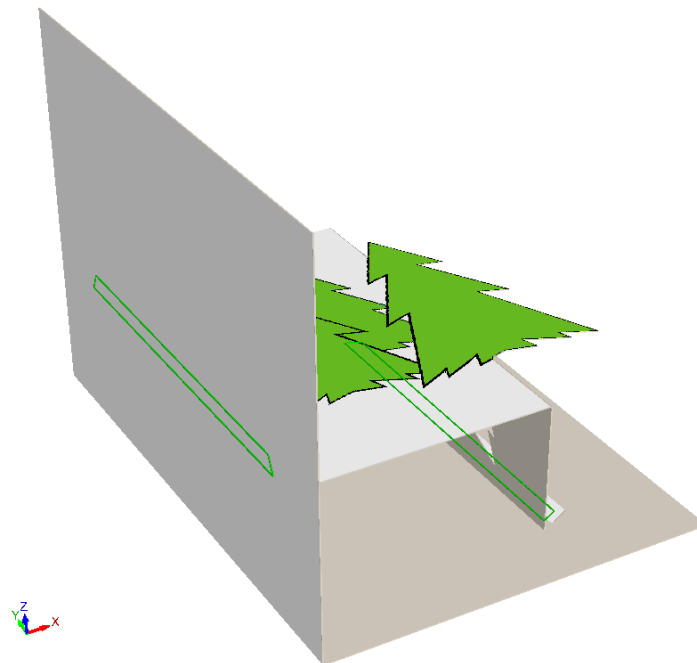

7. To see how the panels move together in this dynamic mate, change the fold angle of the crease folding the card in half.

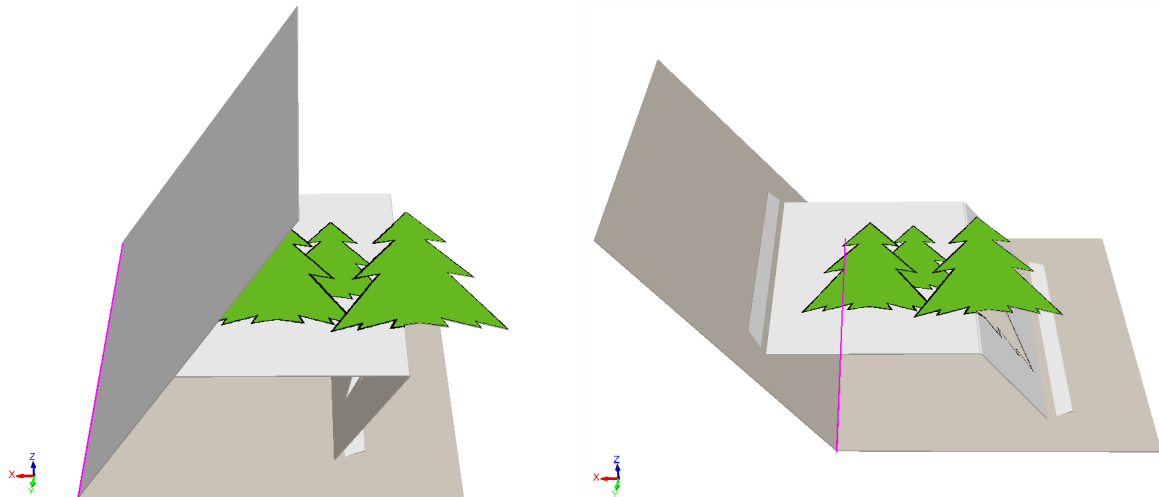

If you would rather use the **Mate** tool to connect the mates manually, or if the mates and target areas in separate designs do not have matching names or shapes, the cursor changes to a mate cursor when you hover over a target area that is a possible mate.



When you hover over an area that is not suitable for a mate, ArtiosCAD shows a stop cursor.



Attaching a solid to a carton in 3D

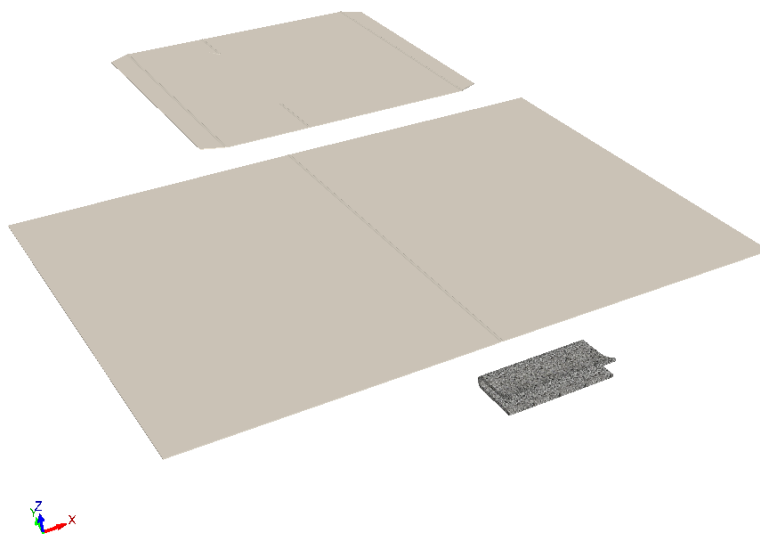

Solids cannot have mate or target areas defined, yet you can attach them to cartons that do by doing the following:

1. Bring all the pieces into 3D.

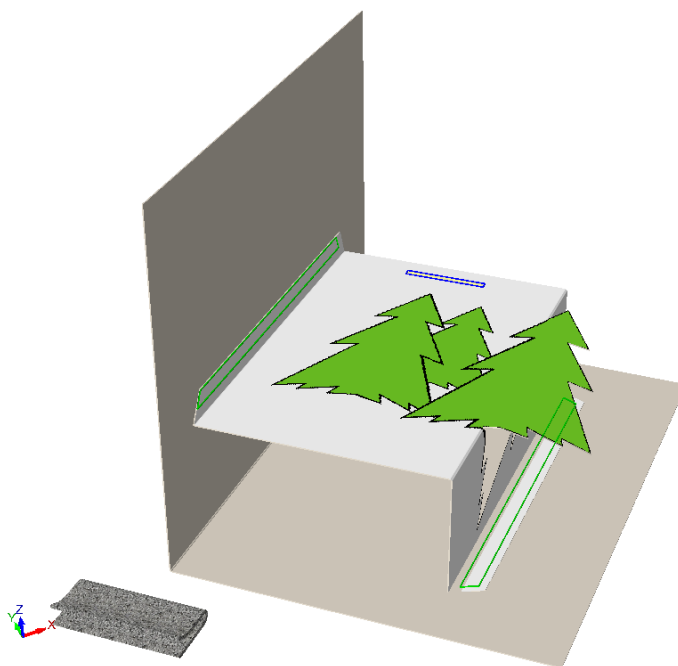

2. Mate the card pieces together, change the View Angle, and turn on **Show mate areas** in the View Mode.



3.  Click **Extend** and click the solid to turn on its extend points.
4.  Click **Select Designs** and select the solid.

5.  Click **Move Point to Point** and move the solid to within 5mm of the mate area. In this example, choose a pick-up point in the middle of the bottom of the clip. When you get close to the mate area, a put-down point appears in its center, as seen in the close-up below.

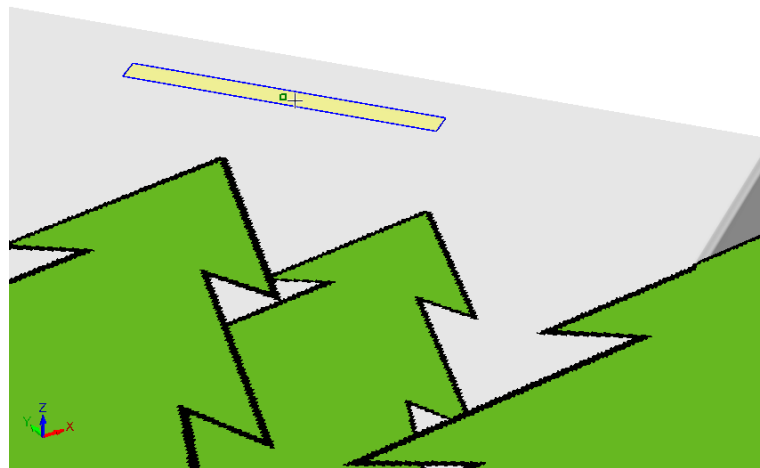

6. Click the put-down point. You may need to use the Rotate tools to get everything aligned to your satisfaction. The finished example of the card with a clip inside of it is shown below.

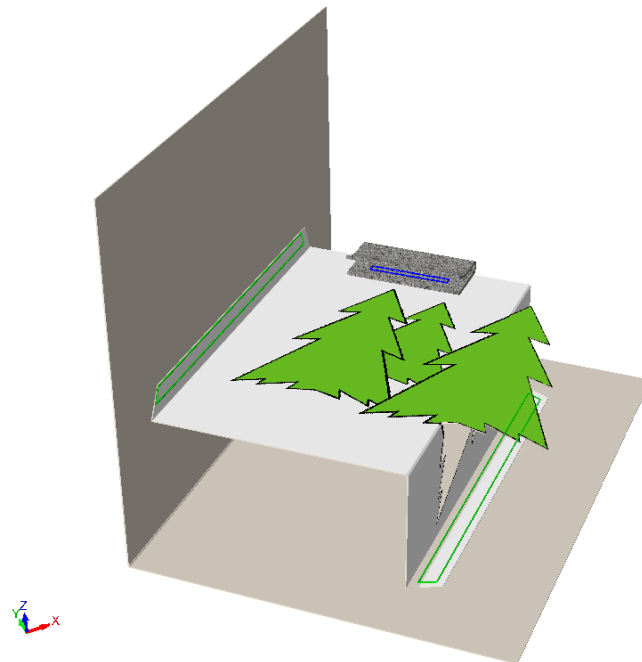

Deleting Mates



Use **Delete Mate** on the Fold toolbar (or Tools menu) to delete a mate from a 3D design as well as its associated 2D design if it is open. It does not change fold angles or the positions of designs.

To use this tool, activate it, and then click the mate to delete.

- If you click over a group of connected mates, ArtiosCAD highlights and deletes all of them.
- If you click over a disconnected mate, ArtiosCAD deletes only that mate.
- If you click over a mate in a design that has multiple copies, ArtiosCAD highlights and deletes the mate in each copy. If all copies of the design have disconnected mates, ArtiosCAD deletes only the one you clicked.

Panel Mate concepts

Panel mates help recreate a 3D scene after a rebuild by connecting two different designs that touch along a panel. Use them to define the spatial relationship between the two designs by defining anchor points, one in each design. They work best when you choose anchor points relevant for each design that will not change in a rebuild. This tool has an advantage over adding mates in 2D in that you do not need to figure out panel orientation to use it.

Before starting this tool, position the two designs so they are touching each other.

Creating a Panel Mate

To create a panel mate, do the following:

1.  Click **Panel Mate** on the Fold toolbar.
2. Hover over the abutting panels in the two designs to connect. ArtiosCAD turns allowable panels green.

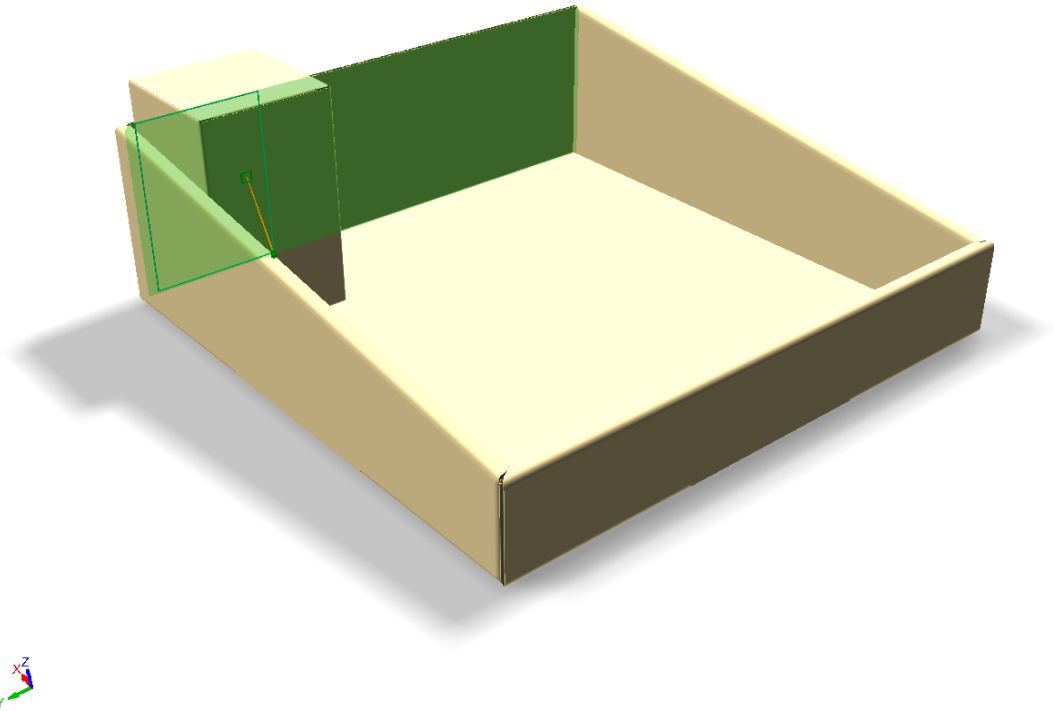

3. As you move the cursor around inside the panel, ArtiosCAD snaps to different suggested anchor points and connects them with yellow lines. Choose points that will most likely not change after a rebuild, like the center points of the two vertical lines shown below. Position the mate as close to the anchor points as you can so that both pieces are in the proper relationship after a rebuild. Green extension lines show a good position, while orange ones show a less desirable but still acceptable position. Click to set the mate.

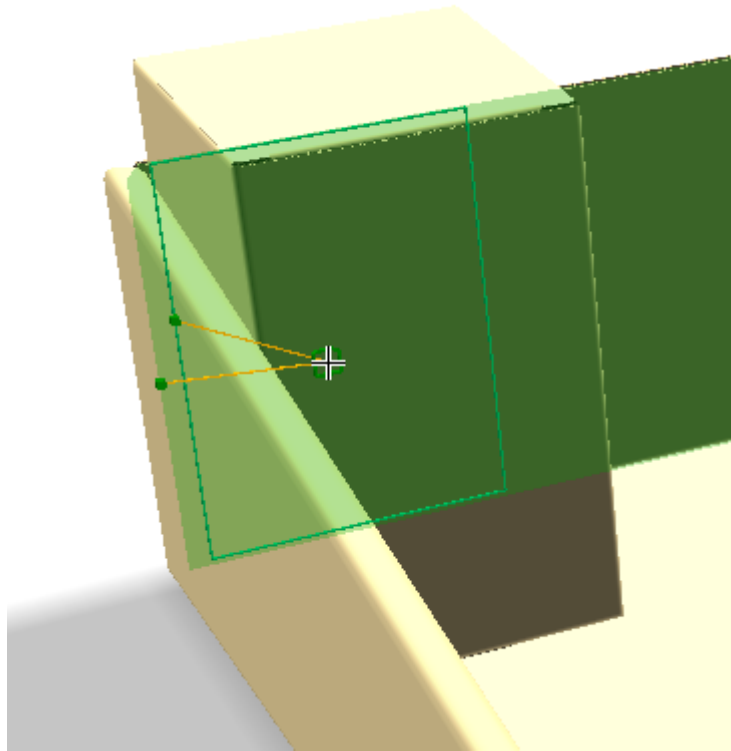

If you are not using rebuildable designs and/or have no plans to rebuild in 3D, you can ignore the anchor points and create the mate as desired.

4. ArtiosCAD shows a connected mate where you clicked.

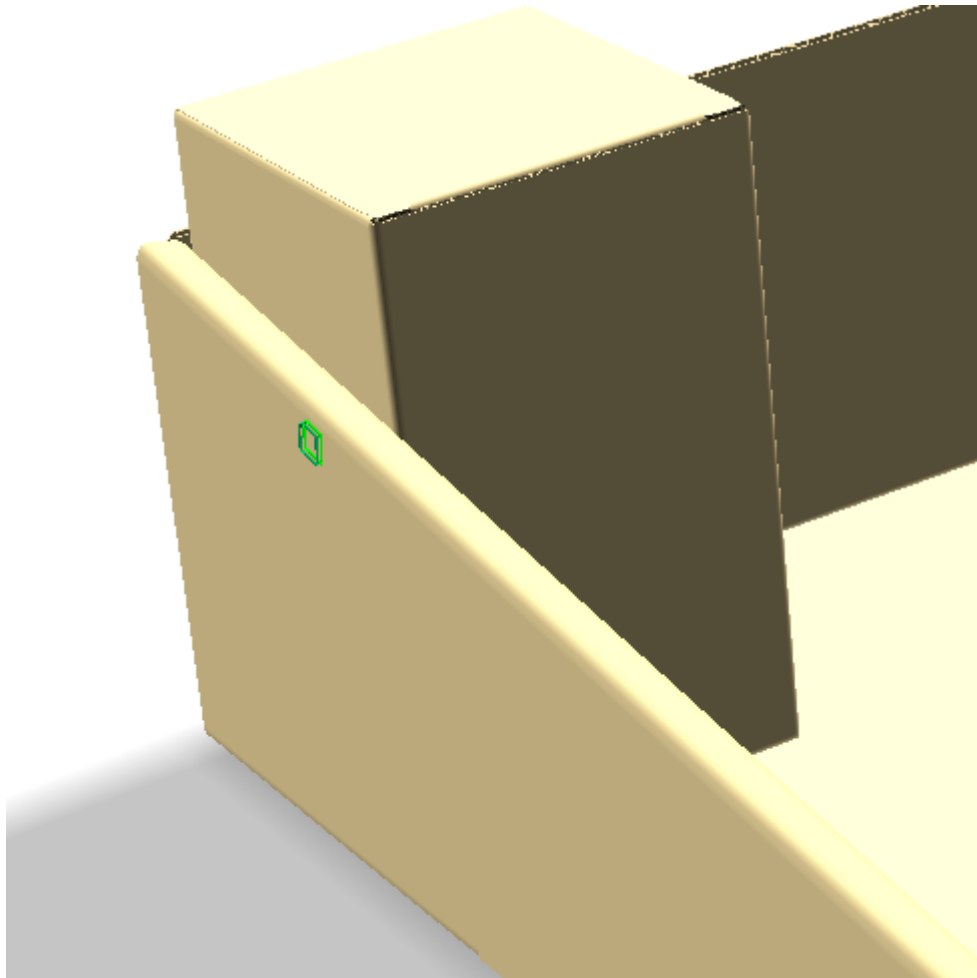

Notes on using Panel Mates

After a rebuild, the designs should share the same relationship to each other as they had before the rebuild. You may need to use the **Mate** tool to reconnect the mate if it becomes disconnected, but if so, they will snap together and you will not need to use any of the manual positioning tools.

If you do not have the associated 2D open, ArtiosCAD does not show anchor point feedback, but it still creates the mates in the 3D design, one of type Mate and one of type Target.

When you create a mate in a design with copies, ArtiosCAD creates a disconnected mate in the same location in each copy.

You can reuse an existing mate and have ArtiosCAD create its corresponding mate on the other design. ArtiosCAD sets the names to match and the new mate has the opposite type to the first mate (either Mate or Target). This is useful when connecting multiple copies of the same design to multiple different locations, such as a display base with multiple copies of the same shelf. The feedback in this case shows only one anchor and locks on to the existing mate.

You cannot mate tear-away designs.

You cannot reuse mates made by **Snap Tab/Slot**, nor can you reuse two mates on top of each other.

You cannot mate two designs that are already connected by mates.

Panel mates work only on two different designs. They do not work on different panels of the same design.

You may not make mates over holes.

ArtiosCAD saves mate connection information to the associated 2D design at the same time it saves fold angles. This is so you can create the desired scene in 3D, close the 3D without saving the fold angles, and reconvert the 2D and have everything flat again. The mates will be there but you must explicitly reconnect them.

Undo and Redo

If you unintentionally move a design in a way you don't like, or fold a flap too much, use the **Undo** command on the Edit menu to reverse your incorrect action. Use **Redo** to redo the action undone. **Undo** and **Redo** work on the following tools:

Table: Tools affected by Undo and Redo

Affected	Not Affected
Moves and rotations	All tools on the 3D View and View Mode toolbars
Fold angles, Fold to Meet	Select tools
Copy, addition, deletion of designs	Light Source
Group, Ungroup	Material Properties
Dimension tools	Extend, Clear Extend
Intersect Design	Animation tools
Cross Section	Bounding Box
Run a Standard	

Changing how you view the workspace

Use the tools on the 3D View toolbar to change how you view the design in 3D.



Zoom Rectangle tool

 The Zoom Rectangle tool lets you view a portion of your workspace at an increased scale.

1. Click the **Zoom Rectangle** tool.
2. Move the mouse cursor to a corner of the area to zoom in upon, hold down the mouse button, and drag to the diagonally opposite corner.

3. Your screen changes to show a close-up view of the area you selected.

Center-Point Zoom tool

 The **Center-Point Zoom** tool, when clicked, prompts you to click the center of an area to be zoomed in upon, and then to drag to the corner of that same area. Release the mouse button to perform the zoom.

Zoom Out tool

 Click the **Zoom Out** tool to view your workspace at a smaller scale.

Zoom In/Out tool

 Use the **Zoom In/Out** tool to change the zoom level by dragging the cursor in the workspace. To use this tool, do the following:

1.  Click the **Zoom In/Out** tool.
2. Click inside the drawing window of ArtiosCAD.
3. Click and drag the mouse up to zoom in or down to zoom out. Alternately, use the up and down arrow keys to incrementally zoom in and out.

This tool remains active until a different tool is clicked.

Scale to Fit tools

 Click the **Scale to Fit** tool to show the entire workspace at the largest scale possible within the borders of the window. When held down, it activates the Scale to Fit tools flyout toolbar.





Click the **Scale to Fit with Border** tool to put a border around the scaled-to-fit view. The size of the border is configured in **Options > Defaults > Startup defaults > View tools options**.

Pan/Zoom tool



The **Pan/Zoom** tool lets you grab a location on the screen and drag it as desired in Pan mode, or zooms in and out according to the direction you drag (up or down) when in Zoom mode. To use it in Pan mode, click it, click and hold a location on the screen, and drag to the new location. Click the right mouse button or press ESC to exit the tool and return to the previous tool used. The cursor looks like a clenched hand while dragging.

Note: If you use the Pan/Zoom tool in high graphics mode, you must refresh the screen by pressing F2 to re-render the graphics.

To use the Pan/Zoom tool in Zoom mode, click it, click **Zoom** on the Status bar, position the cursor in the desired area, and then drag the cursor up to zoom in or down to zoom out. This tool does not interrupt the tool being used before it was clicked. Click the right mouse button or press ESC to exit the tool and return to the previous tool used.

Press TAB on the keyboard to change between Pan and Zoom modes without clicking their respective option buttons.



To exit the Pan/Zoom tool in either mode, either click the mouse button, press ESC on the keyboard, or activate another tool. The previously-used tool will resume operation.

If you have a three-button USB mouse with a scroll wheel, using the scroll wheel at any time zooms in or zooms out as if you were using the Pan/Zoom tool in Zoom mode. Holding the middle mouse button down and dragging the cursor pans the view as if you were using the Pan/Zoom tool in Pan mode.

View Angle tool



Change the view angle, elevation angle, and roll angle at which you view this design by using the **View Angle** tool. You can set the values using four methods:

1. Enter a degree measurement in the  **Angle**,  **Elevation**, or  **Roll Angle** field and press enter;
2. Select a predefined angle from a list box;
3. Drag a slider to set the value. As you drag the slider, the view changes accordingly.
4. Click and drag inside the drawing window. All three View Angle elements change accordingly. Use the arrow keys to rotate incrementally, or hold down CTRL to change the roll angle with the arrow keys.

Note that this tool does not change the physical location of the designs in the workspace. It only changes how you see the workspace.

Some of the sliders may not be visible if the ArtiosCAD window is not wide enough. Make the ArtiosCAD window wider to show them.

The View Angle tool can interrupt other tools. Click the tool and use it as desired, then either click the right mouse button or press ESC to return to the previously-used tool. This is especially useful when moving or aligning objects as you can change the view to reveal more pick-up or put-down points.

Shown below is a design before the view angle is changed.



Shown below is the design after the view angle has been changed.



You may need to click **Scale to Fit** to reset the view of the design.

Next and Previous View tools

 The **Next View** and **Previous View** tools let you switch between views once you have used the View Angle tool to change the view. ArtiosCAD remembers eight previous views by default, but you can configure ArtiosCAD to remember up to 100 views in **Options > Defaults > Startup defaults > View tools options**. Click **Previous View** to go back to previous views from the most recent view and click **Next View** to go forward to the most recent view from previous views. These two tools interrupt whatever tool was previously active; when the view changes, that tool becomes active again.

These tools are designed to work by allowing you to stack several different views, activate a tool such as the **Move Point to Point** tool, choose a pick-up point in a previous view (or the current view) and then choose a put-down point in the current view (or a previous view).

Rotate View tools



The **Rotate Right** and **Rotate Down** tools on the Rotate View tools flyout toolbar rotate the view by 90 degrees in the specified direction.

Orthogonal View tool



The **Orthogonal View** tool snaps the view to the nearest multiple of 90 degrees on all three view angles. This tool turns perspective off. The picture below shows the view before clicking the tool. Note the values in the view angle fields on the Status bar.

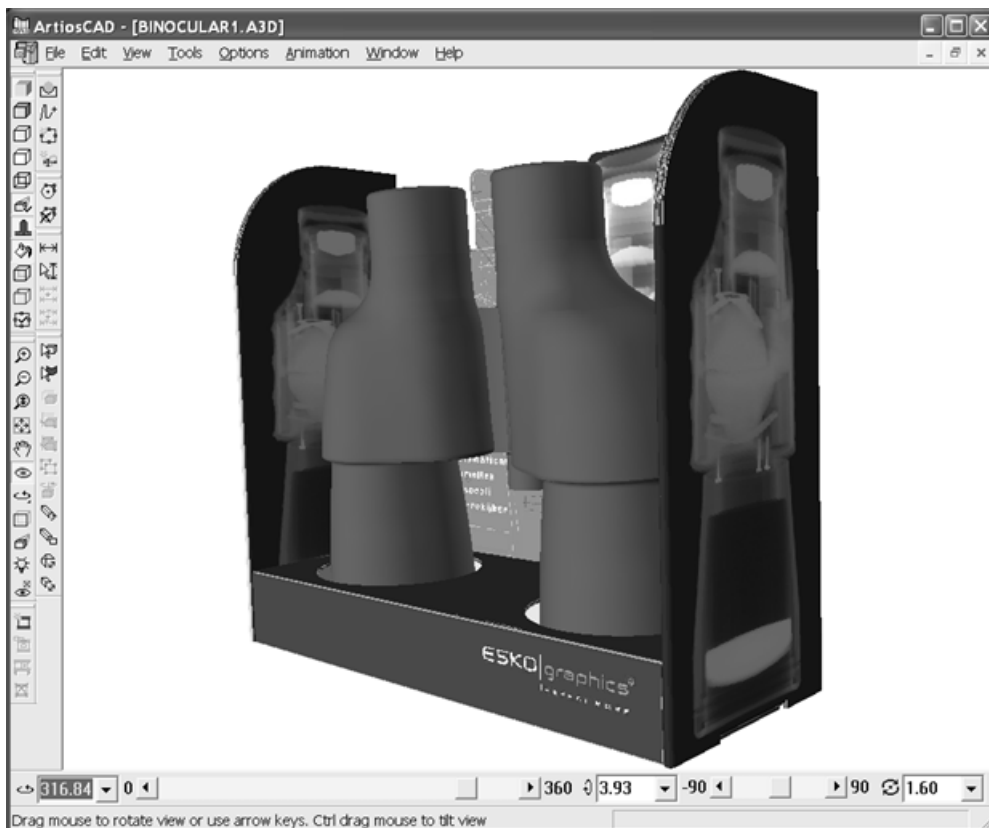

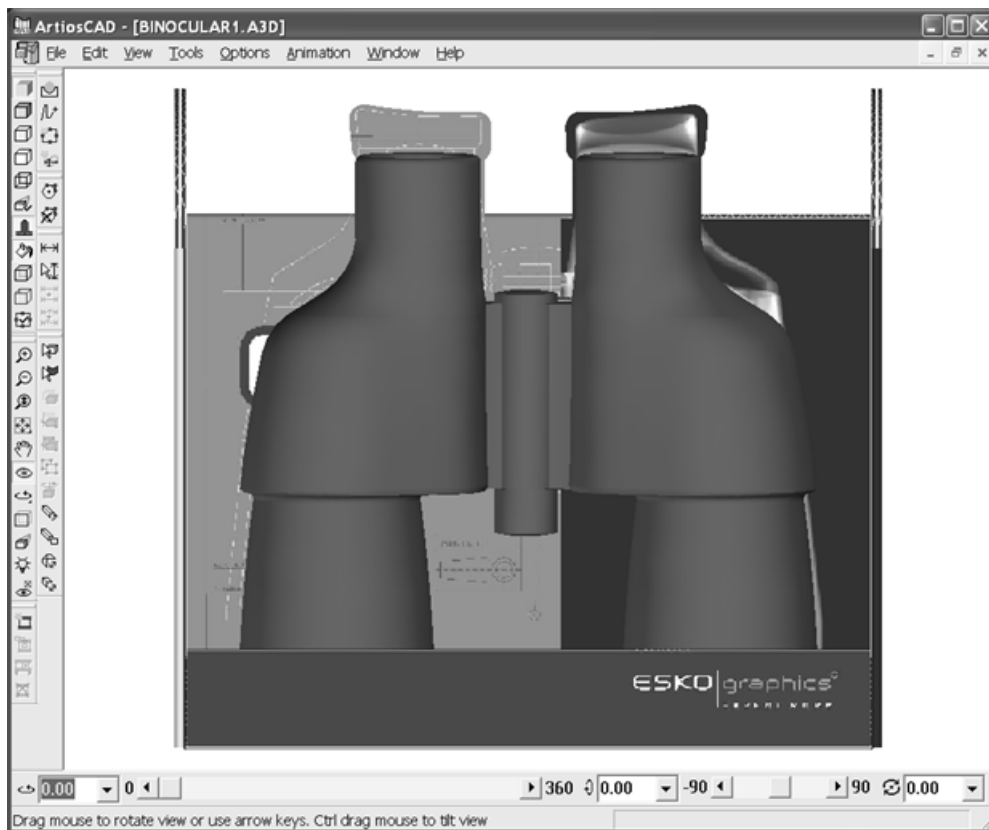

Shown below is the same workspace after clicking the **Orthogonal View** tool.



Note: Boards drawn thinner than 1 pixel may not appear in all orthogonal views when using OpenGL as the rendering method. Change the board thickness or view scale if necessary.

Perspective tool

 *Perspective* is the technique of making parallel lines meet at a point on the horizon in order to make the scene look more realistic. Change the amount or use of perspective using the **Perspective** tool.

1.  Click the **Perspective** tool.
2. To use less perspective, drag the slider to the left. To use more perspective, drag the slider to the right.
3. To toggle the use of perspective, select or clear the **Perspective** checkbox in the Status bar. You can also turn Perspective on or off using the icon on the View Mode toolbar or through the checkbox in the View Mode dialog box.

Shown below is a design using no perspective.



Shown below is the same design using normal perspective.



Shown below is the box with maximum perspective.



Lighting

Light Source tool



The **Light Source** tool lets you add and remove light sources, and also change their positions. The light sources control the shading of the graphics and colors in the workspace. This tool is unavailable in Wireframe view mode. When the tool is active, the Status bar changes to look like the picture below.



If your ArtiosCAD screen is more than 70% of your screen width, the **Brightness** control appears. It affects all the lights. To change just one light, double-click it and use the vertical color brightness slider on the right.



When the tool is started for the first time, three lights appear in the workspace, one in front of the design, one in back of the design, and one above the design. The fill color shows their current color.



The active light has a magenta outline. In the example above, the light bulb near the bottle is the current one. Click a light to select it.

 To add a light, click the **Add Light** tool on the Status bar and then click to set the position of the new light. The new light becomes the active light. Each workspace can have up to eight lights.

 To remove a light, click the desired light to select it and then click the **Delete Light** tool on the Status bar. You cannot delete the last light.

To change the position of a light, click it and drag it to its new position, or use the controls on the Status bar. When dragging a light with the mouse, there is a front position and a back position that correspond with the current cursor position. Drag the light to the left or right edge of the workspace to switch between front and back positions.

To change the color of a light, double-click it, and choose the new color from the standard Windows color selection dialog box. Before you change the color, consider adding the current

color to the list of custom colors so that you may revert to it if desired. The light's custom color is saved with the workspace, but is not saved in the color palette.

Shown below is the same workspace, with the first picture showing a light source beneath and behind the designs, and the second picture showing two additional light sources above and in front of the designs.







Light Source Tool Defaults

You can set default colors and placement of the light sources in the **Light Source** tool. This information is also saved in the 3D workspace so that if someone opens the design on another system, the light source(s) appear as you intended if that person has his/her Defaults set to use the settings saved in the file.

If you close a 3D workspace while you still have its associated single design workspace open, or use **Update 2D**, ArtiosCAD saves the light source information in the single design workspace in addition to saving it in the 3D workspace.

Setting Light Source Defaults

To set the defaults for the Light Source tool, do the following:

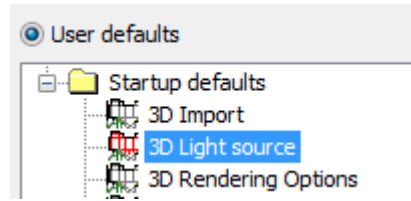

1.  Create a 3D workspace and use **Light Source** to arrange the lights and their colors as desired.
2.  Click **Save lights default** on the Status bar. This saves the current lights configuration to the Startup defaults catalog in User Defaults.



Copy that entry to Shared Defaults if desired. However, you cannot change its contents inside Defaults; you must do that while working in a 3D workspace.

Getting Light Source Defaults

To restore the Light Source settings in a workspace to their defaults, do the following:

1.  Open the 3D workspace and click **Light Source**.
2.  Click **Get lights default** on the Status bar. This resets the workspace's current Light Source settings to the defaults.

Default Settings for Light Source Defaults Behavior

When you restore a 3D workspace, ArtiosCAD normally uses the Light Source settings saved in the workspace. However if you would prefer to always use your own settings, change the settings in the **Light source on open *.A3D** and **Light source on convert to 3D** groups in the **3D View mode** entry in the Startup defaults catalog.

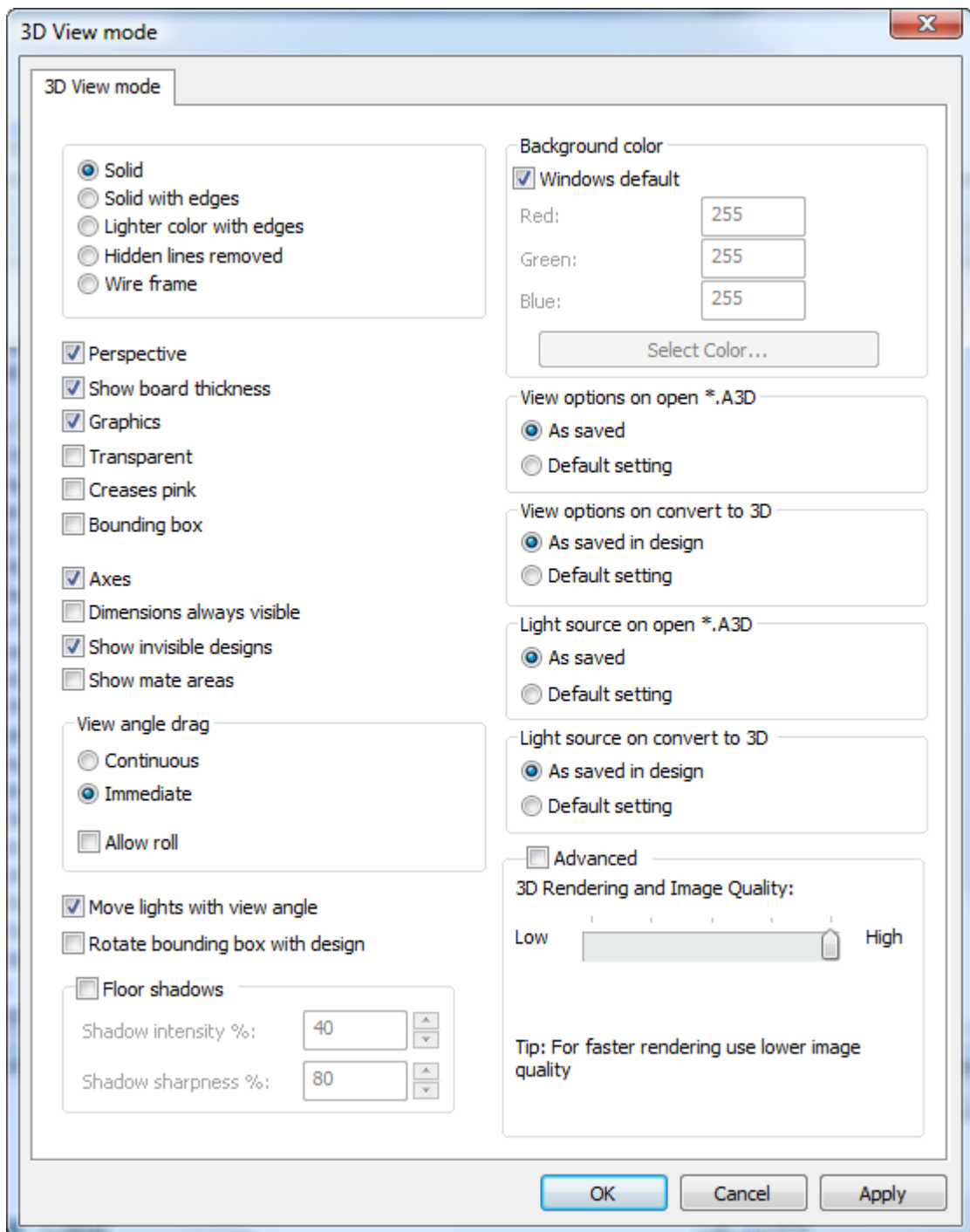

Ambient light

Ambient light is the default light that suffuses a workspace that is not provided by a light source. To change it, click **View > Ambient light**, and choose the new color. Before you change the color, consider adding the current color to the list of custom colors so that you may revert to it if desired. The custom color is saved with the workspace, but is not saved in the color palette.

Ambient light has low contrast. The light bulbs of the **Light Source** tool have much more contrast.

Status bar

The status bar displays various messages and tool controls. When you position the mouse pointer over a tool button, for example, a short description of the tool appears at the left end of the status bar. The middle portion of the status bar returns a status message about the action just completed. For example, if you click the Move Designs or Rotate Designs tool, you will be prompted at the left end of the status bar to select a line and then an axis. After you select a line or axis, the right portion of the bar shows what was selected.



Setting the View mode



The View mode controls many aspects of how designs are viewed in 3D. Click **View Mode** on the View menu or click the button on the 3D View toolbar.

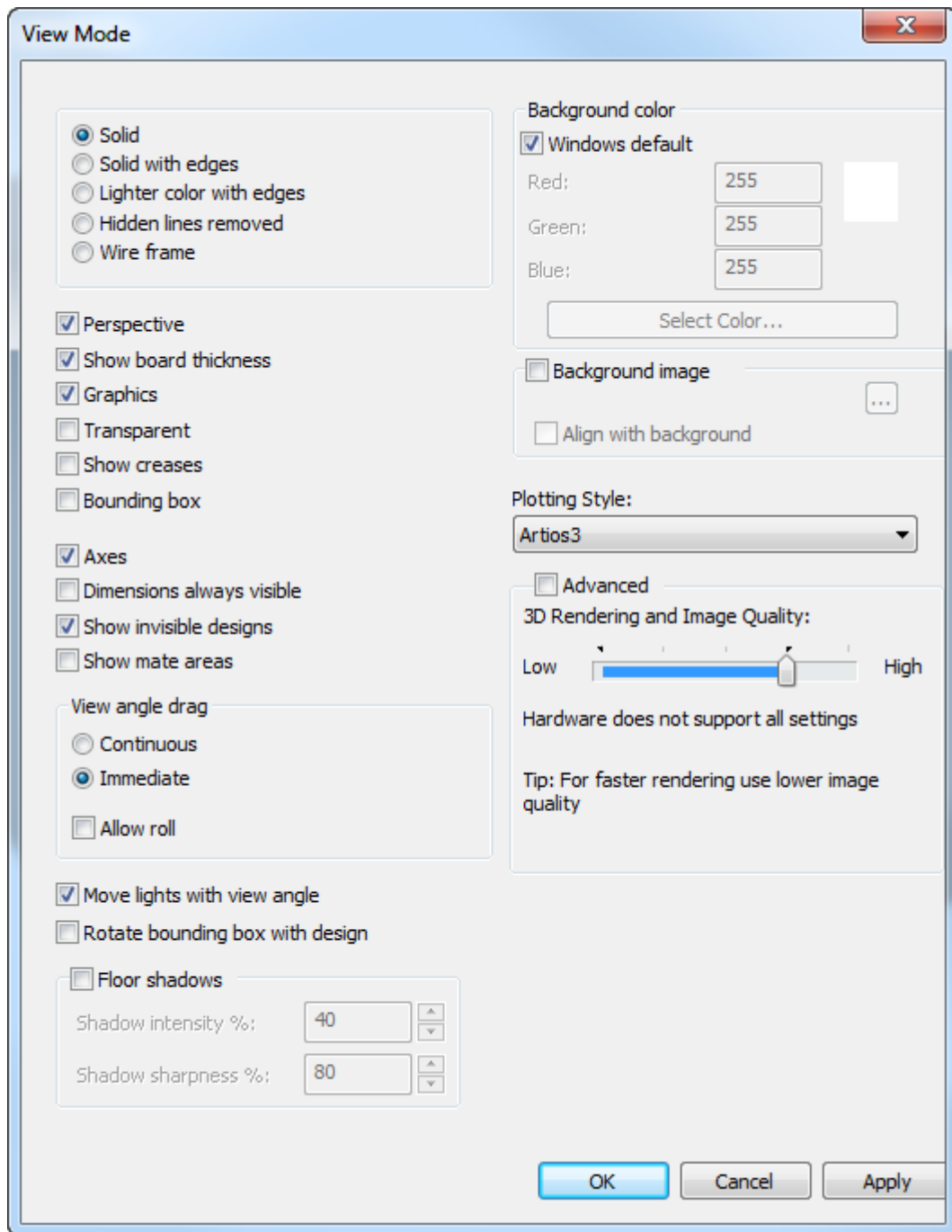

Many of the option buttons and checkboxes on the left side of the dialog box are duplicated by tools on the View Mode toolbar. The topmost or leftmost tool is **Solid**, the next is **Solid with edges**, and so on.



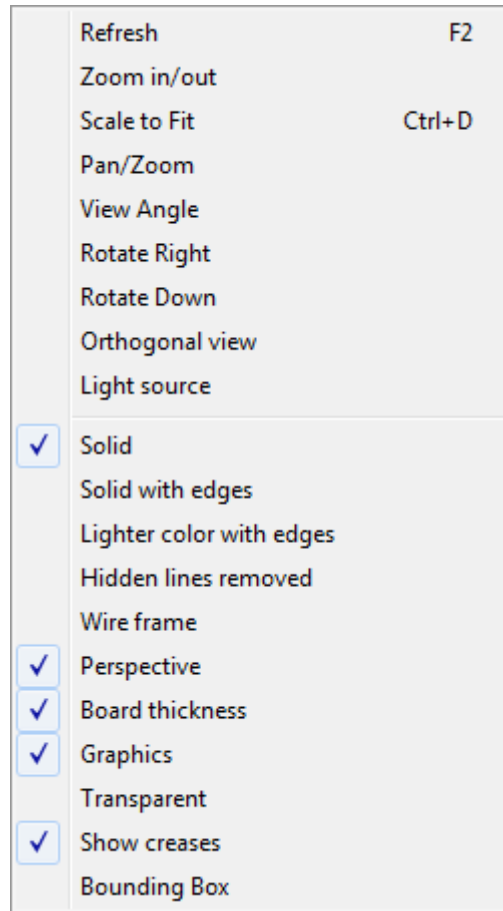

Many of the same commands are also available on the context menu when the cursor is not over an object and the right mouse button is clicked:



 **Solid** displays designs and solids as if they were photographed.



 **Solid with edges** draws black lines on the edges of the designs. The colors of the lines are set by the plotting style. If the design is very complex, you may receive a warning about rendering the design, and ArtiosCAD will prompt for a confirmation.

 **Lighter color with edges** enhances the contrast by lightening the color of the designs. If the design is very complex, you may receive a warning about rendering the design, and ArtiosCAD will prompt for a confirmation.

 **Hidden lines removed** turns all designs white with black edges and no graphics. Solids in the workspace are displayed normally unless Graphics is turned off. If the design is very complex, you may receive a warning about rendering the design, and ArtiosCAD will prompt for a confirmation.

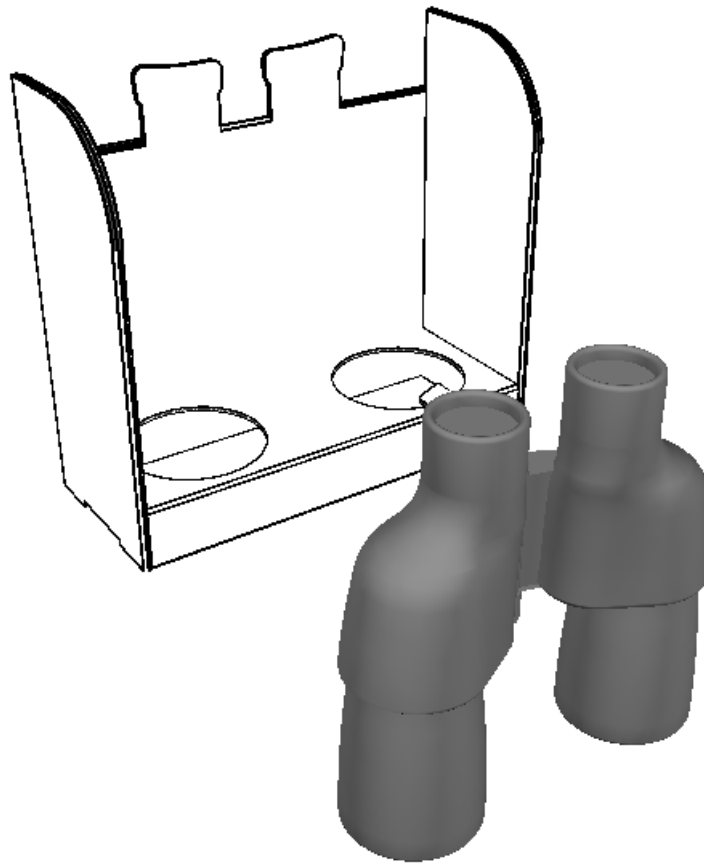

 **Wire frame** shows outlines of the designs and solids in the workspace. Design lines are drawn according to the plotting style. The color used for the wire frame for a solid is defined by the color of the solid, except that if the solid is white, the wire frame is gray.

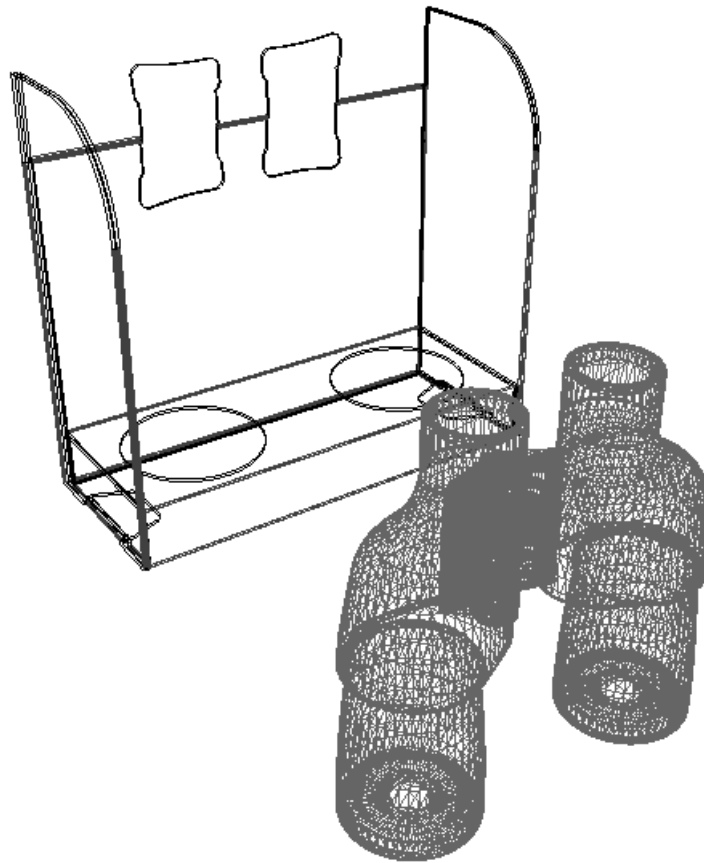



 **Perspective** controls whether parallel lines meet at a point on an imaginary horizon.

 **Show board thickness** shows the board thickness. **Graphics** must also be turned on to see corrugations.

 **Graphics** shows or hides graphics on designs and solids. It also controls the display of corrugation on board edges if **Show Board Thickness** is turned on.

 **Transparent** turns the objects in the workspace partially transparent so that formerly hidden portions become visible. The appearance of transparent objects depends on the order in which ArtiosCAD draws them.

 **Show creases** shows creases in red, perfs in blue, and partial cuts in purple for easier viewing. When this option is turned off, creases, perfs, and partial cuts are the same color as the board.

 **Bounding box** turns the bounding box around all objects on or off. The bounding box provides points for picking up and putting down.

Axes controls whether or not ArtiosCAD displays the X, Y, and Z axes in the lower left corner of the design window. The X axis is red, the Y axis is green, and the Z axis is blue. The axes move appropriately as you change the view angle.

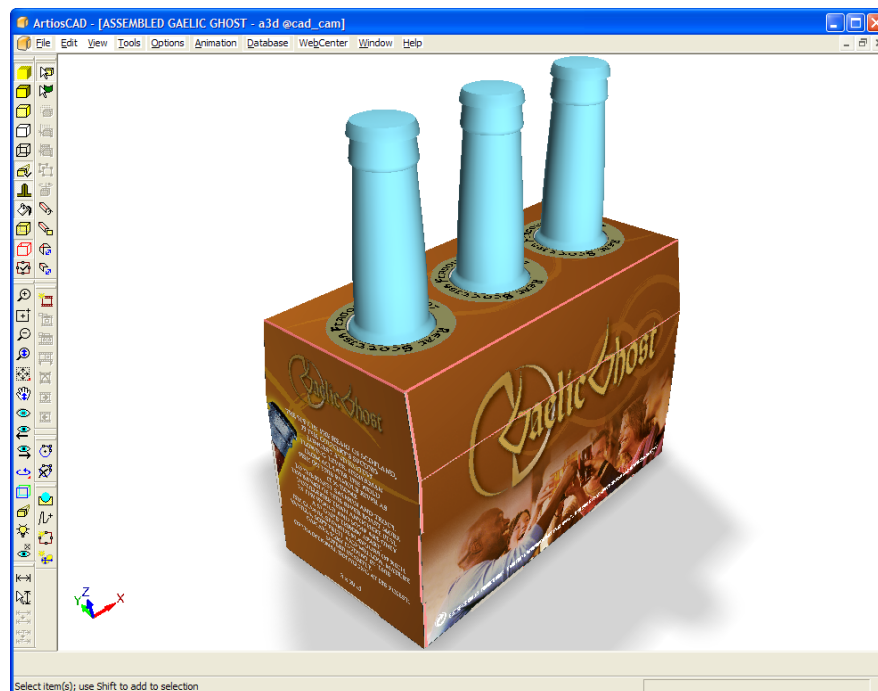

Dimensions always visible controls if dimensions hidden behind objects (such as boxes) are shown or not. The checkbox is off by default. JPG and PNG exports use this setting; VRML export does not as dimensions are not exported to VRML.

Show invisible designs controls whether or not objects set to be invisible are shown with 90% transparency or not shown at all.

Show mate areas turns on or off the rectangles that indicate areas that connect to each other automatically.

In the **View angle drag** group, **Continuous** describes the view angle continuing to change even when the mouse is not moving. **Immediate** stops changing the view angle when the mouse stops moving.

Allow roll turns rolling with the mouse on and off.

Move lights with view angle allows you to disconnect the lights from the view angle. It is checked by default - the lights move with the view angle. Clear this checkbox to not have the lights move with the view angle.

Rotate bounding box with design causes bounding boxes to rotate with a design when you rotate it. This makes moving and aligning boxes at an angle easier.

 **Floor shadows** turns the floor shadow on and off. **Shadow intensity %** controls how dark the shadow is; use a lower number for a lighter shadow and a higher number for a darker shadow. **Shadow sharpness %** controls the fuzziness at the edge of the shadow. Use a lower number for a more diffuse edge and a higher number for a sharper edge.

Note that the shadow uses the light sources defined in the workspace, not the light pictured in an optional background image.

When moving or rotating designs, the floor shadows remains static during the drag, and are updated when the tool finishes.

When using a floor shadow, the light source angles are limited to at least 60 degrees so that the shadows do not get too long. If the light source is at less than 0 degrees, and no other light sources are defined, no shadows are made.

Turning on the floor shadow turns on perspective. Turning off perspective turns off the floor shadow.

Windows default in the **Background color** group sets the background color of the workspace to the color defined by the Display Properties control panel. When it is deselected, the **Red**, **Green** and **Blue** fields become available, as does **Select color**. Enter values from 0 to 255 in the fields provided, or click **Select color** and choose the desired color from the Color dialog box.

Background image sets a background image for the workspace. **Align with background** lets you align the workspace with the background image. See the next section for more information about using this feature.

To change plotting styles, choose a new plotting style from the **Plotting Style** drop-down list box.

 The Performance slider, also known as the **3D Rendering and Image Quality** tool, exists both as a button on the View Mode toolbar and as a group within the **3D View Mode** dialog box.

Clicking the toolbar button opens a small dialog box next to the toolbar button:

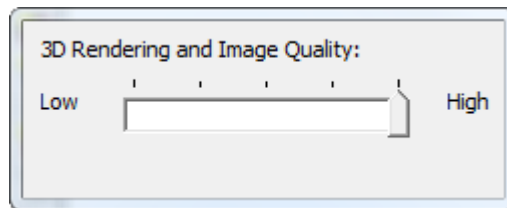

In the **3D View Mode** dialog box:

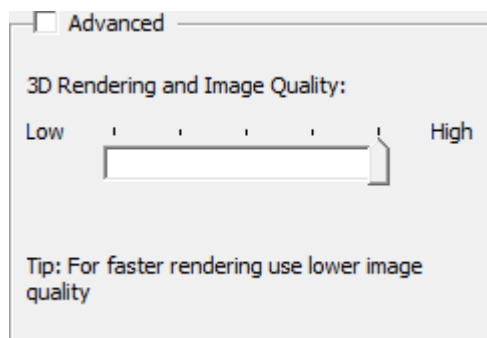

The **Low** end of the slider represents faster performance at the expense of image rendering quality, while the **High** end represents better image quality at the expense of slower performance. If you try to snap to a setting that your computer cannot do, the slider will bounce back and a status message will appear on the Status bar. The toolbar icon indicates the current slider level as a green mark.

There may be a blue indicator in the slider field that shows the settings that your computer can accept.

Tick	Graphics resolution	Number of samples
1	Low	0
2	Medium	0
3	Medium	4x
4	High	8x
5	Maximum	16x

The settings between the two ends of the slider mix the advanced settings of graphics resolution and number of samples, which are discussed in the following topic. For example, if the design has no graphics on it and the display adapter supports 16x sampling, the slider can move to all the way to **High**. Conversely, if the design has many graphics and the display adapter can support large internal bitmaps, but with no support for smooth edges, the slider can still go to **High**. To determine the exact settings supported by your system, click **Advanced** and use the drop-down list boxes to list the available modes.

Set the default state of the items in the View Mode dialog box by clicking **Options > Defaults > Startup defaults > 3D View mode**.

Advanced mode

In the 3D View Mode Dialog box, when you check the **Advanced** checkbox in the **3D Performance and Image Quality** section, the slider is replaced by the **Graphics resolution**, **Image filter**, and **Smooth Edges** drop-down list boxes, along with the **Reduce gaps in edges** checkbox.

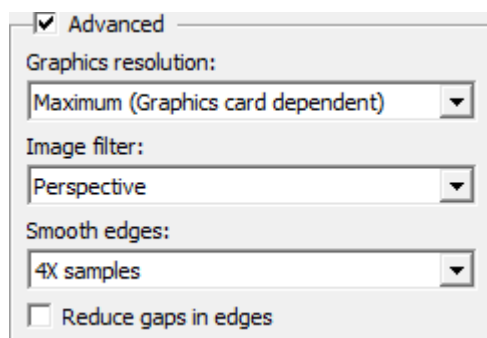

Graphics resolution

Note:

The following discussion refers to the size of bitmaps that the display adapter can create in its internal memory. It does not refer to the size of bitmaps it can display on the monitor.

Note:

The quality of the graphics is limited by the quality of the original graphic files placed into the workspace. If the original graphics were low resolution or otherwise low quality, ArtiosCAD cannot improve them.

The **Graphics Resolution** drop-down list box has four settings which may or may not appear depending on the abilities of the display adapter.

Selected resolution	Overall bitmap pixel size
Low	1024 x 1024
Medium	2048 x 2048
High	4096 x 4096
Maximum	4096 x 4096 per panel or label

For designs, when you select the setting that is the highest your computer can render, the next higher setting causes ArtiosCAD to split the overall graphics into a bitmap per panel at the highest resolution possible. For solids, ArtiosCAD creates one bitmap per label or graphic.

For example, if the display adapter only supports 2048 x 2048 bitmaps, the best selection in the drop-down list box will be **High**. Because this is one level above what the display adapter supports, the graphics will be split into one graphic per panel for a design or label/graphic for a solid.

Note:

If present, a background image is unaffected by this setting and always uses the highest resolution possible.

Image filter

The **Image filter** drop-down list box has three values:

- *Nearest*. Nearest point filtering has been the standard image filter for 3D. It offers sharp edges but blocky results.
- *Linear*. This image filter blurs and blends the pixels together for a smooth look, but some sharpness is lost.
- *Perspective*. This image filter is similar to linear filtering but it compensates for the slope of the object upon which the graphics appear. This method requires more resources than the others so it may impact performance.

Note:

If a background image is present, these options affect its quality.

Smooth edges

The choices on the **Smooth edges** drop-down list box control how ArtiosCAD draws the edges of objects. ArtiosCAD reads each pixel on the edge of a polygon read several times in different places and combines the readings to give the best result, which is called Multi-Sample Anti-Aliasing.

The list in the drop-down list box shows the values your display adapter supports. The values range from **No samples** to **16X samples**, which means each edge pixel is sampled 16 times. The greater the number of samples selected, the longer the render will take.

Note:

Bitmap Outputs do not use smooth edges algorithms.

Reduce gaps in edges

The **Reduce Gaps in Edges** checkbox in the **Advanced** group of the 3D View Mode dialog box controls how ArtiosCAD displays visible vectors in 3D. When this checkbox is checked, **Hidden Line Removal**, **Solid With Edges**, and **Lighter Color With Edges** view modes all look smoother and better. This option also affects Outputs of type **Bitmap**.

Note:

Reduce Gaps in Edges is enabled by default but is not used if there is a solid in the 3D workspace.

Without **Reduce Gaps in Edges** checked:

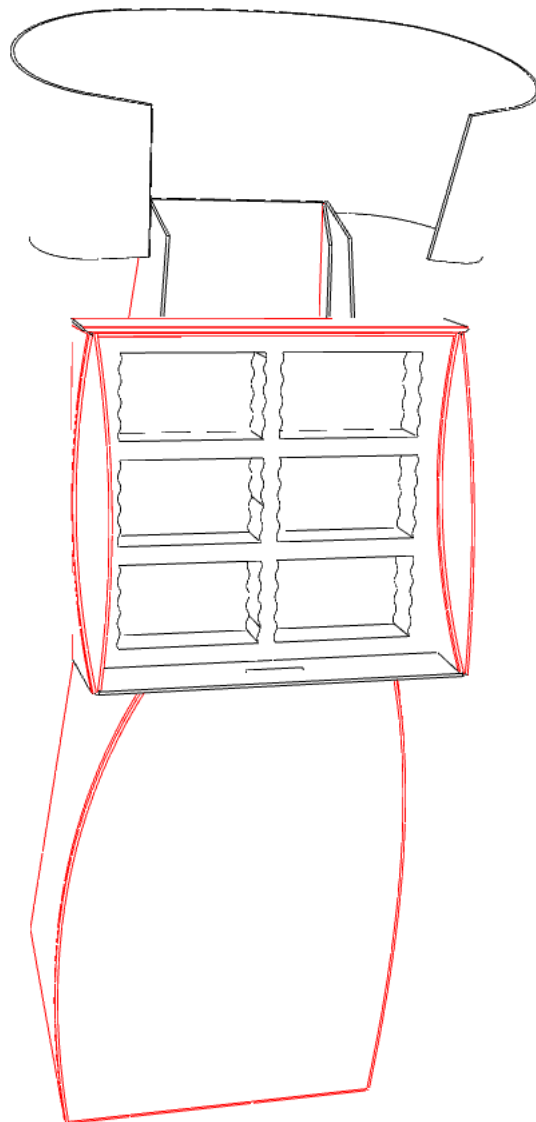

With **Reduce Gaps in Edges** checked:

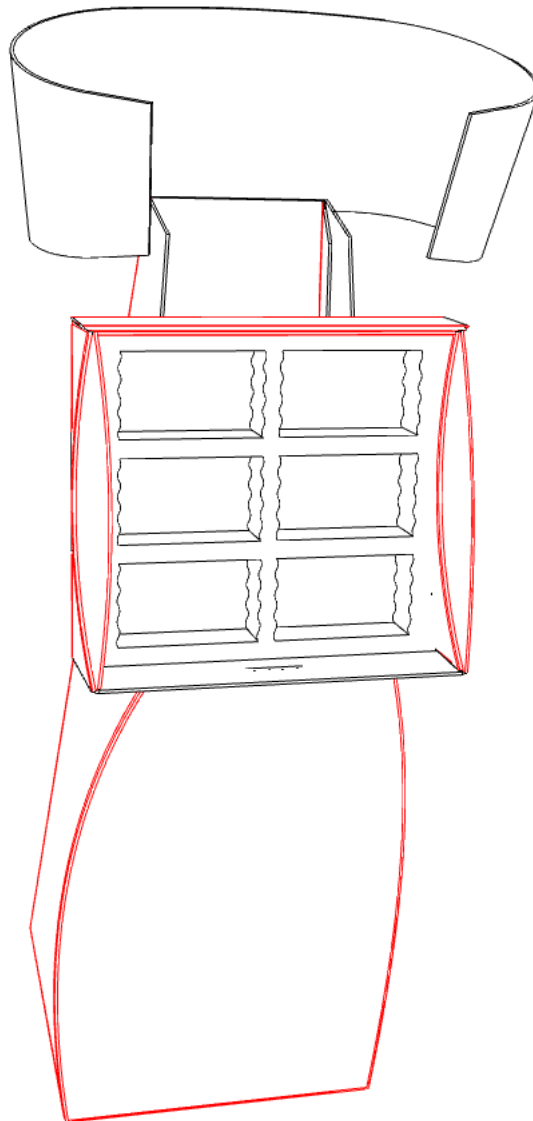

Using a freehand background image

The **Background image** group in the View Mode dialog box lets you set a background image for the 3D workspace. You can either position the design against the background freehand, or you can use the **Align with background** command on the View menu, which is documented in the next section.

Using a background image significantly increases the time it takes to display the workspace. Therefore, position the scene as close as possible to the desired result before adding or turning on a background image. It helps to view the background image first in an image-viewing application to determine the scene before executing it in ArtiosCAD. Also, using Direct3D instead of OpenGL as the rendering method may lead to more robust performance.

To use this feature in freehand mode, do the following:

1. Position the objects in 3D as close as possible to the end result.

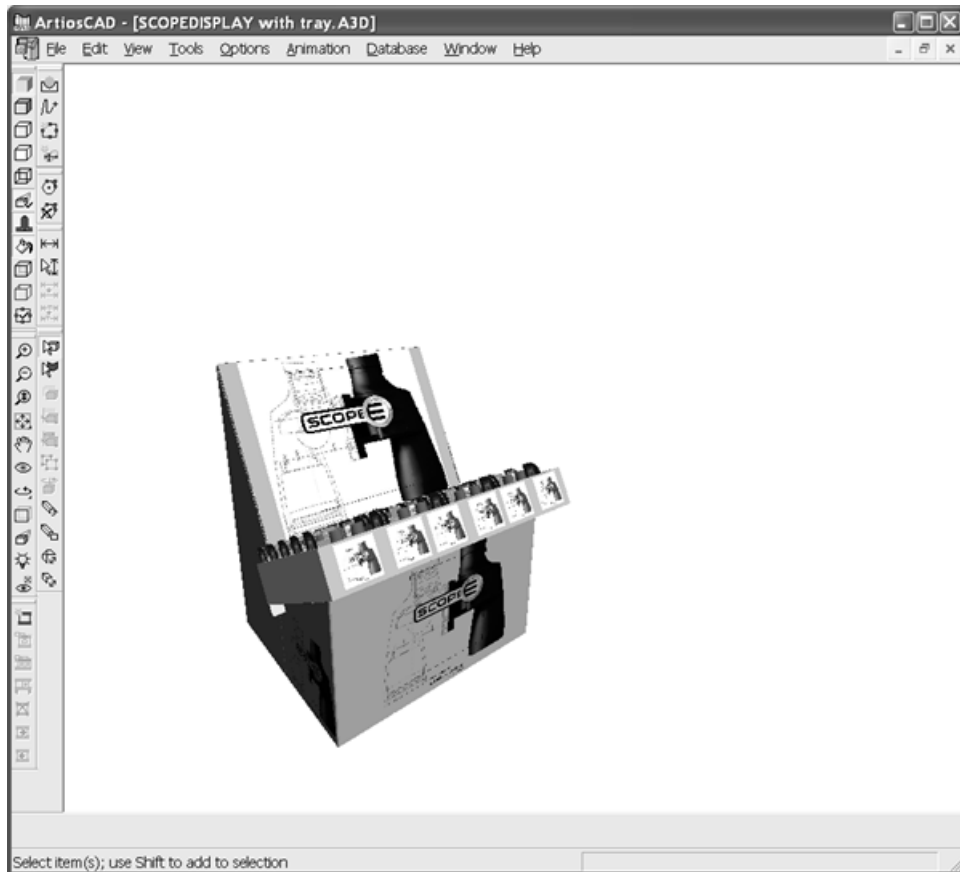

2.  Click **View Mode**, and then click ... (Browse) in the **Background image** group.
3. Navigate to the folder containing the desired image file, select it, and click **OK**. PDF and Adobe Illustrator .AI files may not be used as background images.
4. Click **OK** in the View Mode dialog box to turn on the background image. The background image is centered to match the height of the image with the size of the window. If the image is wider than the window, it is clipped on both sides; if the image is narrower than the window, white space appears on either side of the image.
5. Use the **View Angle**, **Zoom In/Out**, **Pan**, and **Perspective** tools to adjust the position and rotation of the workspace against the background image. You may also use the **Move** and **Copy** tools but their performance will be impacted by having the background image turned on. The background image itself may not be moved. Shown below is a 3D workspace with background image.

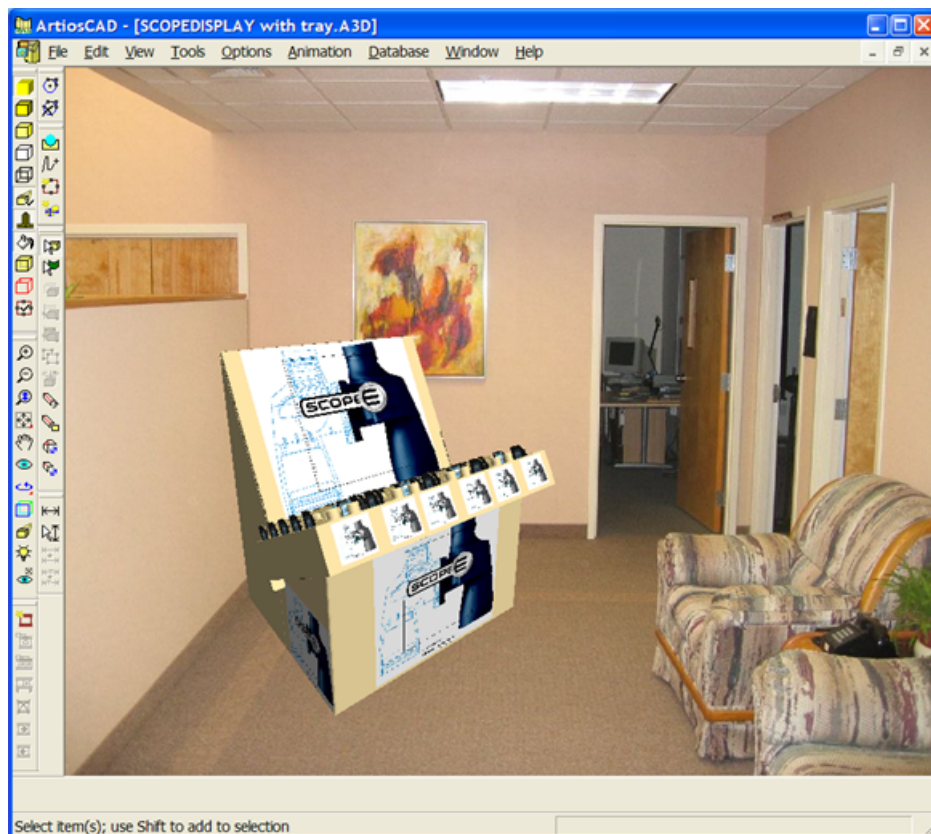

Note: The complexity of the workspace, size of the background image, and 3D rendering method all affect system performance. Bear these in mind when composing the scene. Direct3D may perform somewhat faster than OpenGL on some systems.

To choose a different background image, choose a new image file in the View Mode dialog box as explained in steps 2 through 4.

The background image is saved as part of the 3D workspace.

The background image and floor shadow do not appear in CloseUp windows.

Using an aligned background image

Aligning a background image with a 3D workspace involves indicating a rectangle on the floor of the image (assuming you are using a picture of a place) and then entering the size of that rectangle. This tells ArtiosCAD how to set the vanishing point for the perspective in the workspace.

The **Align With Background** tool aligns the longest X/Y dimension of the bounding box of the designs with the longest dimension in the background image.

To use a background image and align the workspace with it, do the following:

1. In ArtiosCAD, assemble the complete workspace.

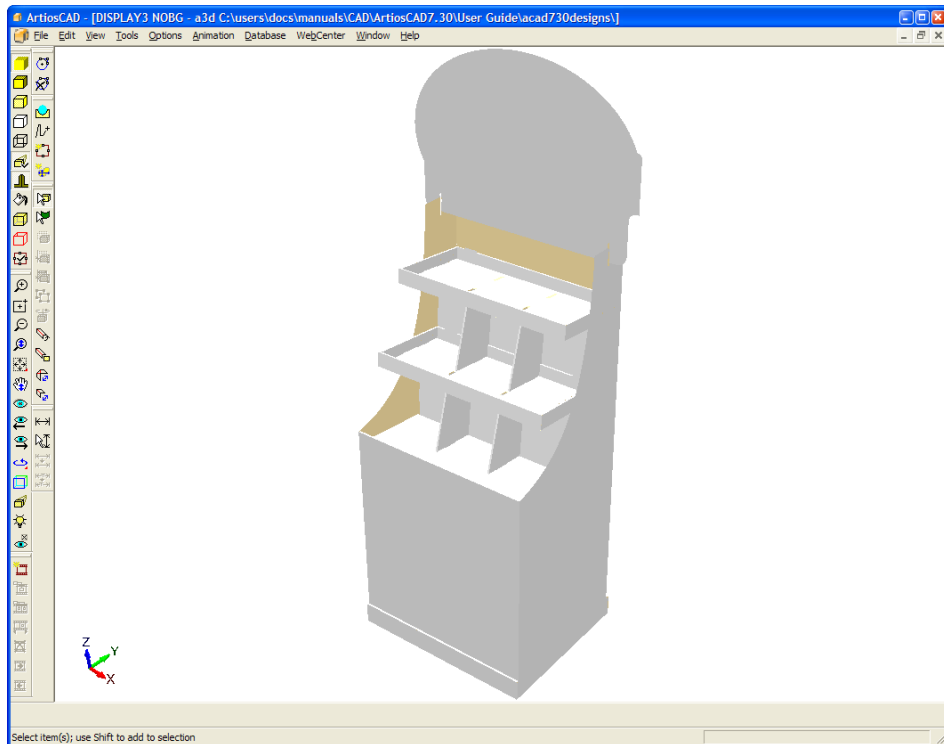

2. View the background image in an image-viewing application and decide upon the scene.
3.  Click **View Mode** to open the View Mode dialog box.
4. In the View Mode dialog box, select the **Background image** checkbox, and use the ... (Browse) button to select the desired image.
5. In the View Mode dialog box, click **OK**. The background image appears in the workspace.

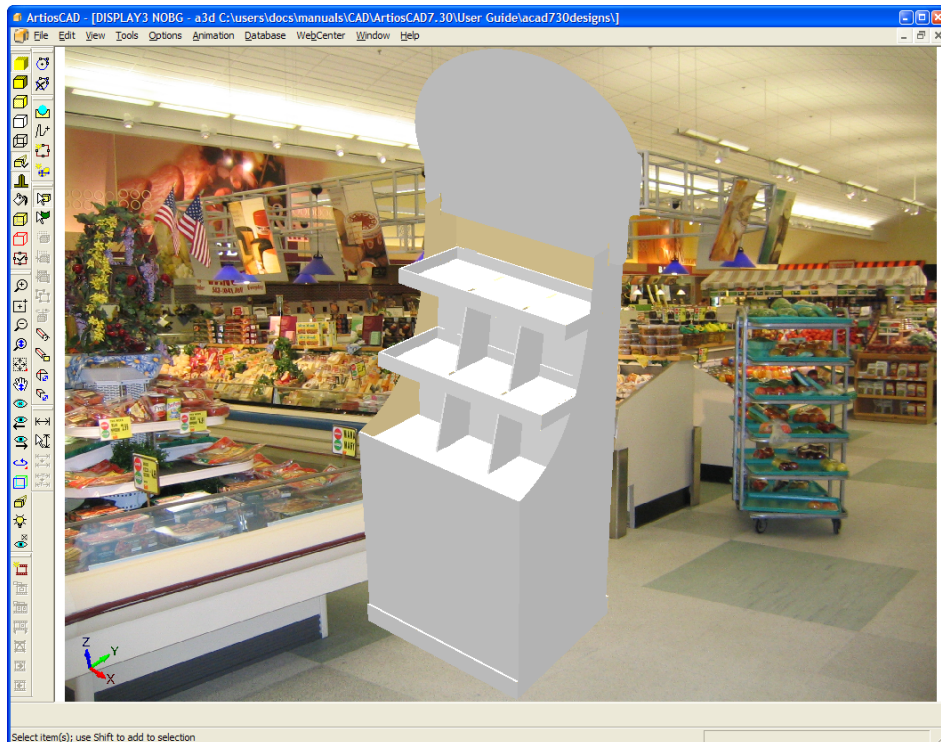

6. Click **View > Align with background**. The Align With Background Options dialog box appears.

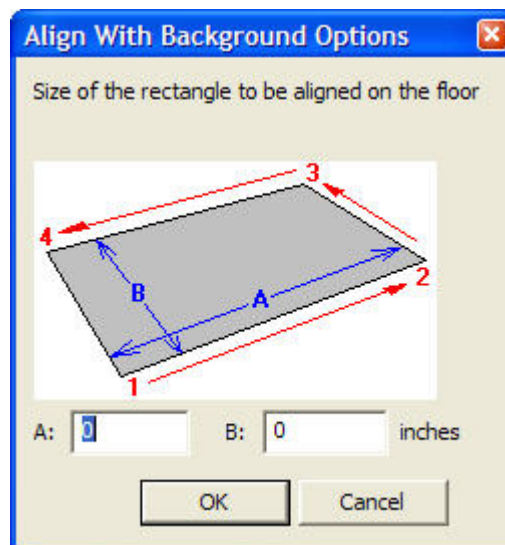

7. The picture in the dialog box shows the order in which to click the corners of the alignment rectangle in ArtiosCAD to set its position. In the fields, enter the longer dimension of the rectangle in the **A:** field and the shorter dimension in the **B:** field. Using a rectangle with a definite proportion between length and width works better than a squarer rectangle. Also, the line formed by points 1 and 2 should go across the front of the designs in the workspace for best results.
8. Click **OK** in the Align With Background Options dialog box. The 3D workspace will be turned off temporarily to show the entire background image.

- Click the points of the rectangle in order. Click the lower left corner, then the lower right, then the upper right, and finally the upper left. ArtiosCAD automatically adds the line from the last corner to the first corner. If you make a mistake, click the **Undo** button on the Status bar. Shown below is the setting of the second corner.

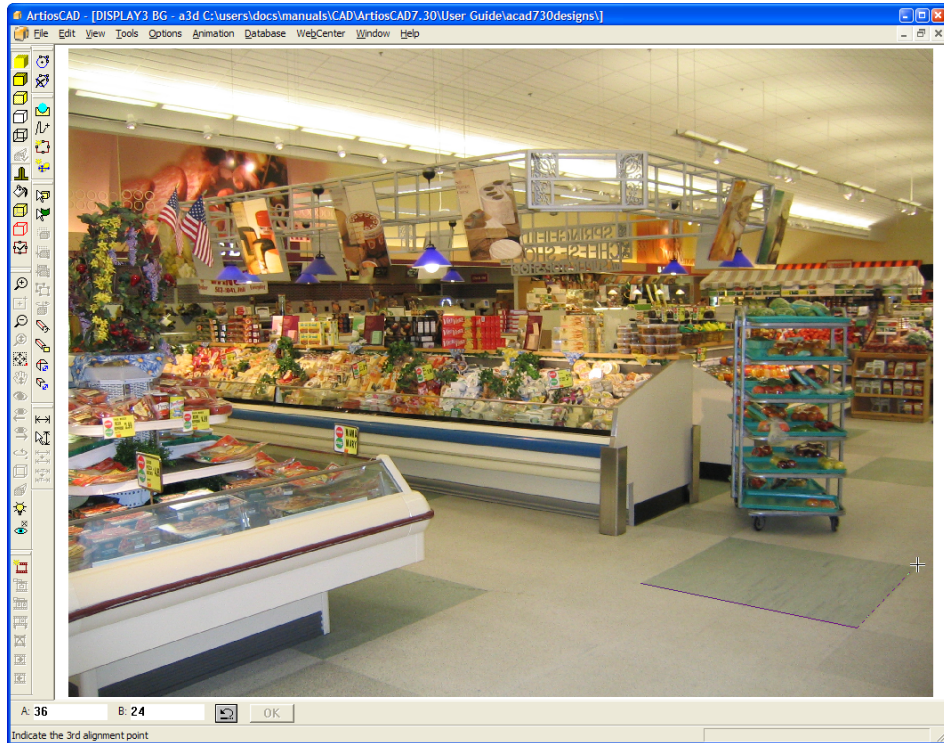

- You may zoom as needed using the **Zoom In**, **Zoom Out**, and **Scale to Fit** tools. Larger alignment rectangles generally yield better results than smaller ones. Precise alignment is critical, as differences as small as a pixel can greatly affect the position of the vanishing point. Shown below is a zoomed-in view in which you can see that the right edge of the rectangle is a few pixels off; that can be corrected later in the process.

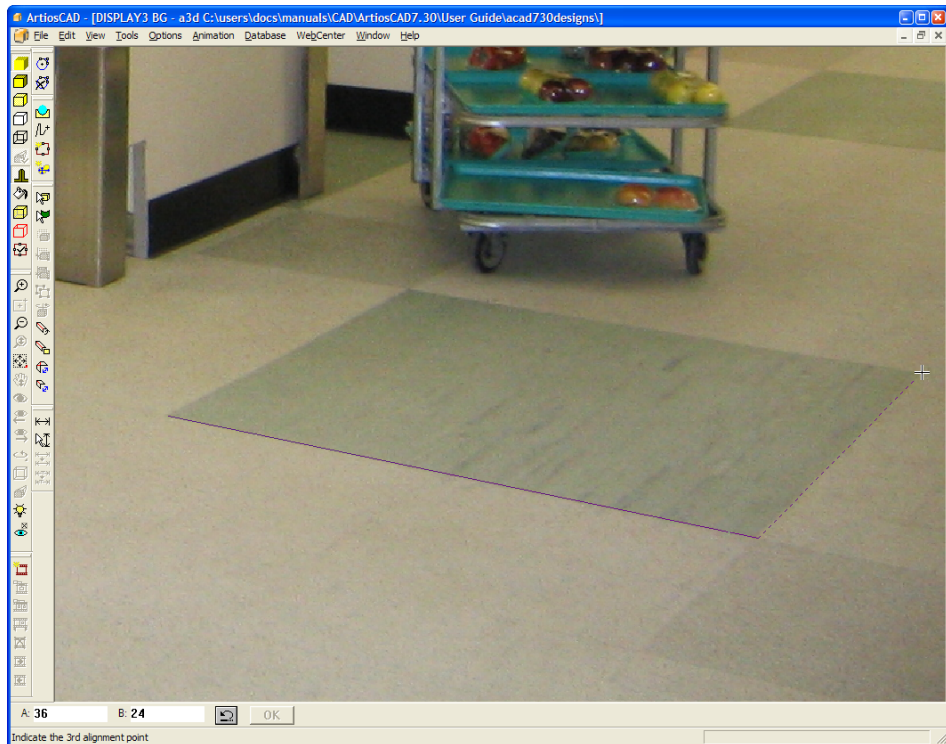

11. Once the rectangle is drawn, you can click a corner and drag it as needed to adjust it. Shown below is an adjustment for emphasis;

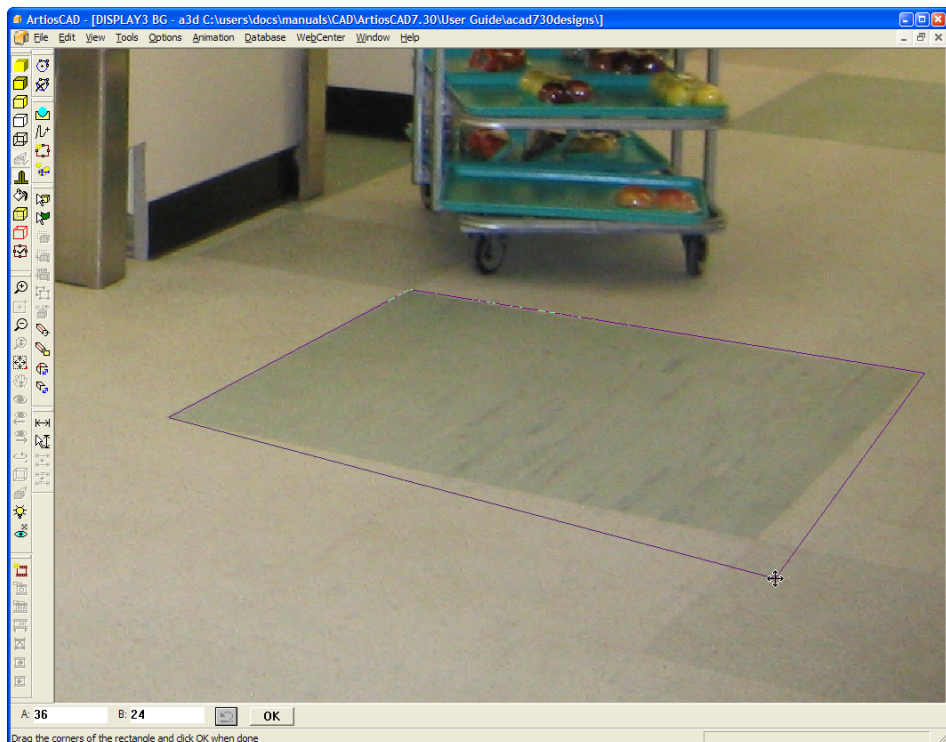

12. When you are satisfied with the size and position of the alignment rectangle, click **OK** on the status bar. The 3D workspace will be turned back on and aligned inside the alignment rectangle as shown below.

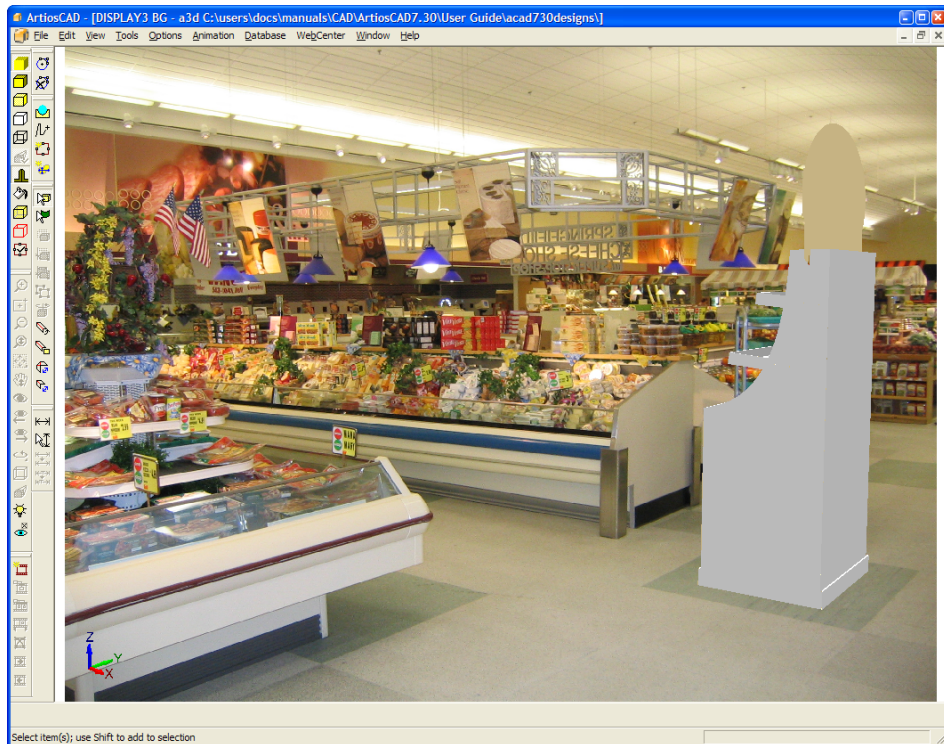

13. ArtiosCAD is now in **Align with background** view mode. In this mode, the **View Angle**, **Zoom**, **Scale to Fit**, and **Pan** tools are unavailable in order to not lose the alignment with the background. Use the **Move** and **Rotate** tools to further align the workspace objects against the background.
14. If desired, turn on the floor shadows in the View Mode dialog box and use the **Light Source** tool to adjust the position of the light sources to change the shadows.
15. Shown below is the completed image.

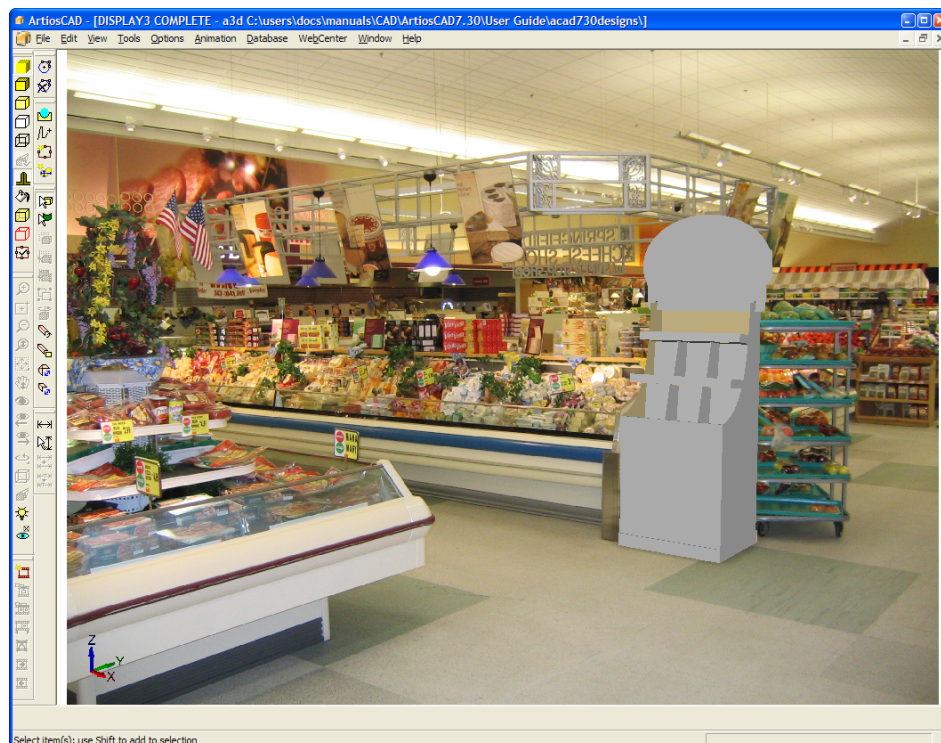

16. To exit **Align with background** mode and make the View Angle, Zoom, Scale-to-Fit, and Pan tools active again, click **View Mode** on the toolbar and deselect **Align with background**.

Note: Once you change the view, the alignment with the background is lost, and you will have to repeat the entire procedure to realign the background with the workspace.

Note: Wide-angle images from digital cameras may suffer from fish-eye lens distortion at their edges. In this case, the alignment of ArtiosCAD's perspective with the background image perspective will be less accurate, with the error becoming larger as the design is moved further from its original placement.

Outputs using background images

JPEG and PNG outputs include the background image at the same aspect ratio as shown in ArtiosCAD.

VRML output includes the background image as a rectangular object positioned behind the designs and grouped with the toolbar (if it is selected for output as well).

Animations with a background image using the Scale to Fit feature for captured frames may zoom in and out when output to VRML. The background image stays the same size when the animation is played in ArtiosCAD. Combining use of the Scale to Fit feature in an animation, using a background image, and exporting to VRML may lead to unpredictable results.

VRML viewers may perform more robustly with background images when set to use Direct3D instead of OpenGL.

VRML outputs containing a background image also contain two extra rectangles for proper image placement. These extra rectangles may appear in other programs when opening the

VRML file. To avoid this situation, before outputting a VRML file, turn off the background image in the View Mode dialog box, and then in the VRML dialog box, do not select **With toolbar**.

Level Designs tool

Use the **Tools > Level Designs** tool to make a design look level on the floor when it has no horizontal base face.

To use the **Level Designs** tool, do the following:

1. Create or open a 3D workspace that has no horizontal base face. For example, this simple display base has no panels that would sit flat on the floor.

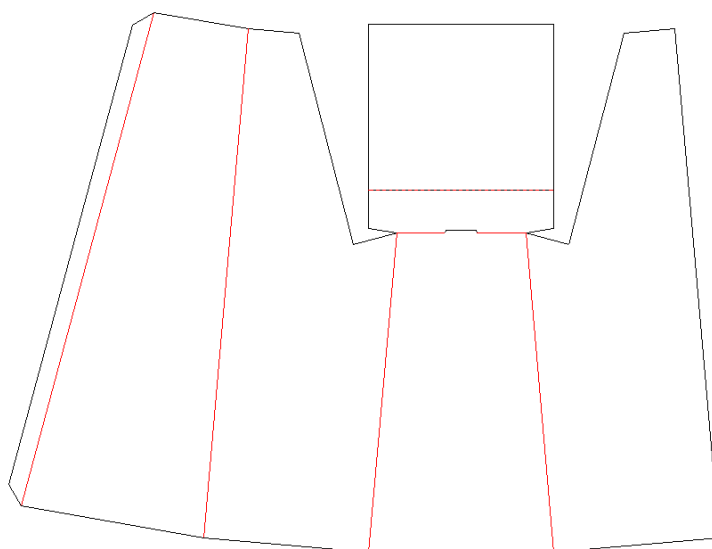

2. Use the back as the base face when converting to 3D.

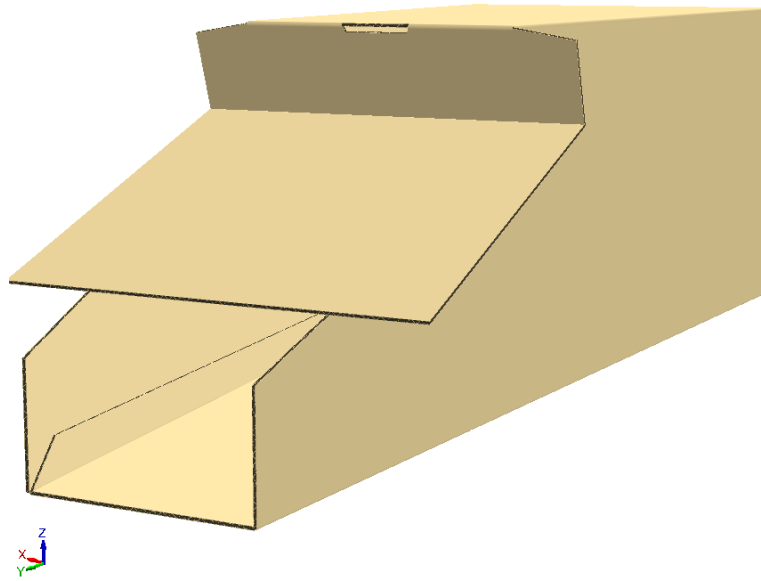

3. Rotate the design so that it is close to upright.

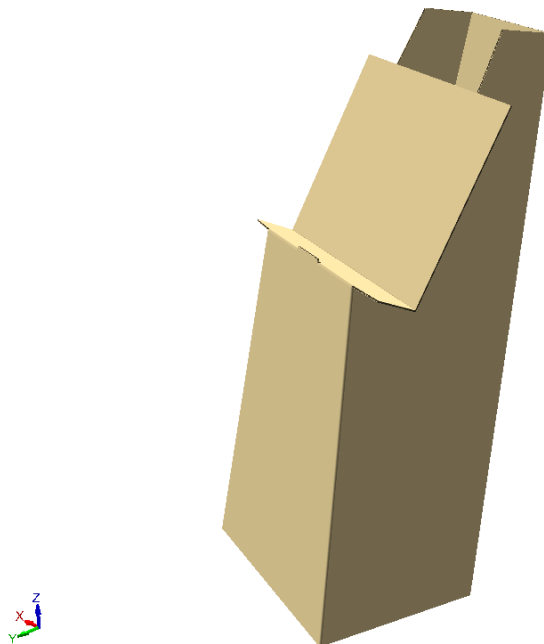

4. Click **Tools > Level Designs**. ArtiosCAD changes the orientation to make the display look more level.

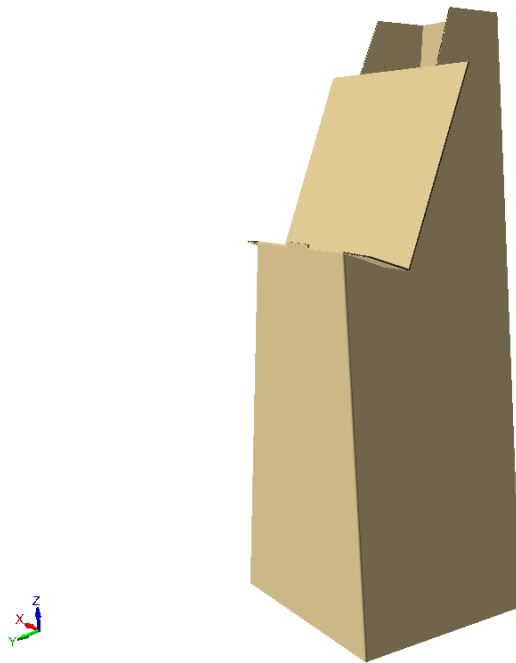

Changing visible properties of objects in 3D

To change the colors of objects in 3D, double-click them with the appropriate Select tool to open the Properties dialog box for the type of object. To select more than one item to change at once, hold down CTRL while clicking to select items.



Use the **Select Designs** tool and double-click a container to change its properties.

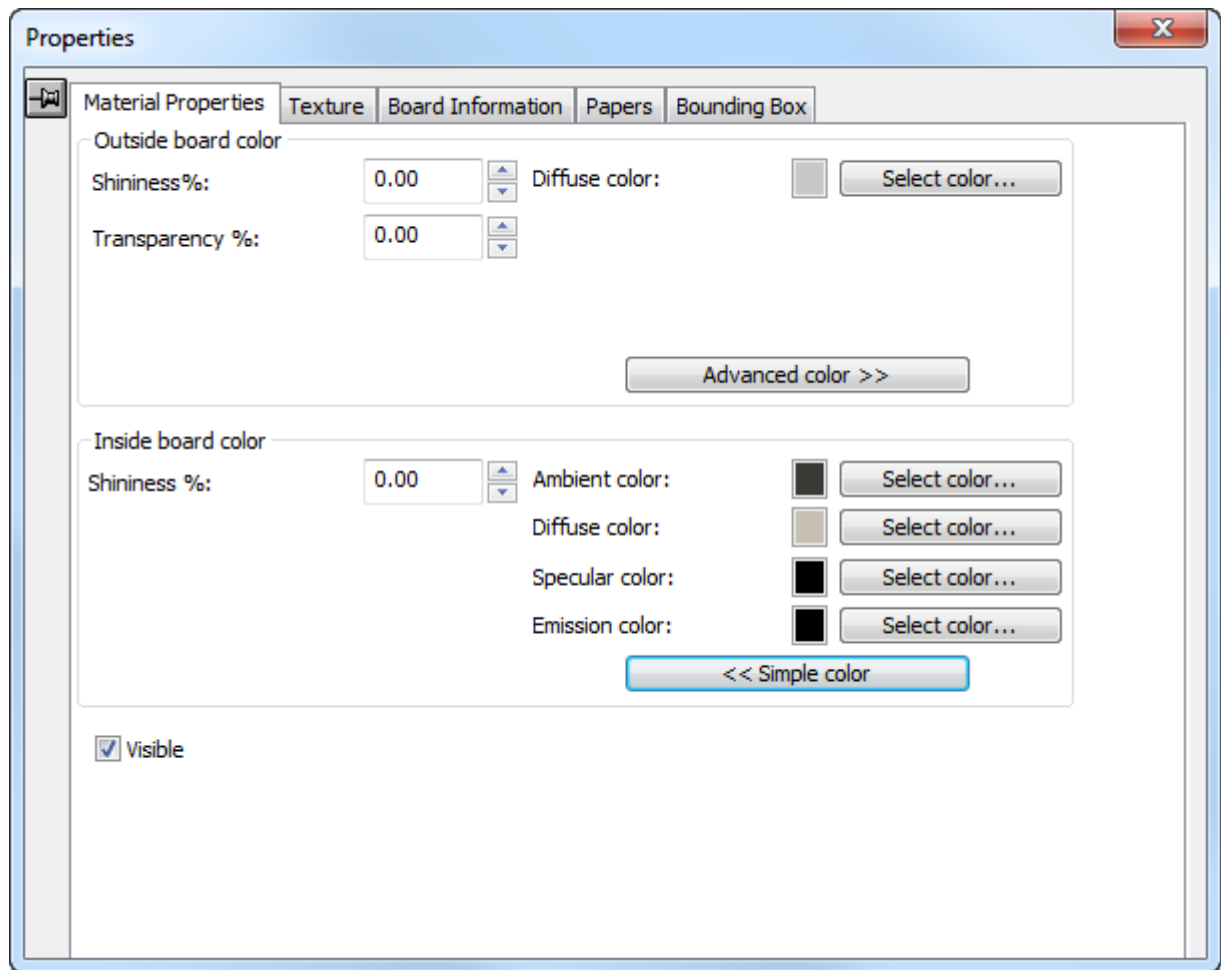

The **Shininess %** and **Transparency %** fields help to simulate different materials. Shininess is most visible on round objects; it has little effect on flat objects such as containers. Transparency of the board works independently of the **Transparent** checkbox in the View Mode dialog box. Use the values in the table below to approximate common objects.

Table: Common Amounts of Shininess and Transparency

Material	Shininess	Transparency
Matte board	0	0
Glossy board	40	0
Beer bottle	90	50
Glass	100	80

Surface colors are split into four components: **ambient** color, which reflects the ambient light; **diffuse** color, which reflects the movable lights in an airy, non-shiny way; **specular** color, which reflects movable lights for a shiny surface, with a shiny surface having a white specular color

and a dull surface a black specular color; and **emission** color, which is the color the object emits.

By default, the Material Properties dialog box only displays Diffuse color in Simple color mode. In Simple color mode, choose a color by clicking **Select color**. To set the other three colors, click **Advanced color**, and then click **Select color** as desired. You may only set a CMYK color for the Diffuse color in Simple color mode.

Visible controls whether the current selection is included in VRML exports and also if it is included when ArtiosCAD calculates the view scale of the workspace. Use this control to turn on and off different elements of your workspace. **Show invisible designs** in the View Mode dialog box controls whether invisible designs are shown at 90% transparency (when visible) or not at all (when invisible). If any part of a design is visible, the entire design is visible; the visibility of the part affects the visibility of the whole. Visibility can be set independently for each design at the start of each animation frame.

Changes you make in this dialog box are applied as they are made. Close the dialog box by clicking the X at the end of the title bar.



Use the **Select Labels or Parts** tool and double-click a label or part of a solid to change its properties, or to delete selected parts by pressing DEL on the keyboard. You may also click and drag to select more than one item, or hold down CTRL while clicking to select more than one item.

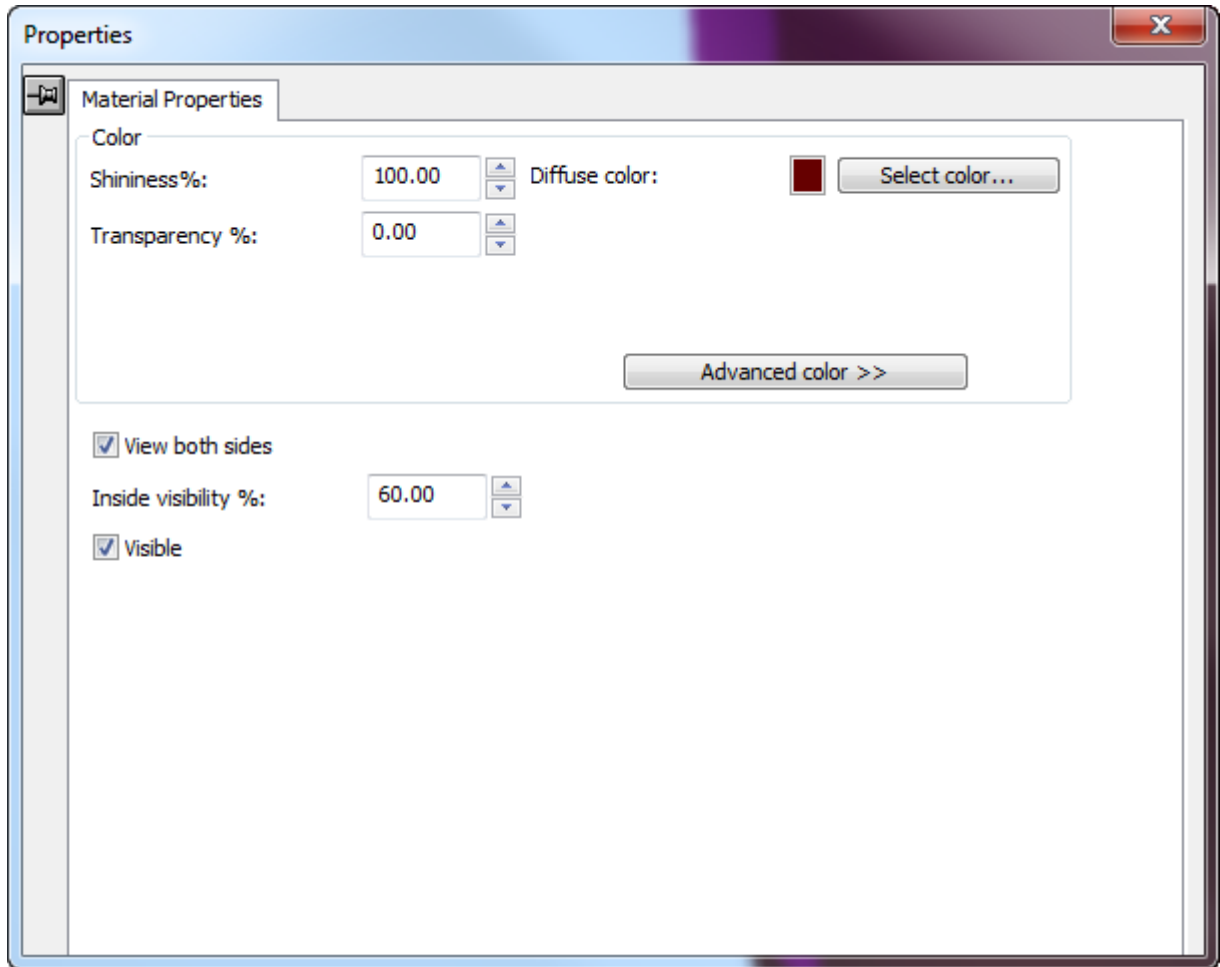

The color controls for a label or parts of a solid work the same way as they do for containers, but there is just one color group. The differences for labels and parts of solids are the **View both sides** checkbox and the **Inside visibility %** field.

View both sides shows all facets of a solid so that it is shown correctly. Shown below is a hammer model with **View both sides** turned off.

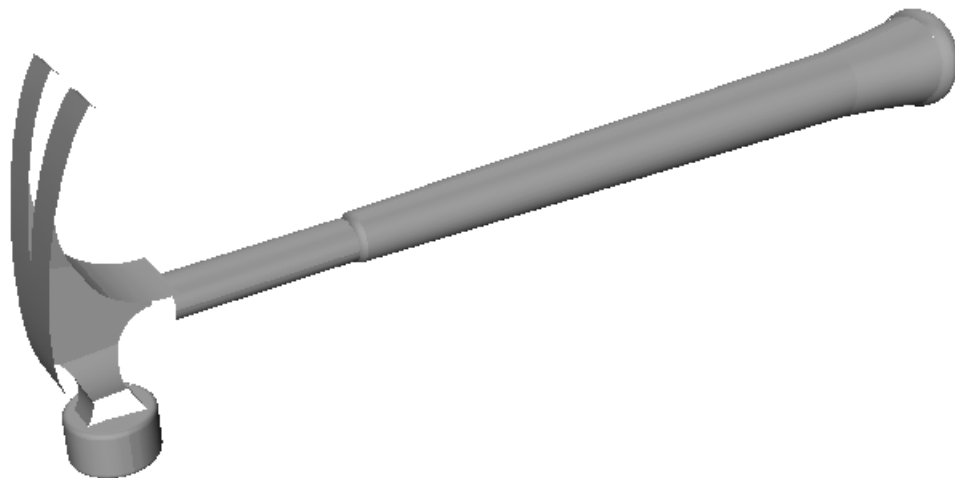

With **View both sides** turned on, the head of the hammer is now complete.

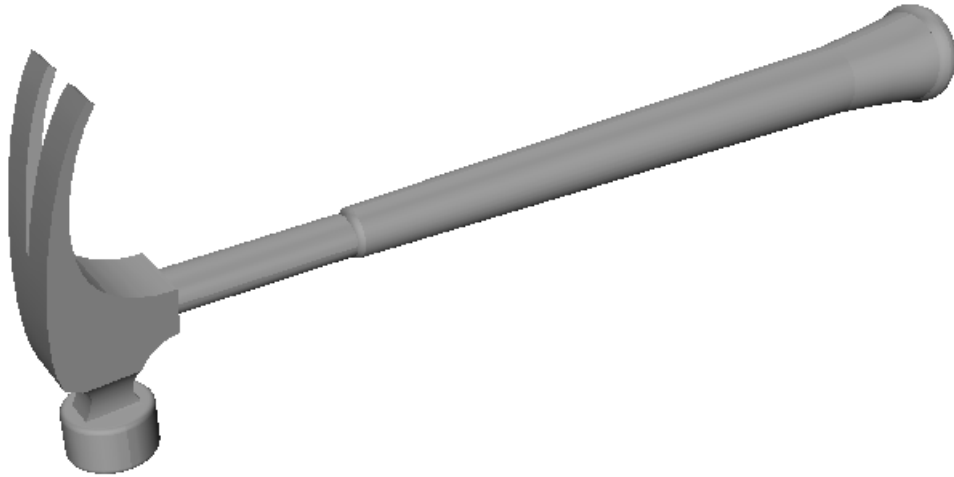

Inside visibility % sets the percentage of labels that show through transparent objects. The label on the bottle below is set to 0% inside visibility.



The same label is now set to 70% inside visibility:



Visible controls whether the current selection is included in VRML exports and also if it is included when ArtiosCAD calculates the view scale of the workspace. Use this control to turn on and off different elements of your workspace. **Show invisible designs** in the View Mode dialog box controls whether invisible designs are shown at 90% transparency (when visible) or not at all (when invisible). If any part of a design is visible, the entire design is visible; the visibility of the part affects the visibility of the whole. Visibility can be set independently for each design at the start of each animation frame.

How to change the board information in 3D

To change the board information dynamically in 3D without changing the board information in the flat workspace, do the following:

1.  Click **Select Designs** and double-click the object to change, or single-click and select the design(s) to change, holding down CTRL to select more than one object.

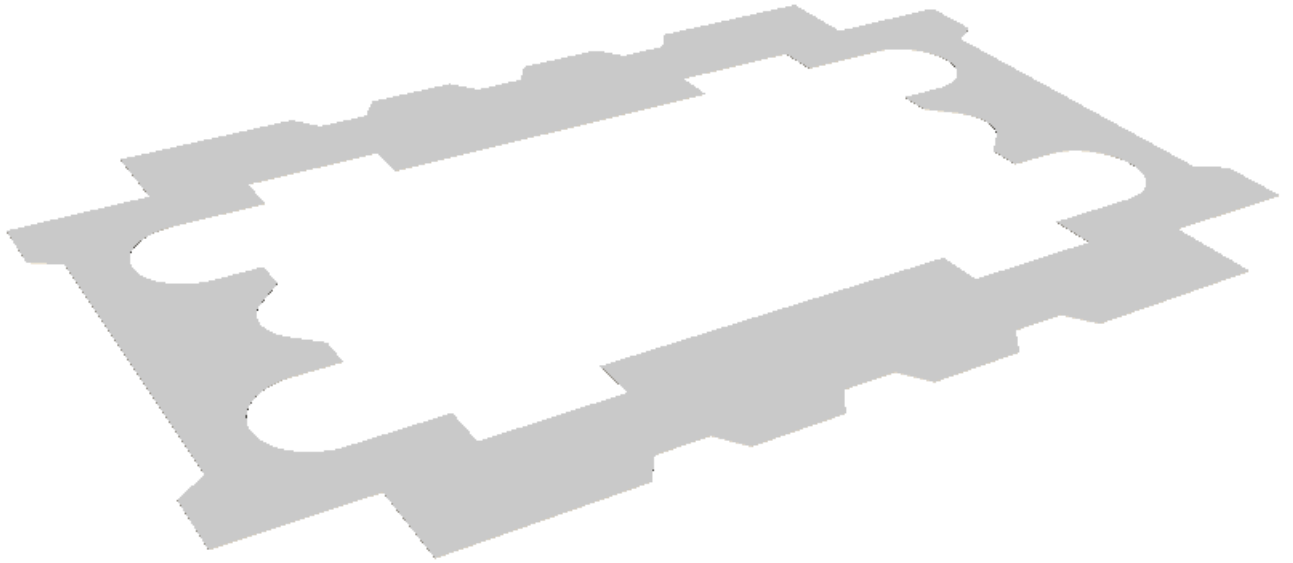

2. If you selected more than one object, click **Edit > Properties**.
3. To change the color, shininess, or transparency of the boards, click the Material Properties tab, and change the values as desired.
4. To change the textures of the board from those defined by the board code, click the Texture tab. Shown below are the textures used for the Orange Urethane Two foam board in the **Artios > Foam catalog**.

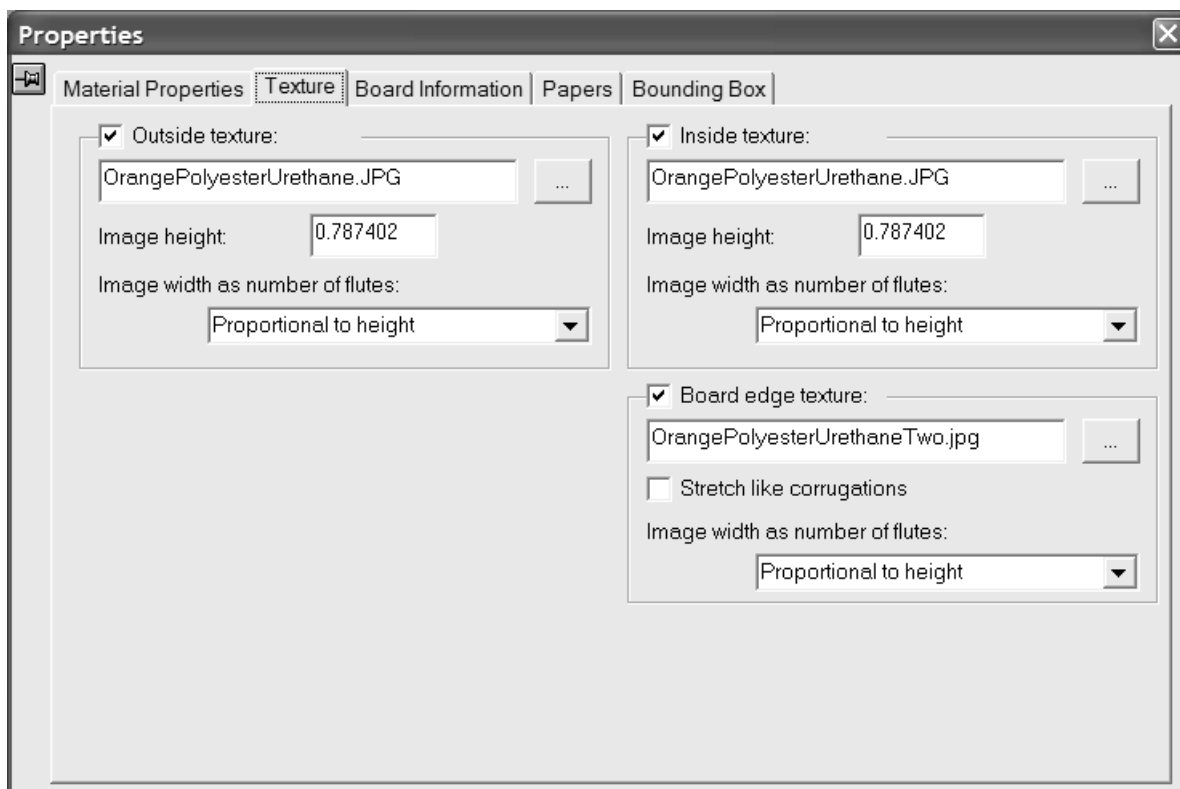

5. To add an inside or outside texture to the board, click the checkbox for it, and then specify the filename of the graphic file for the texture, or click ... (Browse) to the right of the filename field and select it. Some common textures are stored in **\Artios\Common**. The image should be of the board surface with vertical grain or corrugation direction. If you use a custom image, measure the sample when you take its picture so that you know its size; you may need to touch up the image in a graphic editing program so that the edges blend together when the image is tiled.

In the **Image height**: field, enter the height of the image. The size needs to be set in order for ArtiosCAD to scale the picture appropriately. If the height is set to 0, the image will be scaled proportional to the width.

Set the value in the **Image width as number of flutes**: drop-down list box to the number of flutes the image represents. The image should be of a whole number of flutes. It may also be set to **Proportional to height**, in which case the height cannot be set to 0.

To specify a graphic for the board edge texture, check the **Board edge texture** checkbox, then specify the filename of the graphic file for the texture, or click ... (Browse) to the right of the filename field and select it. Some common textures, for example paper corrugated edges, plastic corrugated edges, and paper hexacomb flutes, are stored in **\Artios\Common**. The height of the image for a corrugated board should be the board caliper, and the width should be a whole number of flute pitches. Folding carton boards use an image width proportional to the height.

If no texture is specified for a corrugated board edge, a default picture based on the height and pitch of the flutes is used.

Stretch like corrugations stretches the picture of the board edge texture depending on its angle to the grain/corrugation direction. If this option is not selected, the board edge texture is repeated evenly. This option should not be selected for hexacomb flutes.

- To change the board code, the caliper, or the inside loss measurement of the selected objects, click the Board information tab in the Properties dialog box and change the values as desired. This tab is dynamic and only shows controls for the features that exist in the workspace. Change the value in the **Inside Loss:** field to make small adjustments to the position of the board in 90-degree folds.

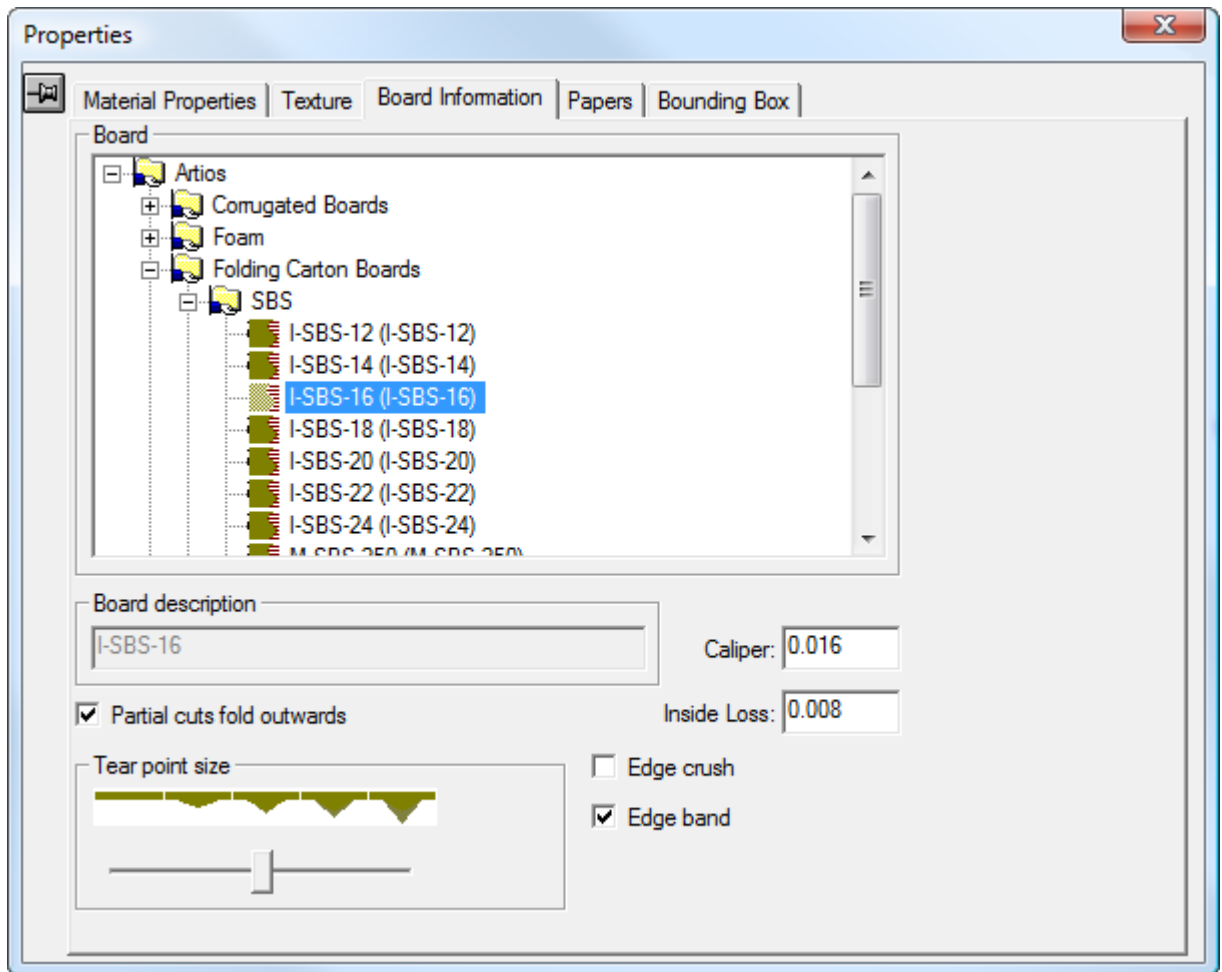

Partial cuts fold outwards specifies the direction in which partial cuts act as creases. They generally fold away from the side of the board in which they were cut. Corrugated partial cuts generally fold to the outside of the container, while folding carton partial cuts generally fold to the inside of the container. If the selected board has flutes defined, this option is checked automatically.

Note:

Select this option to cut V-notches from the print side when using Re-board®. Cutting some V-notches from the inside and some from the outside in the same design is not supported.

Depending on the workspace contents, **Partial cuts fold outwards** can display the **Die Back Side** and **Die Knife Side** option buttons. Checking or deselecting **Partial cuts fold**

outwards changes the option button, and changing the option button selects or deselects the checkbox.

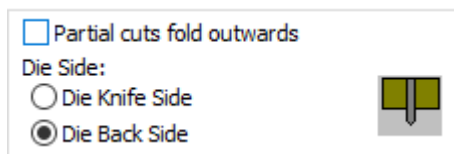

Thin corrugated boards such as E-, F-, N-, and G-flutes may be created as if they were folding carton boards; therefore, depending on your workflow, turn it off if selecting one of those boards.

Use the **Tear point size** slider to adjust the appearance of tear points for perf in 3D.

Edge crush, when enabled, renders a rounded edge on cuts about half a millimeter wide that represents the beveled edge of cut rules. It is always shown for perfs between parts that tear, but you can control its appearance for other lines with this option.

Edge band toggles the display of edge band rule.

Click the Papers tab to view the details about the papers comprising the board. No fields on this tab may be changed; they are for reference only.

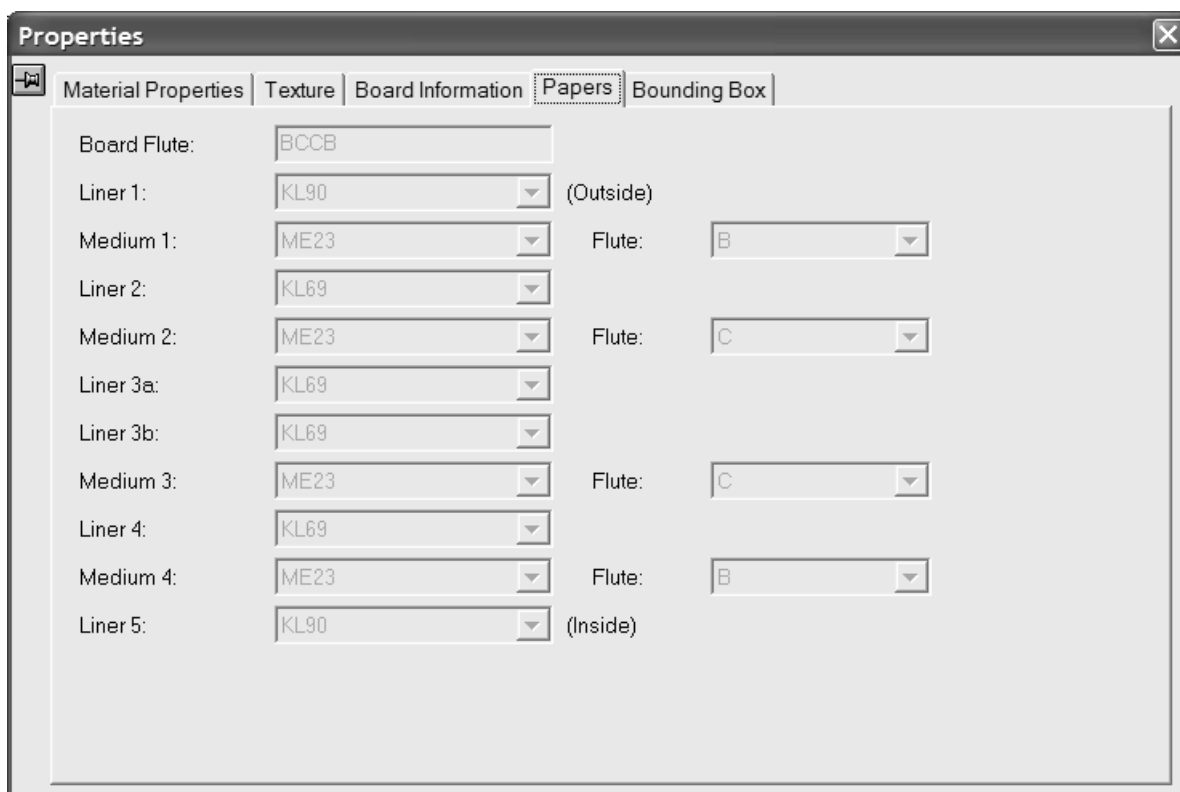

Click the **X** in the upper right corner of the Properties dialog box to make any changes and close it.

7. The changes made will occur immediately. If board thickness was not turned on, it will be turned on when a new board is chosen.

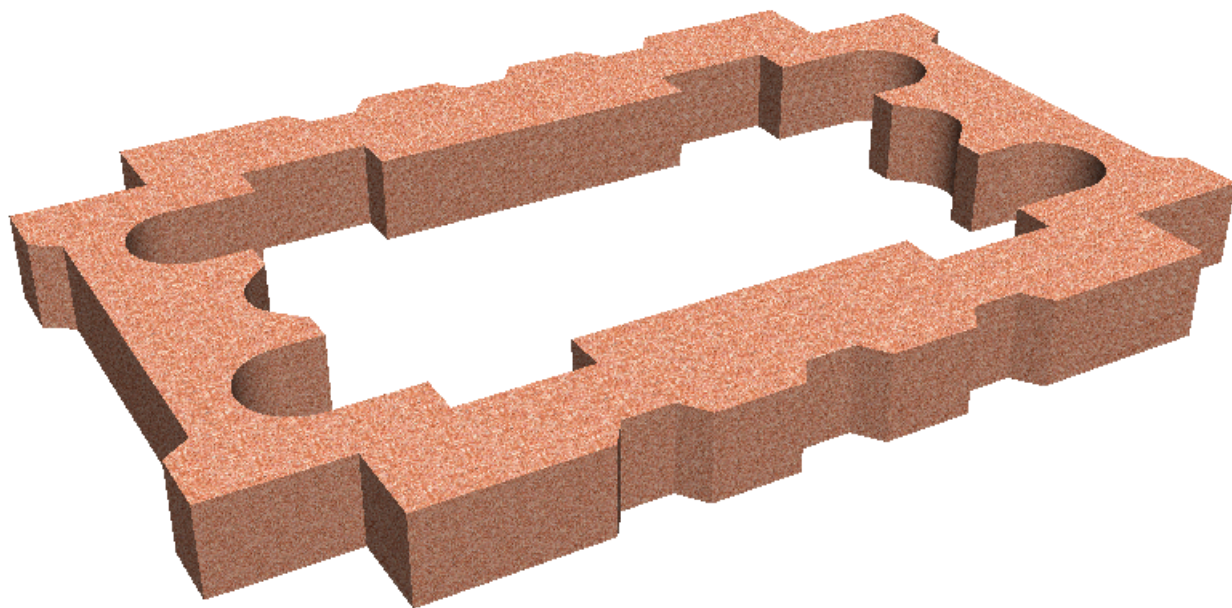

Notes on board textures

If a design has graphics, the graphics are drawn on top of the board texture or board color. If the graphics are PNG or JPG files, they will completely replace the board texture or board color. If the graphics are PDF files, the board image or board color will show through the parts of the PDF files that have no ink or are partially transparent.

Board textures are included in 3D workspaces sent to other sites. They should appear correctly even if the recipient's system does not have the same boards, papers, and textures defined.

Making an extrusion

Making an extrusion is as simple as designing its shape in Single Design, converting it to 3D, and then changing the caliper of the board to the desired size of the extrusion.

Shown below are three flat workspaces.

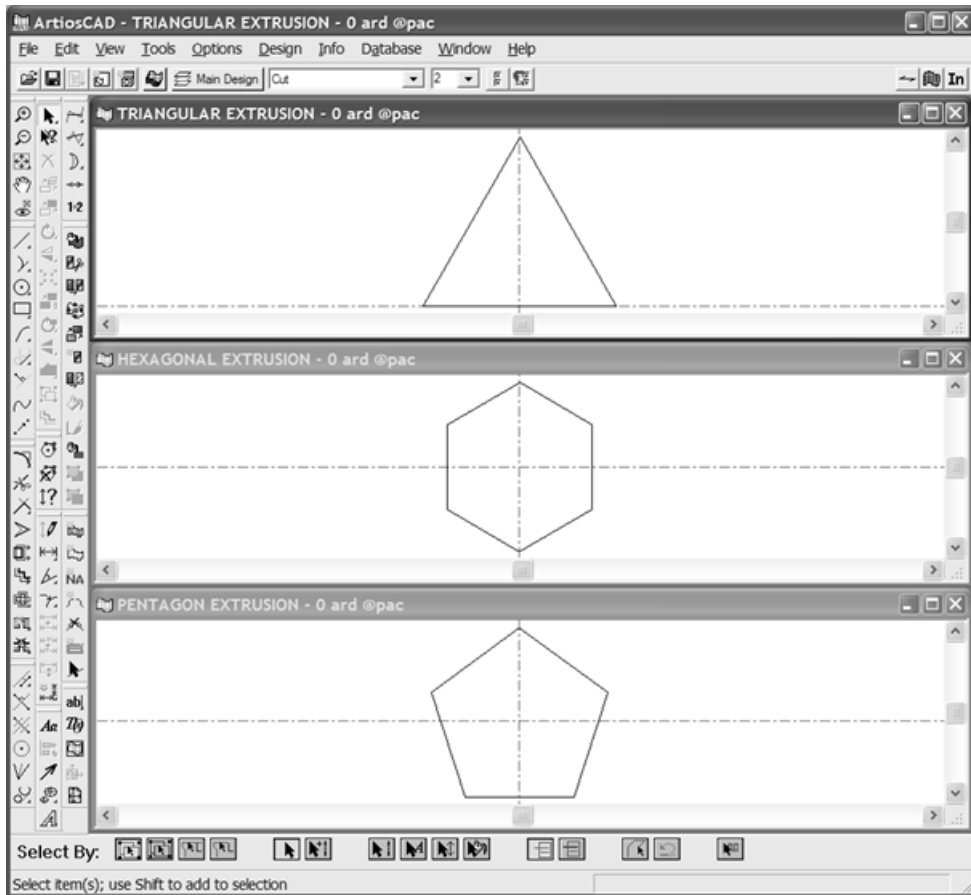

After converting one to 3D and adding the other two, this is the result having selected a normal folding carton board.

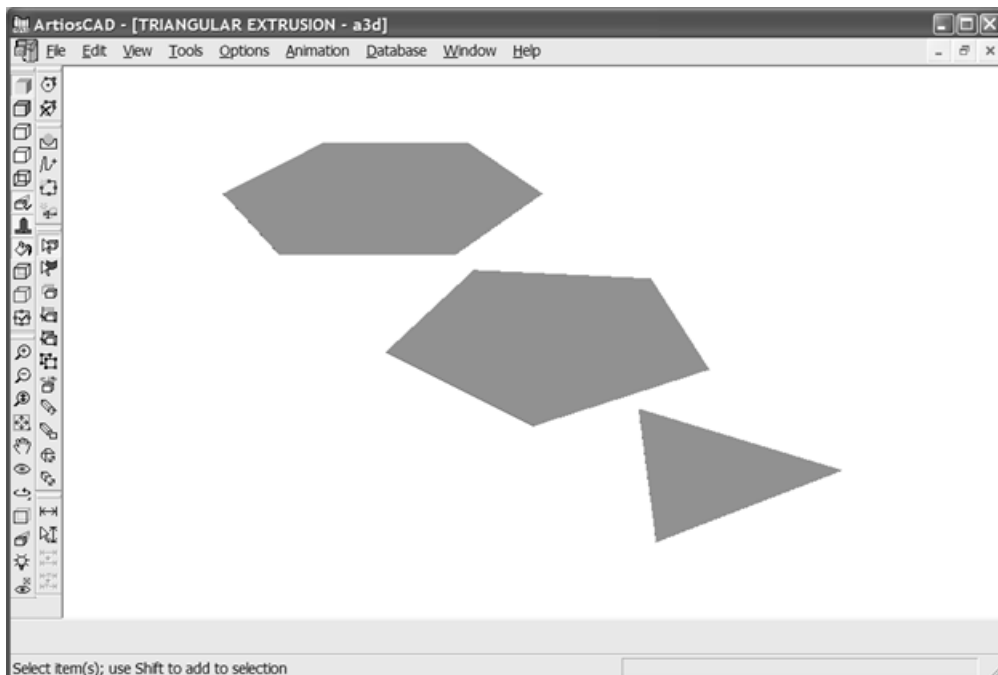

Shown below are the finished extrusions with different color foam boards selected and the caliper increased to 600 mm.

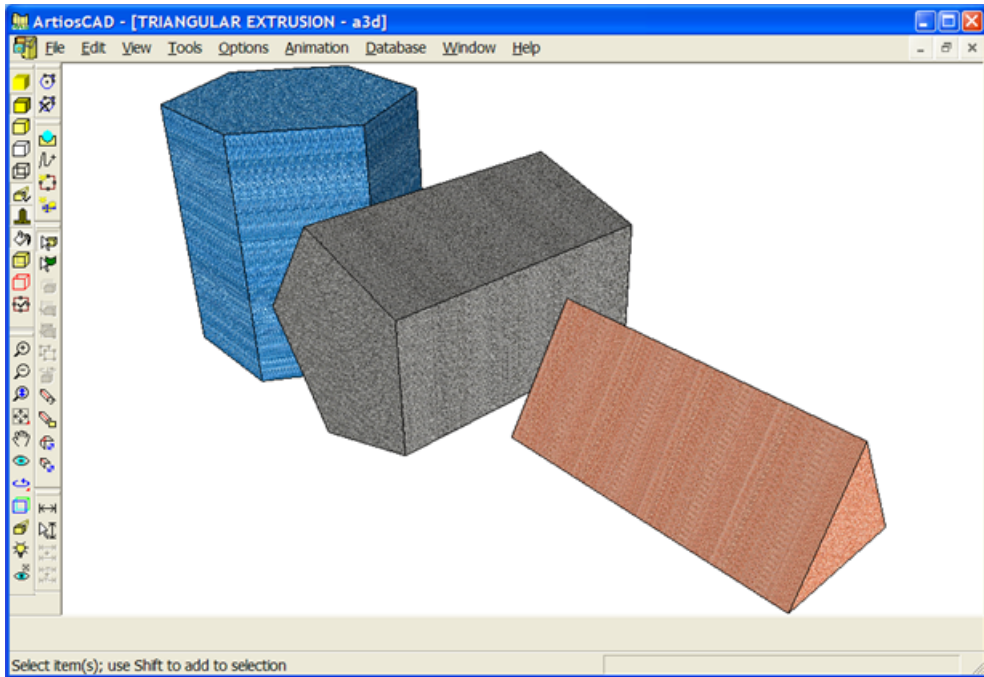

Refreshing the screen

From time to time, refresh the screen to show the latest changes you have made to the workspace. Click **Refresh** on the View menu or press F2 to redraw the screen.

You can also hold down SHIFT and click the middle mouse button if you have one.

Working with dimensions in 3D

Use the tools in this section to add, select, modify, align, and remove dimensions in 3D.

Dimension tool

 The **Dimension** tool allows you to insert dimensions into your workspace.

1.  Click the **Dimension** tool.
2. Select a point or line that will be the beginning of the measured distance.
3. If **Set Direction** is checked on the Status bar, set the direction for the dimension.
4. Indicate a point, a parallel line, or a collinear line that is the end of the measured distance
5. Indicate the extension point. This is where the text of the dimension is put in relation to the design.

6. The dimension is drawn. If **Set Direction** is checked on the Status bar, an extra extension line may be drawn indicating the direction.

Shown below is a design with both Imperial and metric dimensions. The Imperial dimensions were created first, and then the units were changed to metric and the rest of the dimensions were added. Unlike Single Design, 3D dimensions do not update when the units of the workspace are changed.

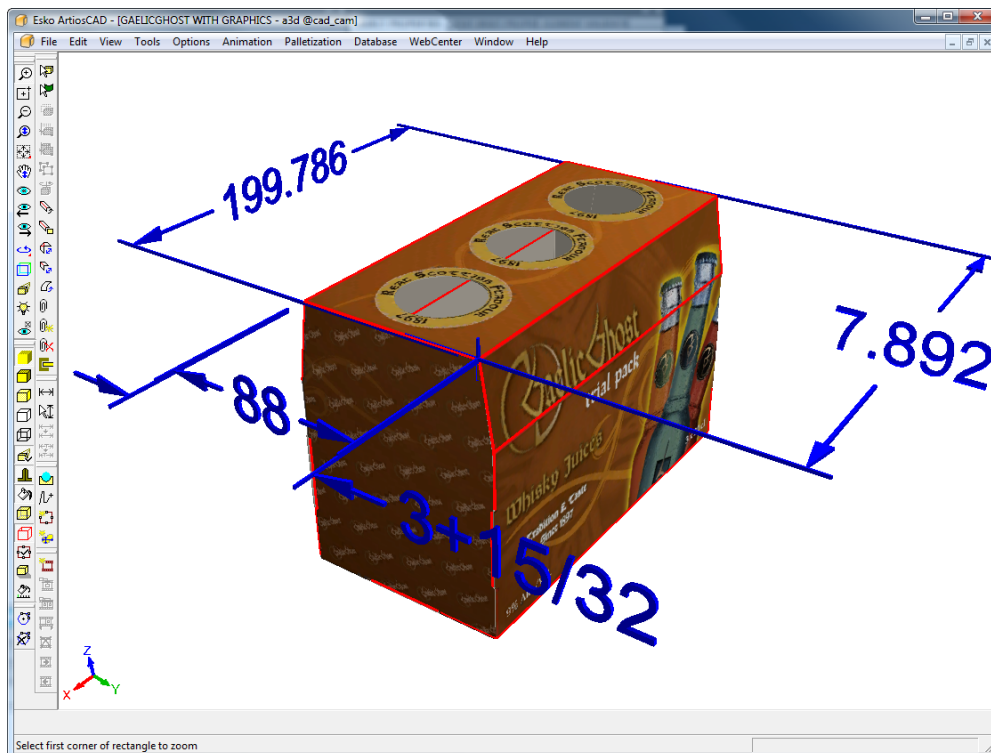

Set the default state of the **Set Direction** checkbox in **Options > Defaults > Property Defaults > 3D Dimensions**.

Select Dimensions tool

This tool allows you to select dimensions so that you can change their appearance.

1.  Click the **Select Dimensions** tool.
2. Select the dimension(s) to change. To select more than one dimension, hold down the SHIFT key as you select items. To select many dimensions at once, make a window selection.
3. If you selected only one dimension, double-click it to open the Properties dialog box; otherwise, click **Edit > Properties**.

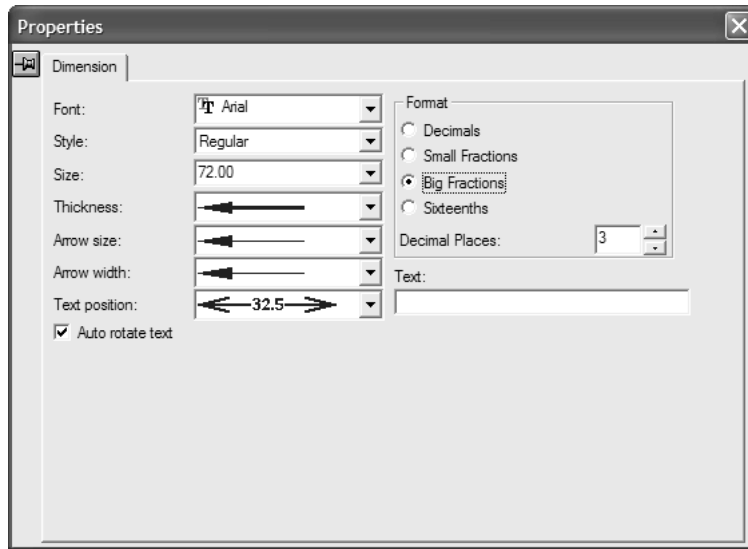

4. Change the style and format options as desired. **Auto-rotate text** enables the selected dimensions to automatically rotate to be parallel with an axis as the view angle changes. In some situations, the dimensions could be obscured by parts of the design when this option is selected, so deselect this option for affected dimensions as desired.

The **Text:** field lets you replace the dimension text with text of your choosing. Use **Undo** to revert to the original dimension text if needed.

The selected dimension(s) are updated with changes as you make them.



To set the dimension defaults for the current workspace, right-click while over a design, click **Property Defaults** on the context menu, and set the options as desired. The changes only affect dimensions created after the property defaults are changed.

To set the defaults for the arrows, text position, and auto-rotation of text for 3D dimensions, click **Options > Defaults > Property defaults > 3D Dimensions**.

To view dimensions in a different color, change the plotting style in the View Mode dialog box to one which has a different color for dimensions.

Change Dimension Alignment tool



 The **Change Dimension Alignment** tool lets you change the extension point of a dimension within the plane of its extend lines. To use it, do the following:

1.  Select a dimension with the **Select Dimension** tool.
2.  Click the **Change Dimension Alignment** tool.

3. Click the desired location for the dimension. The dimension moves to the new location and the extend lines change length as needed.

Change Text Position tool

 The **Change Text Position** tool lets you change the position of text within a dimension. To use it, do the following:

1.  Select a dimension with the **Select Dimension** tool.
2.  Click the **Change Text Position** tool.
3. Drag the text and the extend point of the dimension to its new position and click to set it.

Shown below is a workspace before changing the text positions of dimensions.

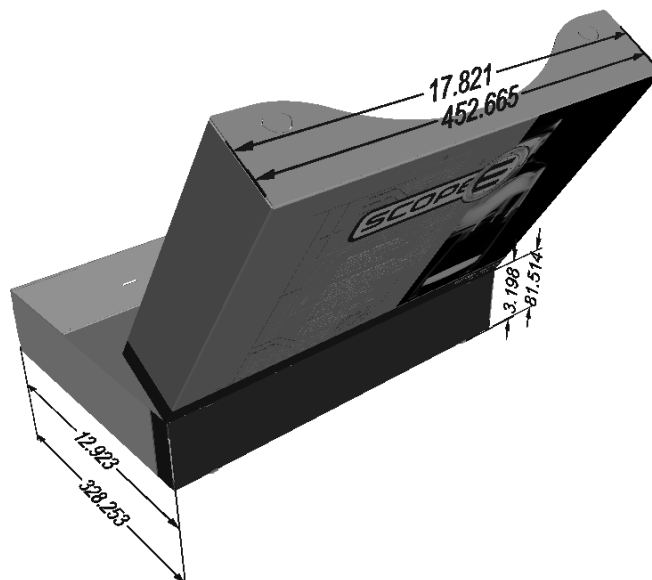

Shown below is the same workspace after changing the text positions and extend points of the dimensions.

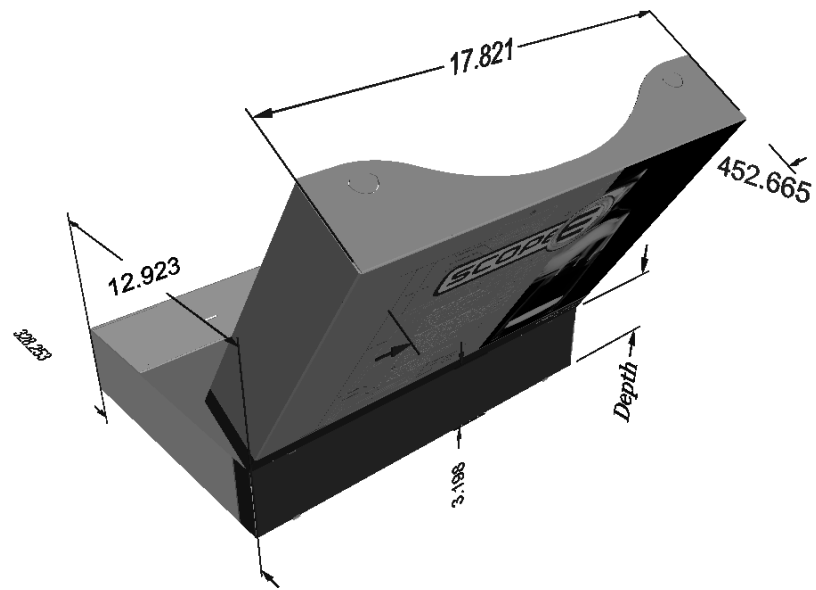

Deleting dimensions

To delete dimensions, select them with the **Select Dimensions** tool, and then press Delete on the keyboard.

Working with Edge Band and Tear Tape

Short reference description.

Edge band is a cover that hides the edge of thick material, such as Re-board[®], usually used for displays. *Tear tape* is the thin plastic strip on the inside of box-opening features.

Both edge band and tear tape are special rules.

Edge band

To use edge band, set some edges in the 2D design to use it.

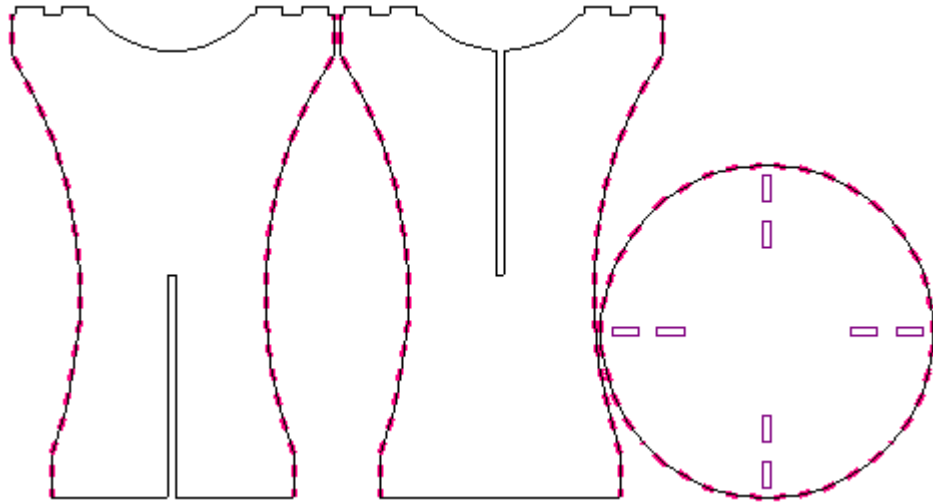

When you convert the 2D to 3D, the edge band appears. Turn it on and off by checking or clearing **Edge band** in the Properties dialog box on the Board Information tab.

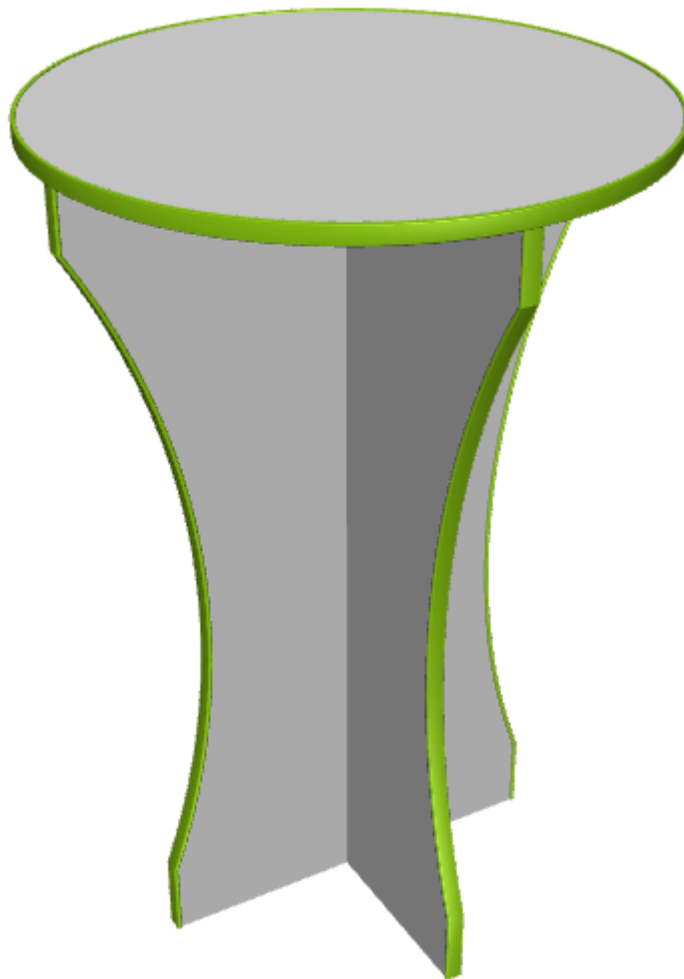

Notes about edge band:

- If edge band goes around a corner, ArtiosCAD shows separate pieces with no mitering.
- You may only use one type of edge band per single design added to 3D.
- To change the color of the edge band, change it in 2D on the Special rule tab of the Properties dialog box for the edge band rule and reconvert to 3D. You cannot change the edge band color in 3D.
- ArtiosCAD shows only solid-color edge band and does not support textures on it.
- Edge band does not turn on or off within an animation.

Tear Tape

To use tear tape, add it as you would any other line to the design. In the example below, it is between the zipper rules.

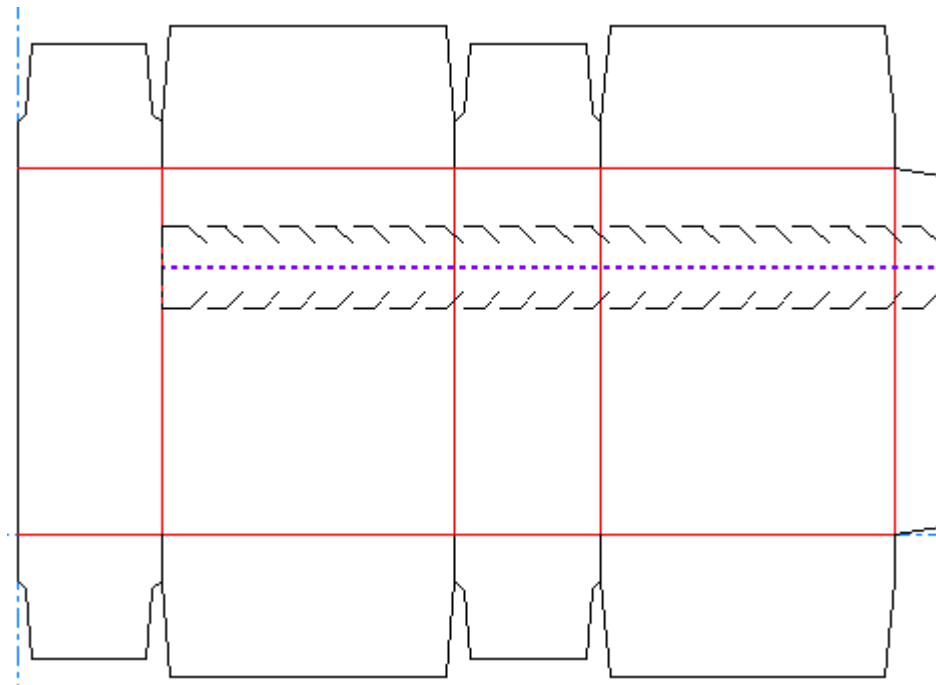

When you convert it to 3D, it looks like the following example.

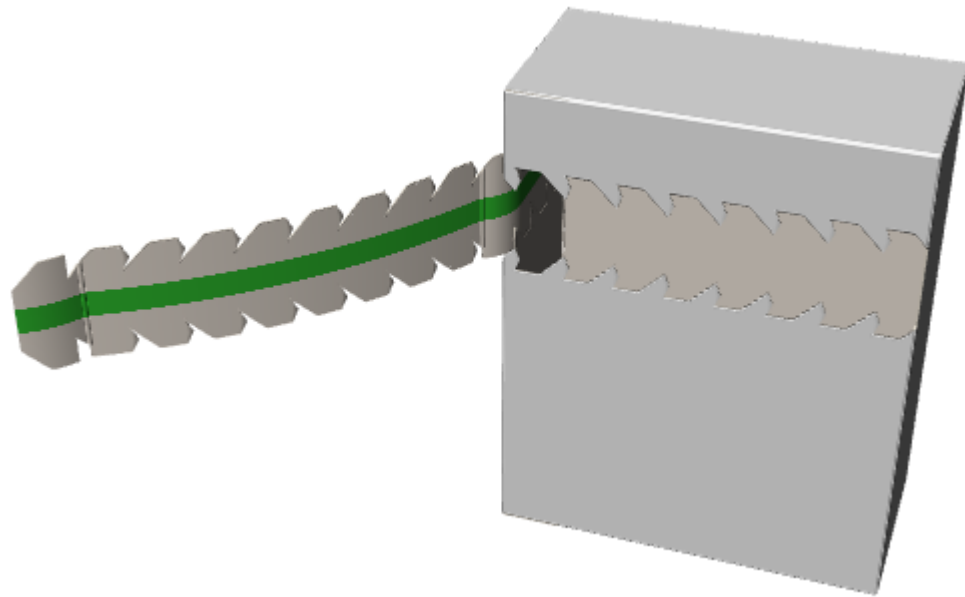

Note: Tear tape does not tear by itself, so to show it tearing without the aid of something like a zipper, surround it with tear lines in the 3D Assist layer.

Animation in 3D

Animation in 3D lets you record a folding sequence and output it as a **Virtual Reality Markup Language (VRML)** file, which can then be played in any Web browser with a VRML plug-in. It will play back as you recorded it. The animation is defined by recording each change to the view in a new **frame** or snapshot.

When you export to VRML, multiple files are created by default, although this can be changed at time of export. The files are pictures of the faces of the objects in the workspace and a file containing the geometric information. Make sure to group the files together when sending them to another person or computer.

Esko recommends the Cortona VRML plug-in, available at <http://www.parallelgraphics.com/products/cortona>.

This is an optional feature and must be specifically purchased.

The workflow to making an animation is:

1. Create a single design and add any desired graphics, stock colors, or symbols.
2. Convert the single design to 3D. It should be flat.
3. Click **Add Frame** on the Animation toolbar.
4. Change the fold angles or move/rotate a design, and click **Add Frame** after each change.
5. Repeat until the design is folded and positioned as desired.
6. Export to VRML, setting the desired options in the VRML options dialog box.
7. Open the resulting file in a web browser which has a VRML plug-in installed.

If there are multiple single designs in the 3D workspace, you might achieve better results by turning off **Scale to Fit** on the Status bar while making the animation.

The tools to make animations are on the Animation toolbar and the Animation menu. The Animation toolbar is shown below.



The Status bar

When any of the Animation tools are active, the Status bar contains controls as shown below.

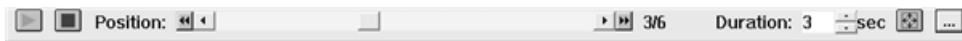

The green triangle button is the **Play** button and starts the animation playback at the current frame. The red square button is the **Stop** button and stops the animation playback.

The numbers between the **Position** slider and the **Duration** field show the current frame and the total number of frames. On the **Position** slider, use the inner direction buttons to move frame by frame; clicking the outer direction buttons moves to the first frame and the last frame respectively. Graphics are turned off while you drag the slider button, but are turned on when you release the mouse button. Graphics are not turned off when the frame-by-frame buttons are used.

The value in the **Duration:** field determines the timing of the animation by controlling the time taken to change from the previous frame to the current frame. The duration for the first frame sets the pause between repeats in VRML Outputs and may be set to 0 for the first frame only. By default, each frame's duration is set to three seconds; you may achieve better results by testing different values. The value in the **Duration:** field is specific to each frame.

 **Scale to fit** may be set for each frame. When clicked, ArtiosCAD centers visible designs in the view and adjusts the view to fit them. Upon playback, the field of view changes smoothly between frames that have this option selected; it may appear that the designs drift, but this is so that the view is centered in each frame that has this option selected.

 The **Options** button opens the Frame Properties dialog box.

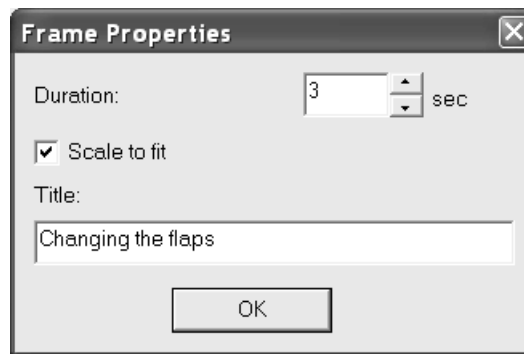

Duration: and **Scale to fit** have the same values as their counterparts on the Status bar. Enter text in the **Title:** field to use when exporting the animation to another format. Click **OK** when done making changes to the dialog box.

The animation in a VRML file will use the view angle and elevation set at the time the VRML file is exported from 3D. Changing the view angle and elevation for each frame has no effect.

To save the animation in the corresponding single design, such as saving it to a standard, close the 3D file while the single design is still open. When a single design is created using that standard, the animation settings will be included.

Animation tools



The first button on the Animation toolbar is **Add Frame**. Use this command to take a snapshot of the current state of the workspace and add it to the animation. For changes to fold angles, you do not need to change each angle incrementally and then capture a new frame. Change the fold angle in the complete amount desired and ArtiosCAD will create the intermediate steps on export. Only changes in fold angles, moves, and rotations are captured in frames. To simulate a change in the view angle or elevation, move or rotate the designs as desired.



The second button on the Animation toolbar is **Update Frame**. Use this to change the current animation frame to match what is on the screen without adding another frame.



The third button on the Animation toolbar is **Update Range of Frames**. Use this to update more than one frame at once, for example if you have added another design to the 3D workspace and then moved it after having made an animation. Changes that can be applied to multiple frames are moving designs, rotating designs, changing the visible property on or off, and changing fold angles.

To use this tool, do the following:

1. Make the desired change(s) to the 3D workspace.
2.  Click **Update Range of Frames** to open the Update Range of Frames dialog box.

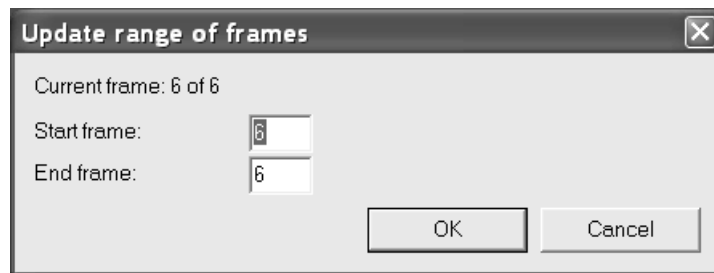



3. Enter the number of the start frame in the **Start frame:** field, and then enter the number of the ending frame in the **End frame:** field. The current frame must be included in the range.
4. Click **OK** to update the frames.

If designs that were moved or rotated already have different positions in different frames in the animation, ArtiosCAD adjusts the position and rotation of each design by the same relative amount in each frame.

 The fourth button on the Animation toolbar is **Animation Playback**. Use this to step through the animation in 3D by using the slider, or to start playing it at the current frame using the Play button.

 The fifth button on the Animation toolbar is **Delete Frame**. Use this to delete the current frame. This tool is available only when the Animation Playback tool is active.

 The sixth button on the Animation toolbar is **Shuffle Frame Forward**. This tool moves the current frame forward by one frame in the animation sequence. This tool is unavailable for the last frame, or if there is no animation defined. This tool is available only when the Animation Playback tool is active.

 The seventh button on the Animation toolbar is **Shuffle Frame Backward**. This tool moves the current frame back by one frame in the animation sequence. This tool is unavailable for the first frame, or if there is no animation defined. This tool is available only when the Animation Playback tool is active.

Note that when shuffling frames, their duration and Scale to Fit setting are kept with them.

The **Reverse Animation** command on the Animation menu reverses the order of all the frames in the animation. When reversing an animation, note that the first duration is a pause before the animation begins, so an animation with durations 2, 3, 4, 5 would have durations 2, 5, 4, 3 when reversed.

The **Delete Animation** command on the Animation menu deletes the entire animation sequence.

Animation notes and restrictions

The animation feature will not play back adding or deleting designs, or changing the base face. If you delete a design while making an animation, it will disappear from all frames created up to that point.

An animation with **Scale to Fit** turned on and with a background image keeps the background image the same size in ArtiosCAD but the VRML version has a zoomed-in image.

When rotating designs in an animation, do not rotate them through 360 degrees. Break the rotation into three 120 degree steps or four 90 degree steps. Otherwise, the designs may rotate the wrong way during animation playback.

If you find that the design(s) in the VRML file move a lot during playback, try turning off **Scale to Fit** on the Status bar before creating an animation.

Dimensions are not output to an animation, nor are they animated with the designs. They are turned off at the start of the animation playback and turned on when the playback completes.

When an animation has a background image, the **Fit** button in Cortona causes the design to disappear. Use the **Restore** button to bring it back.

When the design already has an animation and you add more designs, ArtiosCAD does not record the position of the added designs. The new designs will have a fixed position throughout the animation unless you move them or change the visibility and update the frames of the animation. For best results, add all the designs first and make the animation last. If you add a design to a workspace with an animation, ArtiosCAD warns you that you should add all the designs first and make the animation last.

Likewise, animations also do not record scale changes made using Scale Designs, which has a similar warning.

Tear-away Animations

Tear-away animations show how the design separates. They are different from normal animations and there is a dedicated tool to make them.

Tear-away animations require that the panels can bend. If the panels do not bend, ArtiosCAD makes a pull-away animation instead in which you can only set the pull-off duration and distance of the pulled-away part.

Note: Tear-away animations only work for the first instance of a design; they do not work on copies.

Making a Tear-away Animation

To make a tear-away animation, do the following:

1. Create a 3D workspace and make sure all the designs you want in it are arranged properly. The designs must also have the 3D property of the tearing lines set correctly in Single Design. For example, if you want to show potato chip bags in a retail-ready shipping container, arrange the bags inside the container and fold the container so that it appears closed.



2.  Click the **Make tear-away animation** tool and click where you want the tear-away to start in the part that is torn away. In the example below, the cursor is in the thumb hole and you can see the perf forming the left part of the tear.



3. Set the fields as desired in the Tear-away animation dialog box.

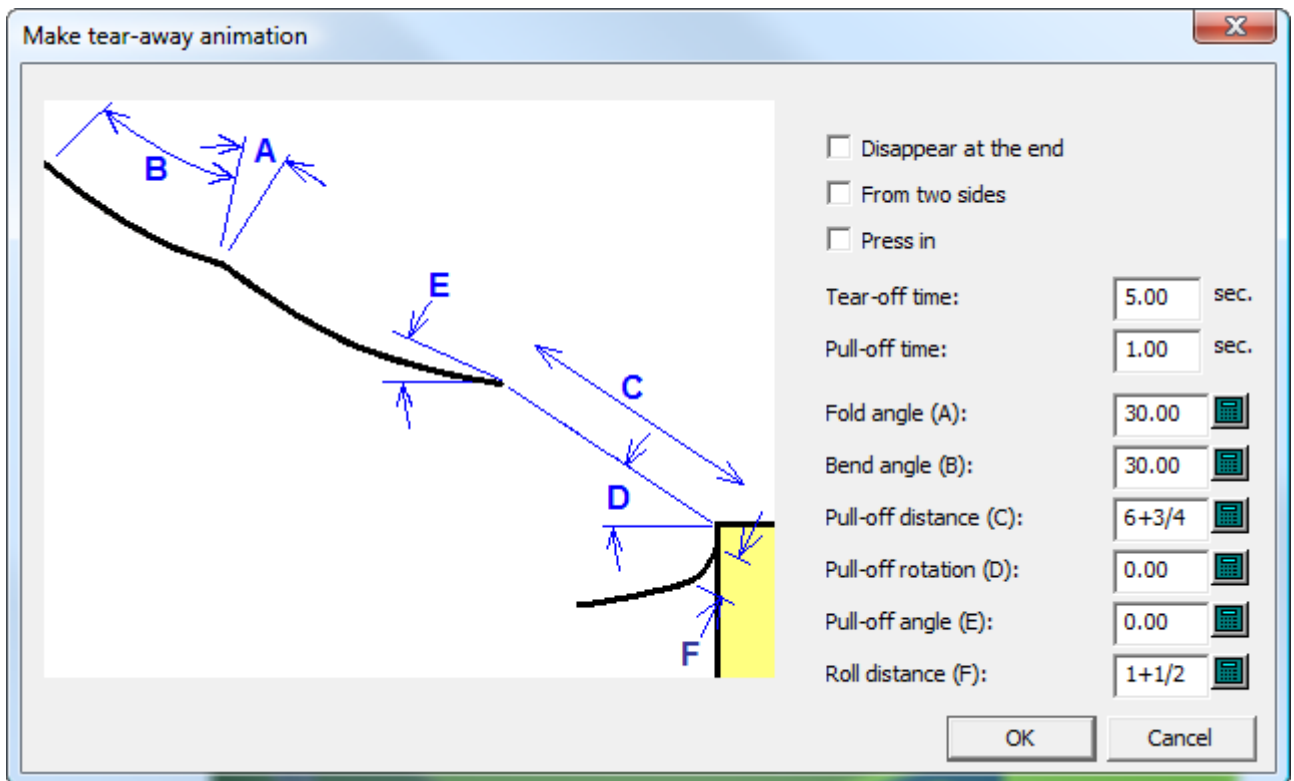

- a) **Disappear at the end** causes the torn-away piece to disappear from the scene when the animation finishes.
- b) **From two sides** shows two ends of the tear-away being torn away simultaneously before the tear-away is detached from the middle. Use this option only when you have specifically designed the tear-away to start in two places at once.
- c) **Press in** causes a beginning thumb notch or other similar construction to be pressed into the container before it is torn away.
- d) **Tear-off time** and **Pull-off time**, respectively, set the duration of those parts of the animation.
- e) **Fold angle (A)** sets the angle at which a fold in the part being torn away is folded at the end of the animation.
- f) **Bend angle (B)** sets the angle at which a bend in the part being torn away is bent at the end of the animation.
- g) **Pull-off distance (C)** controls how far the torn-away piece is pulled from the main piece of the design at the end of the animation.
- h) **Pull-off rotation (D)** determines the rotation at which the torn-off piece turns.
- i) **Pull-off angle (E)** determines the direction in which the torn-off piece moves.
- j) **Roll-off distance (F)** sets how far the torn-away pieces rolls off the main body and thus how tight the bend is. If you have to pull hard to do the tear-away in real life, set a small distance to have a tight bend.

4. Click **OK** when you are done setting the values as desired.

ArtiosCAD creates the animation and starts the **Animation Playback** tool. Click the green triangle to play the animation.



Note: If you use **Scale to Fit** on any of the animation frames, you will not be able to make any changes to the animation.

Example of Tearing from Two Sides

Make sure to check **From two sides** in the Make tear-away animation dialog box if you have designed a box similar to the one shown below.

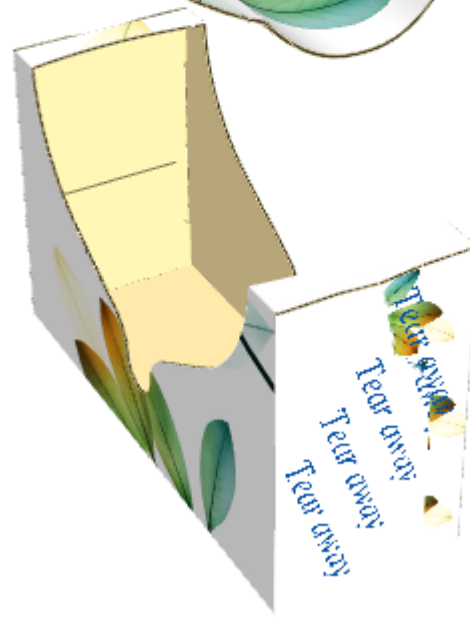
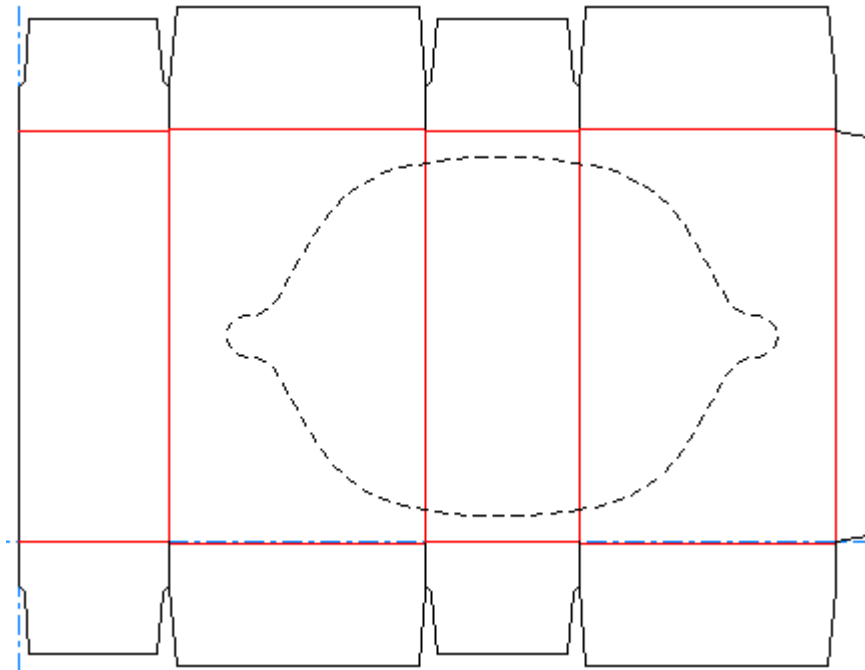

If you do not check the **From two sides** checkbox, the result will look something like this:

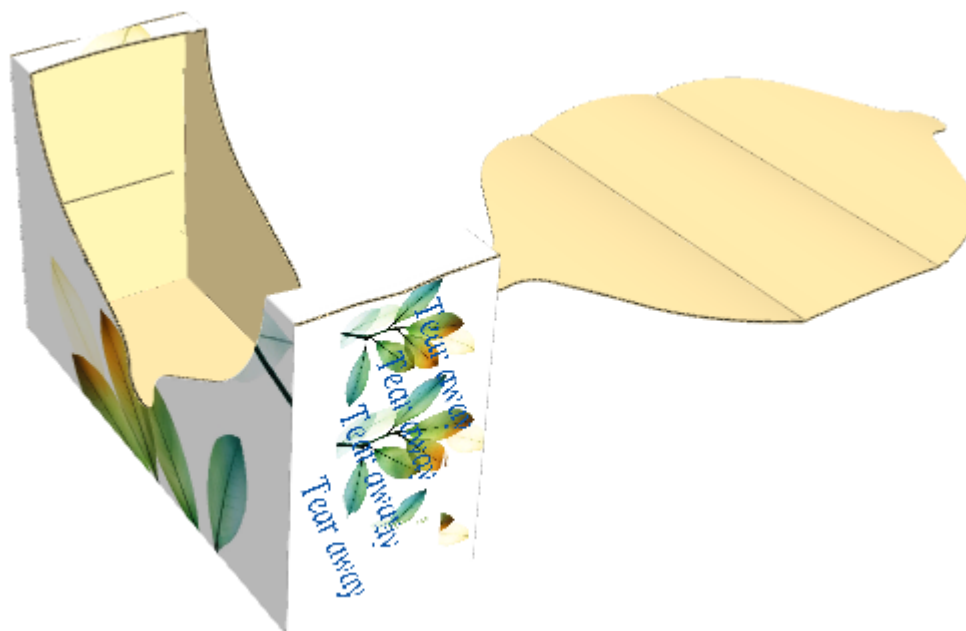

Example of an Attached Tear-Away Animation

Tear-away animations do not actually have to be torn away - as long as the design has lines that will tear in it, you can show them tearing. The example below has a flap edged with perf and ending on a crease. This allows access to its contents, but also means the box can be closed after its contents are removed.

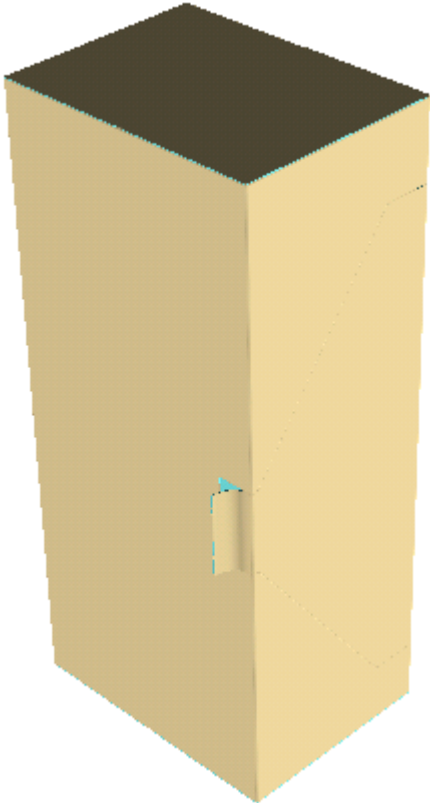

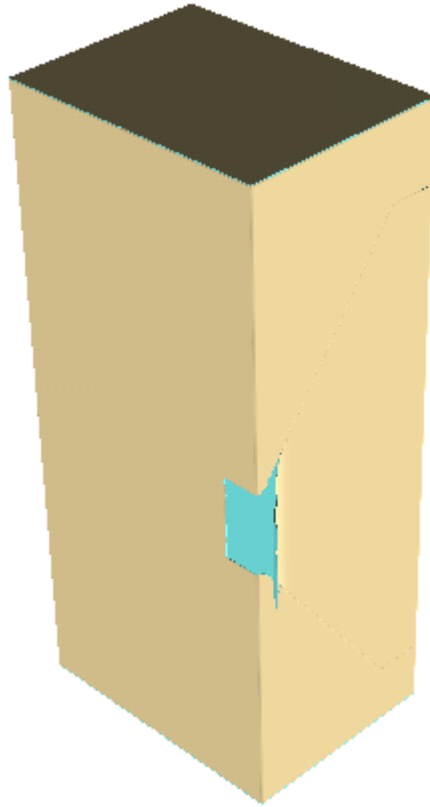

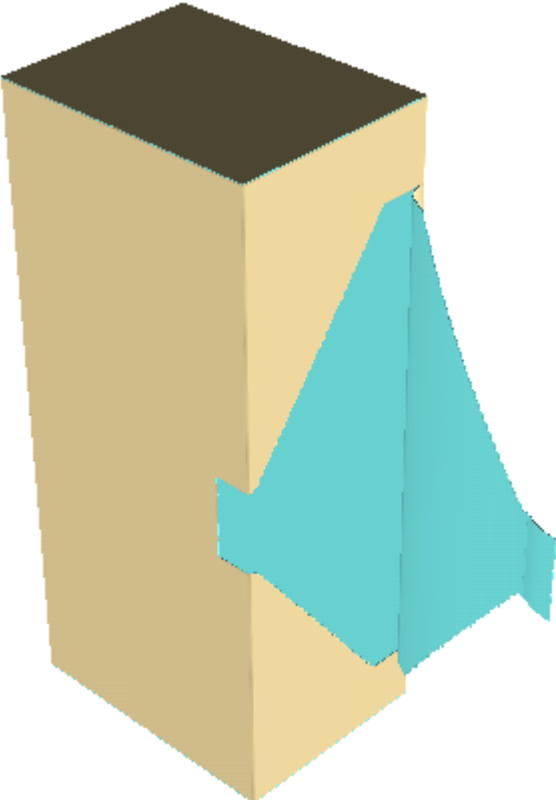

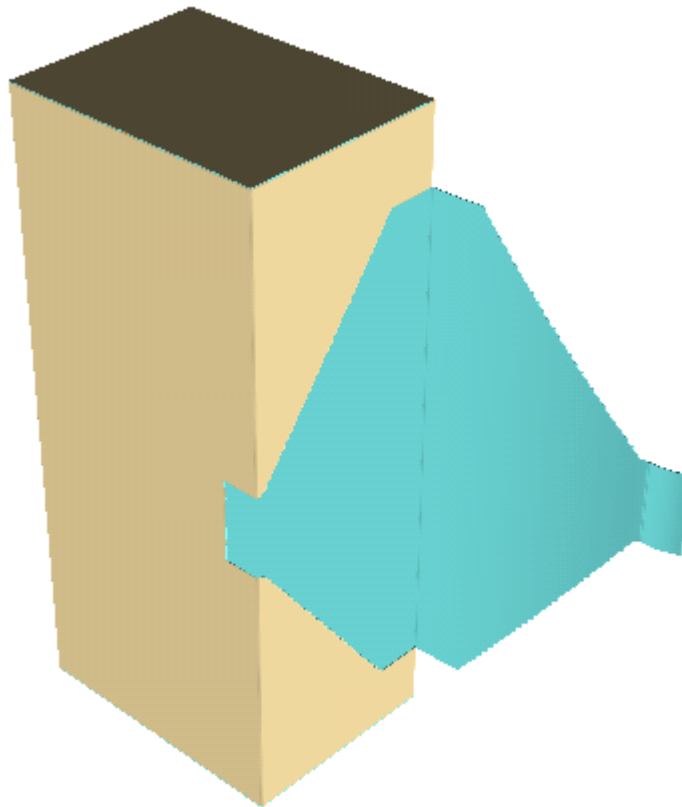

Making a Pull-Away Animation

If the panels of the box do not bend, ArtiosCAD removes the torn-away part from the main body of the container in a straight line.

1. Design the container, making sure to set the 3D property of the tearing lines to **Tear** or **Tear and fold**.
2. Convert the design to 3D.
3.  Click **Make tear-away animation** and then click the start point for the animation.





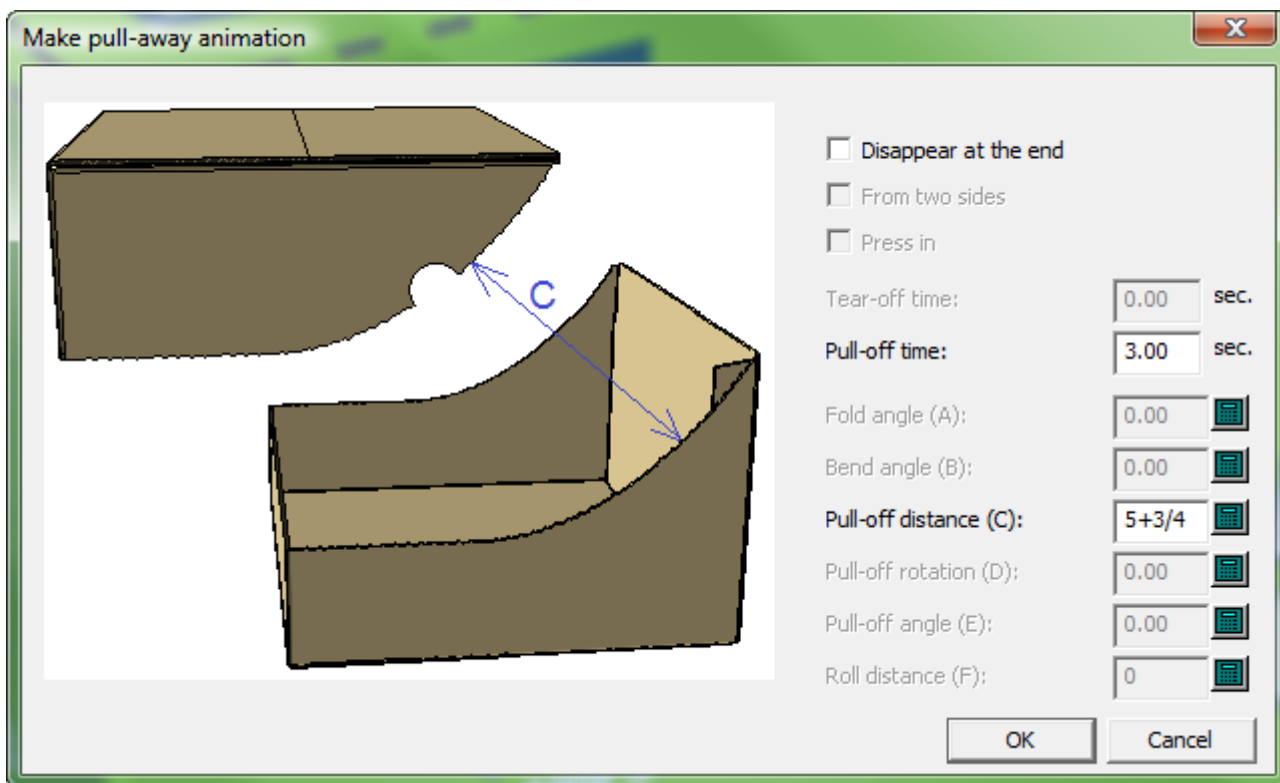

4. In the Make pull-away animation dialog box, set the options as desired and click **OK**.



5. ArtiosCAD creates the animation and starts the **Animation Playback** tool. Click the green triangle to play the animation.



6. To change the direction in which ArtiosCAD pulls the part away, do the following:
 - a)  Use **Animation Playback** to go to the last frame of the animation.
 - b)  Use **Select designs** to select the torn-away part.
 - c)  Use **Move Designs** to move it in the desired direction.
 - d)  Click **Update Frame**.
 - e) When you replay the animation with the **Animation Playback** tool, the pulled-away part will move in the direction you specified.

Substrate Tears

Some designs use partial cuts and reverse partial cuts instead of perfs to tear. This type of tear is called a *substrate tear*, and is shown below as the lines in the second panel that connect the zipper rule to the perf.

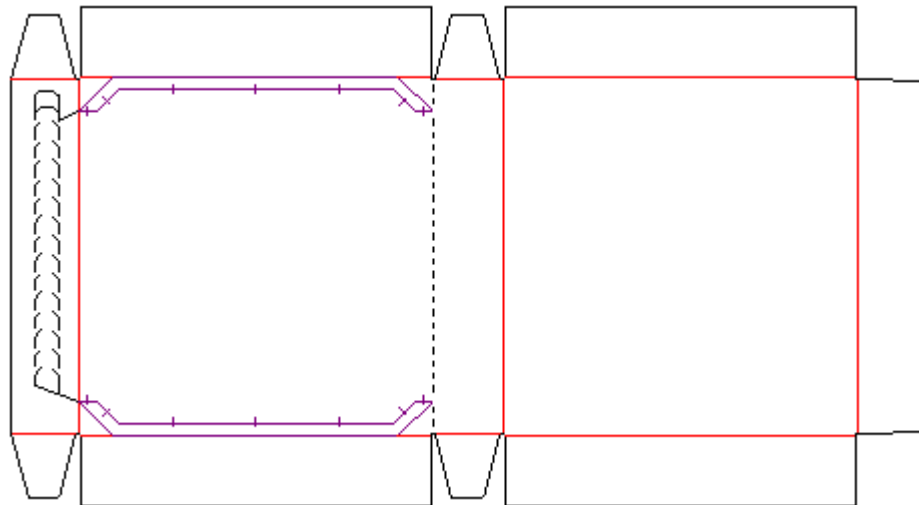

In order for 3D to recognize a substrate tear:

- The substrate tear is made by partial cuts and reverse partial cuts
- The partial cuts and reverse partial cuts have the **Tear** option selected on the 3D tab of the Properties dialog box in Single Design
- There are no gaps in the lines
- The substrate tear area is a maximum of 1/2 inch or 12.7 millimeters wide.

Example of Two Tear-away Animations

To have two tear-away animations in the same design, use **Make tear-away animation** twice consecutively.

1. Design the container, making sure to set the 3D property of the tearing lines to **Tear** or **Tear and fold**.
2. Convert the design to 3D.
3.  Click **Make tear-away animation** and then click the start point for the first animation.



4. In the Make tear-away animation dialog box, set the values as desired and click **OK**.

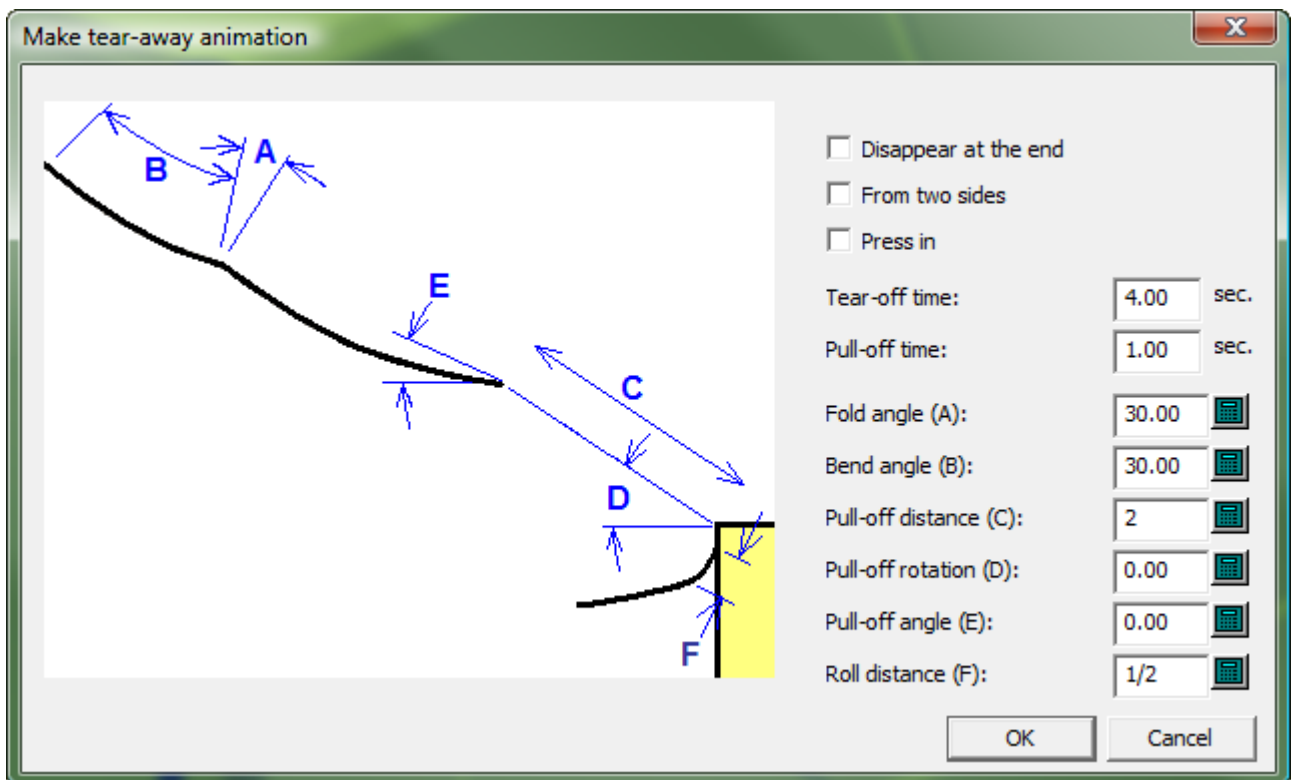

5.  Click **Make tear-away animation** and then click the start point for the second animation.



6. In the Make tear-away animation dialog box, set the values as desired and click **OK**.

ArtiosCAD makes the second animation and starts the Animation Playback tool. Slide the frame slider all the way to the left to start at the beginning, and then click the green triangle to play both animations.

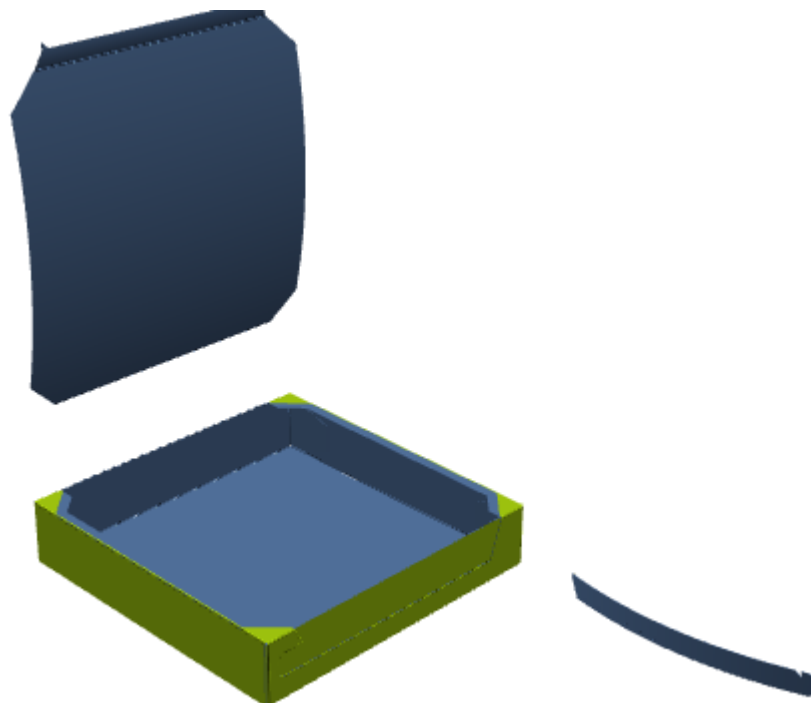



Example of a Tear Strip with an Attached Part

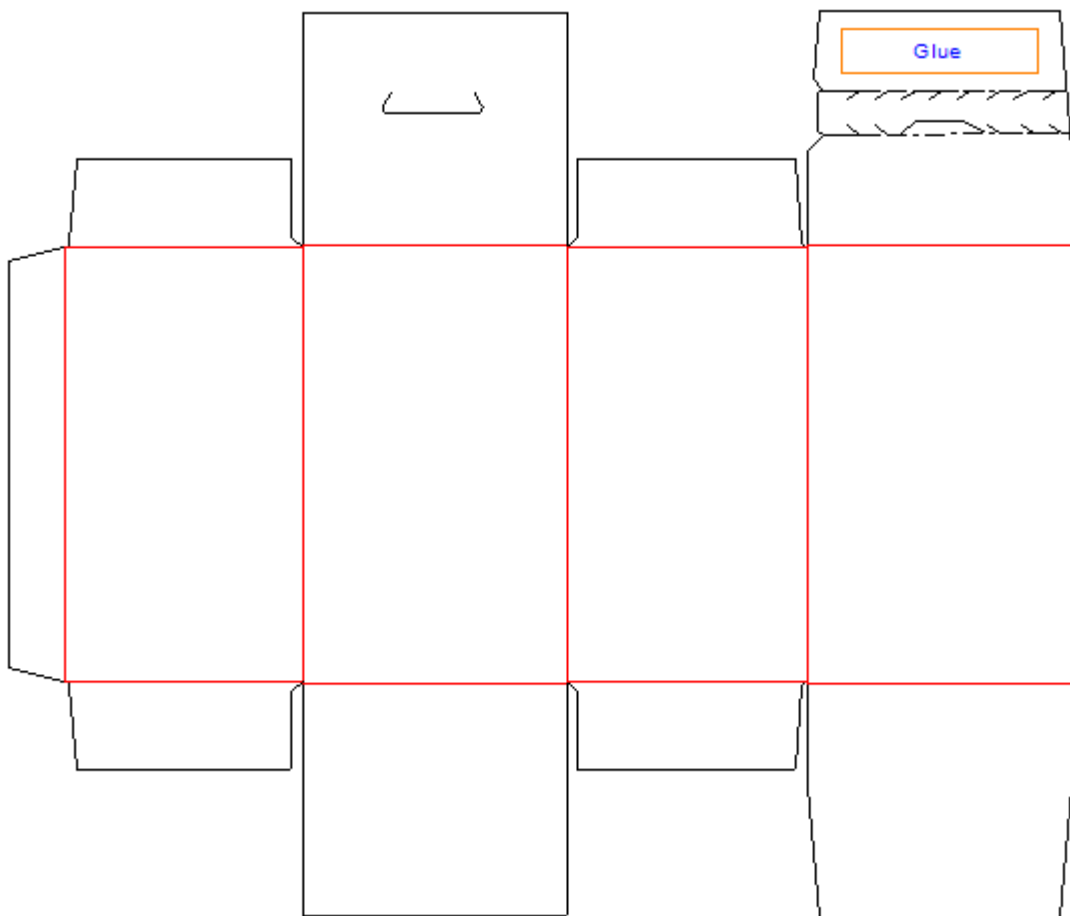

Usually torn-away parts are separated from the main part of the design. To leave the remainder of a part attached after part of it is torn off, such as a flap with a zipper glued to it, do the following:

1. Design the container, making sure to set the 3D property of the tearing lines to **Tear** or **Tear and fold**.
2. Make a Mate area on the part of the design that will remain after the tear-away is torn off. Only one Mate area is needed; ArtiosCAD automatically creates the target area in 3D.

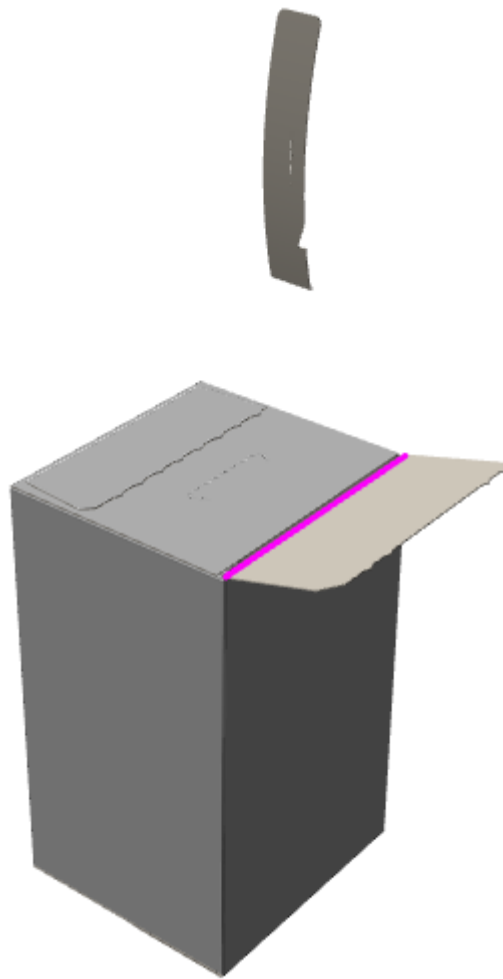

3. Convert the design to 3D.
4.  Click **Make tear-away animation** and then click the start point for the animation. ArtiosCAD creates the animation and activates the **Animation Playback** tool.
5. In the **Animation playback** tool, if the frame slider is not already on the last frame, slide it all the way to the right to go to the end of the animation.
6.  Use **Fold Angle** to unfold the flap that does not have the Mate area.



7.  Click **Add Frame**.
8.  Use **Fold Angle** to unfold the opposite panel, the one that has the Mate area. Note that the part with the Mate area is still attached and was not torn away.

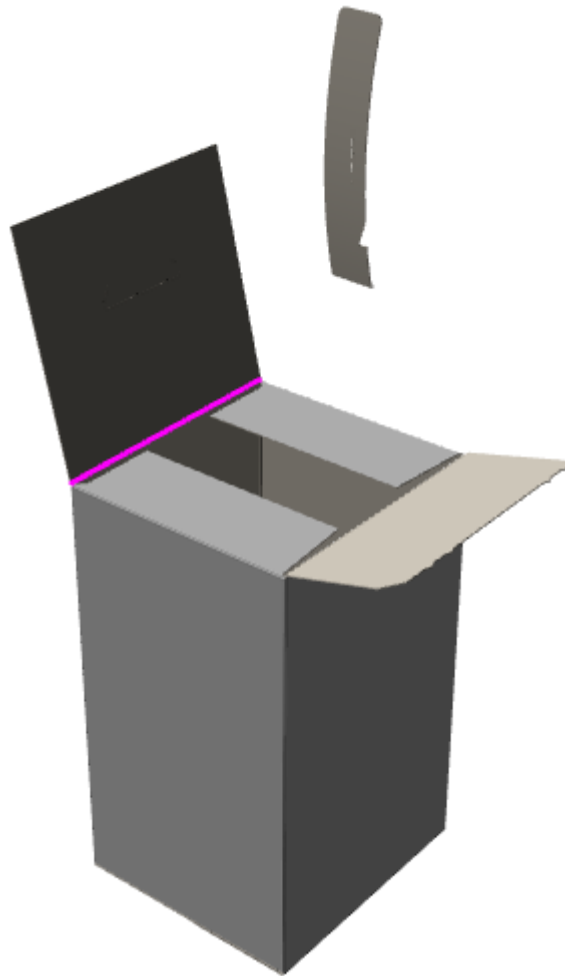

9.  Click **Add Frame** to complete the animation.

You can edit the duration of each frame as desired in the **Animation Playback** tool.

Adding a Tear-away Animation to an Existing Animation

If you already have an existing animation when you use **Make tear-away animation**, ArtiosCAD adds frames to the existing animation. For example, you could create the following animation:

1. Fold a container, leaving the top open.
2. Put contents in the container.
3. Close the container.
4. Tear away the top of the container.
5. Remove the box contents.

To accomplish this, make steps 1, 2, and 3 manually, then use **Make tear-away animation** for step 4, and then add step 5 manually.

Deleting a Tear-away Animation

To delete an entire tear-away animation, click **Animation > Delete animation**. To delete just the tear-away portion of the animation, do the following:

1.  Click **Make tear-away animation**.
2. Click the part to delete.
3. In the Edit tear-away animation dialog box, check **Delete animation of this part** and click **OK**.

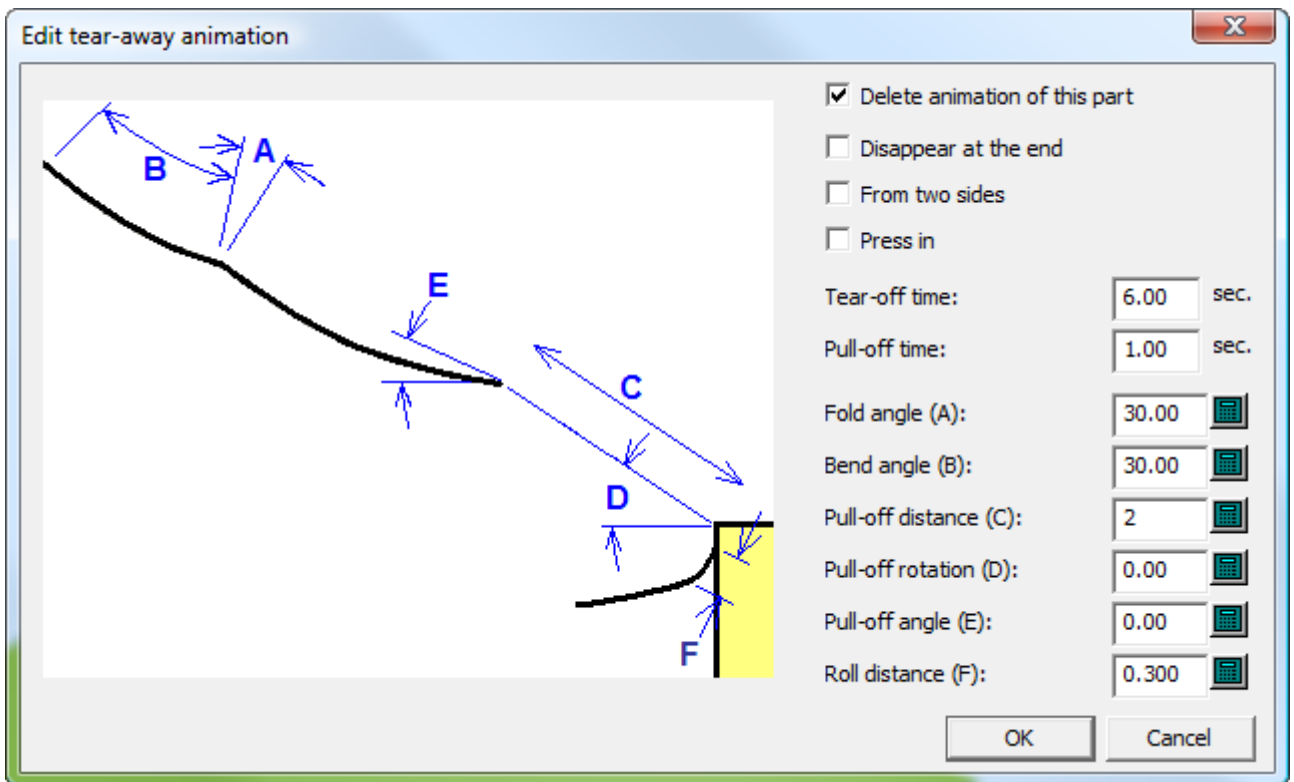

ArtiosCAD deletes the animation for the part you selected.

3D Designer

Use **3D Designer** to make a solid of revolution. A **solid of revolution** is a flat ArtiosCAD design with special layers defined. When converted to 3D, cross-sections and graphics defined in the single design workspace are rendered as a solid model. Shown below in the top pane is a flat single design, and in the bottom pane is the 3D workspace with the solid of revolution.

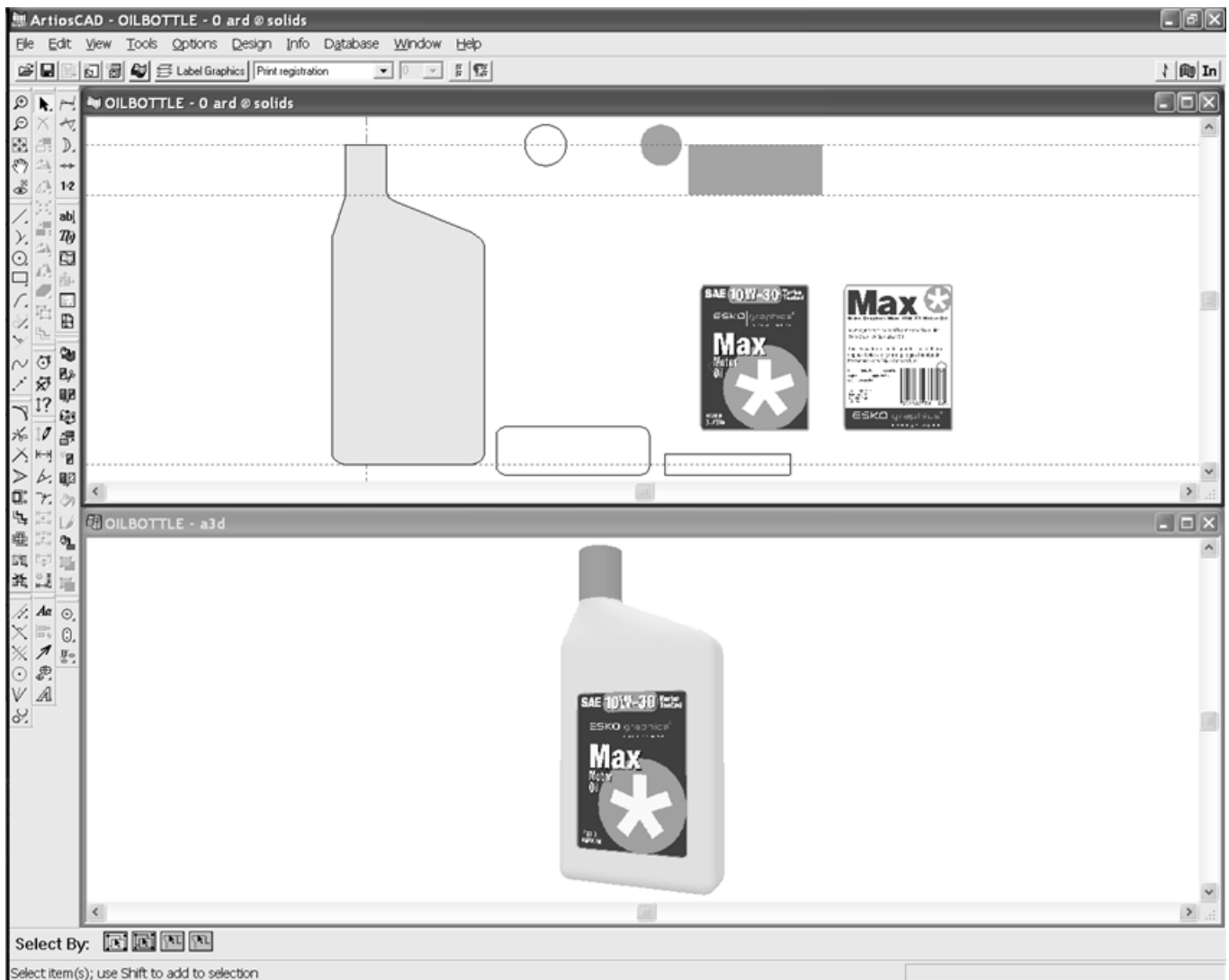

Solids of revolution

Working with the single design

To be converted to a solid of revolution, a single design has these properties:

- A vertical cross section positioned on the Y axis of the workspace in the **Main Design** layer (required)
- A color defined (optional)
- A set of horizontal cross sections at different heights along the vertical axis in a layer of class **Horizontal Cross Section** (optional)
- Graphics for labels defined in a layer of class **Label Graphics** (optional)
- Shrink-wrap graphics defined in a layer of class **Shrink Wrap Graphics** (optional)

Note: At least one layer of the three layer classes described above must exist for the design to be converted to a solid of revolution. The layer can be empty. Solids of revolution may not have holes that go completely through them.

Shown below is the single design workspace for the oil bottle. On the left is the vertical cross section in the **Main Design** layer. To the right of that, the open circle and two open rectangles are horizontal cross sections in the **Horizontal Cross Section** layer. To the right of that, the filled-in circle, filled-in rectangle, and two graphics are in the **Label Graphics** layer.

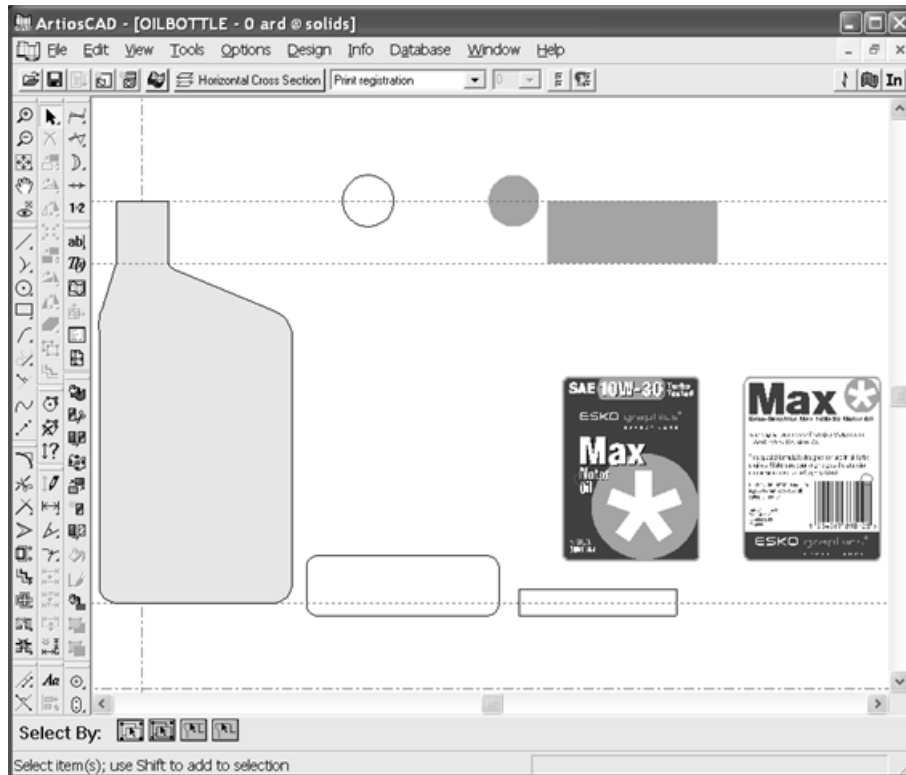

Vertical cross section

The vertical cross section is an outline of the shape using cut lines which straddles the Y axis in the **Main Design** layer. If it is filled with color (using the **Fill** tool), the color becomes the surface color when the single design is converted to a solid of revolution. The vertical cross section does not have to be symmetrical, but the solid of revolution will revolve around the Y axis, so place the vertical cross section accordingly.

Horizontal cross section

Horizontal cross sections must be in a layer of class **Horizontal Cross Section**. If there is no layer of this class, the solid of revolution will have a round cross section. Each horizontal cross section is an outline made of cut lines of the exterior shape of the solid of revolution.

The center of the horizontal cross section's bounding box is aligned vertically with the corresponding point in the vertical cross section. To use a different alignment point, use print registration lines to make a small cross at the desired alignment point. Non-symmetrical shapes may require alignment points for proper positioning.

The horizontal placement of the horizontal cross sections within the single design workspace is not important, but they must align vertically at the correct height along the vertical cross section, and none of the horizontal cross sections should overlap or touch.

If the size of the horizontal cross section differs from that indicated by the vertical cross section, upon conversion to a solid of revolution, the width of the horizontal cross section is scaled to match that of the vertical cross section. A warning dialog box will appear if the size difference is greater than 33 percent.

Graphics for labels

Graphics for labels must be in a layer of class **Label Graphics**. There can be more than one graphic in the same layer. Each label graphic should be a single group.

As with horizontal cross sections, the alignment point for a label is the middle of the bounding box for the graphic. To use an off-center alignment point, make a small cross or circle from print registration lines and group it with the graphic. This point is then aligned with the center of the solid.

Graphics in this layer are positioned on the solid of revolution as follows:

- If it extends above the top of the vertical cross section, the graphic is centered on the top.
- If it extends beneath the bottom of the vertical cross section, the graphic is centered on the bottom.
- If it is positioned between the top on the bottom of the vertical cross section, it is centered on the front.
- If there are two graphics that overlap vertically, the graphic on the right goes on the back.

Shown below are the label graphics for the oil bottle. Note the print registration circles through the M and O on the front label and through the bar code on the back label. They are aligned with the Y axis and thus ensure the labels are placed properly.



Shrink-wrap graphics

Shrink-wrap graphics must be in a layer of class **Shrink Wrap Graphics**. A shrink-wrap graphic wraps around the front and back of the design; it is not intended to cover the top or bottom. A shrink-wrap graphic must be rectangular. If it is made of multiple parts, group them together into a single group.

As with label graphics, the center of the bounding box for the shrink-wrap graphic defines the vertical position of the graphic on the solid of revolution. Any portion of the graphic extending beyond the top or bottom of the vertical cross section is discarded.

If the shrink-wrap graphic is not wide enough to wrap around the design, it is horizontally scaled to do so.

Do not mix label graphics and shrink-wrap graphics; use one or the other.

Do not turn on a Label Graphics layer if using shrink-wrap graphics.

Converting the single design to a solid of revolution

Once the single design is constructed with the layers defined and graphics added, click **File > Convert to > 3D** or the Convert to 3D button on the View bar. The Solid of Revolution Smoothness dialog box appears as shown below.

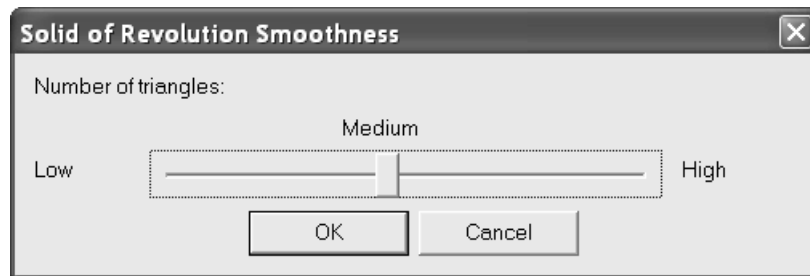

Solids of revolution are composed mainly of triangles. The quality and smoothness of the solid of revolution is directly proportional to the number of triangles. **However, the more triangles, the longer it will take to render the design and the longer it will take drag to refresh.**

Medium smoothness is recommended for most solids of revolution. The smoothness can not be adjusted once the solid of revolution is created. To adjust the smoothness, discard the 3D workspace and reconvert the single design, choosing a different smoothness when prompted.

To set the smoothness, adjust the slider in the Solid of Revolution Smoothness dialog box as desired and click **OK**. The solid of revolution is created and presented in wireframe form. Shown below is the oil bottle at low smoothness in both wireframe and rendered forms.

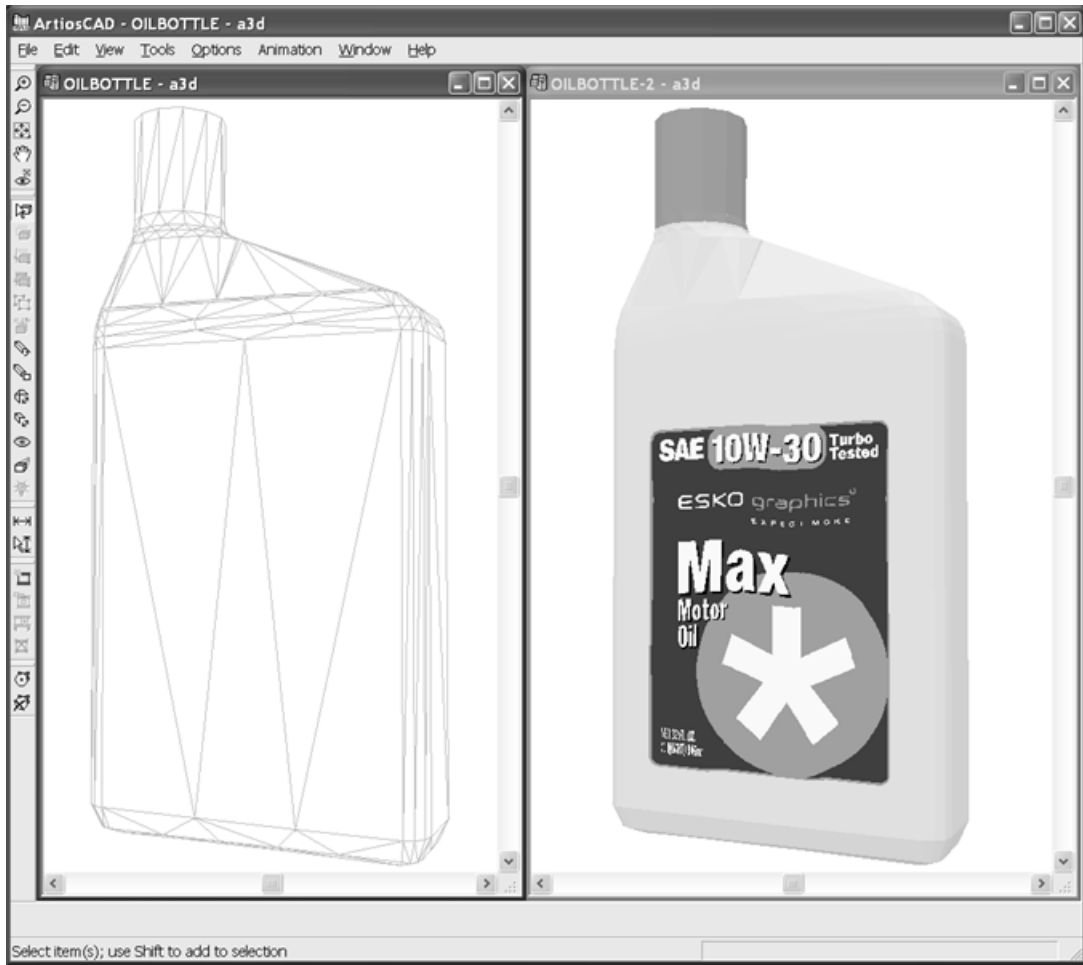

At medium smoothness:

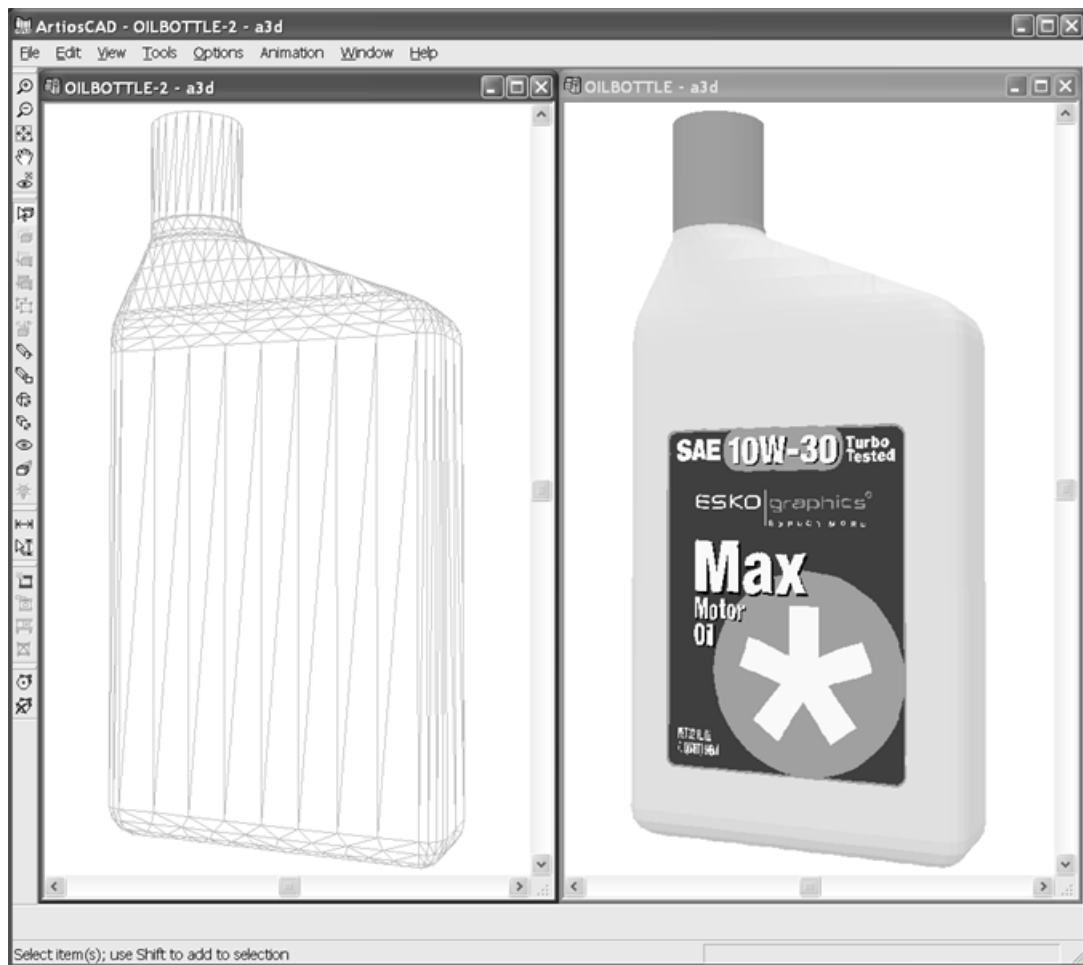

At high smoothness:

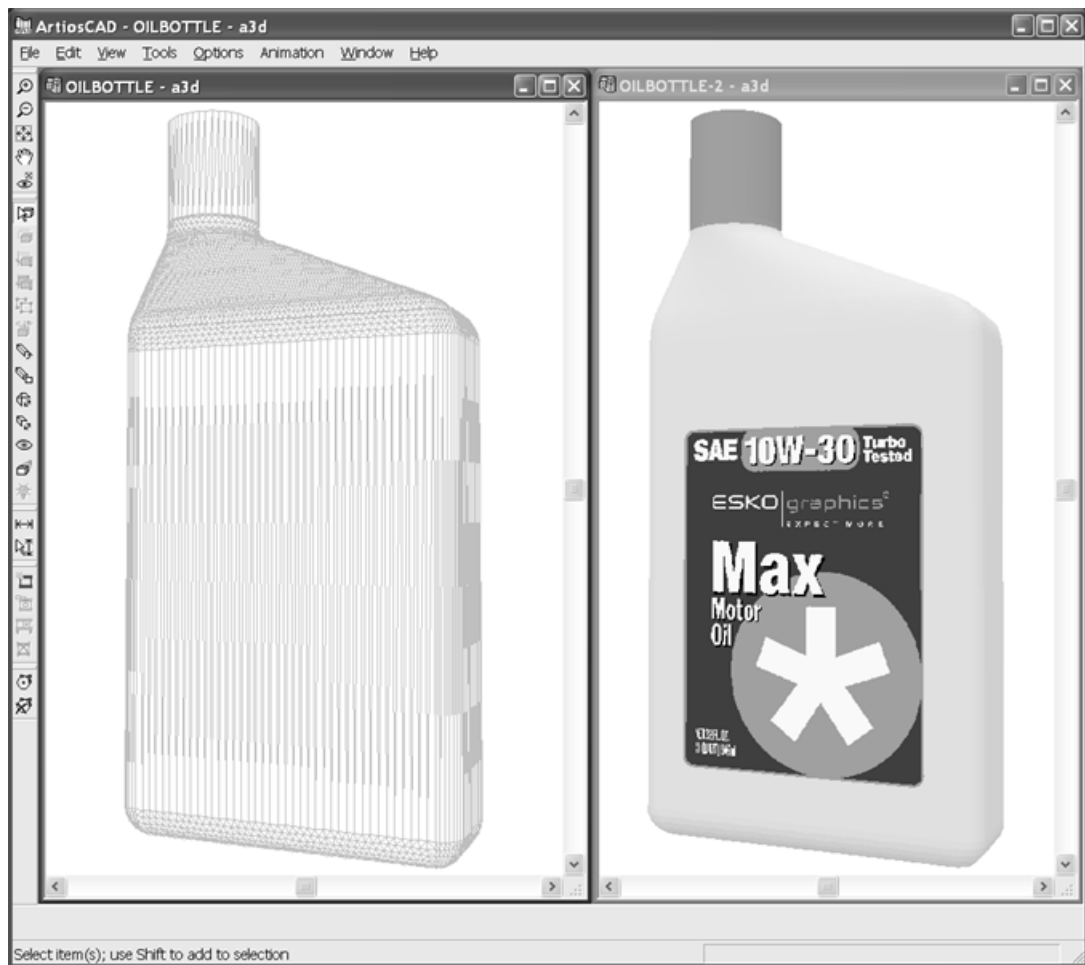

Once the solid of revolution is created, treat it like any other 3D object. Note that to snap to it, **Snap to solids** must be checked in **Options > Snap Options**.

Examples

The power of ArtiosCAD lends itself to many different kinds of solids of revolution. Solids of revolution can have lines that reverse direction, such as glasses. They also can be made from resizable designs - resize the design and create a completely different shape. Both the lager glass and the martini glass shown below were made from the same single design workspace.

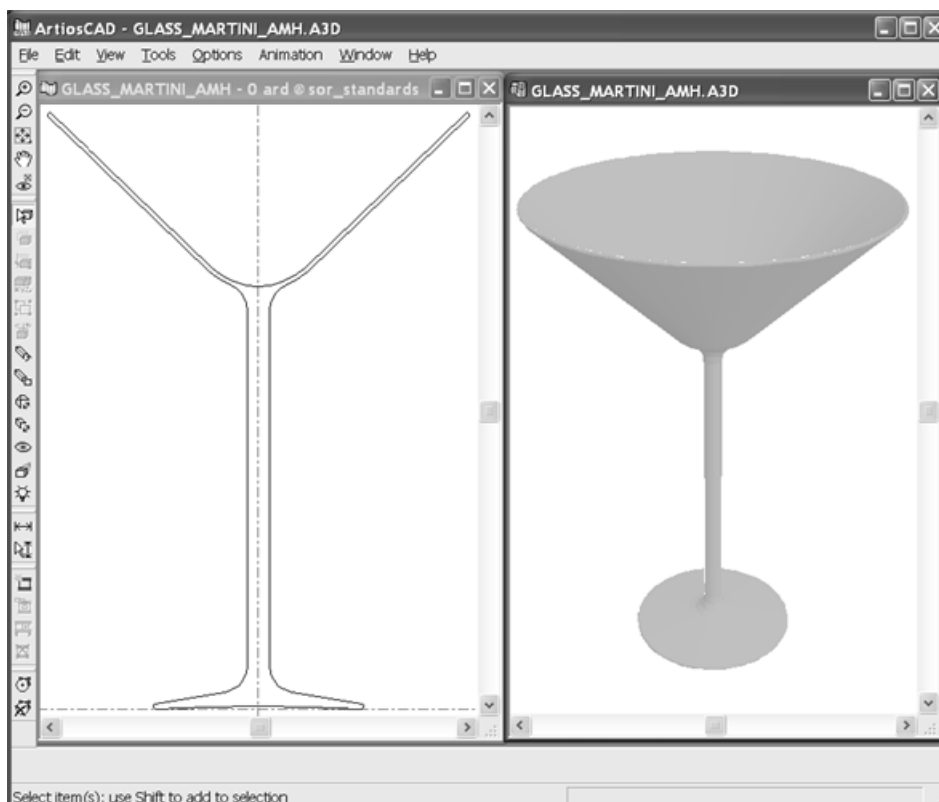
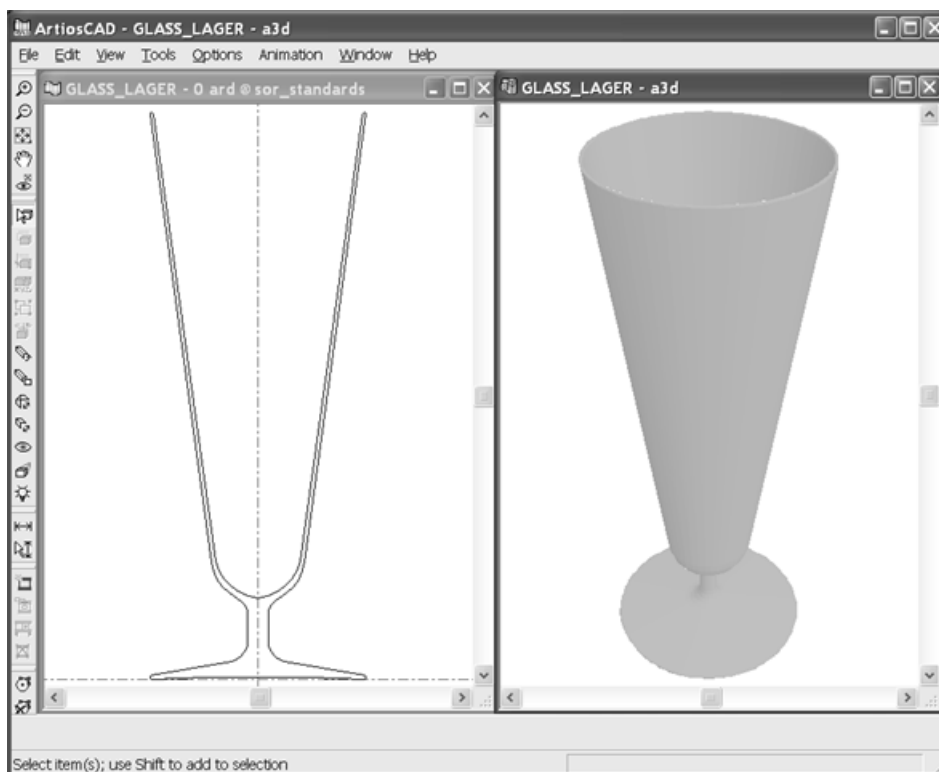

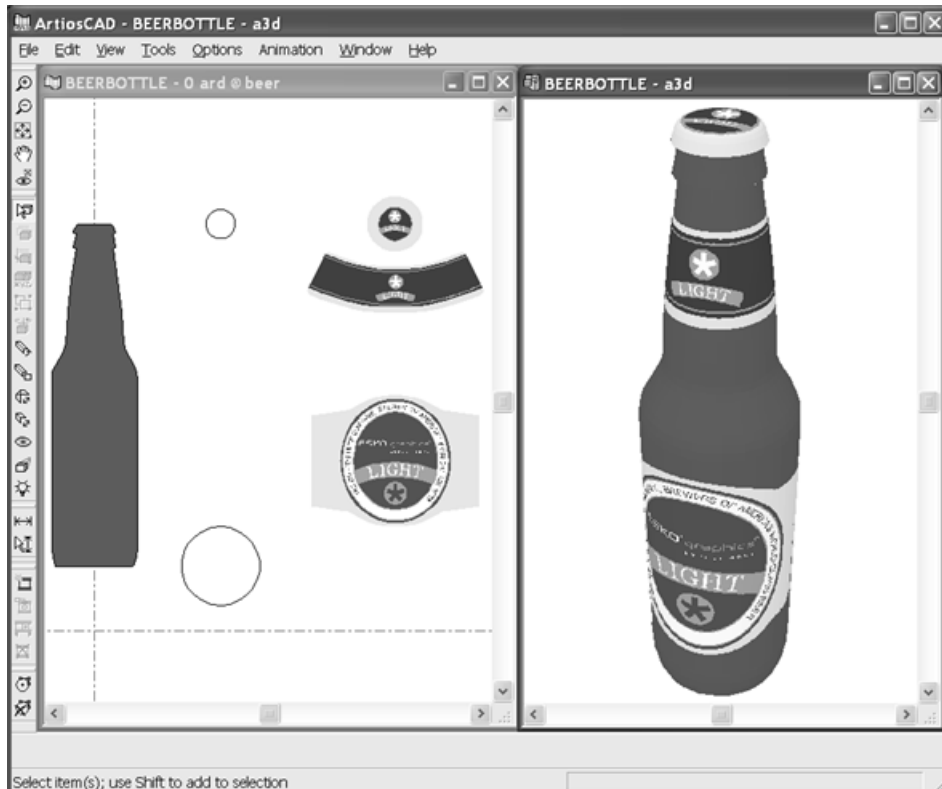
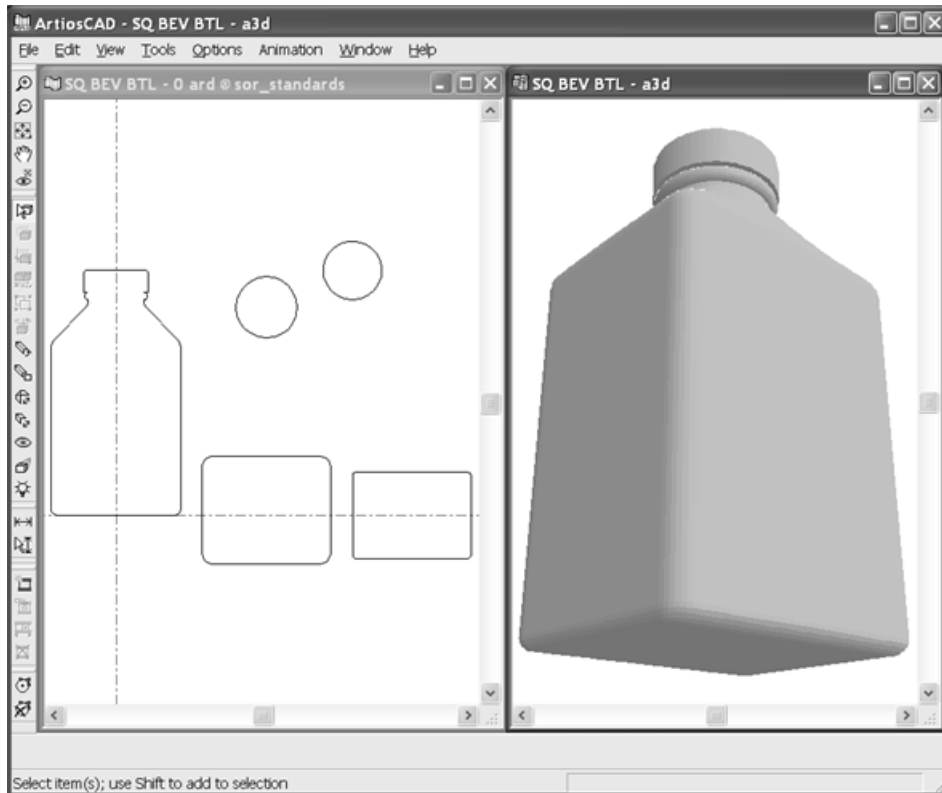

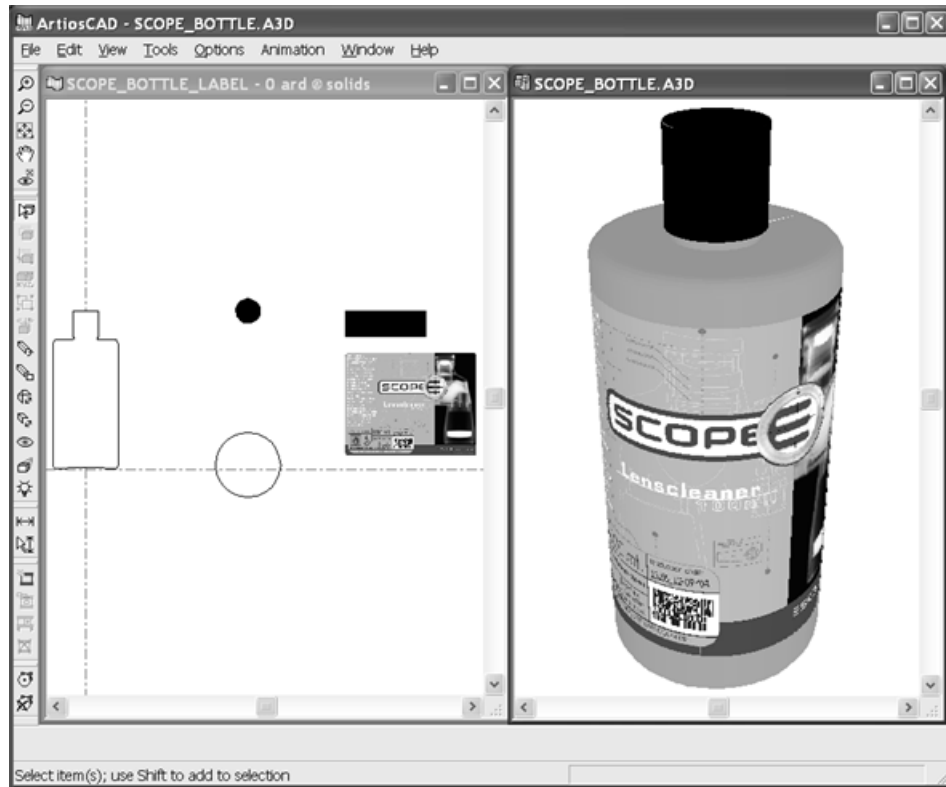

Solids of revolution notes and warnings

Use medium smoothness whenever possible instead of high smoothness, as solids of revolution made with high smoothness takes a long time to render and manipulate, even in wire frame view.

Do not make handles on single designs you intend to convert to solids of revolution. Make a handle as a separate design and add it to the 3D workspace.

Importing Other Solids

3D Designer also can import many different 3D models from other programs. Collada and VRML come with 3D, but other formats require the ArtiosCAD 3D Data Exchange option.

Table: Importable Solid File Formats

File Format	File Extensions	Versions Supported
ACIS	.sat, .sab, .asat, .asab	R1 - 2016 1.0
CGM	.xpgm	R2012 - R2015 and 2016 1.0
CATIA version 4	.model, .exp., .session	4.1.9 - 4.2.4
CATIA version 5	.CATPart, .CATProduct	V5R8 - V5R25 and V5-6R2012 - V5R27
IGES	.igs, .iges	Up to 5.3

File Format	File Extensions	Versions Supported
Inventor	.ipt	6 - 2016
	.iam	11 - 2016
Parasolid	.x_t, .xmt_txt., .x_b, .xmt_bin	9.0 - 28.0.159
ProEngineer	.prt, .prt., .asm, .asm.	16 - Creo 3.0
Solidworks	.sldprt, .sldasm	98 - 2017
STEP	.stp, .step	AP203, AP214 (geometry only)
Unigraphics	.prt	11 to NX10, NX to NX 11

Importing VRML files

VRML files contain polygons, lines, and images. ArtiosCAD can directly import the polygons from most VRML 1.0 and 2.0 files created by other CAD programs. ArtiosCAD also resolves links to external files and uses them if it finds them.

The tables below list what is supported and unsupported, with features and entities being in normal type and keywords being in bold.

Table: Supported VRML features, entities, and keywords

Polygons	Surface color	Shininess
gzip compression	DEF/USE	Units from ArtiosCAD VRML export
scale	Transform	Cube
translation	Group	Cylinder
rotation	Separator	Sphere
matrix	children	Cone
Shape	geometry	width
Material material	diffuseColor	height
Appearance appearance	ambientColor	depth
coord	emissiveColor	radius
point	specularColor	bottomRadius
Coordinate	ambientIntensity	
Coordinate3	shininess	

coordIndex

transparency

Table: Unsupported or Ignored VRML features, entities, and keywords

Animations	JavaScript	Lines
Points	Images	
WorldInfo	ShapeHints	vector
NavigationInfo	Texture2Transform	solid
Background	IndexedLineSet	eventIn
Viewpoint	Normal normal	eventOut
exposedField	ROUTE	WWWInline

If the directory **C:\TEMP** exists, ArtiosCAD puts a log file called **VRMLLOG.TXT** in it for diagnostic purposes each time a VRML file is imported. The file is overwritten each time.

Importing non-VRML files

When you import an ACIS, STEP, IGES, CATIA, ProEngineer, or SolidWorks file, ArtiosCAD performs three steps before the workspace opens in the design window:

1. The file is preprocessed to convert the 3D data into polygons.
2. The polygons are written to file <system temp directory>\TEMP.MSH.LOG.
3. ArtiosCAD reads the temporary file and opens it in a 3D workspace.

SolidWorks files can contain multiple configurations of how to present the model. If opening such a file, ArtiosCAD chooses the default configuration.

SolidWorks assembly files (ending in **.sldasm**) may also contain references to other parts files (ending in **.sldprt**). If any parts file is missing, ArtiosCAD ignores the missing parts and continues the import, but will tell you the name of the missing files.

Opening large files of 50 to 100 MB or hundreds of thousands of polygons can take a lot of time (up to a half hour) depending on the capabilities of your computer. **Save the 3D workspace as soon as it opens.** If the import or save fails for any reason, try opening the TEMP.MSH.LOG file to avoid repeating the initial conversion. Files larger than 50 to 100 MB may fail due to lack of memory or too many polygons for the display adapter to process. To show the number of polygons, click **Help > Diagnostics > List Embedded Designs.**



Use the **Select Labels or Parts** tool to select parts of solids to change their position or properties, or to delete selected parts by selecting them and pressing Delete on the keyboard.

Importing a Solid

Do the following to import a solid:

1. Import the solid into an open 3D workspace, or open it directly. A progress bar appears.

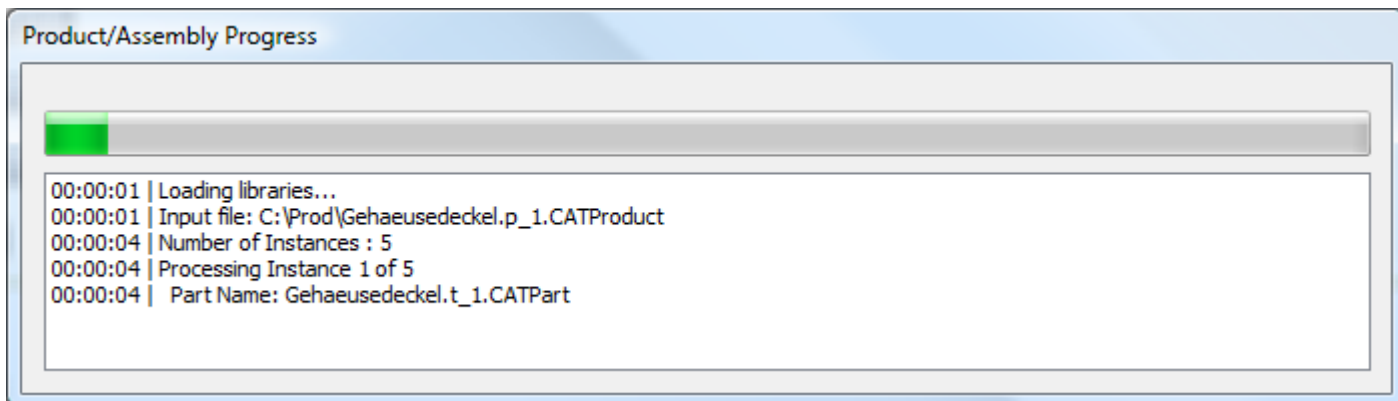

2. A preview of the solid appears. If it has parts defined, you can turn them on and off with the checkboxes next to their names, or on the **Part Selection** menu. To change to a defined angle in the view, choose an option on the **View** menu. You can also use the left mouse button to drag and rotate the camera, the scroll wheel to zoom in and out, and the right mouse button to drag and move the camera. Changing the view in the preview does not change the initial view of the solid when it opens in ArtiosCAD.

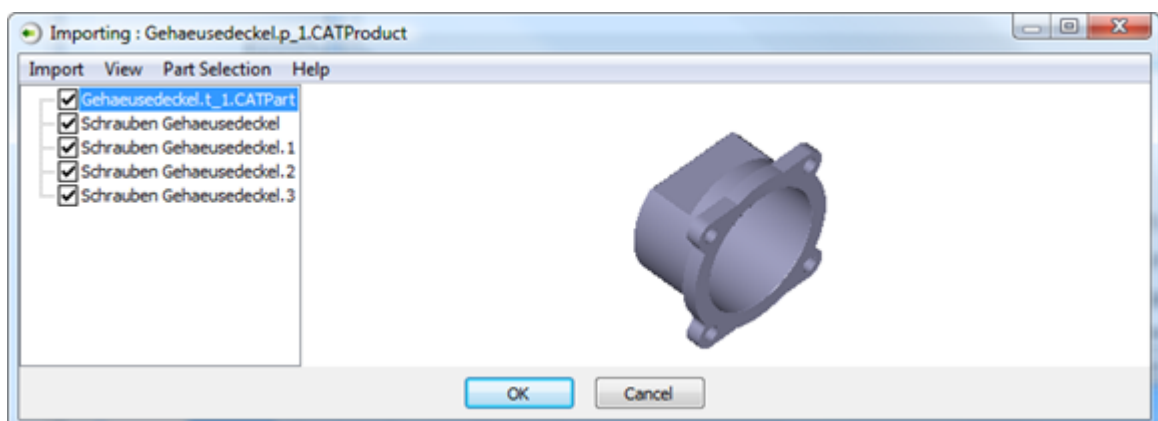

If there is no preview, that means there is no data ArtiosCAD can break into triangles, such as 3D arcs or 3D points. Also, there is no preview for SolidWorks files.

3. Click **OK** to finish importing the solid.

If you get an error message about an unsupported format, it could be because there are accented characters in the filename. Rename the file and try again.

Collada file format support

ArtiosCAD now supports the Collada intermediate file format for use in 3D.

The Collada format has two file types: .DAE and .ZAE. .DAE files are XML files that do not contain included graphics or other binary data. .ZAE files are compressed archives containing a .DAE file and the necessary textures, graphics, and other files to render the .DAE file properly.

The default Collada entry in the Outputs-3D Catalog creates a .ZAE file.

To preserve round-trip abilities between Esko applications, ArtiosCAD warns you when you try to adjust an object that originally came from a Collada file. When you import a Collada file, ArtiosCAD creates a link between the contents of its native workspace and the Collada file. If you then re-export that workspace as a .ZAE, ArtiosCAD bundles the original Collada file into the archive to carry over its information into the new file. Changing the properties of the imported objects in ArtiosCAD breaks that link, and that is the data loss referred to in the warning.

If the Collada file contains more than one object, ArtiosCAD groups the contents of the Collada file together upon import to keep them together.

If you will be exporting the workspace to Collada again, carefully consider the desired changes. It may be better to arrange the object(s) as desired in the source application before you export to Collada and import into ArtiosCAD.

ArtiosCAD can export 3D workspaces as single-body Collada files. On the Collada Options tab of a Collada 3D Output, **Output as single body** defaults to unchecked, but you may check it as desired.

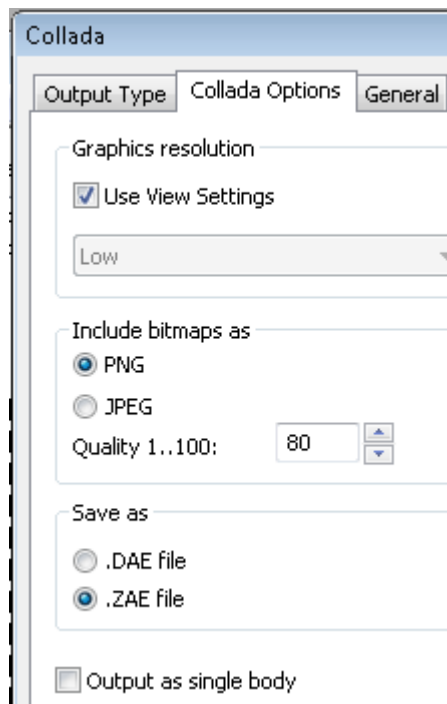

Selecting this checkbox turns off graphics in the exported Collada file as it may have one color and texture. ArtiosCAD will use the outside color for the body color.

Collada notes and warnings

When you export a foldable design from ArtiosCAD in Collada format that does not contain any graphics, Visualizer treats the entire design as if it were a print area, thereby allowing you to apply graphics.

When you load a Collada file with printable areas into Esko ArtiosCAD and no graphics are available, ArtiosCAD shows a checkerboard texture in those areas. When you export back to

the Collada format, that checkerboard texture will output with the Collada file as if it was the true graphic.

When you load a Collada file into Visualizer or Studio, the first printable area will be white, while the remaining printable surfaces will render normally.

For printable areas in a Collada file to be double-sided, there must be at least one transparent object in the scene.

Scale Designs tool





The **Scale Designs** tool changes the scale of solids. Use it when:

- A solid is at the wrong scale (for instance, it is measured in meters instead of millimeters and thus it needs to be scaled up by 1000).
- The size of a solid is not right and needs to be adjusted (for instance, when a cup is too short and needs to be taller).

In the first case, apply a uniform scale change, in which all three dimensions change equally. In the second case, apply a differential scale change, in which dimensions change independently of each other.

Note: You may need to update or recreate an animation sequence (if one exists) after using this tool.

1.  Select the solid(s) to change.
2.  Click **Scale Designs**. If you select a single instance of a solid with multiple copies, ArtiosCAD asks if you want to modify all the copies or just the selection. Note that if you make a separate copy, ArtiosCAD cannot undo that action.



3. In the Scale Solid Designs dialog box, choose the appropriate options for your desired changes.
 - a) Choose either **Uniform scale** or **Differential scale**.
 - b) For X, Y, or Z, enter either the new size or choose a scale factor from the drop-down list box. Click inside the Scale factor field to enter a custom value. ArtiosCAD shows the size of the bounding box for the selected design(s) as the initial size.

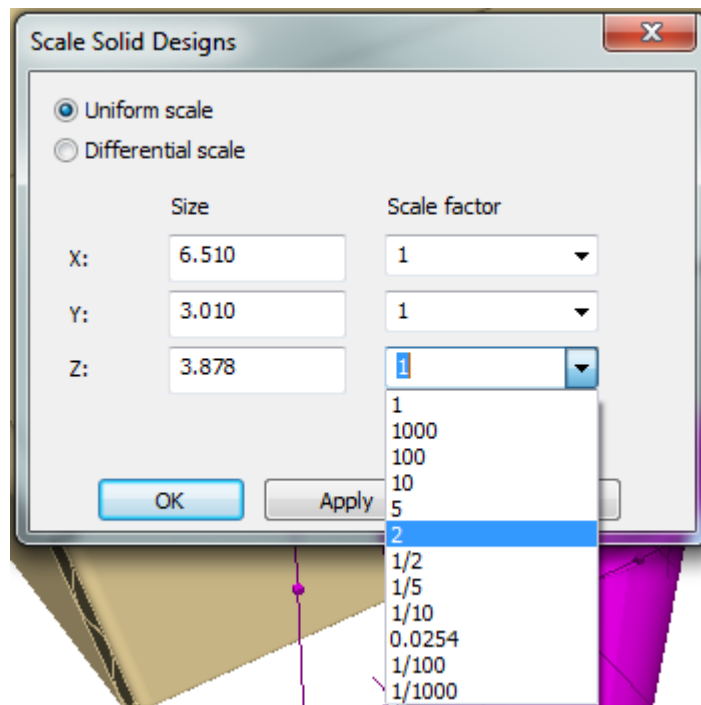

4. Click **OK** to apply the changes and return to 3D or click **Apply** to apply the changes and remain in the dialog box for more changes. ArtiosCAD scales the selection around the center of the overall bounding box. It does not change the position of the object(s) after changing the scale, so you may need to move them manually (as seen below by the intersecting side of the tray).

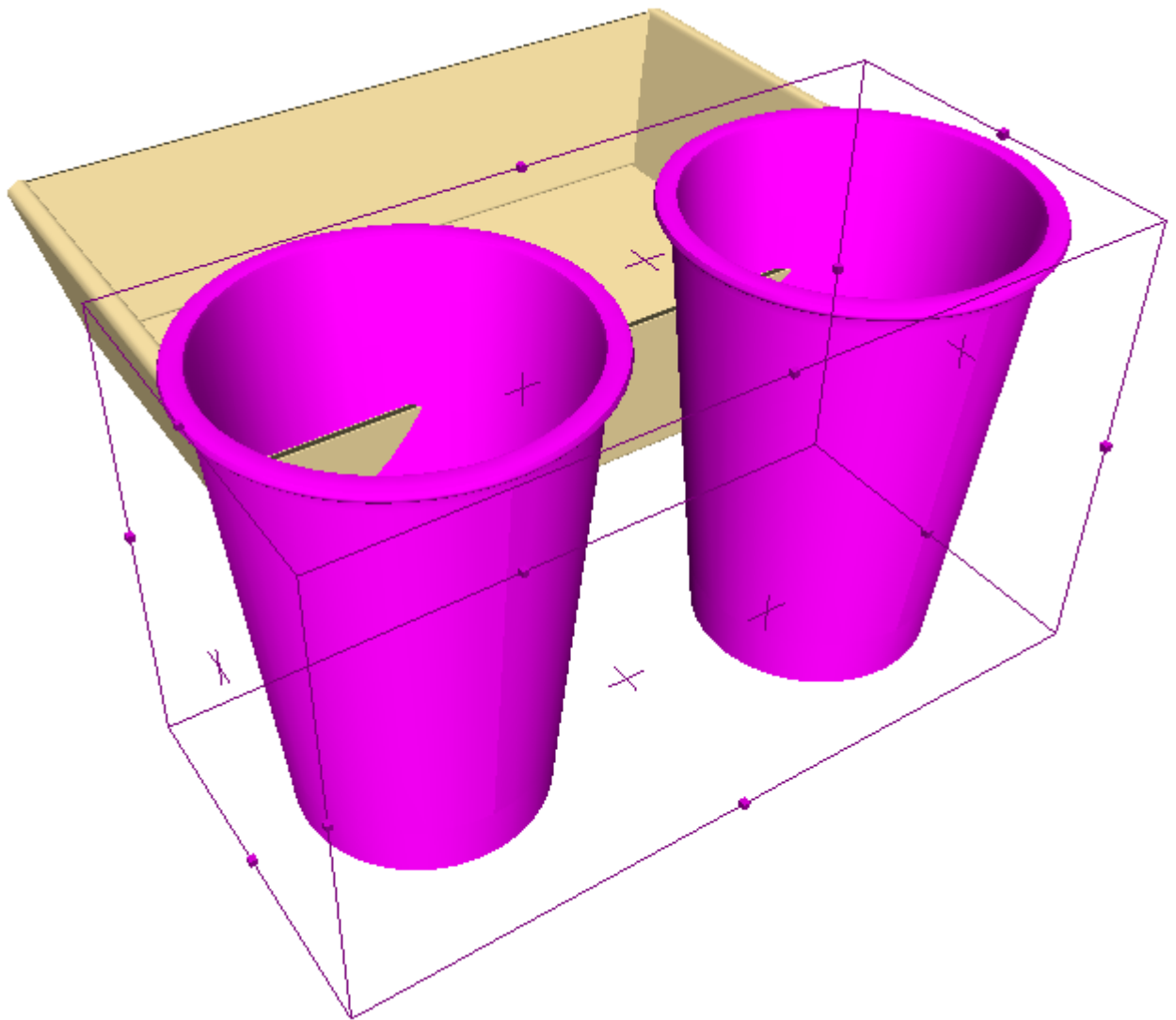

Cross Sections

The tools on the Cross Section toolbar let you make and adjust pieces of folding carton or corrugated board that intersect with objects in the 3D workspace. These tools require the 3D Designer license.



Intersect Design tool

 The **Intersect Design** tool creates holes in a corrugated or folding carton design where it intersects other designs or solids. The tool has the following controls on the Status bar:

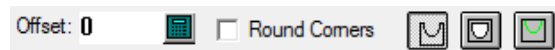

Enter a value in the **Offset:** field to specify a gap between the intersecting object and the cutout in the intersected object.

 The first button on the Status bar, **Intersect Designs**, sets the tool to use cut lines to make the hole boundaries in the flat design.

 The second button on the Status bar, **Intersect Designs All The Way Through**, sets the tool to make complete cut-outs for objects such as wine glasses.

 The third button on the Status bar, **Intersect Designs with Annotations**, sets the tool to use annotation lines to make the hole boundaries in the flat design.

To use the tool, do the following:

1. Position the objects together.
2.  Click **Intersect Design** on the Cross Section toolbar.
3. On the Status bar, enter an offset if desired, select or clear the **Round corners** checkbox (to create rounded corners in the holes), and choose the mode for the intersecting lines.

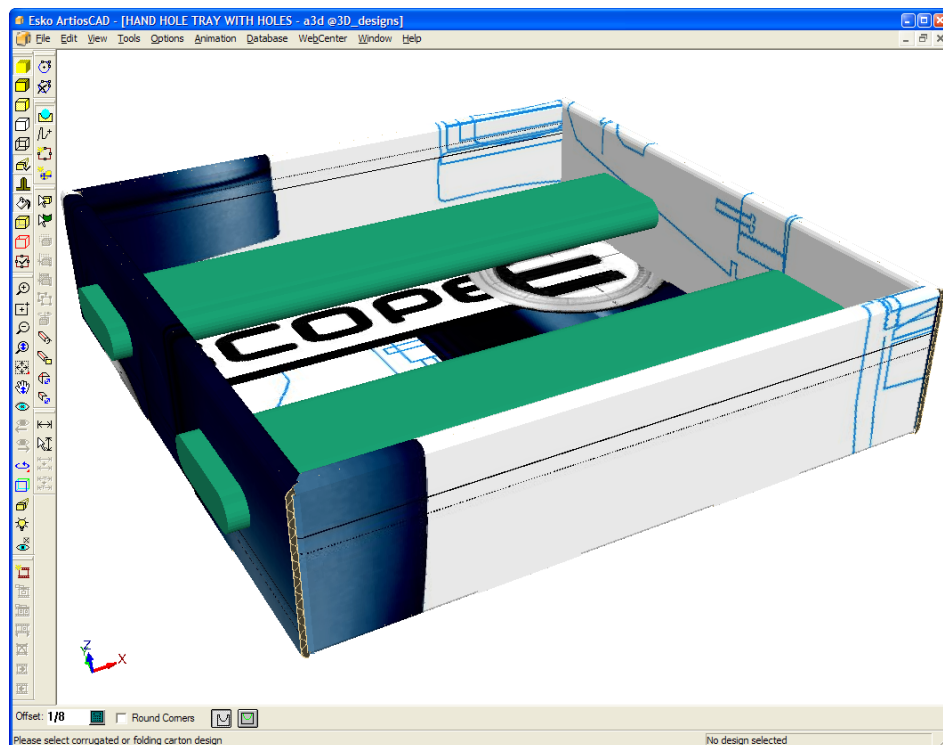

4. Click the intersected corrugated or folding carton design.
5. If the single design workspace corresponding with the selected 3D object exists, ArtiosCAD prompts you to update it or create a new single design. Set the option button as desired and click **OK**. Clicking **Cancel** stops the tool.



6. Choose a parameter set for the design. If you are updating the existing design, the previously-selected parameter set is selected.

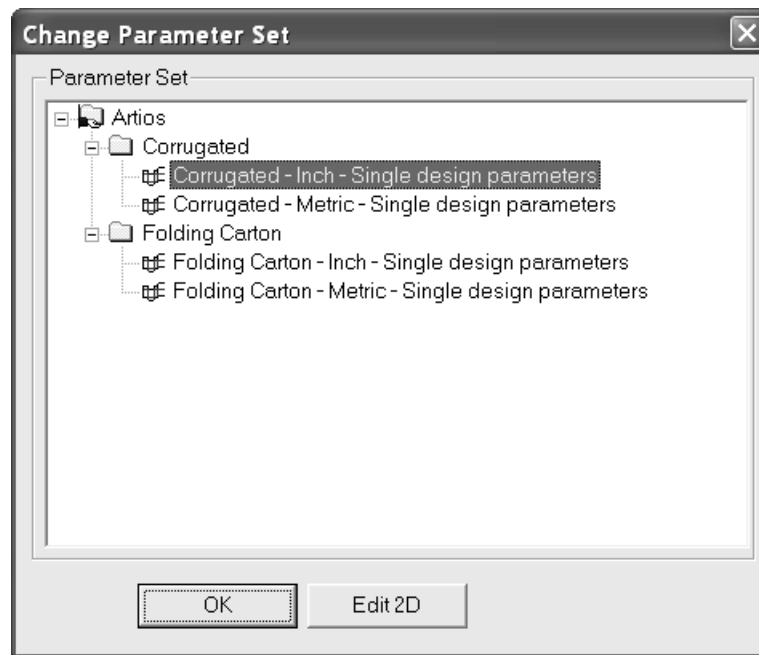

To accept the changes to the single design and return to 3D, click **OK**. You may want to move the dialog box to see more of the design.

To make changes to the single design, click **Edit 2D**, make the changes, click **Convert to 3D** on the View bar, and update the 3D workspace.

7. Once you return to 3D, the view changes to show transparency with purple edges to make the new holes more visible. Clicking any Select tool turns off the temporary transparency. Shown below is tray with temporary transparency turned on and the 1/8" offset around the solids.

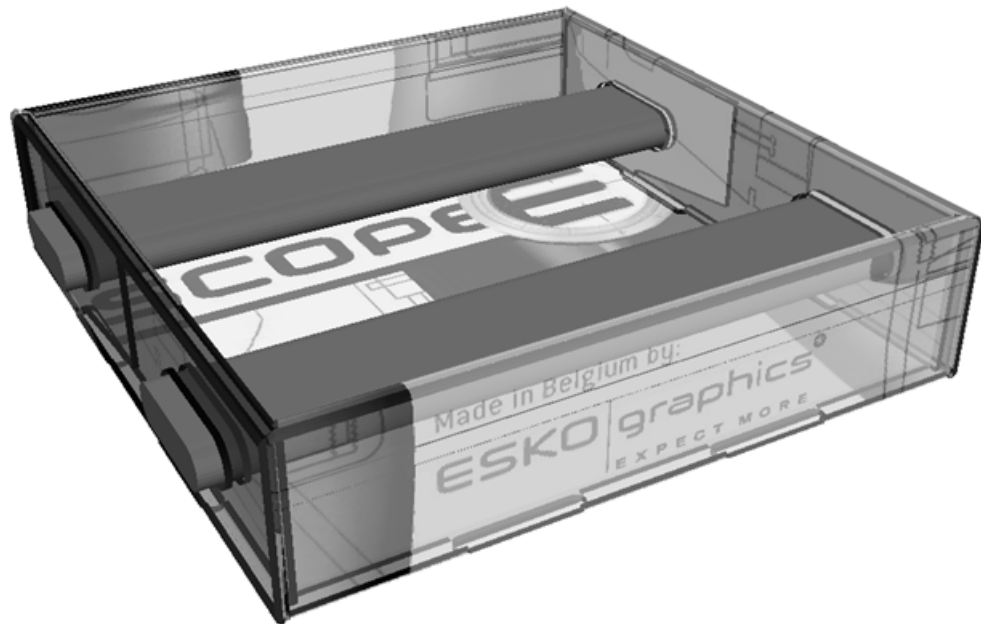

Shown below is the final result with the bars removed.

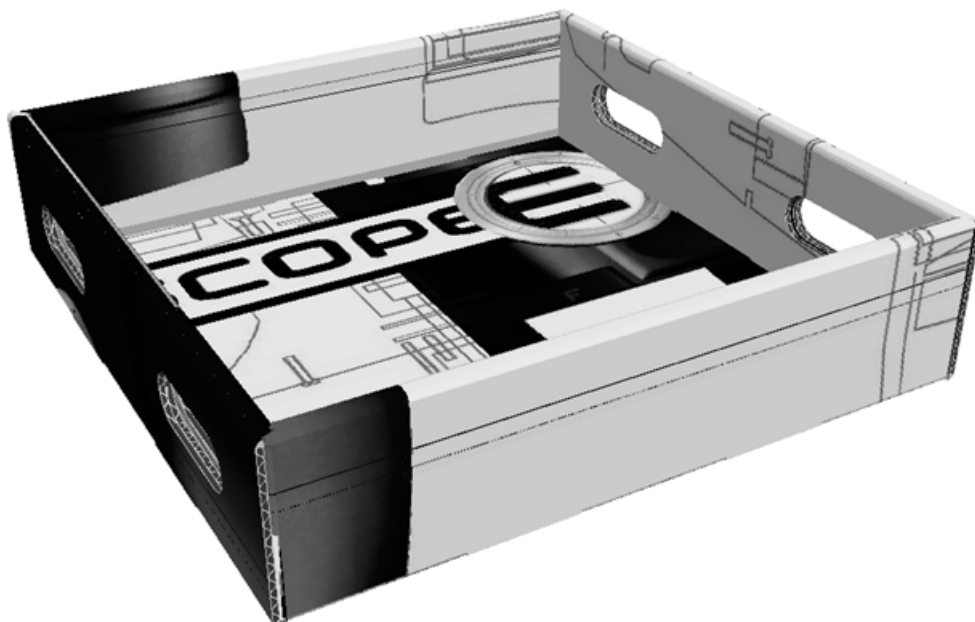

Note: Any copies of the design will have the same holes made in them.

The filename for the flat workspace containing the intersected design is generated from the filename of the 3D workspace, plus a number that increments by one for each intersected design.

Cross Section tool

 The **Cross Section** tool creates a piece of folded board with cutouts for the portions of objects it intersects. The size of the bounding box determines the size of the folded board created by the tool. Before using this tool, adjust the bounding box as needed using the instructions in the next section.

To use this tool, click it, select the start point of the piece of folded board, and make the desired geometry using drag similar to that of the Line tool in Single Design. Shown below is a step in the construction of a cross section.

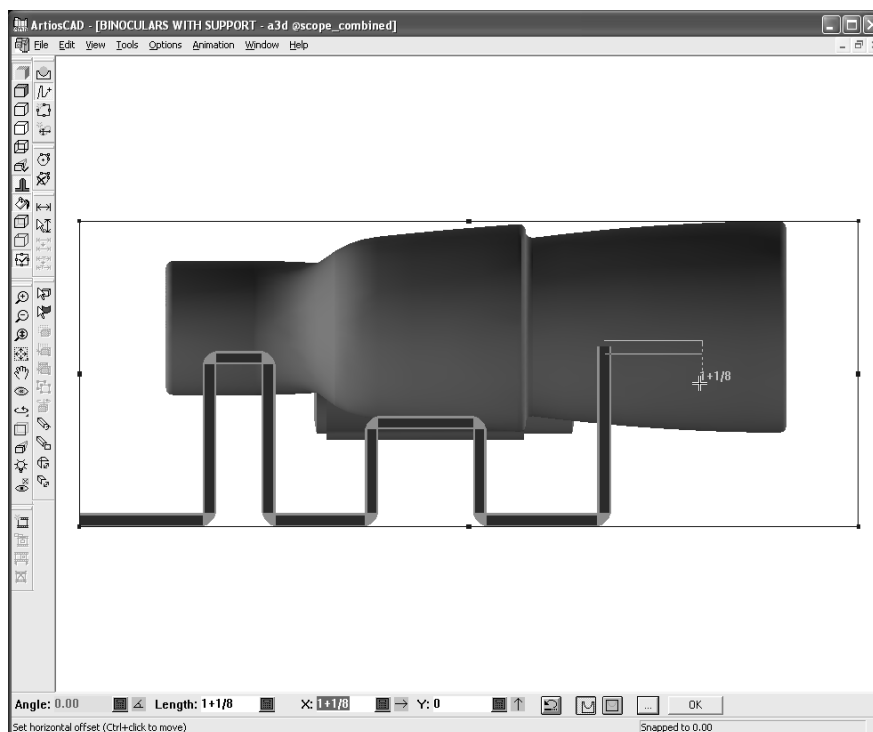



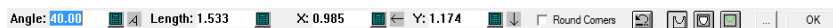

Shown below are the controls on the Status bar in greater detail.



The **Angle**, **Length**, **X**, and **Y**: fields all behave as they do for the Line tool in Single Design. **Round Corners**, when selected, has the tool create rounded corners in the holes it creates.

 The **Undo** button undoes the last piece of geometry created. It is very important to use this button instead of pressing CTRL-Z, as pressing CTRL-Z will undo everything the tool has made up to that point, not just the last segment.

-  The **Intersect Designs** button has the tool create cut lines in the folded board where it passes through other objects.
-  The **Intersect Designs All The Way Through** button has the tool create complete cut-outs for objects such as wine glasses.
-  The **Intersect Designs with Annotations** button has the tool create annotation lines in the folded board where it passes through other objects.
-  Clicking **More Options** opens the Cross Sections Parameters dialog box:

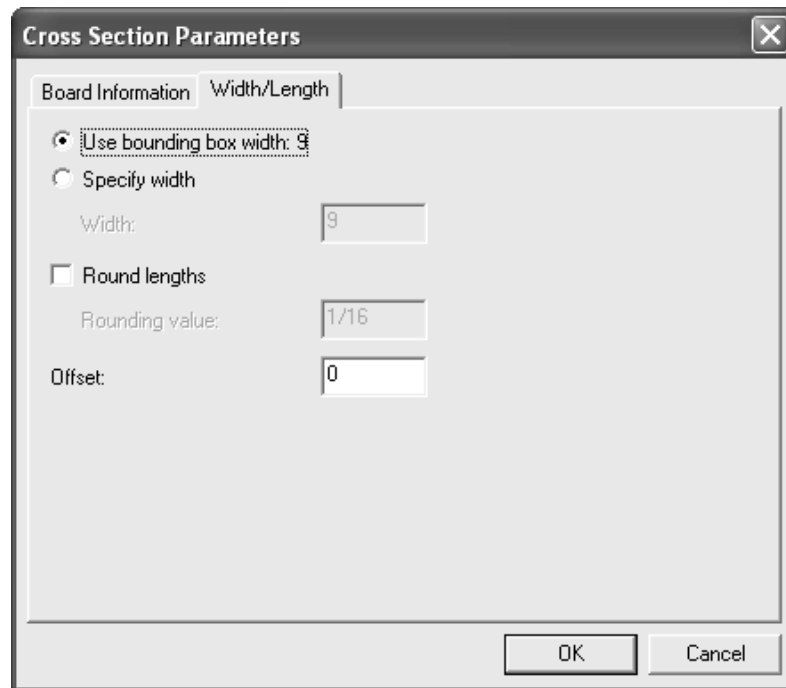

The Board Information tab lets you choose the board and set the caliper of the folded board. The default board is used initially, but if you change it, the new board becomes the default for the tool in the current workspace.

On the Width/Length tab, choose to **Use bounding box width** to set the size of the folded board, or click **Specify width** and enter a value in the **Width:** field.



Round lengths rounds the board lengths to the nearest increment specified in the **Rounding value:** field. When checked, it is initially set to the rounding value set for the board.

A value in the **Offset:** field adds a gap between the piece of folded board and the object being cross sectioned.

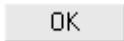
Note: Defaults for the **Intersect Design** and **Cross Section** tools are in **Options > Defaults > Shared defaults > Startup defaults > 3D Tools Defaults**.

 Clicking **OK** on the Status bar completes the geometry and calculates the cross section. The amount of time it takes to make the cross section depends on the complexity of the design as well as your computer hardware. Clicking another tool before clicking **OK** cancels the cross section completely.

To make a cross section, do the following:

1. Open the design that will have a cross section made around it.
2.  Use the **Bounding Box** tool to modify the size of the bounding box.
3.  Click the **Cross Section** tool.
4. Click the start point for the piece of folded board. To move by an offset from that point, hold down CTRL and click in the desired location.
5. Click and drag to make the desired geometry. The drag snaps to existing lines, but also has enough of a cutback to allow for the board thickness depending on where you click. You can hold down CTRL while clicking to move the start point for the geometry, but make sure all pieces are connected.

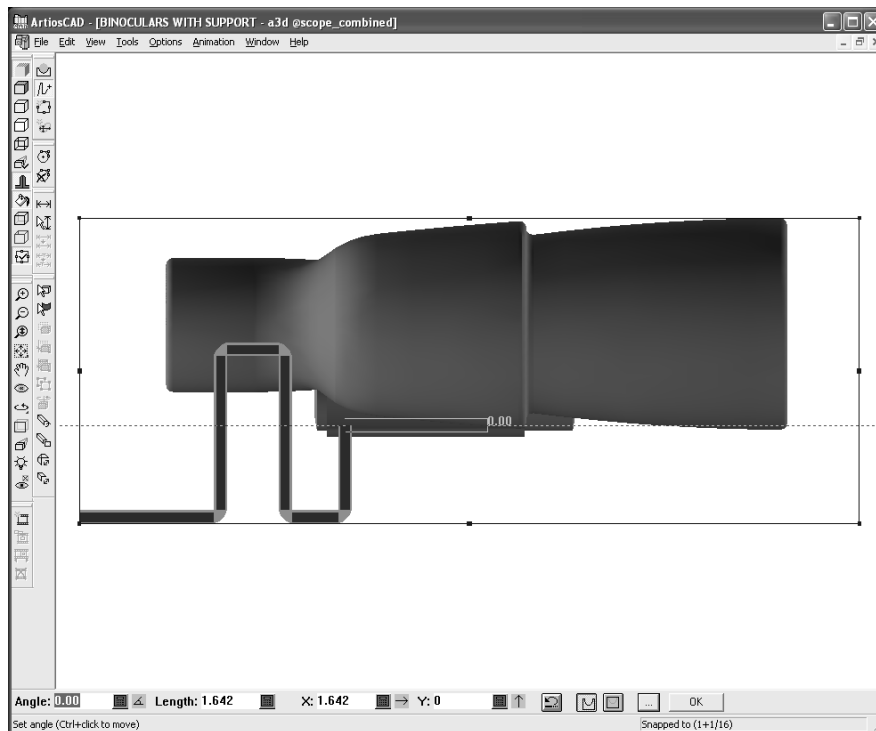

6. When done creating geometry, click **OK** to create the piece of folded board.
7. Choose a parameter set for the folded board.

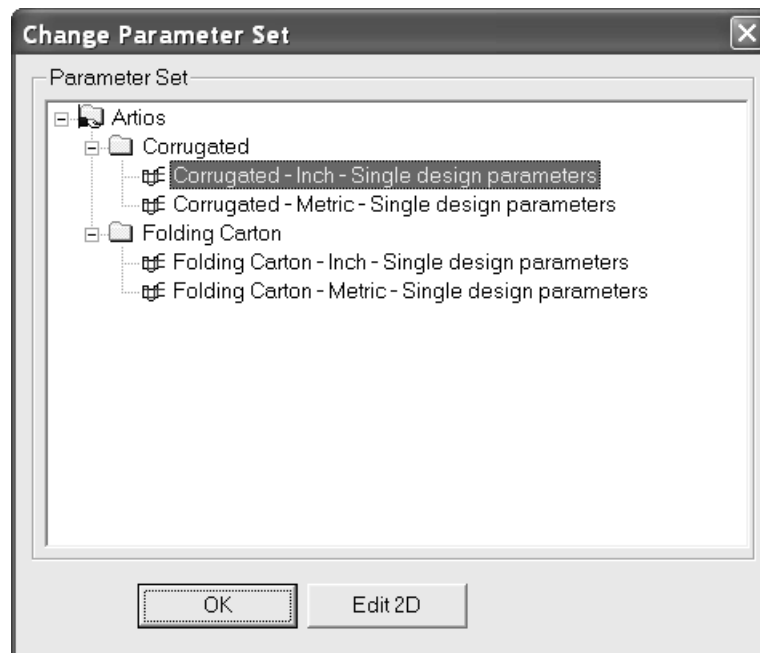

To accept the folded board and return to 3D, click **OK**. You may want to move the dialog box to view more of the design.

To make changes to the folded board, click **Edit 2D**, make the changes, click **Convert to 3D** on the View bar, and update the 3D workspace.

8. Once you return to 3D, the view changes to show the folded board in transparency with purple edges and no perspective, and the View Angle tool is activated. Clicking any Select tool turns off the temporary transparency.

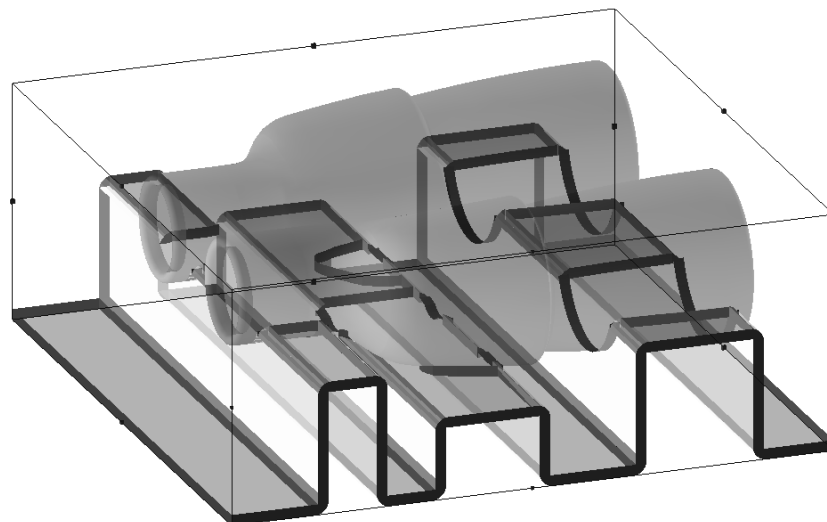

Shown below is a view from underneath to show more detail.

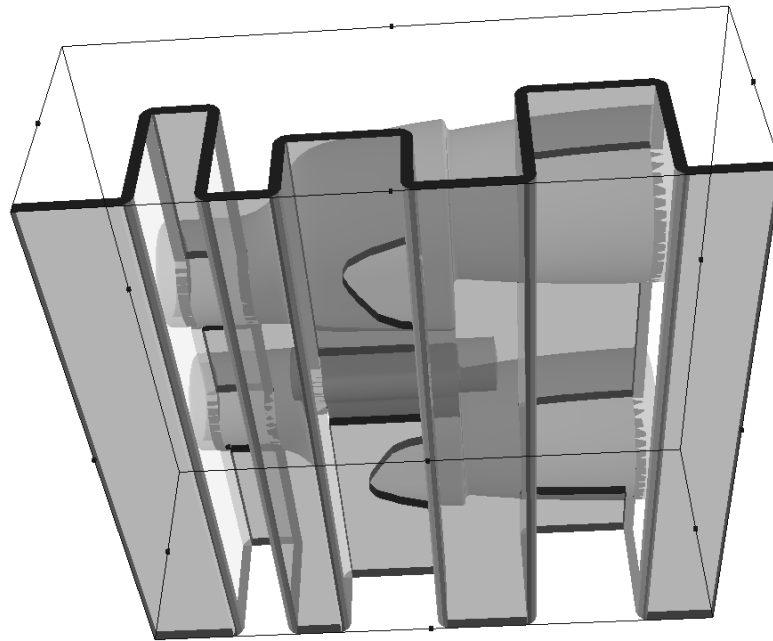

The folded piece of board is a series of panels connected with creases or reverse creases depending on the fold angle. ArtiosCAD positions the design so there are more creases than reverse creases.

The filename for the flat workspace containing the folded piece of board is generated from the filename of the 3D workspace, plus a number that increments by one for each cross section workspace.

Bounding Box tool



The **Bounding Box** tool creates a bounding box around all the objects in the 3D workspace, and lets you adjust the size of the bounding box. The **Cross Section** tool uses it to define the size of the flat design created as a cross section, and the **Run a Standard** tool uses it for the dimensions of the standard it creates.

The bounding box grows to accommodate designs added to the 3D workspace, but is unaffected when objects are removed.

Note: The Bounding Box tool does not work with CloseUp windows.

When you click the tool, the view changes to the closest orthogonal view, and perspective is turned off. The fields on the Status bar become available when you click a side of the bounding box. The drag is for the active field in the Status bar.

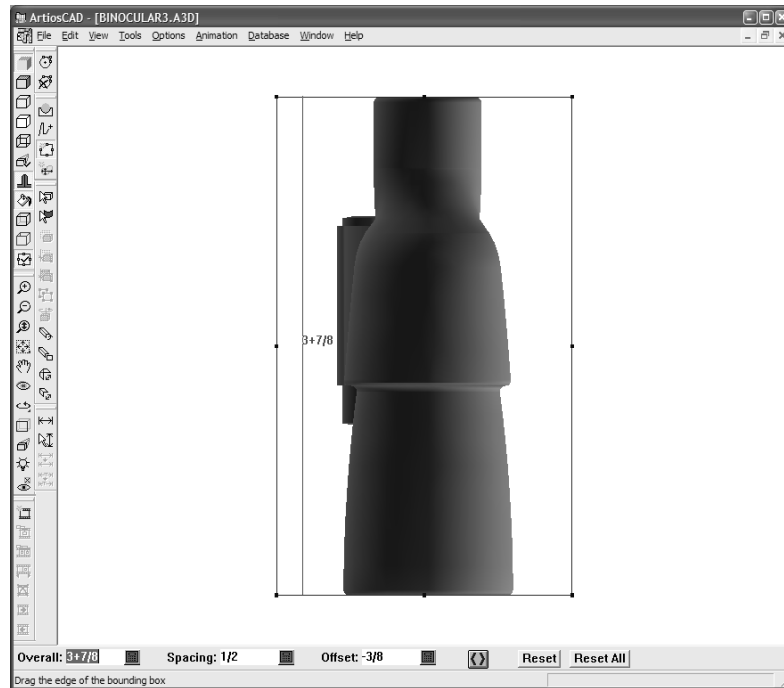

Shown below are the controls on the Status bar:

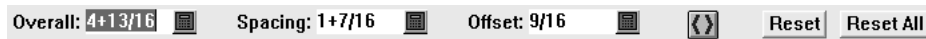

The value in the **Overall:** field shows the distance from the opposite side of the bounding box. **Spacing:** refers to the distance from the closest edge of a design. **Offset:** is the distance from the previous position of the side being adjusted.

 The **Move Both Sides** button toggles the adjustment of both parallel sides at once.

Reset snaps the last bounding box edge adjusted back to its minimum spacing from the edge of the object.

Reset all adjusts the bounding box edges to encompass all items in the 3D workspace.

Only two dimensions are shown in the orthogonal view. Use the **Rotate View** tools to adjust the view so that the other dimension of the bounding box can be adjusted.

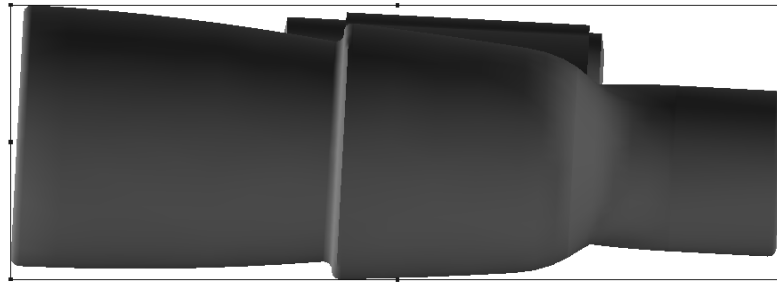

Rotating solids using the bounding box

When importing a solid, it may not be defined to be square to its bounding box as shown below. Use the bounding box and the **Align With** button in the **Rotate** tool to make it square to the bounding box.



Note: **Snap to solids** must be selected in **Options > Snap Options** for this procedure to work.

To make the binoculars square to the bounding box, and to resolve similar situations with other solids, do the following:

1.  Click the **Bounding Box** tool to show the bounding box and change to orthogonal view.
2. Select the item to adjust.
3.  Click the **Rotate** tool and click the axis around which to rotate the object. In the example below, the axis orthogonal to the view is selected.

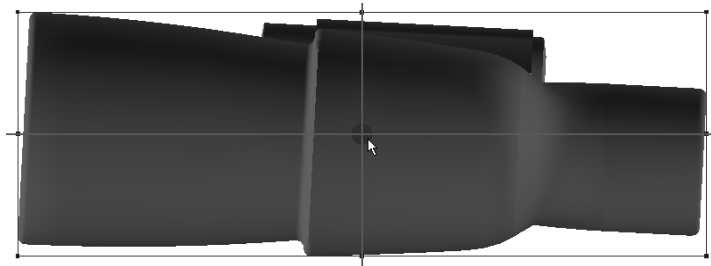

4. Click the edge of the solid to align with the bounding box. For the binoculars, the bottom edge of the bigger lens was used.
5. Click the edge of the bounding box with which to align the object.
6. The object rotates.

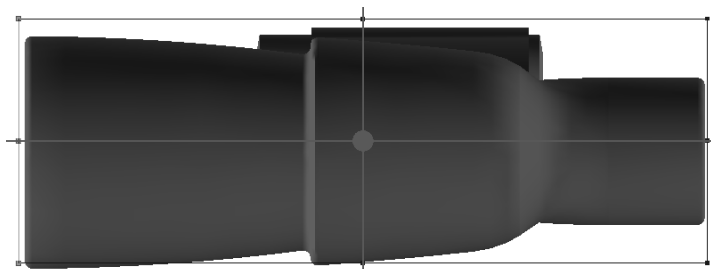

7.  Note how the bounding box is no longer correct. Click the **Bounding Box** tool and use the **Reset** button to snap the edges to their minimum clearances. Shown below is the final result.

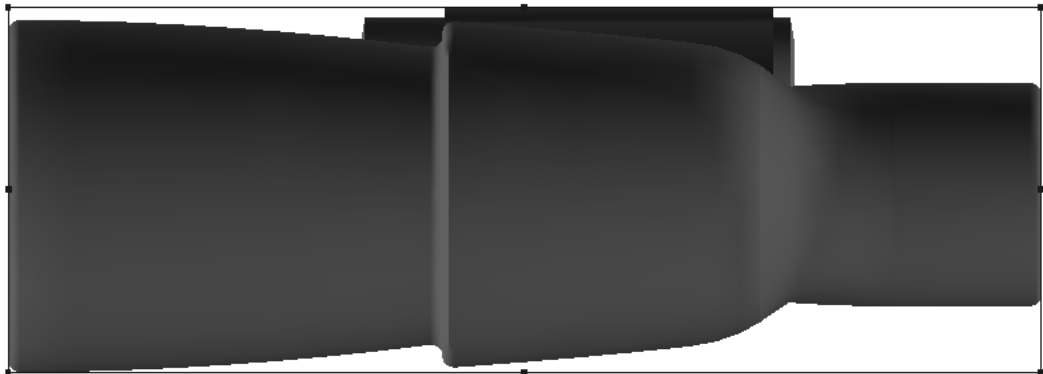

Run a Standard tool

 The **Run a Standard** tool creates a design from a Standards Catalog entry using the dimensions of the bounding box as the dimensions of the design.

To run a standard, do the following:

1. Adjust the bounding box as desired. You may want to make it slightly bigger than the object it will contain to allow for board thickness.
2.  Click the **Run a Standard** tool.
3. Click the side of the bounding box that will be the length dimension of the new design.
4. Click the side of the bounding box that will be the width dimension of the new design.
5. Choose a standard from the Standards Catalog and click **OK**.
6. Choose a parameter set and board and click **OK**.
7. If the standard does not contain any of the L, W, or D variables, map the existing variables to the length, width, and depth and click **OK**.
8. Proceed through the standard prompts as usual, clicking **Next** to go to the next menu or **OK** to skip the remaining menus and make the design.
9. Choose a base face for the new design. It appears in the 3D workspace. If the standard contains fold angles, they are used; if not, the design is shown flat.

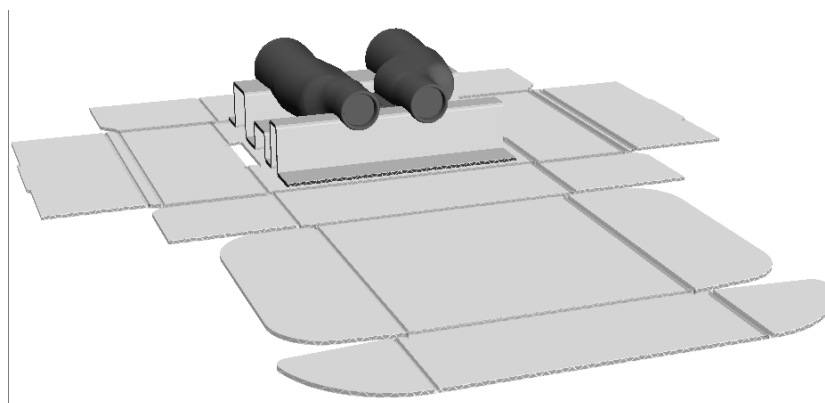

10. Fold it as desired.

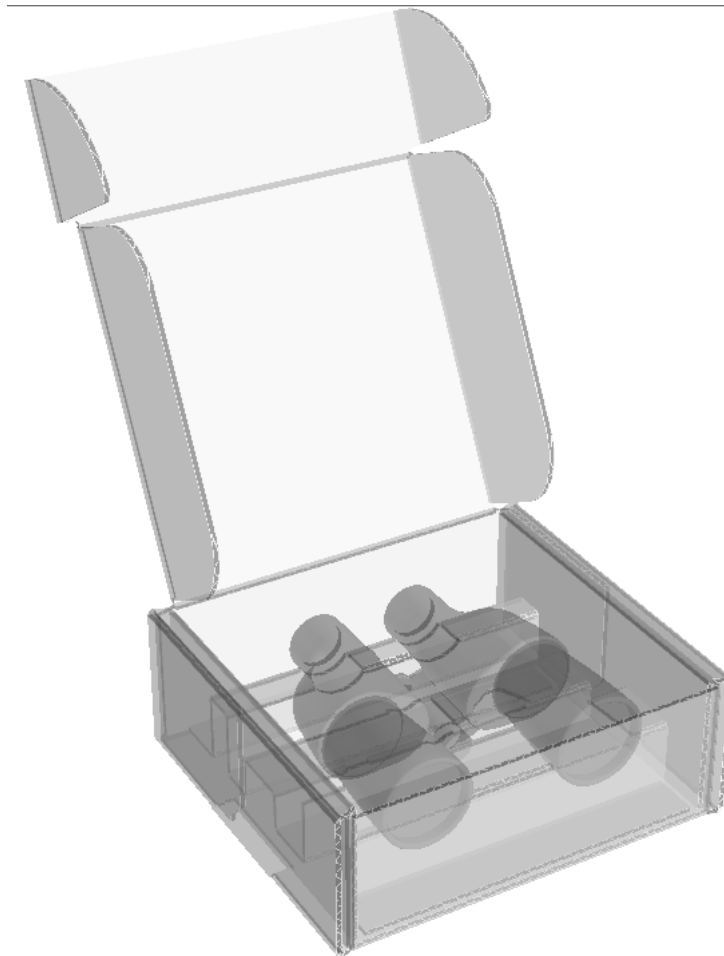

11. The single design will be open in another ArtiosCAD window. Save it as desired.

Note: Designer WorkBench standards, or those that reference them, may not be used with this tool.

Note: If the standard contains a crease that crosses more than one panel, a warning will appear. If you proceed, panels may be missing from the 3D design created. For best results, split creases in standards that cross panels.

Convert to 2D tool

The **Convert to 2D** tool on the Tools menu lets you create a flat design out of a corrugated or folding carton design in a 3D workspace. This is useful when you receive a 3D workspace from someone else without the corresponding flat design(s) and you want to make changes to the design(s).

When you convert a design to 2D from 3D, the following restrictions apply:

- Curved lines are converted from a series of straight lines into arcs. Arcs smaller than 3 millimeters may not be converted exactly as they were in the 3D design.
- The 2D design line pointages are all set to 2.
- Cut lines should have most of their bridges but crease lines will have none.

- The 2D design will have no graphics.

For example, if you received the workspace shown in the Cross Section tool documentation, and needed to modify the piece of corrugated board supporting the binoculars, you would do the following:

1. Click **Tools > Convert to 2D**.
2. Choose a parameter set and click **Edit 2D**.
3. Edit the flat design as desired in Single Design.

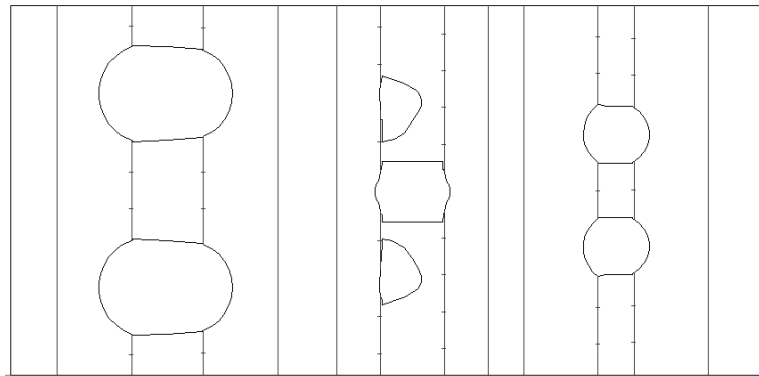

4.  Click **Convert to 3D** on the View bar, choose **Update 3D**, click **OK**, select the base face, and click **OK**. The updated workspace is shown.

Add Hardware Tool



Add Hardware adds solid hardware such as hooks and their associated holes to the 3D design, and, if the corresponding 2D design is open, the holes required for the hardware to the 2D design and placement lines to assist with rebuilding and reconvertig. It also allows you to place products on the hooks. You can place just one hook in Single Placement mode, or you can place an array of many hooks in Array Placement mode.

Shown below is a countertop display with the tray part filled by **Array Copy** and hooks and products applied in an array to the header by **Add Hardware**.



If you view the back, you can see the holes and the hook attachment pieces.

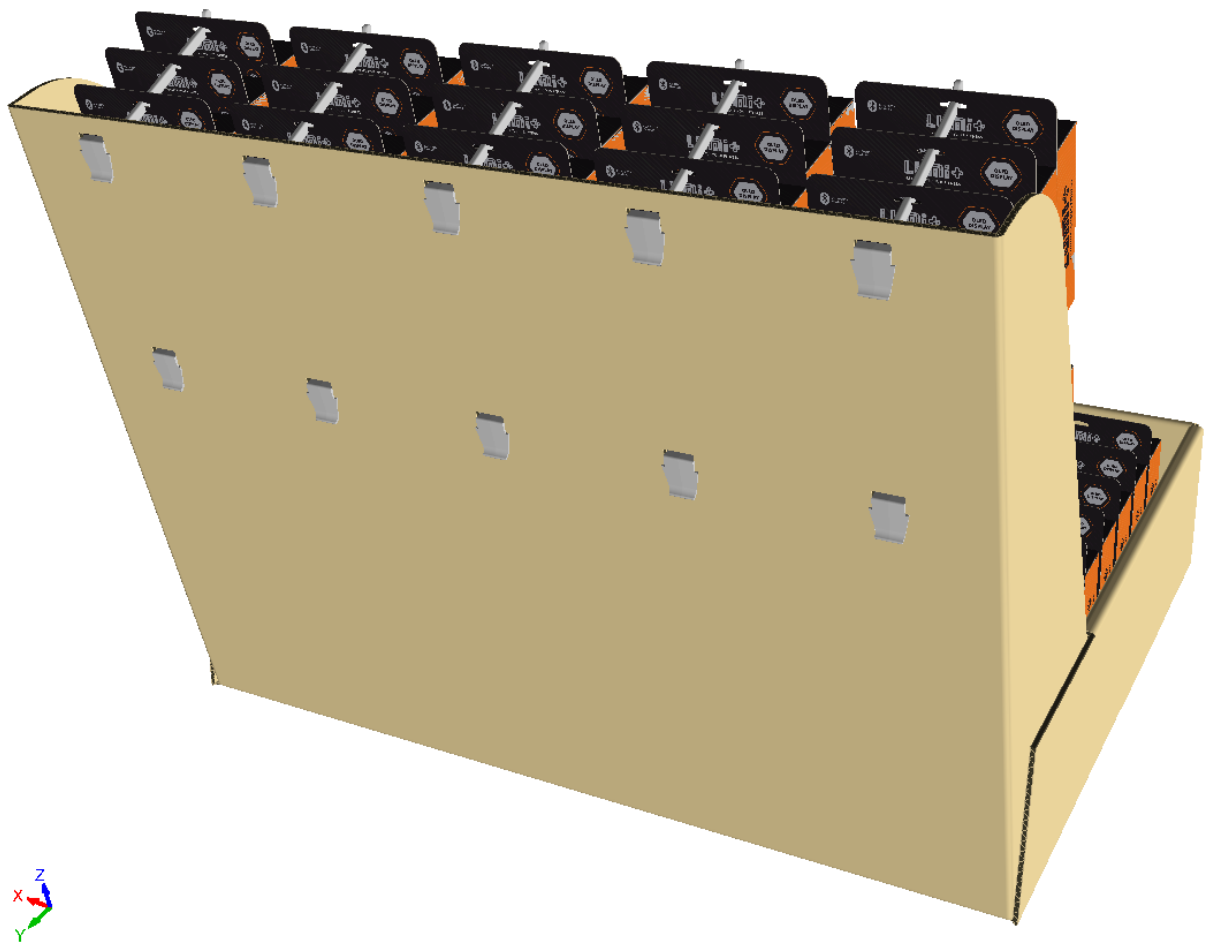

The 2D workspace has the proper holes along with placement lines in the 3D Assist layer if you rebuild the design and reconvert it to 3D.

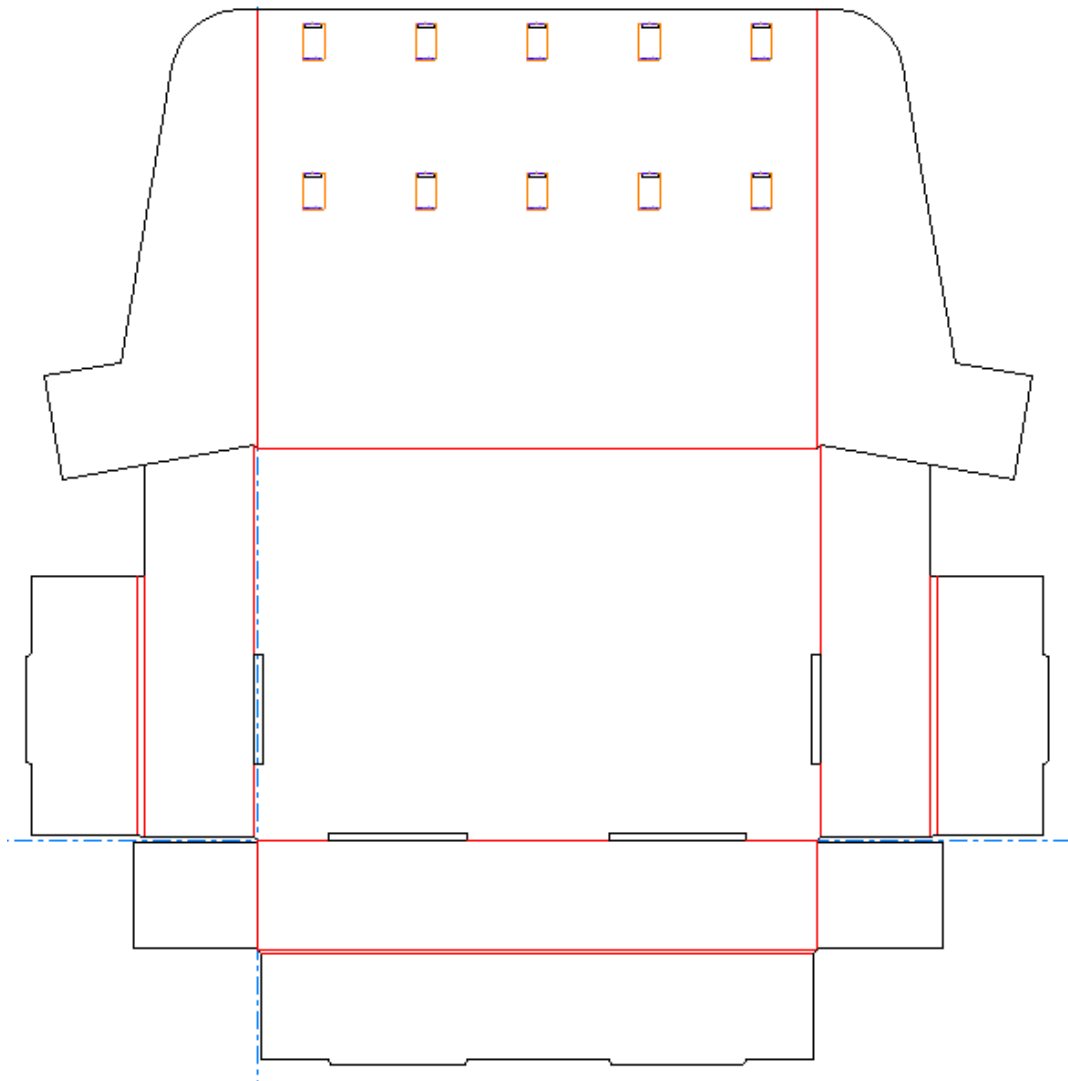

Before You Begin

Before you begin using **Add Hardware**, keep the following in mind:

- ArtiosCAD links the 2D and 3D workspaces. Add hardware only when the design is complete. If that is not possible, if you add hardware in 3D, switch to 2D and make changes, you must convert the 2D to 3D again and select Update 3D in the Convert to 3D dialog box. Do not just switch to the 3D window. If you do not follow the convert\update path out of 2D, the risk of the 2D and 3D workspaces becoming desynchronized increases. It will then become more difficult for ArtiosCAD to align panel sizes and holes between the two workspaces.
- If you will be using a product (something hanging on the hook), make sure it is oriented correctly with respect to the axes, not the view angle. The hole should be at the top and the product should be facing you.
- A product must have at least one hole in it for ArtiosCAD to recognize it as such.
- Similarly, for any design, make sure the Z axis is up and rotate the design so it sits flat on the floor.

- Set the view angle so that you are looking directly at the panel in which you want to place hardware.
- Don't use panels that use curved creases.
- Don't use designs with tear-away parts.
- FFR hook models have text on their right sides that causes them to be slightly asymmetrical.
- ArtiosCAD creates layers for the hardware parts as needed unless layers of the right class exist and are unlocked. Any layers it creates apply to all print items.
- Accordingly, layer limits apply. If the 2D document is at the limit for the number of layers, close it. **Add Hardware** will work in 3D but the 2D document will have no knowledge of the holes you make.
- Hardware placement lines have their own properties page. If only some of the copies have the selected hardware in them, ArtiosCAD shows how many copies use it. Do not ungroup the hardware placement lines.
- If the hardware in the 3D workspace matches existing hardware in an associated open canvas (either the full path or managed path matches), ArtiosCAD updates the part count of the existing part rather than adding a new instance of the same part.

Supported Product Shapes

ArtiosCAD supports the following shapes for use as products with **Add Hardware**.

Blister card:

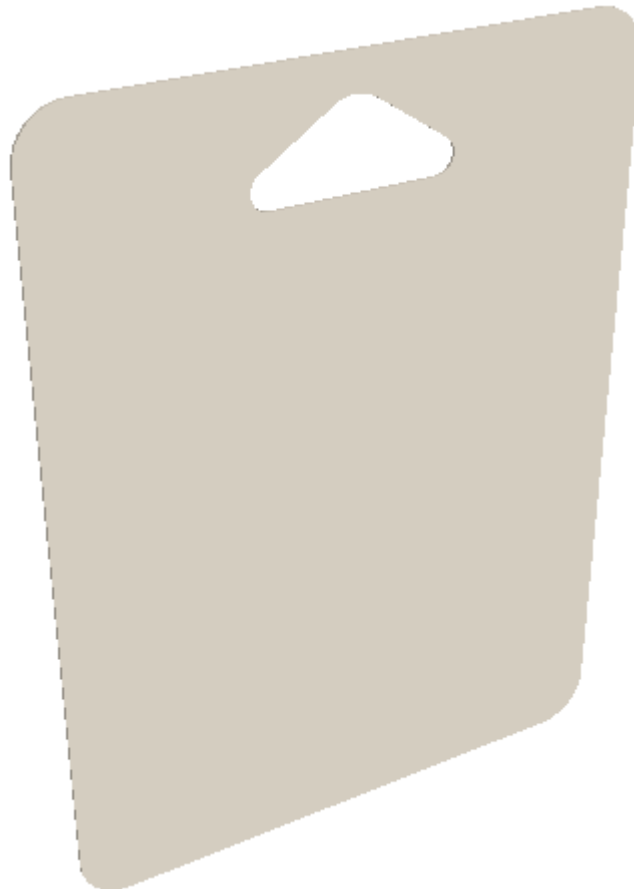

Blister box carton with hole:

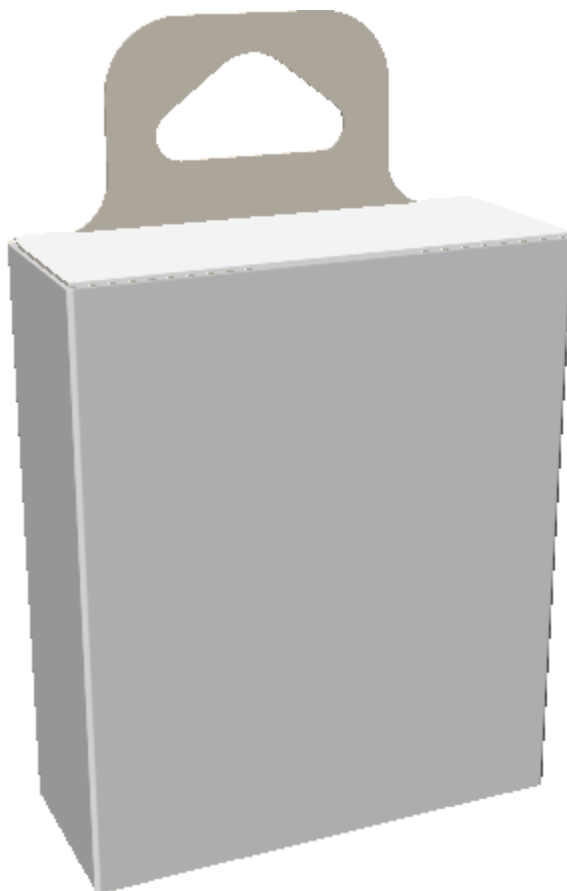

One-piece blister box solid with hole:



One-piece blister box solid with hook:



ArtiosCAD centers the inside top point on the hook.

If you get unexpected results when working with a hooked design, see how the outline looks that ArtiosCAD makes when you select it as the product. If the outline does not conform to the area of the hole formed by the hook, you may experience problems. Shown below is a hook that will work properly.

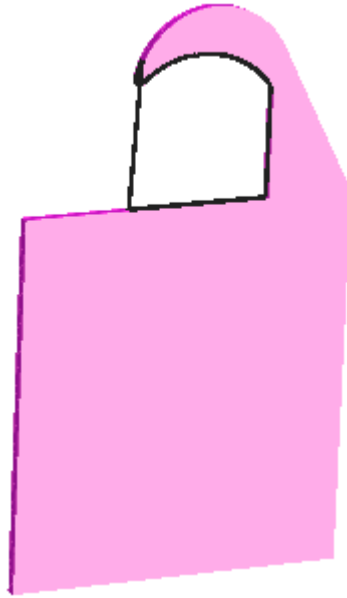

When ArtiosCAD places this on a hook as a product, it centers it correctly.

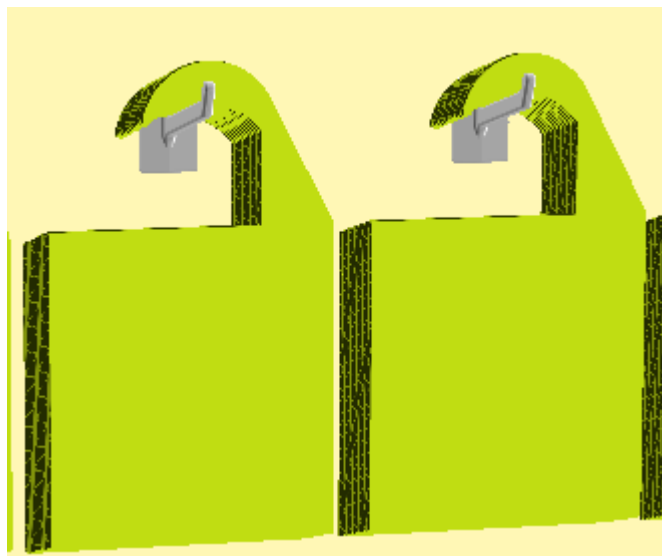

Starting the Tool and Selecting the Hardware

1. Create or open the 3D design to which you want to add hardware. Make sure it is oriented correctly with respect to the axes with Z being up.
2. If you want to hang products on the hardware, use **File > Add a Design**, Add to Open 3D, or paste from the clipboard to add the products. Make sure the products are oriented correctly with respect to the axes, are facing toward you, and that they have a hole or hook at their tops to hang from.
3.  Click **Add Hardware**. The Select Hardware dialog box opens.

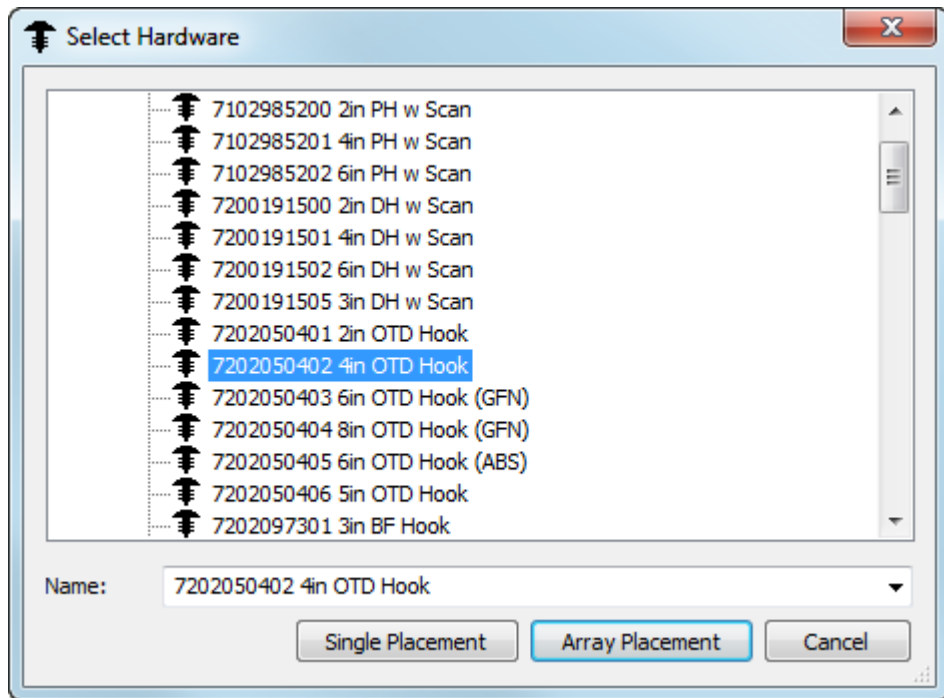

As you hover over a piece of hardware, ArtiosCAD shows you a preview and its description.

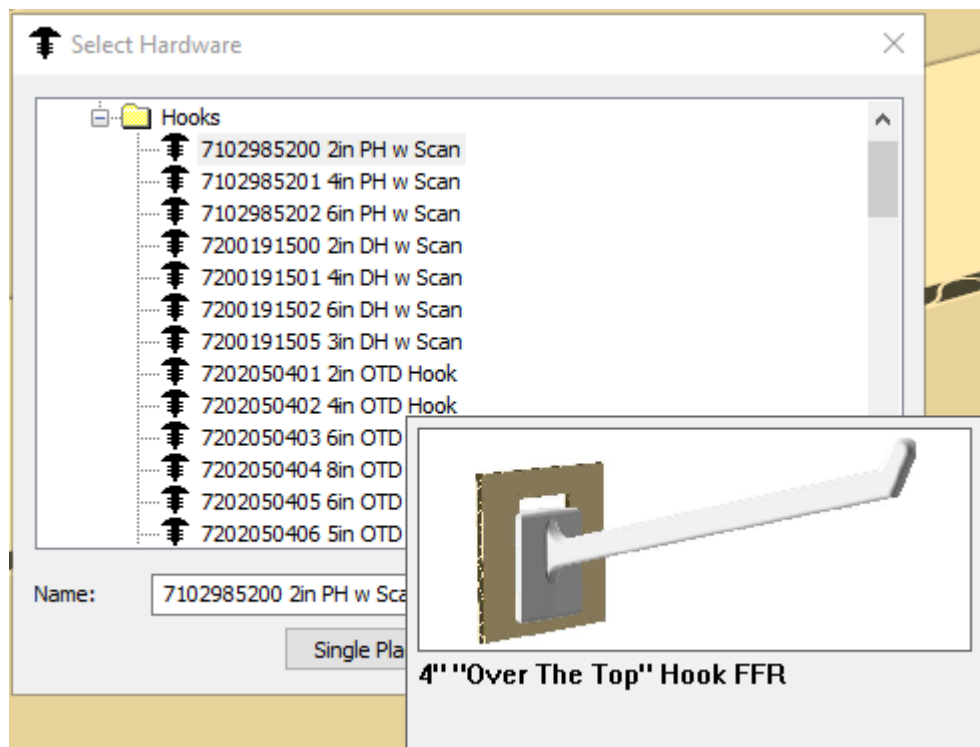

If you start typing in the Name field, ArtiosCAD filters the list for easier searching.

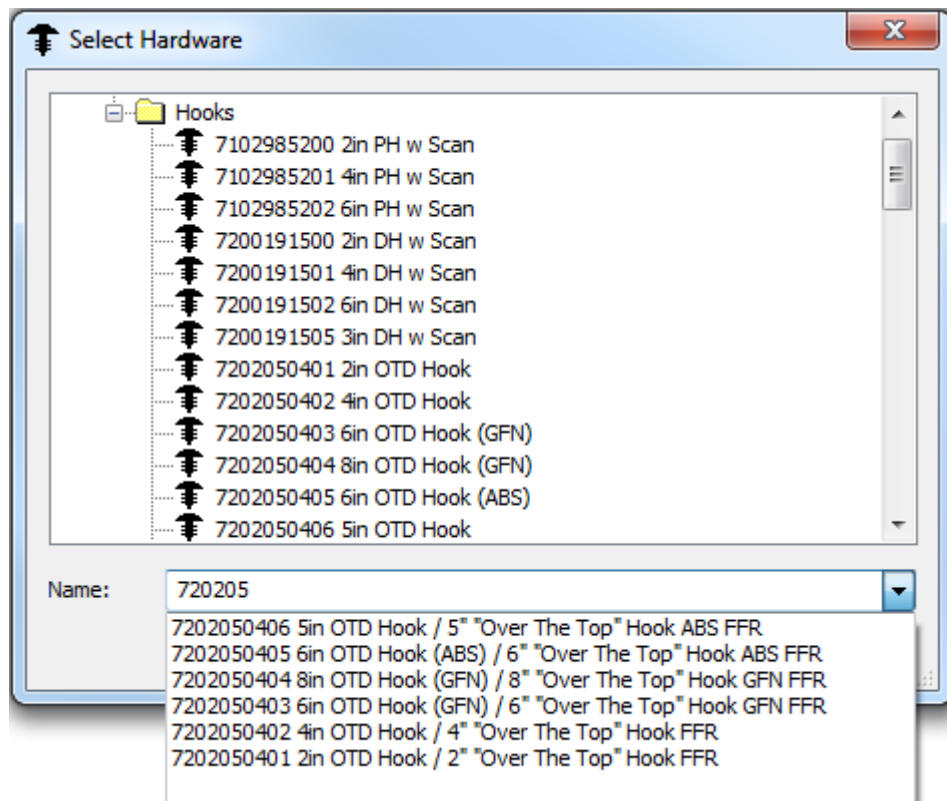

4. When you have chosen the piece of hardware to add, click either **Single Placement** to just place one piece of hardware at a time or click **Array Placement** to place a grid of multiple pieces at once.

Using Single Placement Mode

1. Once you have chosen the piece of hardware to add, click **Single Placement** in the Select Hardware dialog box.
2. Click inside the panel of the box to work in to set the working area. The working area is the largest rectangular plane of the panel where you clicked that has no collisions with other geometry, and it is always rectangular with respect to the axes. The point at which you click inside the panel determines the justification reference point for the hardware which is represented by a blue cross. If you click in the center of the panel, ArtiosCAD measures from the center of the panel. If you click at the top center of the panel, ArtiosCAD measures down from the top, and so forth. In the example below, the center of the panel is the justification reference point.

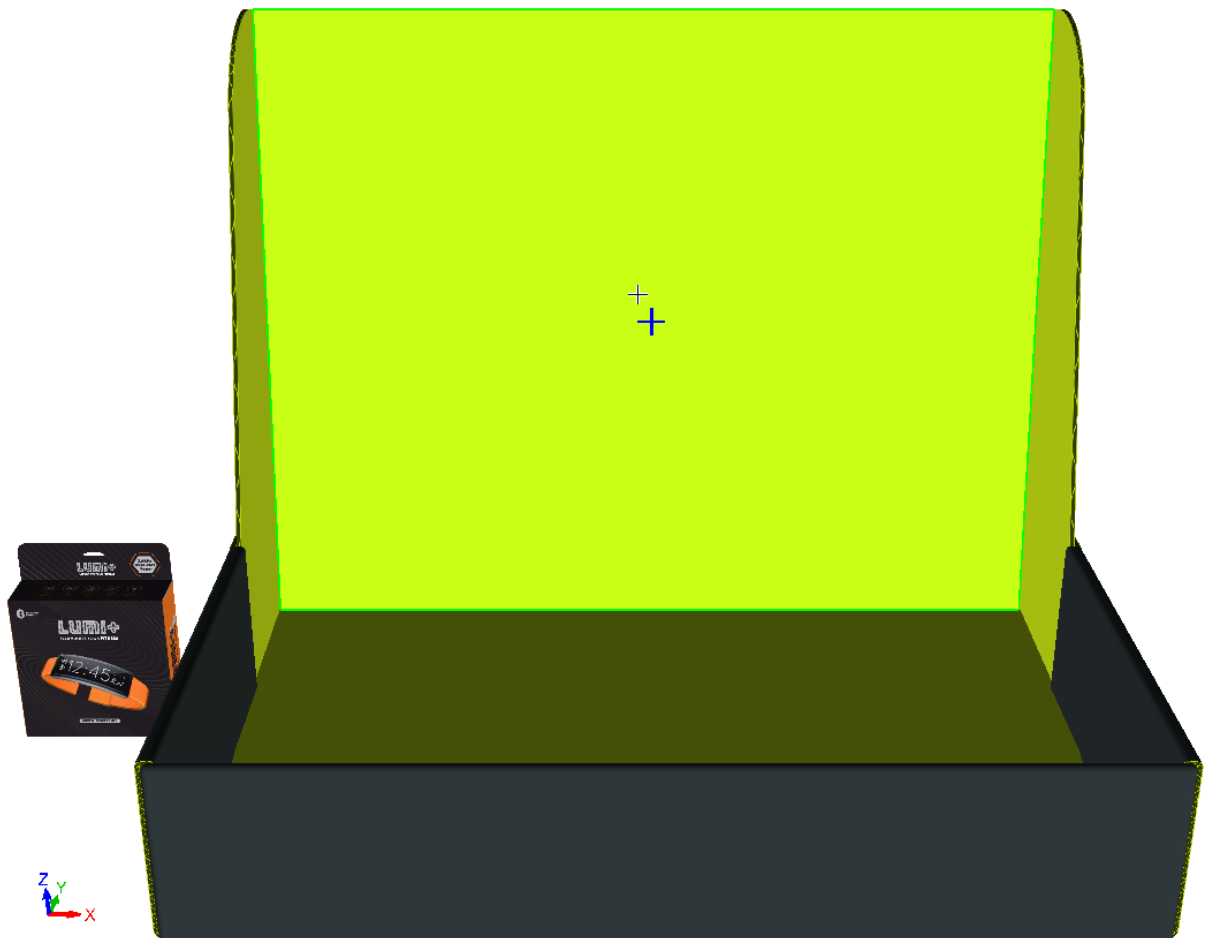

3. The Single Placement Options dialog box appears.

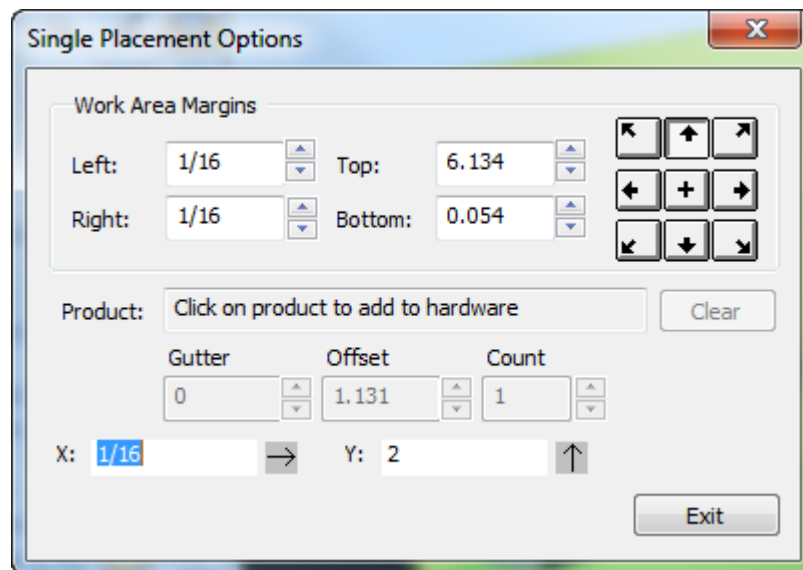

- To put a product on the hardware, click it near its hole or hanger. The name of the product appears in the Product field. To remove the product from the hardware, click **Clear**.

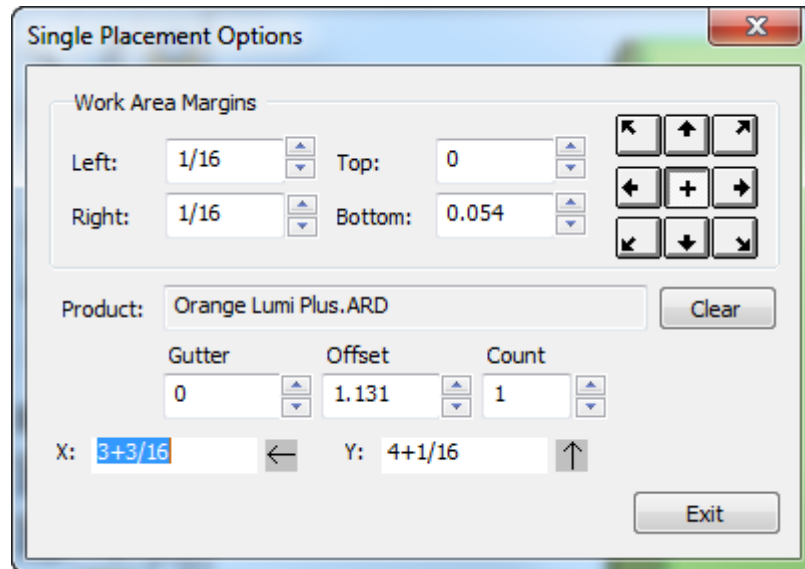

- The X and Y fields prompt for the position of the hardware offset from the alignment point, which you can also set using drag. The active field has a dark blue drag measurement line. To change the justification point, click one of the justification buttons at the top right of the dialog box. Change the margins of the work area as desired in the Work Area Margins group.
- Position the hardware as desired and click to set the put-down point. You can place it outside of the working area but inside the same panel if there are no collisions with anything else. If you have an existing hole in the panel, you can snap the hardware into that hole as long as their sizes match within 0.1 mm. If you use an existing hole, ArtiosCAD does not update the corresponding open 2D workspace.

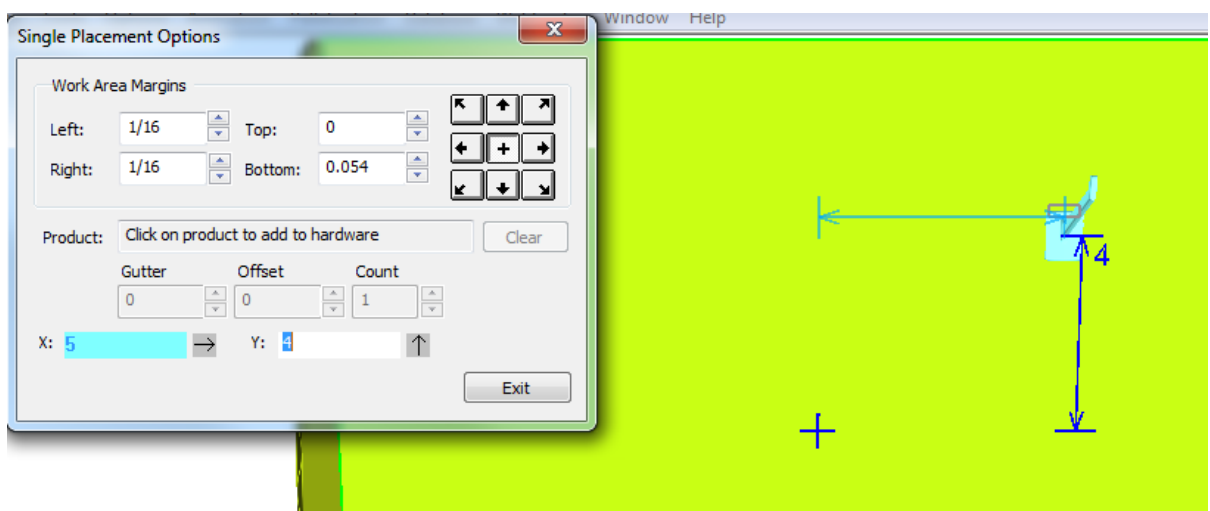

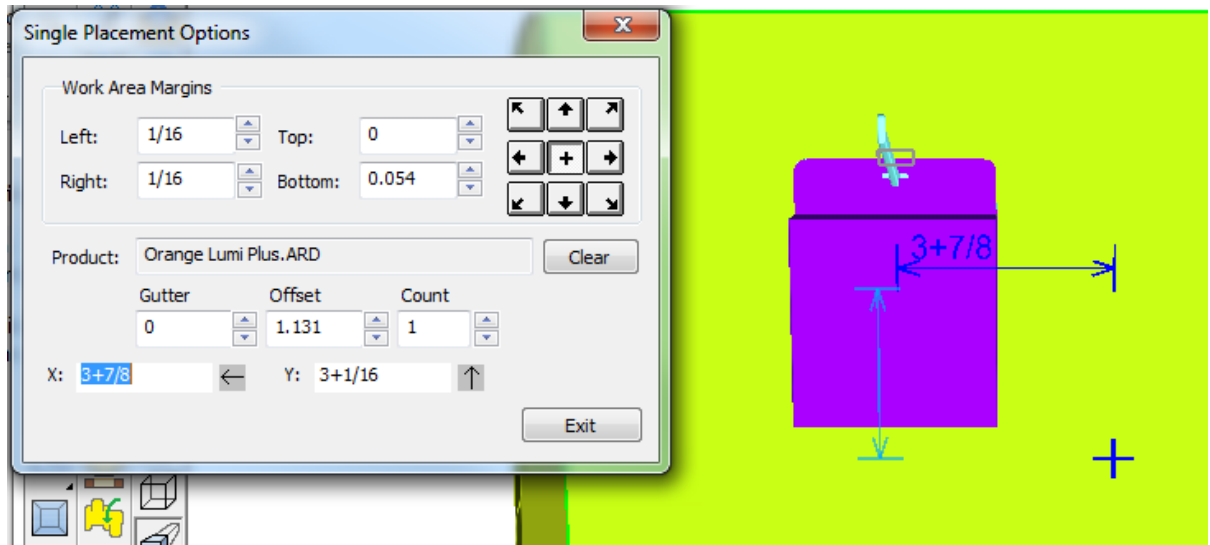

If you have a product on the piece of hardware, the Gutter, Offset, and Count fields are available. Gutter and Offset have no effect in Single Placement mode, but Count sets the number of products on the piece of hardware.

7. Repeat as desired to place more hardware.
8. Click **Exit** when done placing hardware.

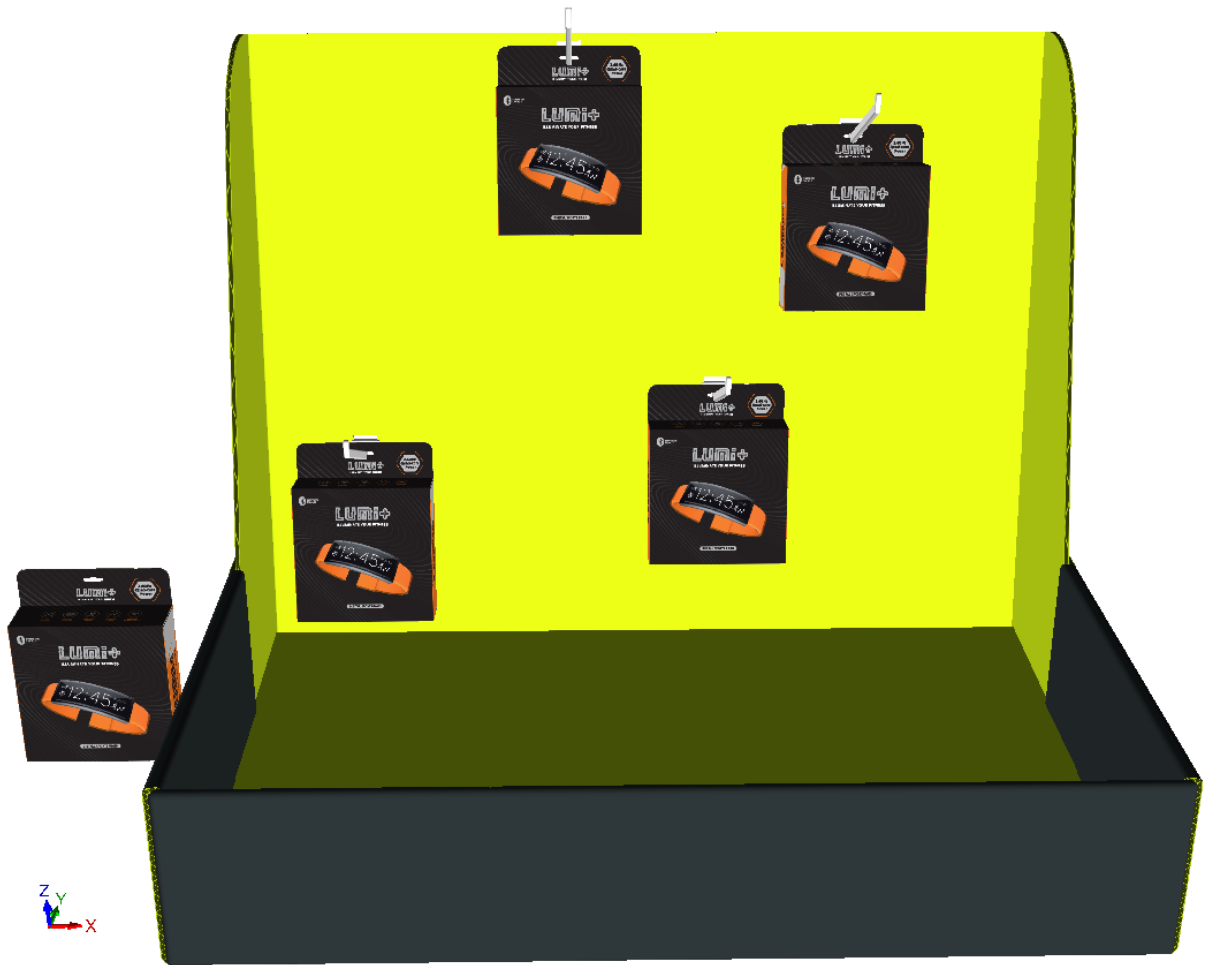

ArtiosCAD displays wrong placement or numbers with red drag and error messages in the status field at the bottom right of the window. Shown below is a collision.



 If you need to change the view while placing hardware, click **View Angle**, change the view, and then press ESC to return to adding hardware.

If you have multiple instances of a design to which you add hardware, ArtiosCAD prompts you if you want to add the hardware to all instances, just the one in which you clicked, or split the design with hardware into a separate copy.

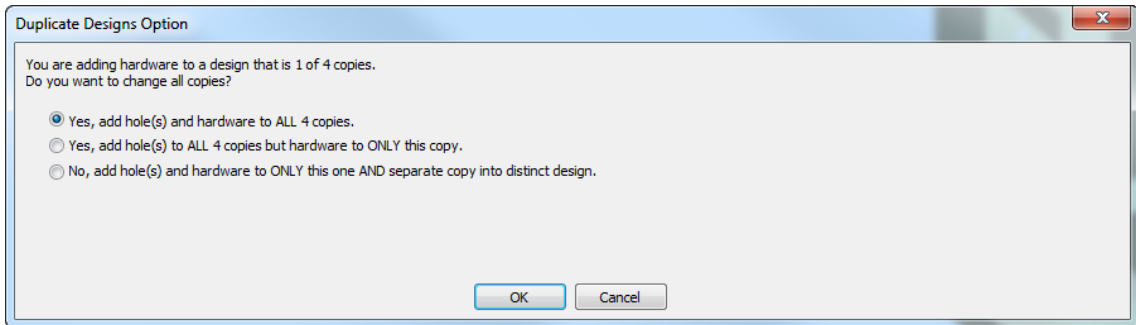

If there are more than 40 duplicates, the add to all option is unavailable as this would create too many copies.

If you choose to make a separate copy, ArtiosCAD shows options for updating the 2D workspace.

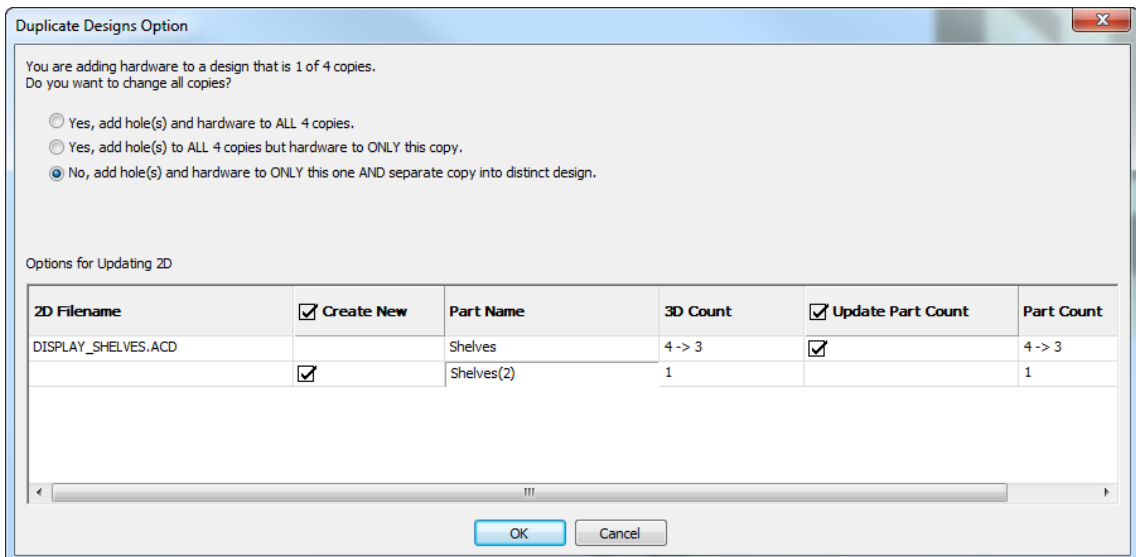

In the example above, ArtiosCAD shows two rows for the affected 2D workspace, DISPLAY_SHELVES.ACD, a canvas. The first row is for the existing workspace and the second row is for the part workspace it will create for the separate copy. Double-click the new part's entry in the Part Name field to change it. You can choose to create the new workspace by checking the **Create New** checkbox. Likewise, you can choose to update the part count in the existing workspace using the **Update Part Count** checkbox.

Using Array Placement Mode

1. Once you have chosen the piece of hardware to add, click **Array Placement** in the Select Hardware dialog box.
2. Click inside the panel of the box to work in to set the working area. The working area is the largest rectangular plane of the panel where you clicked that has no collisions with other

geometry, and it is always rectangular with respect to the axes. The point at which you click inside the panel determines the justification reference point for the hardware which is represented by a blue cross. If you click in the center of the panel, ArtiosCAD measures from the center of the panel. If you click at the top center of the panel, ArtiosCAD measures down from the top, and so forth. In the example below, the top left corner is the justification point.

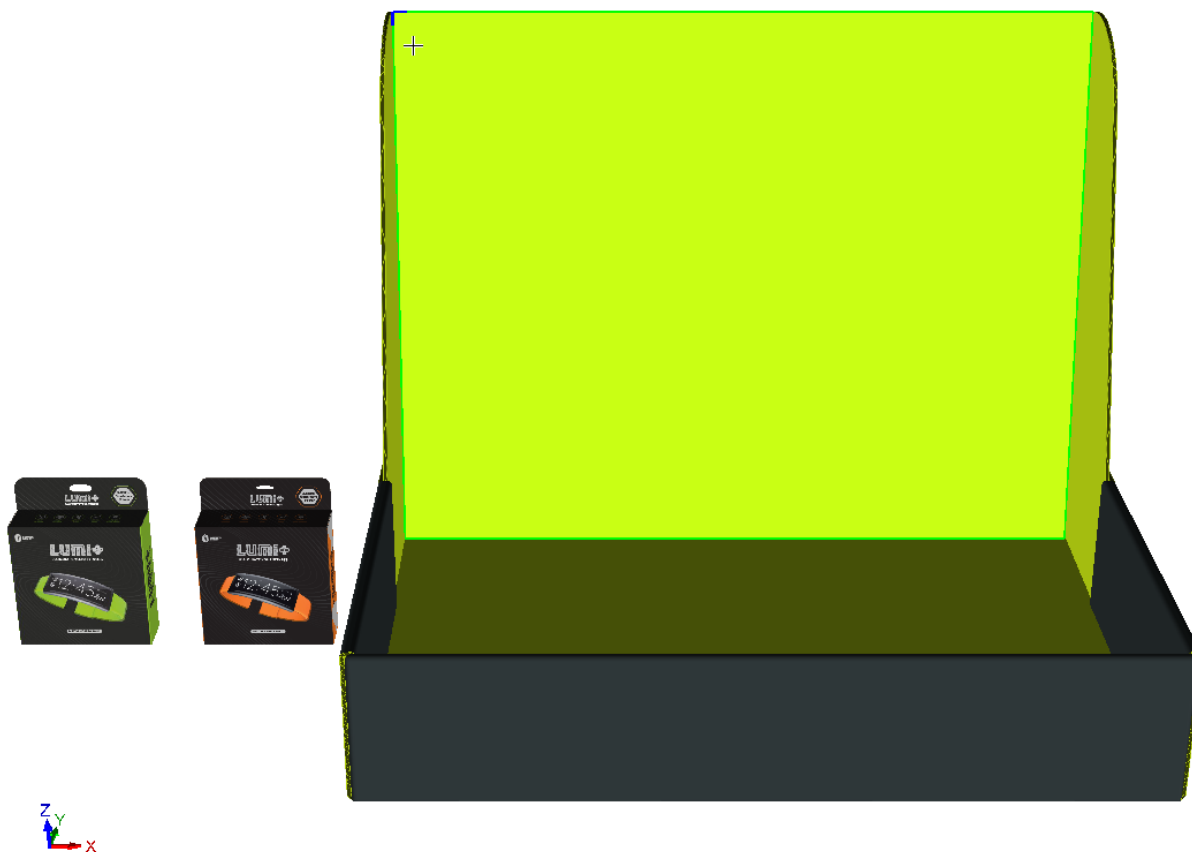

3. The Array Placement dialog box appears.

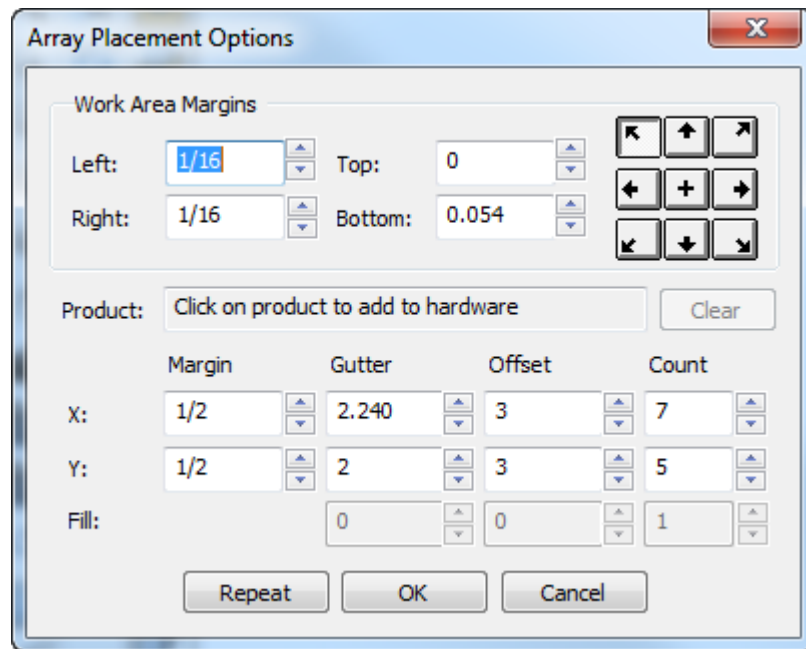

An array of hardware also appears in the working area.

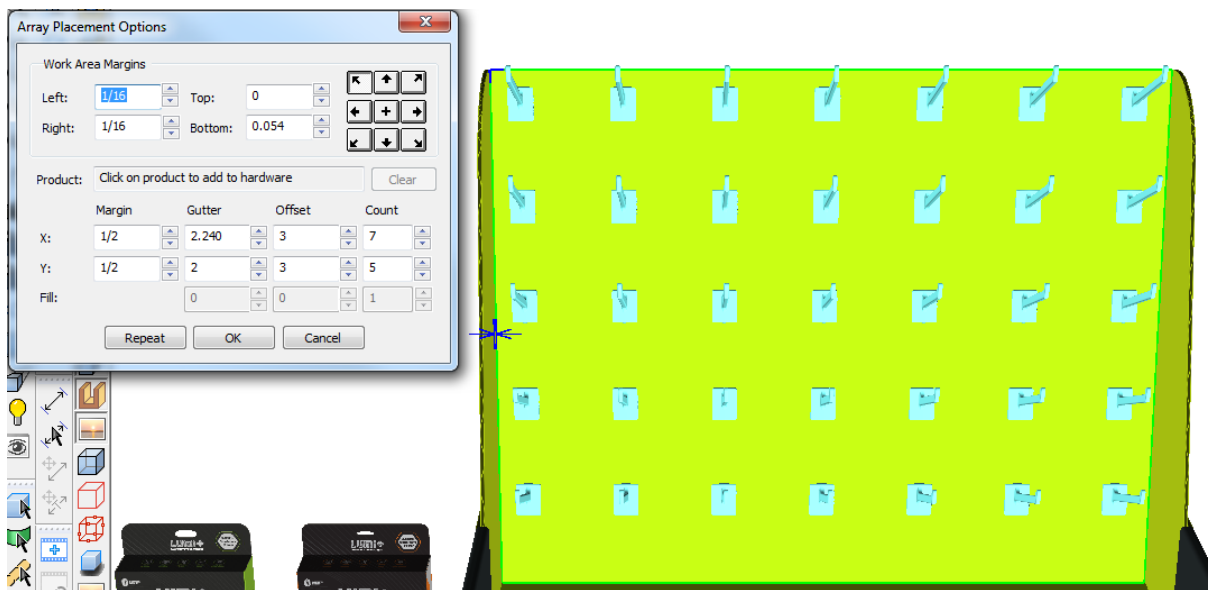

4. To put a product on the hardware, click it near its hole or hanger. The name of the product appears in the Product field.

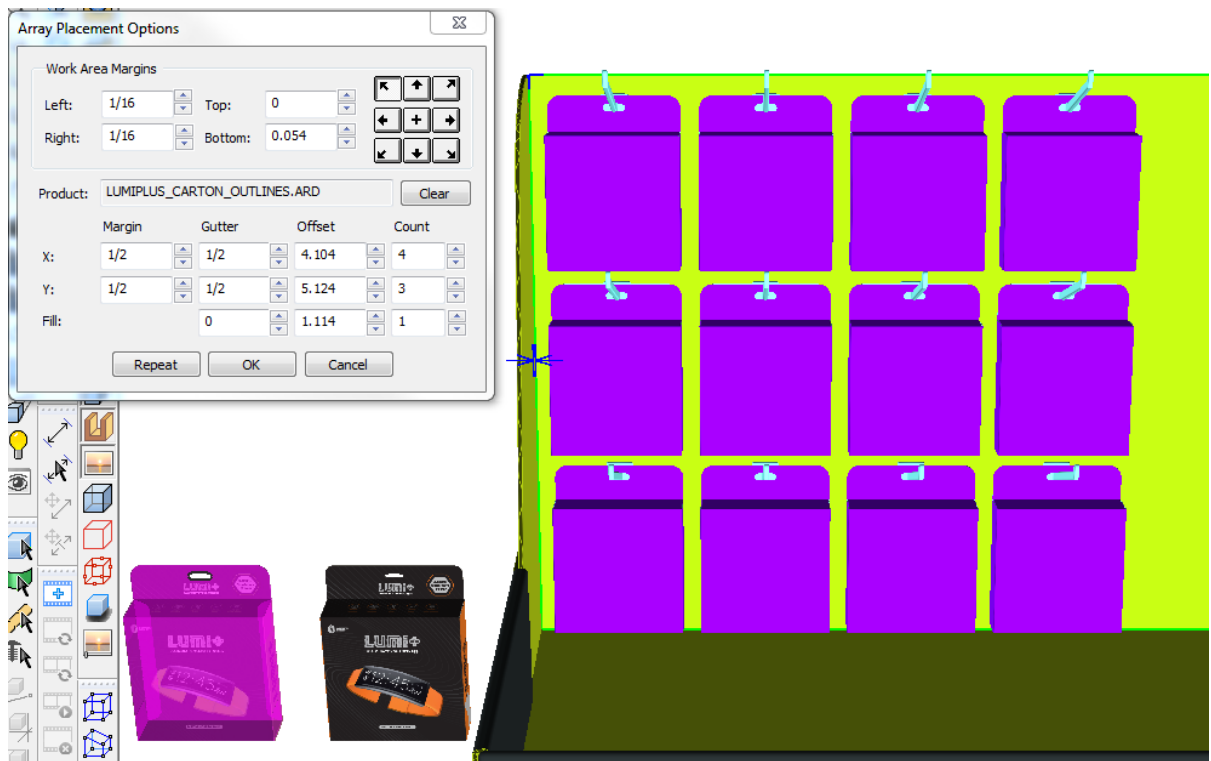

To remove the product from the hardware, click **Clear**. ArtiosCAD recalculates the array.

5. Adjust the values in the Array Placement Options as desired. When you click inside a field, ArtiosCAD will show you what you are adjusting with visual feedback. As you change a field, ArtiosCAD recalculates the other fields and updates the array. Hold down SHIFT or CTRL to increment the Count and Fill spin controls by 5 instead of 1. The distance fields increment by the Nudge Options values in Startup defaults.
 - a) Margin is the distance between the outermost edge of the bounding box of all the hardware/products and the edge of the working area.
 - b) Gutter is the distance between the bounding box of the hardware/product in one column or row and the next column or row.
 - c) Offset is the distance between the pickup point of the hardware in one column or row and the next column or row.
 - d) Count is the number of hardware/products in a direction.
 - e) In the Fill row, Gutter, Offset, and Count affect the placement of the product on the hardware. This row is only available when there is a product. Gutter is the distance between two products. Offset is the distance from the start of one product to the start of another product. Count is the number of products on the hardware.
6. Click **OK** to place the array if you do not want to make another array. To immediately start making another array without having to restart the tool, click **Repeat**.



7. Because less than half of the working area was filled, the rest of the panel has another working area on it which you can fill with a different array. Select the new working area and click near the justification point.



8. Repeat the process of adding a product and setting the dimensions of the array. Click **OK** in the Array Placement Options dialog box when done.



ArtiosCAD displays wrong placement or numbers with red drag and error messages in the status field at the bottom right of the window. Shown below is a collision.

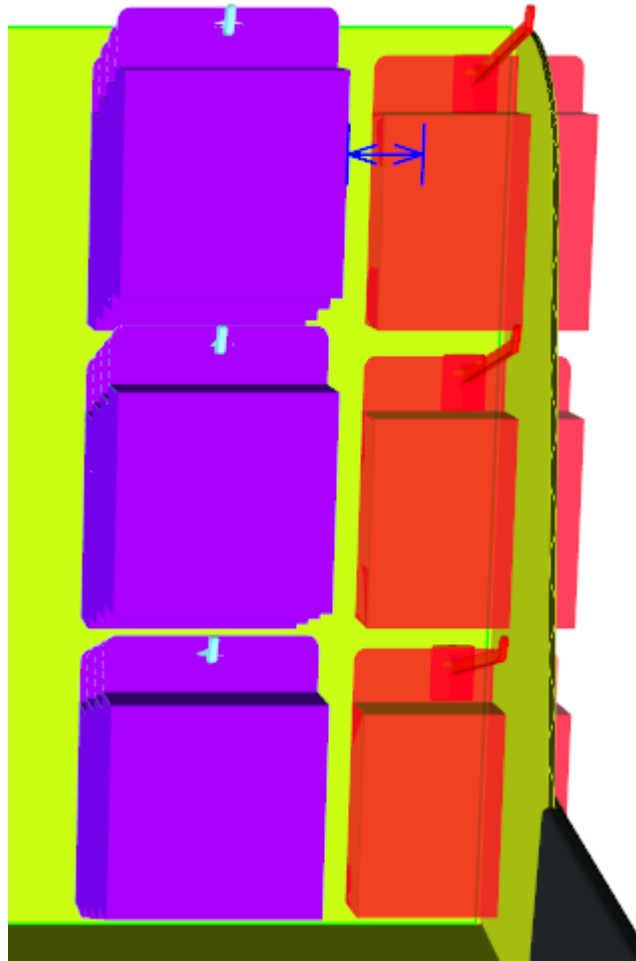

 If you need to change the view while placing hardware, click **View Angle**, change the view, and then press ESC to return to adding hardware.

If you have multiple instances of a design to which you add hardware, ArtiosCAD prompts you if you want to add the hardware to all instances, just the one in which you clicked, or split the design with hardware into a separate copy.

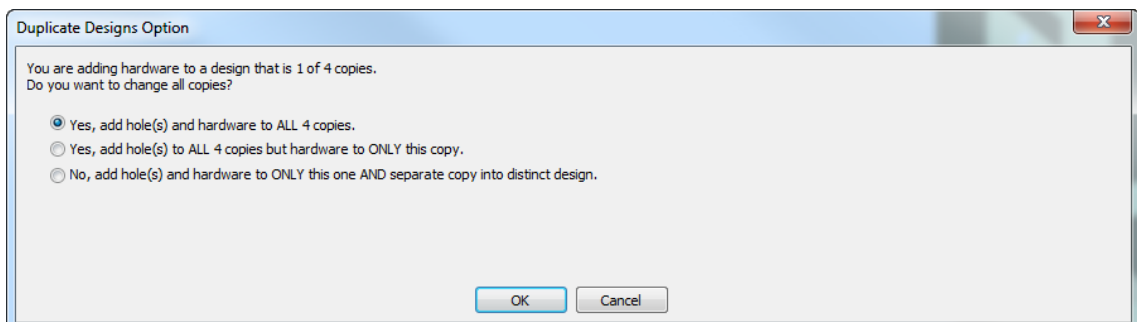

If there are more than 40 duplicates, the add to all option is unavailable as this would create too many copies.

If you choose to make a separate copy, ArtiosCAD shows options for updating the 2D workspace.

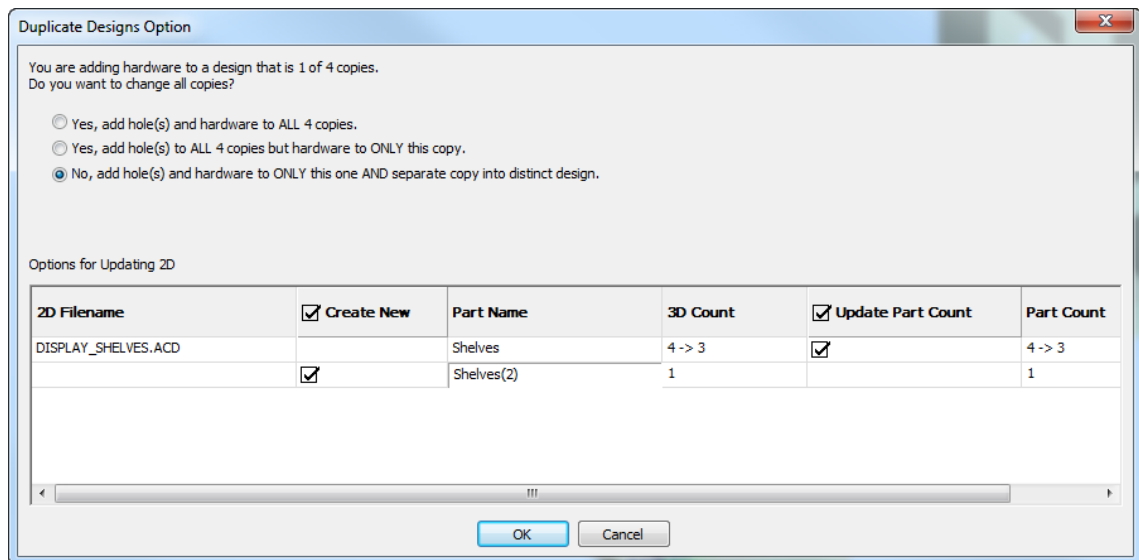

In the example above, ArtiosCAD shows two rows for the affected 2D workspace, DISPLAY_SHELVES.ACD, a canvas. The first row is for the existing workspace and the second row is for the part workspace it will create for the separate copy. Double-click the new part's entry in the Part Name field to change it. You can choose to create the new workspace by checking the **Create New** checkbox. Likewise, you can choose to update the part count in the existing workspace using the **Update Part Count** checkbox.

Using the Select Hardware Tool to Delete Hardware



Select Hardware on the 3D Tools toolbar lets you select hardware, optionally the hole it uses, and the product on the hardware. Once you have made a selection, you can then delete what is selected.

-  In a workspace containing hardware, click **Select Hardware**.
- On the Status bar, leave **Include Holes** selected, or deselect it to keep the holes. When **Include Holes** is selected, you may only select hardware in copies of the same design.
- Click an individual piece of hardware to select it, or hold down SHIFT or CTRL and click multiple pieces. You can also click and drag a window to select everything inside the window.



4. Once you have selected the hardware, press DEL on the keyboard to delete the selection.
5. If the change impacts a design with multiple copies, ArtiosCAD asks you what to do in the Duplicate Designs Options dialog box. You can either delete the hole(s) and hardware from all the copies, or split the existing design. Click **OK** when done.

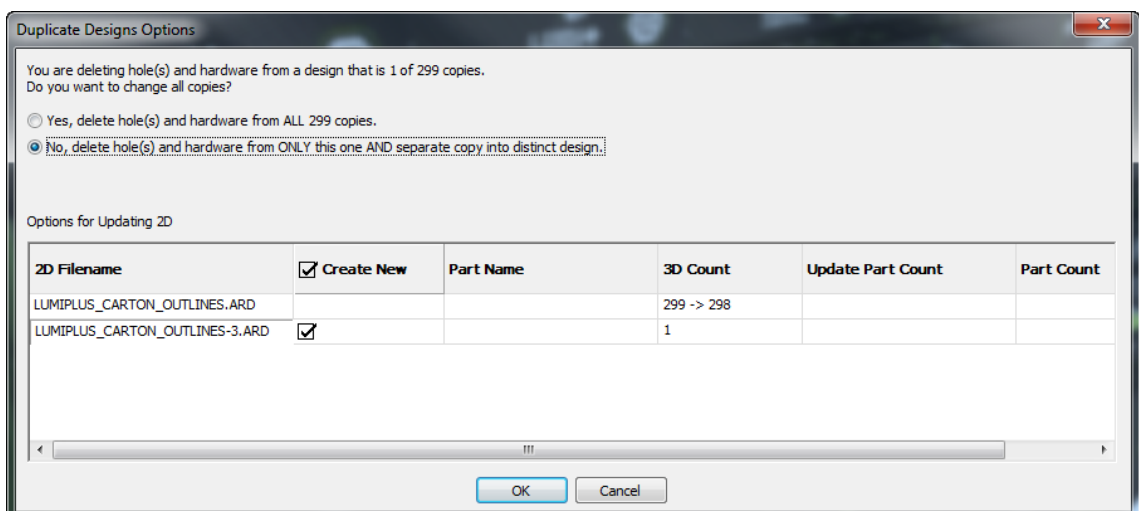

- ArtiosCAD deletes the hardware and holes (if included). If there were multiple instances of the hardware, ArtiosCAD deletes those too.

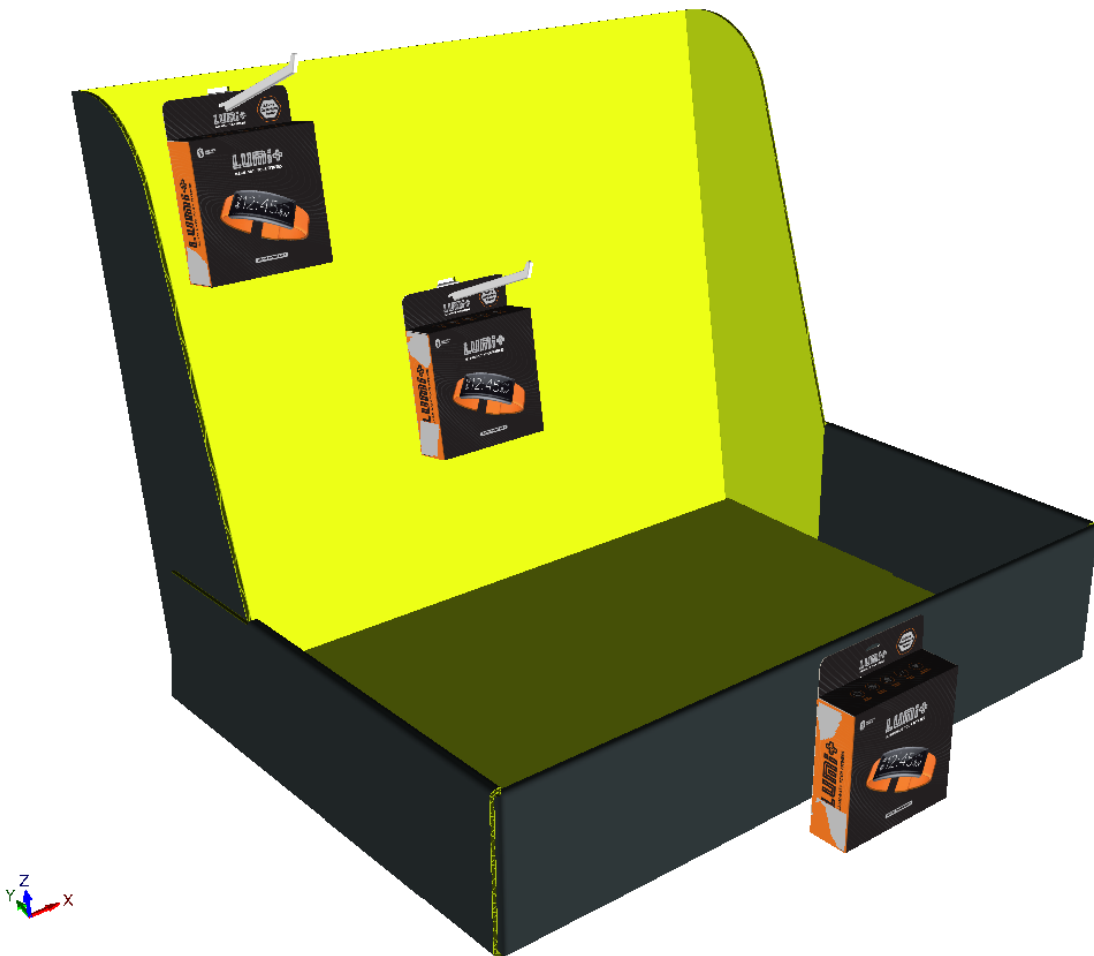

When you delete hardware using this tool, ArtiosCAD updates the connected 2D design as well if it is open. If **Include Holes** is checked, ArtiosCAD deletes the holes too. Note that removing the holes is only possible using **Select Hardware** with **Include Holes** selected. It is possible to remove the hardware using the normal Select tool, however.

If the part count drops to 0, ArtiosCAD removes the part.

Updating the 2D Workspace After Adding Hardware in 3D

When you are adding hardware in 3D and have the single design or canvas workspace open, ArtiosCAD updates the flat workspace automatically. ArtiosCAD does not update the flat workspace if it is closed.

ArtiosCAD adds holes created by **Add Hardware** to the Windows and Cutouts layer of the flat design. If this layer does not exist, ArtiosCAD creates it. If it does exist, ArtiosCAD adds the holes to it. If print items exist, ArtiosCAD looks for a layer of class Windows and Cutouts in the current print item, adds the holes to it if it exists, or creates the layer if it does not exist. Note that it will add them to the current print item; ArtiosCAD does not record which print item was current when it converted the workspace to 3D so if you changed print items after converting to 3D, ArtiosCAD may put holes in an incorrect print item.

The holes ArtiosCAD adds are line type cut, pointage 2. There is no Default for this.

If the open flat design is the linked canvas, ArtiosCAD adds a thumbnail image of the hardware part to the canvas. The count on this part is the current part count in 3D.

Add Hardware adds placement lines to the 3D Assist layer in the flat design so that if you reconvert it to 3D, ArtiosCAD positions the hardware correctly. **Update 2D** does not modify non-matching placement lines or hardware parts in 2D if you have changed them manually.

Undo/Redo in 3D of **Add Hardware** updates the open flat workspace.

In a 3D workspace created from a canvas, if the 3D has multiple copies of a part, and when adding hardware you choose to split the changed copy into a new design, ArtiosCAD does not add the holes to the original part in the canvas as it is no longer associated with the split copy in 3D.

If you rebuild a flat design with holes in it, ArtiosCAD does not recalculate the position of the holes if the panel changes size.

If you have more than one view of the flat design open, ArtiosCAD only turns on the Windows and Cutouts layer in the first view. Turn the layer on manually in other views if desired.

Add Hardware Tool Notes

General Notes

ArtiosCAD checks that the current board matches the caliper range of the selected hardware, but does not prevent you from using hardware that is too big or too small.

FFR hooks have text on one side which makes them slightly asymmetrical.

Undo/Redo do not change the splitting of designs when adding hardware.

Modifying or deleting holes in 2D does not automatically update the 3D workspace. Reconvert the changed 2D workspace to 3D and select **Update 3D** in the Convert to 3D dialog box to update the 3D workspace.

Select Hardware only selects hardware close to a hole in a panel. If you delete the hole only, the tool cannot later delete the orphaned hardware. Use **Select Designs** to select and then delete the hardware in that case.

If copies of a design are rotated differently than the original, and you add hardware to the original that gets duplicated to the copies, the hardware in the copies may not be aligned correctly.

In single placement mode, ArtiosCAD checks if there is already hardware defined for this hole in the linked flat design, and if so, warns you.

Notes on Adding a Product

A product must be a single carton or solid with a suitable hole or hook for hanging. Put the hook or hole at the top, with the front of the product facing toward you.

If a product has curved creases or bends, the hook or hole must be in a flat panel.

If a product has more than one hole or hook, ArtiosCAD selects the hole or hook closest to where you clicked.

For a product that is a solid, a hole must go all the way through a thin (less than 1 cm) part of the solid.

For a product that is a solid with more than one hole, ArtiosCAD selects the largest hole it finds.

Working Area Notes

The working area calculation checks for collisions that as close as 0.3mm and as far away as the distance required to place the hardware. ArtiosCAD does not check for collisions behind the working area.

You cannot select panels for the working area that are smaller than the hole required by the hardware.

Bend panels, curved crease panels, and designs with tear-away parts are not supported.

ArtiosCAD orients the hardware in 3D just as it is oriented in its native workspace regardless of the current view angle. ArtiosCAD orients hardware the same way it is shown in the preview when you hover over it while selecting it. To put the hardware on the other side of the panel, stop the tool, change the view angle so the desired side of the panel is facing you, and restart the tool.

ArtiosCAD also orients the hardware so that the surface of the reference board in the hardware workspace is aligned with the side facing you in the 3D workspace.

Depending on the panel geometry, you may not be able to initially select the desired alignment point. Set the working area anyway and change the alignment point using the controls in the placement options dialog box.

If you put hardware in a panel that is flat on the floor, ArtiosCAD orients the hardware so that its positive Z axis matches the positive Y axis of the flat workspace.

Some ArtiosCAD standards do not use the XY plane as the floor. Before you use **Add Hardware**, make sure to orient the workspace so that Z is up and the designs sit on the floor.

It is possible to select a panel for the working area that is not currently visible due to the view angle. Thus is it possible to place hardware extending into the interior of the design.

Add Hardware only modifies one panel at a time. It is possible to have a working area extend across adjacent panels but ArtiosCAD only puts holes in the panel in which you clicked.

Array Calculation Notes

You may not use expressions in any of the fields in the Array Placement Options dialog box.

Holes of hardware components may not overlap. However, hardware and products may overlap holes.

Add Hardware will not add more than 500 holes per panel. ArtiosCAD warns after 200 holes and stops showing array drag to maintain performance levels.

For the above limit, hardware that creates more than one hole per piece counts as the number of holes it creates, not the number of pieces of hardware. For example, a 2-prong hook is one piece of hardware but counts as two holes.

Creating a Hardware Component from a Solid Model

You can create your own hook-style hardware component for use with **Add Hardware**. Review the solid model carefully to ensure there are no gaps or sharp angles between surfaces, which may cause it to not work properly.

1. Open the solid model of the hardware component in 3D. You might want to perform this procedure on a copy of the original as it modifies the workspace and cannot be undone.
2. Orient it so that the piece that attaches to the board is vertical and the projecting part is facing toward you. Bad alignment:

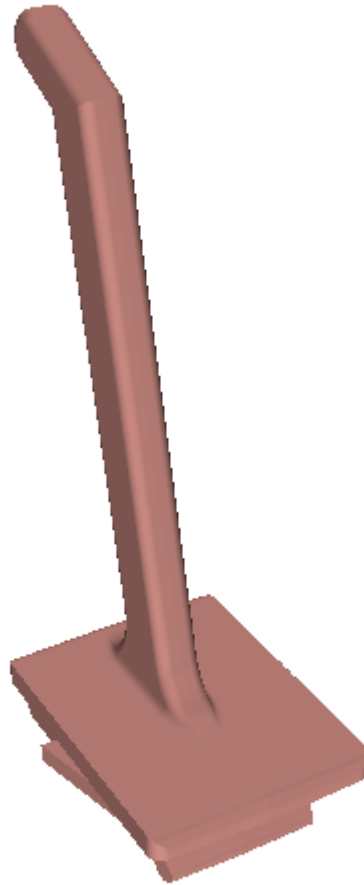

Good alignment:

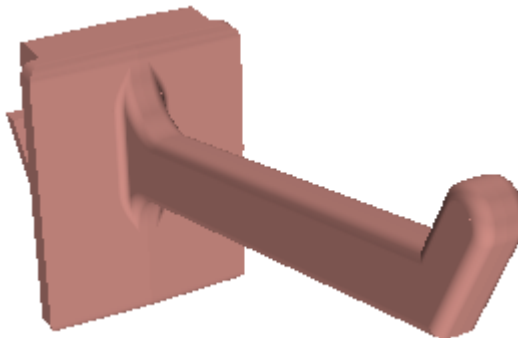

3. Click **Options** > **Set as Hardware Component**.
4. ArtiosCAD opens the Convert Hardware Model to 3D Hardware Component dialog box. Read it carefully, and then click **Yes** to convert the workspace to a hardware component.

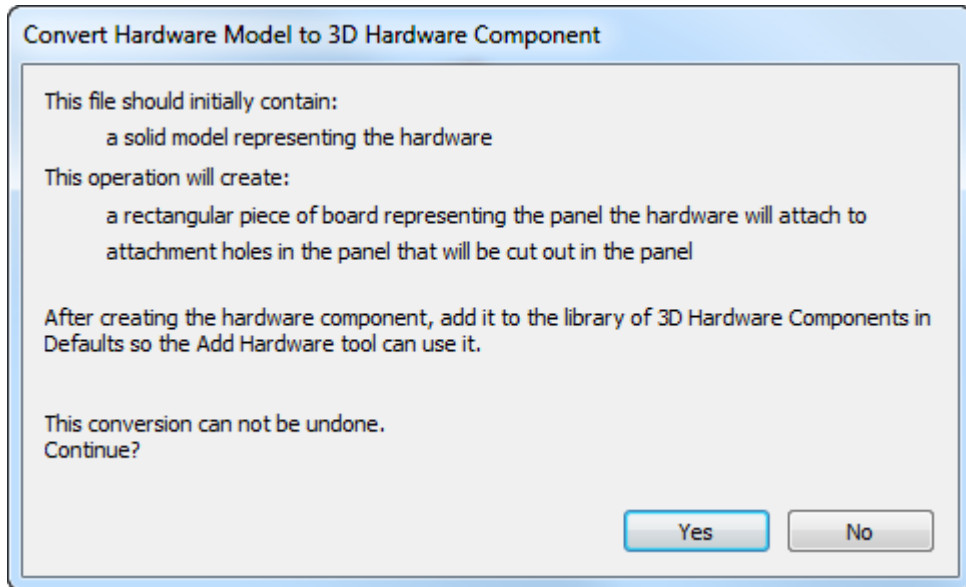

5. ArtiosCAD displays the Hardware Properties dialog box in which it displays the computed calipers this hardware can work between along with the computed length of the usable part. Adjust the Minimum and Maximum fields as desired and click **OK**.

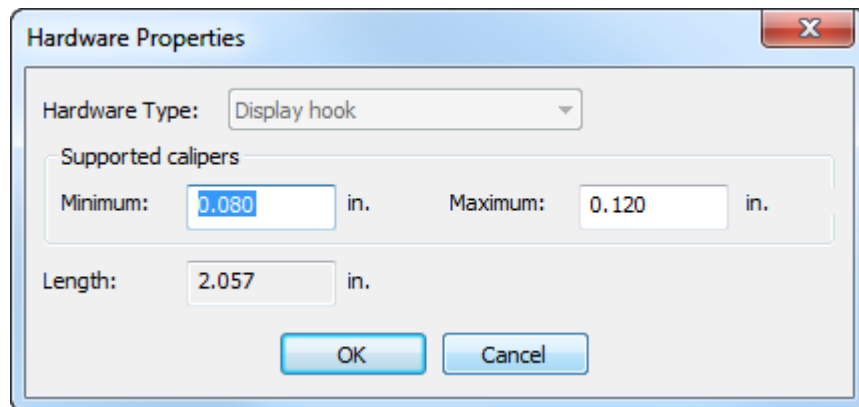

6. ArtiosCAD adds a piece of corrugated board as an alignment piece and creates the necessary hole(s) in the board where the hardware intersects. ArtiosCAD shows the hole(s) with green lines.

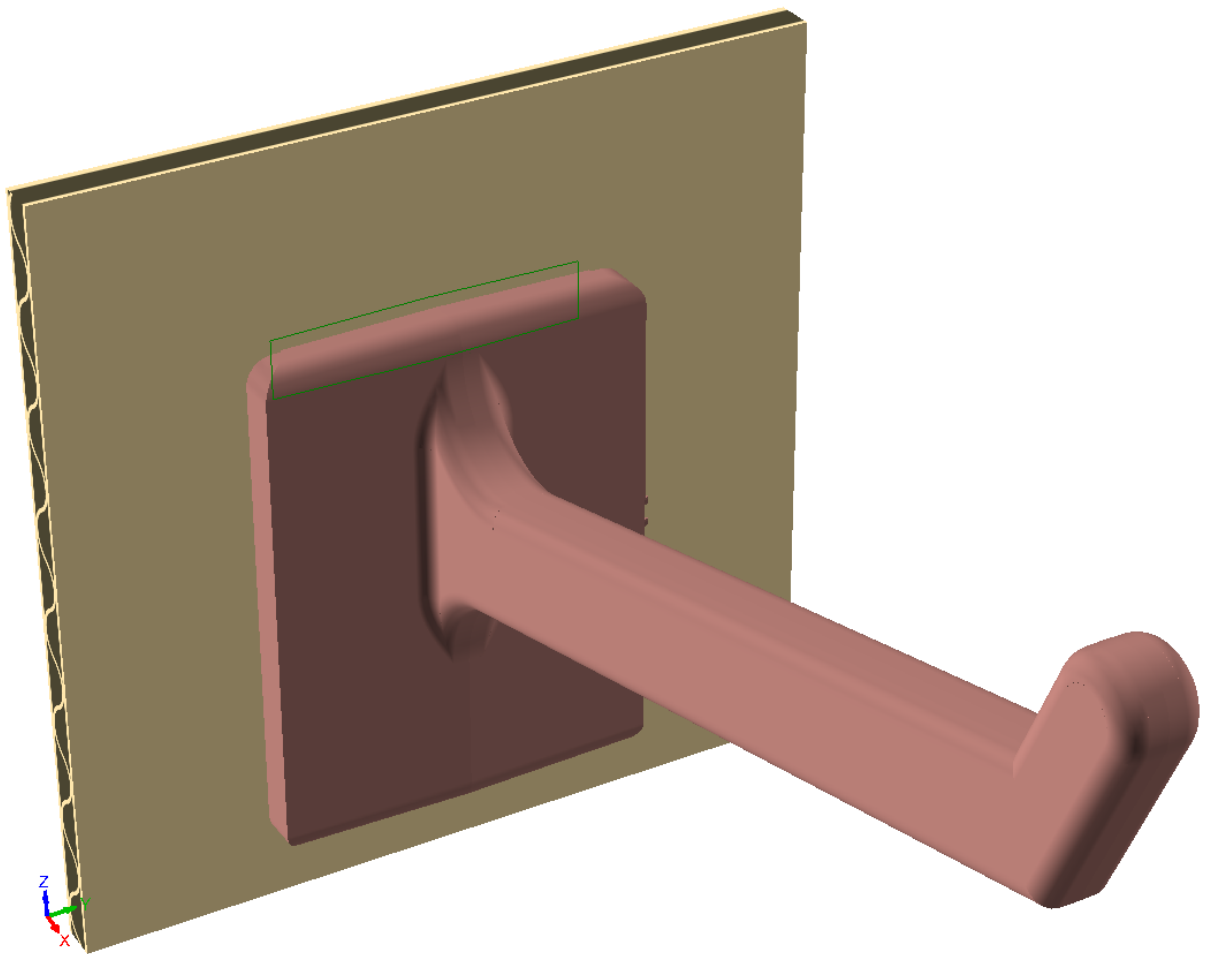

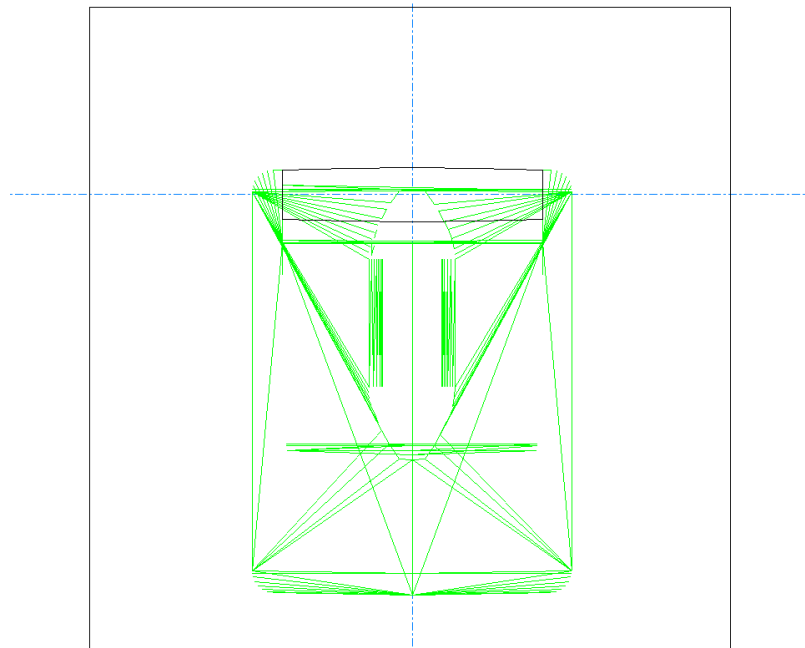

If you need to change the holes, typically to make the hole taller to allow for easier hardware insertion, do the following:

- a) Click **Tools > Convert to 2D** and click the alignment piece.
- b) Set a parameter set if prompted.
- c)  The holes are in the Main Design layer. Click the **Layers** control on the stage bar to turn off the Grip position layer (the green lines showing the position of the hardware).

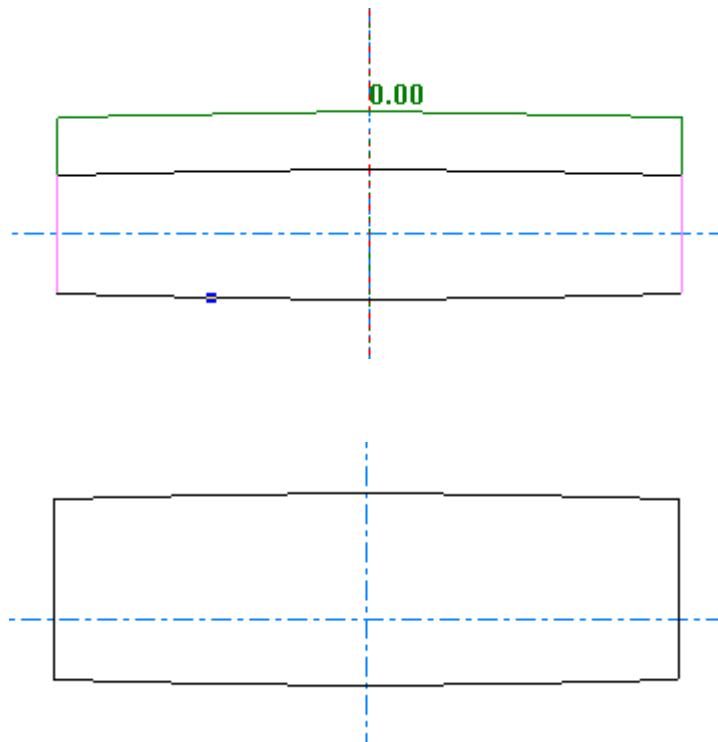

d) Adjust the holes as needed.



e)  Click **Convert to 3D** on the stage bar and pick **Update 3D** in the Convert to 3D dialog box. The holes in the alignment piece show the changes you made.

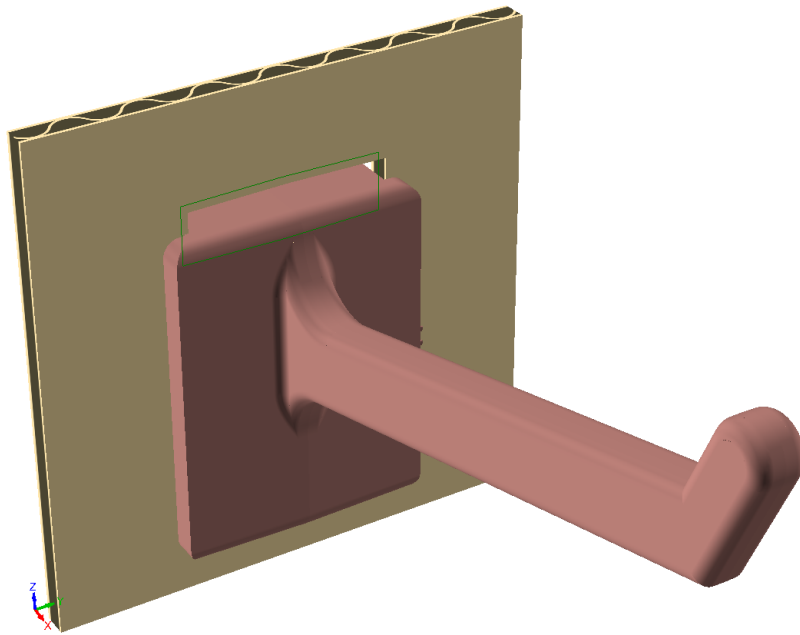

7. Click **File > Save As**.
8. In the Save Hardware to Defaults dialog box, click **Save to Defaults** to save the workspace and add it to User Defaults.

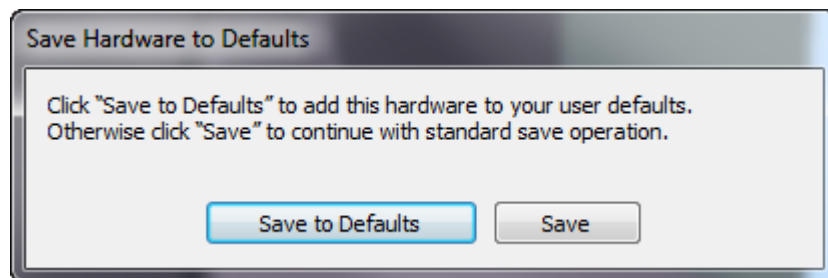

9. In the next Save Hardware to Defaults dialog box, enter a name, description, and filename (ending in .A3D) in the fields and click **OK**.

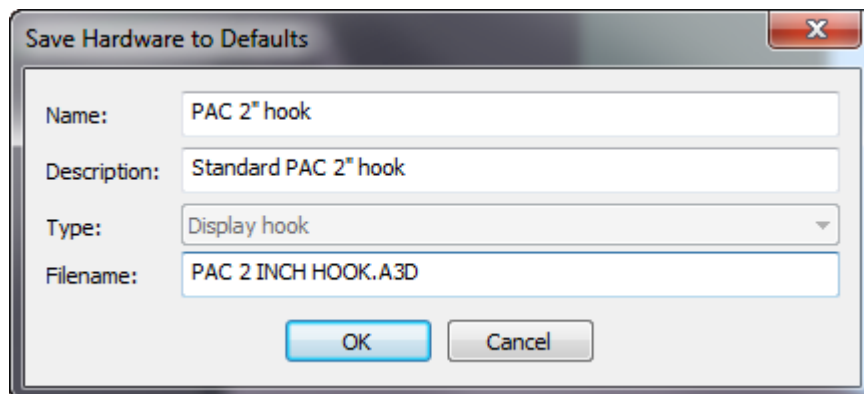

10. If you are using ArtiosCAD Standard Edition, the hardware is now ready for use. If you are using ArtiosCAD Enterprise, enter a description in the Database Information dialog box and click **OK**.

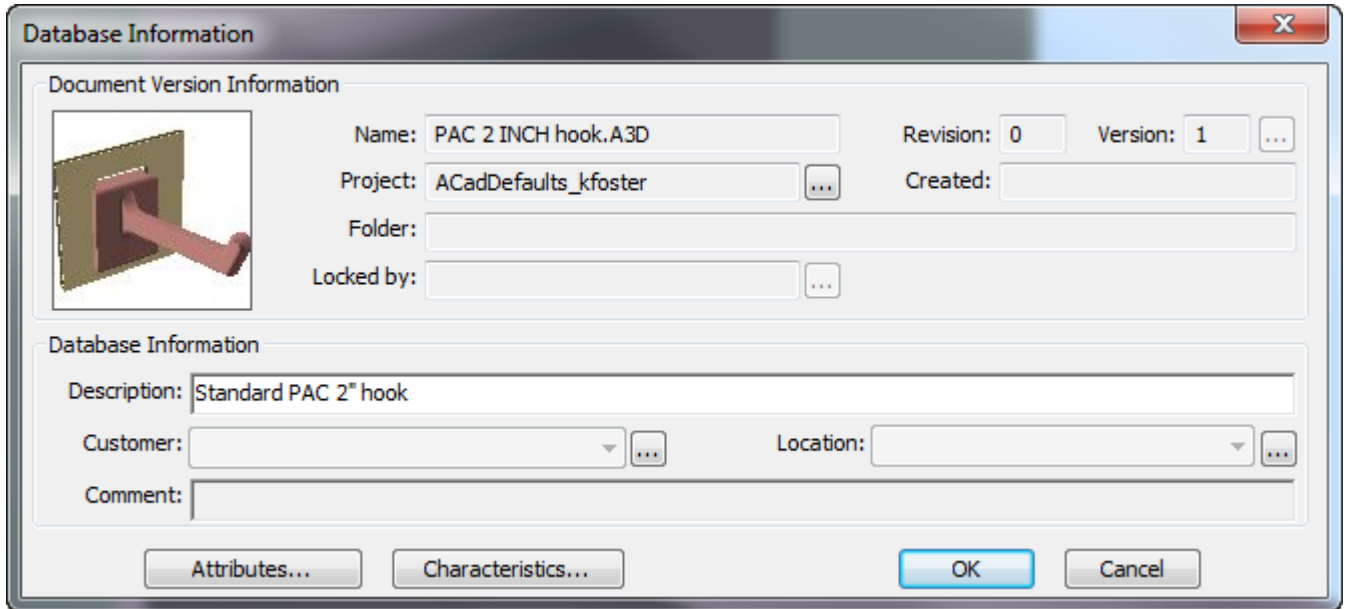

The new hardware appears in the Select Hardware dialog box when you use **Add Hardware**.

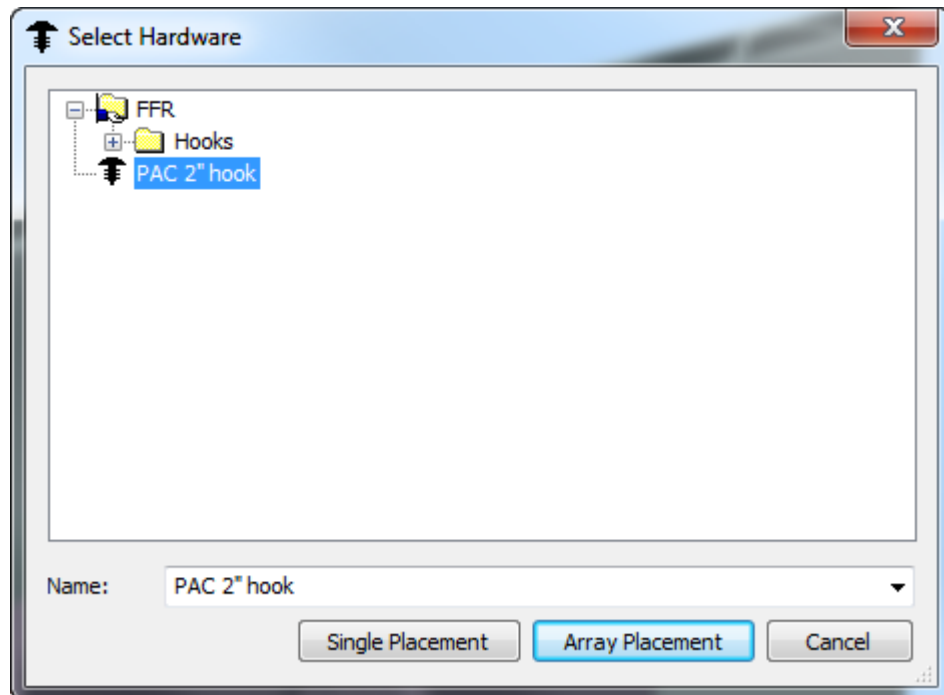

If you would rather add the hardware to Shared or Location Defaults, click **Save** instead of Save Hardware to Defaults dialog box, save the file to ServerLib or the Shared Defaults Project, and add an entry for it in the 3D Hardware Components catalog in the desired tier of Defaults.

Creating a Hardware Component from Scratch

You can create a hardware component manually instead of using a solid model from an outside source. Follow the general procedure for creating a hardware component from a solid model, but with these differences:

- In 3D, make it from carton pieces or from solids of revolution, making sure it makes a complete outline with no sharp angles.
- **Set as Hardware Component** combines all non-corrugated pieces into a single solid that becomes the hardware component.
- ArtiosCAD treats the corrugated pieces as alignment pieces and supports only one alignment piece. The alignment piece:
 - Must be a corrugated rectangle.
 - Must have at least one hole.
 - Must be aligned vertically.
 - Should have the correct holes.
 - The caliper should be around the minimum it will be used with.
 - The front surface of the alignment piece should align with the front of the grip (the part that attaches the hardware to the alignment piece).
 - Rotate the view so the hardware points toward you.
- If you need different holes for the same piece of hardware, create separate workspaces with those holes and separate entries in the 3D Hardware Components catalog.

Modifying a Hardware Component

If you need to change the caliper of an existing hardware component, open its workspace (presumably in ClientLib, ServerLib, or one of the Defaults Projects) and click **Options > Hardware Properties** to change the range of supported calipers.

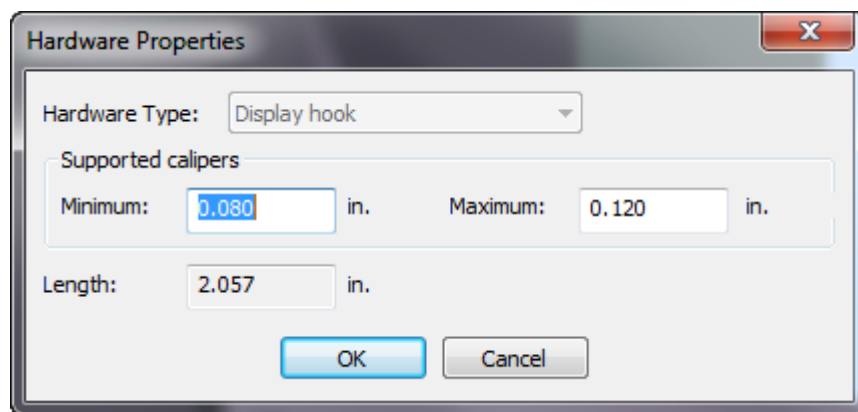

To change the length, which does not always behave predictably and is unsupported, click **Help > Diagnostics > Stretch Hardware**, enter a new length, and click **Stretch**.

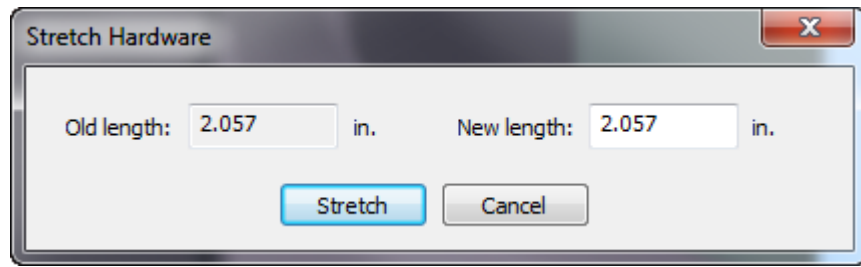

Save the workspace, making sure to save it to the proper Defaults location.

Rebuild Tool Overview



Rebuild on the Cross Section toolbar and the Tools menu lets you rebuild a design in 3D in the same ArtiosCAD session after you converted it from a resizable 2D design.

To rebuild it in a future ArtiosCAD session, reconvert the original 2D to 3D and select **Update 3D** in the Convert to 3D dialog box.

Note:

ArtiosCAD deletes any animation when you start this tool.

This tool does not work on 3D designs based on LASERPOINT standards.

Rebuild Tool

To rebuild a design in 3D, do the following:

1.  Click **Rebuild** on the Cross Section toolbar or on the Tools menu.
2. Hover over the design to rebuild. ArtiosCAD shows the filename of the design next to the cursor.
 - ArtiosCAD turns the design magenta, and turns other instances of the same 3D design a lighter shade of magenta.

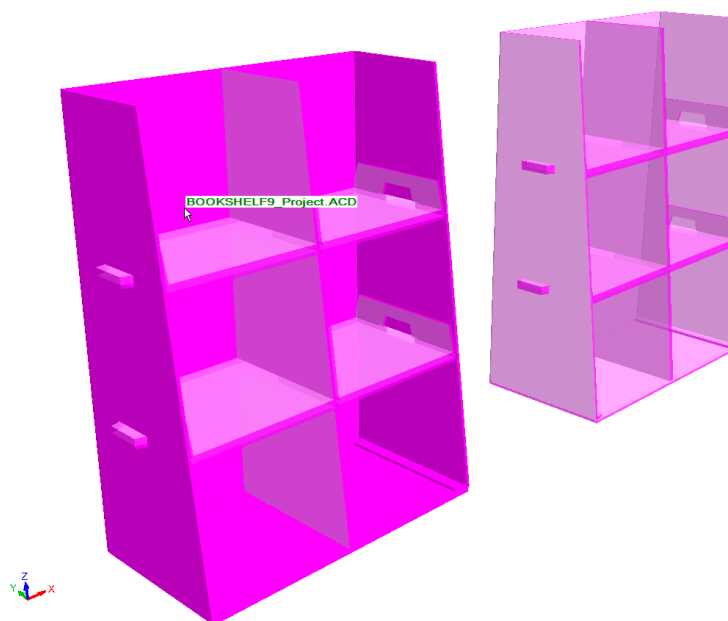

- If the associated 2D design is not open, or if the 2D design is not rebuildable, ArtiosCAD turns the design red, displays an error message in the Status bar, and uses a stop cursor.

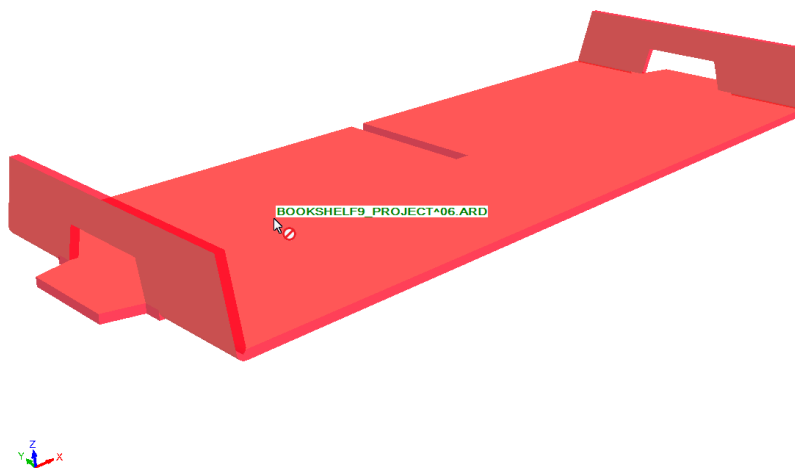

3. Click the highlighted design. ArtiosCAD does an **Update 2D** for the associated 2D design and prompts you to update part counts if needed.

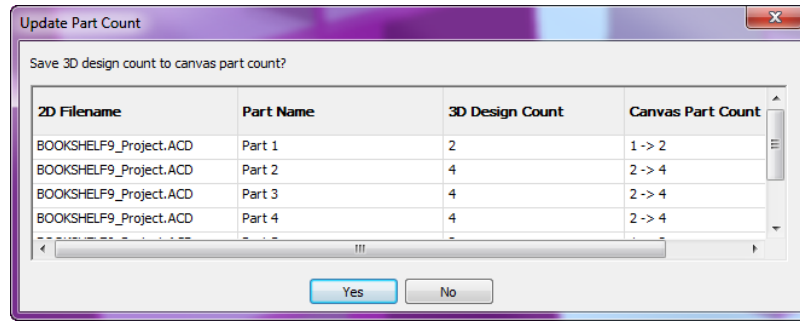

4. ArtiosCAD displays the Rebuild dialog box. Change values as desired and proceed through it normally.

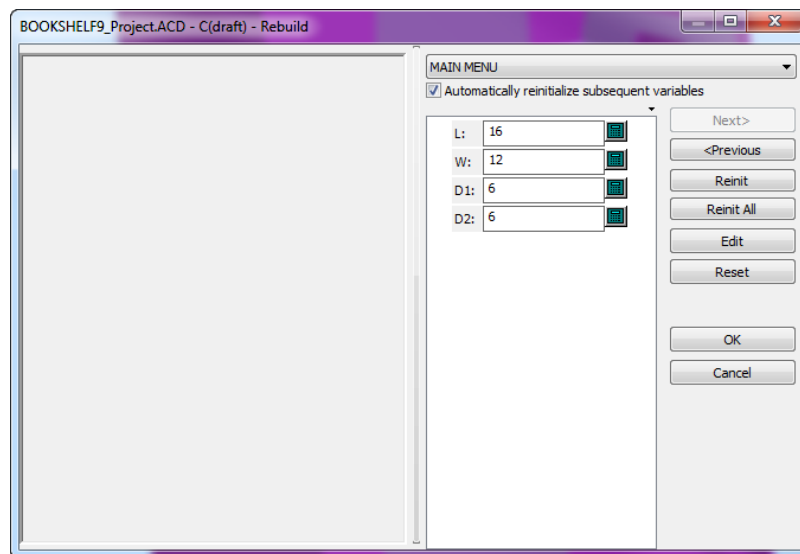

5. Click **OK** to complete the rebuild. ArtiosCAD rebuilds the design.

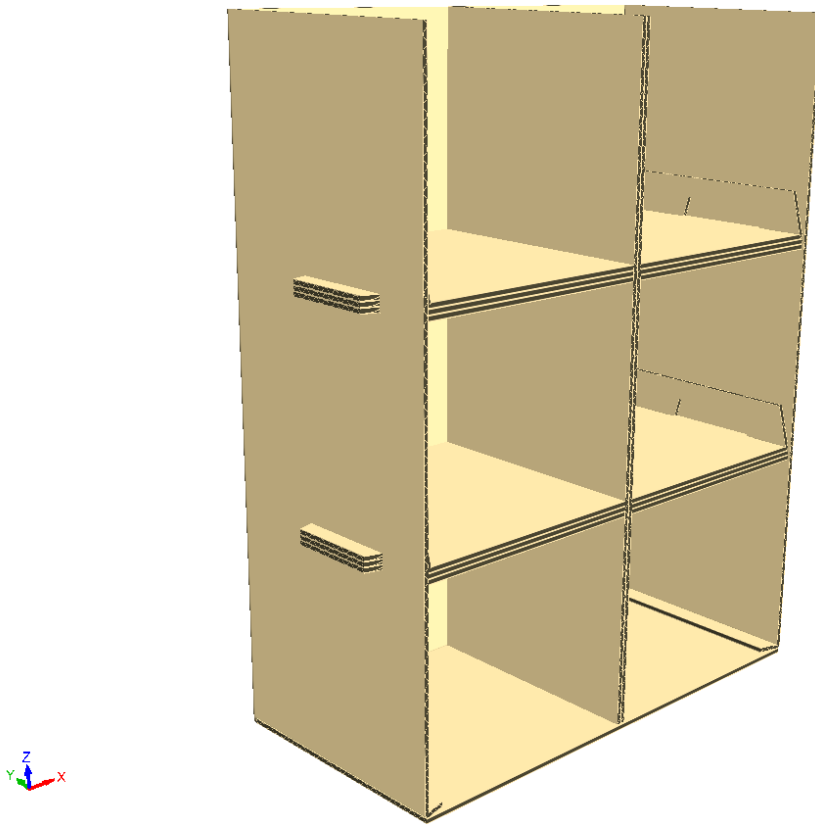

Notes on Using the Rebuild Tool in 3D

If the rebuild has unexpected results, use **Undo** to revert to the previous state.

If the rebuild results in geometry that has more pieces than before the rebuild, ArtiosCAD opens the Add Unfolded Designs dialog box and prompts you to select base faces again.

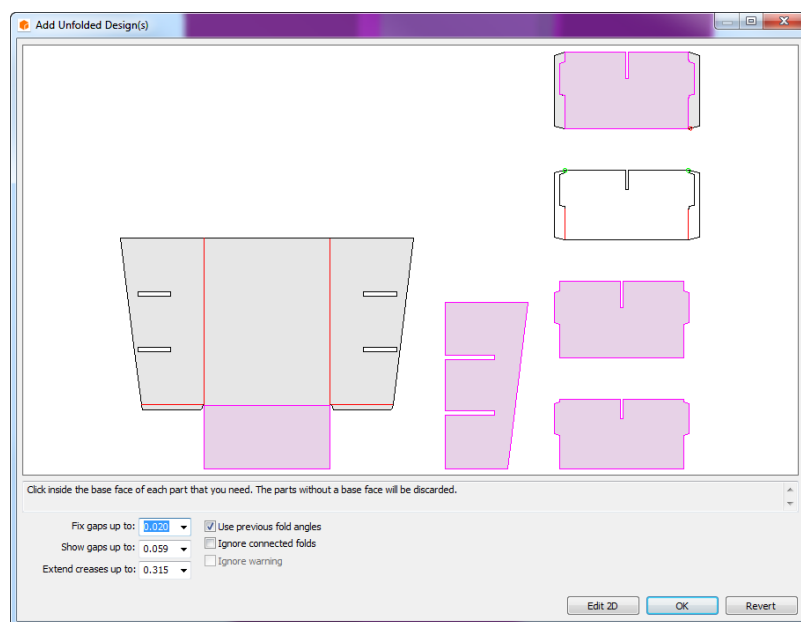

ArtiosCAD does not associate the extra pieces with the 2D document. If there are fewer pieces after the rebuild, ArtiosCAD does not display the Add Unfolded Designs dialog box.

In the Add Folded Design dialog box, there are different buttons than when you do a regular Convert to 3D. **Edit 2D** cancels the rebuild and returns to single design so you can make changes, and manually reconvert to 3D when you are done making those changes. **Revert** cancels the rebuild, reverts the 2D to what it was before the rebuild, activates the 3D view, and starts **Select Designs**. It does not revert board code changes or part count changes in canvases. **OK** is unavailable if there are errors.

If the rebuild fails, ArtiosCAD shows the 2D Rebuild Failed dialog box.

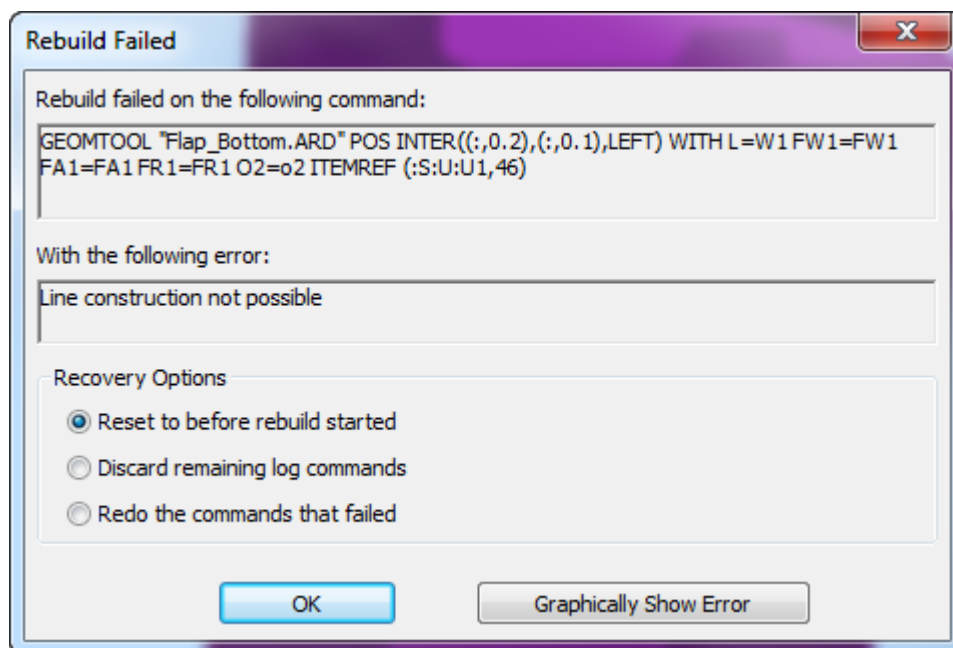

If you choose **Reset to before rebuild started**, ArtiosCAD makes no changes to the 2D or 3D designs. If you choose **Discard remaining log commands** or **Redo the commands that failed**, ArtiosCAD changes the 2D, makes it active for editing, and leaves the 3D unchanged.

Notes on Splitting Designs

When you split designs in 3D due to adding hardware or changing properties when there are multiple copies of a design, ArtiosCAD prompts you how to handle making the separate copy caused by splitting the design.

Depending on the circumstances, and if you tell it to, ArtiosCAD will create a new canvas part or single design that will contain the added hardware or changed properties.

Canvases

If you accept the default choices in the Duplicate Designs Options dialog box when splitting a design that is a part in a canvas that is open:

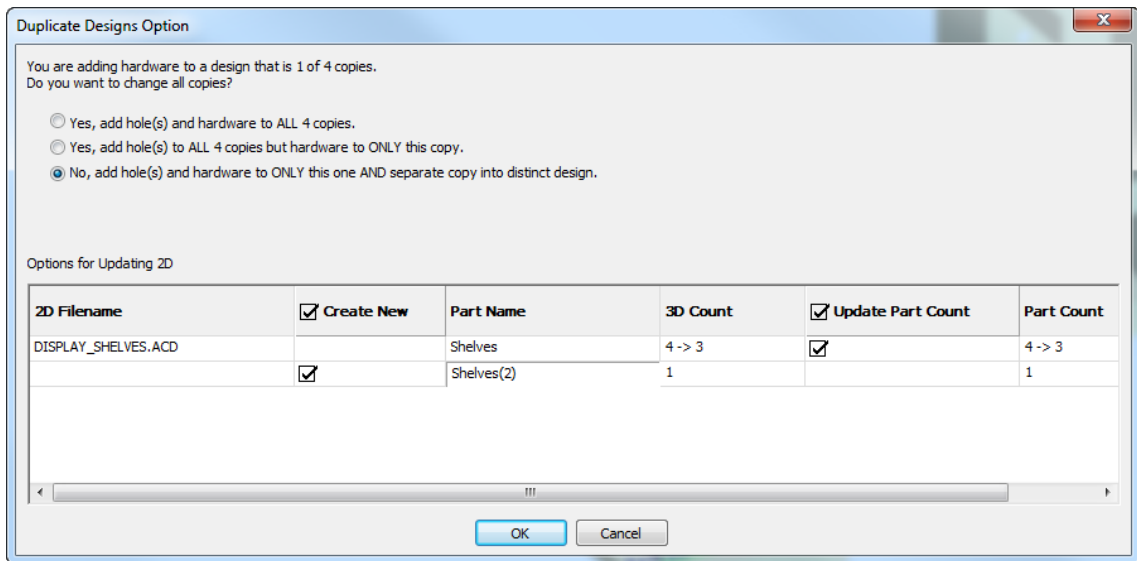

- ArtiosCAD changes the original part count to match the count in 3D
- ArtiosCAD creates a new part with the same count as in 3D
- ArtiosCAD saves the new part's properties, fold angles, and position in the canvas
- ArtiosCAD associates the new part with the changed design(s) in 3D.

If you deselect **Update Part Count**:

- ArtiosCAD does not update the part count of the original design in the canvas to match the one in 3D
- ArtiosCAD creates a new part in the canvas
- ArtiosCAD saves the new part's properties, fold angles, and position in the canvas
- ArtiosCAD changes the properties of the selected designs. or changes their hardware
- ArtiosCAD associates the changed designs in 3D with the new part in the canvas.

If you deselect everything:

- ArtiosCAD does not change the canvas and saves no 3D information
- ArtiosCAD changes the properties or hardware but the designs are no longer associated with any parts in the canvas.

3D Designs

The Duplicate Designs Options dialog box shows which designs are selected and which ArtiosCAD will create.

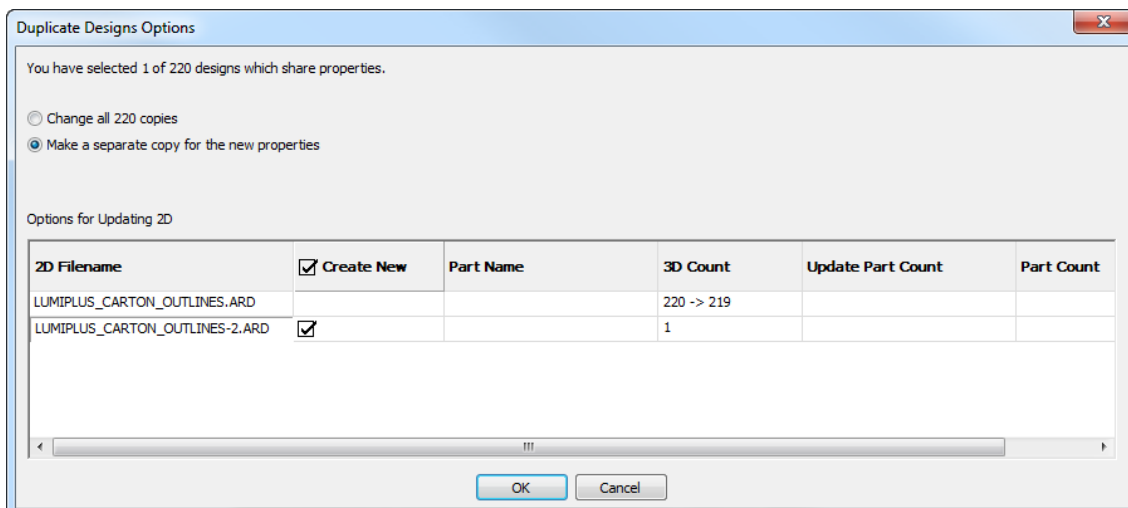

Each design has two rows. The first row shows information about the current 3D design. The second row shows information about the ArtiosCAD will create and associate with the selected designs after the split.

If you change nothing:

- ArtiosCAD creates and opens a new single design
- The new design has the same geometry as the original, but holds the 3D information for the design selected in 3D
- ArtiosCAD changes the selected design's properties in 3D and associates the duplicates with the new single design.

If you deselect **Create New**:

- ArtiosCAD does not create a new single design
- ArtiosCAD changes the selected design's properties in 3D and but does not associate duplicates with any single design.

Undo/Redo

All changes relating to splitting a design in 3D are on one level. One click will undo or redo them all.

When you undo a split:

- Undo undoes the change of association but leaves the new design open
- ArtiosCAD lists all copies of the design together in the embedded design list

When you undo a property change:

- ArtiosCAD no longer updates the associated 2D design.
- ArtiosCAD saves fold angles but not properties or positions in an associated single design or canvas

Undo/Redo will not work if you made manual changes to the single design or canvas after doing a split or property change in 3D, or adding or removing hardware. Also, Undo in 3D will no longer automatically update the 2D design.

Miscellaneous

Creating new copies when splitting designs or adding hardware deletes any animations.

Any errors (such as exceeded limits) show in yellow in the Duplicate Designs Options dialog box.



Synchronizing changes between 3D and 2D

ArtiosCAD maintains links between 2D and 3D workspaces. If both workspaces are open, It immediately synchronizes some of these links but others only get synchronized when you save the workspace or use **Update 2D**.

Property/Action	Change type	Workspace type	Synchronization type
Hardware holes	Structural	Single Design	Immediate
Hardware holes with no part split	Structural	Canvas	Immediate
Color	Material	Single Design	Manual
Color with no part split	Material	Canvas	Manual
Textures	Material	Single Design	Manual
Textures with no part split	Material	Canvas	Manual
Board information	Structural or Material	Single Design	Manual
Board information with no part split	Structural or Material	Canvas	Manual
Any part split	Structural	Canvas	Immediate
Changing the number of 3D copies	Structural	Single Design	Not available
Changing the number of 3D copies	Structural	Canvas	Manual

Splitting an imported design into multiple parts

To split an imported design into multiple parts, do the following.

-  Use the **Select Labels or Parts** tool to select the elements of the design to split into a separate design.
-  Click **Group**.
- ArtiosCAD will warn you that you are grouping the selected parts into a separate design. Click **OK** to split the parts into a separate design. The selected parts will be a single separate design; they will not be separated into individual designs.

Note: You cannot undo this procedure.

Palletization in 3D

You can round-trip data between Cape Pack/TOPS and ArtiosCAD to palletize a 3D design, make a secondary (shipping) container in Cape Pack/TOPS starting in 3D, and also to make a pallet load in 3D starting in Cape Pack/TOPS.

For answers to some frequently asked questions about palletization, see *Palletization FAQ* in the *Outputs* chapter.

Note:

Before using these features for the first time, make sure you have mapped Cape Pack/TOPS styles and materials to ArtiosCAD standards and boards as described in the *Builder* chapter. You may also want to set Cape Pack/TOPS defaults as described in the *Defaults* chapter.

Palletizing a 3D workspace

To send a 3D workspace to Cape Pack for palletizing and then view the Cape Pack solution back in 3D, follow the instructions below. If you are using TOPS, the workflow is similar: choose a pallet and send the information to TOPS, which will palletize the design and send the information back to 3D.

1. In 3D, design a new workspace or open an existing one, and assemble its components as desired. Make sure to fold it into its final form as its bounding box will be used for the sizing information in Cape Pack.

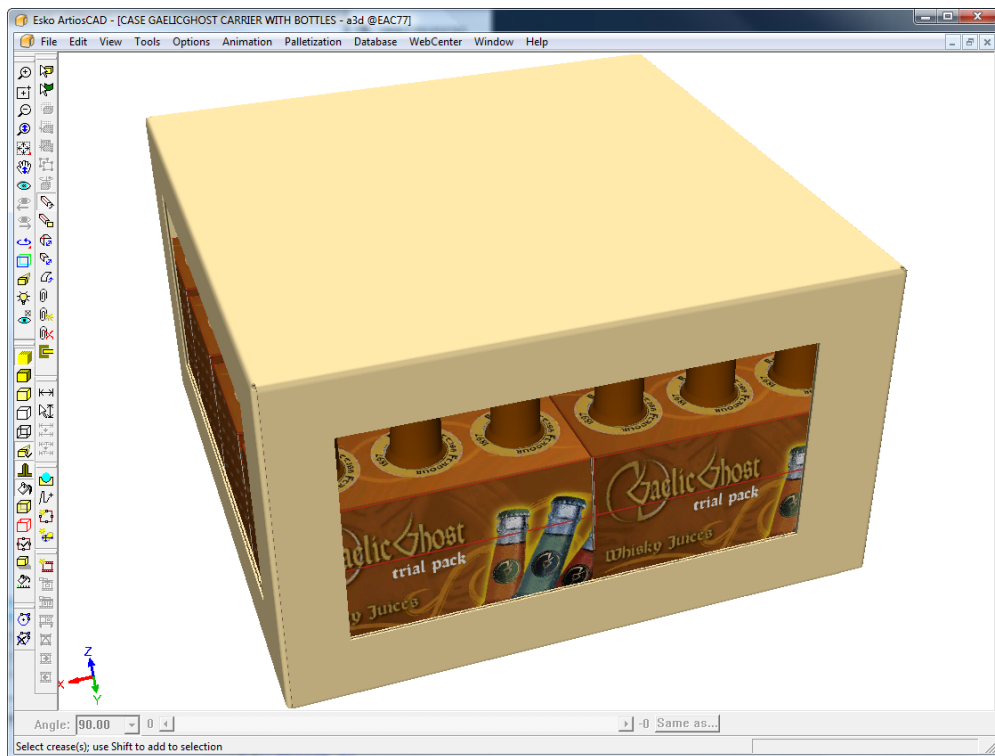

2. Click **Palletization > Change Pallet**.
3. In the Select Pallet dialog box, select a pallet and click **OK**.

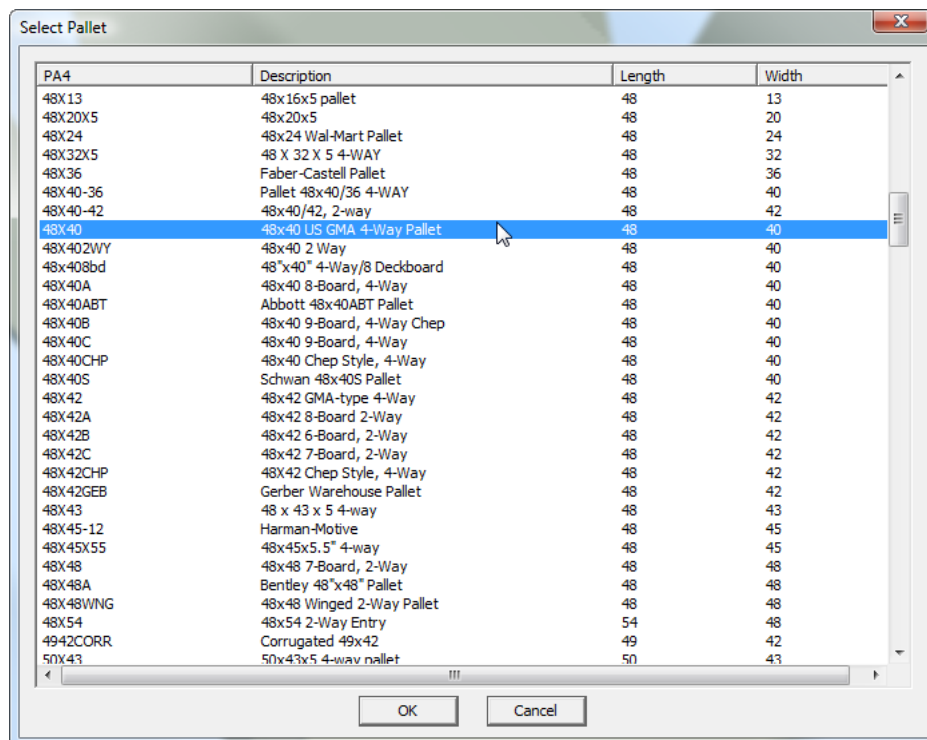

4. Click **Palletization > Palletize Design**.

ArtiosCAD creates a copy of the workspace and works with the copy in order to not infringe on your original.

5. In the Cape Palletize dialog box, choose **Pallet Group**.
6. Set the values in the **Package Information** and **Pallet Information** groups as appropriate and click **OK**.

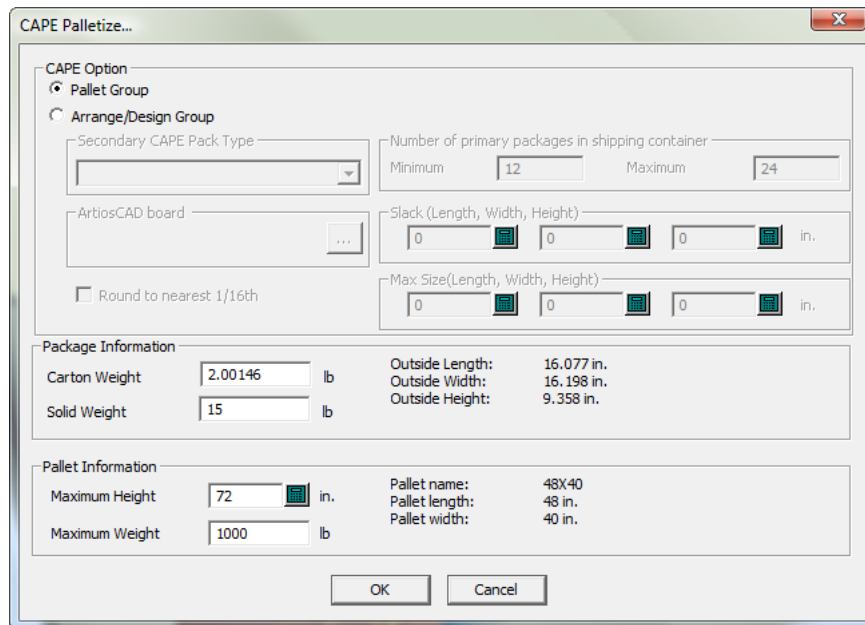

Click **OK** through any alerts. Cape Pack may prompt you that it is swapping the dimension directions.

Note:

ArtiosCAD is unusable while waiting for a response from Cape Pack.

7. In Cape Pack, use the **Goto Next Solution** and **Goto Previous Solution** arrows to find the best solution.

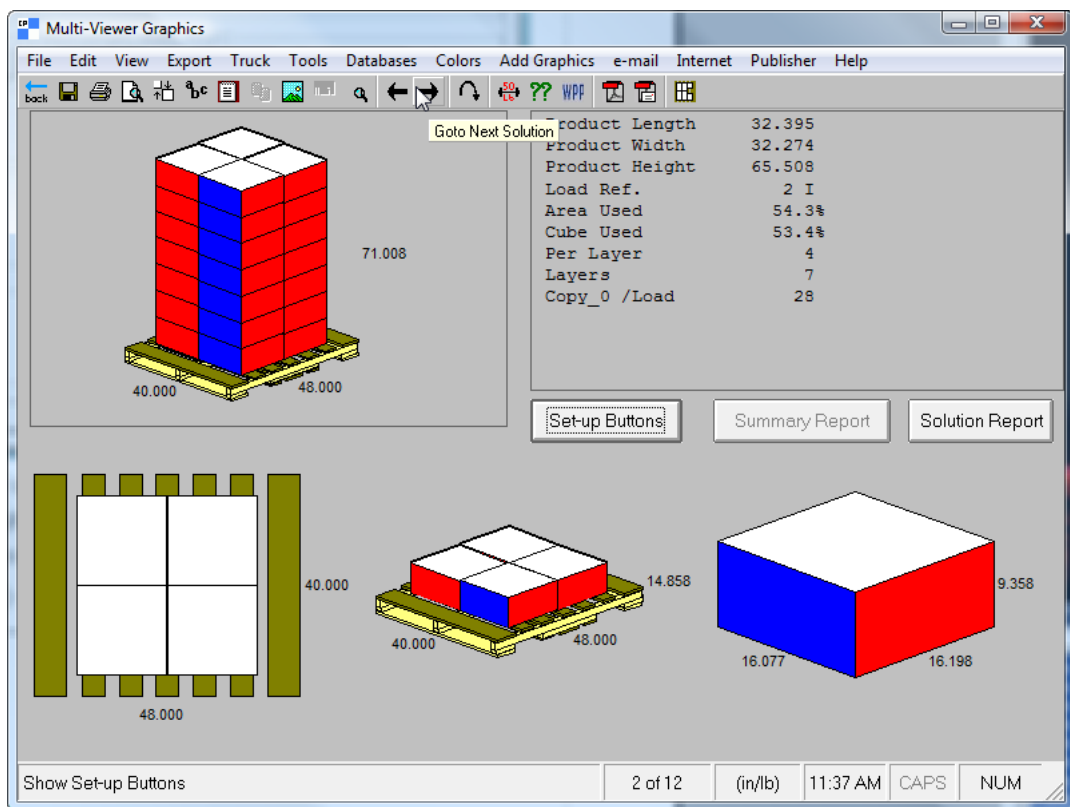

8. When you have found the best solution, click **File > Export and Exit**.

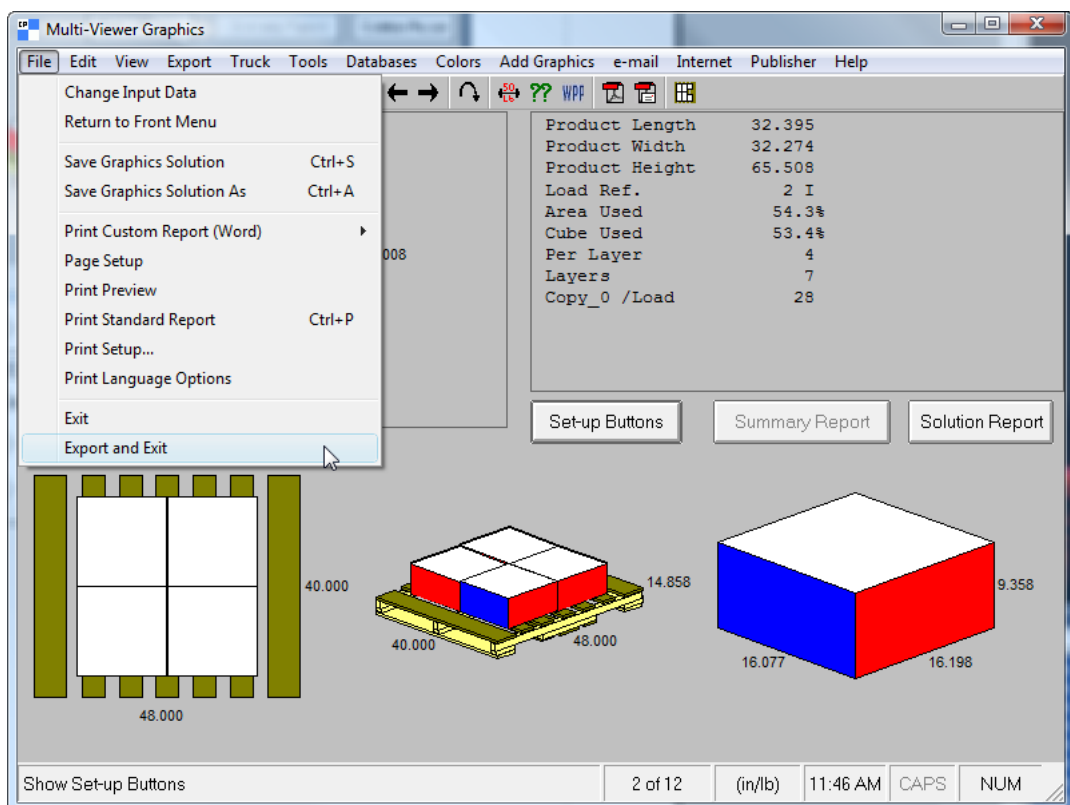

9. The palletization solution appears in 3D; save it and work with it as a normal 3D workspace. Remember that this is a copy and not your original 3D workspace.

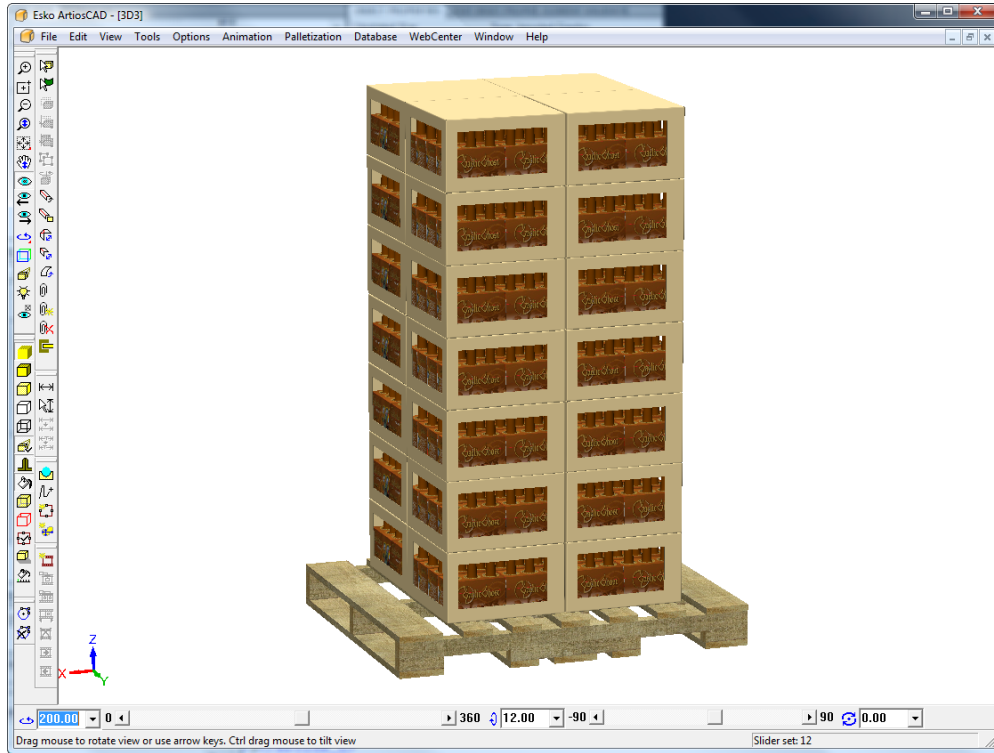

Arranging a Group in CAPE around a 3D workspace

In addition to palletizing a workspace from 3D in Cape Pack, you can also create secondary packaging in Cape Pack for your primary package in 3D.

To create secondary packaging around your primary package, do the following:

1. In 3D, design a new workspace or open an existing one, and assemble its components as desired.

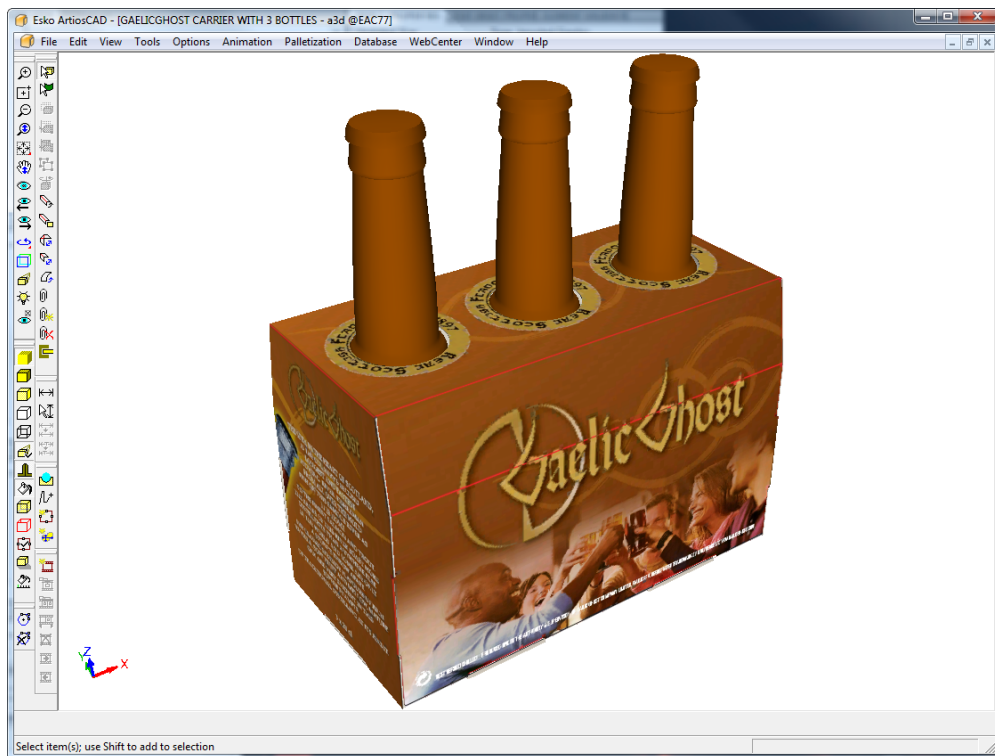

2. Click **Palletization > Change Pallet**.
3. In the Select Pallet dialog box, select a pallet and click **OK**.

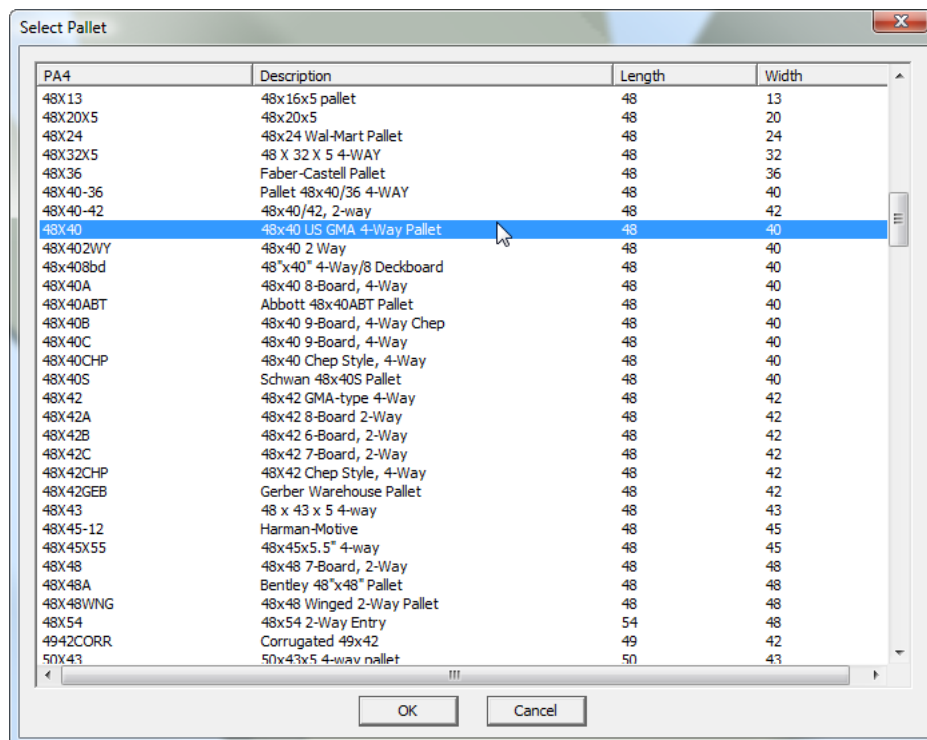

4. Click **Palletization > Palletize Design**.

5. In the Cape Pack Palletize dialog box, choose **Arrange/Design Group**.

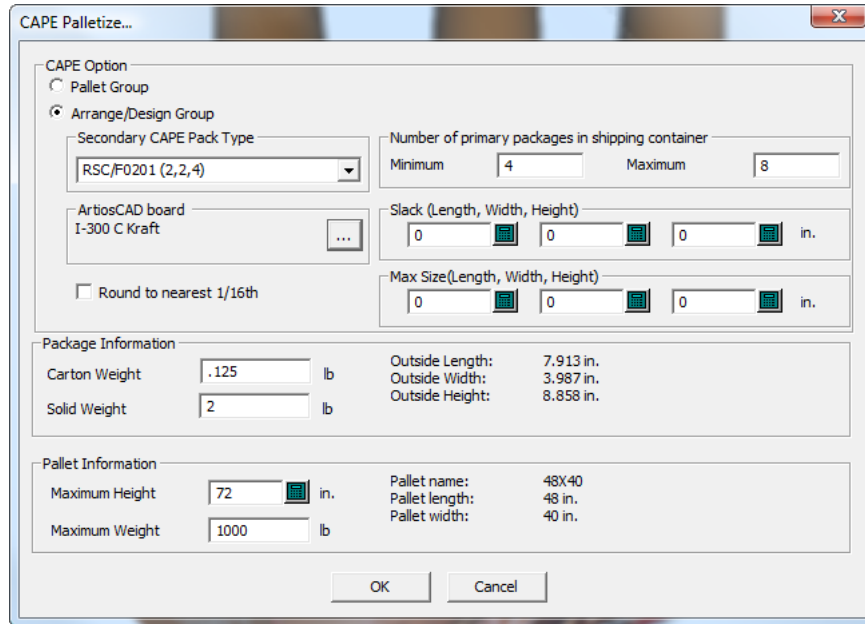

6. Enter appropriate values in the fields:

- a) Select the secondary package from the **Secondary CAPE Pack Type** drop-down list box.
- b) In the **ArtiosCAD board** group, click Properties (...) and select a board code.
- c) In the Minimum and Maximum fields, enter the number of primary packages to create secondary packages for. If you have more than one primary package in your 3D workspace, divide these numbers accordingly; for example, if you had 4 primary packages in 3D, you would only want 1 or 2 of them in Cape Pack.
- d) Enter values for the slack (gaps between the primary packages) and the maximum size of the secondary packaging, if desired.
- e) Check **Round to nearest 1/16th** if desired.
- f) In the **Package Information** group, enter the weight of the primary package and any solids it contains.
- g) In the **Pallet Information** group, enter the maximum height of the stacked pallet and its maximum weight.
- h) Click **OK**.

Cape Pack will launch. Click **OK** through any alerts. Cape Pack may prompt you that it is swapping the dimension directions.

Note: ArtiosCAD is unusable while waiting for a response from Cape Pack.

7. Use the **Goto Next Solution**, **Goto Previous Solution**, **Goto Next Pattern**, and **Goto Previous Pattern** arrows to find the best solution. The primary package is the one with yellow and magenta faces, while the secondary package has red and blue faces.

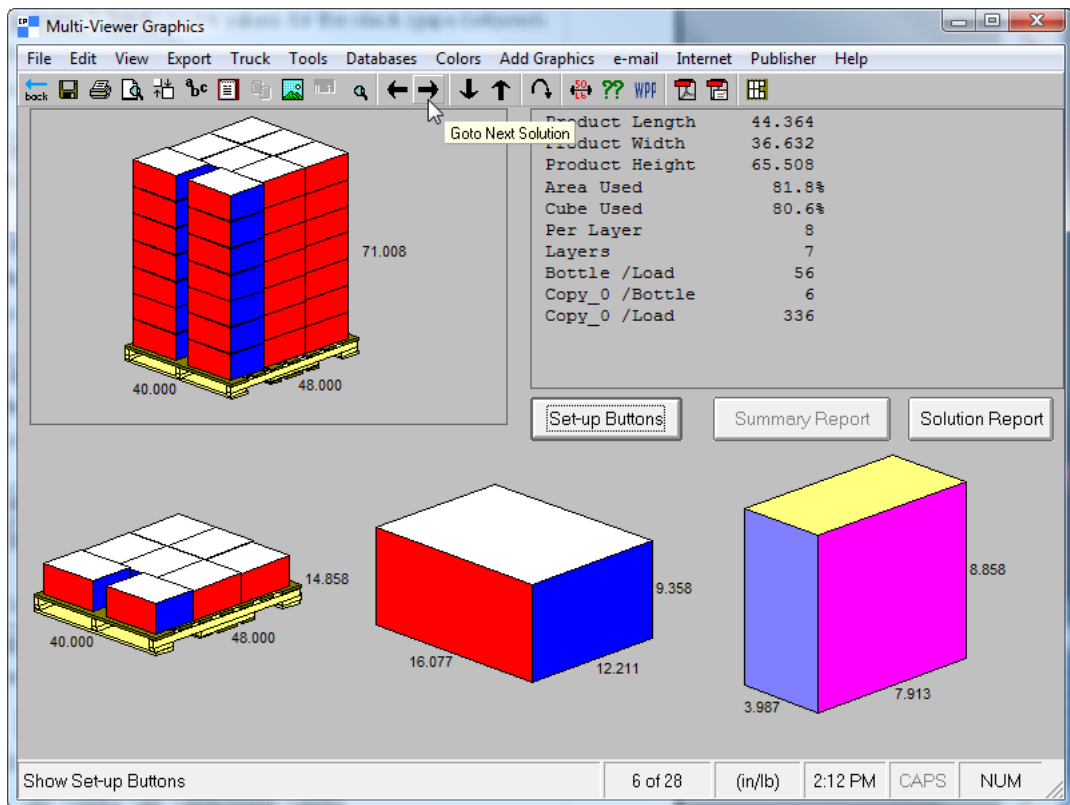

8. When you have found the best solution, click **File > Export and Exit**.

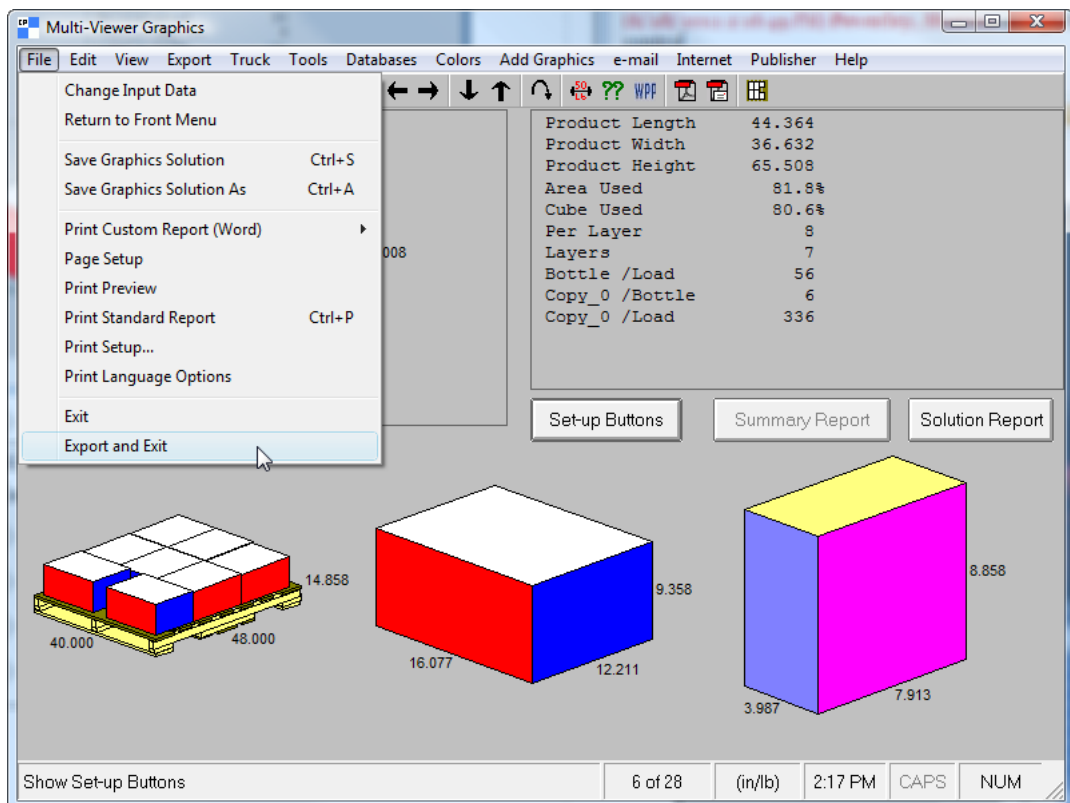

If you do not have either the styles or boards mapped as described previously, ArtiosCAD will prompt you to choose the missing elements.

9. ArtiosCAD displays the standard it constructed using the Cape Pack data. Work with the single design as you would any other workspace.

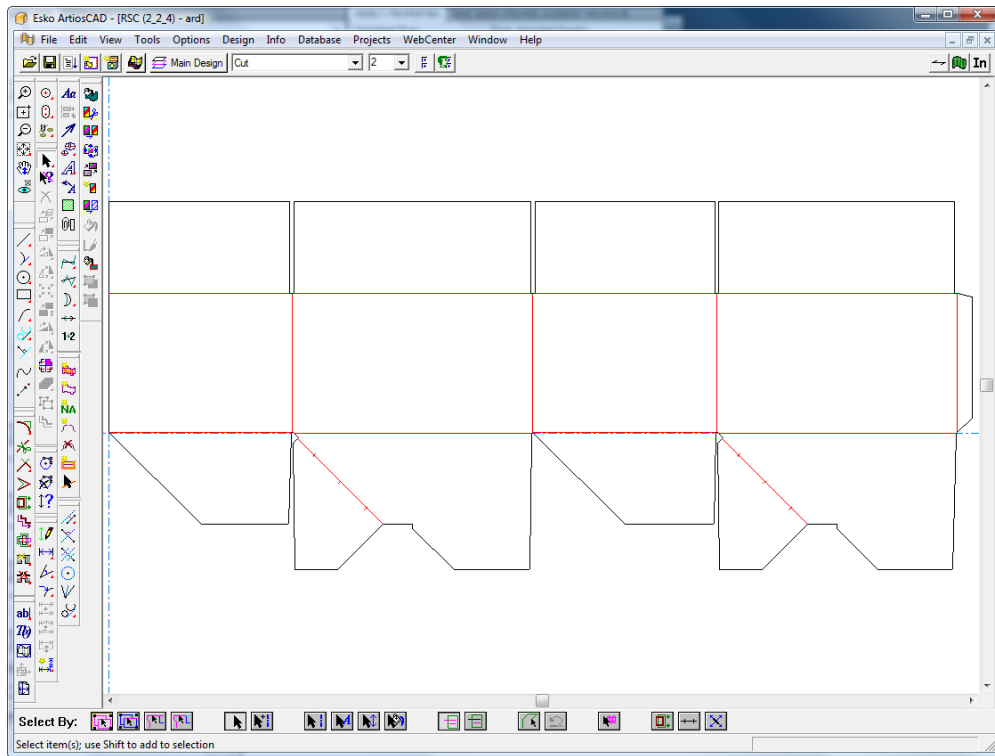

10.  Click **Convert to 3D** and then **Add to 3D** with the primary package's workspace selected, and then click **OK**.

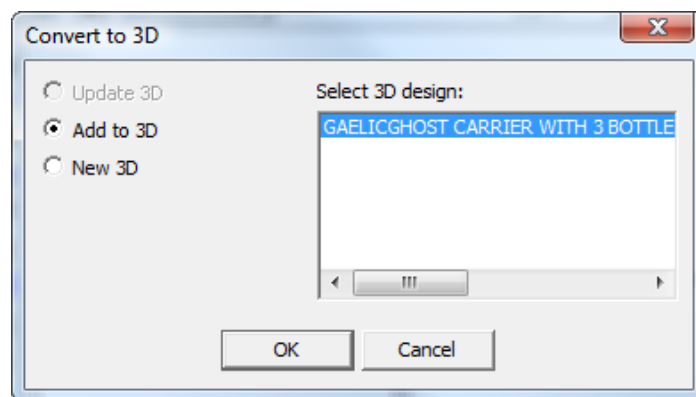

The secondary package appears in the 3D workspace.

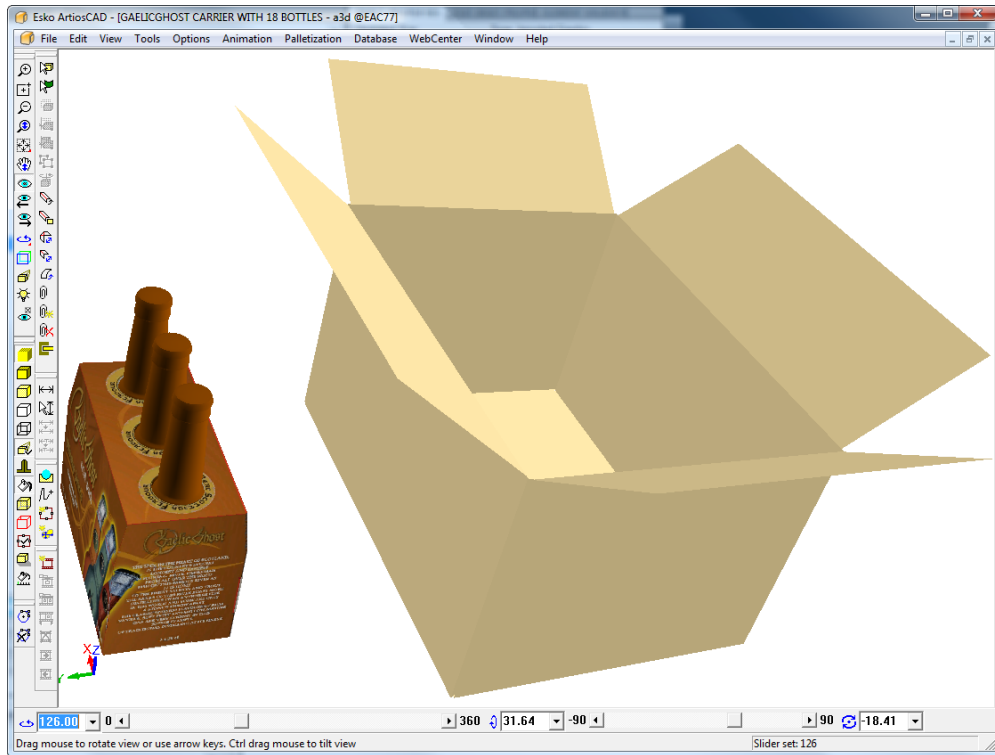

11. Use the tools in 3D to duplicate and align the primary packaging inside the secondary packaging as desired.

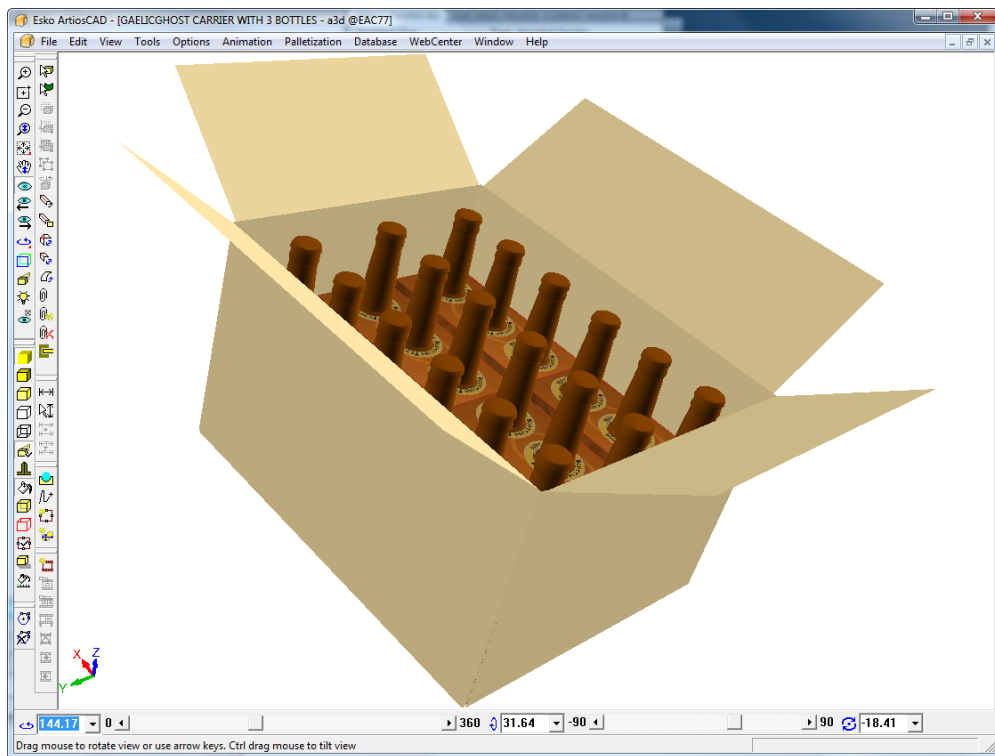

Creating a Folding Carton Arrange case using Cape

A knock down flat (KDF) is a container that is folded for shipping, arranged into bundles, and then put into a shipping container (the FCA case) for full assembly elsewhere. In Cape Pack, this is done using **Folding Carton Arrange (FCA) > New Case Sizes > Nested Cartons in Bundles**. In ArtiosCAD, this is called creating an FCA case and is on the Palletization menu.

The workflow is generally:

- Create the flat single design in ArtiosCAD
- Tell ArtiosCAD to create an FCA case and set the parameters
- Calculate the FCA solution in Cape Pack and export the palletization data to ArtiosCAD
- Convert the resulting single design for the case to 3D
- Fold the case at 90 degrees
- Show the palletization data that came from Cape Pack
- Optionally, run a Report showing the FCA case (described in the *Outputs* chapter).

You may also start with your own single design, convert it to 3D and fold it in half so it is flat, and then start the workflow from 3D. Both workflows require 3D.

Note: You must have Cape Pack installed to create an FCA case.

Creating the FCA case and calculating the pallet load

To create the FCA case, do the following:

1. Create a single design, either by running a standard or by making your own, or convert an existing single design to 3D and fold it in half.
2. Click **Palletization > FCA Bundles in New Case**.
3. In the Select Pallet dialog box, choose a pallet for the design and click **OK**.

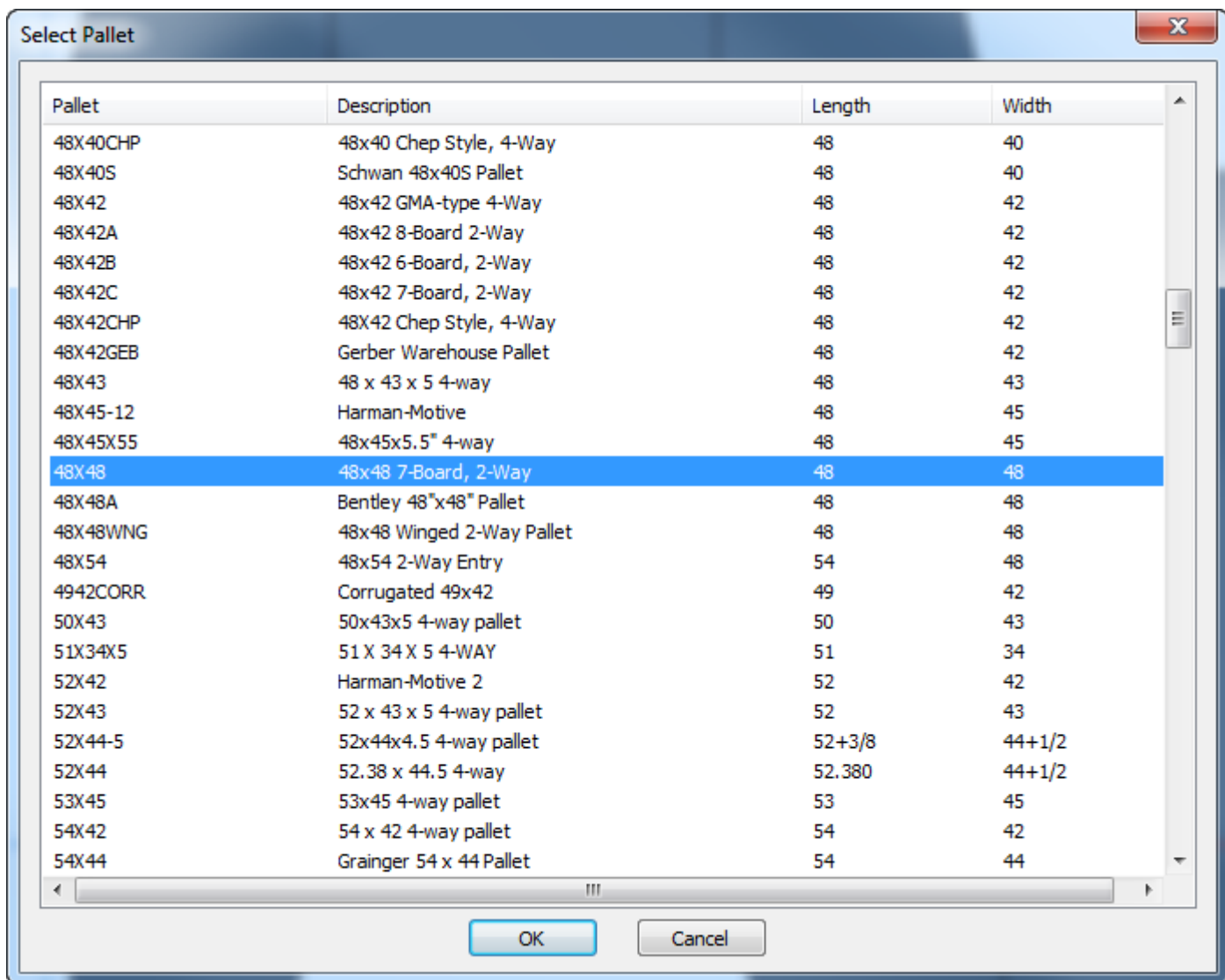

4. In the Create New FCA Case dialog box, enter the values you need to make your FCA case.

Create New FCA Case

FCA

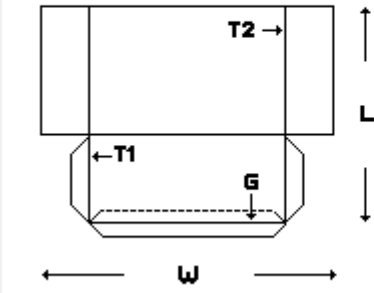

Folded Glue Joint (G) (value or variable)
 in. Calculate FCA

Length (L): in. Width (W): in.

Thickness (T1): in. Thickness (T2): in.

Weight: lb Fluff Factor: %

Bundle Counts

Minimum:

Maximum:

Case

Type: *

Board: *

Max Weight: lb

Number of FCAs

Minimum:

Maximum:

Slack

Length: in.

Width: in.

Height: in.

Max Size

Length: in.

Width: in.

Height: in.

- a) Length, Width, Thickness 1, Thickness 2, and Weight come from the single design, but you may change them as desired. Thickness 2 is initially 0 because ArtiosCAD assumes there is only one fold per knock-down flat carton (KDF) inside the case. If you have more than one fold, enter the cumulative increase in thickness per KDF past the one double board thickness for one fold. You can also adjust these thicknesses if one end of the KDF is thicker than the other to have Cape Pack alternate their positions within the bundle.
- b) The length is based on the blank size and ArtiosCAD assumes the glue joint is not folded. If it is folded, enter its size in Folded Glue Joint. Note that the dimensions and diagram are shown differently from the ones in Cape Pack but the carton is folded the same way.
- c) Click **Calculate FCA** to calculate the sizes based on the Flatblank to KDF formula in Cape Pack.
- d) For the Fluff Factor, enter an estimate of the percentage that the folded cartons might shrink or expand within the bundles.
- e) In the Bundle Counts group, enter the minimum and maximum number of bundles to create.
- f) In the Case group, choose the type of case (from Cape Pack) and the ArtiosCAD board code to use.
- g) In the Number of FCAs group, enter the minimum and maximum number of cartons inside the case.

- h) In the Slack group, enter the dimensions for the size of the free space between the bundles and the cases.
 - i) In the Max Size group, enter the maximum size for each bundle.
 - j) For the Max Weight, enter the maximum weight of the filled case.
 - k) Click **OK**. ArtiosCAD will launch Cape Pack.
5. As Cape Pack always thinks that the longer dimension is the length, it may prompt you that the variables are mismatched. Click **OK**.

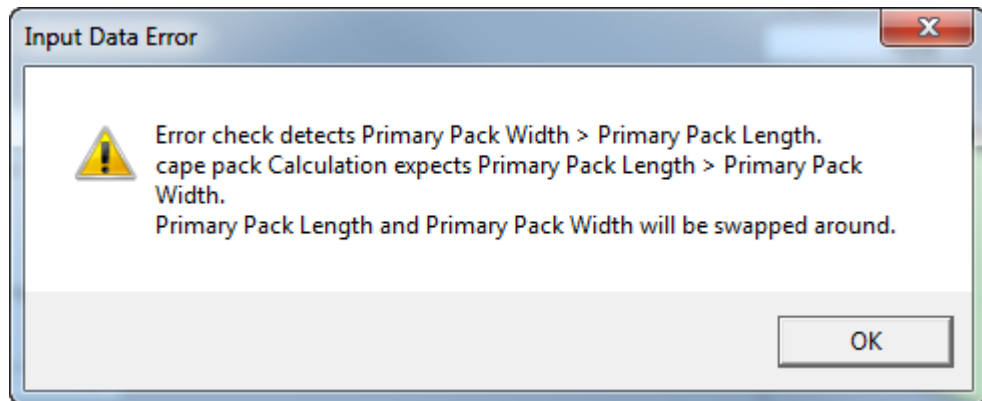

6. Cape Pack will automatically start calculating solutions.

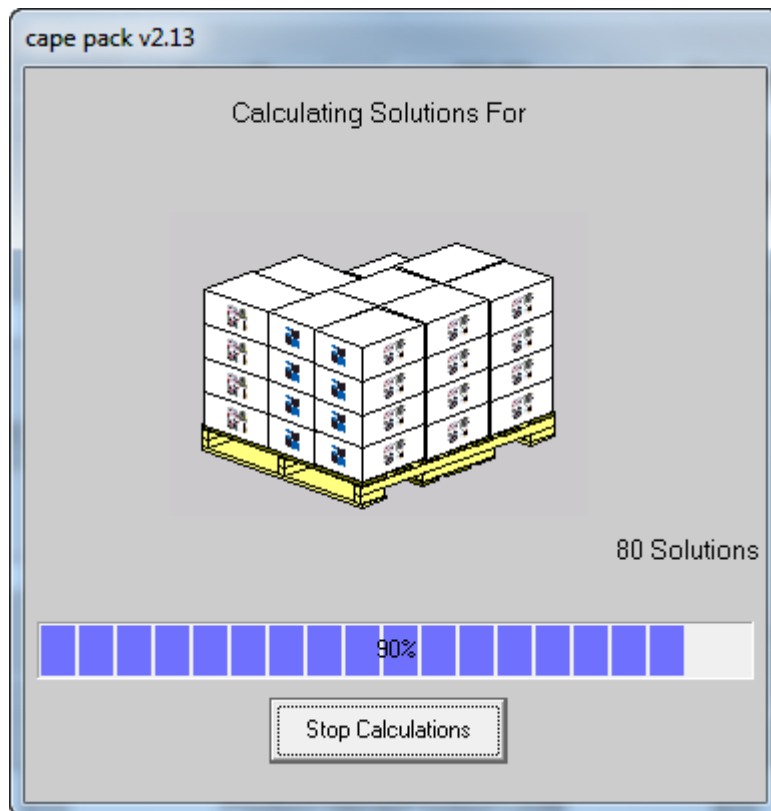

7. Use the arrows to review the solutions.

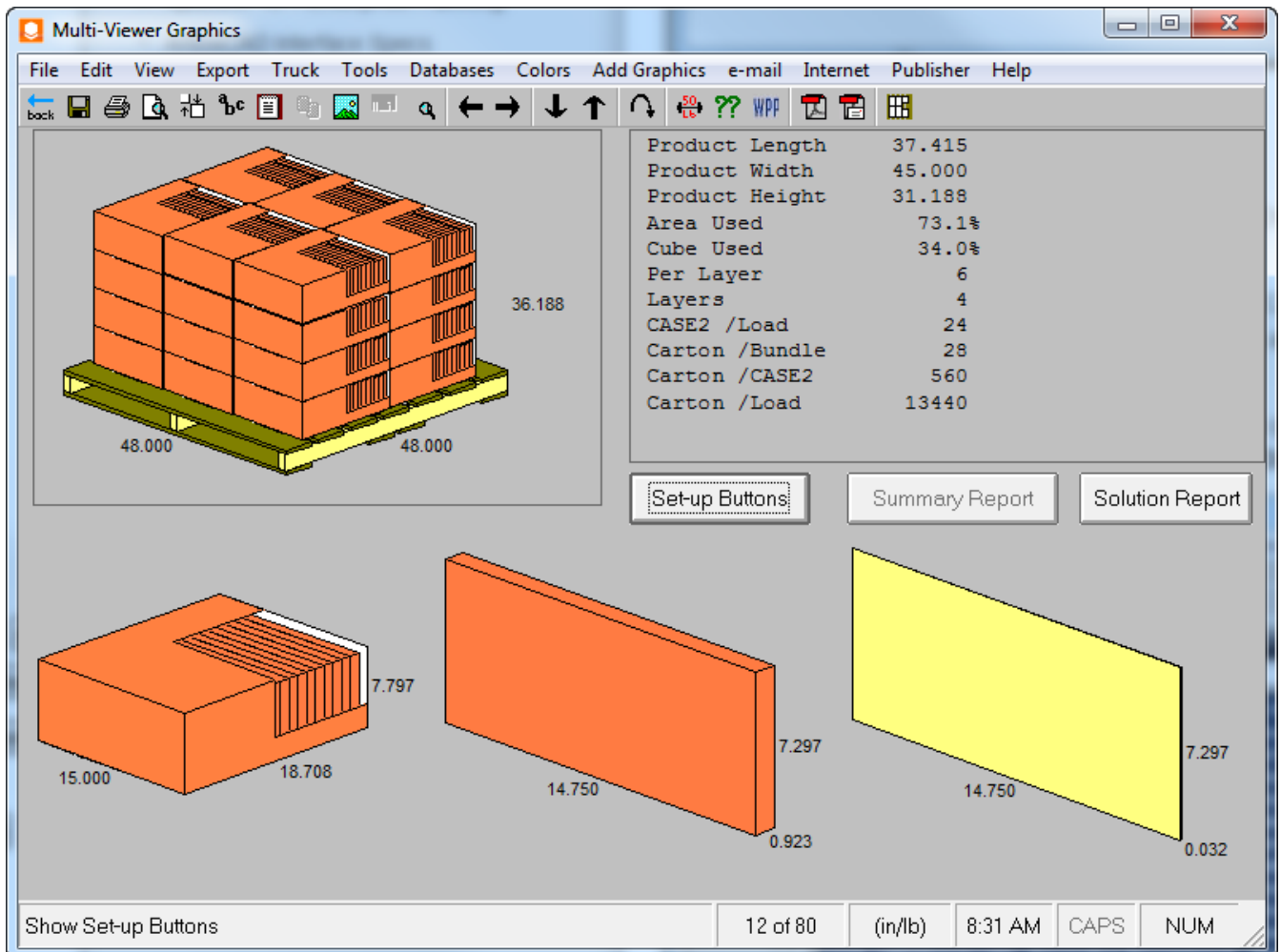



8. When you have chosen the desired solution, click **File > Export and Exit** to return to ArtiosCAD.

Folding the FCA case solution from Cape

Cape Pack returns the case and palletization data to ArtiosCAD.

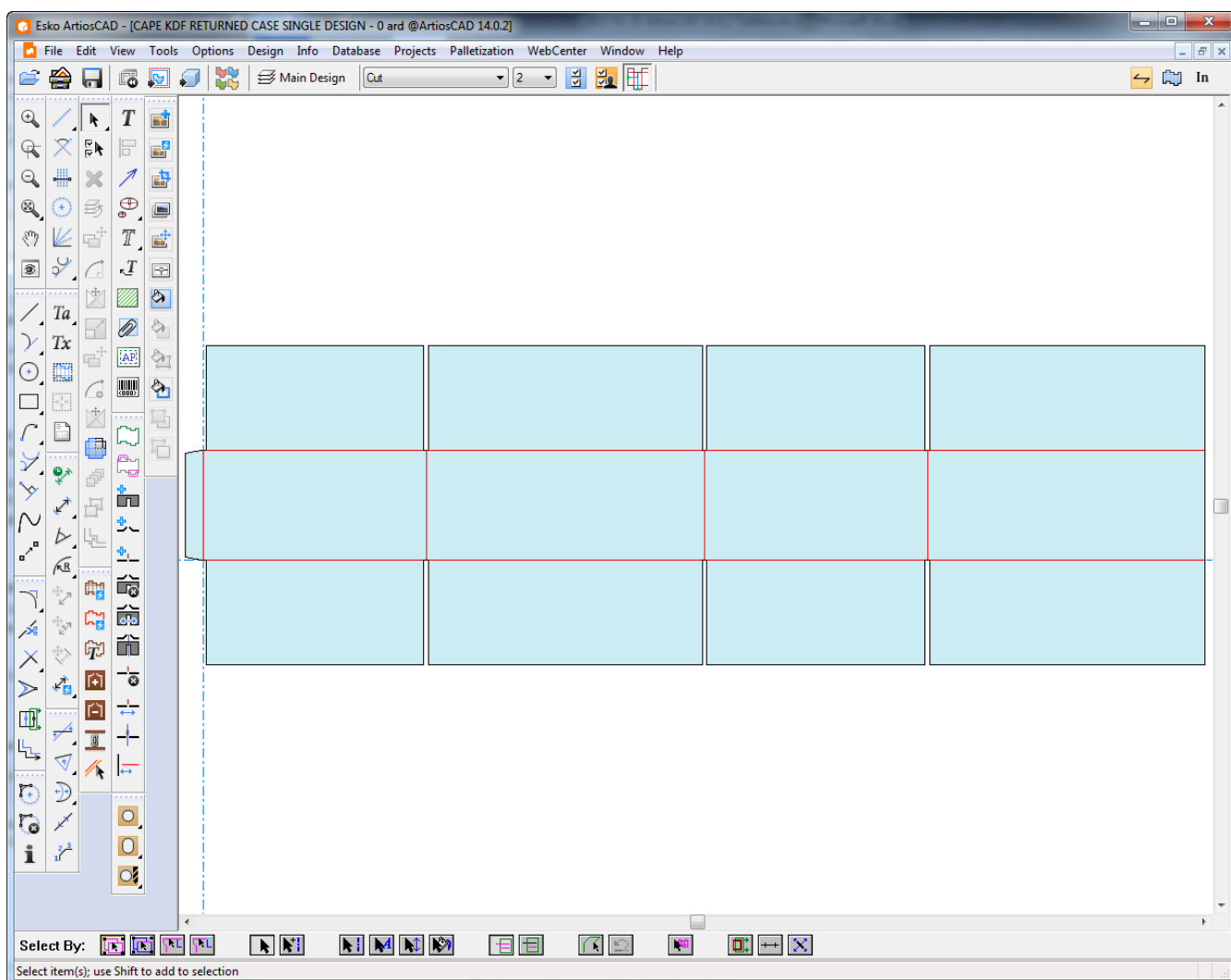
1. If you do not already have any standards mapped to Cape Pack designs, choose the standard to run to substitute for the FCA case resulting in a single design. You may modify the single design as desired.



2.  Convert the single design to 3D.
3.  Fold all creases at 90 degrees.

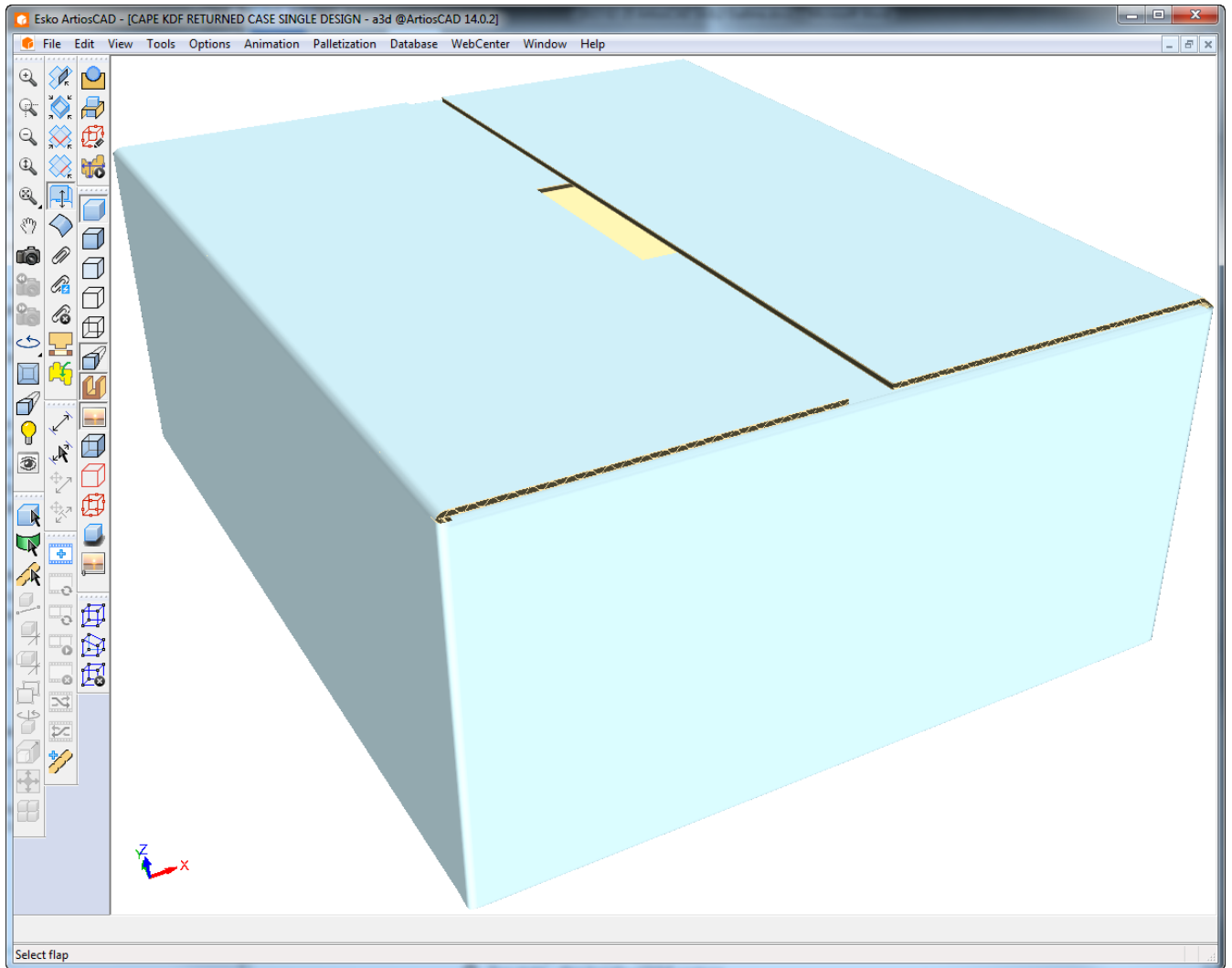

4. Click **Palletization > Show Last Palletization solution.**
5. As Cape Pack and ArtiosCAD measure dimensions differently, there may be a mismatch. Click **Yes** to continue.

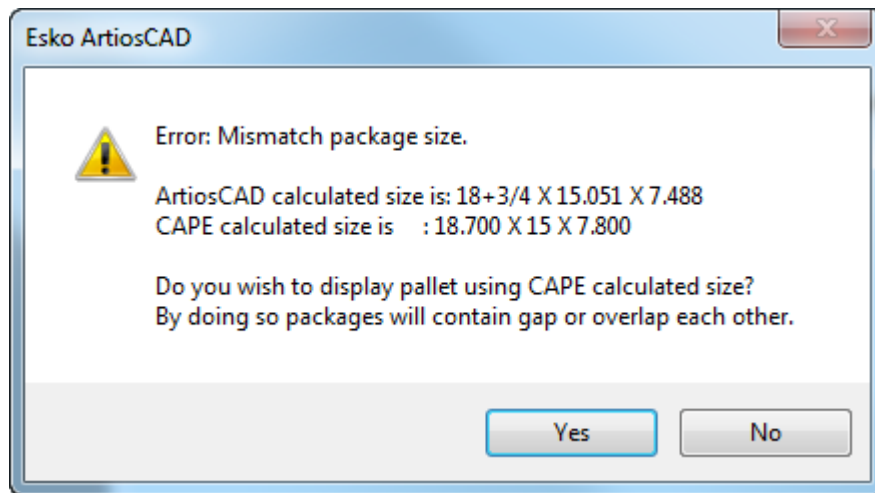

6. ArtiosCAD displays the palletized case.

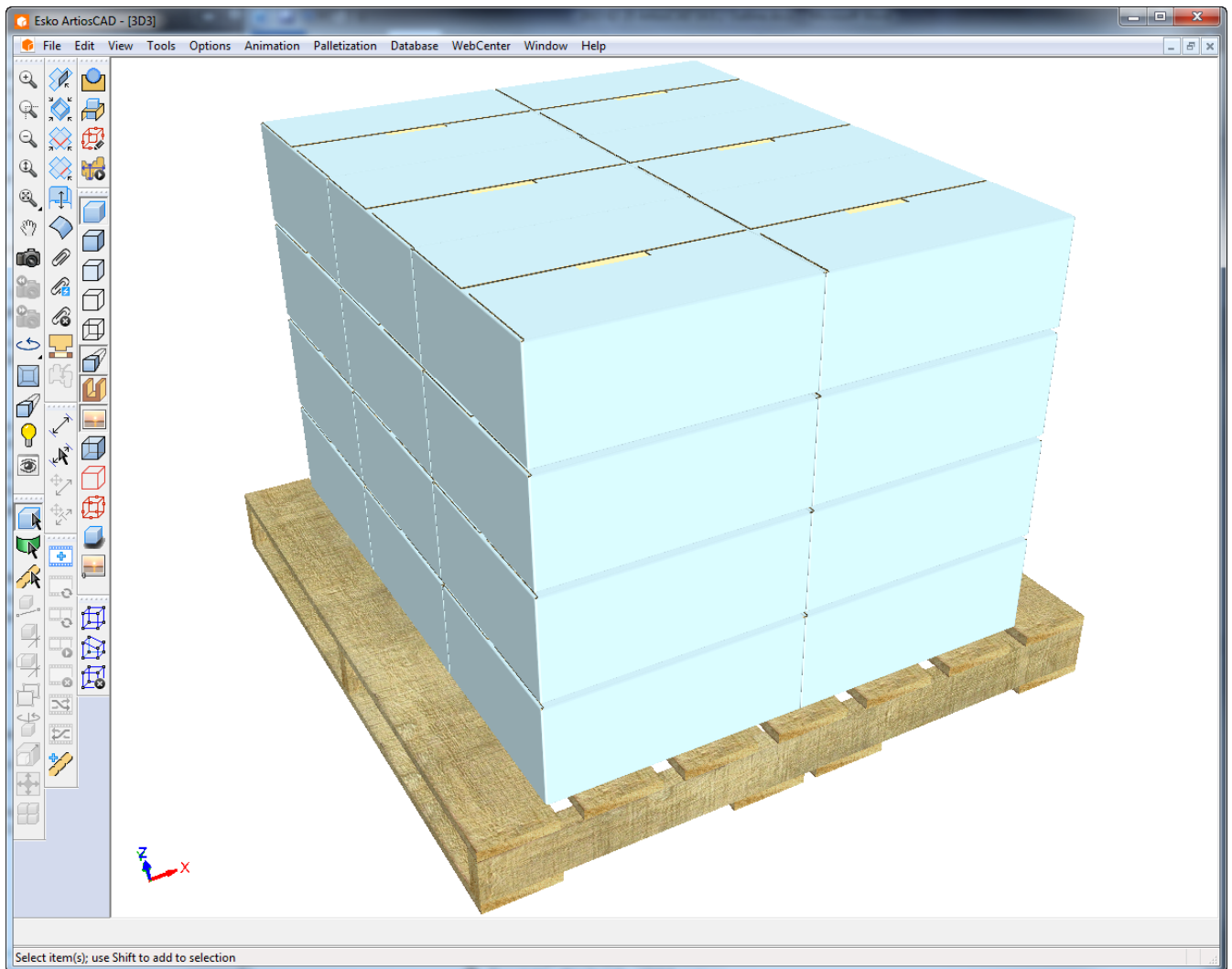

Filling a Case with Cape in 3D

Use Cape Pack's Arrange feature to fill a case with a solid from ArtiosCAD.

Make sure to pick a case that compensates for inside loss when you fold it. To determine if your desired case will work properly, measure the main panels and see if their sizes match the dimensions you used to create the container; the measured sizes need to be larger than the dimensions you entered. You also need to consider the effects of dividers and rollovers that may impact the amount of interior space available for the product. The way the flaps fold might also intrude on interior space.

Shown below is a FEFCO 204 standard at 18x12x12. As you can see, the panels are larger than the entered dimensions.

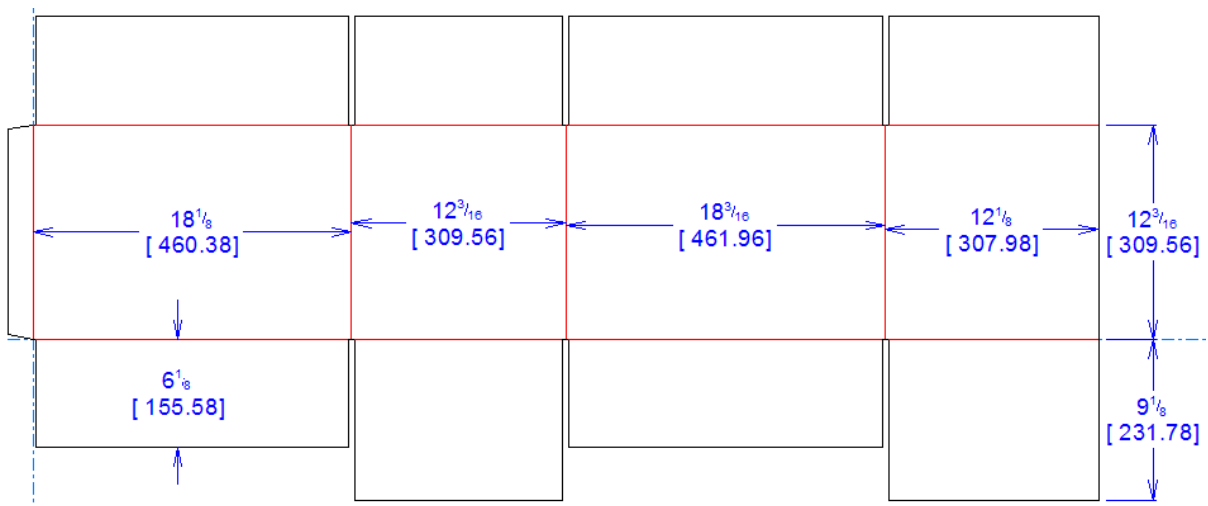

While you are designing, keep the 3D workspace clean with only the original solid or carton so that filling the shipper with the Cape Pack-produced array is accurate. If you add items to the 3D workspace after going through this workflow, your results will not be what you expect as ArtiosCAD will insert the entire contents of the 3D workspace into the case if you re-palletize.

Starting in ArtiosCAD and Choosing the Case in Cape Pack

To start filling a case, do the following:

1. In ArtiosCAD, arrange your solid or carton as desired in 3D.

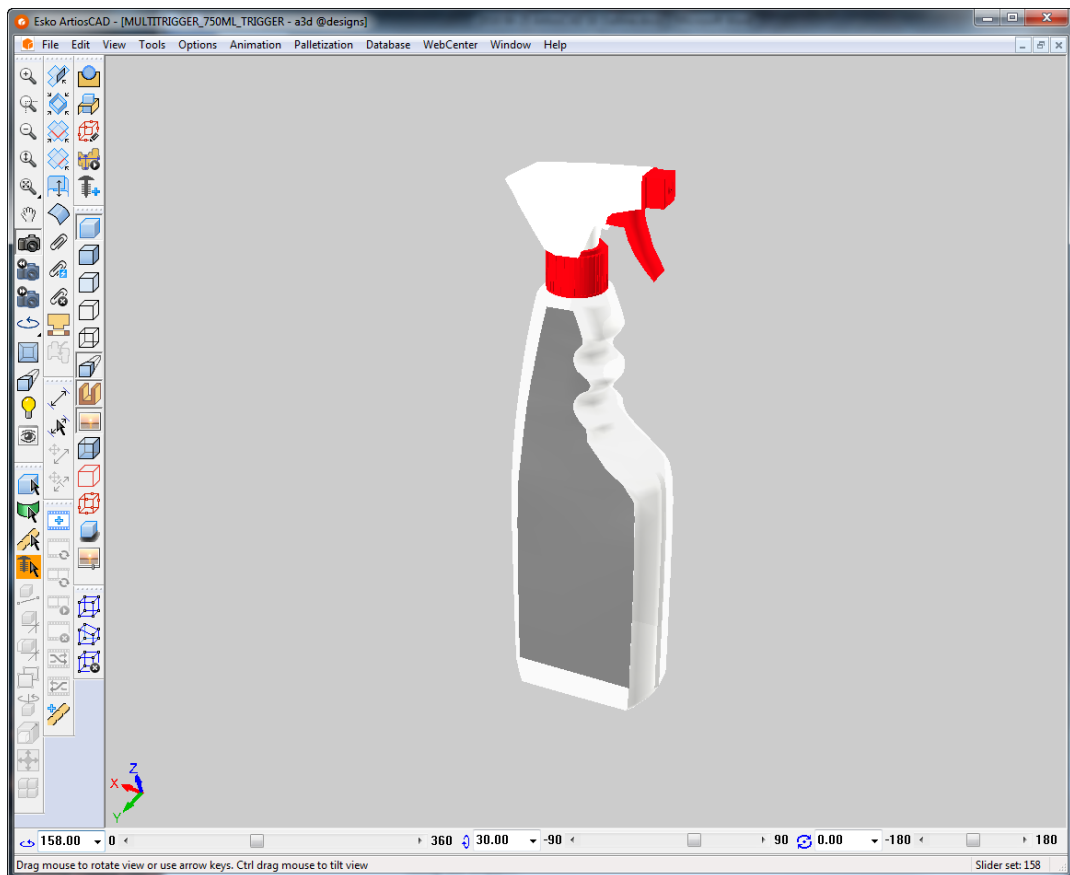

2. Click **Palletization > Create Palletized Design.**
3. In the Select Pallet dialog box, choose the pallet to use.
4. In the CAPE Palletize dialog box:
 - a) Set the CAPE Option to **Arrange/Design Group.**
 - b) Choose an appropriate case from the Secondary Pack Type drop-down list box.
 - c) Set the ArtiosCAD board as desired.
 - d) Enter the weight of the solid.
 - e) Enter the minimum and maximum number of primary packages (the number of solids or cartons to put in the case).
 - f) Enter the slack dimensions and the max size dimensions.
 - g) Click **OK.**

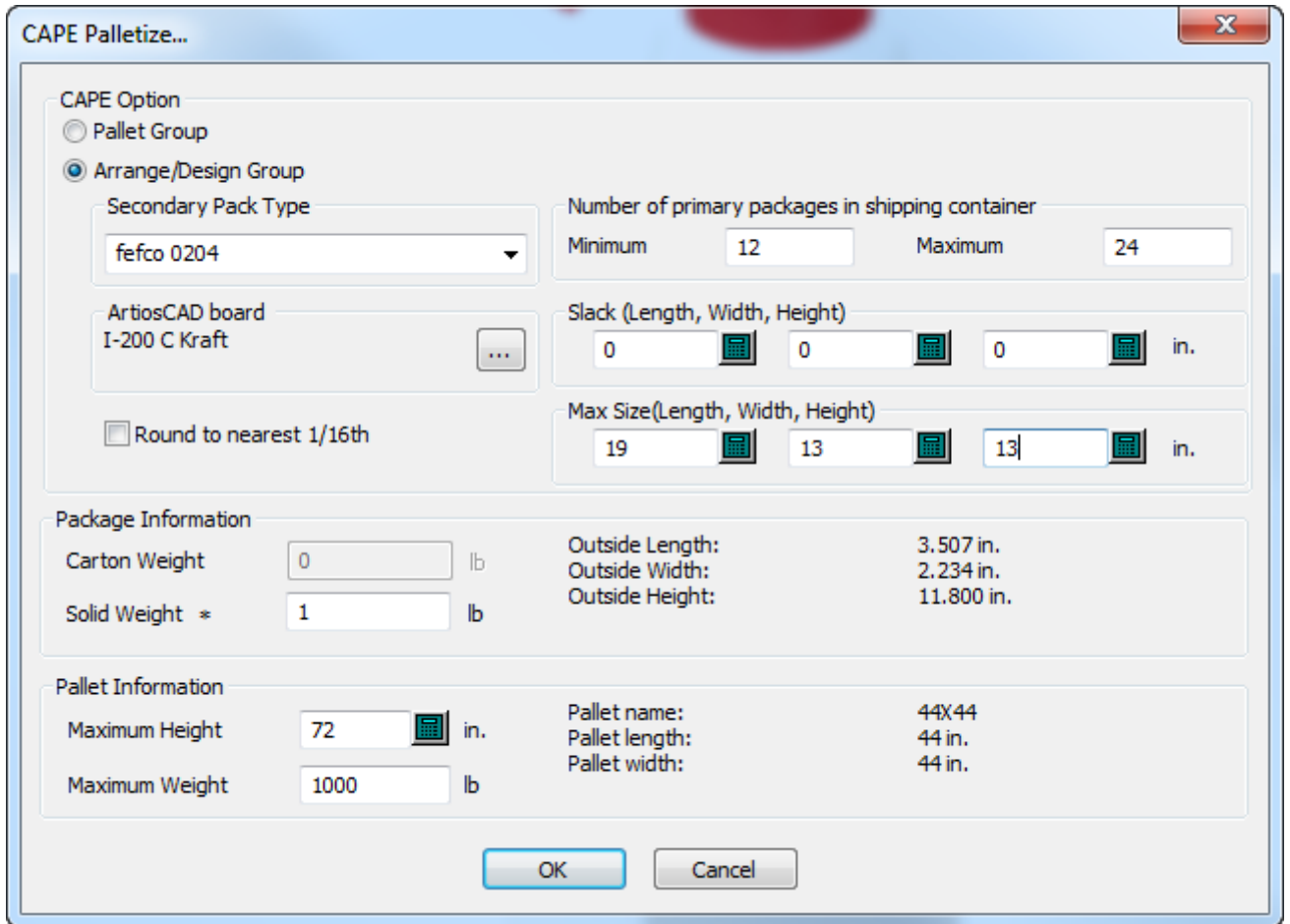

5. In Cape Pack, choose the solution to use. Click **File** > **Export and Exit** to export the information to ArtiosCAD.

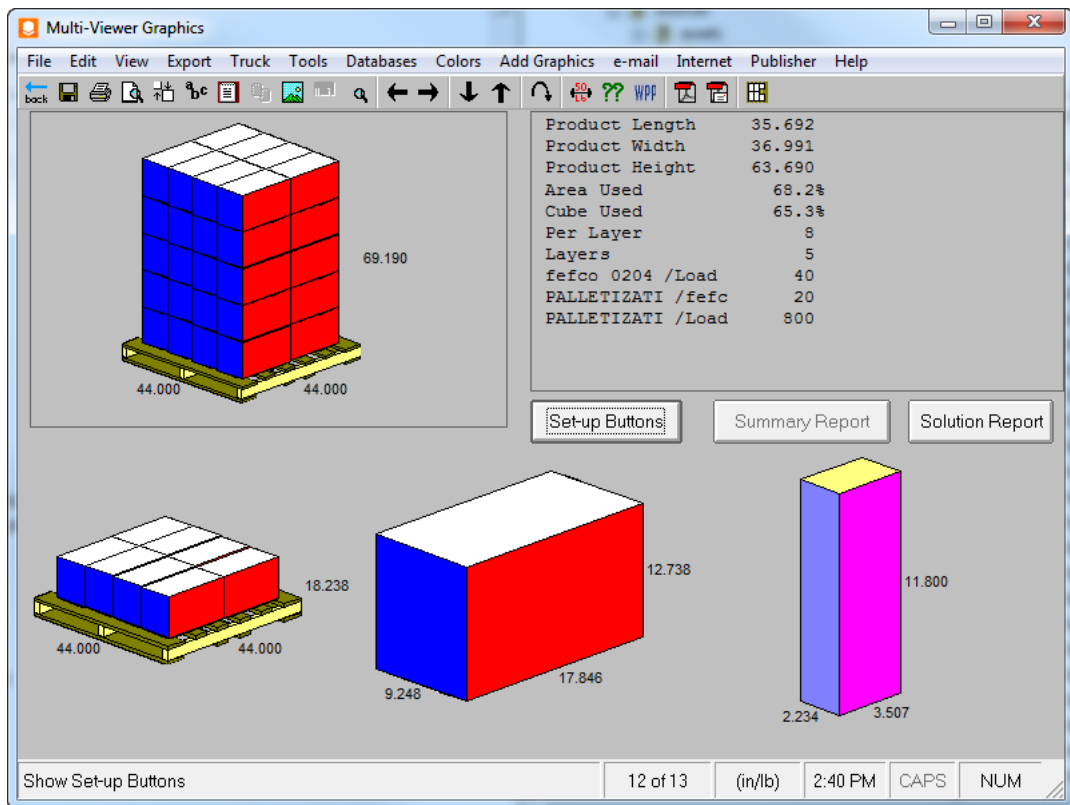

Returning to ArtiosCAD and Folding the Case

Now that you've palletized the case, the next step is to convert the case to 3D and fill it.

1. Back in ArtiosCAD, click **Convert to 3D** on the stage bar.
2. In the Convert to 3D dialog box, pick **New 3D** with **Fill with Primary Design** selected and click **OK**.

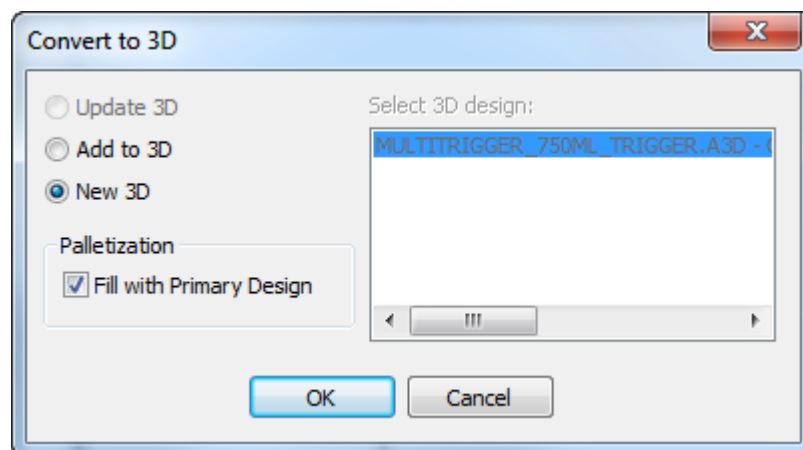

3. In the Add Unfolded Designs dialog box, select the base face and click **OK**. If there are previous fold angles to use, use them.

4. If the design had fold angles saved, the case should appear in 3D folded full of the primary design. If the design did not have fold angles saved, or if you need to change the fold angles before filling it, fold the case as desired and click **Palletization > Fill with Primary Design**.
5. Shown below is the filled case.

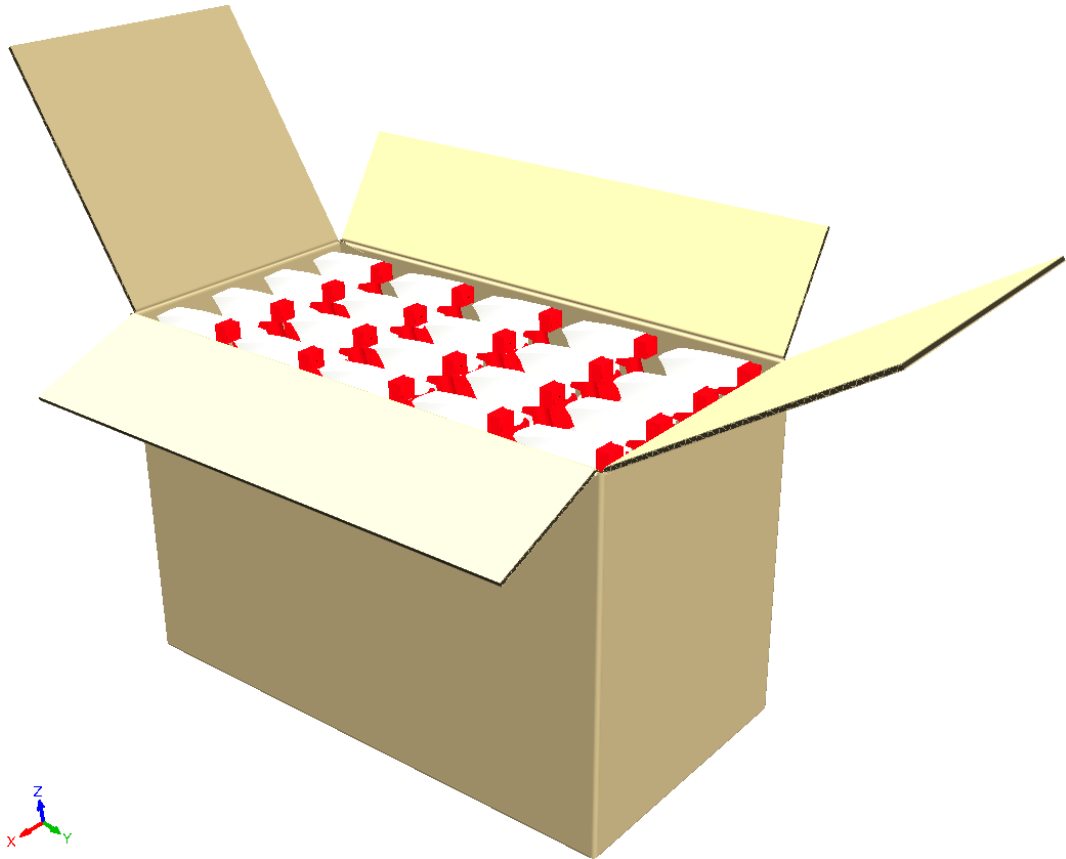

15. Outputs

Introduction to Outputs

Outputs are processes that transform your electronic drawing data into something tangible that you can share with the rest of the world. You can make an output using a report, a simple printout, a sample, or an electronic file. Outputs are configured in the Defaults section of ArtiosCAD. You can customize your own output methods in addition to using those on the server.

Shown below are the default outputs in the default configuration.

Bitmap Output	▶
Blanking	▶
Canvas	▶
Counter Cutting Output	▶
Gerber	▶
Grouped Output Example	▶
Kongsberg C64 - Corrugated	▶
Kongsberg CM1930	▶
Kongsberg CadX Outputs (do not rename anything)	▶
Kongsberg DCM	▶
Kongsberg DS2000 Diesaw	▶
Kongsberg XE10 - FC	▶
Kongsberg XL22 - FC	▶
Kongsberg XL44 - Corrugated	▶
Laser Cutting Output	▶
Mimaki	▶
Palletization	▶
Printer output	▶
Rubber	▶
Rule bender output	▶
Steel Counter	▶
Step and Repeat Outputs	▶
iPC	▶

There are many options in Outputs that are configurable only in Defaults. For more information on configuring outputs, see the *Defaults* chapter.

Concepts and Ideas in Outputs

There are two conceptual types of outputs – those that are printed on a printer or plotter, and those created on a machine that is not a printer or plotter. Windows printer drivers are used for most printer outputs. ArtiosCAD CAM (Computer Aided Manufacturing) drivers are used for most plotter and machine output.

You can also create **Grouped outputs**, which as the name implies is a group of outputs. This way you can (for example) output to a printer, send a design via e-mail, and cut the sample all with a few clicks of the mouse. For more information on configuring Grouped outputs, see the *Defaults* chapter.

Multiple workspace outputs support outputting more than one workspace at a time through the same report or to the same device. See the section at the end of the chapter for more information.

Sending data to output devices

ArtiosCAD communicates with each output device using special software called a driver. ArtiosCAD can use its own drivers, as in the case of sending output to a sample maker, or it can use the drivers that came with the operating system, as in the case of a desktop printer.

For more information on configuring devices, refer to the *Peripherals* and *Defaults* chapters.

Notes and warnings when printing bitmaps

Below are answers to frequently asked questions regarding printing bitmaps from ArtiosCAD.

How do I make a JPEG/PNG/TIFF/Bitmap Output?

Create an Output in Defaults with **Output type Plot** on the Output Type tab, **Driver type Bitmap** on the Device tab, and choose the appropriate format in the **Bitmap Format:** group. Set the output size in pixels in the **Device Size:** fields on the Position tab.

On the Directories tab of the Output, set the extension, such as .JPG for JPEG, .PNG for PNG, .TIF for TIFF, etc.

My bitmap output is very small.

The default bitmap size is 100 by 100 pixels. Increase this to the required size in pixels.

My bitmap output is fuzzy. Why?

JPEG is a lossy compression format (as opposed to lossless) where there is a trade-off between image quality and file size, which blurs the image a little. If your output has dimensions and lines but no graphics, PNG format will work better. PNG compression produces crisp lines and dimensions, but will blend the colors in the graphics.

Poor quality print output. Why?

Make the bitmap size larger, for example 3000 pixels, to have sufficient resolution for printing. Set the width on the Position tab of the Output to match the size of the page in current units.

There is a loss of resolution when I zoom in on the JPEG/PNG. Why?

JPEG and PNG are each bitmap formats. A bitmap is a particular size in pixels and does not scale well. If you want an image that can be scaled, try using EPS format instead if you have a program which supports it (such as Adobe Illustrator). A large bitmap with thick lines scales down better than a small bitmap scales up, but bitmaps in general do not scale well.

Why can't I make a GIF file?

There are licensing limitations on software that makes GIF files. ArtiosCAD uses the PNG (Portable Network Graphics) format instead.

Printing

To print the active workspace, click **File** and then click **Print**.

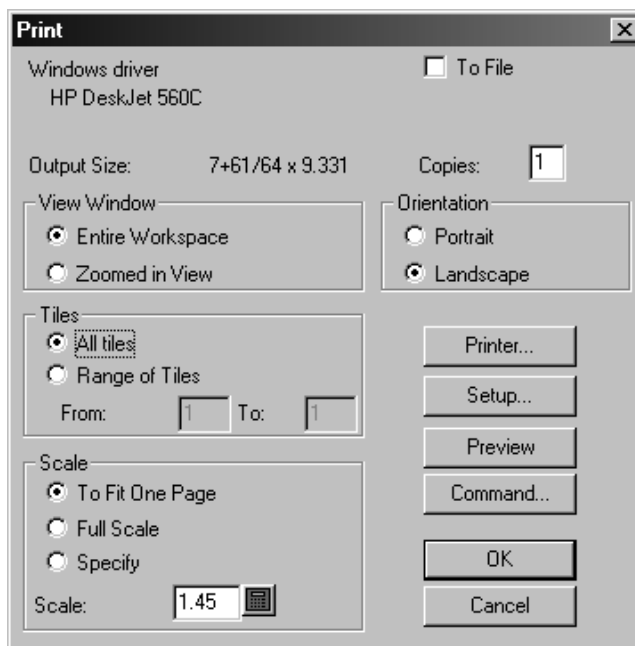

To print the entire workspace on the default printer, click **OK**.

The **To File** checkbox sends the printer data to a file instead of to a printer. Enter the number of copies to print in the **Copies** field. If you are currently zoomed in on a portion of the workspace, the options in the **View Window** group determine what will print – either the **Entire Workspace** or the **Zoomed-in View** you currently have on the screen.

The **Scale** options control the physical size of the printout on the output media.

If the scale of the design (set in the **Scale** field) results in a print larger than the printer can handle, **All tiles** and **Range of Tiles** control what is printed. Tiled outputs have alignment marks on them for easy assembly of the full-size plot. As with other Output options, tiles are configurable in Defaults. The extent to which the alignment marks are printed depends on the margins of your output device.

Portrait and **Landscape** in the **Orientation** group determine how the long axis of the workspace relates to the long axis of the paper.

The **Printer** button lets you choose the driver to use with the printer. Choose between printers or plotters defined in the operating system (Windows printer) and printers or plotters driven using native ArtiosCAD drivers (CAM driver).

Clicking **Setup** leads to the Print Setup dialog box where you can adjust settings such as the stretch factor and position of the output on the page.

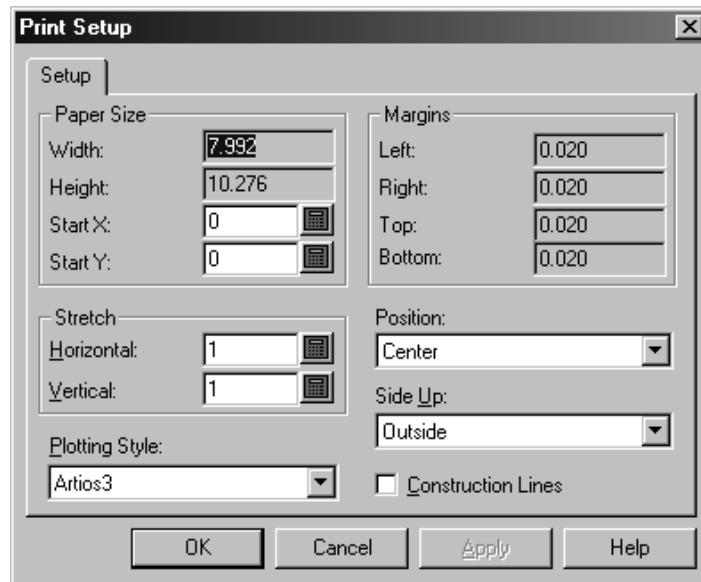

Preview shows you the data you are sending to the printer or plotter as it will look once printed or plotted. You can set the preview to show automatically in the Preview Control group in the Output's properties in Defaults. Step through the individual line order output by using the **Slow Plot** slider at the bottom of the preview window. An arrow shows the current line. If you zoom in, only the current lines shown are stepped through. **Command** lets you view and modify the actual ArtiosCAD command used to make the output. Do not modify the command unless you are sure of what you are doing, or are told to modify it by Esko Support personnel.

Shown below is the Output Preview dialog box for a Report. Click **OK** to make the output, or **Cancel** to return to the Output dialog box.

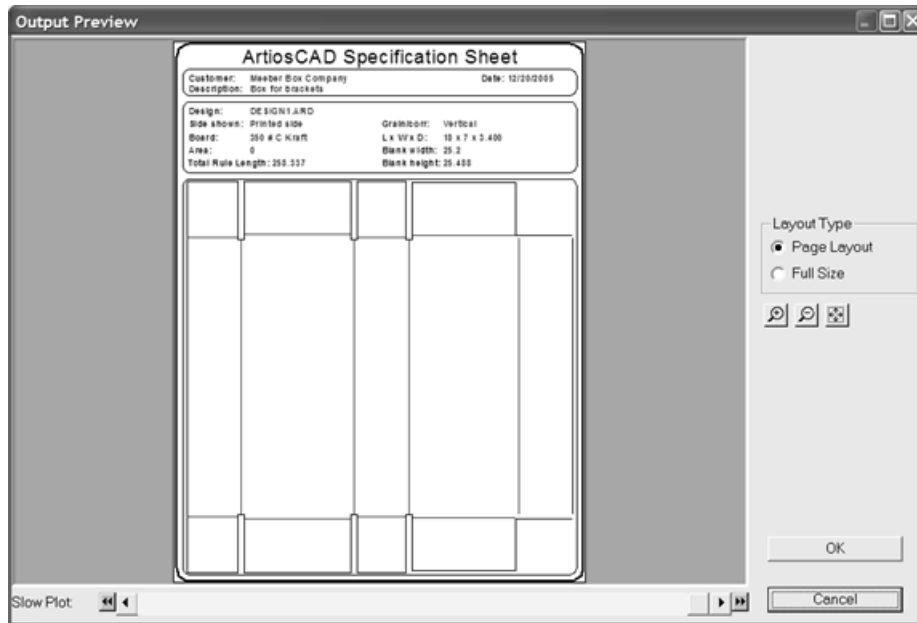

Creating a PDF file

The ability to create PDF files using the native ArtiosCAD driver is an option which much be purchased and may or may not be loaded on your system. Use of third-party software or drivers may lead to unpredictable results.

To create a PDF file, do the following:

1. Create the workspace as usual and turn on the layers to be included in the Output.
2. Click **File > Outputs > Printer output > Plot to PDF**. If you have added any Outputs to the root level, there will be an **Artios** folder to select after you click Outputs. The Plot to PDF dialog box appears similar to the one shown below.

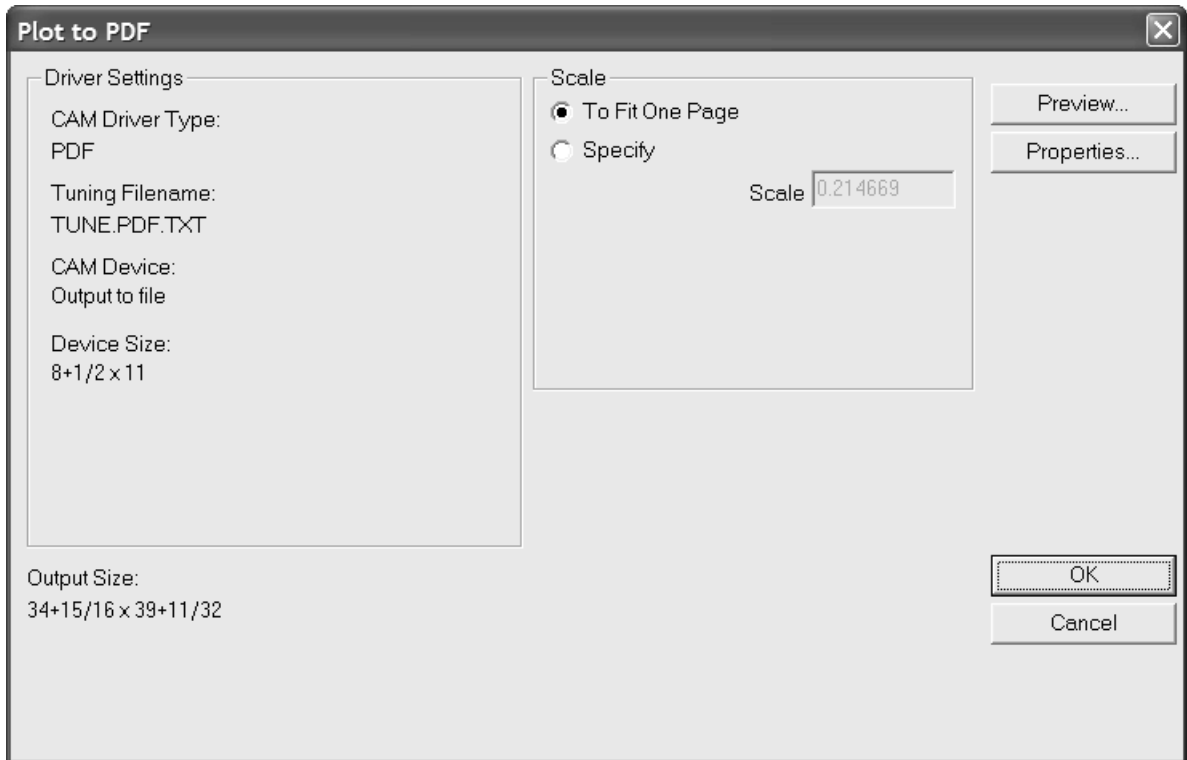

3. Click **Properties** to change the size, position, security, and other aspects of the Output.

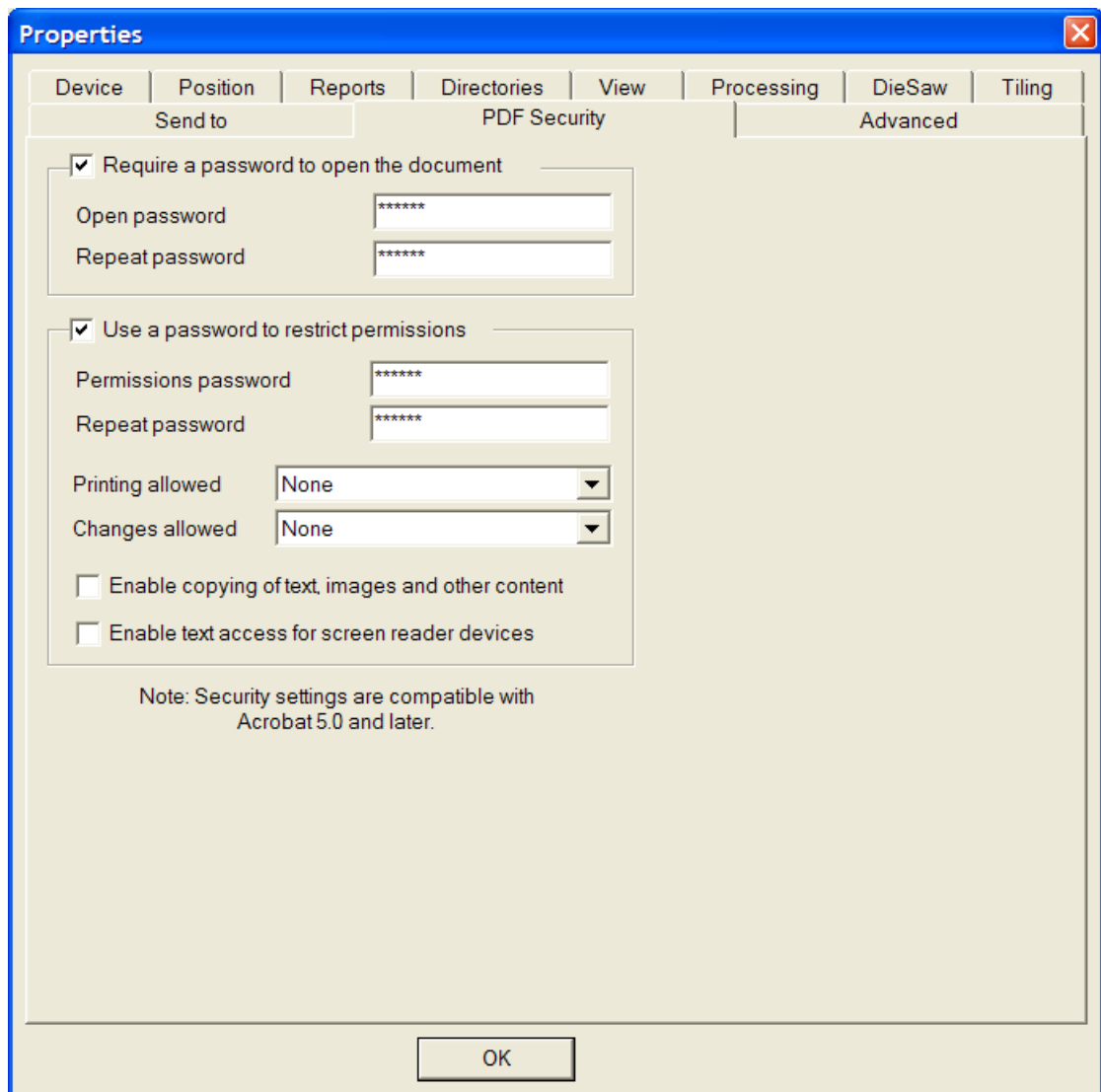

Click **OK** once you have set the options as desired to return to the Plot to PDF dialog box.

4. Click **OK** in the Plot to PDF dialog box.
5. In the Save As dialog box, navigate to the directory in which to save the Output and enter a filename for the Output in the **File name:** field.
6. Click **Save** to make the Output.

Depending on the state of the **Automatically Open** checkbox on the Directories tab of the Output definition, if you have a PDF-viewing utility installed, the PDF file may automatically open once it is created.

Setting PDF security options

The PDF security options available in an ArtiosCAD Output correspond to those used in Adobe Acrobat. They may be set in Defaults just like any other properties.

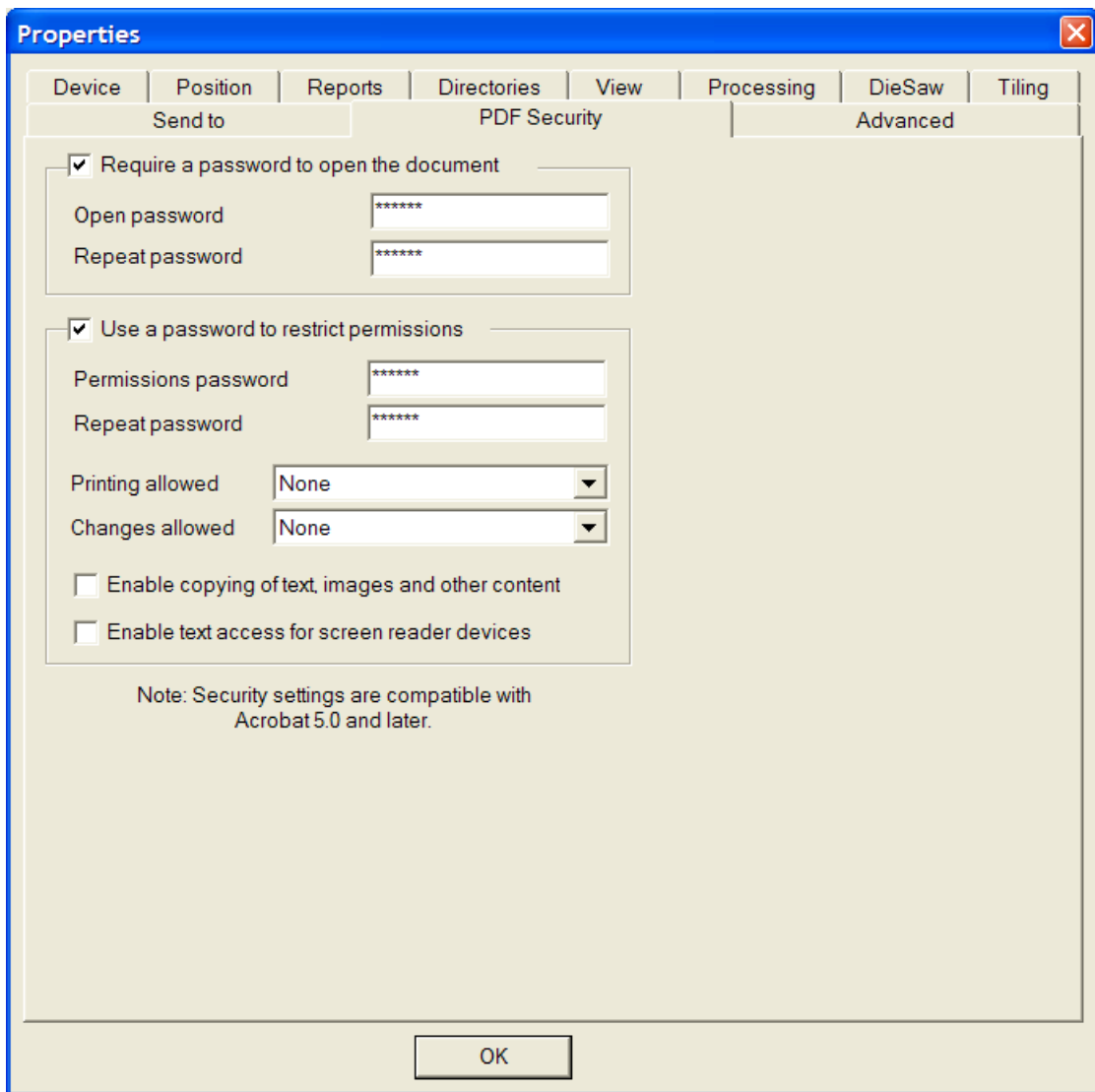

Checking **Require a password to open the document** requires the recipient of the file to enter a password when opening the PDF file using Adobe Acrobat Viewer. Enter this password in the **Open password** and **Repeat password** fields; they must match exactly. There is no way to recover this password if it is lost or forgotten.

Checking **Use a password to restrict permissions** requires the recipient of the file to enter a password to change how the file is protected. Enter this password in the **Open password** and **Repeat password** fields; they must match exactly. There is no way to recover this password if it is lost or forgotten.

If both password options are used, the two sets of passwords must be different.

In the **Printing allowed** drop-down list box, there are three settings: **None**, **Low Resolution**, and **High Resolution**. **None** means the recipient may not print the document. **Low Resolution** allows printing as a bitmap up to 150 dpi. **High Resolution** allows printing the document at any resolution, and to use high-quality vector output and other advanced printing features if the printer supports them.

In the **Changes allowed** drop-down list box, there are three choices: **None**, **Page content changes only**, and **All changes allowed**. **None** allows no changes in Adobe Acrobat. **Page**

content changes only restricts changes to what is shown on the page, but prevents other changes such as page rotation. **All changes allowed** allows any change.

The recipient of a PDF file created by ArtiosCAD with security options set must use Adobe Acrobat 5.0 or later to open the file.

Note: ArtiosCAD cannot open PDF files with an Open password, nor can it open PDF files that have restricted permissions and that do not have content copying enabled.

The **Plot to PDF/U3D** Output is meant to be used only in the optional 3D module, as it requires 3D data.

Samplemaking

To print or cut a sample, click **File**, then **Outputs**, and then navigate through the menu items until you find your samplemaker. To make navigation easier, you should move your machinery outputs higher up in the hierarchy in Defaults.

Clicking **Artios CM1930 – Cor. sample cutting and graphics** leads to the dialog box shown below.

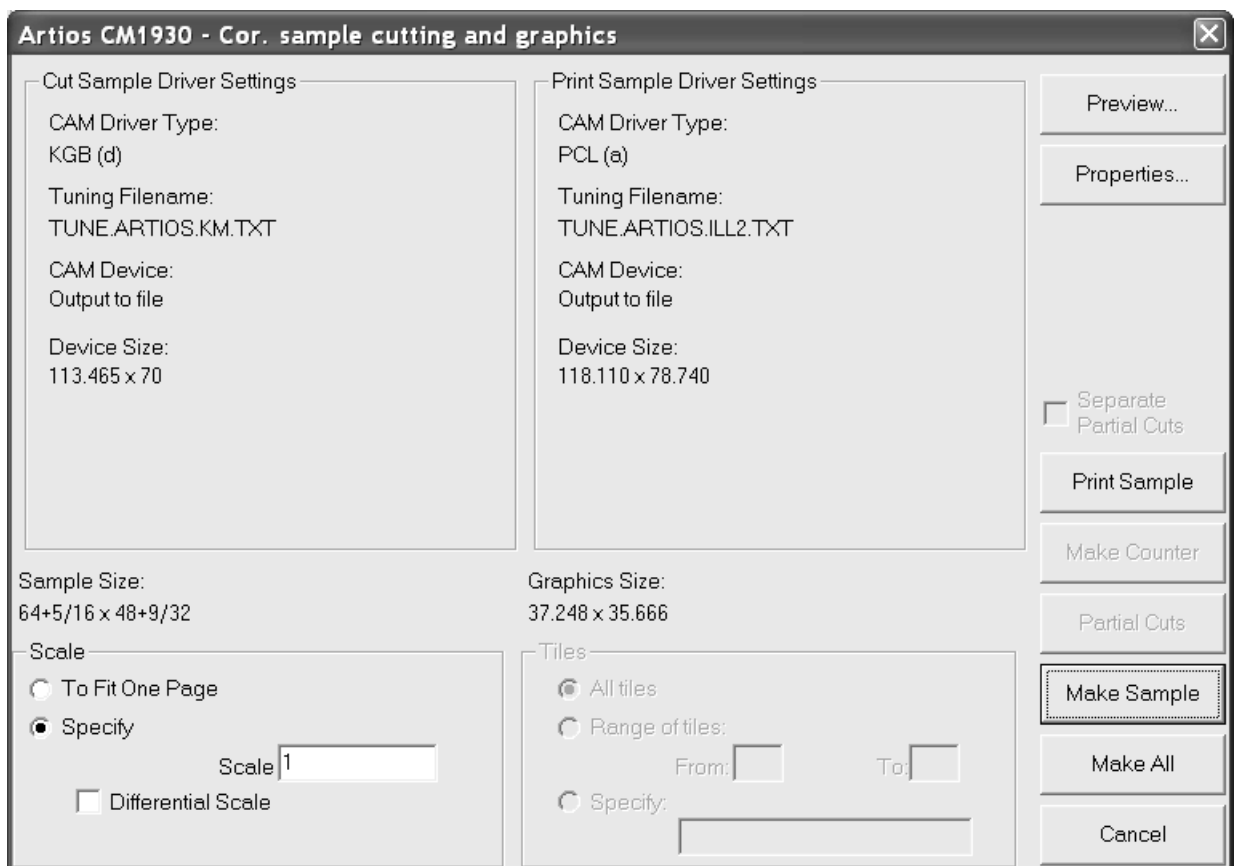

Preview lets you see what will be output before it is actually output.

Properties leads to the Properties dialog box where all samplemaking and sampleprinting options can be set.

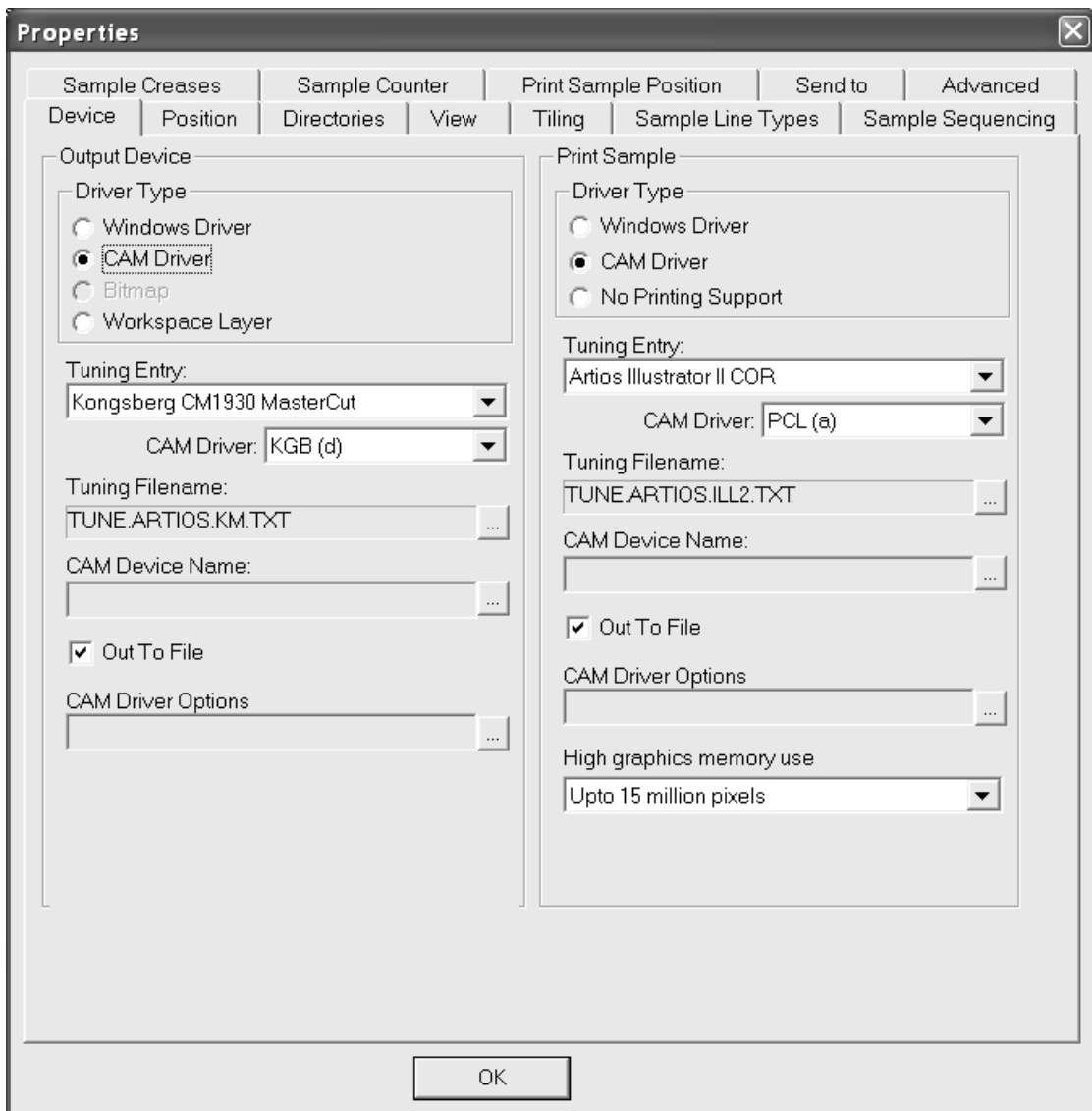

You can customize the behavior of your samplemaker by changing its information in Defaults. All the same options in the Properties dialog box are configurable in Defaults.

Print Sample (back in the samplmaking dialog box) sends the graphic portions of the workspace to the print head on the samplemaker. Note: Text which is in a graphics layer will be printed in black if not given a color. Also, sample printing of Inside layers is not supported.

Make Counter sends the counter information in the Counter layer to a file which can then be interpreted by a samplecutter. The line types in the Counter layer must be set to countercutter line types. Note that this is not used to make a phenolic resin counter - it is used to make a pseudo-counter out of carton stock on a samplecutter. A counter made out of carton stock is also called a **matrix**.

Make Sample cuts the sample.

Make All makes everything that is supported by the selected output device.

Note that some output drivers straighten nearly-straight arcs. Use the GNC driver to preserve nearly-straight arcs. The GNC driver can also facet small arcs to raise and lower the knife for smoother cuts. Contact Support for more information about the GNC driver.

Note for DieSaw users

When outputting to a DieSaw, the DieSaw layer is the only layer which is output. Make sure you are not trying to output a different layer when performing a DieSaw output.

Making an Output to i-cut Production Console

To send a single design or manufacturing file to the i-cut Production Console for cutting on a Kongsberg samplemaker, do the following:

Note: If you run this Output while in a canvas, ArtiosCAD outputs the current part, not the entire canvas.

1. Open the workspace in ArtiosCAD.
2. Click **File > Outputs > <name of your iPC Output> > <name of your iPC - Submit Job Output>**.
3. In the Specify Material and Cutting Profile dialog box, choose the material and cutting profile for the job. In the Materials list, ArtiosCAD displays the current workspace's board code as well as the materials contained in the iPC Resource Database. Choose the desired material, change the Cutting Profile if necessary, and set the number of Ordered Copies. The Tooling Preset, Optimization Preset, and Production Preset are shown for information only.
 - a) If you choose the board code, the other fields except for Ordered Copies are unavailable.

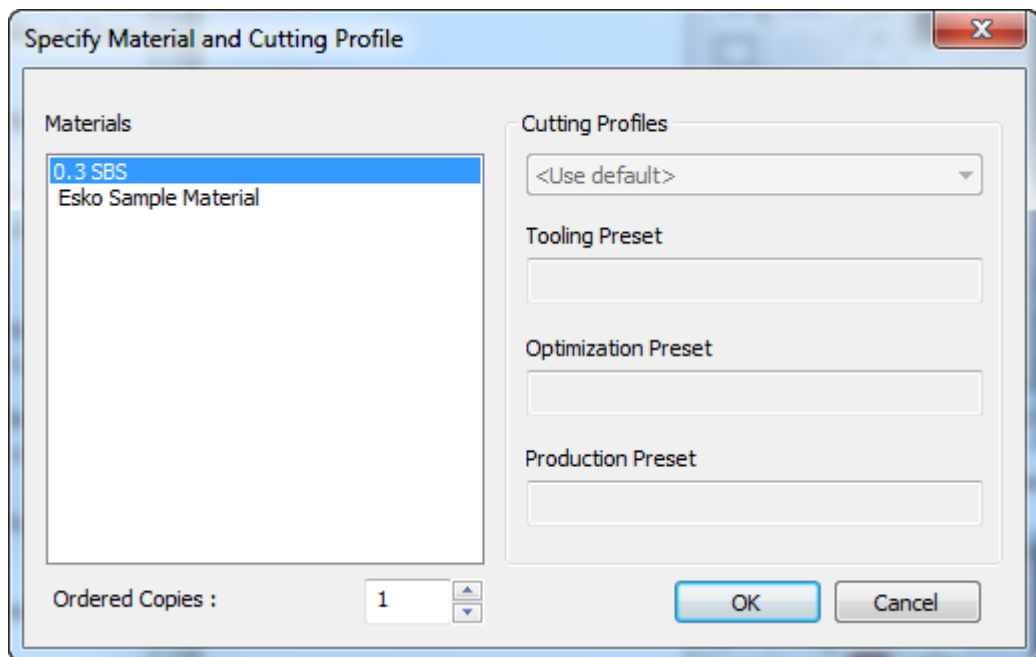

- b) If you choose something from the iPC Resource Database, you can then change the Cutting Profile.

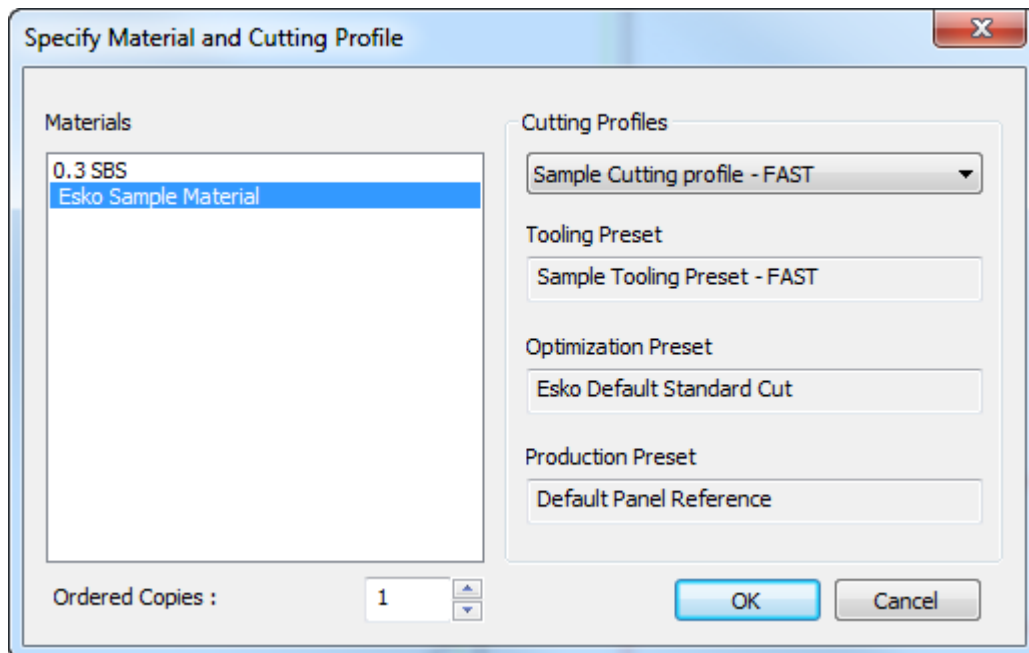

Click **OK** when you have chosen a material, set the number of ordered copies, and optionally a cutting profile.

4. After a few moments, the job appears in the i-cut Production Console ready for the Kongsberg table operator to process.

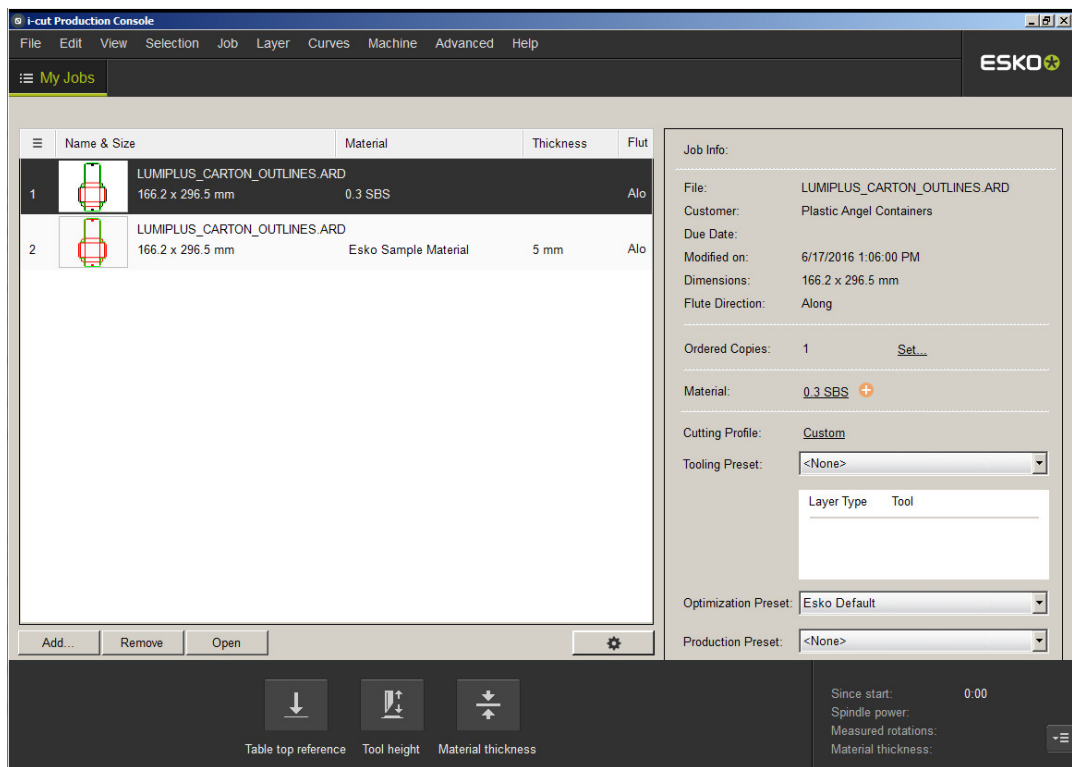

Reports

What is a report?

A report is a way to print pictures of workspaces along with information about those workspaces. For example, you could have the name of the design, its dimensions, the customer name, and the job order number on the same printout as a flat view of the design, the design folded in 3D, and the design laid out on the die board.

You must have the ReportMaker feature to modify design windows or work with variables. However, you can change fixed text on pre-made forms if you do not have ReportMaker.

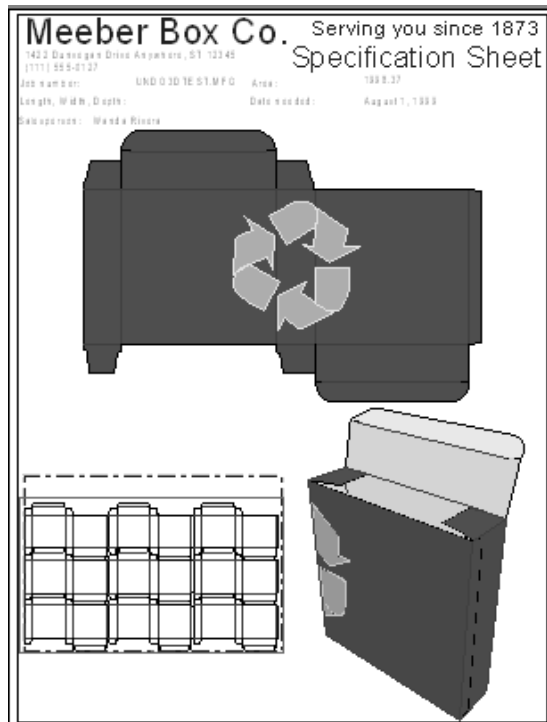

Making a custom report

Although ArtiosCAD comes with several pre-made reports, you will probably want to make some that serve your unique needs. For example, you may want to put your company's logo on one, along with certain items of text that aren't on the pre-made forms.

Making a report usually involves doing the following steps:

- Deciding what types of designs and information you want on your report;
- Defining the size of the report;
- Drawing lines to separate areas from each other;
- Adding text and graphics to the report;
- Designating the part of the report that the design images will go into;
- Adding the report to a Report Catalog;
- Defining an Output that uses the report.

Tools specific to the creation of reports are on the ReportMaker toolbar. The first button on the toolbar is in the Toolbar Master Control and toggles the display of the toolbar.

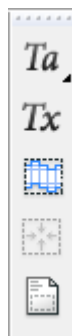

Deciding the contents of the report

Different circumstances call for different information on reports. For example, information going to your sales force probably requires different information than that going to the printing plate machine operators. Customers would probably like to see a folded version of their design along with its pertinent details. Know your audience -- too much information can be just as bad as too little information. You probably already have some sort of shop ticket, job information sheet, or order tracker that can be turned into a report.

You should also decide which file views you want to be on the report. Would a 3D representation help? A manufacturing file view would be for a diemaker. A view of both sides of the workspace could be useful as well. The possibilities are infinite.

Defining the size of the report

Once you have decided what will be on the report, start ArtiosCAD and make a blank design. Turn on the ReportMaker toolbar if it is not on already. The size of a report is usually based on the printer used to print it.



Click the **Report Size** button on the ReportMaker toolbar.



Choose the printer from the **Device** list box. The size of the report will automatically be displayed in the **Report width:** and **Report height:** fields. If you want to rotate the rectangle

used to form the edge of the report, check the **Rotate** report checkbox. Click **OK** to accept the settings. A rectangle will appear in the design that is the edge of the report.

Drawing lines to separate areas

If you want to have lines defining the different areas on your form (for example, you may wish to separate text from graphics), use the **Line** tool to draw them. Lines are optional, as the only thing required on a report is a File Window.

Creating a File Window

File Windows contain symbols, pictures of flat designs, manufacturing files, print items, 3D files, Bill of Materials table rows, or Cape palletization solution views. You can have many File Windows on the same report, each having different contents.



To create a File Window, click the **File Window** tool on the ReportMaker toolbar. Use the drag to set the diagonal starting and ending points of the rectangle. Alternately, enter values in the **X** and **Y** offset fields on the Status bar to set the corners of the rectangle. After creating a rectangle, the tool is still active in order to facilitate making another. Shown below is a report with three File Windows.

<p>Meeber Box Co. Serving you since 1873</p> <p>1422 Dunvegan Drive Anywhere, ST 123 45 (111) 555-0127</p>		<p>Specification Sheet</p>	
Job number:	Workspace name	Area:	AREAH.00
Length, Width, Depth:	Length, width, depth	Date needed:	Date required
Salesperson: Salesperson			
<p>Design 3</p>			
<p>Manufacturing 1</p>		<p>3D 2</p>	

Double-click a File Window with the **Select** tool to change its properties.

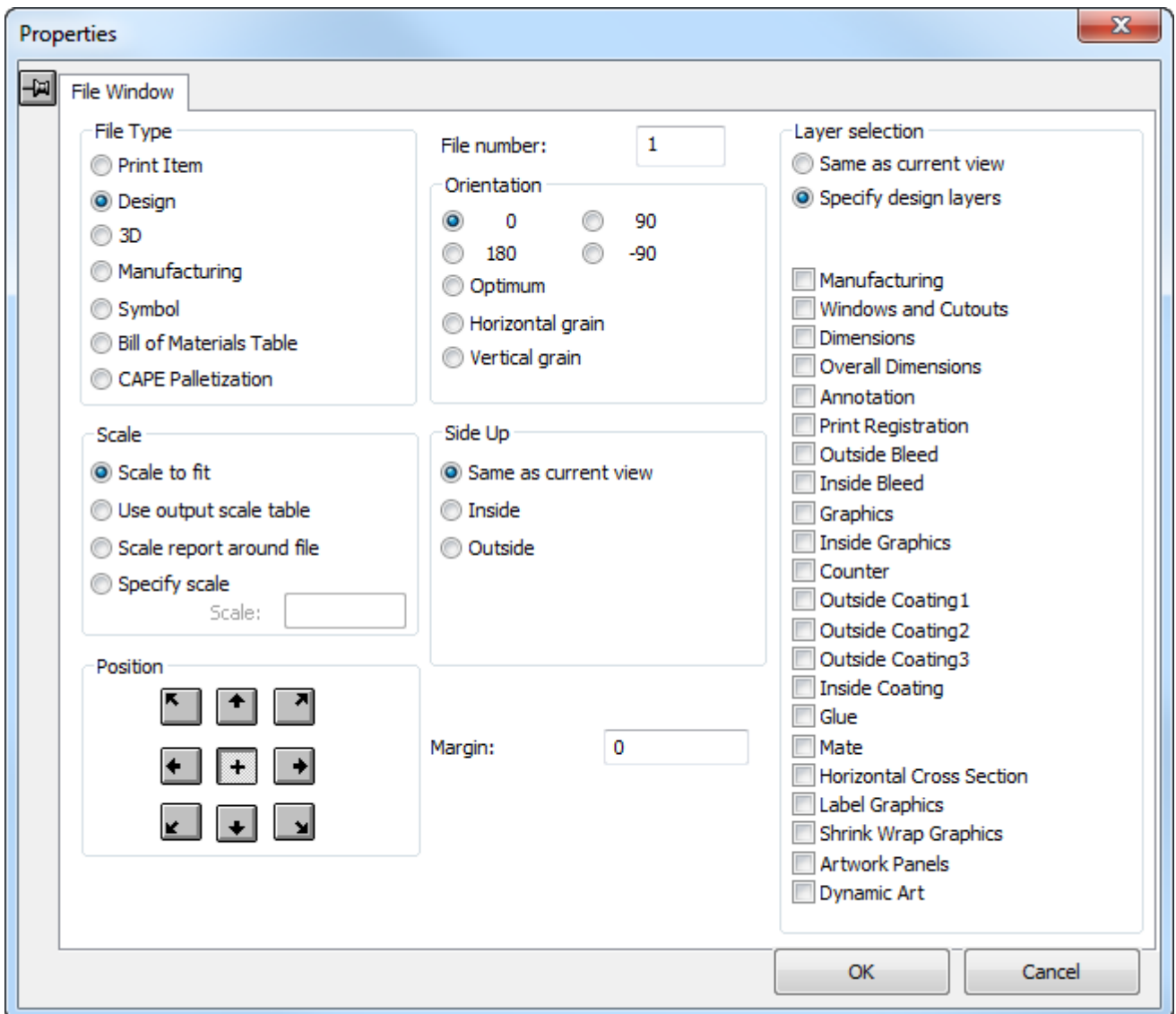

Choose the option button in the **File Type** group that corresponds with the type of file which will be shown in the File Window.

The option buttons in the **Scale** group determine the size of the file view within the File Window. **Scale to fit** makes the contents of the window as large as possible while still fitting within the File Window.

Use output scale table instructs ArtiosCAD to set the scale of a File Window according to a predefined table in Defaults. ArtiosCAD will set the scale in that File Window to the closest scale that is less than or equal to the scale derived from the Scale to Fit command. For example, if Scale to Fit would use a scale of 0.8753, but **Use output scale table** is selected, ArtiosCAD will use the scale in the table that is closest to that value without exceeding it, for example 3/4.

Scale report around file expands the report to fit around the file window if the file window contents are initially larger than the report, but does not shrink the report if the file window contents are initially smaller than the report. This option is valid only for Design and Manufacturing type File Windows. If more than one File Window in a report uses this method,

the report scale is calculated to the size needed to encompass all the occupied windows. It is meant for use with an Output set to scale 1. If you use a report with a File Window set to this scale option in an earlier version of ArtiosCAD, the File Window will behave as if it were set to **Scale to Fit**. If you open the report workspace in an earlier version of ArtiosCAD, the **Scale** group option is set to **Specify Scale** of -2.

The option buttons in the **Scale** group are not available when the File Window type is 3D, Symbol, Bill of Materials Table, or Cape Palletization.

The buttons in the **Position** group control how the file view is positioned within the File Window. The buttons around the edge of the square align the design with the corresponding point of the File Window. The center button (+) aligns the center of the design with the center of the File Window.

The **File number** indicates which file will be displayed in the File Window. The **File Number** prompt changes to **Print Item Number** prompt if **Print Item** is selected in the File Type group. When you create a report containing more than one File Window, increment the File number by 1 for each File Window. When outputting the Report, the current design is file number 1; any other open designs are assigned numbers 2 onward. When using a Manufacturing report, make sure the manufacturing file is the active workspace - so that it is in File Window 1.

Note: Make sure each File Window has a unique number, except if you have multiple Design File Windows of the same number that are meant to show different layers of the same design, as long as those layers are not Manufacturing or Windows and Cutouts, as those might cause problems with calculated expressions. For example, multiple Design File Windows with the same number would be permissible when one is showing the Outside Graphics layer, another is showing the Dimensions layer and the flat view, and yet another is showing the Inside Graphics layer. Do not assign File Windows of differing types the same number - for example, do not have Design 1, 3D 1, and Manufacturing 1. The report may not work correctly if you have same-numbered File Windows for different types of workspaces. If you are planning a report with a manufacturing file and single designs, make the manufacturing file as File Window 1 and make the other File Window types 2, 3, 4, and so forth.

The option buttons in the **Orientation** group determine the rotation of the design in the File Window. **0**, **90**, **180**, and **-90** all rotate the contents by a fixed amount. **Optimum** sets the orientation so that the largest scale is obtained. **Horizontal grain** and **vertical grain** set the design so that the grain direction chosen is drawn along the longer axis of the File Window.

The **Margin** specified indicates the distance from the edge of the File Window to the outermost edge of design.

Options buttons in the **Side Up** group control which side of the design is shown.

The option buttons in the **Layer Selection** group control which layers are shown. **Same as current view** shows the design on the report the same way it is being viewed in ArtiosCAD. **Specify layers** lets you choose which layers to show on the report regardless of the view at the time of output. If the **File Type** is set to Manufacturing, another option button appears which allows you to specify those Manufacturing or Design layers to output.

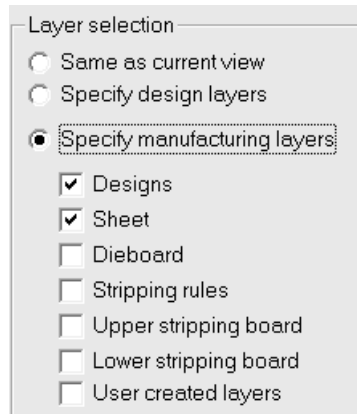

The layers selected when **Specify design layers** and **Specify manufacturing layers** are active are remembered when the other option button is selected. For example, if you select **Inside Bleed** and **Graphics** when **Specify design layers** is active, they will be remembered when **Specify manufacturing layers** is active. If you do not select any design layers for a Manufacturing file window, only the Main Design layer is shown when **Designs** is selected in the Manufacturing layers.

Using a Symbol file window

The **Symbol** type of file window is used to hold a symbol, which is a graphic. This graphic can be lines and arcs drawn and filled in ArtiosCAD, or it can be a graphic file of the following format and extension: BMP, DIB, JPG, PNG, TIFF, and PDF (only if you have purchased the PDF option).

You can:

- specify the exact symbol to use;
- specify a library function which will determine the name of the symbol;
- build a conditional statement that instructs ArtiosCAD to use a different symbol when the specified conditions are met.

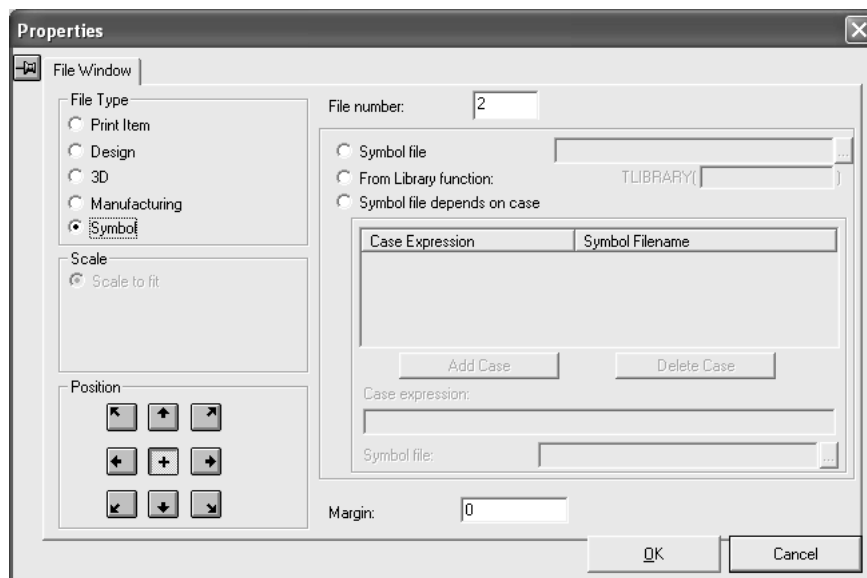

When the File Window is set to type **Symbol**, the Scale is automatically set to **Scale to fit** and the Position is automatically set to centered horizontally and vertically. As with other types of File Windows, the value in the File Number field controls which element of the current workspace corresponds to the symbol window.

To use the same symbol file each time the report is accessed, click the **Symbol File** option button and enter the filename of the ArtiosCAD workspace containing the symbol.



The **From library** function option button lets you use a library function to return the symbol filename to ArtiosCAD.

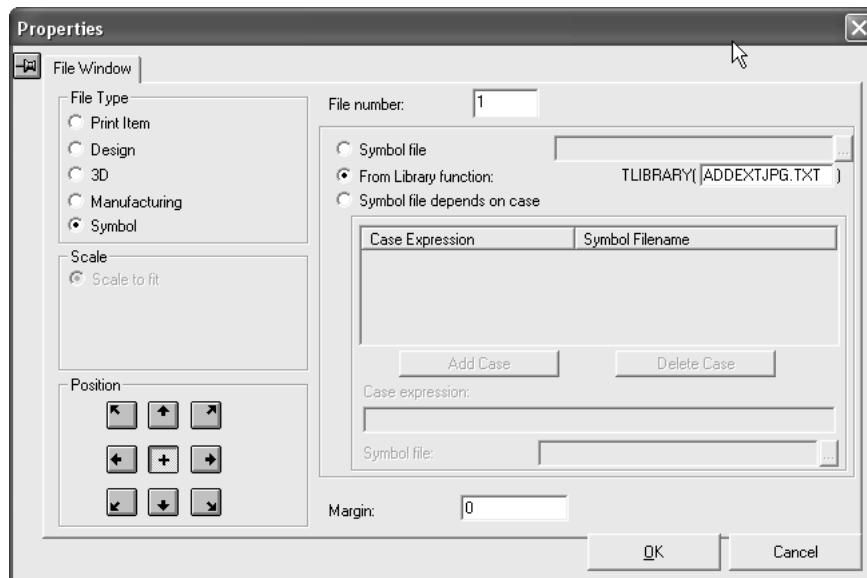

Perhaps you have corresponding JPG files for each design you make that have the same name as the design file. Including them automatically on a report can be done using a library function as described below.

A library function such as ADDEXTJPG.TXT is a short program allowing the filename for the contents of a Symbol-type file window to be defined automatically as the Report is run.

Note: This library function is not part of the ArtiosCAD installation; to use it, you must create it in a text editor such as Notepad and save it in ServerLib.

The library function will typically use the function #PATHNOEXT\$ to get the pathname of the current design without the .ARD extension. The last line of the command file returns the pathname to be used. The following example would return pathname.JPG for a design pathname.ARD.

```
DEFINE &FNAME$

SET &FNAME$ #PATHNOEXT$,".JPG"
```

When the Report runs in an Output, the library function for the pathname is evaluated for each file window, and the image from that pathname is scaled to fit in the rectangle defined by the

file window item. The pathname may refer to an ArtiosCAD design, such as **GRAIN.ARD**, or an external image such as **1234.JPG**.

The report may contain several file windows, each referring to a different image, such as a picture of the product, and a palette diagram. For each image file that does not exist, a text message is centered in the file window with the pathname of the missing file. This diagnostic is useful for instances such as a missing grain symbol. To avoid this message for designs that do not have a corresponding image file, the library function that sets the filename can be set to ignore any missing files as shown below:

```

DEFINE &FNAME$
SET &FNAME$ #PATHNOEXT$, ".JPG"
IF FILEEXISTS (&FNAME$)
SET &FNAME$ &FNAME$
ELSE
SET &FNAME$ ""
ENDIF
    
```

Again, to use the library function, you have to enter it in a text editor and save it in ServerLib before you specify it in the Properties dialog box for a symbol-type file window on a Report.

To configure the report to use a different symbol depending on the result of an evaluated expression, select the **Symbol file depends on case** option button. When you select this option button, the **Case** group becomes available.

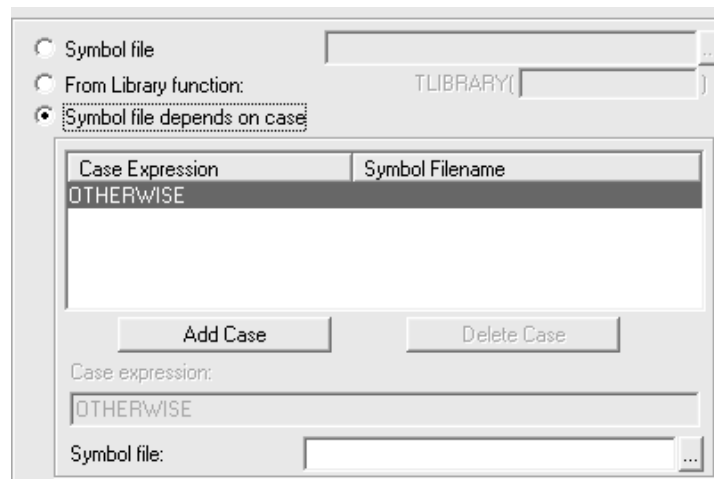

To add a case, do the following:

1. Select the **Symbol file depends on case** option button.
2. Click **Add Case**.
3. Enter the expression to be evaluated in the **Case expression** field. Use the same syntax here as that used in any Edit Expression dialog box.
4. Enter the full name and path of the desired symbol file in the **Symbol file** field. Click the button at the end of the field to browse for the file.
5. Add more case expressions by clicking **Add Case**. Delete a case expression by selecting the one to delete and then clicking **Delete Case**.

There will always be an OTHERWISE case listed when **Symbol file depends on case** is selected. The expression entered in this field is the one ArtiosCAD will use when none of the other case expressions are valid. This field can be left blank if you know that the condition will always be met.

Using a Cape Palletization file window

When you choose **Cape Palletization** as the file window type, the Properties dialog box changes to let you choose what ArtiosCAD extracts from the 3D workspace that you have already palletized.

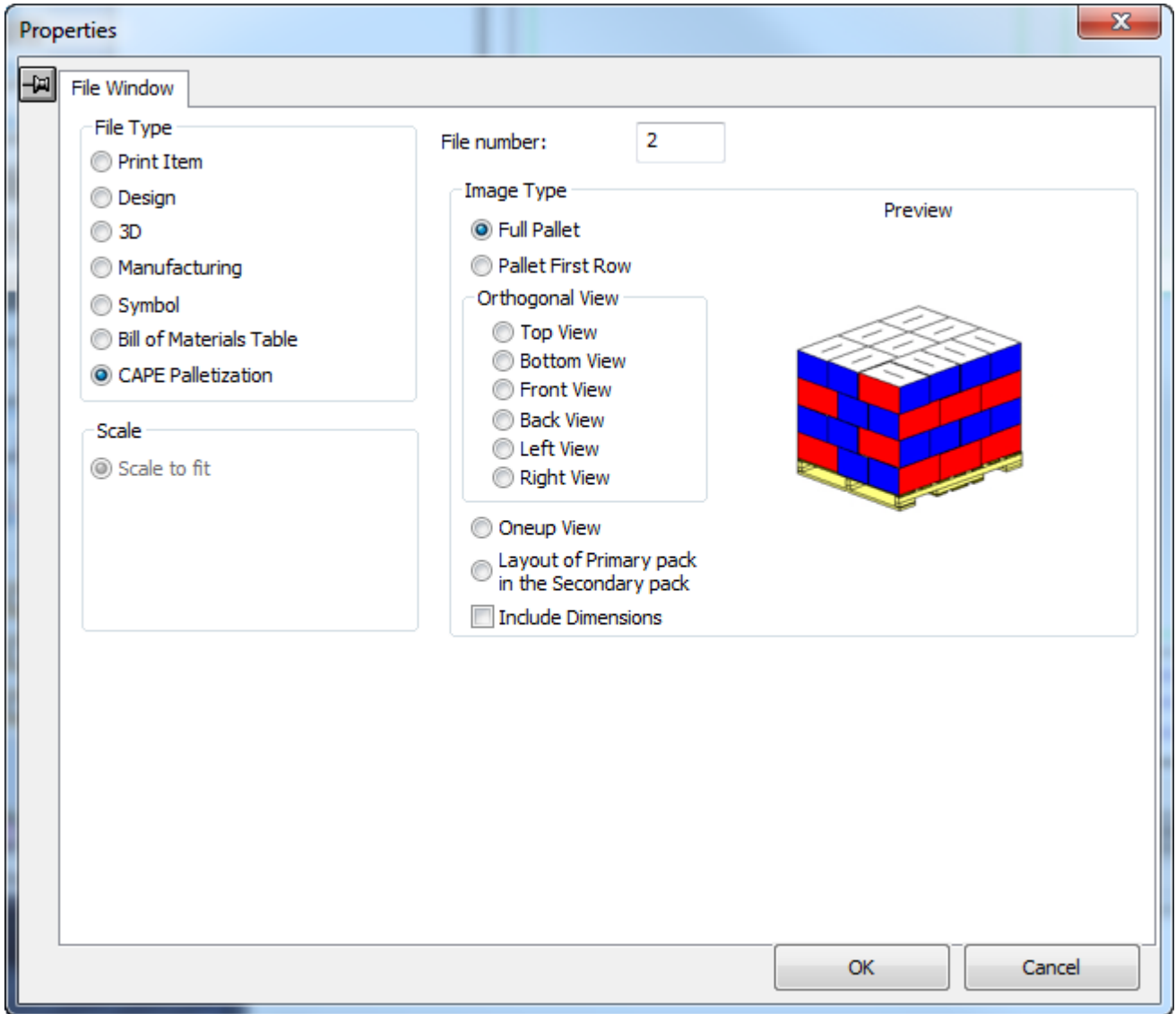

Choose an option in the Image Type group as desired. As you choose different image types to show in the file window, ArtiosCAD updates the preview with an example of a generic solution. The options in the Orthogonal View group apply to the full pallet view.

Adding text to the report

Three types of text are used on reports:

- Fixed text, which never changes;
- Prompted text, which you can change each time you use the report;
- Calculated expressions, which is text generated automatically each time you use the report.

The maximum amount of text allowed in an item of text is 4000 characters.

Adding fixed text

T Adding fixed text is accomplished by using the normal **Paragraph Text** tool on the Annotation toolbar. See **Paragraph Text tool** in the *Builder* chapter for more information.

Adding prompted text

Ta Add prompted text by using the **Prompted Text from Table** tool on the ReportMaker toolbar. Click the tool and place the text in the desired location. The Prompted Text Catalog will appear as shown below; yours may be different if you have different defaults defined. Click the plus sign to the left of a category to expand it. Then select an entry and click **OK**.

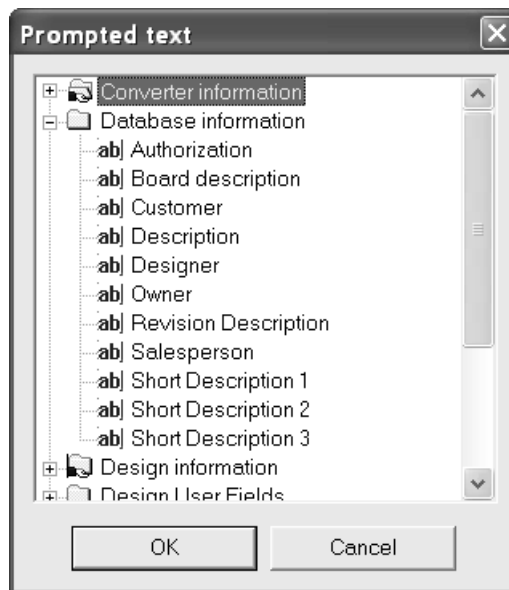

The cursor will still be the one for prompted text, so if you click in another location, the Prompted Text Catalog will reappear so that you may add another entry. When you have finished adding prompted text, click **Cancel** in the Prompted Text Catalog.

If you place a prompted text variable within a rectangle of design lines, the text entered for that prompted variable will wrap to the confines of the rectangle. If there is more text than will fit, ArtiosCAD will print as much as possible and end with an asterisk.

The **Database Information**, **Design User Fields**, and **Manufacturing User Fields** Catalogs link to the database, so that when you output the Report, you are prompted to set those fields. The values you set are saved in the database. Reports with database prompted text items may not be used in versions of ArtiosCAD lower than ArtiosCAD 6.0.

To copy database variables into another design or standard style for use when rebuilding a design, use the **Copy** button in Advanced StyleMaker as described in the *Designer* chapter,

Adding the *Inside Dimensions* menu, except use the name of the report workspace containing the variables instead of VARMASTER.

Adding calculated text

T_x Add calculated text by using the **Calculated Text** tool on the ReportMaker toolbar. Place the indicator box in the desired spot and click the mouse button. The Calculated Expressions Catalog will appear.

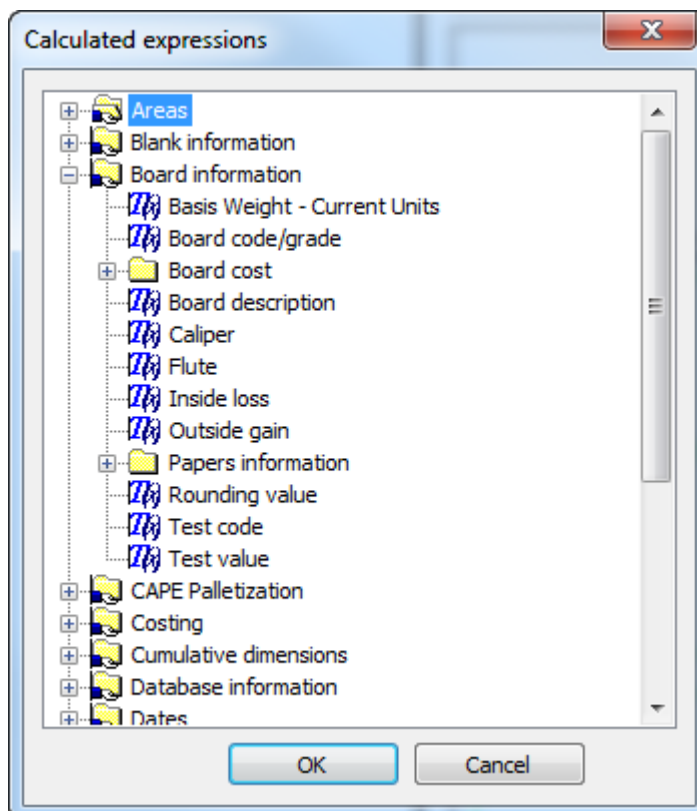

Choose the calculated expression to add and click **OK**.

The tool will remain active; clicking again will place another item of calculated text and will cause the Calculated Expressions Catalog to reappear. When you are done adding calculated expressions to your report, click **Cancel** in the Calculated Expressions Catalog.

If you place a calculated text expression within a rectangle of design lines, the text generated for that calculated expression will wrap to the confines of the rectangle. If there is more text than will fit, ArtiosCAD will print as much as possible and end with an asterisk.

A special calculated text entry for the length, width, and depth of the design where not all three variables are required to be set is the [L][xW][xD] entry in the **Design information > LxWxD sizes** folder. Use this entry to print those values if you are not sure if they will be set when the Report is run. Values which are not set will be blank.

Note: If you are using Cape Palletization data on this Report, for there to be regular ArtiosCAD-type calculated text, you must have a file window of type Design on the Report and the calculated text's properties must be set to reference that file or print item number in the Expression relates to group.

Adding graphics to the report



Adding graphics to a report is as simple as using the **Add Graphics** tool on the Graphics toolbar. Navigate to the directory the graphic file is in and double-click its name. The graphic will appear in the report and its handles will be on. Click a handle to use to move the graphic to the desired location, and then drag the graphic to its new position.

Modifying items on the report



To delete an item from a report, select it and click the **Delete** tool on the Edit toolbar.

Move text by selecting it with the **Select** tool and dragging it to its new position. The Align Text tools are handy for aligning fixed text and prompted text items into columns. Move graphics with the **Move** tool.

To change the attributes of any text, double-click it with the **Select** tool. The Properties dialog box will appear. Do not change the **Text** field of Prompted Text items or Calculated Expressions.

Use the tools on the Edit toolbar to modify a graphic if desired. The tools on the Graphics toolbar also modify any graphic item on a report.

Changing the size of a File Window



Use the **Adjust File Window** tool to change the size of a File Window by doing the following:

1. Click the **Select** tool and then select the File Window to modify.
2. Click the **Adjust File Window** tool.
3. Click the handle point to use. This is the point you will be moving to change the size of the file window.
4. Move the handle point using drag or by entering new values in the Status bar fields.

Modifying fixed or prompted text

To change an item of fixed or prompted text, double-click it with the **Select** tool to invoke the Properties dialog box.

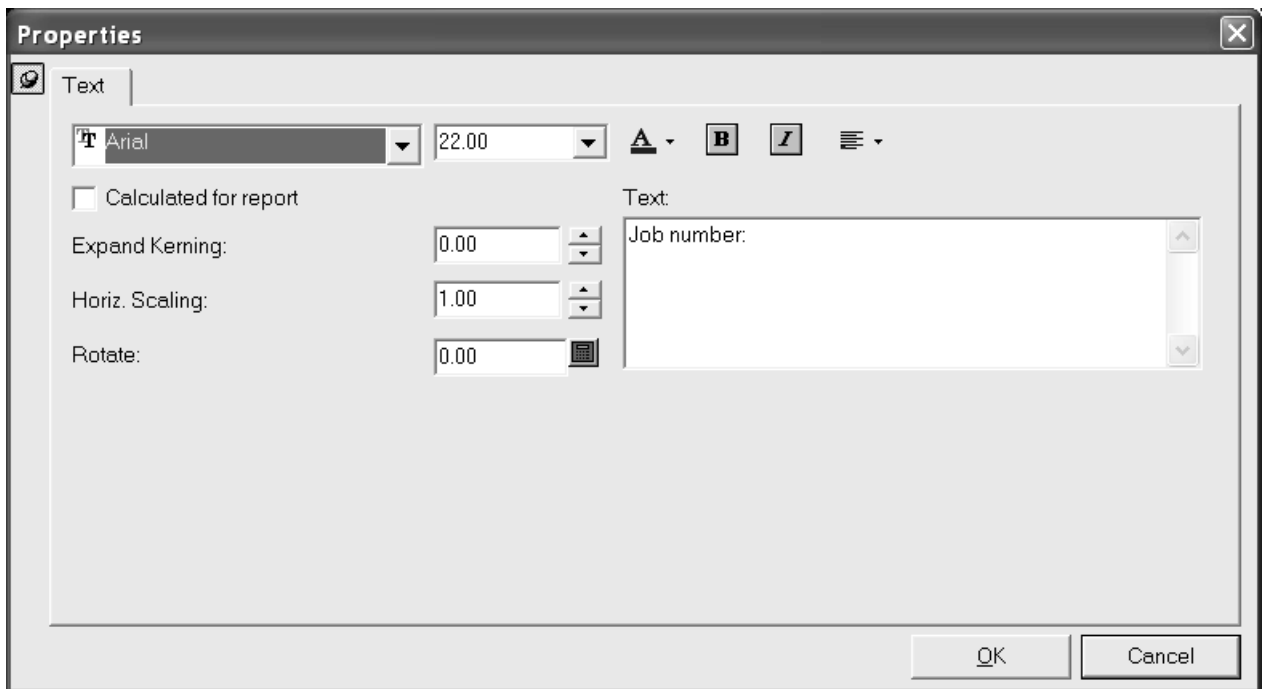

Modify the text appearance and justification by using the controls along the top of the dialog box. **Kerning** controls the amount of space ArtiosCAD inserts between letters. **Horizontal scaling** increases the horizontal size of the characters without changing the vertical size. **Rotate** changes the angle of the text. Note that changing the text justification may be required to position the text exactly as desired.

To change the text itself, change the text in the **Text** field.

Modifying calculated text

To modify calculated text, double-click it with the **Select** tool to invoke its Properties dialog box.

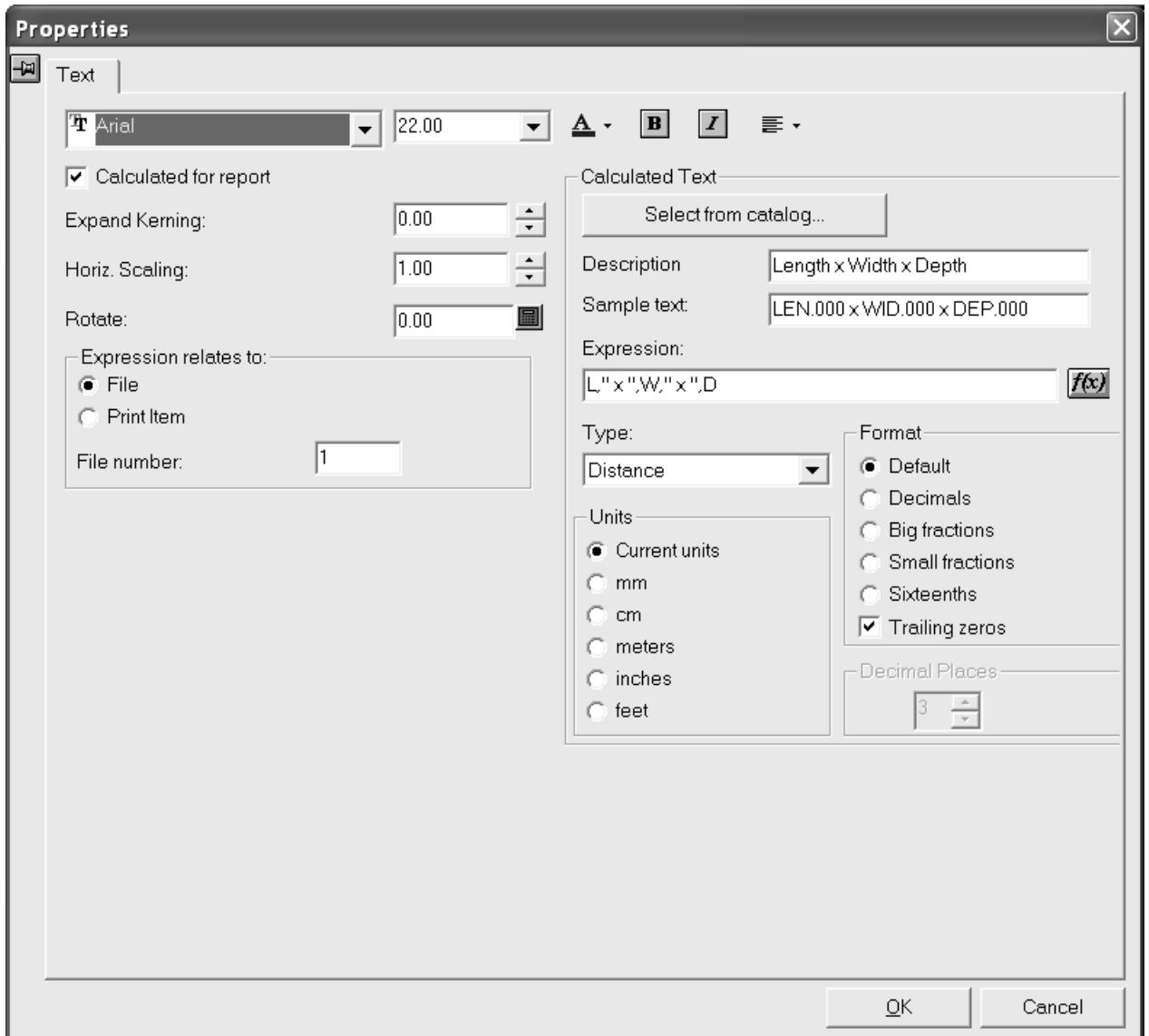

Modify the text attributes in the usual ways. **Kerning** controls the amount of space ArtiosCAD inserts between letters. **Horizontal scaling** increases the horizontal size of the characters without changing the vertical size. **Rotation** sets the angle of the text from horizontal.

In the **Expression relates to** group, make sure you have the correct file or print item selected, otherwise incorrect information will print on the report.

Note: If you are using Cape Palletization data on this Report, for there to be regular ArtiosCAD-type calculated text, you must have a file window of type Design on the Report and the calculated text's properties must be set to reference that file or print item number in the Expression relates to group.

The **Calculated Text** group contains the options which affect the actual information displayed when the report is run, not just the font options of the information. **Description** is what shows in the menu when you select the item of calculated text. **Sample text** is what appears as a placeholder in the design window while you are building the form. **Expression** is the ArtiosCAD expression which calculates the value. The **f(x)** button lets you change the way the expression

is calculated by invoking the Edit Expression dialog box. Do not use invisible variables in calculated expressions. **Select from catalog** lets you replace the current item of calculated text with a new one you choose from the Calculated Text Catalog.

The choice in the **Type** drop-down list box determines the availability of the **Units** and **Format** groups as well as the options within them. For instance, if the Type is **Distance**, the Units are plain linear measurements, but if the Type is **Area**, the Units are squared. If the Type is **Angle or Number** the Units option buttons are unavailable, and if the Type is **Text** both the Units and Format groups are unavailable. Use **Distance** for expressions which are units of length. Use **Area** for units which are squared. **Angle or Number** should be used for numbers with no units such as number up (on a die). **Text** should be used for text or for expressions which contain more than a single number, such as **Length, Width, Depth**.

Decimal Places controls how many decimal places are used and is only effective when anything but Default is chosen in the **Format** group.

Rubber on Reports

You can create a custom Rubber Types legend on a Report using the calculated text items below. An example Rubber Types legend is included in the **Artios** example outputs.

Table: Calculated expressions for a Rubber Types legend

Description	Calculated text expression	Example
Rubber type name in the list of rubber types	RTNAME(rtype), rtype =1,2,3,4,...	RTNAME(1)
Rubber color block in the list of rubber types	RTLIN(rtype)	RTLIN(1)
Rubber type name in the list of rubber sheets	RUBT.R[RUBS.S rtype .RT].NAME\$	RUBT.R[RUBS.S1.RT].NAME\$
Rubber sheet width	RUBS.S rtype .DX*#M	RUBS.S1.DX*#M
Rubber sheet height	RUBS.S rtype .DY*#M	RUBS.S1.DY*#M
Waste %	RUBS.S rtype .WASTE	RUBS.S1.WASTE

Shown below is an example layout with rubber sheets on a Report with a Rubber Types legend.

Rubber Layout for: RUBBER8 Die size: 33 x 23

Rubber type	Sheet size used	Waste %
Green Profile	20	8.085
Red Neoprene	20	1.122
Yellow slot		52.57
Cork		

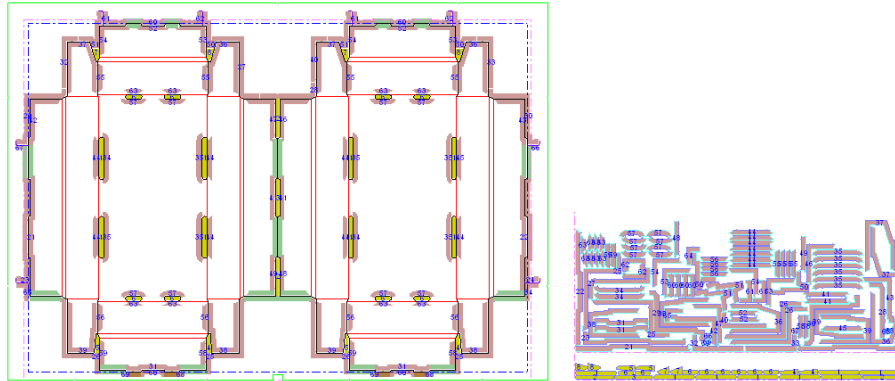

To have each rubber sheet on a separate page, use the reports in **File > Outputs > Artios > Rubber > Rubber Separate Sheets**. A separate Report is provided for rubber sheets 1 through 5. The rubber sheet number for the file window is derived from the text item called **rubbertypename5** with calculated text RUBT.R[RUBS.S5.RT].NAME\$.

Saving the report

When you are done constructing the report, save it to either the ServerLib or ClientLib directory of the ArtiosCAD release you are using in order to be able to easily add it to the Reports catalog. Also, saving it in one of those directories preserves it through software upgrades.

Making a title block report

Most reports scale the design to fit inside a rectangle in the report. A **title block** report has the design at a specified scale, usually scale 1, with the report text positioned relative to the edge of the design.

Create a title block report by designing the title block, and adding the file window for the design with a fixed scale. Set the justification of the file window to position the title block at the required position relative to the design. For example, to position the title block at the bottom center of the design, use bottom center justification for the file window. Shown below is an example.

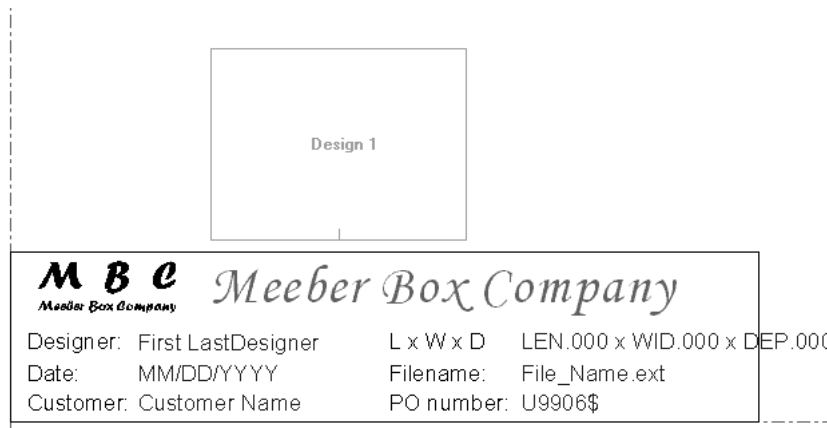

When a title block Report is used in an Output, the design is positioned in the file window according to the justification of the file window. Set the scale of the output to fit one page. The actual size of the file window is not used; it does not make any difference if the design is bigger or smaller than the file window. Shown below is an example of a completed Output.

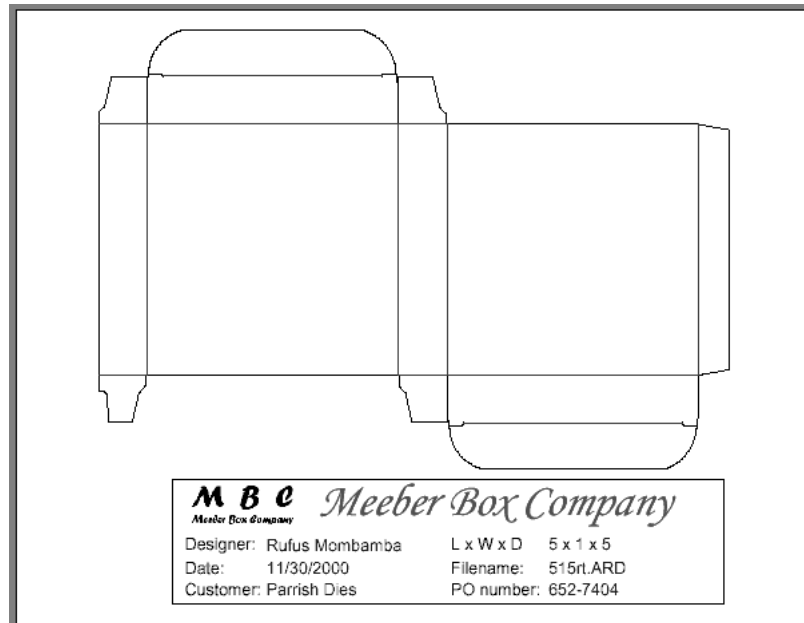

Notes and warnings about Reports

When you want to output a report which will show a manufacturing file and its embedded single designs, do the following:

1. Assign File Window 1 the **Manufacturing** file type in its Properties dialog box.
2. Assign File Windows 2..x the **Design** file type in the Properties dialog box.
3. When you Output the report, **make sure** the manufacturing file is the active document. File Windows 2..onward are filled in the order in which they are displayed in the Oneups Dialog in Manufacturing. Thus, the first embedded file would appear in File Window 2, the second embedded file would appear in File Window 3, and so forth.

4. If you have more file windows on the report than you have embedded designs in the manufacturing file, the remaining file windows will be empty. You can assign other open files to them if you wish.

When putting text on a Report, you should always put it inside a closed shape made out of cut lines. The text is truncated against the perimeter of the report if the scale gets too large on Output. This prevents text from running off the page if the scale is too big.

Using the ITEMORD function on Reports

The ITEMORD() function returns the ordered quantity of a print item. The function argument refers to the quantity number. If you have a multiple quantity report for use with manufacturing files, the ordered quantities should have calculated text:

ITEMORD(1) print item 1, ITEMORD(2) print item 1, ITEMORD(3) print item 1, and so on.

If you have a report for a mixed layout, the ordered quantities on the report should have calculated text:

ITEMORD(1) print item 1, ITEMORD(1) print item 2, ITEMORD(1) print item 3, and so on.

Adding a report to the Reports Catalog

Once the report workspace is saved, click **Defaults** on the **Options** menu of ArtiosCAD.

To add the report to the Shared defaults, which will let everyone using this installation of ArtiosCAD use it, do the following.

1. Open the Report Catalog in the Shared Defaults window.
2. Right-click **Report Catalog**, click **New**, click **Data**, and enter the name of the re-port as you want it to appear in the Report Catalog.
3. Then double-click its icon and enter the name of the report work-space. It is a good idea to use a copy of the report workspace which you have saved in ServerLib as this will be preserved through future upgrades.
4. Click **OK** when you have entered the name.
5. Save your changes to Defaults by clicking **File > Save**.

Once the report has been added to the Reports Catalog, it must be added to Outputs in order for it to appear in the Outputs menu.

Defining an Output that uses the report

To define an Output using the report, while still in Defaults, right-click Outputs, click **New**, then click **Data**. Enter the name of the new output, e.g. Meeber Box Company simple report. Double-click its icon. A dialog box will appear with the name of the report as the title.

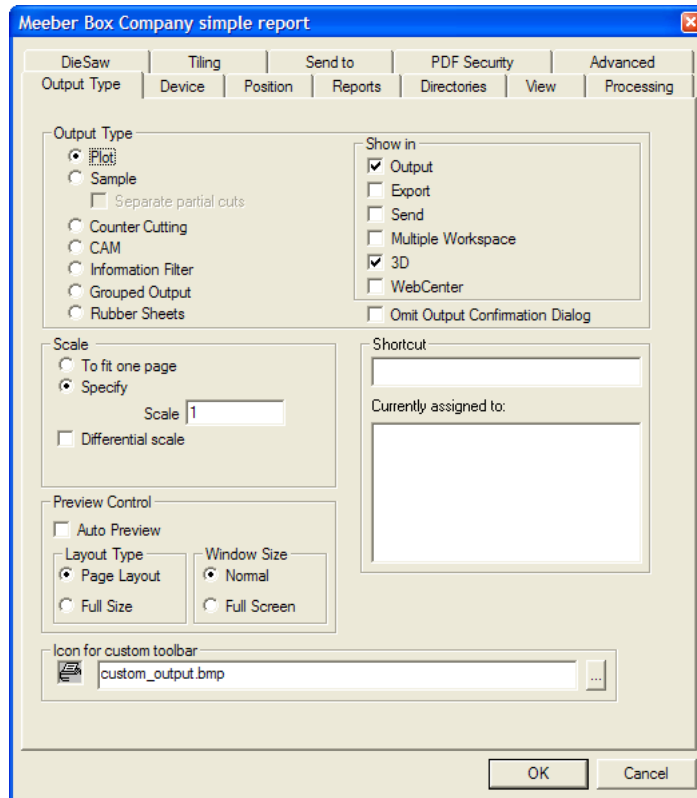

In the **Shown in** group, select those areas of ArtiosCAD (or, optionally, WebCenter) in which the new Output will appear. You must select at least one area; if only one checkbox is selected, that checkbox may not be deselected until another is selected.

If you will print this report on a printer driven by Windows, choose the printer the report will be printed on in the **Windows Driver** drop-down list box on the the Device tab, or choose **Default Printer** to output to the default printer.

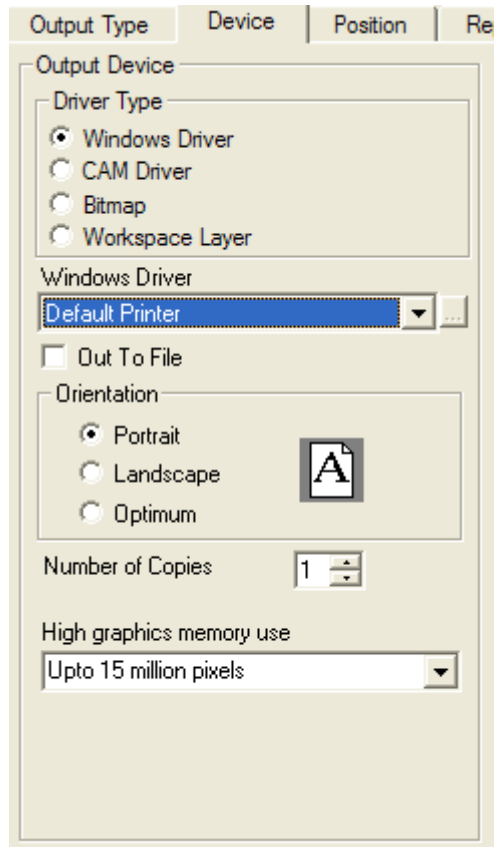

If you are using an ArtiosCAD internal driver for the printer, choose CAM on the **Device** tab and choose the device from the CAM Driver list box. Leave the **Output Type** as **PLOT** and set the **Scale** to **To Fit One Page**.

Once the options on the Device tab are set correctly, click the Reports tab. Check the **Use Report** checkbox and select your report.

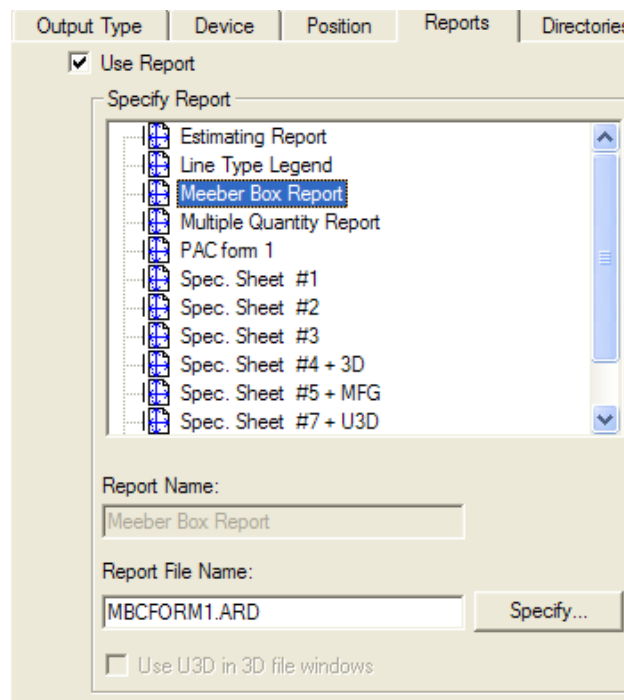

If the Report has at least one 3D window on it and the Output is a PDF file, the **Use U3D in 3D file windows** checkbox becomes available. U3D is an industry-standard 3D output format that can be read by many applications. For example, if you embed U3D data in a PDF file, Acrobat Reader 7.0 or greater lets you zoom in and out, rotate, and otherwise change the view of the objects in the 3D file window. Select this checkbox as desired.

To have individual PDF or U3D images when you use this Report with Cape Pack data, use unique palletization file numbers in Cape Pack but associate them with the same ArtiosCAD 3D workspace.

To change other settings, click the other tabs and set the options as desired. When done, click **OK** to apply the changes you made to Defaults. Then click **File**, and then click **Save** to save the shared defaults. Click **Yes** in the Warning dialog box about overwriting the shared defaults.

To give only yourself access to the report, follow the procedure listed above for Shared Defaults, except do it in the User Defaults pane of the Defaults dialog box.

Using a Report

Once you have added your report to the Reports Catalog and have created an Output for it, using it is quite easy. The procedure for using a Report in Single Design or Manufacturing differs from using one in 3D; see the next section for the 3D procedure.

Single Design and Manufacturing

To use a Report, open the workspace(s) you want to place on the report. Turn on the layers that you want to be printed on the report along with the workspace(s). Click File, then Outputs,

and then the name of the Output you created. If you used prompted text on the Report, you will be prompted to set values for each prompted text item.

The values you choose for any database-linked prompted text items will be set in the database upon completion of the output. You may only set user fields for the type of document being Output; those user fields with the opposite type are listed but unavailable.

Variables used in both the report and the workspace(s) being used on the Report may be listed when outputting the Report, but may not be changed. To change them, change them in the workspace(s) before outputting the Report.

Set the values as desired and click **OK**.

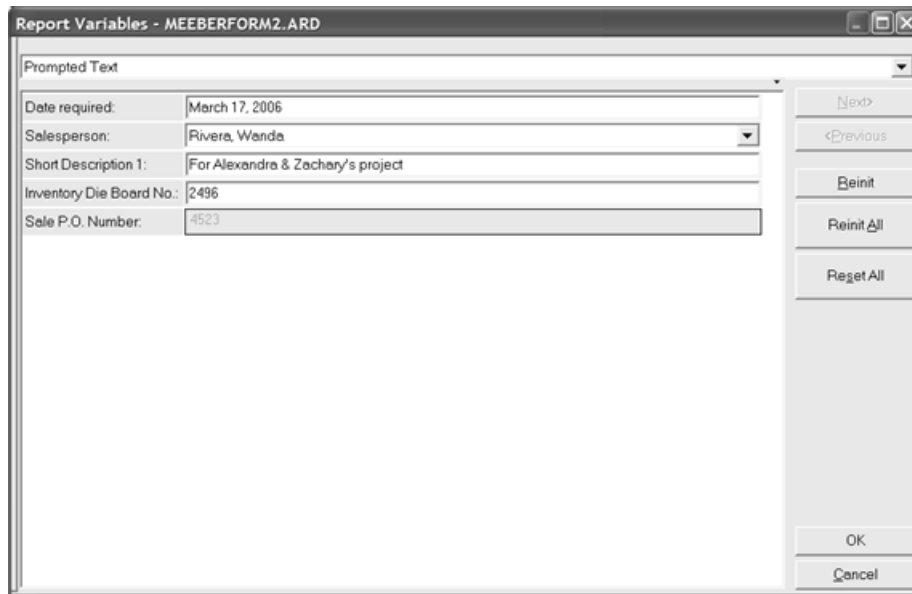

If you have more than one File Window on the report, the Select Report Files dialog box will appear. In this dialog box you can review which file is associated with which File Window and change it if necessary. You can only choose from among open files, so make sure you have already opened the workspaces you want to output before you start the Output. Click **OK** when the files are assigned to their proper File Windows.

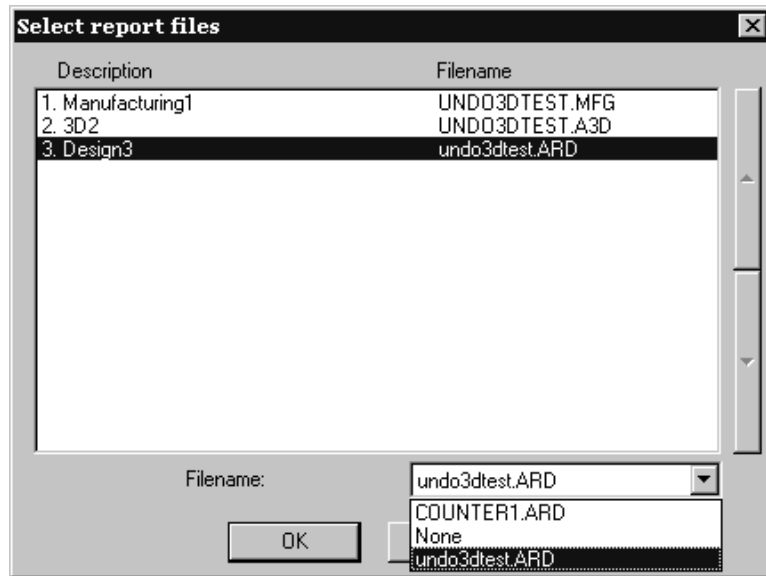

Note: If you have a manufacturing file window on a report, **you must make the manufacturing file the active document** in ArtiosCAD (so that its title bar is highlighted) for it to print correctly on the report.

The output dialog box for the report will appear, and because you defined all the options in Defaults when configuring this Output, everything should be set correctly.

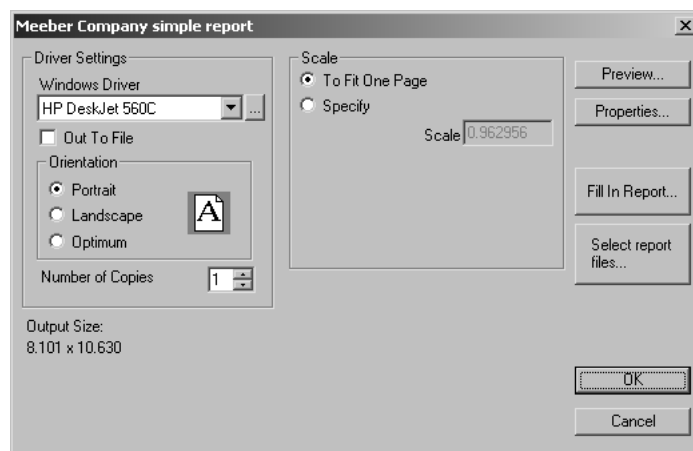

Preview shows a preview of the form as it will print.

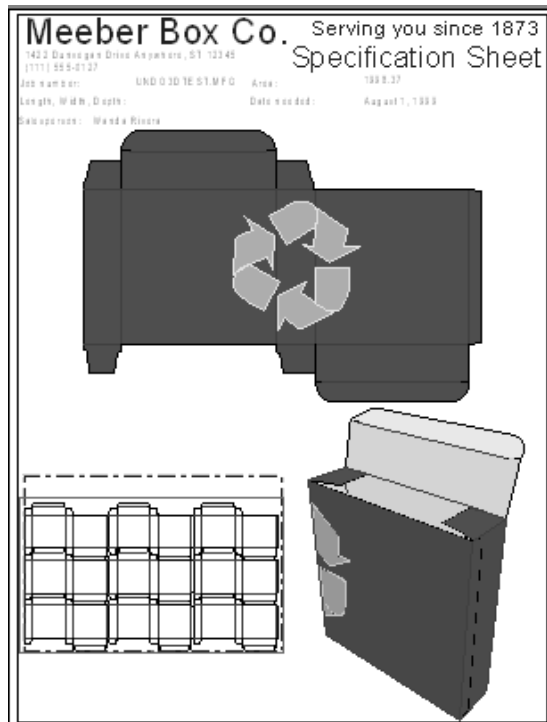

Properties lets you adjust the properties of the Output itself, not of the report. **Fill in Report** lets you adjust the answers you gave to prompted items. **Select report files** invokes the Select report files dialog box as shown on the previous page.

Click **OK** to print the report. Click **Cancel** to dismiss the output dialog box.

3D

Using a Report from 3D is as easy as using one in Single Design or Manufacturing. The difference is that in order to get the design information for variables on the Report, ArtiosCAD references the single design workspaces that are shown folded in the 3D workspace. The Output will not work without the associated single design workspaces, so to use a Report on a 3D workspace on a different computer or at a different site, you must also copy or send the associated single design workspaces along with the 3D workspace.

If the 3D workspace contains exactly one structural single design, ArtiosCAD checks to see if the single design is already open. If it is not already open, ArtiosCAD looks in the location holding the 3D workspace, and opens it if it is found. If it still cannot be found, ArtiosCAD prompts you to browse for the file.

If the 3D workspace contains more than one structural single design, ArtiosCAD prompts you for the workspace(s) to use with the Report.

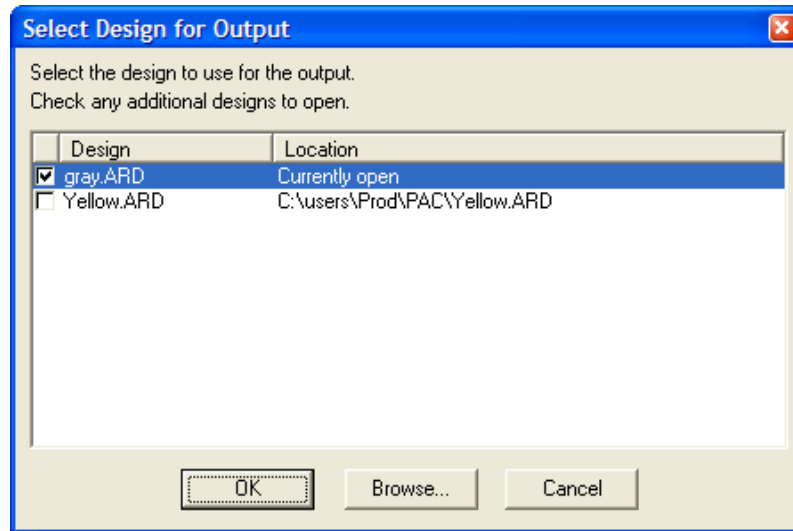

Select the workspace(s) to use by checking their checkboxes and click **OK**. If **File not found** is displayed in the **Location** column, highlight that line and click **Browse** to find the file. The Report will then be created in the same way as in Single Design or Manufacturing.

Note: You may not use a Report with a workspace containing only embedded solids or Solids of Revolution; there must be a structural component to the 3D workspace.

Shown below is an example of a Report with a Single Design window and a 3D window exported to a PDF file that uses U3D.

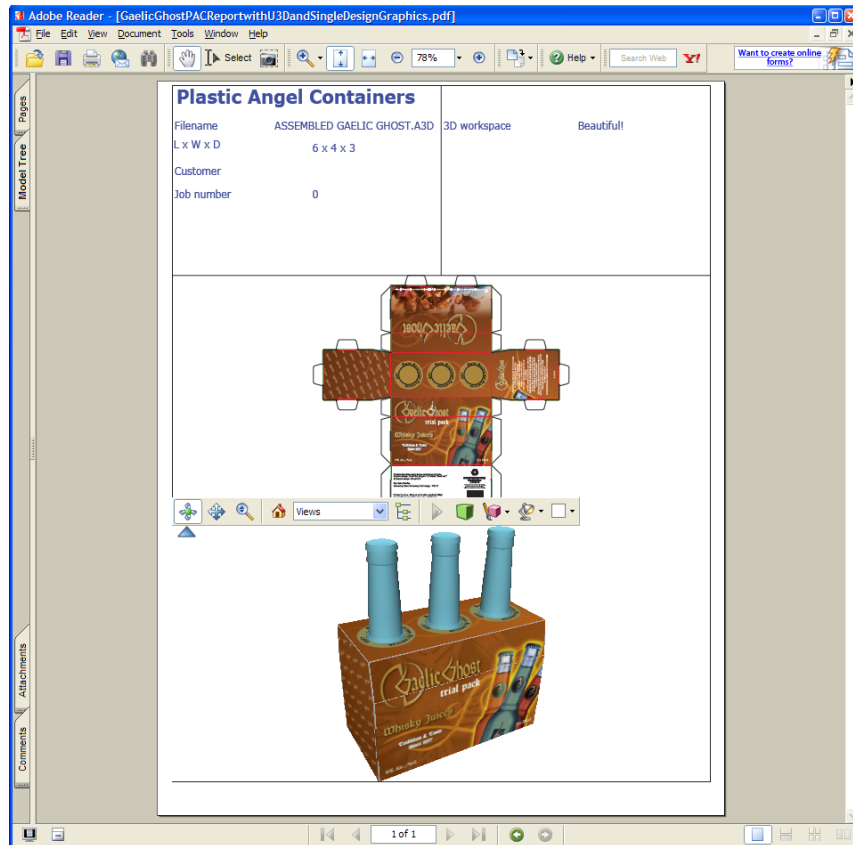

Cape

ArtiosCAD has three example Cape Pack Reports in **Outputs > Palletization**.

- Cape Pack Arrange/Design Group Report
- Cape Pack Pallet Group Report
- FCA Pallet Group Report

Cape Arrange/Design Group Report workflow

This workflow describes how to use the example Cape Pack Arrange/Design Group Report starting in Cape Pack. It creates two single designs, one for the primary pack and one for the secondary pack, that you then convert to 3D.

1. In Cape Pack, create an Arrange/Design Group solution.

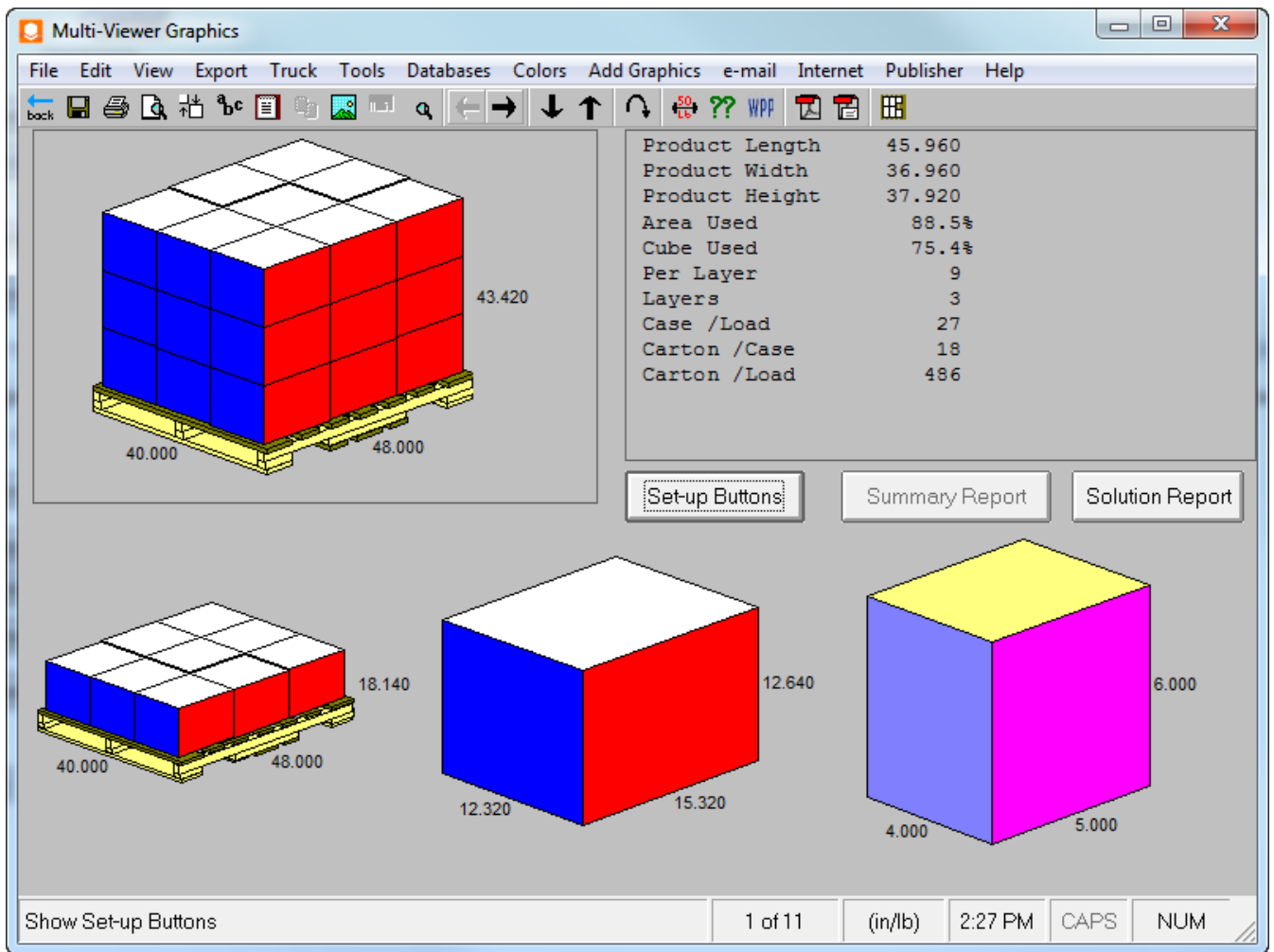

2. Export this solution to ArtiosCAD. It will create two new single designs that you can modify as desired, such as by adding graphics.

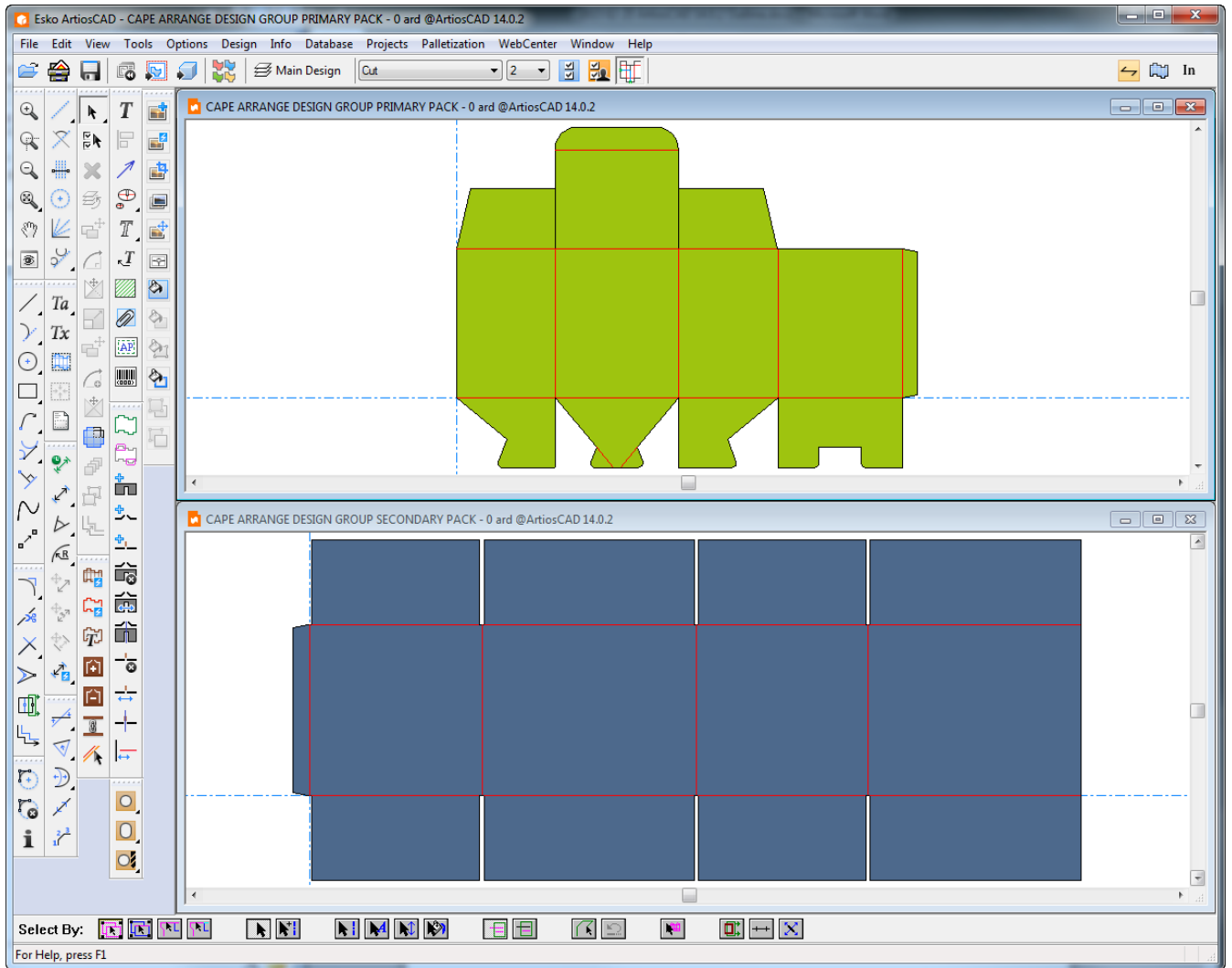

3. Convert these single designs to separate 3D workspaces and fold them at 90 degrees if needed.

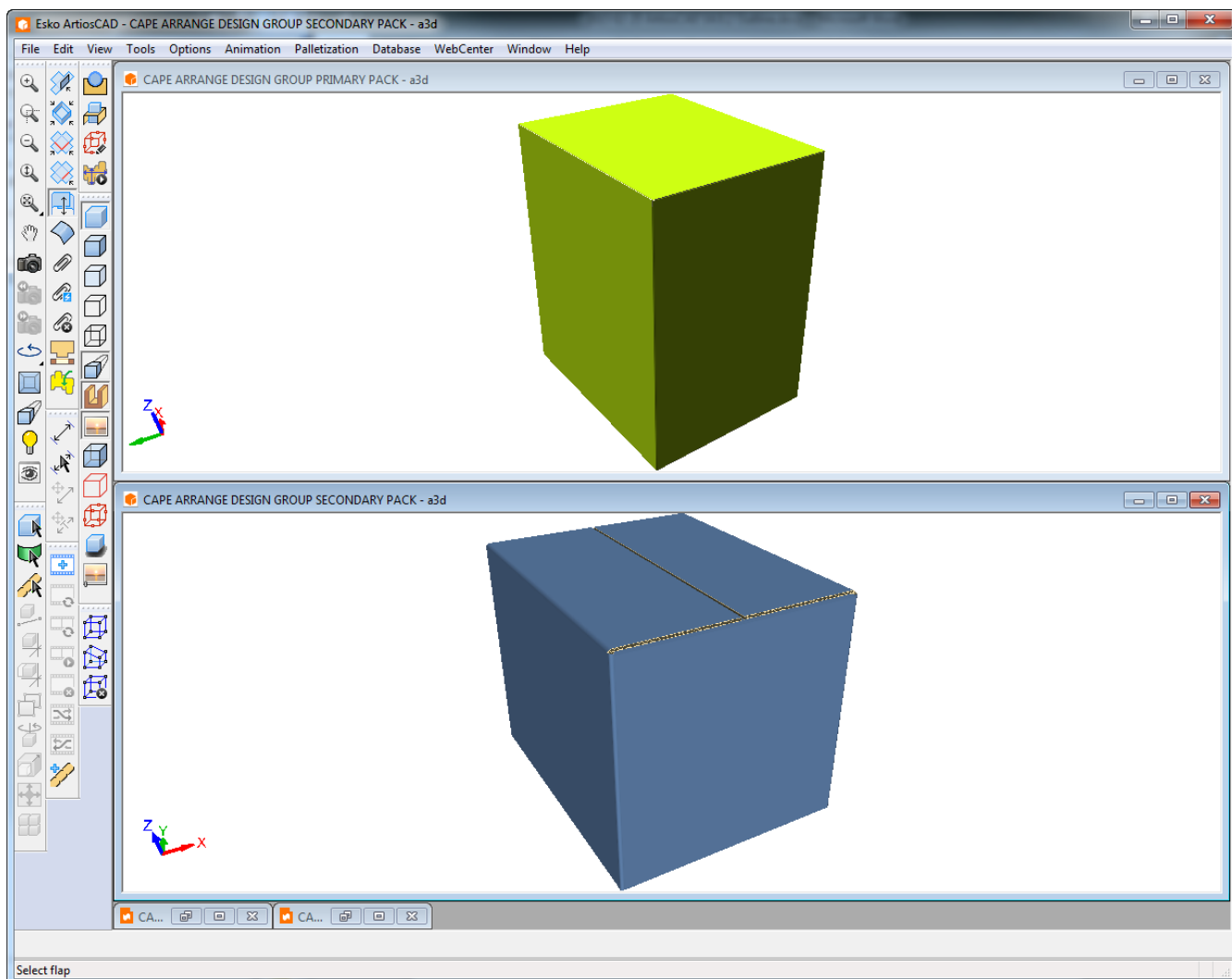

4. In 3D, click **Outputs > Palletization > Cape Arrange/Design Group Report**.
5. Select the 3D workspace for the primary pack to map to file window 1, select the 3D workspace for the secondary pack to map to file window 2, and click **OK**.

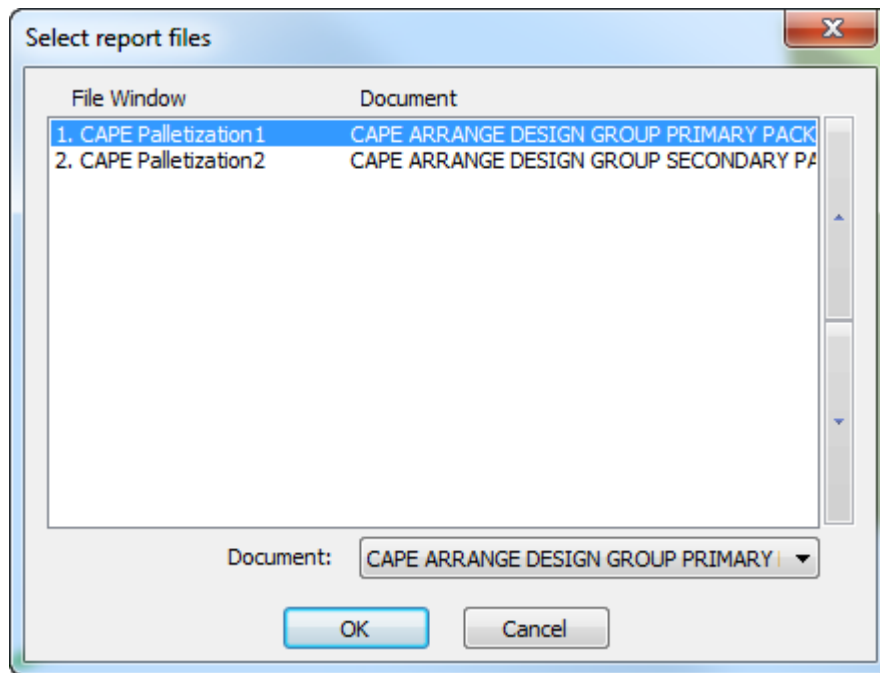

6. In the Output dialog box, click **OK** to output the Report as previewed below. At the top of the report is some palletization calculated text. Beneath that, starting with the top left image going from left to right row by row, is a full pallet view of the secondary pack, the oneup layout in the secondary pack, the pallet first row view, and the primary pack oneup view, followed by more palletization calculated text.

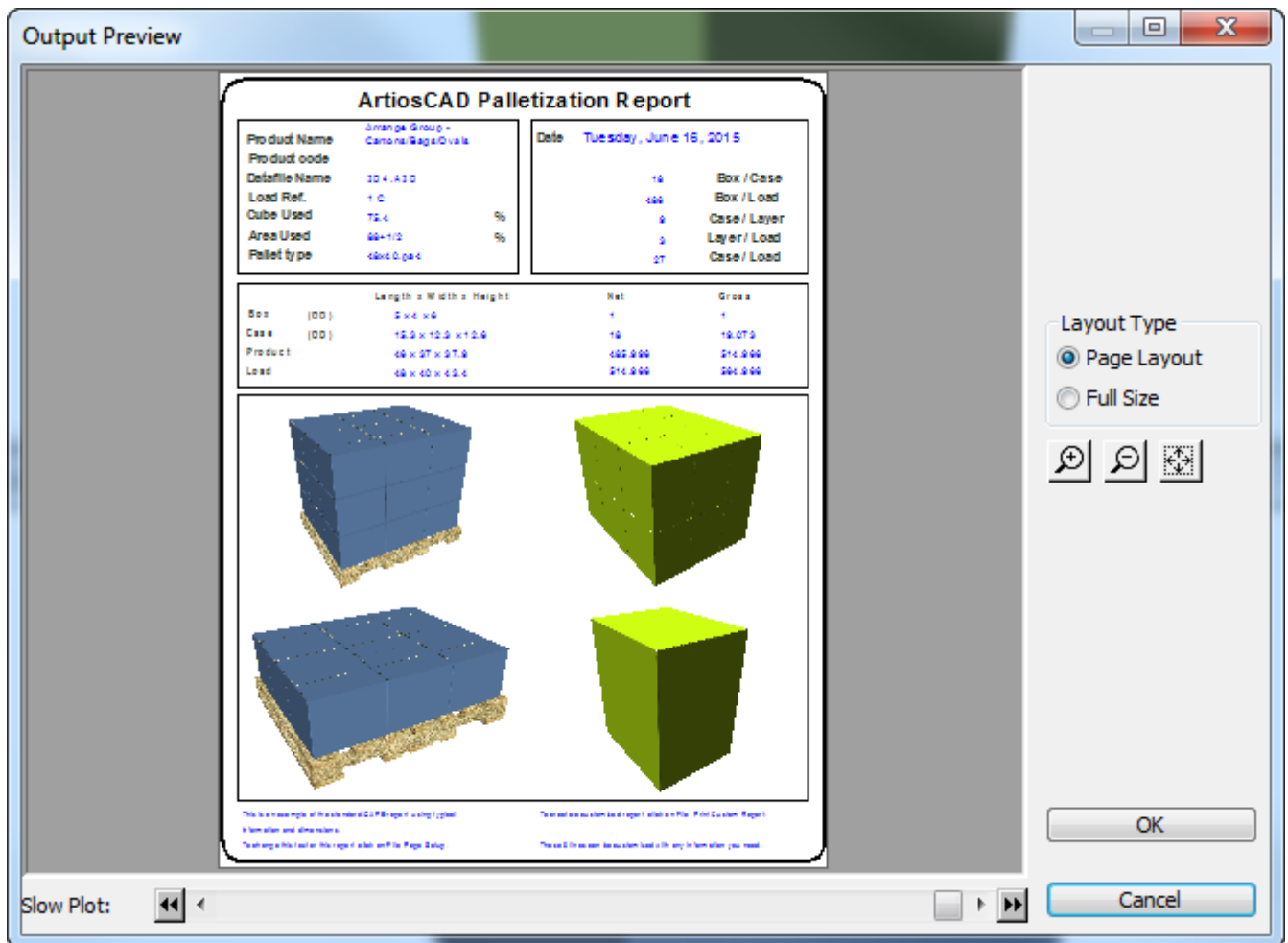

You can also use this workflow in ArtiosCAD with your own single design which you would then convert to 3D, palletize, and run with this Output. The 3D workspace is the primary package, and Cape Pack returns the secondary package as a single design. Convert the secondary package to 3D. Map file window 1 to the primary package's 3D workspace and file window 2 to the secondary package's 3D workspace.

Cape Pallet Group Report workflow

This workflow describes how to use the example Cape Pack Pallet Group Report starting in Cape Pack.

1. In Cape Pack, create a Pallet Group solution.

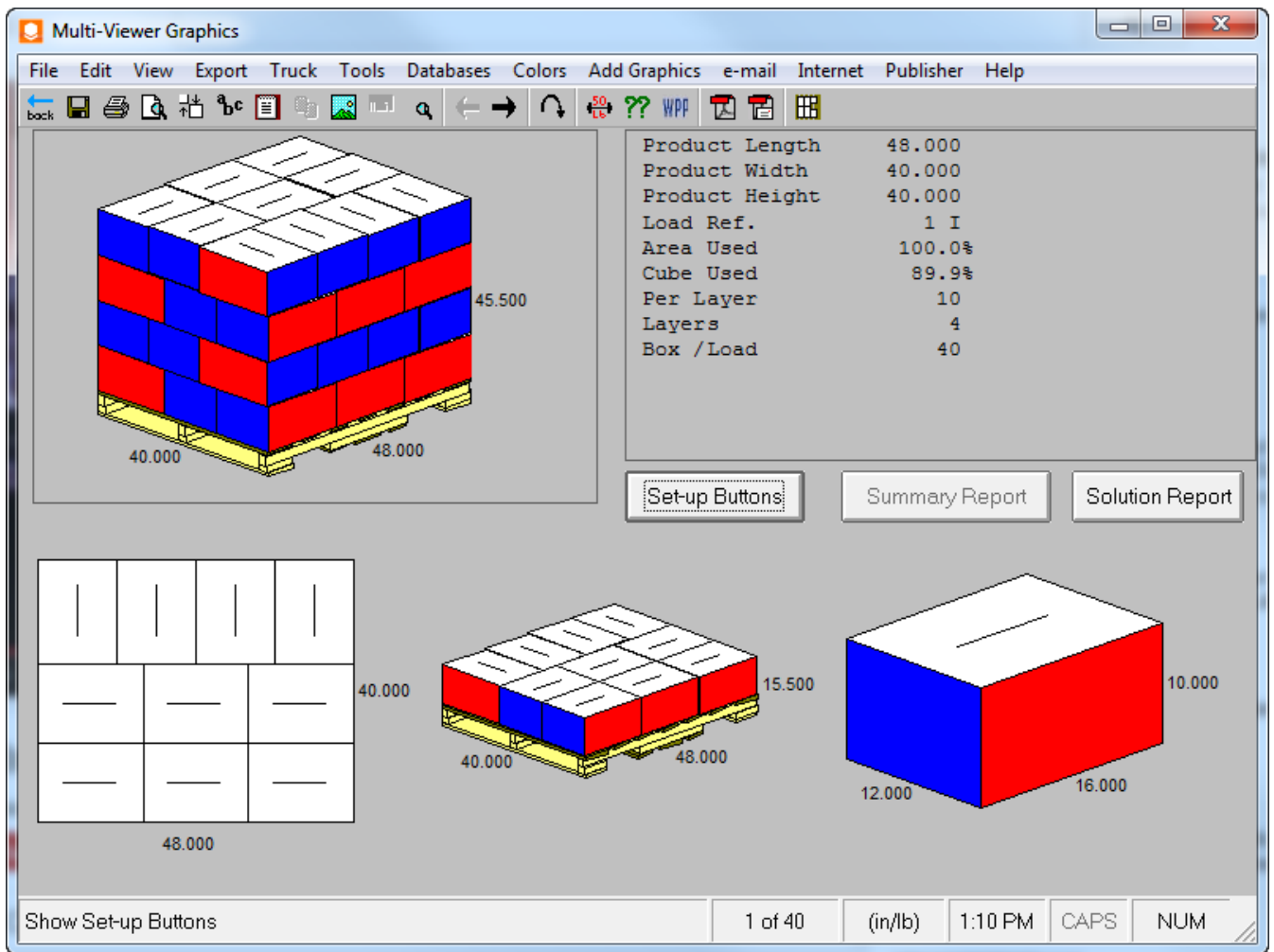

- Export this solution to ArtiosCAD. It will create a new single design that you can modify as desired, such as by adding graphics.

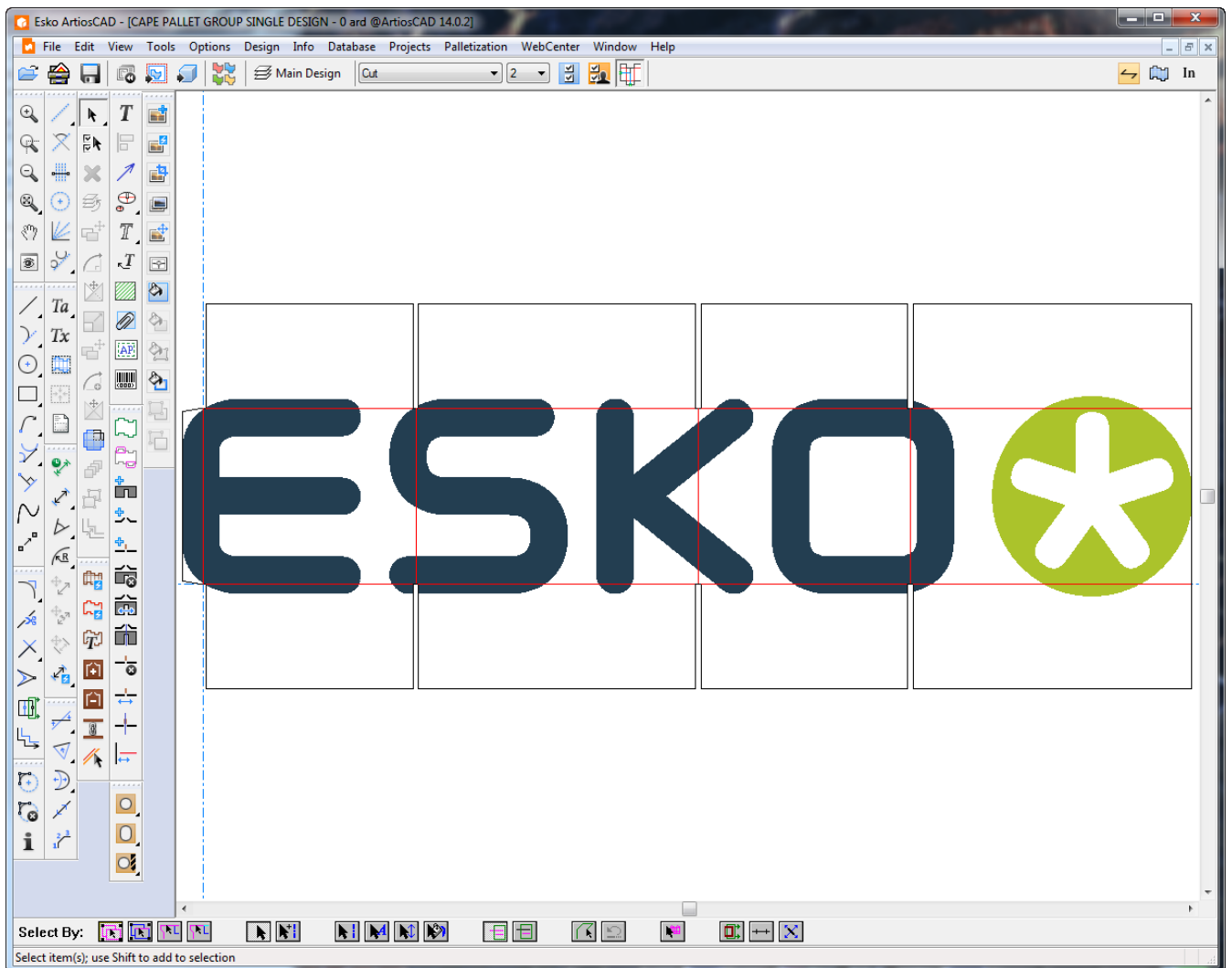

3. Convert this single design to 3D and fold it at 90 degrees.

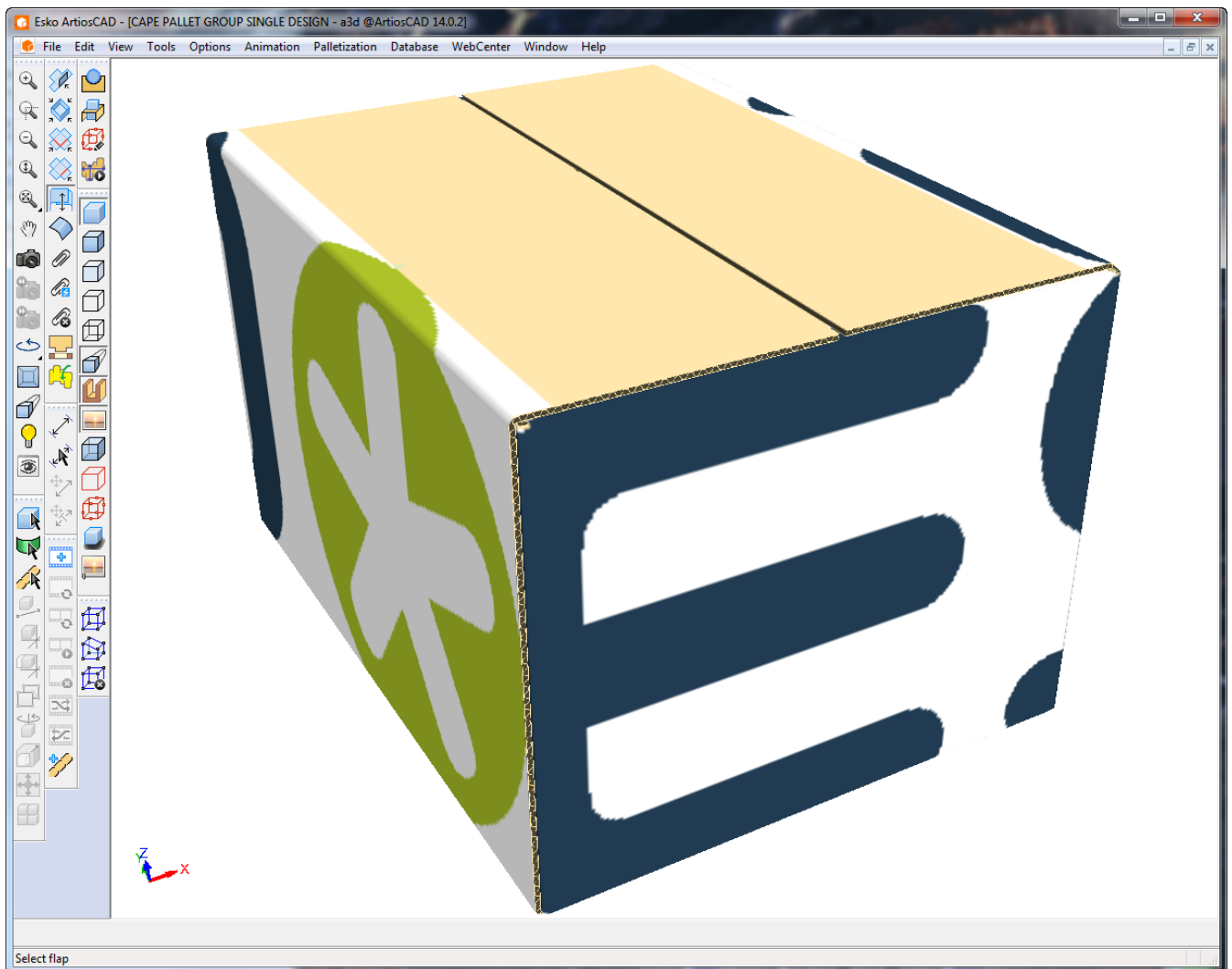

4. In 3D, click **Outputs > Palletization > Cape Pallet Group Report**.
5. Select this 3D workspace to map to file window 1 and click **OK**.

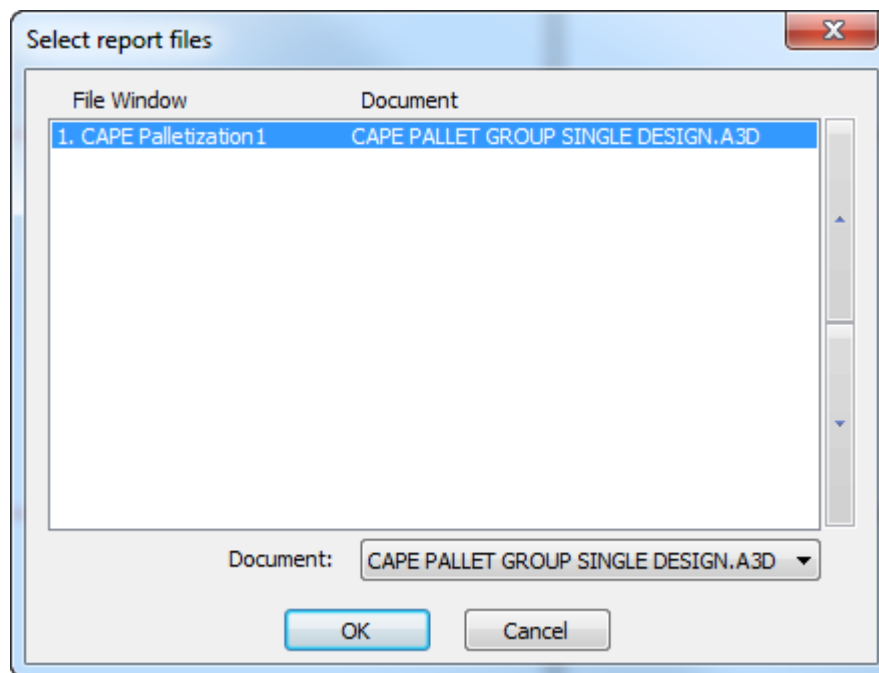

6. In the Output dialog box, click **OK** to output the Report as previewed below. At the top of the report is some palletization calculated text. Beneath that, starting with the top left image going from left to right row by row, is a full pallet view, a pallet first row view, a top view, and a view of the single design, followed by more palletization calculated text.

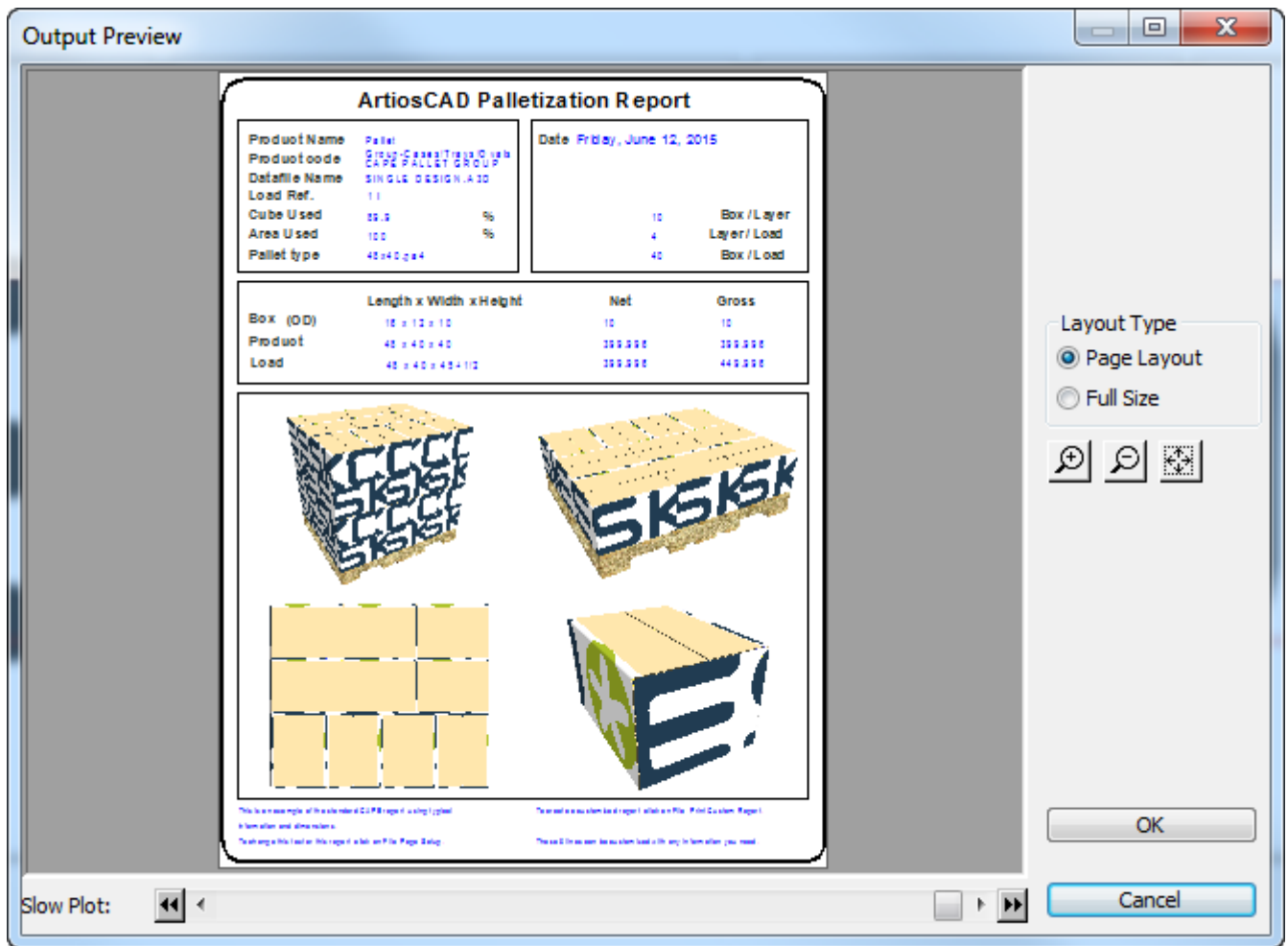

You can also use this workflow in ArtiosCAD with your own single design which you would then convert to 3D, palletize, and run with this Output. Leave the single design workspace open so that you can use the Outputs menu. Shown below is the report with a design that originated in ArtiosCAD.

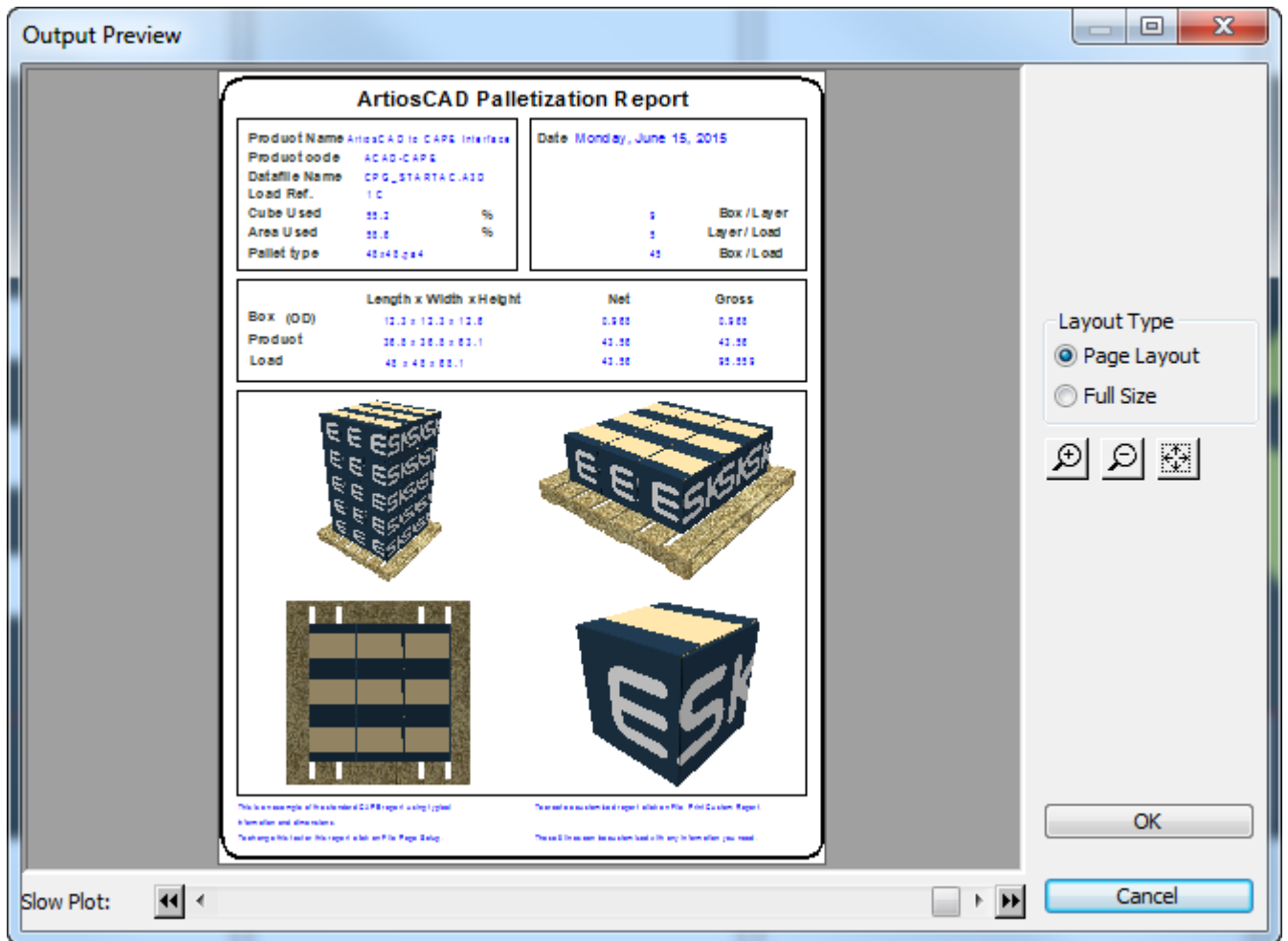

FCA Pallet Group Report workflow

Once you have created a KDF (knock-down flat) and palletized shipping case as described in the *Palletization in 3D* section of the 3D chapter, you can Output a Report showing the solution.

1. Have both the KDF and shipping case open in 3D, with the KDF folded in half and the shipping case with all angles at 90. ArtiosCAD uses the palletization metadata returned from Cape Pack to generate the Report.

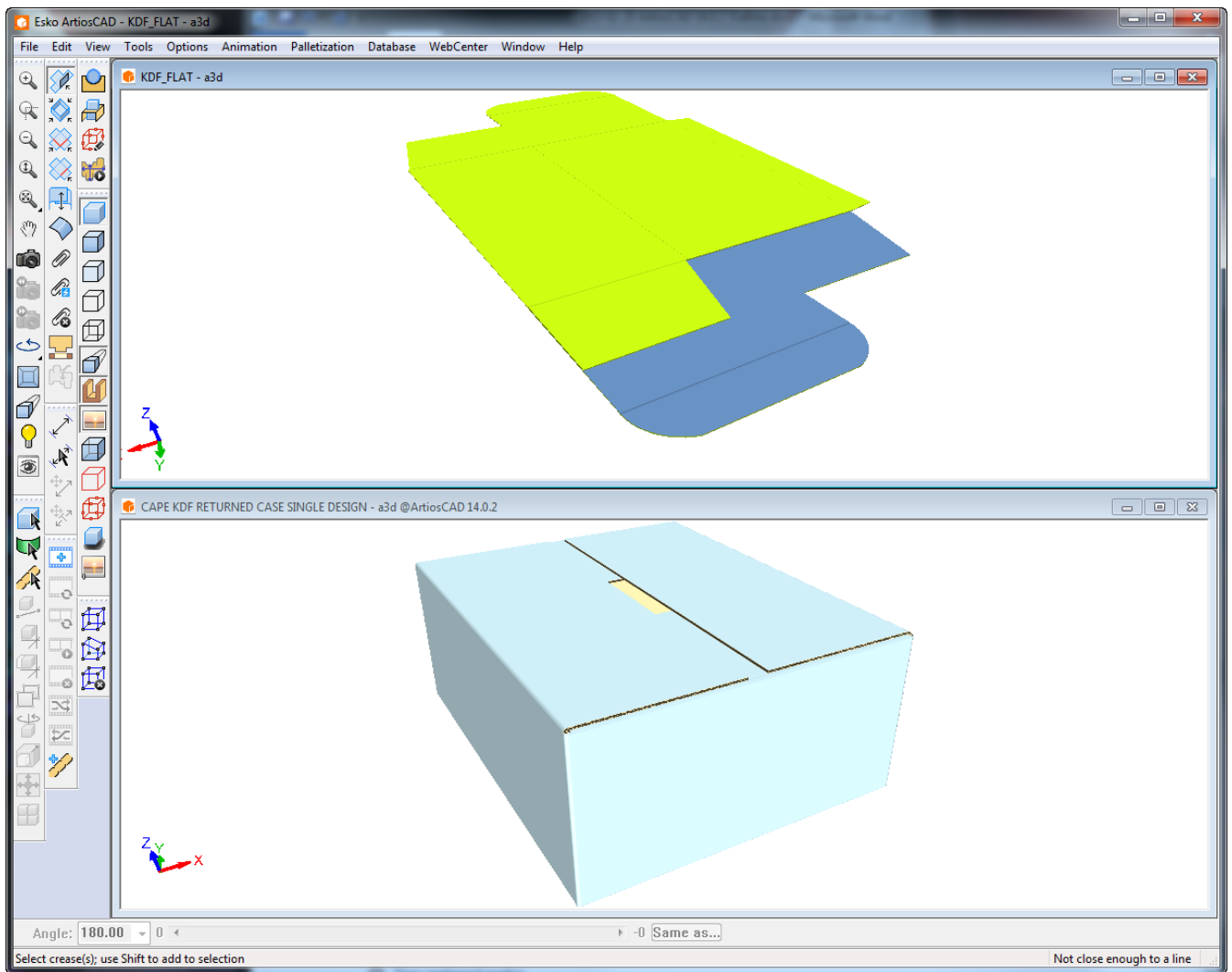

2. In 3D, click **Outputs > Palletization > FCA Pallet Group Report**.
3. In the Select report files dialog box, set file window CAPE Palletization 1 to the KDF 3D workspace, and set file window CAPE Palletization 2 to the shipping case 3D workspace. Click **OK**.

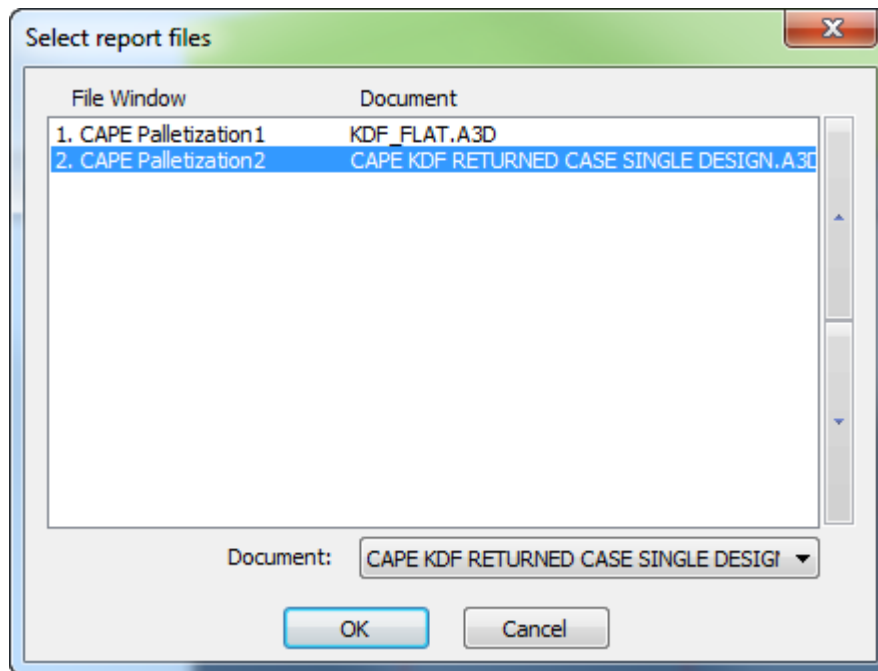

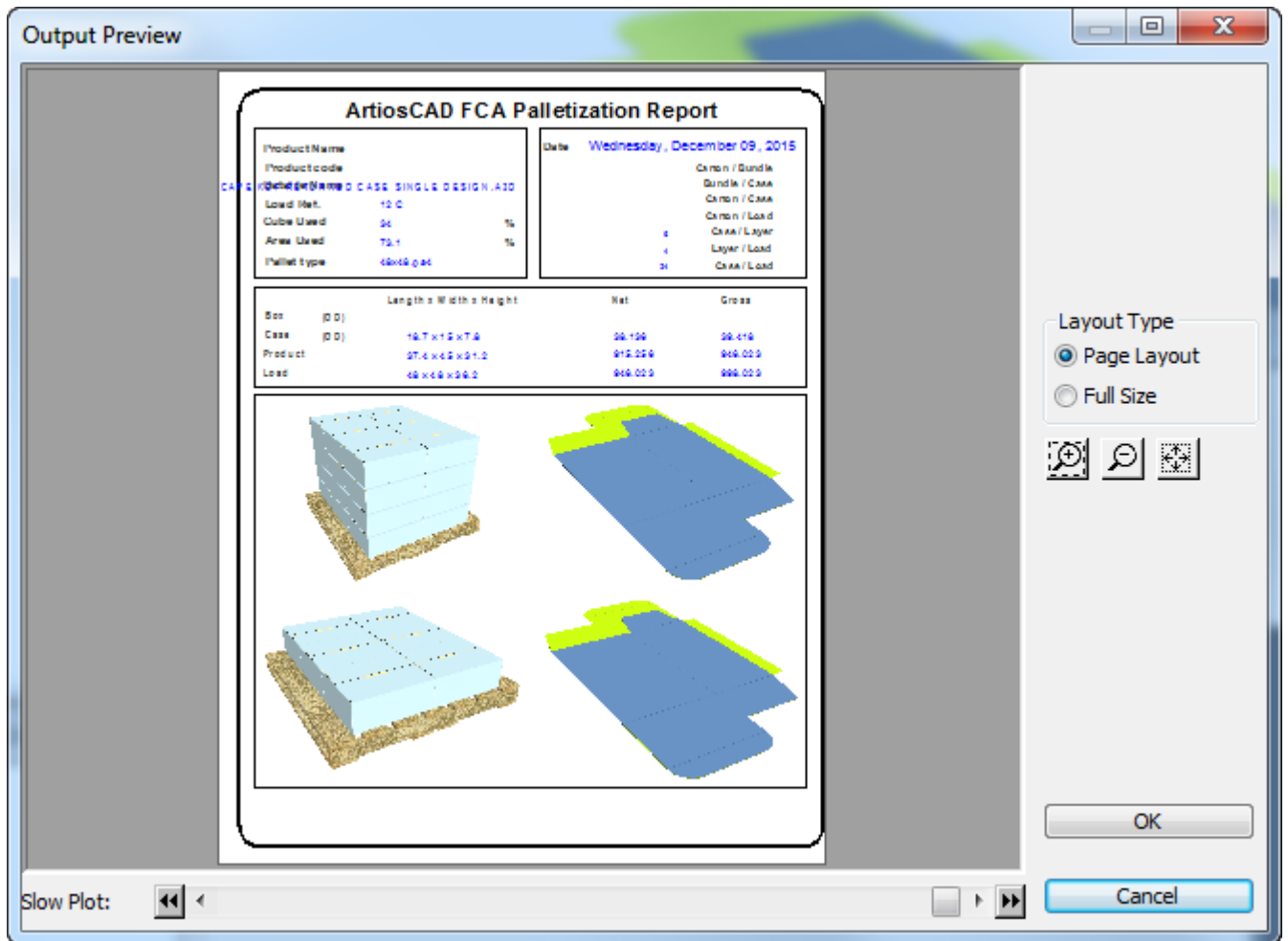

4. Set the options in the Output dialog box as desired and click **OK** to make the Output.

Shown below is the Output preview. On the top left is the full palletized solution. On the bottom left is one layer of the palletized solution. On the top right are the entire contents of the secondary pack. On the bottom right is a single KDF carton.



Example - Using multiple instances of the grain/corrugation direction indicator on a report

A practical use of the conditional symbol functionality is to put a grain/corrugation direction indicator symbol on a report for each file window. To start, do the following:

1. Create a new Single Design file and decide how many designs will be on the report.
2.  Use the **Report Size** tool to set the size of the report based on the output device.
3.  Use the **File Window** tool to make twice the number of File Windows as decided on in step 1, e.g. if there will be three designs on the report, make six File Windows. Make large windows for the designs and small windows for the direction indicators.
4. Double-click each small window to invoke its Properties page. Three things need changing in the Properties page for each small window - the file type, the file number, and the contents of the Case expression group.
 - Change the File Type to **Symbol**.

- Change the file number to match its corresponding Design window. This means that the Symbol window for Design 1 should have a file number of 1, the Symbol window for Design 2 should have a file number of 2, and the Symbol window for Design 3 should have a file number of 3.
- Select **Symbol file depends on case**.
- Click **Add Case**. In the **Case expression** field, enter **GRAIN=1**. Click the ... button at the end of the **Symbol file** field to browse for the symbol file. Navigate to the InstLib directory of your ArtiosCAD installation and choose GRAINVER.ARD.
- Select the OTHERWISE case. Click the ... button at the end of the **Symbol file** field to browse for the symbol file. Navigate to the InstLib directory of your ArtiosCAD installation and choose GRAINHOR.ARD.

After repeating this step for each Symbol file window, the Properties dialog box for each Symbol file window should look similar to the one shown below, except each window will have a different number in the **File number** field.

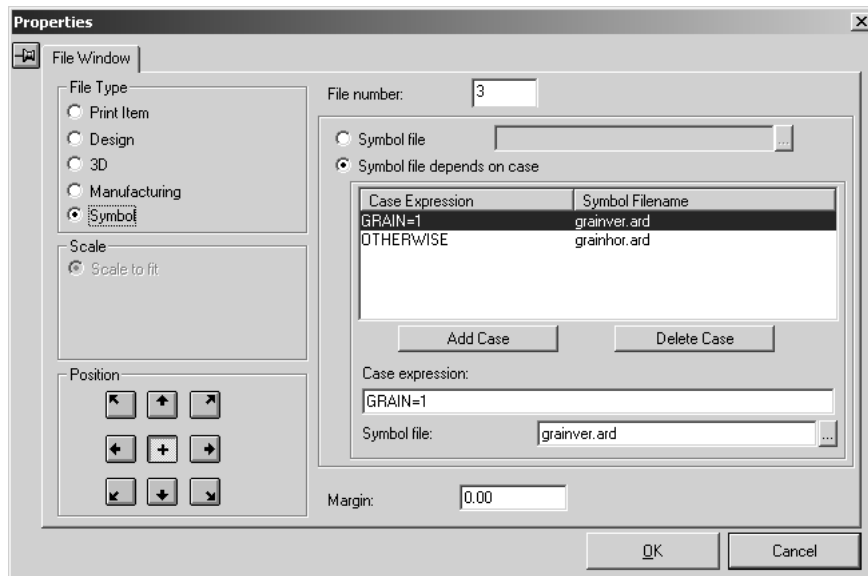

5. Make any other desired changes to the report - adding text, a logo, and so on. Shown below is the form in the design stage

Meeber Box Company		
DesignName LEN x WID x DEP	DesignName LEN x WID x DEP	DesignName LEN x WID x DEP
Design 1	Design 2	Design 3
Symbol	Symbol	Symbol

- Save the report, add it to the Report Catalog, and create an Output for it. When you run it with three designs open, the output will be similar to the picture below.

Meeber Box Company		
MBC_92800_NIELDS.ARD 100 mm x 75 mm x 100 mm	MBC_92800_EFO.ARD 130 mm x 25 mm x 130 mm	MBC_92800_FRUVOUS.ARD 50 mm x 50 mm x 50 mm

Bill of Materials Reports for Projects

ArtiosCAD can create Bill of Materials Reports, or BOM Reports. BOM Reports list different designs that make up a Project. Shown below are the first pages of two example BOM Reports run against the same Project.

ArtiosCAD BOM 11/08/2008 14:01:16
 Project: 2008-11-08001 Manager: Katryna Foster
 Customer: Plastic Angel* Sales: Nerissa Ghomeshi
 Notes: Cumulative project for November's work

05_2496.ARD # Req'd: 3
 Description: Database configuration testing
 Material: 200 # C Kraft # Colors:
 Notes1:
 Notes2:
 Size: 26*518*35*718 Wght:0 Rule: 337.40* Cost(\$):

2496 CREAM TUBE* # Req'd: 5
 Description: Cream tube holder
 Material: 1-SBS-16 # Colors:
 Notes1:
 Notes2:
 Size: 6*16*32*8*112 Wght: 64 Rule: 70.539 Cost(\$):

3X05_2496.ARD # Req'd: 1
 Description: Database configuration testing
 Material: 200 # C Kraft # Colors:
 Notes1:
 Notes2:
 Size: 84*314*35*718 Wght:0 Rule: 1012.2* Cost(\$):

ANGEL1 WITH INSIDE AND* # Req'd: 0
 Description:
 Material: 200 # C Kraft, US # Colors:
 Notes1:
 Notes2:
 Size: 22*111*16*18* Wght:0 Rule: 218.43* Cost(\$):

ArtiosCAD BOM 11/08/2008 14:03:27
 Project: 2008-11-08001 Manager: Katryna Foster
 Customer: Plastic Angel* Salesperson: Nerissa Ghomeshi

Name	Print Item	Cnt	Weight	Area	Rule	Comments
1. 05_2496	Green	3	0	955.17	337.41	
2. 2496 CREAM TUBE*	2496 CREAM TUBE HOLDER.ARD	5	0.02	61.45	70.54	
3. 3X05_2496	3X05_2496.ARD	1	0	3040.41	1012.23	
4. ANGEL1 WITH INSIDE AND*	ANGEL1 WITH INSIDE AND*	0	0	426.81	218.43	
5. ANGEL1	ANGEL1.ARD	1	0	426.81	218.43	
6. ANGEL2 SMALL*	ANGEL2 SMALL WRAPAROUND.ARD	1	0.16	196.08	112.52	
7. ANGEL3 LARGE*	ANGEL3 LARGE WRAPAROUND.ARD	1	0.85	1374.57	355.00	
8. ANGEL5 CENTER*	ANGEL5 CENTER WRAPAROUND*	1	0.89	1103.48	322.71	
Total Count:		13	2.00	9314.1*	3385.8*	

The basic idea behind using BOM Reports is that you design a Report that repeats information down the page for each individual document in the Project. You can show as much or as little information as you like about the designs. To help show you what is possible, a few example BOM Reports are included in Shared defaults in **Options > Shared defaults > Outputs > Artios > Project Bill of Materials**.

Note:
 BOM Reports do not need to be added to the Report Catalog in Defaults.

The **Project Documents** dialog box and the **Documents** pane of the Project Browser are where you configure the order and quantity in which the designs will appear on BOM Reports.

To run an existing Output against every document in a Project, simply check **Project-Bill of Materials** in the **Show in** group on its Properties dialog box in Defaults. When it is time to run that Output, select it from the **Projects > Bill of Materials** menu instead of the **Outputs** menu.

Using an example BOM Report

Note:
 To use most of the example BOM Reports, you must have the PDF option installed on your system.

ArtiosCAD ships with several example BOM Reports on the **Projects > Bill of Materials** menu. Note that BOM Reports **do not** appear in **File > Outputs**.

- Bill of materials PDF
- Bill of materials summary table PDF
- MultiPage PDF
- Project XLS

- **Bill of materials PDF** and **Bill of materials summary table PDF** are the two BOM reports shown in the previous section.
- **Multipage PDF** prints each Project document to a separate page of a PDF file.
- **Project XLS** exports Project data to a Visual Basic script file which is then used to create an .XLS file. If you have Microsoft Excel on your system, it automatically opens the .XLS file as a spreadsheet. If you are interested in changing this Report, contact the System Integration team at your local Esko office.

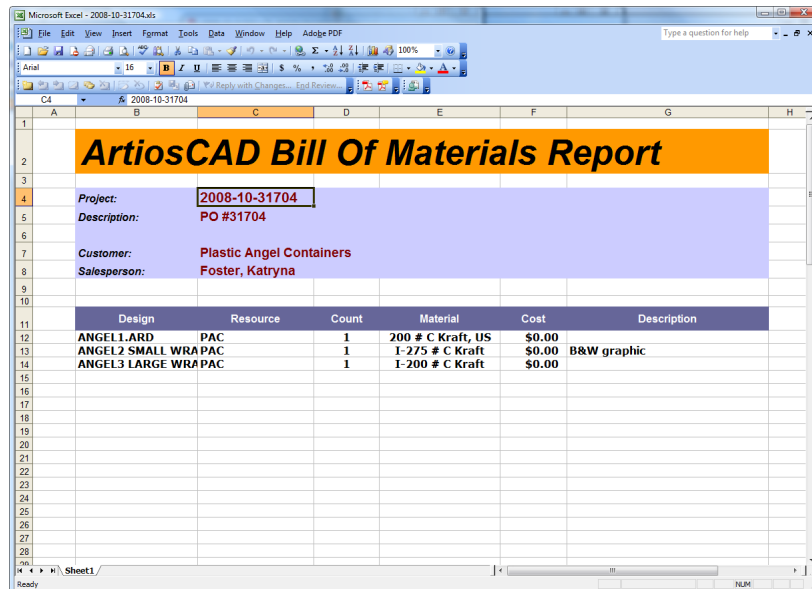

Configuring Project documents before using a BOM Report

Before you Output a BOM Report, use the **Project Documents** dialog box to set up which documents in the Project will appear on the BOM Report, the order in which they will appear, and the quantity of each component required by the Project as a whole.

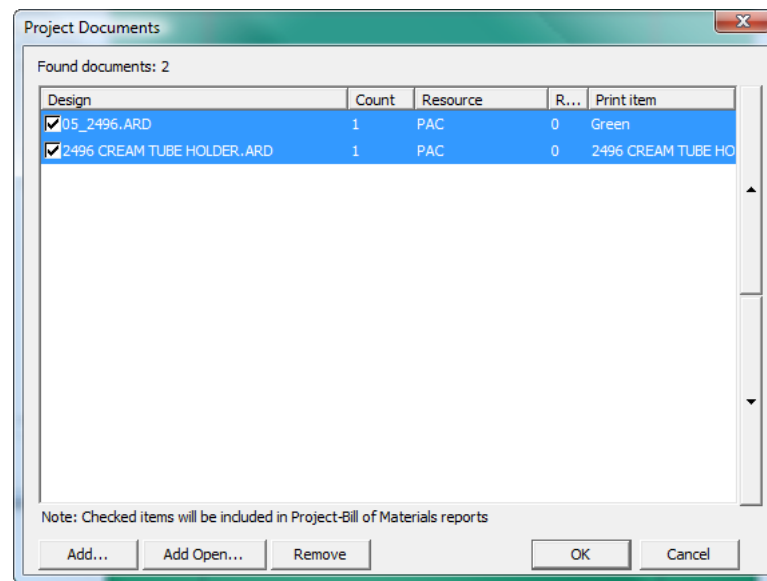

To configure the documents before running the BOM Report, do the following:

1. Create a new Project and add documents to it, or open an existing Project.
2. Click **Projects > Project Documents**.
3. To include a document on the BOM Report, check the checkbox to the left of its name in the **Design** column. To omit the document from the BOM Report, clear the checkbox.
4. Change the number in the **Count** column using the increment buttons to the number of items represented by the document that are required by the Project as a whole.
5. The documents will appear on the BOM Report in the order they are shown in this dialog box from the top down. To change the position of a document, select it, and then use the up and down arrows at the right edge of the list to change its position.
6. Click **OK** in the **Project Documents** dialog box to return to ArtiosCAD.

Outputting a BOM Report

To Output a BOM Report, do the following:

1. Create a new Project and add documents to it or open an existing Project.
2. Configure the presence, the order, and the count of the documents on the BOM Report using the **Project Documents** dialog box as explained previously.
3. Click **Projects > Bill of Materials** and click the BOM Report to Output.
4. If there is a **Properties** dialog box for this BOM Report, set the options as desired and click **OK**.
5. ArtiosCAD Outputs the chosen BOM Report.

Creating a BOM Report

Creating a BOM Report is just like creating a regular Report, except you define a special area called the **Bill of Materials table** and you do not have to add the Report to the Report Catalog when done. Note that your system must have the Reportmaker option in order for you to create new Reports.

Before you create your own BOM Reports, open the example ones (..\InstLib\BOMReport.ARD and ..\InstLib\BOMTABLEREPORT.ARD) to see how they work. You may modify these as desired, but save the modified versions to ..\ServerLib.

The steps below describe the general procedure for creating a BOM Report.

1. Start ArtiosCAD and create a new single design.
2. Using the tools on the Reportmaker and Geometry toolbars, define the report size and draw lines to separate areas on the form as desired.
3. Create a File Window that will be the main repeating area of the BOM Report, and double-click it after you have created it to open its **Properties** dialog box.
4. Change the **File Type** to **Bill of Materials Table**.
5. If desired, leave space for a header and a footer by checking **Header Row** and **Footer Row**, respectively. Set their sizes as desired as well as the pages on which they will be shown.

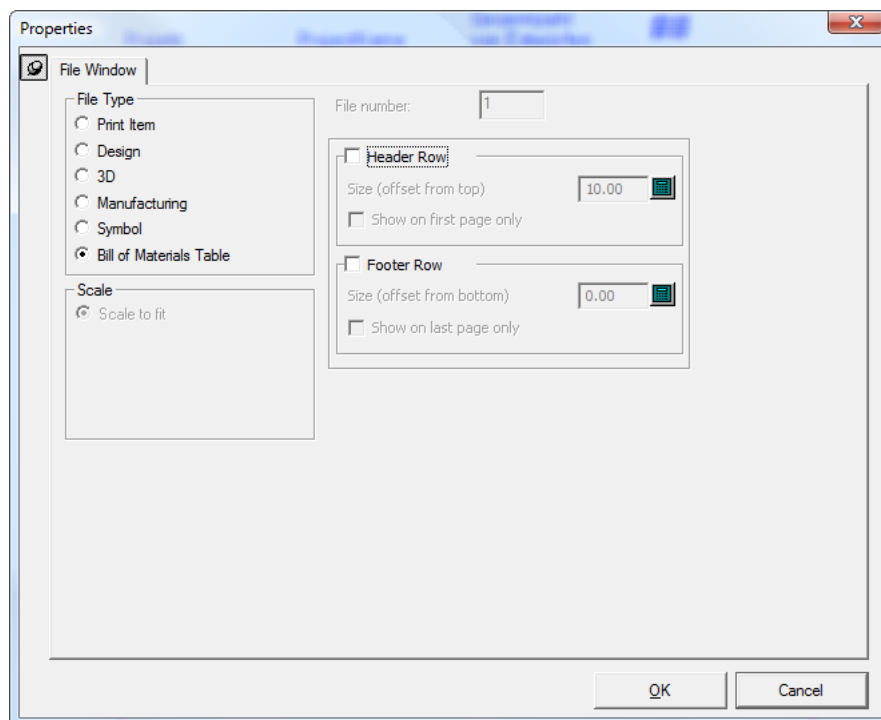

6. Click **OK** to close the dialog box. Shown below is an example of a possible BOM Report in mid-construction.

Plastikengels-Behälter			
Projekt:	ProjectName	Gesamtzahl von Entwürfen	##
Datum verursacht	mm/dd/yyyy	Today's-Datum	DD/MM/YY
Manager:	First LastManager		

Bill of Materials Table

- Next, define the actual repeating File Window that will show the information about each document in the Project. Create a template small enough to be repeated down the page several times, and fill it with a File Window and the desired static and calculated text. Prompted text is not available for BOM Reports. Note that design lines will only be drawn on parts of the Report that are repeated. Use Form Lines 1 and Form Lines 2 linetypes to draw lines in the BOM Table window in non-repeated areas (for example, table column separators that go all the way down the page even if there aren't repeated rows of the table).

Plastikengels-Behälter			
Projekt:	ProjectName	Gesamtzahl von Entwürfen	##
Datum verursacht	mm/dd/yyyy	Today's-Datum	DD/MM/YY
Manager:	First LastManager		
<div style="border: 1px solid green; padding: 5px; text-align: center;">Design 1</div>		Dateiname	File_Name.ext
		Beschreibung	Design description
		Material	Board description
		Größe	[L][x W][x D]
<div style="border: 1px solid green; padding: 20px; min-height: 200px;"> <p style="text-align: center;">Bill of Materials Table</p> </div>			

8. Save the BOM Report workspace to ..\ServerLib.

Adding a BOM Report to the Bill of Materials menu

Once you have created a BOM Report and saved it to ..\ServerLib, do the following to add it to the Bill of Materials menu:

1. Start ArtiosCAD if it is not already started.
2. Click **Options > Defaults**, and then expand **Shared defaults > Outputs > Artios > Project Bill of Materials**.
3. Right-click **Project Bill of Materials**, click **New > Data**, and enter the name of the new BOM Report.
4. Double-click the new entry you just created to open its **Properties** dialog box.
5. On the **Output Type** tab, in the **Output Type** group, select **Project-Bill of Materials**, and in the **Shown In** group, select **Project-Bill of Materials**.

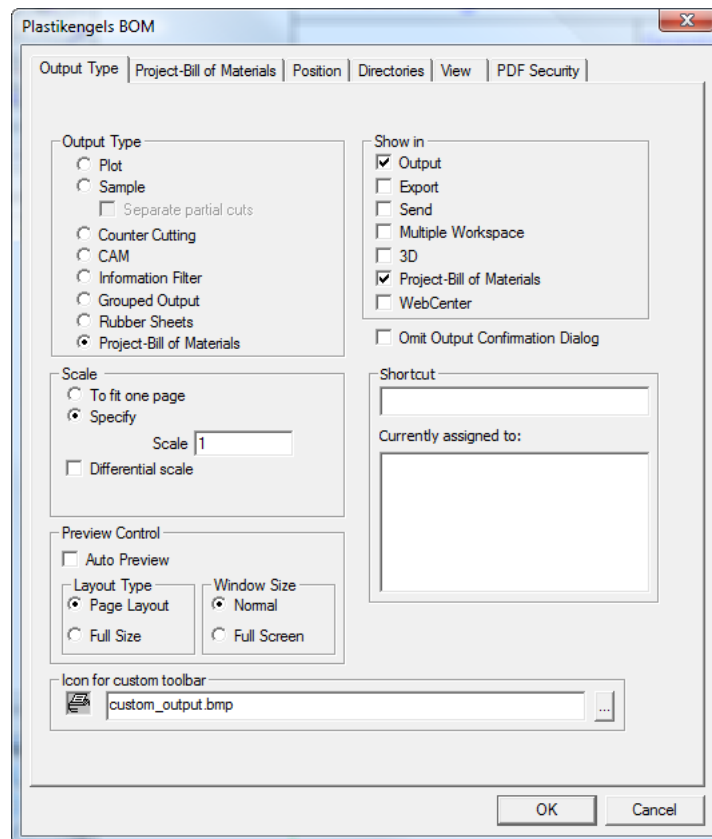

6. On the **Project-Bill of Materials** tab, in the Processing group, choose the destination for the BOM Report. **Windows Driver** generally directs the output to printer; set the options in the **Windows Driver** group as appropriate. **Multipage PDF** creates a PDF file of the Report and requires your system to have the PDF option; select the **Use U3D in 3D file windows** checkbox as desired. **XML** is reserved for use by the Esko Systems Integration group.
7. Still on the **Project-Bill of Materials** tab, in the **Reports** group, click **Add**, navigate to ..\ServerLib, select the workspace for the BOM Report, and click **Open**. If there is another Report you want to run when this BOM Report is run, add it here. If you want the Report to run against every document in the Project, leave its checkbox selected. If you clear its checkbox, it will run only once when this Bill of Materials is run.

When you add a calculated expression from the **Line Type Legend** catalog, you are prompted for the **Line type index** in the Function Parameter dialog box. This is a number that gets incremented by one each time a new line type is added to the workspace being output. When adding the calculated expressions, increment this number by 1 for each row in the legend.



In the second column are the fields for the examples of the rules. These are instances of the **Line Representation** calculated expression.

In the third column are the fields for the lengths of the rules. These are instances of the **Total Line Length** calculated expression.

Line type legend expression properties

The properties of each calculated expression are important as different options can be set in the **Expression** field. The amount of text in the **Sample text:** field sets the length of the field on the screen and on the report.

Line Name expression

When adding a Line Name item, the expression is `LTNAME(line index, ruletype option)`. If you double-click the first example of the name in the Specific Rule legend to view its properties, the expression is `LTNAME(1,2)`. The Line Index was set in the Function Parameter dialog box - but the ruletype option uses a value of 1 by default.

For each line in the Line type index, when the ruletype option is 1, and the rule is a generic rule, the name of that rule in the index is shown using its generic name. For example, the names of 1/2 by 1/2 generic perf and 1/4 by 1/4 generic perf would be combined into one line, Perf.

When the ruletype option is 2, a separate entry is made in the legend for each type of specific rule.

Line Representation expression

As with the Line Name expression, the **Expression** field controls how the calculated expression is displayed on the report. The Expression is in the format `LTLINE(line index, ruletype option)`. The line type index should always increment by one. When the ruletype option is 1, a picture of the generic rule is drawn. When the ruletype option is 2, a picture of the specific rule type is drawn.

Total Rule Length expression

As with the other expressions used to make line type legends, the Total Rule Length expression uses a ruletype option of 1 or 2. When set to 1, the rule length shown by the expression is that of all special rules of that type combined with generic rules of that type. When the ruletype option is set to 2, the length of special rule and generic rule is listed separately.

Line type legend results

Once the legend is configured, when the report is output, the legend should look similar to the one shown below, substituting the line types in the workspace being output.

Specific Rule Legend		Length
Cut		206.135
Crease		165+13/16
Partial cut		8.344
Half crease		16.788
1/2" zipper right		36+3/8

Line and Hatch Legend Output

The **Line and Hatch Legend Report** in **Outputs > Printer Output** shows the single design, some basic information about the design, a Line Type legend, and a Hatch Legend. The Hatch Legend in this Output shows samples of up to 7 hatches used in the workspace. If two hatches have the same name but are functionally different, they are both shown in the legend with the same label. Shown below is the preview of a sample workspace used with the Output. The Hatch Legend is shown at the bottom right.

ArtiosCAD Specification Sheet

Customer: Plastic Angel Containers Design: CONBURYCOOKIESLRG WITH* Description: Cookies die shape for graphics Board: I-SB 5-16	Area: 189.15 6.299 x 3.543 x 5.906 Blank width: 20.236 Blank height: 12.559
--	--

Specific Rule Legend	Length	Hatch Legend
	12.652	
	42.145	
	23.552	
	41.288	

To build a custom Hatch Legend, use the entries in the **Hatch Legend** folder of the Calculated Expressions catalog when creating a Report.



Making a multiple workspace output

You can set up an Output which outputs more than one workspace at a time by checking the Multiple Workspace checkbox in the **Shown in:** group on the Output Type tab of an Output's Properties dialog box. This Output can also be used in the Database browsers.

It has two modes of operation: one when there are workspaces open and one when there are not.

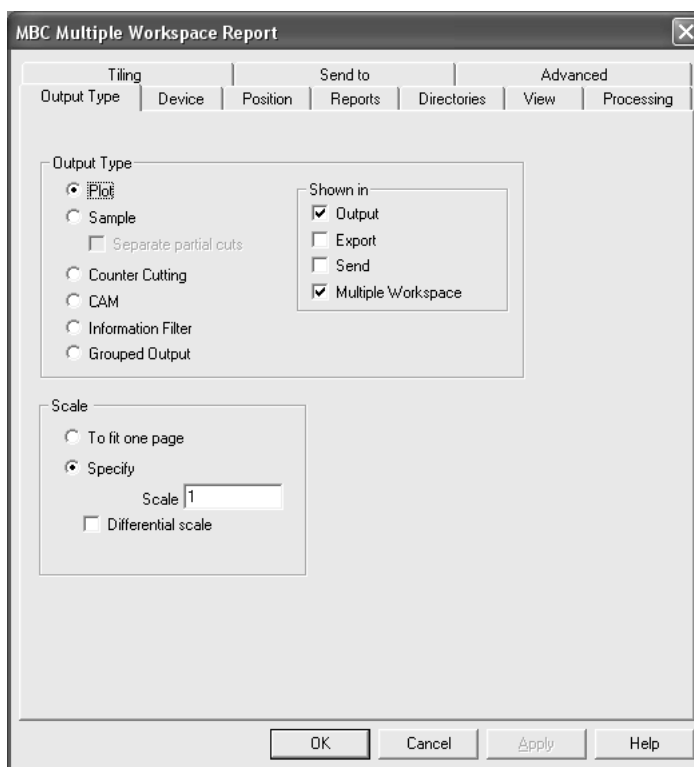

Outputting Multiple Closed Workspaces

To use a Multiple workspace output to output closed workspaces, select it from the **Multiple Workspace** folder in **File > Outputs** and then select the files to use with that output. You must have at least one Output designated as a Multiple Workspace output for the folder to appear on the File menu. Multiple Workspace outputs appear on the File menu when A) a Single Design is open; B) a Manufacturing file is open; or C) when nothing is open.

To create and run a Multiple Workspace output on closed workspaces, do the following:

1. Create a Report and configure an Output for it in Defaults, making sure to select the **Multiple Workspace** checkbox on the Output Type tab of its Properties dialog box.
2. Save and exit Defaults.
3. Click **File > Multiple Workspaces > Your output name**.

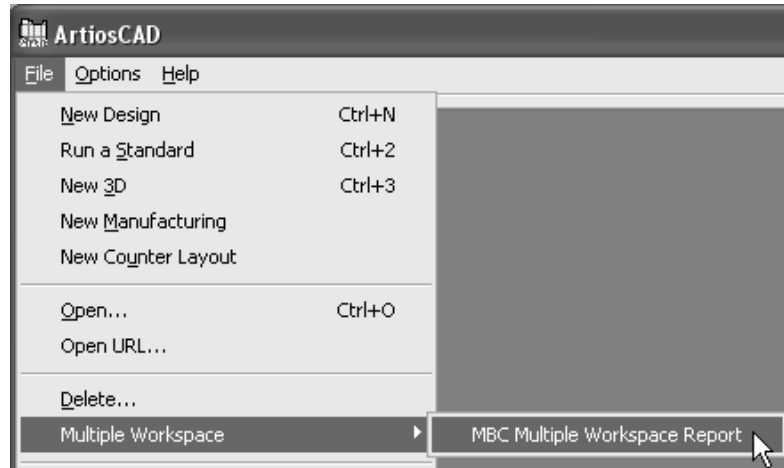

4. Using the **Directory View** in the Open dialog box, select the files to output by holding down CTRL and clicking their names. Click **Open** when you are done selecting files.

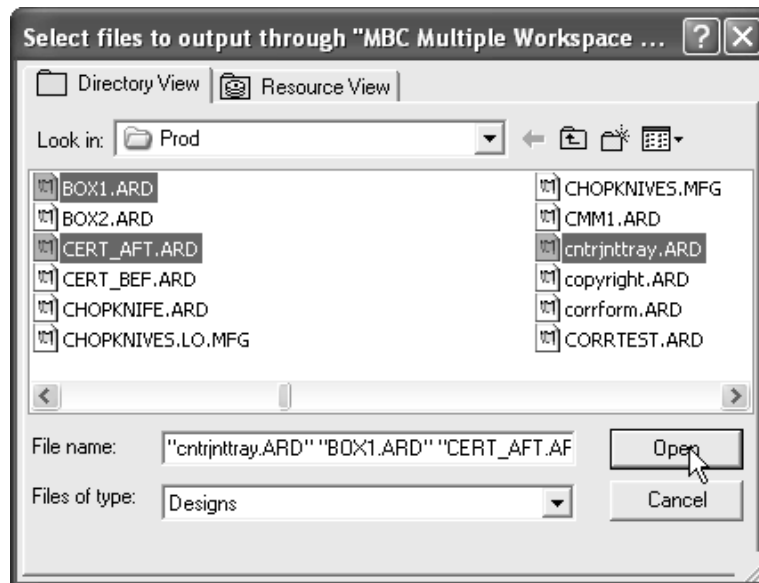

5. As each workspace is output, its path and name will appear in a dialog box.

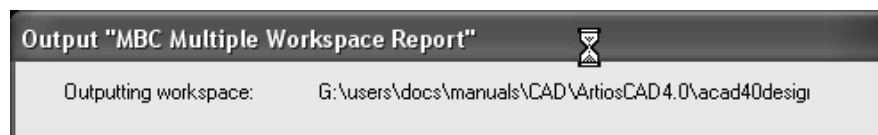

Outputting Multiple Open Workspaces

The process for creating an Output for use for multiple open workspaces is the same as creating one for closed workspaces: in the Output definition in Defaults, check **Multiple Workspace** in the Show in group on the Output Type tab. Running the output, however, is different.

Note: Outputting multiple open workspaces works only for regular Outputs of single designs and manufacturing workspaces. It does not support 3D Outputs.

Note: If you are making a file Output, clear **Automatically Open** in the Output File Options group on the Directories tab of the Output definition to prevent the multiple outputted files from opening in their native applications.

To run a Multiple Workspace Output on open workspaces, do the following:

1. Open all the workspaces to Output.
2. Click **File > Multiple Workspace > Your output name**.
3. In the Select Files for Output dialog box, all the open files are automatically selected. Deselect one by clearing its checkbox. Select or deselect all of them by checking or clearing **Select All**.

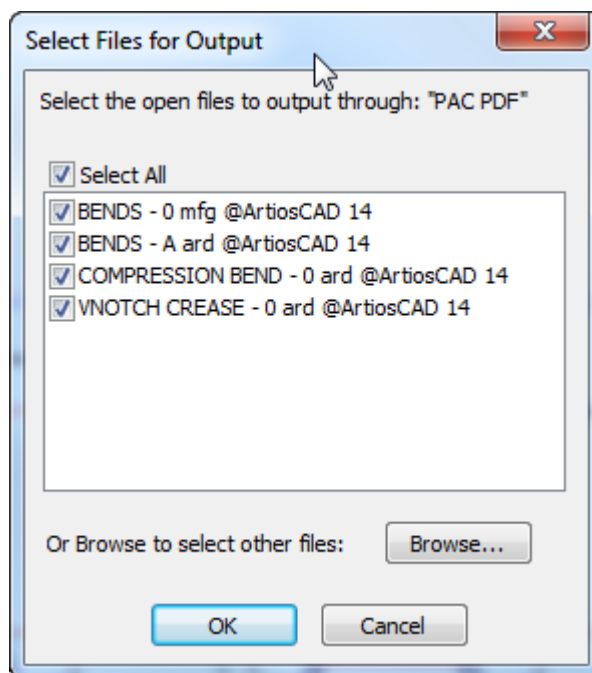

To select only closed workspaces, click **Browse**.

4. Click **OK** to Output the workspaces.

Palletization integration

You can create palletized solutions directly from layouts. Cape Pack and TOPS Pro have been enhanced by their developers to take advantage of this.

Note:

You must have Cape Pack v2.09 or TOPS Pro v6.503 or newer installed on your system to use the palletization features. They can use either client/server or workstation/standalone mode.

Note:

Set the Cape Pack/TOPS Defaults before using any palletization features. See the *Defaults* chapter for more information.

Creating a new CAPE/TOPS palletization solution

Before creating a new palletization solution, create and save the single design(s) to use in it, then do the following:

1. In ArtiosCAD, click **File > New > Palletization**.
2. Select the pallet to use from the list shown in the **Select Pallet** dialog box and click **OK**. ArtiosCAD extracts the list of pallets from CAPE/TOPS.
3. Use the **Add Oneup** tool to add the single designs to the layout.
4. Use the **Nest** tools to arrange the single designs.
5. Click **Palletization > Output to CAPE/TOPS**. CAPE/TOPS must not already be running; if it is, ArtiosCAD will prompt you to close it and try again.

The Output dialog box will appear showing a preview of how the pallet might look in CAPE/TOPS. CAPE/TOPS may show the pallet differently than ArtiosCAD depending on the orientation of the longer dimension and other factors. Shown below is a stripped pallet.

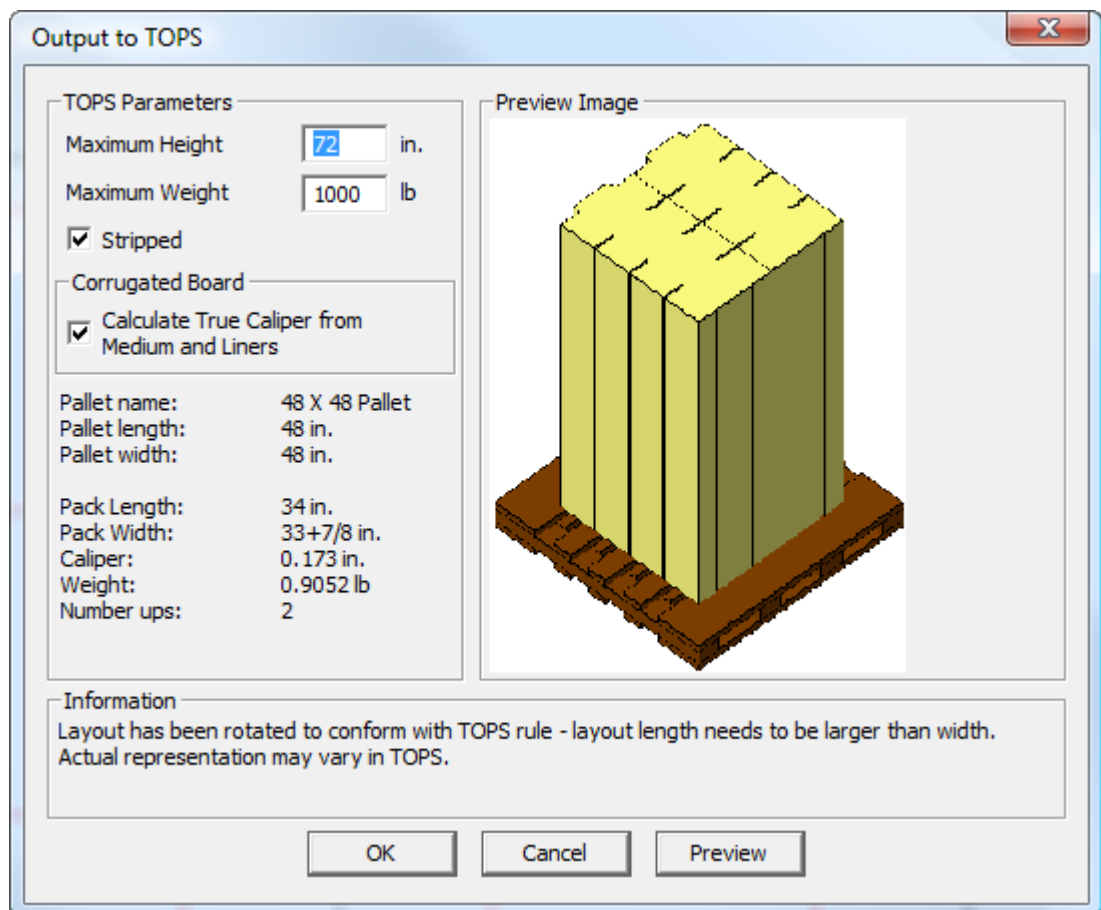
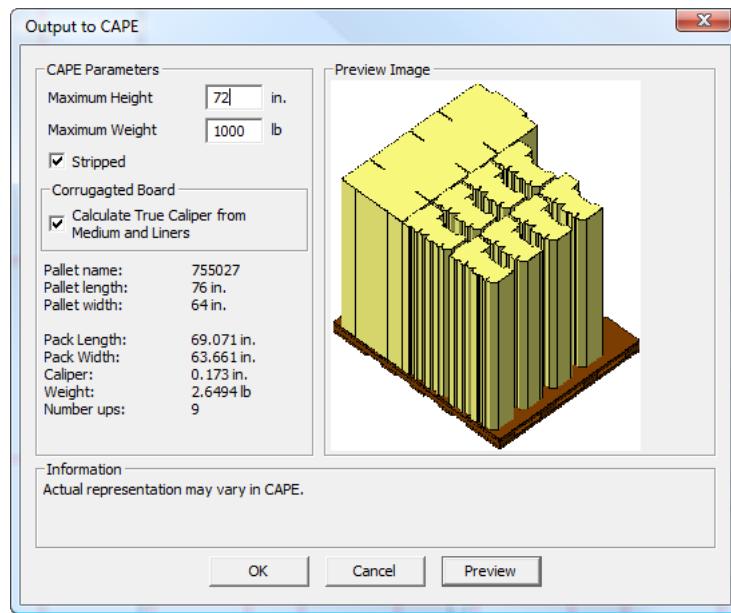

6. In the **Output to CAPE/TOPS** dialog box:
 - a) Set the **Maximum Height** and **Maximum Weight** fields with appropriate values.

- b) To have only the cartons and not the cartons and the waste appear on the pallet, check the **Stripped** checkbox. When this checkbox is selected, stacks of the carton are shown in the preview and in CAPE PACK, as in the example above. When this checkbox is not selected, just the flat top-down view is shown in the preview and in CAPE PACK.
 - c) Set the **Calculate True Caliper from Medium and Liners** checkbox to force ArtiosCAD to measure the caliper based on the board components along the flute rather than using the caliper variable. This checkbox is cleared and unavailable for non-corrugated boards.
7. Click **OK** to perform the Output.
 CAPE will open showing the solution.

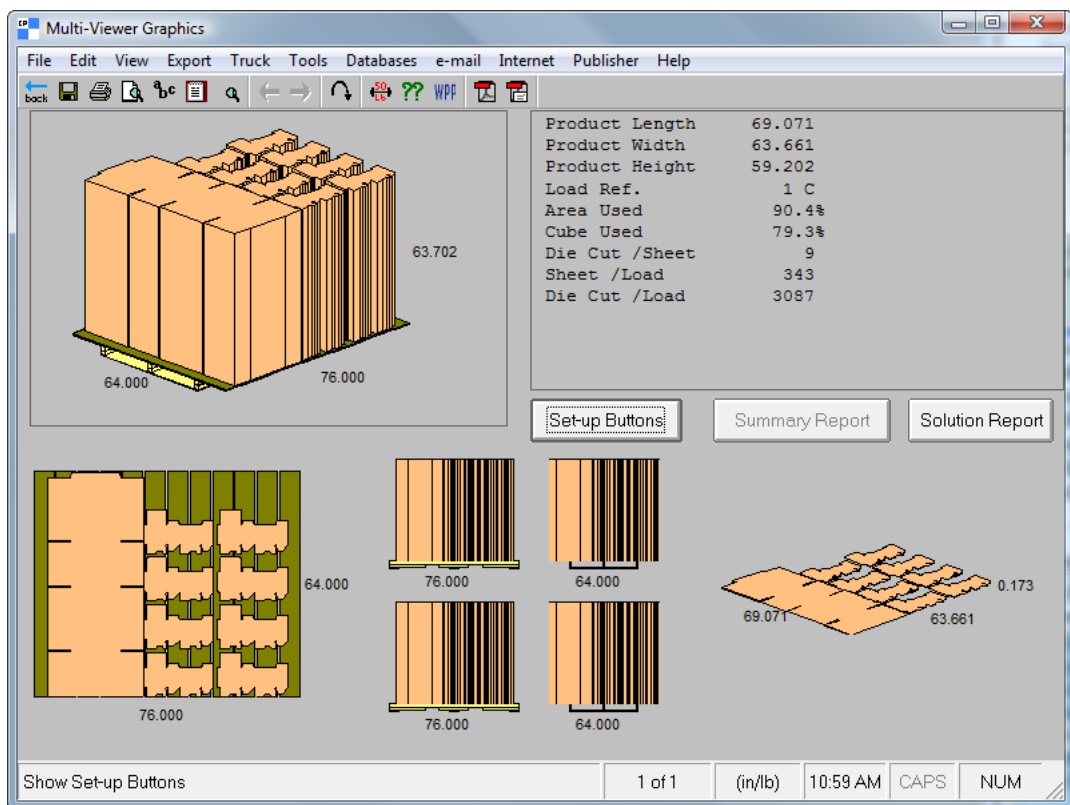

In TOPS, it looks like this:

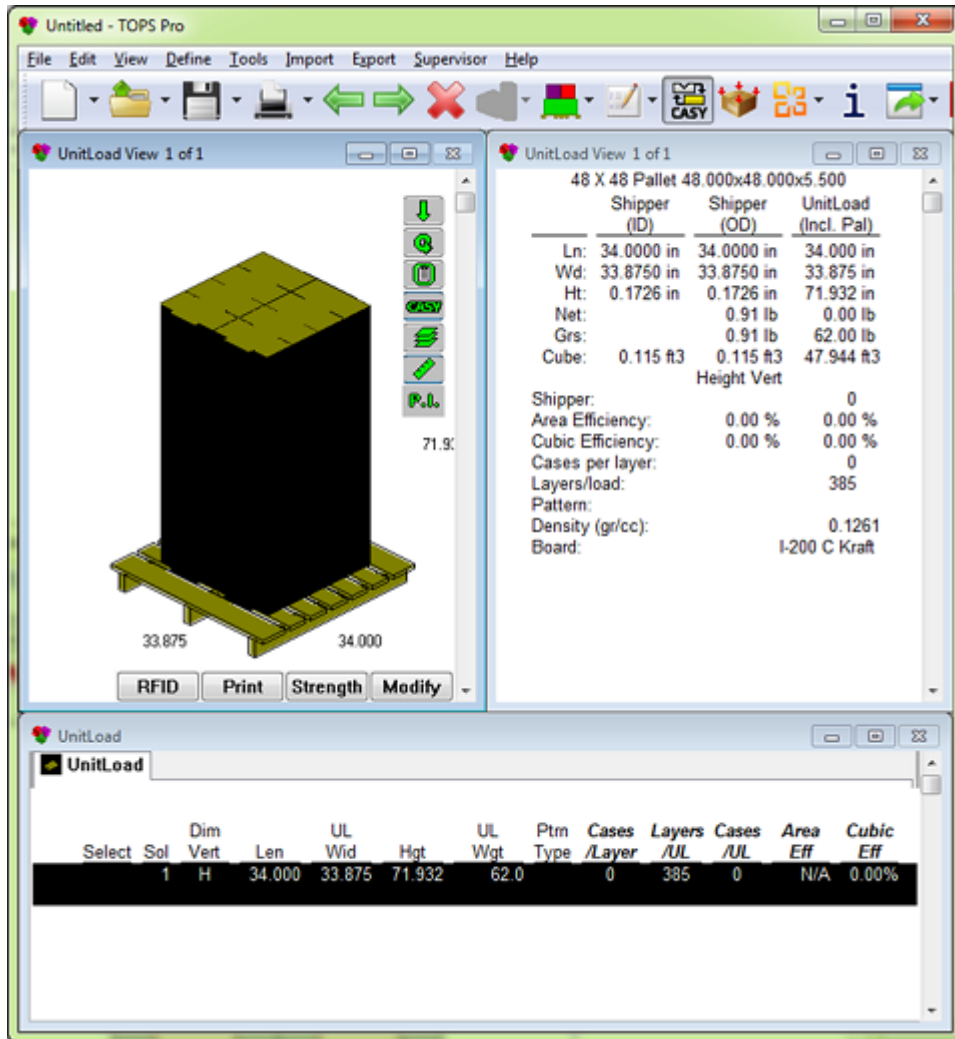

8. Use CAPE/TOPS as desired to complete the palletization solution.

Converting a layout to a CAPE/TOPS palletization solution

To convert a layout to a CAPE/TOPS palletization solution, do the following:

1. Open the layout in ArtiosCAD.
2. Click **Palletization > Output to CAPE/TOPS**.
3. ArtiosCAD will prompt that no pallet is defined. Click **OK** to have ArtiosCAD select the closest matching pallet.
4. In the **Select Pallet** dialog box:
 - a) Select a different pallet if desired.
 - b) Select or deselect the **Stripped** checkbox to control if waste will be on the pallet.
 - c) Select the **Adjust sheet size to match pallet size** checkbox to change the size of the existing sheet to match the pallet.
5. Click **OK** in the **Select Pallet** dialog box to continue.

6. In the **Output to CAPE/TOPS** dialog box:
 - a) Enter the maximum height and weight of the pallet.
 - b) Select or deselect the **Stripped** checkbox.
 - c) Select or deselect the **Calculate True Caliper from Medium and Liners** checkbox (if available).
7. Click **OK** in the **Output to CAPE/TOPS** dialog box to perform the Output.
CAPE/TOPS will open showing the solution.
8. Use CAPE/TOPS as desired to complete the palletization solution.

Changing the pallet in a CAPE/TOPS palletization solution

To change the pallet in a layout that already has been used in a palletization solution, do the following:

1. Open the layout in ArtiosCAD.
2. Click **Palletization > Change Pallet**.
3. In the **Select Pallet** dialog box, select a different pallet. A brown bounding box represents the selected pallet in the drawing area as shown below.

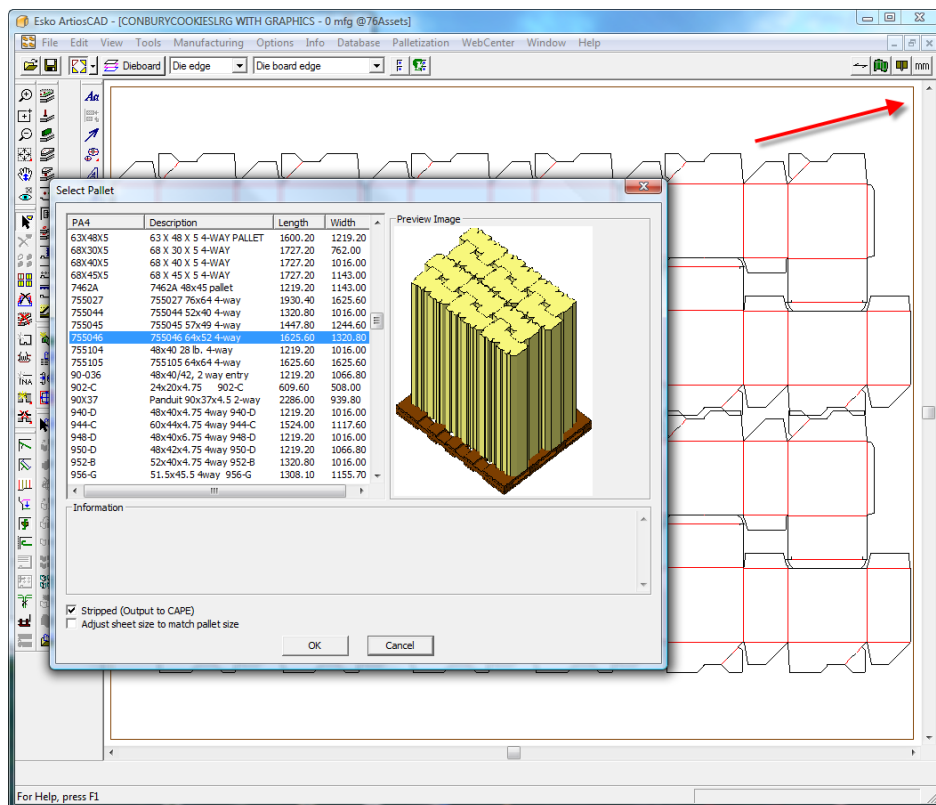

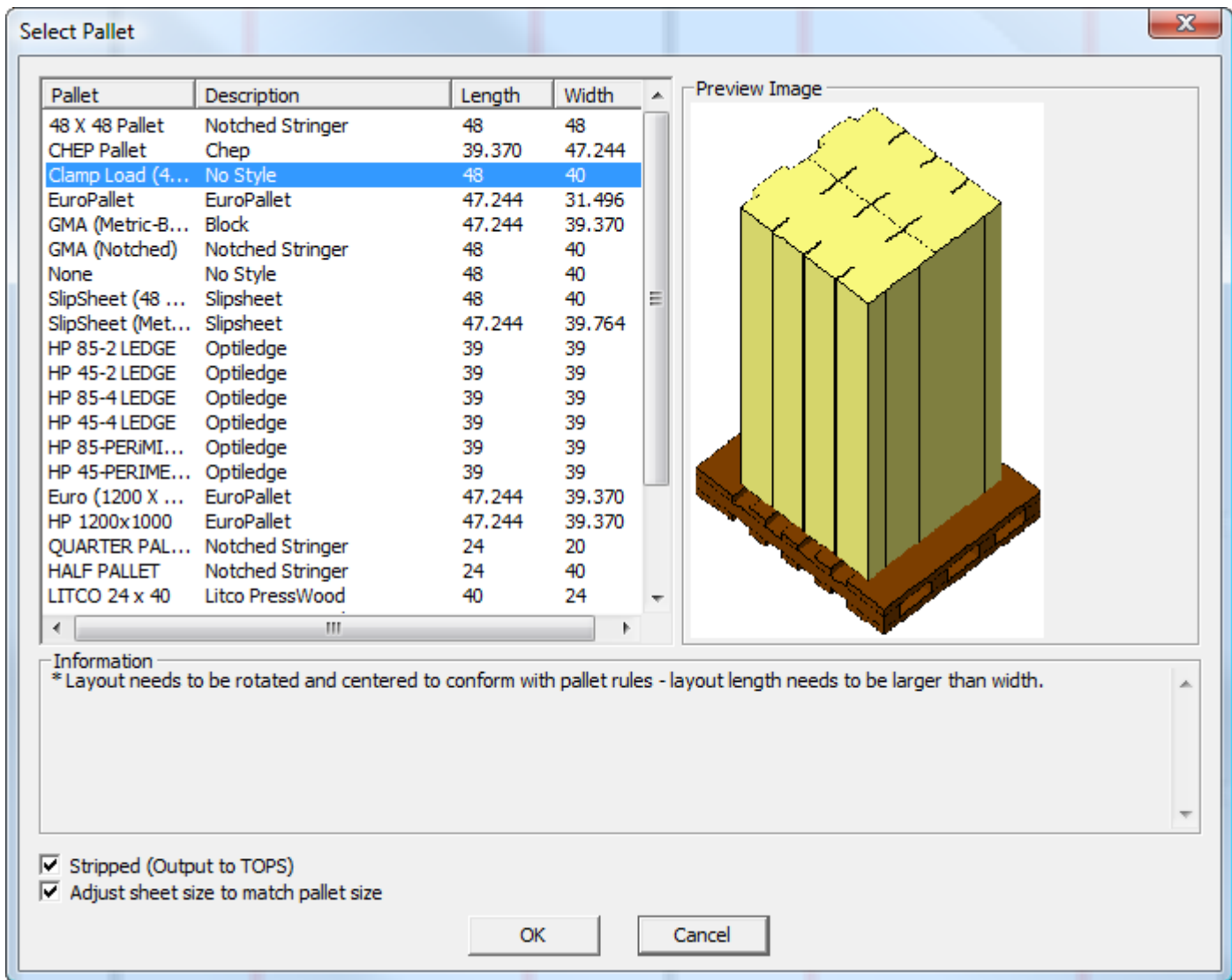

4. Set the **Stripped** and **Adjust sheet size to match pallet size** checkboxes as desired.
5. Click **OK** to make the change.

Palletization FAQ

Question

Why is **OK** unavailable in the CAPE/TOPS Output dialog box after I create a new palletization workspace?

Why does the sheet size keep changing when I change pallets?

Answer

No board information has been defined yet. Either add a design or click **Info > Board Information** and select a board.

Adjust sheet size to match pallet size is selected in the **Select Pallet** dialog box. Deselect it to stop this.

Question	Answer
Why isn't the sheet size changing to match the pallet size when I choose a new pallet?	Adjust sheet size to match pallet size is not selected in the Select Pallet dialog box. Select it to have the sheet size change with the pallet.
Why is Calculate True Caliper from Medium and Liners unavailable?	The current board is not a corrugated board and thus has no medium or liners defined. Change to a corrugated board by clicking Info > Board Information .
Why does the preview look different than my layout?	CAPE/TOPS requires the length of the layout to be greater than the width. ArtiosCAD will rotate the layout by 90 degrees if required to meet this rule.
There's a brown edge when I select a pallet and sometimes the sheet edges vanish. Why?	The brown edge represents the pallet edge. The pallet is placed centered on the layout. When Stripped is selected, only the single designs determine the pallet placement and the sheet edges are not shown. When Stripped is not selected, both the single designs and the sheet edge determine the pallet placement.
What are the brown and purple lines in the preview?	When Stripped is not selected, the brown lines are the pallet edge, and the purple lines are the sheet edges which are not output to CAPE/TOPS.
My layout has an overhang; why isn't it showing?	CAPE/TOPS handles overhangs differently from ArtiosCAD as everything is centered on the pallet. An uneven overhang will be recalculated. Also, if the blank is smaller than the pallet, there will be no overhang in CAPE/TOPS.
I made my layout the way I want it and CAPE/TOPS is nesting it differently. Why?	CAPE/TOPS maximizes the pallet usage and thus may re-nest the layout if either the blank width or height are less than half of the pallet width or height.
How does ArtiosCAD calculate the inside dimensions from CAPE/TOPS dimensions?	ArtiosCAD uses the inside dimensions to build a design, while CAPE/TOPS can use either inside dimensions plus the caliper or outside dimensions. If CAPE/TOPS specifies inside dimensions, so does ArtiosCAD. If CAPE specifies outside dimensions, the package type defines the number of folds along length/width/height and ArtiosCAD subtracts these folds (times the board caliper) along each side to calculate the inside dimensions.
A design in ArtiosCAD is not the same size when I convert it to 3D even though the inside dimensions and caliper match.	ArtiosCAD's outside dimensions on a standard may not always match those from CAPE/TOPS due to the use of inside loss and outside gain causing bulges on folds.
Why do I have to reselect a board when I have mapped it properly?	In CAPE/TOPS, most outside dimensions are specified and thus the material thickness is sometimes ignored, in which case it is set to 0.0 with name undefined . There is no material by that name in the CAPE/TOPS mapping table and thus ArtiosCAD does not recognize it. All

Question

Answer

ArtiosCAD designs must have a board code and inside dimensions, and to set the inside dimensions properly from CAPE's/TOPS' outside dimensions, you may have to reselect the board.

Do I need to fold up my 3D design or will ArtiosCAD do it automatically for me before palletizing it?

You must fold up your designs before palletization so that ArtiosCAD sends the correct size bounding box to CAPE/TOPS.

Can I customize the textures shown on the pallet?

Yes. Put your own versions of palletwood.jpg and palletwoodend.jpg in ClientLib or ServerLib if desired.

I got an error about mismatched package size. What is this?

This is due to the difference between ArtiosCAD's and CAPE's/TOPS' methods for calculating outside dimensions. Generally click **No** if you see this message.

I have done a lot of work in CAPE/TOPS and now I have many designs open in ArtiosCAD. Which one is correct?

They are all correct since you supplied the parameters each time and clicked **File > Export and Exit**. If you only wanted to check the palletization in CAPE/TOPS, click **File > Exit** instead without exporting.

3D Outputs

To output a 3D workspace, click **File > Outputs-3D**.

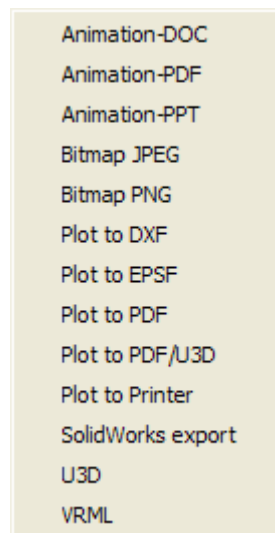

Note: Using any of the Animation outputs requires purchasing the 3D Animation feature. Contact your Esko salesperson for more information about purchasing this option. Using the **Animation-PDF**, **Plot to PDF**, and **Plot to PDF/U3D** outputs require purchasing the PDF option. Contact your Esko salesperson for more information about purchasing this option. Using the **Animation-DOC** output requires Microsoft Word to be installed on your system. Using the **Animation-PPT** output requires Microsoft PowerPoint to be installed on your system. Dimensions are turned off in animation outputs. Using the SolidWorks export output requires purchasing the SolidWorks option.

Outputting a 3D animation as a Microsoft Word document

To output a 3D animation as a Microsoft Word document, do the following:

1. Make sure Microsoft Word is loaded on your system and that the animation is saved and ready for output.
2. Click **File > Outputs-3D > Animation-DOC**. The Animation-DOC dialog box appears as shown below.

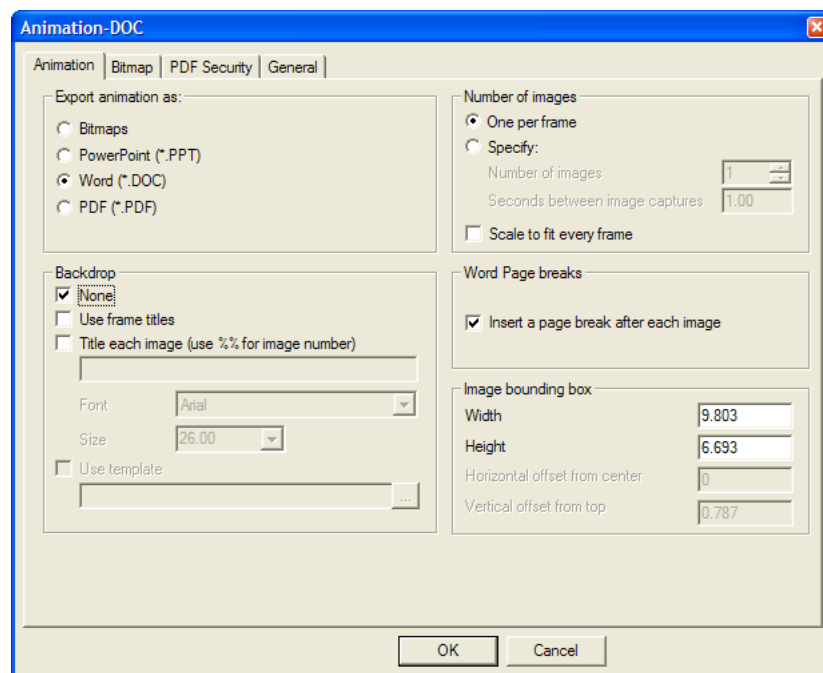

Animation tab

1. On the Animation tab, the options in the **Export animation as:** group control the type of output created. Leave **Word (*.DOC)** selected.

The options in the **Backdrop** group determine what is shown along with the animation. **None** turns off frame titles; to turn off the background image, deselect it in the View Mode dialog box before starting the Output. **Use frame titles** includes the frame titles set for each frame in the Frame Properties dialog box when making the animation. **Title each image** adds a title for each frame if none were defined during creation. Use **%%** to include the image number. Using both title options simultaneously is possible; frames with specific

titles defined in the animation use them, while frames with no title defined use the one specified in the **Title each image** field. **Font** and **Size** set the typeface and size of the title for each frame. **Use template** is not applicable for this output type.

In the **Number of images** group, **One per frame** uses a page of Word document per frame of animation. **Specify** enables the **Number of images:** field, which controls how many animation frames are captured and exported, and **Seconds between image captures:** field, which controls the length of animation playback time between each image capture. Setting a value in one field sets the value in the other field.

Scale to fit every frame scales each frame to fit the output size defined in the **Image bounding box** group regardless of the frame properties set in the animation.

Insert a page break after each image in the **Word Page breaks** group controls whether or not hard page breaks are inserted after each image. When this option is not selected, more than one image per page is possible depending on the size of the bounding box.

The fields in the **Image bounding box** group control the size of the image placed on the page.

Set the options on this tab as desired, and then click the Bitmap tab.

Bitmap tab

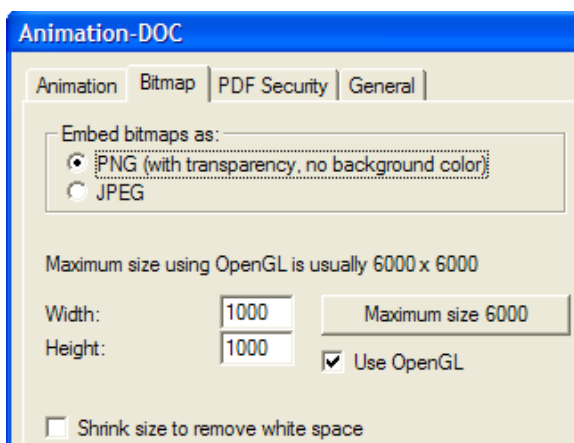

1. The settings on the Bitmap tab control the format of the exported images, their pixel size, and the rendering method used to generate them.

In the **Embed bitmaps as:** group, choose either **PNG** (Portable Network Graphics) or **JPEG** (Joint Photographic Experts Group) format. PNGs ignore background color and support alpha channel transparency, which can improve their appearance in programs that support alpha transparency.

JPEGs support quality settings via the **Quality** field, with 1 being lowest quality and smallest image file size and 100 being highest quality and largest image file size. JPEGs support background color but do not support transparency.

The maximum bitmap size using Direct3D is different for each display adapter. The **Width:** and **Height:** fields all set the number of pixels that in total determine the resolution of the exported images. Do not forget to consider the size of the pages in Microsoft Word when setting the pixel size of the images, as the images will be clipped to fit the margins of the page if they are too large. To set the maximum size, click **Maximum size <number>**.

Setting both the **Width:** and the **Height:** to 1000 pixels provides sufficient resolution for most workspaces. Use a higher resolution if the exported animation will be printed, but do not forget that image size is also controlled by the bounding box size set on the Animation tab and must fit on the page in Microsoft Word.

To use OpenGL and thus make higher-resolution images, check the **Use OpenGL** checkbox and change the number of pixels; this option is selected by default. **Shrink size to remove white space** removes the background pixels surrounding the workspace from the exported images, and is automatically selected and disabled if a background image is visible in the workspace.

Set the options on this tab as desired, then click the General tab.

General tab



1. On the General tab are the **Output Directory:** field and the **Automatically Open** checkbox. If you enter a directory in the **Output Directory:** field or use the **Browse** button to specify one, that directory is used by the Save As dialog box when you click **OK**. **Automatically Open** controls whether ArtiosCAD launches Microsoft Word after the Output is done and opens the document.

Finishing the Output

1. Once you have set the options on all the tabs as desired, click **OK**.
2. In the Save As dialog box, choose the directory in which to save the file and enter a filename. Click **Save** to perform the Output. Depending on the state of the **Automatically Open** checkbox, ArtiosCAD may launch Microsoft Word and open the document. Shown below is an example Output.

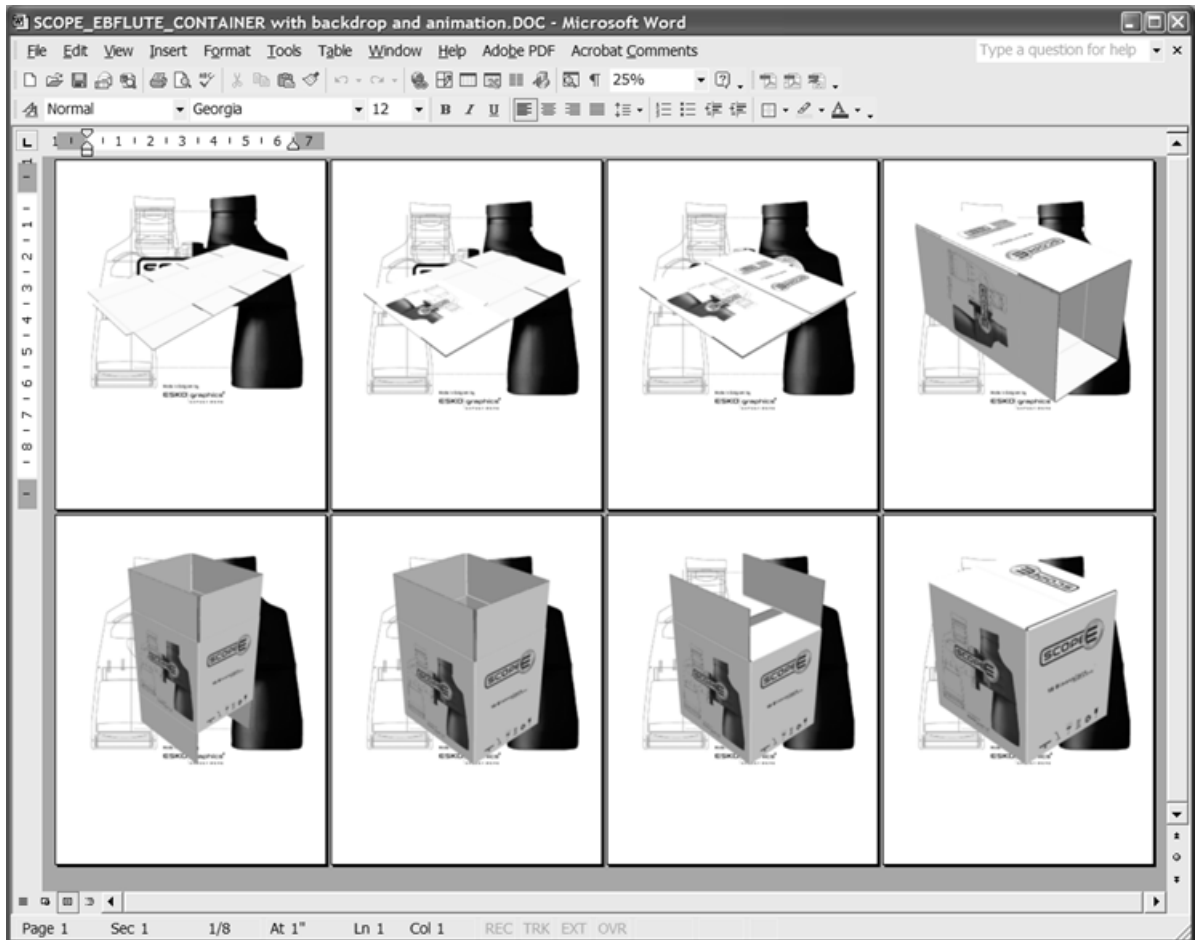

Outputting a 3D animation as a PDF document

Outputting a 3D animation as a PDF document is similar to outputting an animation as a Microsoft Word document. The only differences are on the Animation tab of the Animation-PDF dialog box. Using this Output requires having purchased the PDF option.

To output a 3D animation as a PDF document, do the following:

1. Make sure the animation is saved and that the workspace is ready for output.
2. Click **File > Outputs-3D > Animation-PDF**. The Animation-PDF dialog box appears as shown below.

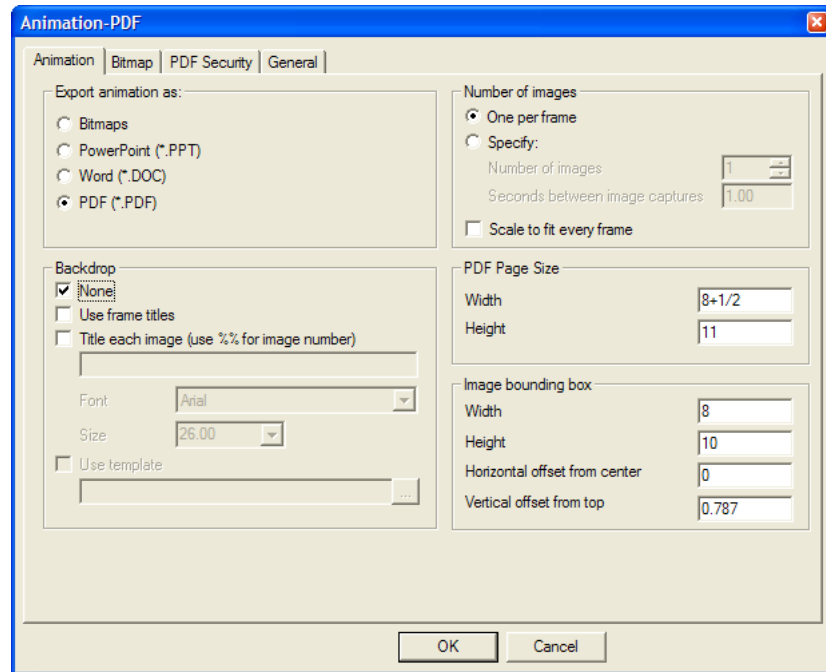

In the **Export animation as:** group, leave **PDF (*.PDF)** selected.

The options in the **Backdrop** and **Number of images** groups work the same way as in the Animation-Doc Output.

The **Width** and **Height** fields in the **PDF Page Size** group set the size of the PDF pages in the outputted file.

The fields in the **Image bounding box** group control the size and placement of the images on the pages; set them as desired. Ensure the bounding box is smaller than the page size to avoid clipping the graphics in the outputted file.

Set the options on this tab as desired.

1. Set the options on the Bitmap, PDF Security, and General tabs as desired, and click **OK**.
2. In the Save As dialog box, choose the directory in which to save the file and enter a filename. Click **Save** to perform the Output. If you have a PDF-viewing utility (such as Adobe Acrobat or Adobe Acrobat Viewer) and the **Automatically Open** checkbox on the General tab was selected at time of Output, the PDF file will be opened automatically as shown below.

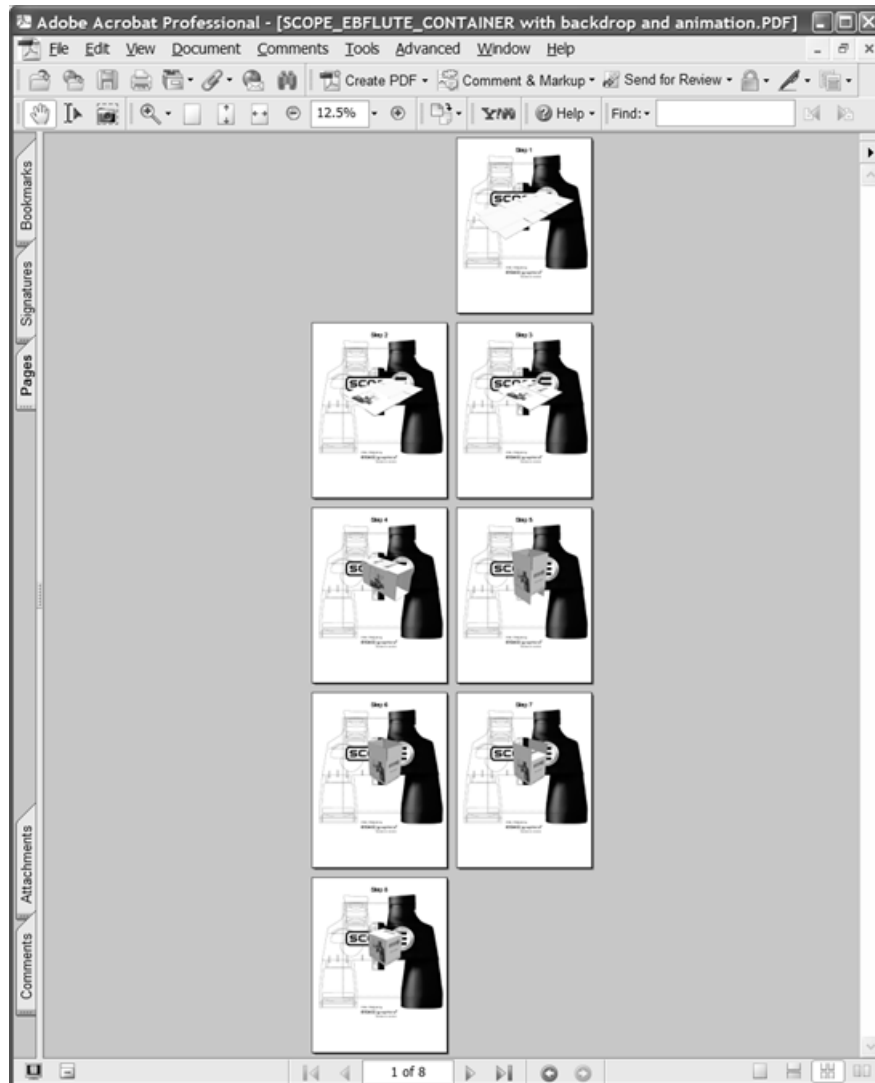

Outputting a 3D animation as a Microsoft PowerPoint document

Outputting a 3D animation as a Microsoft PowerPoint document is similar to outputting an animation as a Microsoft Word or PDF document. The only differences are on the Animation tab of the Animation-PPT dialog box.

To output a 3D animation as a Microsoft PowerPoint document, do the following:

1. Make sure Microsoft PowerPoint is loaded on your system and that the animation with at least 2 frames is saved and ready for output.
2. Click **File > Outputs-3D > Animation-PPT**. The Animation-PPT dialog box appears similar to the one shown below.

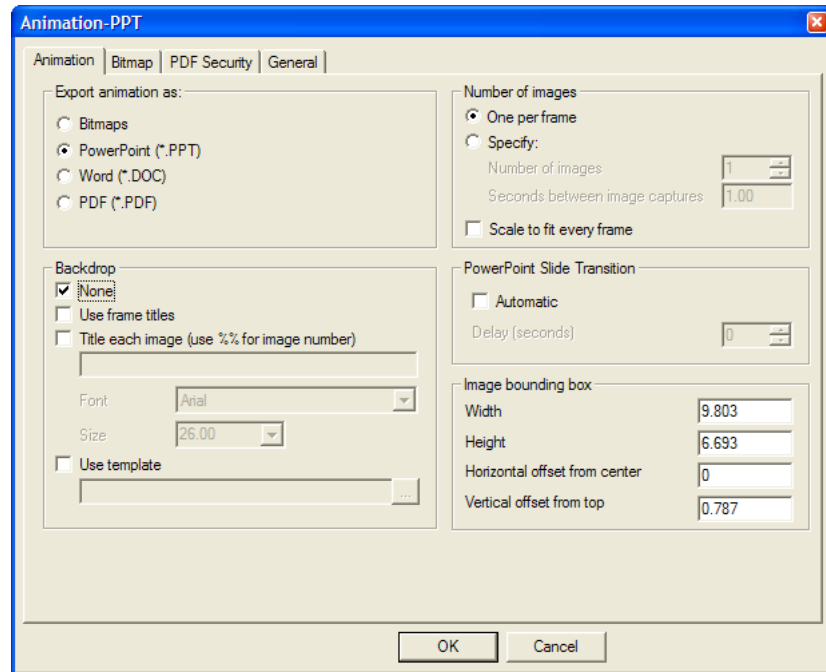

3. In the **Export animation as:** group, leave **PowerPoint (*.PPT)** selected.

The options in the **Backdrop** and **Number of images** groups work the same way as in the Animation-Doc and PDF Outputs. **Use template** lets you specify or browse for a Microsoft PowerPoint template to use instead of having the images placed on a series of blank slides. If you plan to use a template, turning off the background image in the View Mode dialog box before performing the Output may yield more desirable results.

The options in the **PowerPoint Slide Transition** group control if the output file runs as a slide show when opened. Click **Automatic** to have the slides automatically advance using the duration specified in the **Delay (seconds)** field.

The fields in the **Image bounding box** group control the size and placement of the images on the slides; set them as desired. Ensure the bounding box is smaller than the page size to avoid clipping the graphics in the outputted file.

Set the options on this tab as desired.

4. Click the Bitmap and General tabs and set the options on them as desired, and then click **OK**.
5. In the Save As dialog box, choose the directory in which to save the file and enter a filename. Click **Save** to perform the Output. If **Automatically Open** was checked on the General tab, ArtiosCAD will launch Microsoft PowerPoint and open the presentation.

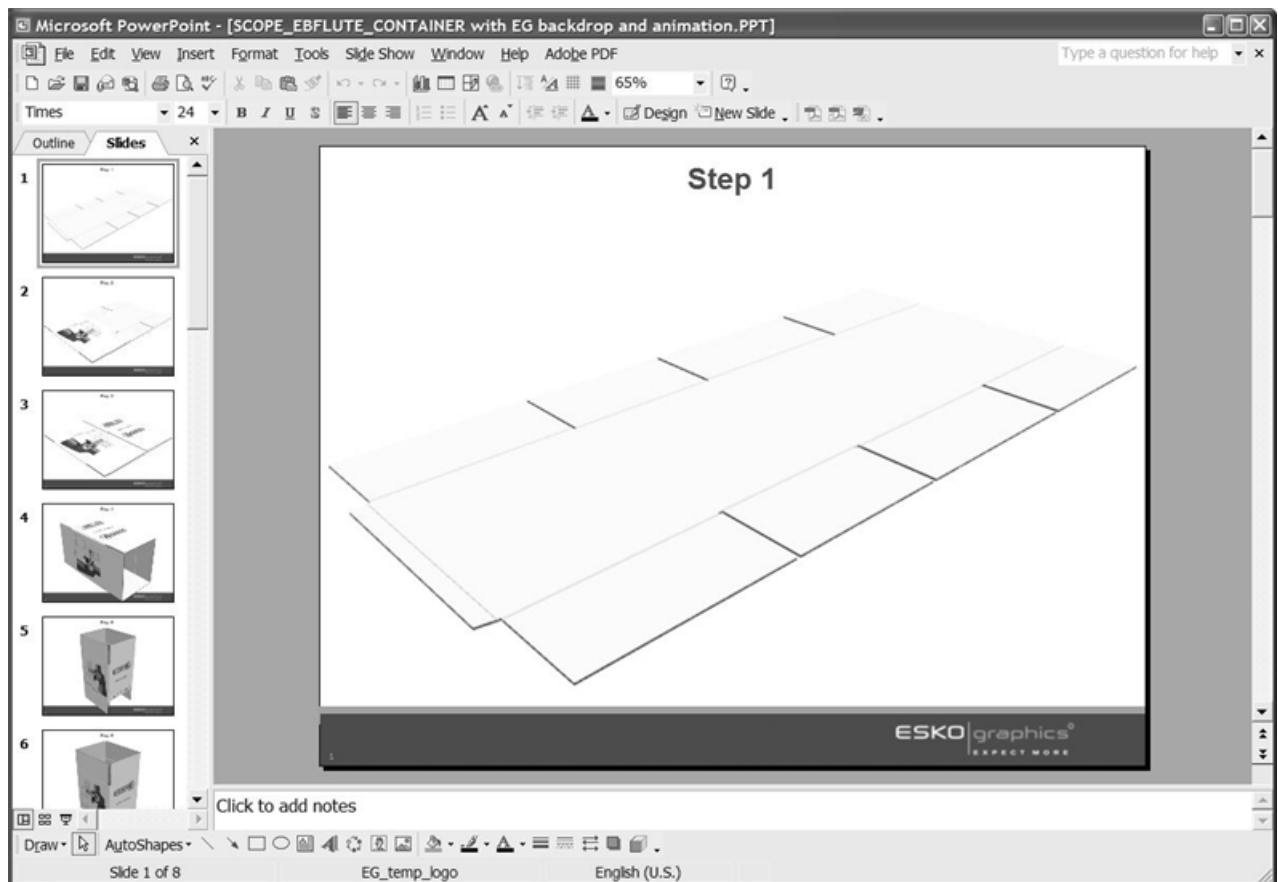

Outputting a 3D workspace as a JPEG or PNG bitmap

To output a 3D workspace or frame of an animation as a bitmap, do the following:

1. Save the workspace and position it as you would like it to appear in the outputted file. If outputting an animation frame, use the **Animation Playback** tool to show the desired frame of the animation.
2. Click **File > Outputs-3D > Bitmap JPEG** or **Bitmap PNG**. The Bitmap JPEG or Bitmap PNG dialog box will appear similar to the one shown below.

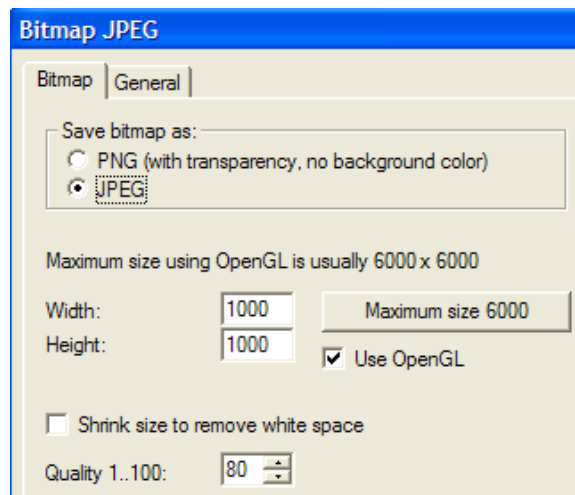

3. The settings on the Bitmap tab control the format of the exported image, its pixel size, and the rendering method used to generate it.

In the **Save bitmaps as:** group, choose either **PNG** (Portable Network Graphics) or **JPEG** (Joint Photographic Experts Group) format. PNGs ignore background color and support alpha channel transparency, which can improve their appearance in programs that support alpha transparency. They are the only Output type which supports the transparency features in ArtiosCAD.

JPEGs support quality settings via the **Quality** field, with 1 being lowest quality and smallest image file size and 100 being highest quality and largest image file size. PNGs do not support a quality setting, so that option is not available when PNG is the selected format. JPEGs support background color but do not support transparency.

The maximum bitmap size using Direct3D is different for each display adapter. The **Width:** and **Height:** fields set the number of pixels that determine the resolution of the exported images. To set the maximum size, click **Maximum size <number>**. Setting both the **Width:** and the **Height:** to 1000 pixels provides sufficient resolution for most workspaces. Use a higher resolution if the exported animation will be printed.

To use OpenGL and thus make higher-resolution images, check the **Use OpenGL** checkbox and change the number of pixels; this option is selected by default. **Shrink size to remove white space** removes the background pixels surrounding the workspace from the outputted image, and is automatically selected and disabled if a background image is visible in the workspace.

Set the options on this tab as desired, then click the General tab.



4. On the General tab are the **Output Directory:** field and the **Automatically Open** checkbox. If you enter a directory in the **Output Directory:** field or use the **Browse** button to specify

one, that directory is used by the Save As dialog box when you click **OK**. **Automatically Open** controls whether ArtiosCAD launches an image viewer after the Output is done and opens the document.

5. In the Save As dialog box, choose the directory in which to save the file and enter a filename, and click **Save** to perform the Output. If **Automatically Open** was checked on the General tab, ArtiosCAD will launch the default image viewer associated with the bitmap file type and show the file.



Outputting a 3D workspace to an EPSF file, PDF file, or printer

The **Plot to EPSF**, **Plot to PDF**, and **Plot to Printer** Outputs in **File > Outputs-3D** all work similarly, just as the animation outputs work similarly.

To perform one of these three Outputs, do the following:

1. Save the workspace and position it as you would like it to appear in the outputted file. If outputting an animation frame, use the **Animation Playback** tool to show the desired frame of the animation.
2. Click **File > Outputs-3D**, then click either **Plot to EPSF**, **Plot to PDF**, or **Plot to Printer**. The Plot to **Choice** dialog box will appear.

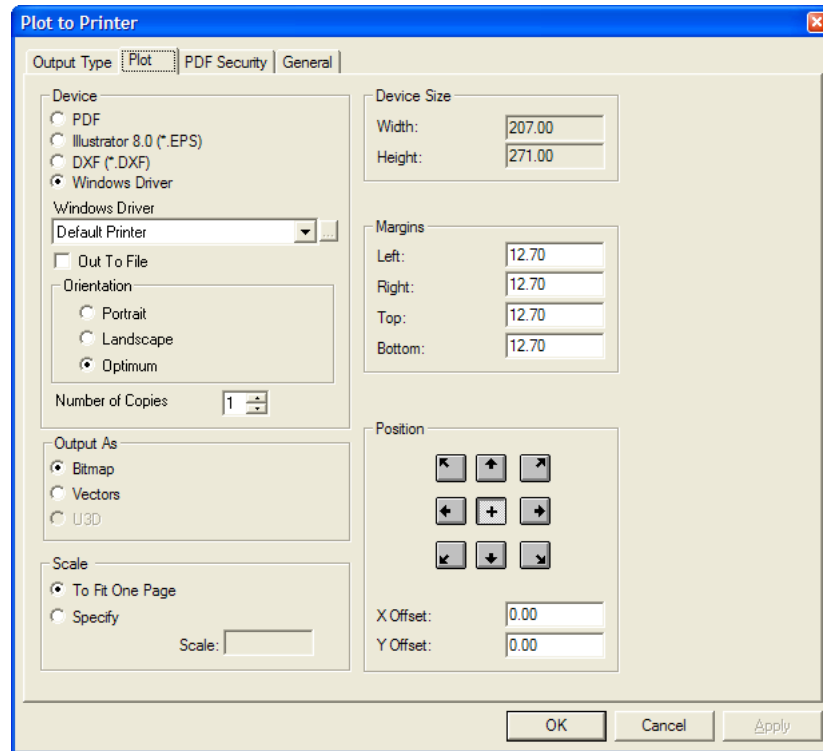

The options in the **Device** group control the Output type and any associated options for that type. **PDF** and **Illustrator 8.0 (*.EPS)** have no additional options in this group, but choosing **Windows Driver** lets you choose the device, the page orientation, and the number of copies to make.

In the Output As group, **Bitmap** makes the output as a snapshot of the screen. **Vectors** takes a snapshot but adds the edges as lines. **U3D** is unavailable as this is not a PDF or U3D Output.

When choosing **Vectors**, the degree of complexity of the workspace may cause issues with hidden line removal, and if there are more than 10 designs or solids with more than 10,000 polygons, the Output may take a few minutes to complete. Vector outputs do not contain bounding boxes. The color of the lines is set by the plotting style for plots and PDF Outputs. Line color in EPSF Outputs are controlled by the tuning file TUNE.EPSF.3D.TXT.

The options in the **Scale** group control the size of the Output as compared to its original size in the workspace. **To Fit One Page** is most useful when using **Plot to Printer**. **Specify** lets you enter a desired value in the **Scale:** field.

The **Device Size**, **Margins**, and **Position** groups all work as they do in other Outputs. **Device Size** is unavailable for Outputs of type **Windows Driver**.

Set these options and values as desired, and then click the General tab.



1. On the General tab, the **Output Directory** field lets you specify the directory in which the Output file will go. The **Automatically Open** checkbox controls whether the outputted file is automatically opened by a program associated with its file type, such as Adobe Illustrator for .EPS files. **Automatically Open** has no effect for **Plot to Printer** unless **Out to File** is also selected and the filename includes an extension associated with a program such as .txt.
2. Once you have set the options on the Plot and General tabs as desired, click **OK**.
3. In the Save As dialog box, choose the directory in which to save the file and enter a filename, and click **Save** to perform the Output. If **Automatically Open** was checked on the General tab, ArtiosCAD will launch the default application associated with the outputted file type and show the file.

Outputting a 3D workspace to a PDF file with U3D

U3D is an industry-standard 3D output format that can be read by many applications. For example, if you embed U3D data in a PDF file, Acrobat Reader 7.0 or greater lets you zoom in and out, rotate, and otherwise change the view of the objects in the 3D file window.

Creating a PDF file with embedded U3D data is similar to creating a PDF file without it, in that in 3D, you click **File > Outputs > Plot to PDF/U3D**, except that instead of choosing to output as a bitmap or vectors, you choose **U3D** in the **Output As** group on the Plot tab of the Output dialog box. Also, the U3D Options tab is added to the Output dialog box as shown below.

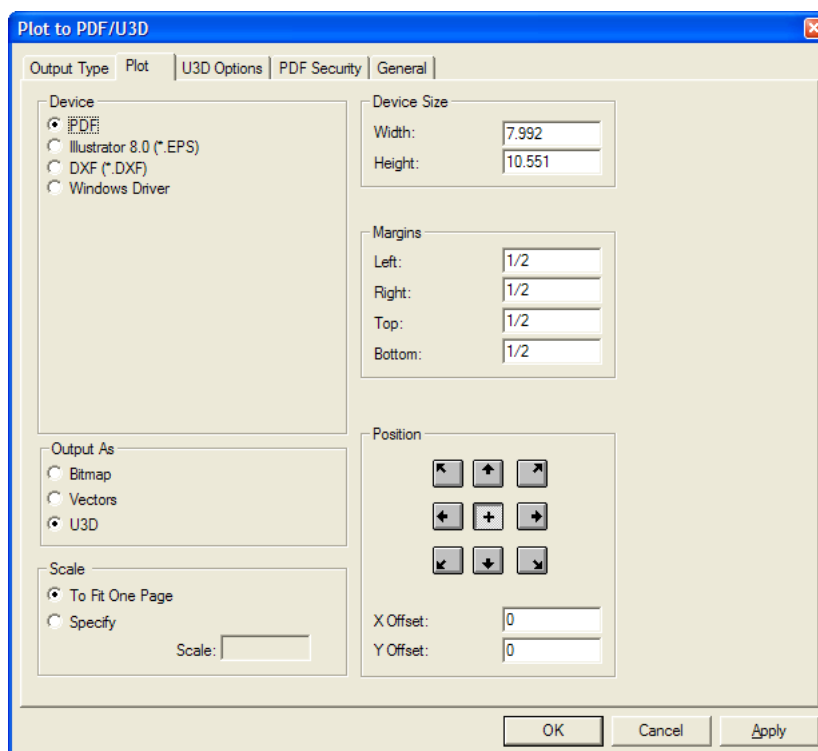

On the U3D Options tab, in the **High graphics** group, **Use View Settings** uses the current high graphics mode of the workspace. Clear this checkbox to enable the drop-down list box in which you can choose the desired high graphics mode setting.

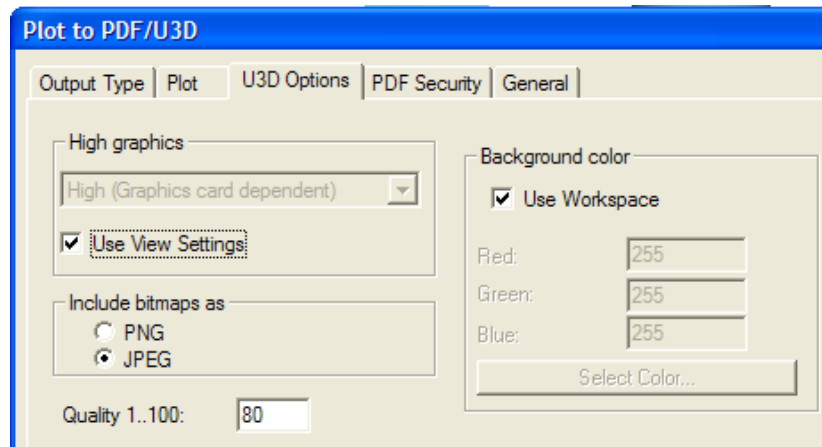

In the **Include bitmaps as** group, choose the file type for the images embedded in the PDF file, either **PNG** or **JPEG**. When JPEG is the selected choice, the **Quality 1..100** field is available. Use a higher number for better-quality images.

In the **Background color** group, **Use Workspace** includes the background color defined in the View Mode dialog box, if there is one. Clearing this checkbox enables the **Red:**, **Green:**, and **Blue:** fields, and also the Select Color button, which leads to the color palette.

On the PDF Security and General tabs, set the options as desired.

When you have completed setting the various options, click **OK** to make the PDF file with embedded U3D data, or click Cancel to return to ArtiosCAD.

Shown below is a 3D workspace output to a PDF file using U3D in transparent wireframe view.

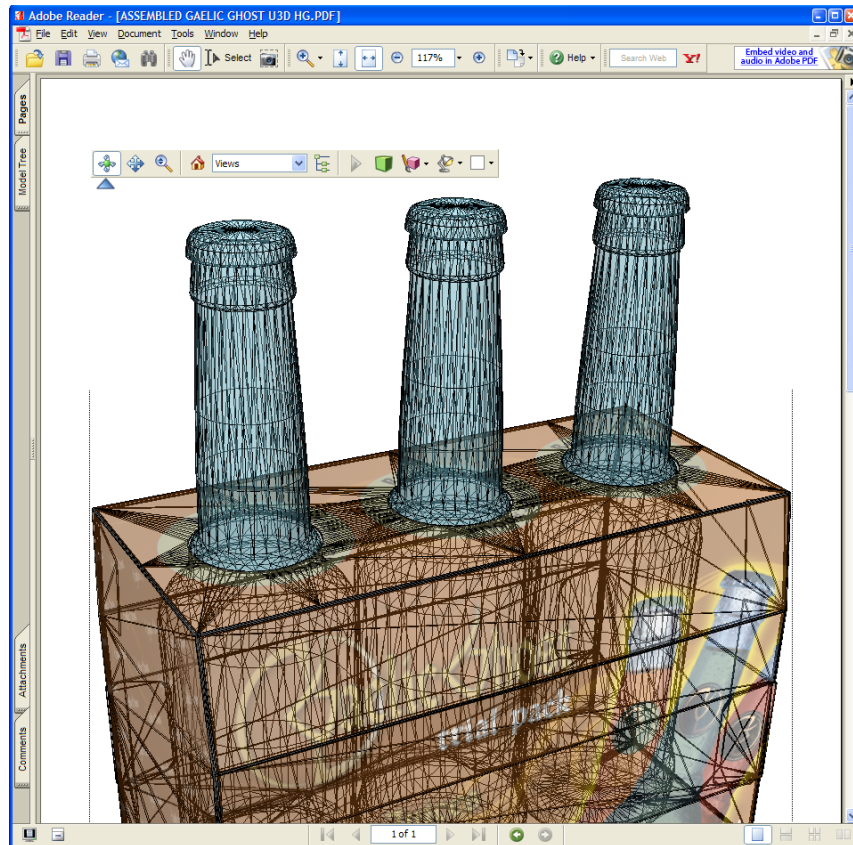

Outputting a 3D workspace to U3D

To output a 3D workspace to plain U3D for use with other applications, use the **U3D** entry on the Outputs-3D menu. Clicking the **U3D** entry opens the U3D dialog box as shown below.

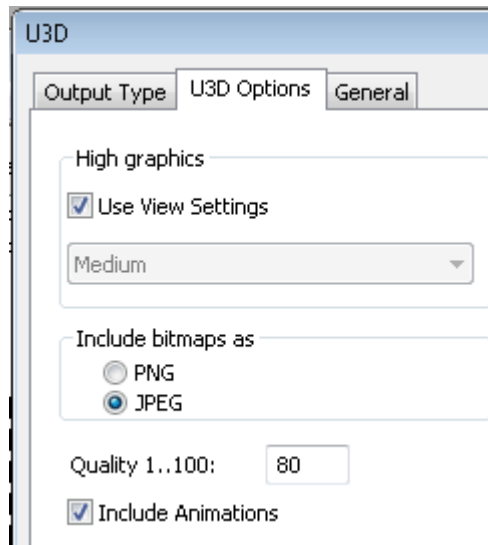

On the U3D Options tab, in the **High graphics** group, **Use View Settings** uses the current high graphics mode of the workspace. Clear this checkbox to enable the drop-down list box in which you can choose the desired high graphics mode setting.

In the **Include bitmaps as** group, choose the file type for the images embedded in the PDF file, either **PNG** or **JPEG**. When JPEG is the selected choice, the **Quality 1..100** field is available. Use a higher number for better-quality images.

Include Animations is checked by default.

On the General tab, the **Output Directory** field lets you specify the directory in which the Output file will go. The **Automatically Open** checkbox controls whether the outputted file is automatically opened by a program associated with its file type, such as Adobe Illustrator for .EPS files.

Once you have set the options on the Plot and General tabs as desired, click **OK**.

In the Save As dialog box, choose the directory in which to save the file and enter a filename, and click **Save** to perform the Output. If **Automatically Open** was checked on the General tab, ArtiosCAD will launch the default application associated with the outputted file type and show the file. However, most systems do not have an application associated with U3D files.

Notes and warnings when using U3D

U3D-enabled Outputs do not follow the 3D View mode settings in the current view, except in the one case of High graphics mode if **Use View Settings** is checked on the U3D Options page of the Output. In particular, U3D files are always created as if **Solid**, **Perspective**, **Show board thickness**, and **Graphics** are turned on in the View mode.

For PDF Reports with embedded U3D data, the U3D models are centered and fill the appropriate 3D file window, regardless of window settings in the Report. The scene is scaled to fit the 3D file window. Also, 3D content appears as a static bitmap of the initial view in the Outputs Preview dialog box.

For Plot to PDF Outputs, the U3D window matches the placement as if **Bitmap** were selected in the **Output As** group. With an edge-on view this will generally result in a skinny U3D window in the PDF file and the model will appear cut off as soon as it is rotated. To get around this, use a PDF Report with a 3D file window of the desired shape and size. Size issues can be somewhat counteracted by using the Marquee Zoom tool in Acrobat to make the 3D window fill the screen.

For both PDF Reports with embedded U3Ds and Plot to PDF Outputs, background images are not embedded in PDFs. Background images for 3D objects are not supported by the current PDF standard (PDF 1.6).

For plain U3D Outputs, the background image is included in the U3D file but will only match an ArtiosCAD view if the viewing window can be made the same size relative to the background image as it is in ArtiosCAD. It may be possible to achieve nearly the same alignment as viewed in ArtiosCAD by not manipulating the object and resizing the window carefully. This means that a model aligned to a background in ArtiosCAD can not be Output in a way that it will necessarily appear aligned to the background when opened in another U3D-enabled application.

U3D background images can only be 24-bit color images; other format background images are ignored, not exported.

Reports with more than one 3D file window with the same file number do not work correctly with U3Ds.

Adobe Acrobat versions 7.0.9 and 8.0 have an issue where the first of several copies of a 3D object does not appear initially. For example, an beer carrier with 6 bottles will initially appear to have only 5 bottles. The missing object(s) appears as soon as you clicks in the 3D area, or you scroll the Acrobat Reader window, or do something else to cause it to update the view. With Acrobat 7.0.9 the temporary disappearance will happen again each time Acrobat's 3D Toolbar is used (such as to change the rendering mode or the lighting).

Adobe Acrobat Professional 7.0.9 does not embed ArtiosCAD-generated U3D data. Users wishing to embed raw U3D from ArtiosCAD in PDF files are currently recommended to use Adobe Acrobat Professional 8.0 (best) or 8.1. In Adobe Acrobat, use **Tools > Advanced Editing > 3D Tool** to embed the U3D data into an existing PDF file.

As of this writing, the best viewer for ArtiosCAD-generated PDFs with U3D models embedded is Adobe Acrobat Reader (or Professional) version 8.0. Version 8.1 has introduced an issue where replicated objects sometime move over other copies of the same object. Adobe Acrobat aggressively updates itself to the highest version available with the same major release number (7.x -> 7.0.9 and 8.x goes to 8.1, at the moment). As a workaround, Adobe Acrobat Reader 7.0.9 can still be downloaded from the Adobe website for free and works better than Adobe Acrobat Reader 8.1 for viewing ArtiosCAD files with copied design and solids.

To download Adobe Acrobat Reader 7.0.9, point a Web browser to http://www.adobe.com/products/acrobat/readstep2_allversions.html.

U3D Animation Notes

Some notes about animations in exported U3D files:

- ArtiosCAD will instruct Acrobat Reader to repeat the animation 1000 times because it does not recognize when you click **Play** after the animation finishes. This way, you may pause and resume the animation as desired. If you have a piece that appears or disappears at the end of the animation, make sure to add a frame afterward so that this action is visible.
- U3D animations showing moving bend panels will not exactly match the ArtiosCAD animations due to U3D format restrictions; however, they will be a close approximation.
- Surface smoothness in an exported U3D file can vary due to variances in the U3D algorithm.
- **Scale to Fit** is not supported.
- U3D animations with curved creases and/or mates may not work properly.

Outputting a 3D workspace to a VRML file

Outputting a VRML file from 3D lets you share your work in 3D with people who do not have either ArtiosCAD or the ArtiosCAD Viewer.

Note: If your workspace contains a tear-away animation, or an animation with curved creases or mates, do not output it to VRML as VRML does not support the type of bends used. Use a different Output format.

To output a 3D workspace to a VRML file, do the following:

1. Set the view angle and elevation of the 3D workspace as you want them to be in the VRML file.

2. Click **File > Outputs-3D > VRML**.
3. Navigate to the directory in which to save the files, and name the main file as desired. The picture files will share the same root name as this main file. As the **Save as type:** field defaults to VRML when exporting from 3D, do not change it. Click **OK** when done naming the file to be saved in the desired location.
4. The VRML Options dialog box appears. The options in it are explained at the end of this procedure. Set the options as desired and click **OK**.
5. The VRML files are created in the desired location. If the **Automatically open** checkbox in the VRML Options dialog box was checked, the Web browser launches and the animation opens.

Shown below is the VRML Options dialog box. All the options in it are configurable in **Defaults > Outputs-3D > Artios > VRML > VRML options**.

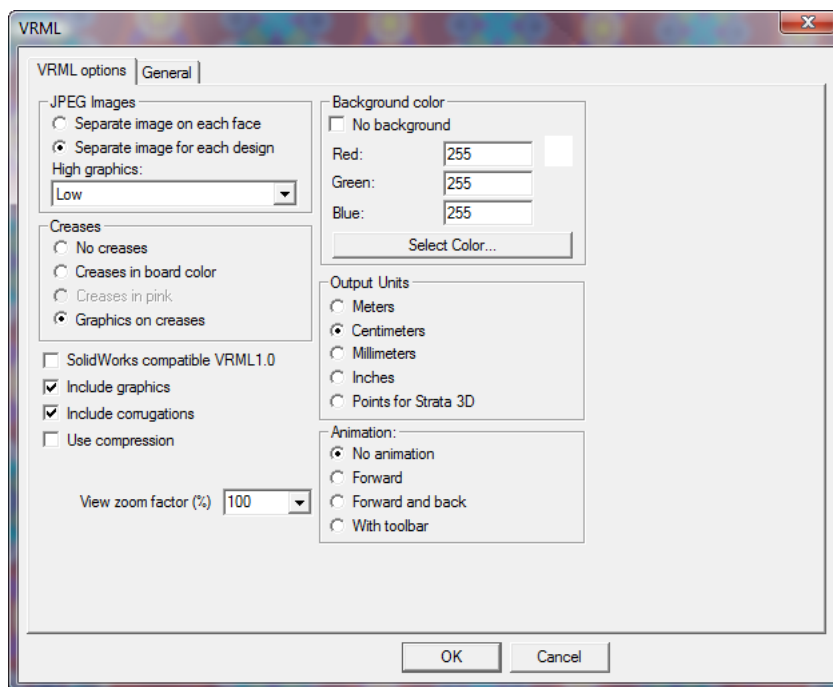

SolidWorks compatible VRML 1.0 outputs a VRML version 1.0 file for use with SolidWorks and other programs that do not support VRML version 2.0. VRML 1.0 does not support graphics or animation.

Include graphics controls the export of graphics. Turn this checkbox off for the smallest VRML files with the most robust performance possible in the browser; turn it on for rich detail. This checkbox must be checked for the **JPEG Images** and **Creases** groups to be available.

Note: Exporting a design to VRML with graphics turned on creates separate .JPG files. Make sure to keep them with the .WRL file so that the graphics are displayed correctly when the .WRL file is viewed.

Include corrugations, when checked, draws corrugations on the edges of corrugated boards. Turn this checkbox off for smaller VRML files with more robust performance in the browser.

Use compression controls if the VRML geometric information file is compressed or not. A smaller file is faster to download, but some third-party programs do not support compression and may error if this option is checked. The JPEG image files are already compressed according

to the **JPEG Quality** setting in Property Defaults and are unaffected by the state of this checkbox.

Automatically open, when checked, launches the Web browser and opens the VRML file as soon as it is created.

View zoom factor sets the initial field of vision in the VRML file. 100 percent uses the same scale factor as in ArtiosCAD. If you find that animations are extending outside of the browser window, try setting this value to a smaller number. The zoom factor can be between 40 percent and 250 percent.

JPEG Images group

On export, the image of each face of the box is converted to a JPEG graphic. **Separate image on each face** creates a separate JPEG file for each face. The size of each file is limited by the resolution of the graphics in ArtiosCAD.

Separate image for each design makes a single large JPEG file for each design in the workspace instead of separate JPEG files for each face. Use this option when using the VRML file in other 3D graphics applications that need to substitute or manipulate the graphics.

The **High graphics:** drop-down list box lets you specify the resolution of the exported graphics as **Low**, **Medium**, **High**, or **Maximum**. **High** and **Maximum** depend on the abilities of the computer's display adapter.

Creases group

There are several ways to handle creases when exporting to VRML. **No creases** simply does not include them in the output. **Creases in board color** makes them the same color as the board, but the lighting in the VRML rendition shows them as slightly contrasting. **Creases in pink** turns the creases pink for easy visibility. **Graphics on creases** wraps the graphics around the creases on the inside and outside of the design(s). This is the most sophisticated option, but it increases file size by 50 percent.

Background color group

The settings in the **Background color** group control the color shown by the browser in the empty space as the VRML file plays. **No background** allows the preferences set in the VRML plug-in to be used. When checked, the rest of the options in the group are unavailable.

The values in the **Red:**, **Green:**, and **Blue:** fields allow you to set custom values for each color. The results of the settings are shown next to the **Red:** field.

Clicking **Select Color** opens the color palette. Click **OK** when you have chosen a color.

Output Units group

As there is no measurement ability in the browser window, the options in this group control the granularity of the VRML plug-in's zoom tools. Selecting **Meters** provides coarse zoom while selecting **Millimeters** provides fine zoom. **Centimeters** is the default, and should be selected when choosing **With toolbar** in the **Animation** group. **Points for Strata 3D** should be selected when the VRML file will be opened in Strata 3D; select **No animation** in the **Animation** group as well for files destined for Strata 3D.

Animation group

The options in the **Animation** group control how the animation behaves in the browser.

Note:

Do not output VRML animations with curved creases or mates as they may not work properly.

No animation creates an unmoving view of the design. **Forward** runs the animation continuously. **Forward and back** runs the animation forward, then backward, and repeats. **With toolbar** inserts a toolbar into the VRML file allowing you to manually step through the file, as well as toggle design transparency. The toolbar is shown below:



The first button plays the animation.



The second and fifth buttons move to the first and last frames of the animation, respectively.



The third and fourth buttons move back or forward one frame in the animation sequence, respectively.



The sixth button toggles transparency. Shown below is a frame of an animation with transparency off.

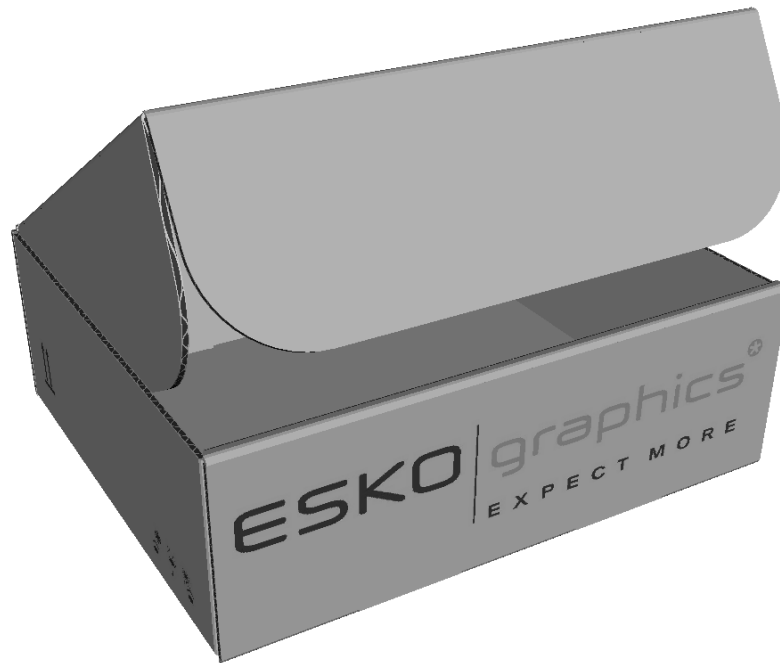

Shown below is the same frame with transparency on.

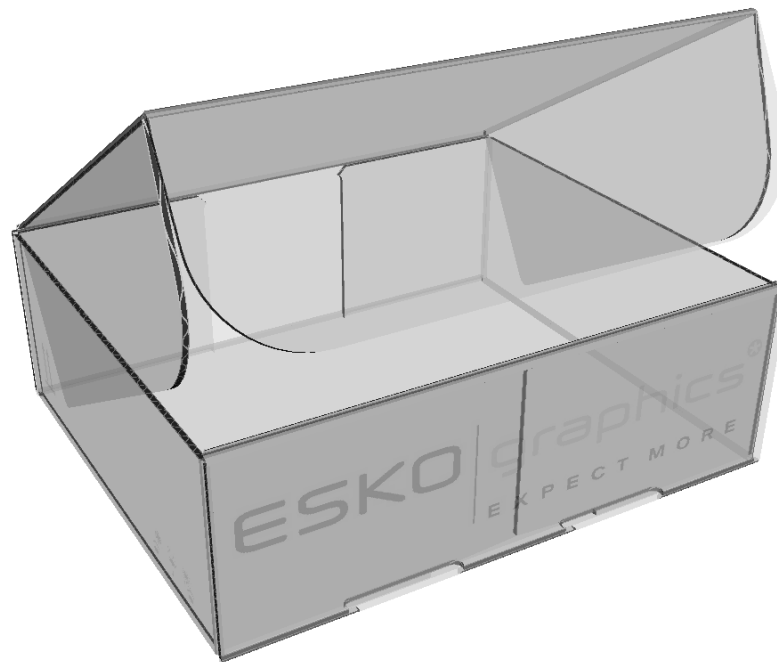

Outputting a 3D workspace to a SolidWorks file

Note: You may only output a SolidWorks file if you installed the SolidWorks supplemental software from a pre-12.0.10 version of ArtiosCAD. The example **SolidWorks export** Output in the Outputs-3D catalog has been removed. If you have upgraded from a previous version and have never modified the Output, the installation process removes it. You can easily create a new one as the SolidWorks output type still exists.

The **SolidWorks export** command on the Outputs-3D menu lets you output a 3D workspace as a SolidWorks part, an IGES file, or a ProEngineer part. You must have purchased the SolidWorks option and installed the SolidWorks Import/Export component for this feature to work.

To perform the SolidWorks export, do the following:

1. Position the items in the 3D workspace as desired and save the workspace.
2. Click **File > Outputs-3D > SolidWorks export**.

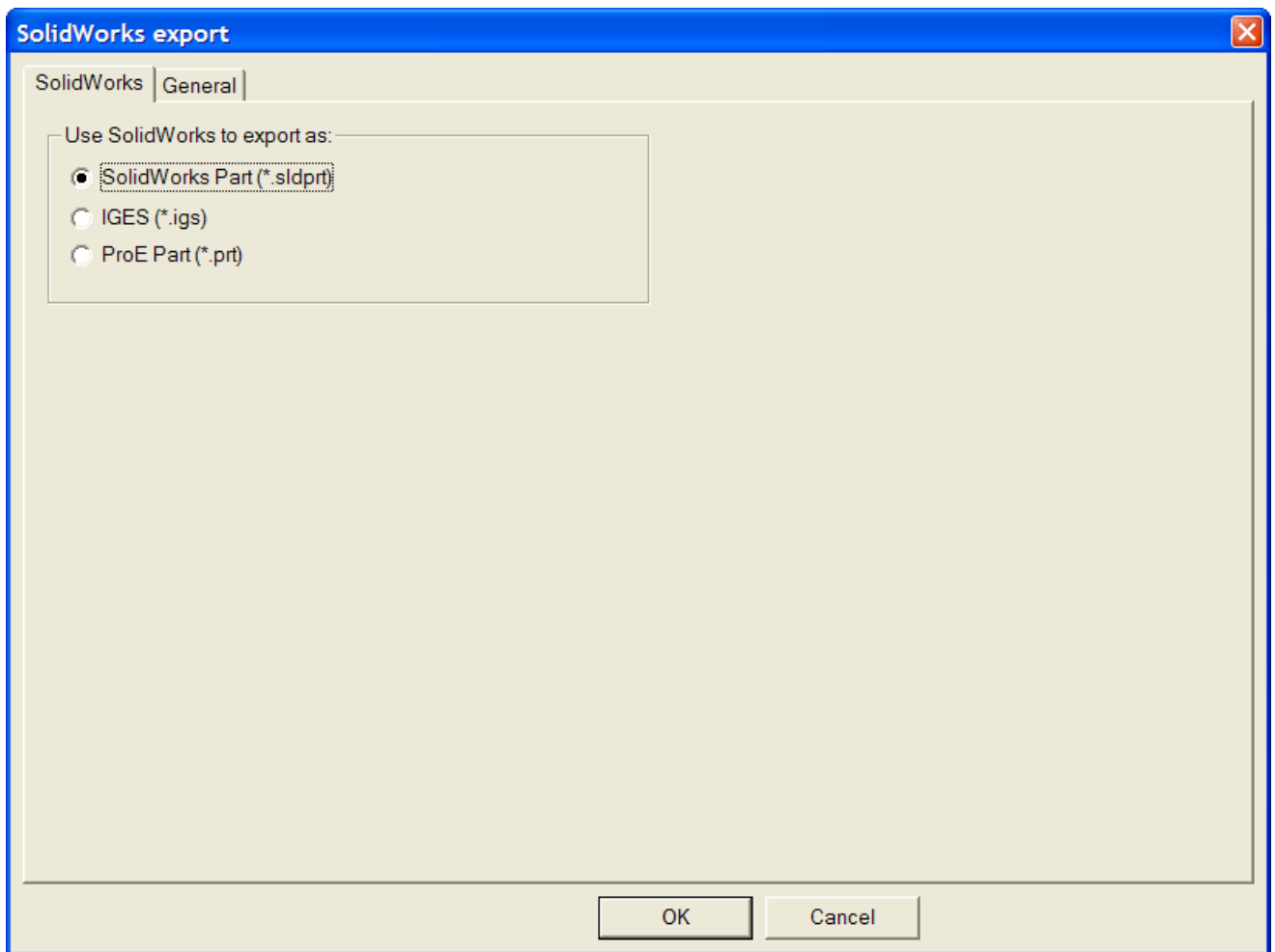

3. Choose the type of file to create.
4. On the General tab are the **Output directory** field and the **Automatically Open** checkbox. Set them or leave them blank as desired.
5. Click **OK**.
6. In the Save As dialog box, navigate to the desired directory (if necessary) and enter the filename in the **File name:** field.
7. Click **Save**. The Output is performed.

Notes and warnings

The exported file has a SolidWorks body for each for each face and crease in each carton, as well as for each solid. Each SolidWorks body has the outside color of the ArtiosCAD 3D design, but there is no separate inside color, and no graphics.

Graphics, dimensions, and bounding boxes are not exported.

ProEngineer and IGES exports do not include color.

Exporting a 3D workspace as a ProEngineer part automatically appends a version number to the filename based on the contents of the output folder. The export process also replaces any non-ASCII characters with an underscore (_).

Some imported VRML and IGES files might not export correctly from ArtiosCAD if they do not have well-formed solid bodies. Imported CATIA and SolidWorks files should have well-formed solid bodies.

SolidWorks files are not backward-compatible between versions of SolidWorks. To show the version of SolidWorks that ArtiosCAD uses, click **Help > Diagnostics > Show SolidWorks Version**.

Outputting a 3D Workspace as a STEP, IGES, ACIS, or XCGM File

Use the **Spatial export** Output in 3D to export a 3D workspace as a STEP, IGES, ACIS, or XCGM file for use in other programs. This Output makes a solid body from each panel and create of an ArtiosCAD design instead of thousands of triangles. If there are multiple parts in a workspace, each part is a separate body.

To perform the export, do the following:

1. Position the items in the 3D workspace as desired and save the workspace.
2. Click **File > Outputs-3D > Spatial export**.

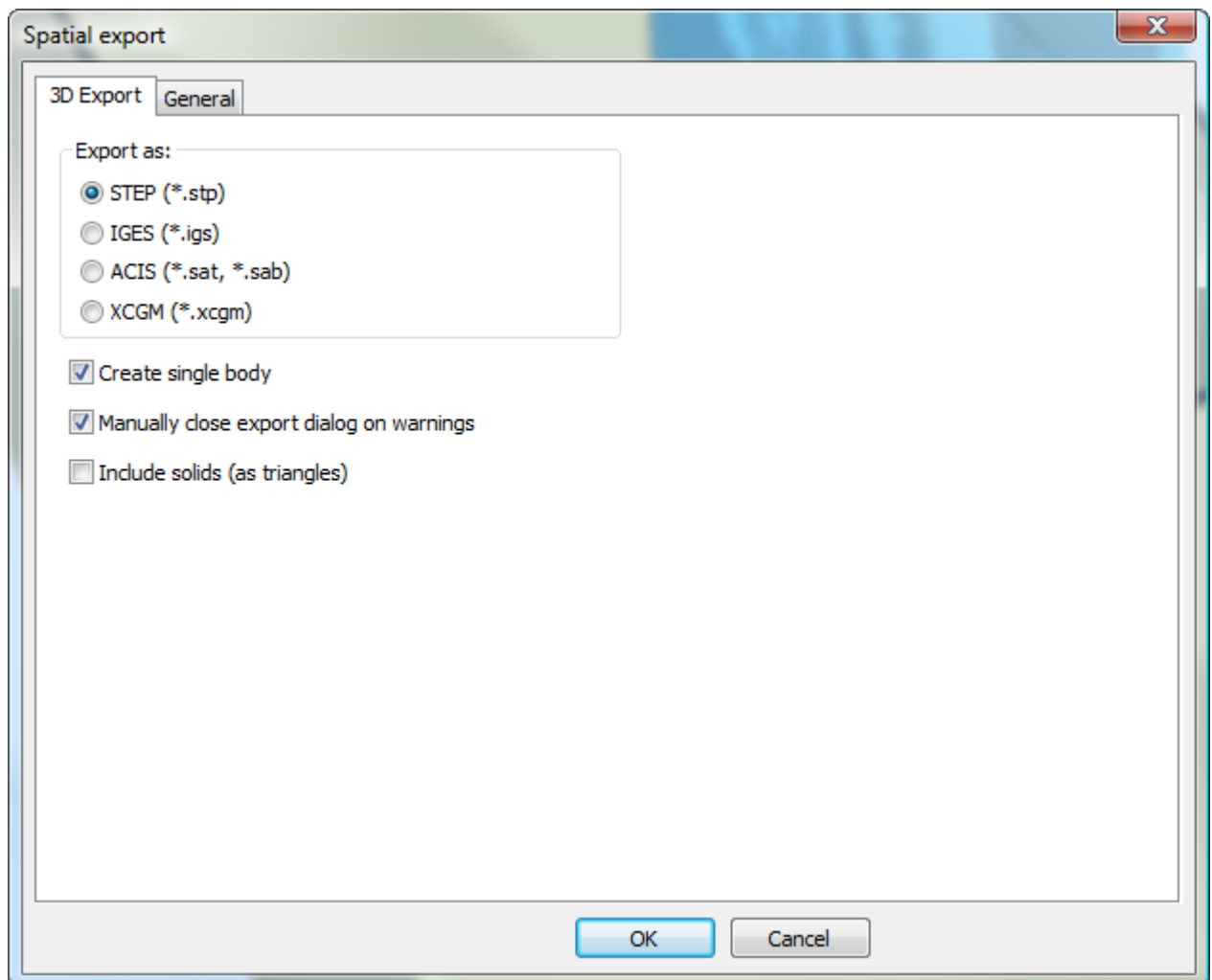

3. Choose the desired file type in the Export as: group.
4. Set the checkboxes as desired:
 - a) **Create single body** exports all the panels of the container as one solid body for easier use in other applications. When this checkbox is not checked, each individual panel is exported as a part.
 - b) **Manually close export dialog on warnings** keeps the progress bar dialog box open if there are any warnings so you can see them. Click **Close** to close the dialog box.
 - c) **Include solids (as triangles)** includes any solids in the 3D workspace in the Output as triangles. When this checkbox is not selected, ArtiosCAD only includes containers in the exported file. This checkbox is not available if there are no solids in the workspace.
5. Click **OK** to start the Output.
6. Set the filename and folder as desired and click **Save**.
7. ArtiosCAD displays a progress bar as it exports the file.

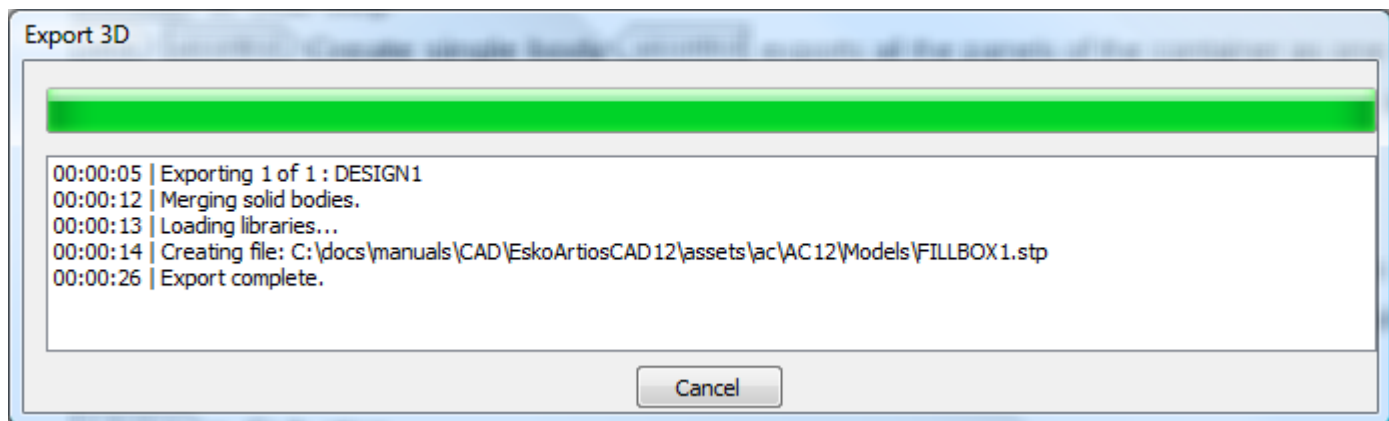

Spatial Export Notes

Notes about using the **Spatial export** 3D Output:

- ArtiosCAD includes no graphics in the exported file due to file format restrictions.
- There can be only one color per single design. ArtiosCAD sets the color to the outside color of the single design(s).
- Creases are represented by cylinders. When their ends are not flat, ArtiosCAD renders their ends with triangles for a more realistic appearance.
- Slots and indented perfs have square edges and are cut through completely.
- There is no representation for edge crushing.
- ArtiosCAD exports imported solids as triangles. More intricate solids may cause the export to take longer.

3D Movie Outputs

If you have the 3D Animation module, you can now export .AVI and .MOV movies from ArtiosCAD. The **Movie** output type has been added to Outputs-3D entries.

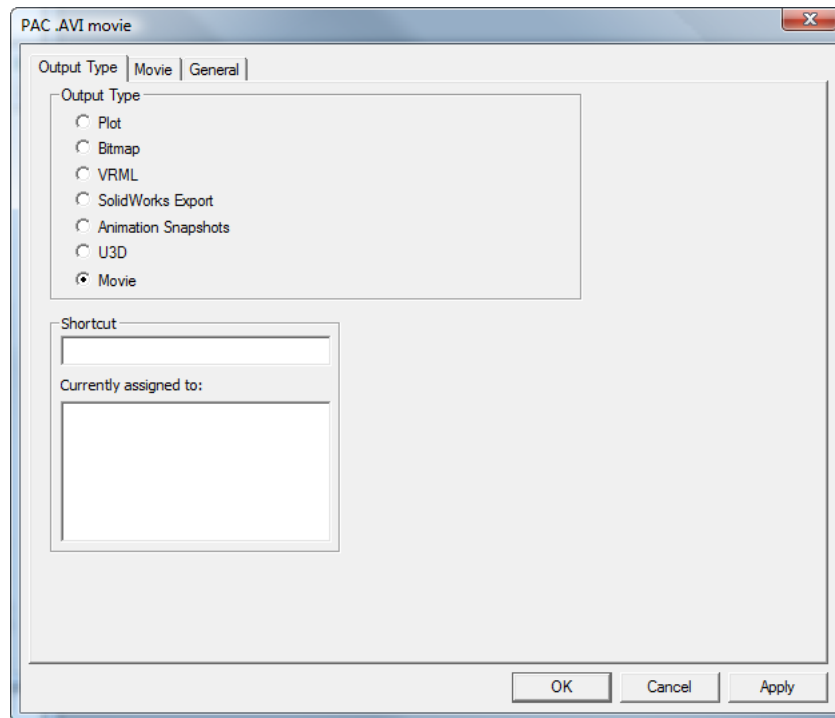

Note:

This feature is highly dependent on the multimedia codecs on your computer. Esko cannot guarantee that the codecs on your personal computer will work as anticipated. If you have trouble using this feature, you should make sure you have the newest codecs available from your operating system vendor or other third-party software vendor.

Note:

Outputting a .MOV file requires the Apple QuickTime Player to be installed on your computer. This player is no longer supported or maintained by Apple; use it at your own risk.

See the *Defaults* chapter for more information on creating a Movie output.

Creating a 3D Movie Output in Defaults

Before you create a 3D Movie output, keep these considerations in mind:

- Multimedia codecs vary between computers and there is no guarantee that a movie you make on your machine will work flawlessly the first time on someone else’s computer. If you encounter problems, you may need third-party support from your operating system vendor or codec supplier.
- You need the 3D Animation module on your computer to use this Output.
- You need the free Apple® QuickTime® Player Installed on your system to output files in .MOV format. This software is available for download from at <http://www.apple.com/quicktime>.

Create a 3D Movie Output definition by doing the following:

1. Start ArtiosCAD, open Shared Defaults, and expand the Outputs-3D catalog.
2. Right-click **Outputs-3D**, then click **New > Data**.

3. Enter a name for the Output, press Enter, and double-click the new entry.
4. In the **Output Type** group, select **Movie**.

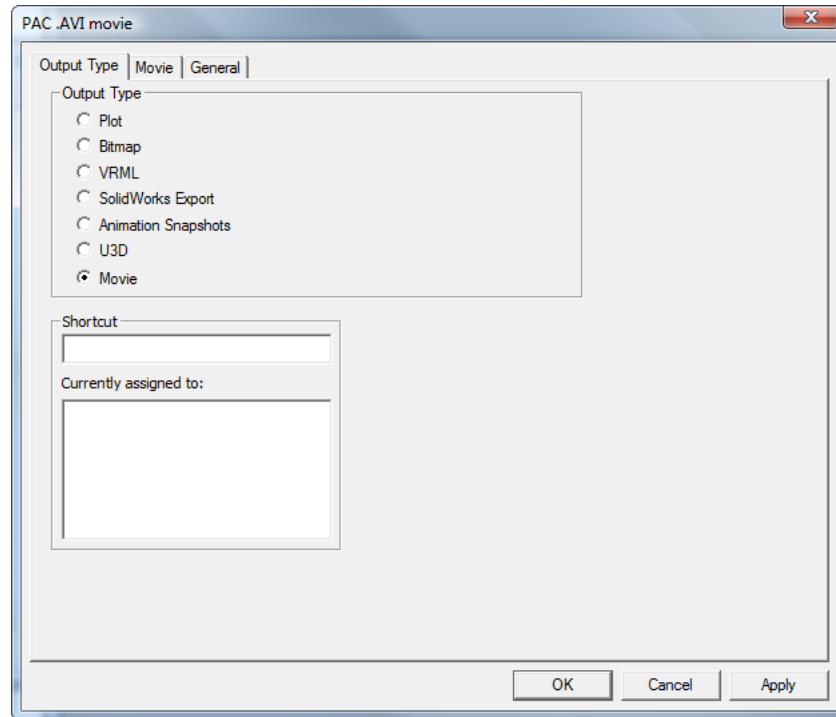

5. Click the **Movie** tab.

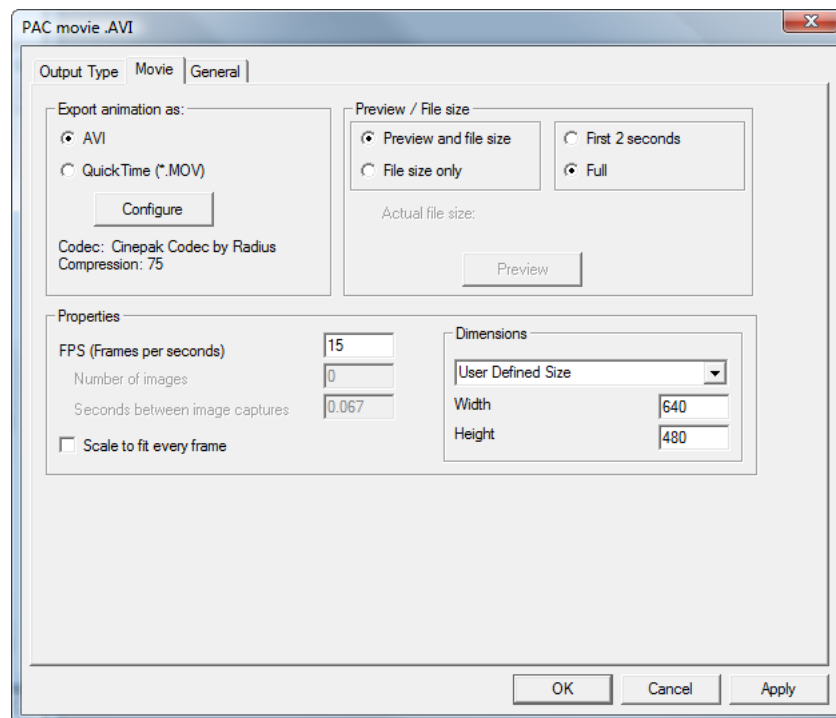

6. In the **Export animation as** group, choose either **AVI** or **QuickTime (*.MOV)**. AVI files are generally used on computers using the Microsoft Windows family of operating systems while QuickTime files are generally used on the Apple Macintosh.
 - a) Supplemental information about the codec used by the selected format is shown beneath the **Configure** button. The default settings are sufficient for most situations, but if you are not achieving the desired results, click **Configure**.

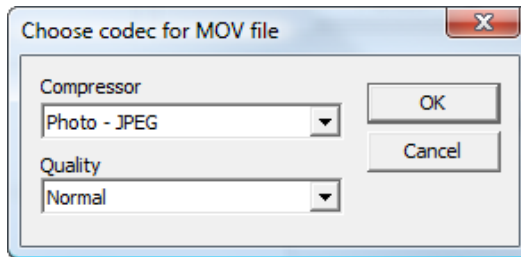
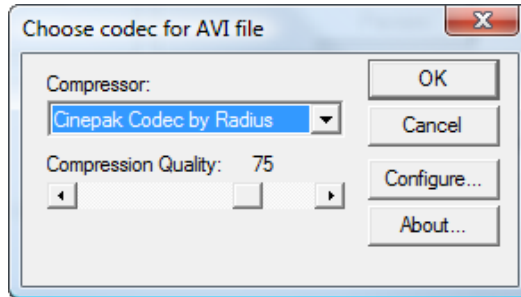

- b) in the **Choose codec for AVI file** or **Choose codec for MOV file** dialog box, set the codec ArtiosCAD uses to create the movie in the **Compressor** field. The list of compressors available is dependent upon the software loaded on your system.
 - c) For .MOV files, each compressor may have different configuration options available to it via the **Configure** button. Depending on the output format and compressor you chose, you may also be able to set the compression quality using the slider for .AVI files or the drop-down list for .MOV files.
 - d) When you have selected the compressor and quality settings to use, click **OK** to return to the **Movie** tab in the Output definition.
7. In the **Preview/File size** group, set the default selection for these options when creating the Output. **Preview and file size** will make a preview of the movie and compute its file size based on the selected codec configuration. **File size only** will only compute the file size. The times in the other group either preview the **First 2 seconds only** or the **Full** movie length. **Get file size** is available only when creating the Output.
8. In the **Properties** group, set the **FPS (Frames per second)** value to a number between 1 and 30. 15 is the default. A higher number results in smoother video. **Scale to fit every frame** performs a Scale to Fit for every frame of the video.
 - a) **Number of images** and **Seconds between image captures** are read-only fields that display their relevant information when creating the Output.
9. In the **Dimensions** group, set the width and height in pixels of the movie manually by selecting **User Defined Size** from the drop-down list box, or choose one of the pre-defined sizes. The sizes must both be exactly divisible by 4.

- a) **NTSC** (National Television Standards Committee) is the video format used for televisions in the United States and Japan. **PAL** (Phase Alternating Line) is the format used in some of the rest of the world.
 - b) DVD, SVCD, and VCD refer to the size of the frame in pixels - Digital Versatile Disk being large, Super Video CD being medium, and Video CD being small.
 - c) DivX, XviD, and WMV are all standard sizes for movies intended to be watched on a computer.
 - a) DV stands for digital video which has a standard width of 720 pixels. The height varies by country standard.
- 10.** Once you have set the options on the **Movie** tab as desired, click the **General** tab, on which you can set the **Output Directory** (if desired) and also the **Automatically open** checkbox, which is checked by default.
- 11.** Click **OK** to finish defining the Output.
- 12.** Save and exit Defaults as usual.

Outputting a Movie from 3D

Because VRML and U3D outputs do not support the methods used for curved creases, you can now output .AVI and .MOV movie files of your animation sequences. You must have the 3D Animation module to output movies from 3D.

.AVI files can be played on the Apple Macintosh using **VLC Player** which can be downloaded from: <http://www.videolan.org/vlc/>, and MOV files can be played on all computers using VLC as well.

Before you can Output a movie from 3D, you must have configured a movie Output in the **Outputs-3D** catalog in Defaults. See the *Defaults* chapter for more information.

To Output a movie from 3D, do the following:

- 1.** Create or open a 3D workspace that has an animation sequence defined.
- 2.** Click **File > Outputs-3D** and click the desired movie output.
- 3.** Set the options on the **Movie** tab as desired. For more information about each option, see the *Defaults* chapter.

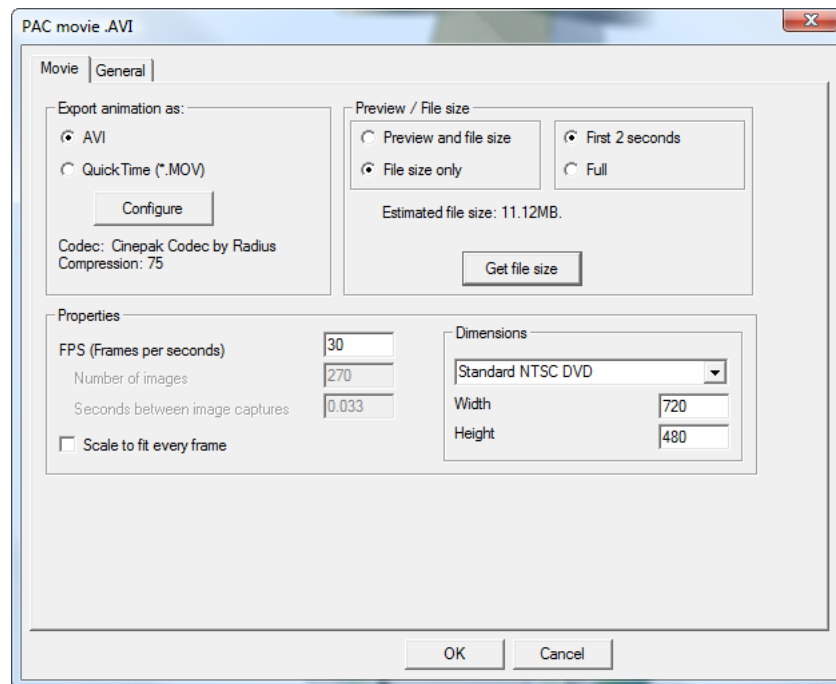

4. If desired, click **Preview/Get file size** in the **Preview/File size** group to generate a preview of the movie or find out how large the file will be. Adjust the settings if the file size is too large; some email systems still have 5 MB attachment limits.
5. Click the **General** tab and set the options as desired.
6. Click **OK** and enter a name for the movie file in the **Save As** dialog box to begin the Output.
7. A progress dialog box appears. If it is going to take too long to Output the movie, click **Cancel**. In that case you should retry the Output with different settings - a lower FPS setting, a smaller frame size, greater compression - that will result in a smaller, faster-to-generate file.

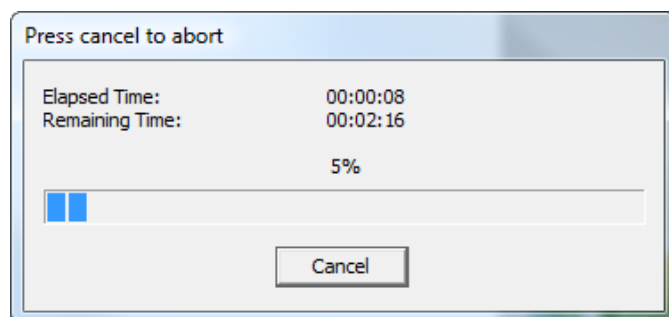

8. If **Automatically Open** on the General tab was checked, the movie file opens automatically in the associated media player.

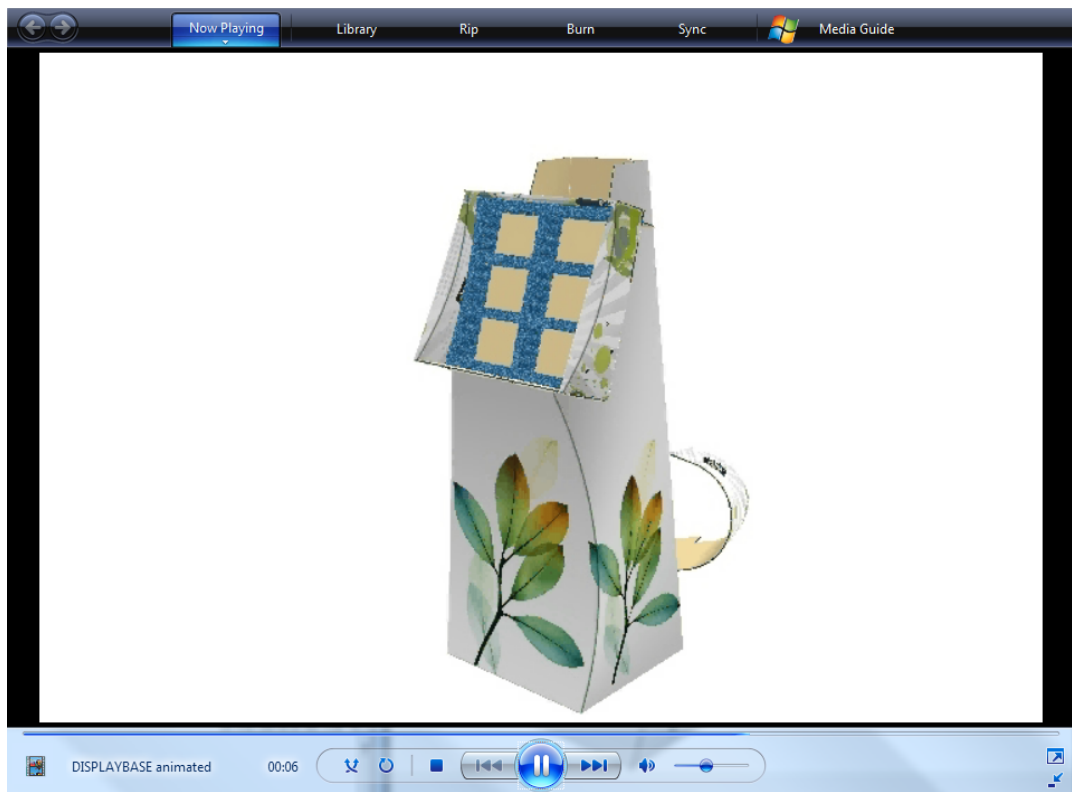

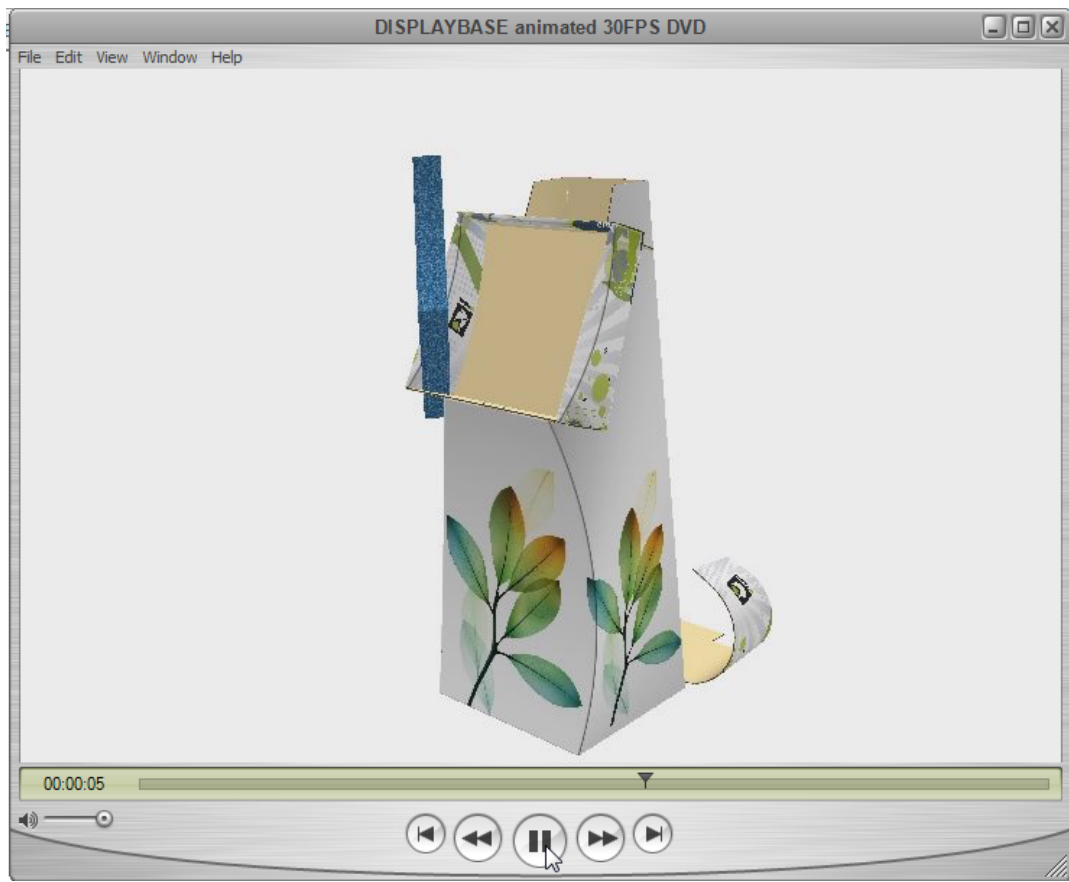

Canvas Outputs

Canvas Outputs are similar to regular Outputs.

If you use an Output on the **File** menu, ArtiosCAD uses the active part for that Output. To Output all the parts in a canvas, use **Parts > Parts Outputs**.

Some notes about canvas Outputs follow.

For calculated expressions:

- In most cases, avoid directly accessing workspace variables. However, L, W, and D work correctly for either the canvas or a part. Note that for a part, L, W, and D are for information only.
- Most board variables will work correctly, such as CAL, IL, OG, CRRV, TEST, WGHARA, CSTARA, CSTWGH, HRRV, SRV, BRD\$, BDD\$, FLU\$, and TST\$. However, corrugated board variables for liners and mediums will not work for the selected part, as they always return canvas information.
- Legacy Reports may contain calculated expressions that directly access variables. These will not work with canvases and parts. Remove these expressions and re-add them from the Calculated Expression catalog, as those contain updated definitions. For example, you may have a Report that uses DBREC.DESC to show a design description. Replace this with an expression using DBGET(DESIGN,DESC\$). Likewise, if you have a legacy Report that uses

(TLIBRARY(LIBDBSTYLE.TXT)) to list design characteristics, replace it with #DBCHARS\$ so that ArtiosCAD gets the characteristics for the canvas or part as appropriate.

- The expression for Design Standard Name, #CFN\$, will always return the name of a standard used for a canvas, not for a part.

If your Output is set to Output to a layer, ArtiosCAD generally puts that data into a part of type Output. There can be only one Output part; if there already is one, ArtiosCAD adds the content to the existing part.

Running a BOM-like Output for a canvas

To run a BOM-like Output for a canvas, do the following:

1. Click the name of the canvas in the Parts List to select it.
2. Click **Parts > Parts Outputs** and then the desired Output. (The desired Output must have **Parts Outputs** selected in the Show In group in its definition in Defaults to appear in this list.)
3. ArtiosCAD opens the Select Parts dialog box.

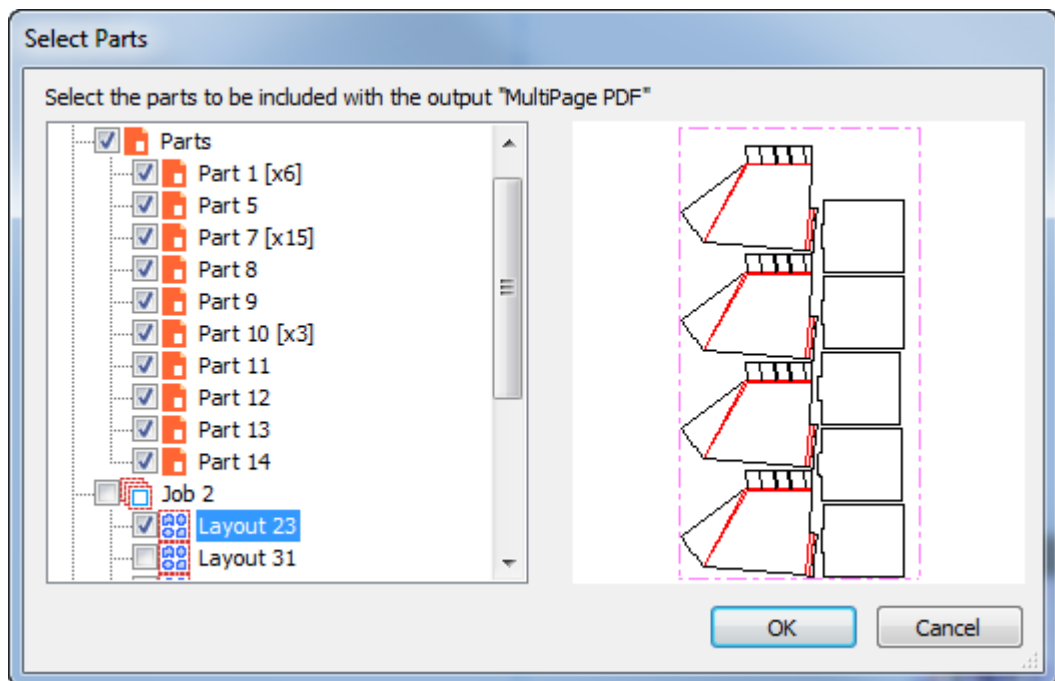

ArtiosCAD selects all Production-type parts by default. Click a part name to see its preview.

4. Select the parts to include in the Output and click **OK**.
5. ArtiosCAD runs the Output normally and prompts you to set the scale, number of pages, see a preview, or set the properties. Click **OK** to make the Output. If your Output goes to files, ArtiosCAD prompts you for the location and filename.

Shown below is an example BOM Report.

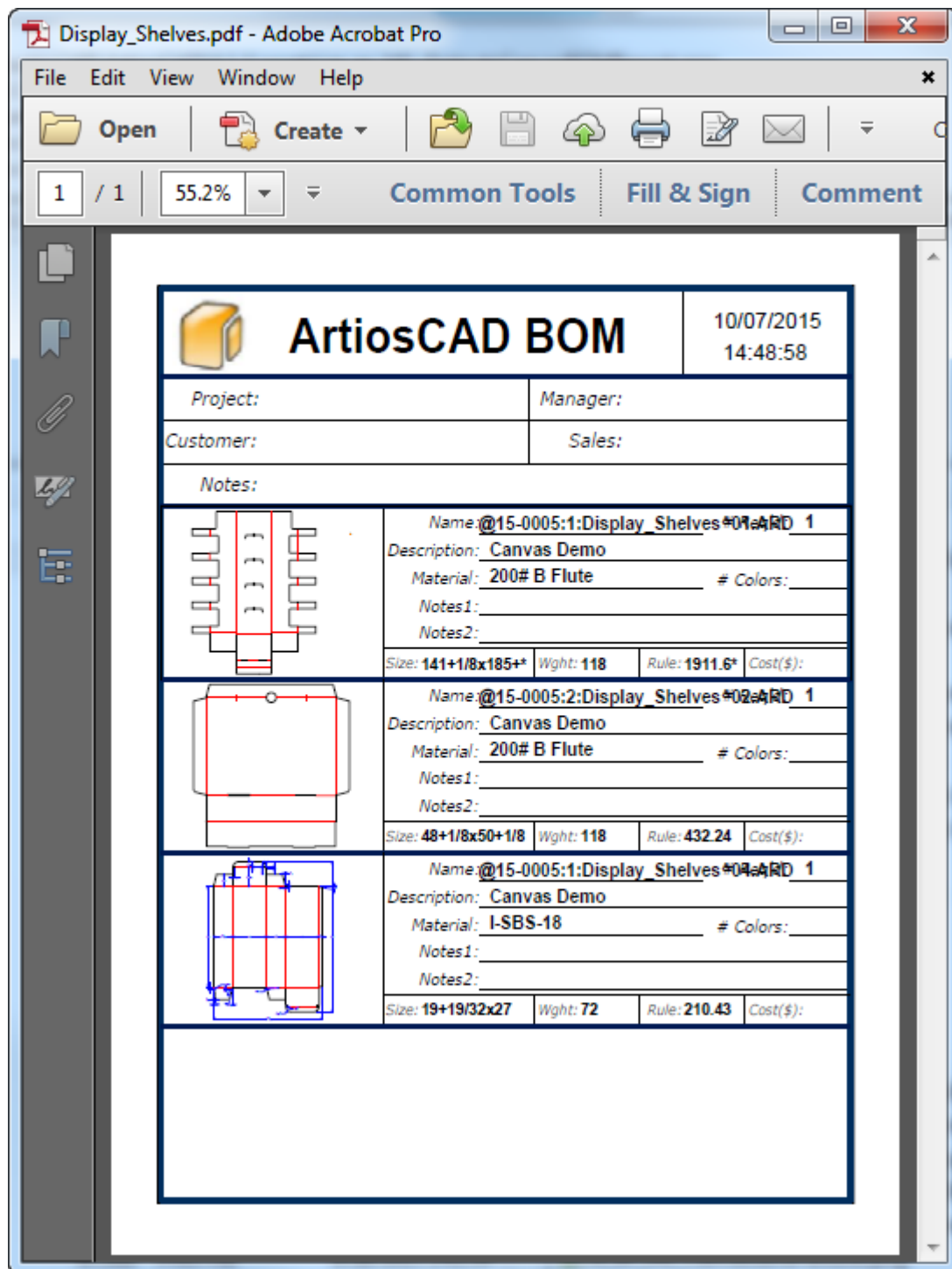

Running a part-by-part Output for a canvas

Part-by-Part Outputs run without prompting for more information. Make sure to configure them so that they do not need to prompt you for information. For example, for a

samplemaking output, make sure the directory is set correctly for the output file on the Directories tab of the Output definition in Defaults.

To run a part-by-part Output for a canvas, do the following:

1. Click the name of the canvas in the Parts List to select it.
2. Click **Parts > Parts Outputs** and then the desired Output. (The desired Output must have **Parts Outputs** selected in the Show In group in its definition in Defaults to appear in this list.)
3. ArtiosCAD opens the Select Parts dialog box.

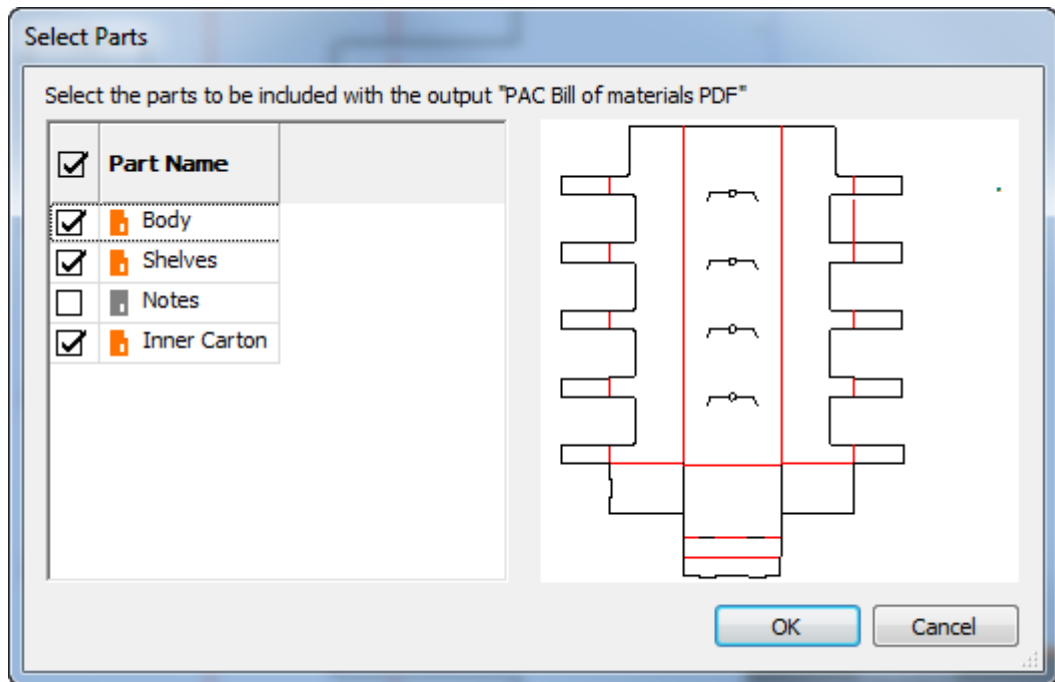

ArtiosCAD selects all Production-type parts by default. Click a part name to see its preview.

4. Select the parts to include in the Output and click **OK**.
5. Click **OK** to make the Output. If your Output goes to a file, ArtiosCAD precalculates the filenames so it can skip the Output confirmation dialog box for each part.

Shown below is an example part-by-part Output that created a PDF file. Each part is on a separate page.

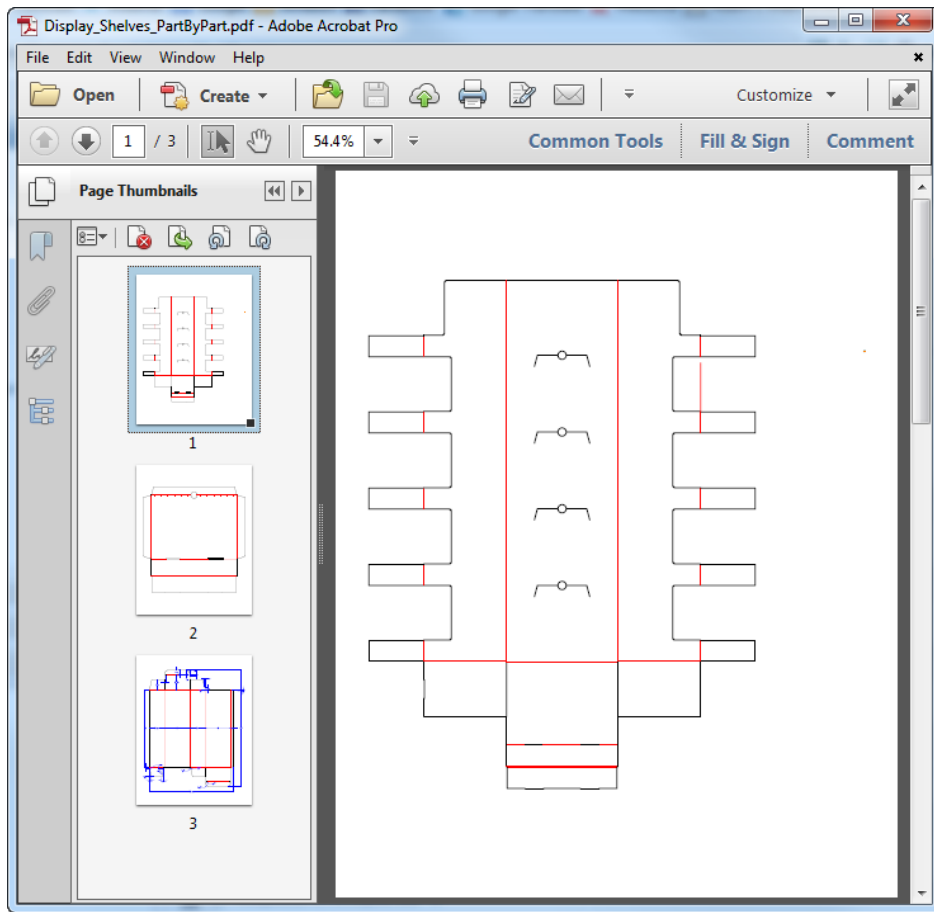

Reports around canvas layouts

Reports around canvas parts use geometry macros to add information about a layout part to the canvas. See **Outputs > Artios > Canvas > Report Around Canvas Part** for an example.

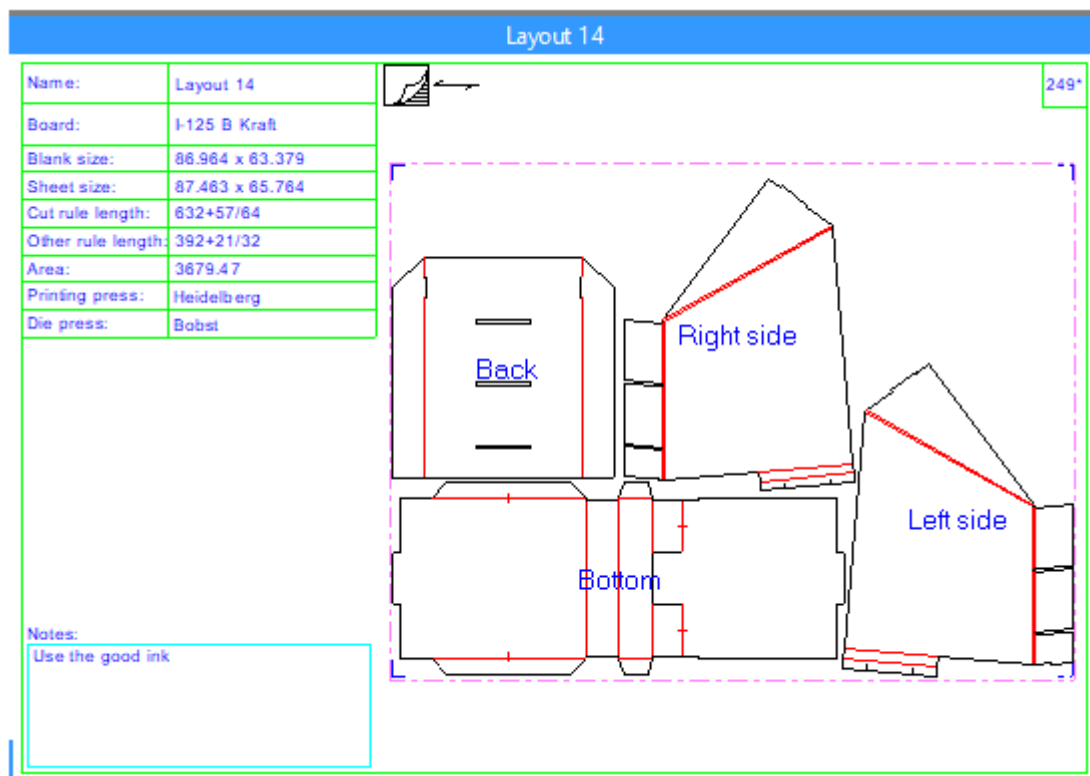

To use this Output, do the following:

1. Make a Layout part the active part and do everything needed to consider it done.
2. Run the Output.
3. Answer any prompted variable prompts.
4. ArtiosCAD creates the Report around the Layout part.

Deleting a Report Around a Layout Part

There are two ways to delete a Report Around a Layout Part:

1. Right-click the layout in the Parts List and click **Delete Layout Annotation** on the context menu.
2. Open the Sheet Properties dialog box for the layout and click **Delete Layout Annotation**.

Notes about Reports Around Canvas Parts

General Notes

If the Report overlaps other parts, drag the Layout part by its title bar to reposition it. If you turn off jobs, the automatic movement ArtiosCAD performs when turning jobs back on takes Reports into account.

You can have more than one Layout report in a canvas. All Reports go into the same Annotation layer. The sample Report makes a layer called Estimating Info. If you create your own Report, you can name the layer as desired.

You can run Reports of this type on Production or Hardware parts, but there will be no sheet information, and geometry tools are not available in hardware parts.

ArtiosCAD does not update in-place Reports automatically. Delete the existing one and re-run the Output if you change the Layout and need to update the information in the Report.

ArtiosCAD expands the Report if needed to fit around the Layout part, but does not shrink it if the Layout part is smaller than the File Window defined on the Report.

ArtiosCAD deletes the Report when you recalculate or rebuild the layout. Run the Output at the end of your workflow.

Double knife removal is not available for canvas layouts. To remove double knives, convert the layout to Manufacturing and remove them there. If you want to put the rule length after double knife removal on the Report, consider using an expression like LENTYPE(1) - #DKNIFE.as the value for a piece of calculated text.

Exporting parts with a Report

ArtiosCAD does not export sheet dimensions or Reports around a canvas part when you convert to Manufacturing.

If you save the part as a single design, ArtiosCAD does include the associated Report, and you can re-run the Output in it if you change the design.

To export Report data as XML, set the Output Type group to **Bill of Materials**, enable **Parts Outputs** in the Show In group, and set the Processing group to **XML** on the Project-Bill of Materials tab of the Output definition.

Creating your own Report Around a Canvas Part

To understand how to make your own Report to put around a canvas part, use ..\InstLib \ReportAroundPart.ARD as a guide.

1. Create a single design workspace and create borders and separators with annotation lines.
2.  Use **File Window** on the Reports toolbar to add a file window of type **Design** and set the Scale to **Scale report around canvas part**.
3. You may also add file windows of type **Symbol** as desired. Symbol file windows copy different workspaces into the file window based on an expression. Read more about Symbol file windows in [Using a Symbol file window](#) on page 1706 earlier in this chapter.
 - a) Some sample expressions are listed below. In order to have an empty Symbol window for a particular case, you need to have a blank workspace for ArtiosCAD to copy into the window.

Options	Description
GRAIN=2	Horizontal grain; use GRAINHOR.ARD
GRAIN=1	Vertical grain; use GRAINVER.ARD
SIDE<0	Outside side; use SIDEPRINTED.ARD
SIDE>0	Inside side; use SIDEUNPRINTED.ARD
CAL=0	Board caliper is 0, indicating a part has no board

4. Add prompted text, calculated text, and prompted userfields as desired.

- a) Some calculated text has different meanings depending on which type of part is active.

Calculated text	Production part	Layout part
Area	Part area	Total area of the parts
Waste on blank	Blank size minus part area as a percentage	Sheet size minus total area of the parts, as a percentage
Blank size	Blank size of this part	Total blank size of the layout (not the sheet)
Rule length	Rule length of this part	Total rule length in the layout
L, W, D	L, W, D for this part	L, W, D if all the parts in the layout have the same value, else blank
Board	Part board	Layout board
Part name	Part name	Layout part name

- b) Layout and sheet size calculated text only work for layout parts, not production parts.

Calculated text	System variable	Notes
Layout size X	#CUTSIZE X	
Layout size Y	#CUTSIZE Y	
Sheet size X	#SHTSIZE X	
Sheet size Y	#SHTSIZE Y	
Sheet size with grain	#SHTSIZE WG	
Sheet size cross grain	#SHTSIZE XG	
Sheet margins, trim	#SHTMARL ... #SHTTRIM B	See Useful variables for sheet dimensions on page 1109
Length of double lines	#DKNIFE	Can be subtracted from the total length
Number up	#NUP	Total number of designs on the sheet

5. When you are done designing your Report, you should have something like this. Save it and copy it to ServerLib.

Name:	PART #	Symbol	Symbol	Die number
Board:	Board Description	<div style="border: 1px solid green; padding: 20px; text-align: center;"> <p>Design 1</p> </div>		
Blank size:	Blankx,Blanky			
Sheet size:	Sheetx,Sheety			
Cut rule length:	Len.cut			
Other rule length:	Len.other			
Area:	Areanh.00			
Printing press:	my printing press			
Die press:	my die press			
Notes:	<div style="border: 1px solid cyan; height: 40px; width: 100%;"></div>			

6. Add it to the Report Catalog if desired.
7. Create an Output for it using these settings:
 - On the Output Type tab:
 - Type: **Plot**.
 - Scale: **1**
 - Show in: At least **Outputs** and **Parts Outputs**. It must have a file window that is scaled around a part to appear in Parts Outputs.
 - On the Device tab:
 - Driver type: **Workspace layer**
 - Layer name: anything, just not blank
 - On the Report tab:
 - Enable **Use Report**
 - Either select it from the Report Catalog or enter its filename in Report File Name.
8. Click **OK** to finish defining the Output.
9. Save and exit Defaults. You are now ready to use your Report.

16. DataCenter for Standard Edition

Introduction to DataCenter

DataCenter is a program which makes finding specific information about ArtiosCAD designs quick and easy. As you work, DataCenter automatically records facts about every single design and every manufacturing file you create or modify.

Note: DataCenter only works with ArtiosCAD Standard Edition. It is not installed with ArtiosCAD Enterprise. If you are using ArtiosCAD Enterprise, please ignore this chapter.

DataCenter has two intertwined parts – the information-gathering engine in ArtiosCAD and the browsers in which the information is viewed. The engine sends information to a database using MSDE, Microsoft SQL Server, SQL Server Express Edition, or Oracle.

Within ArtiosCAD, you can search for single designs and manufacturing files, as well as viewing information for embedded designs in manufacturing files. Other browsers, for information such as board codes, customers, userfields, and so forth are contained within the **DataCenter Admin** program in the **Esko > ArtiosCAD** program group.

Concepts and Ideas in DataCenter

Browsers

There are fifteen main areas of DataCenter called **browsers** that display information. They are:

- The **Design** browser (in ArtiosCAD)
- The **Manufacturing** browser (in ArtiosCAD)
- The **Embedded Design** browser (designs saved in manufacturing files, shown on a per-manufacturing file basis in ArtiosCAD)
- The **Projects** browser (in ArtiosCAD)
- The **Auto-Number** browser (in DataCenter Admin)
- The **Board** browser (in DataCenter Admin)
- The **Characteristics** browser (in DataCenter Admin).
- The **Company** browser (in DataCenter Admin)
- The **Company Type** browser (in DataCenter Admin)
- The **Counter** browser (in DataCenter Admin)
- The **Person** browser (in DataCenter Admin)
- The **Resource** browser (in DataCenter Admin)

- The **Server** browser (in DataCenter Admin)
- The **Userfield** browser (in DataCenter Admin; requires Information Enhancement module)
- The **Restricted Userfield Set** browser (in DataCenter Admin)

Viewing database information

In ArtiosCAD, to view all the single designs or manufacturing files in the database without searching for them, open the appropriate browser from the **Database > Browsers** menu.

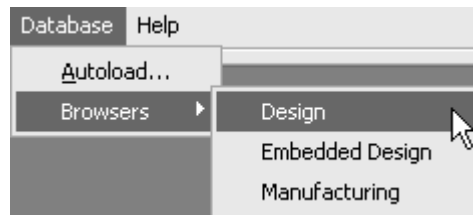

The browser windows are independent of the main ArtiosCAD window.

To view all non-design information, open **DataCenter Admin** in the ArtiosCAD program folder or on the desktop.

Sorting the list of information

All browsers except for Characteristics show a list of items in the database that can be sorted by column. To sort the information, click the button with the column name at the top of each column. Successive clicks of the same button change the sort order from ascending to descending and vice-versa.

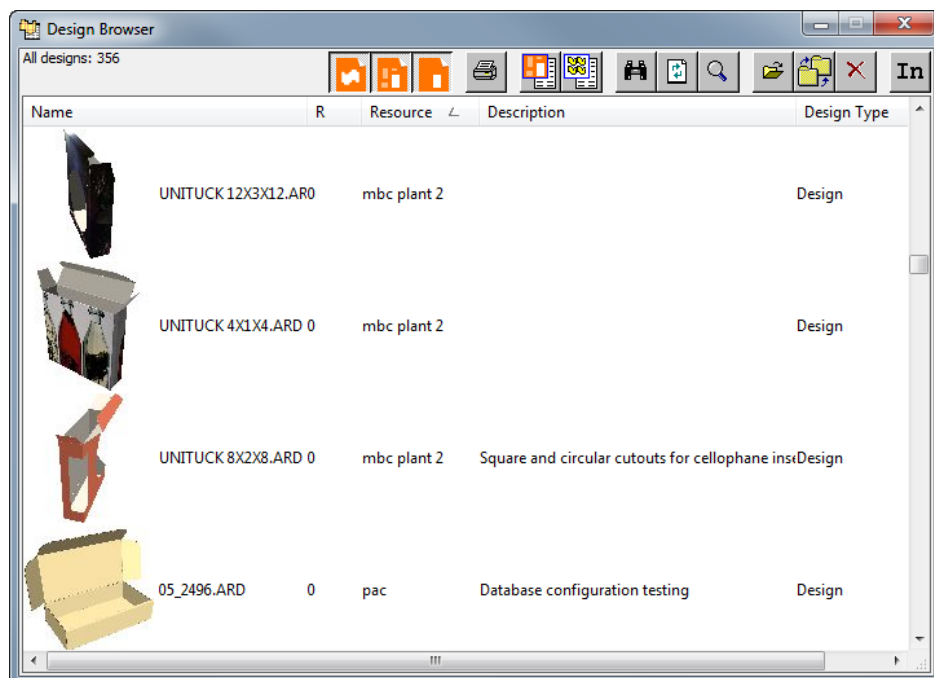

Selecting an item from the list and viewing its information

Double-click an item in the list to select it and view its details. The clicked item's information will appear beneath the list. Select more than one item by holding down CTRL and clicking the desired items.

The details area of the window usually has more than one tab. Switch to a different tab by clicking it. Shown below is the Design browser in ArtiosCAD.

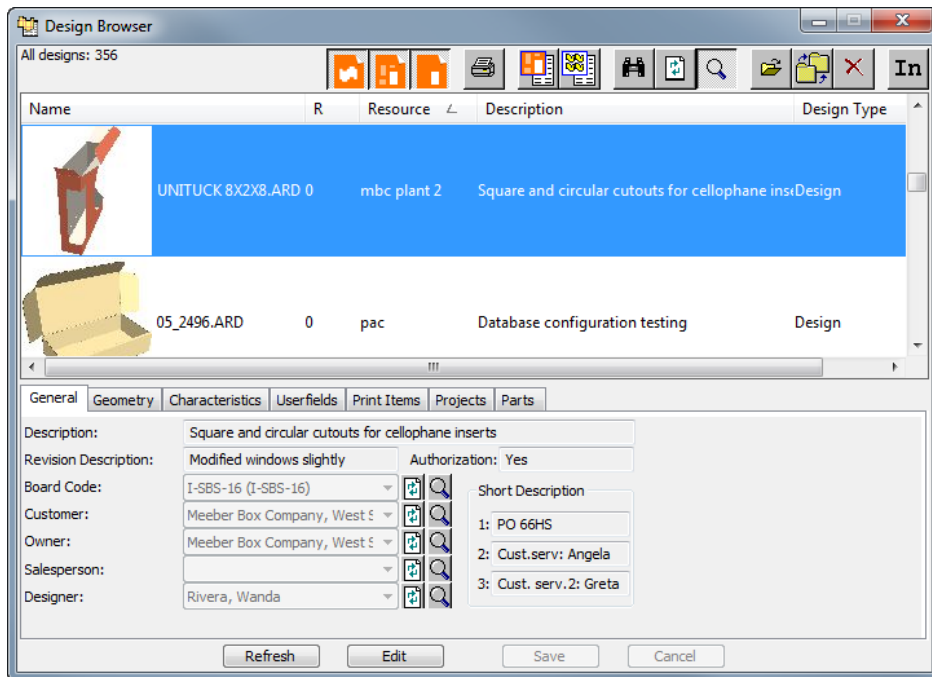

When one canvas is selected in the browser, the Parts tab shows parts, their filenames (if they have been saved as independent workspaces), their revision, and the location in which they are saved.

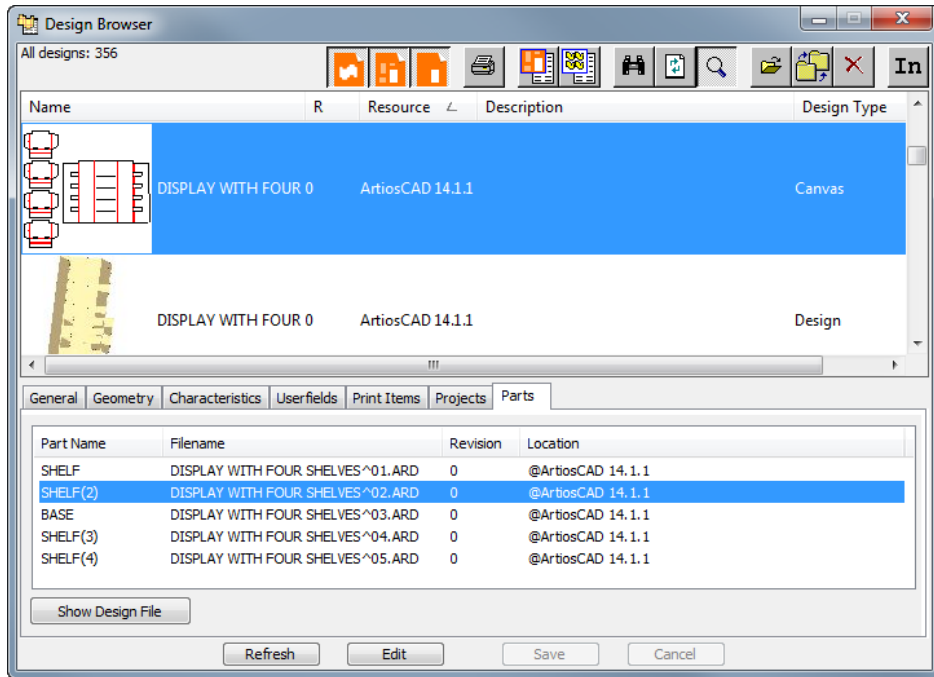

Click **Show Design File** to show the design file alone in the browser. In that browser, the Canvases tab shows which canvases use the design. Likewise, **Show Canvas** shows the selected canvas.

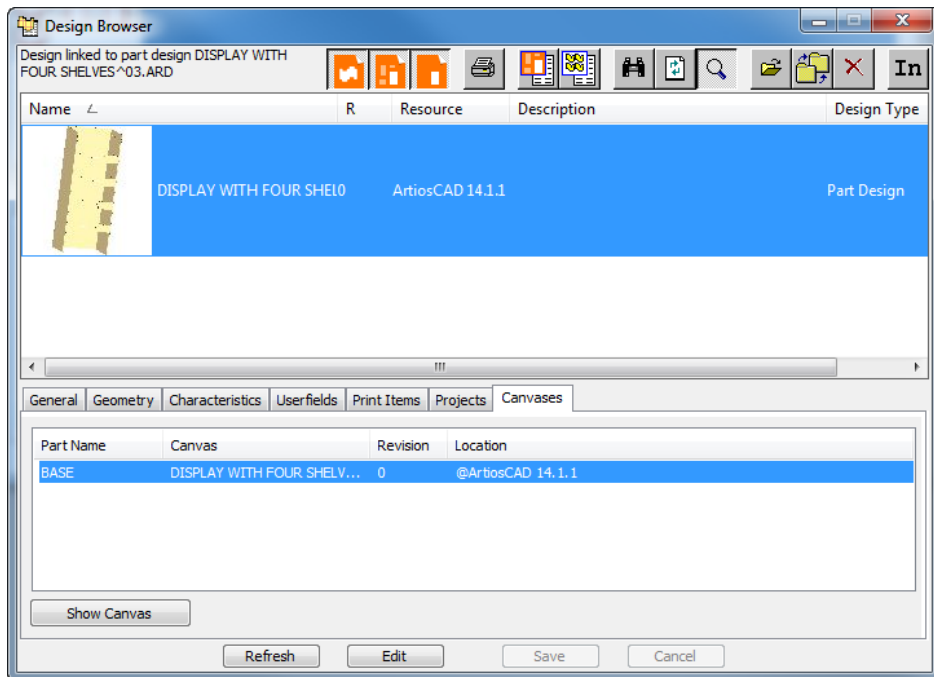

Shown below is the Manufacturing browser in ArtiosCAD showing the details for the selected manufacturing file.

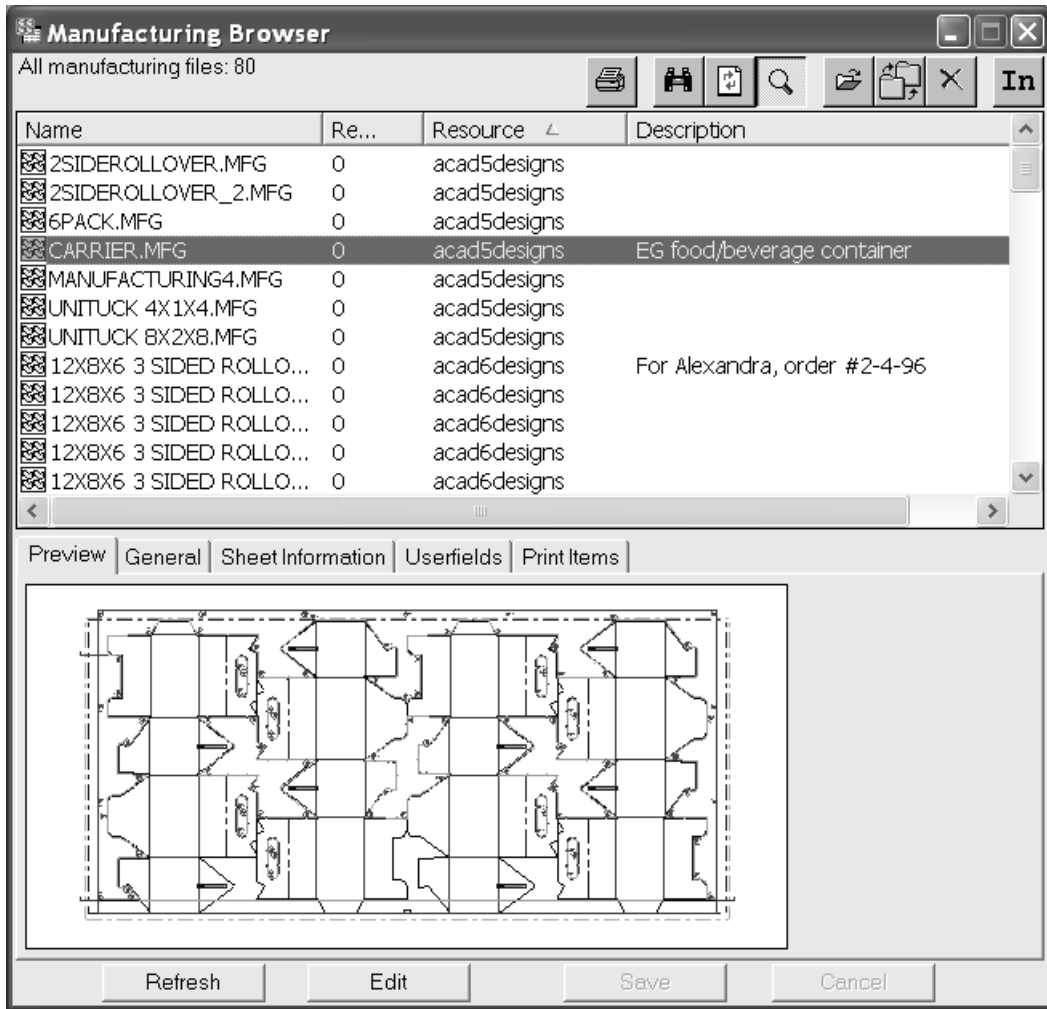

Shown below is the Embedded Design browser in ArtiosCAD showing the details for the selected item.

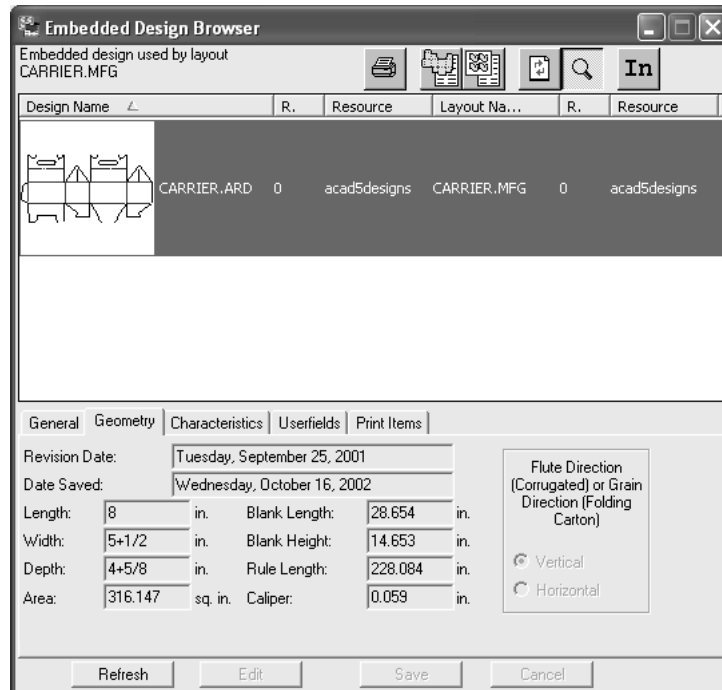

Shown below is the Company browser in DataCenter Admin showing the details for the selected item.

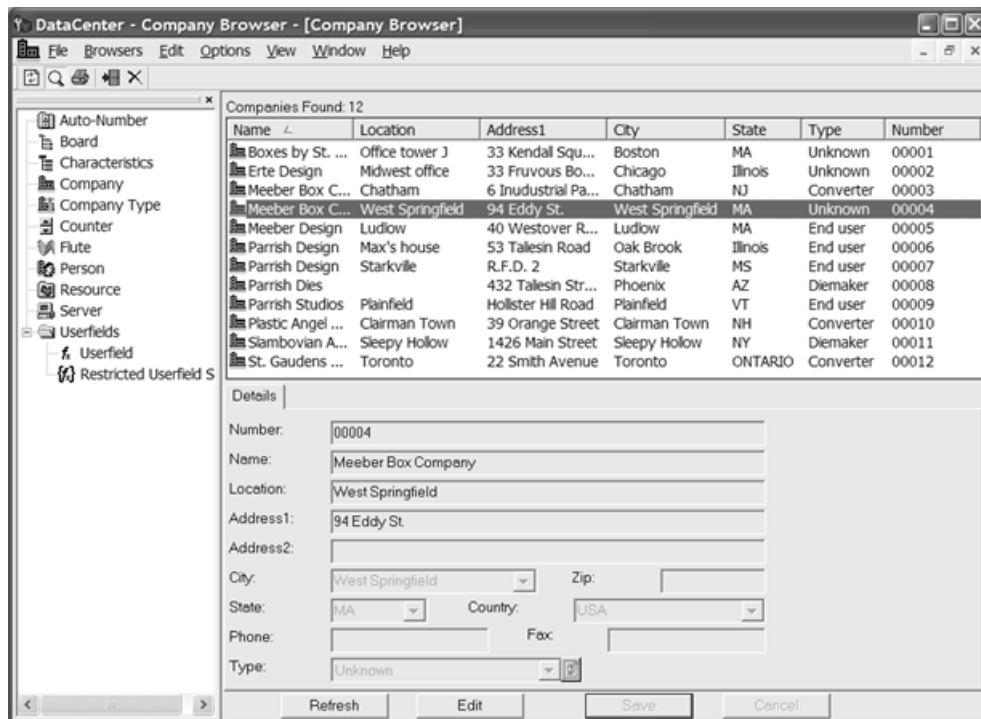

 To view specific information for a field, click **Show Item Details**. A dialog box appears showing details for the selected item. Click **Cancel** to close the dialog box.

View Customer ✕

ID:

Name:

Number:

Location:

Address(1):

Address(2):

City:

State:

Zip Code:

Country:

Phone:

Fax:

Company Type:

The toolbars

Each browser in ArtiosCAD has a unique toolbar, while the browsers in DataCenter Admin share the same toolbar.

Toolbars in ArtiosCAD Browsers

Shown below is the Design browser toolbar.



Shown below is the Manufacturing browser toolbar.



Shown below is the Embedded Design browser toolbar.



In the Design browser, the first three buttons control what types of designs the browser shows.



Show Design Files shows single designs.



Show Canvas Files shows canvases.



Show Parts Files shows parts.

At least one of these three buttons must be selected.



Clicking **Print** prints a report for the current browser.



Find Associated Design File in the Embedded Designs browser finds the non-embedded version of the design.



Show Associated Canvas Files shows the canvases containing the selected part. Only one record may be selected when using this feature.



Show Associated Manufacturing Files shows the manufacturing files containing an embedded copy of the selected design. Only one record may be selected when using this feature.



Edit Search Criteria opens the Search dialog box so that you can refine the search results.



Refresh Browser reloads the browser after clearing any search criteria.



Show Details toggles the display of the details area beneath the browser window.



Open file opens the selected file(s) in ArtiosCAD.



Move/Copy to New Resource opens the Copy/Move Item(s) dialog box, which lets you copy or move the current selection to a new resource.

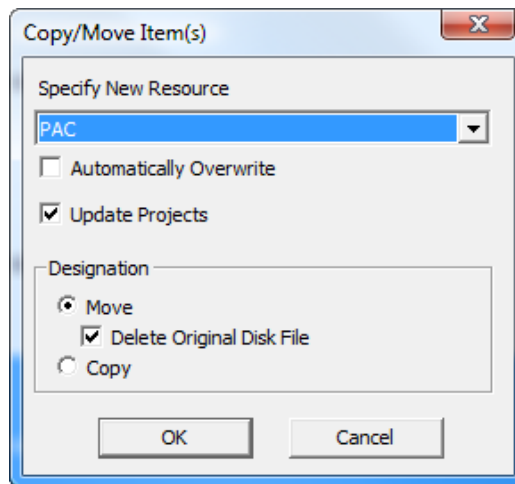

Specify the new resource in the **Specify New Resource:** drop-down list box. To overwrite files in the new resource without being prompted for each file, check the **Automatically Overwrite** checkbox. **Update Projects** prevents accidentally losing Project data when moving items between resources.

Note: Remember to back up your database regularly. Restoring it is the only way to recover from making such a mistake with Project data.

In the **Designation** group, choose to **Move** or **Copy**. If moving, check the **Delete Original Disk File** checkbox to remove the original file, leaving just the file(s) in the new resource. Click **OK** to perform the move or copy, or **Cancel** to return to the browser.



Delete deletes the current selection. When clicked, you are prompted to choose whether to delete both the database record and associated ArtiosCAD file or just the database record as shown below. Choose the desired option button and click **OK** to delete or **Cancel** to return to the browser with no deletion.

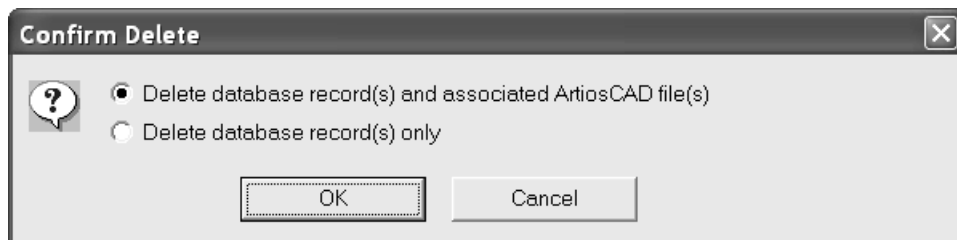

Units changes the units between imperial and metric.

Toolbar in DataCenter Admin

Shown below is the toolbar in DataCenter Admin.



Refresh resets the search criteria and reloads the browser.

 **Details** toggles the display of details for the selected item(s).

 **Reports** prints a report of the information in the current browser, or, if more than one item is selected, asks if the report is to encompass just the selected records or the entire browser.

 **Insert New Record** adds a new record to the current browser.

 **Delete** deletes the currently selected records. It is available only when there is a current selection. You are asked to confirm the deletion before it takes place.

Searching for information

A database is only as good as the information in it. To be useful, that information must be easy to retrieve. To retrieve the information quickly and easily, use the **Search** command on the File menu in ArtiosCAD.

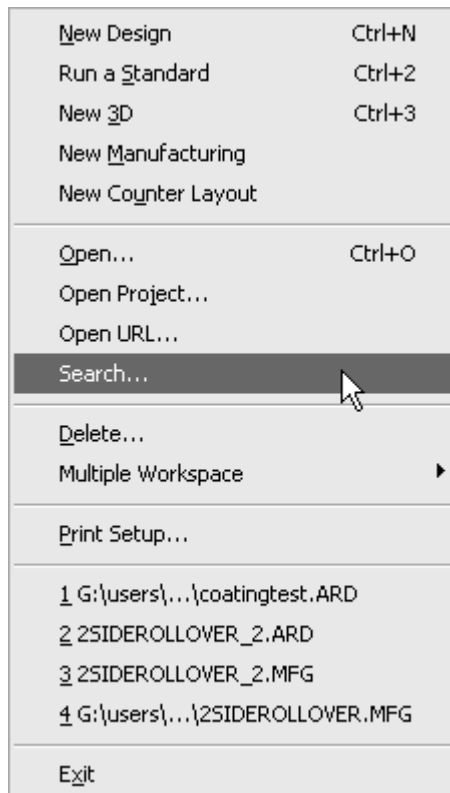

Shown below is the Search dialog box.

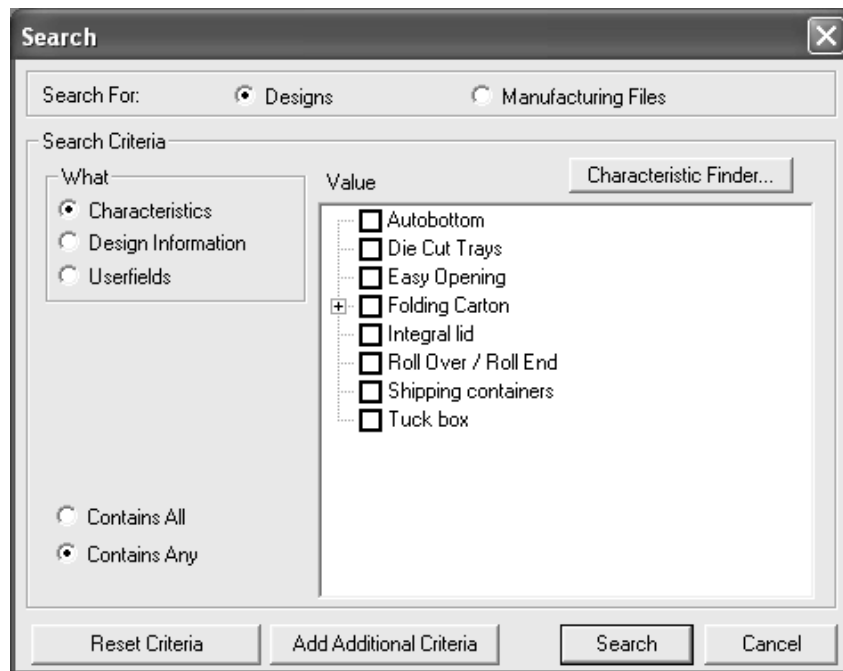

To search for information, do the following:

1. Start ArtiosCAD, and click **File > Search** to open the Search dialog box.
2. Select **Designs** or **Manufacturing files** in the **Search For:** group.
3. In the **What** field, choose the kind of data to use as search criteria.

Characteristics are attributes assigned to the design, such as the style of container, or its intended usage.

Design Information is information such as resource name, owner name, width, and so on. This option is unavailable when searching for manufacturing files.

Userfields are customizable variables whose values are saved in a single design or manufacturing file.

4. The option button selected in the **What** field controls the appearance of the rest of the **Search Criteria** group.

When it is set to **Characteristics**, the Characteristic tree appears, as do the **Characteristic Finder** button and the **Contains All** and **Contains Any** option buttons. As manufacturing files do not use characteristics, this option is unavailable when searching for them.

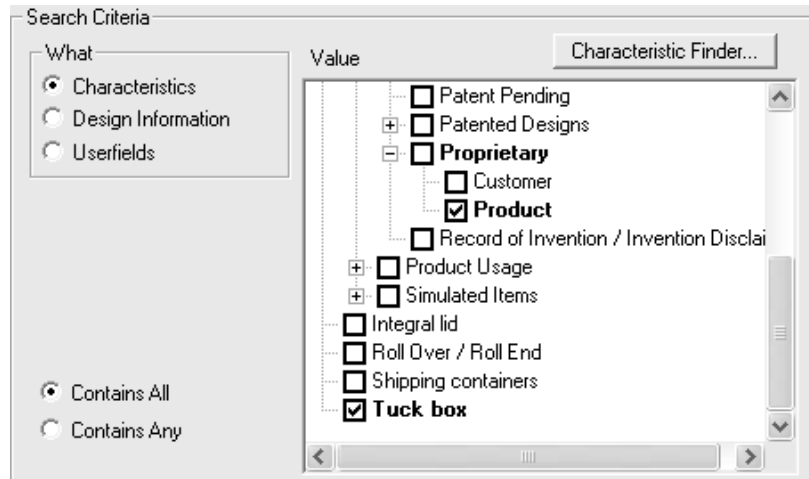

The Characteristics tree shows data hierarchically for easy categorization. Check the checkboxes for characteristics to search for. **Contains All** searches for single designs or manufacturing files which have all the selected characteristics defined. **Contains Any** searches for single designs or manufacturing files which have at least one of the selected characteristics.

The Characteristics Finder is described later in this chapter.

When the option button in the **What** field is set to **Design Information** or **Userfields**, the **Where**, **How**, and **Value** fields appear. The **How** field appears after the **Where** field is set, and the **Value** field appears after the **How** field is set.

In the **Where** field, choose the type of item to search for.

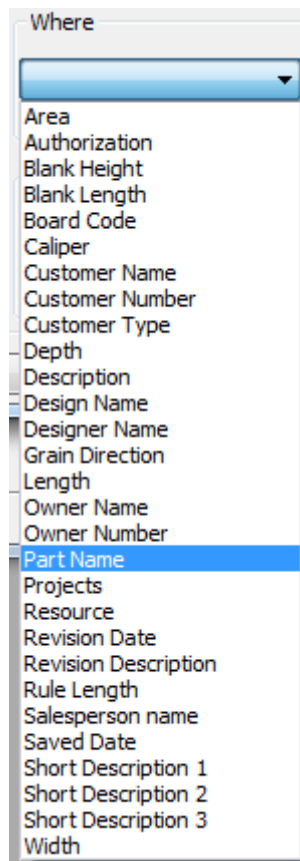

For text items, in the **How** field, choose **Equals** to set the **Value** using something already in the database. Choose **Begins With** to match items that begin with the text you enter. Choose **Contains** to type a custom value.

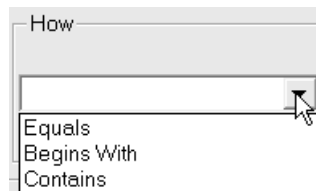

For numeric selections in the **Where** field, **>=** (greater than or equal to), **<=** (less than or equal to), and **Is Between** are available in the **How** field. When using **Is Between**, enter the lower limit in the **From** field and the higher limit in the **To** field.

In the **Value** field, either choose an item from the dropdown list (if **Equals** is selected in the **How** field) or type the desired information to search for (if **Contains** is selected in the **How** field).

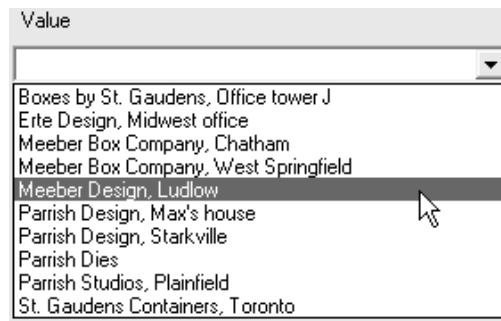

5. Once all the fields have values entered, you can Search or click **Add Additional Criteria** to add more search conditions. Add the new search conditions just as you created the first set, making sure to click **Add Additional Criteria** after choosing the last set to add it to the criteria list. To delete a set of criteria, select it and click **Delete**.

Additional Criteria			Delete
What	Where	How	Value
Design Information	Owner Name	Equals	Meeber Box Com
Characteristics	All Characteristics	Contains All	Tuck box
Userfields	Ship Method	Contains	Overnight

Once you are satisfied with all the search criteria, click **Search**. The Design Browser or the Manufacturing Browser appears containing the results of the search.

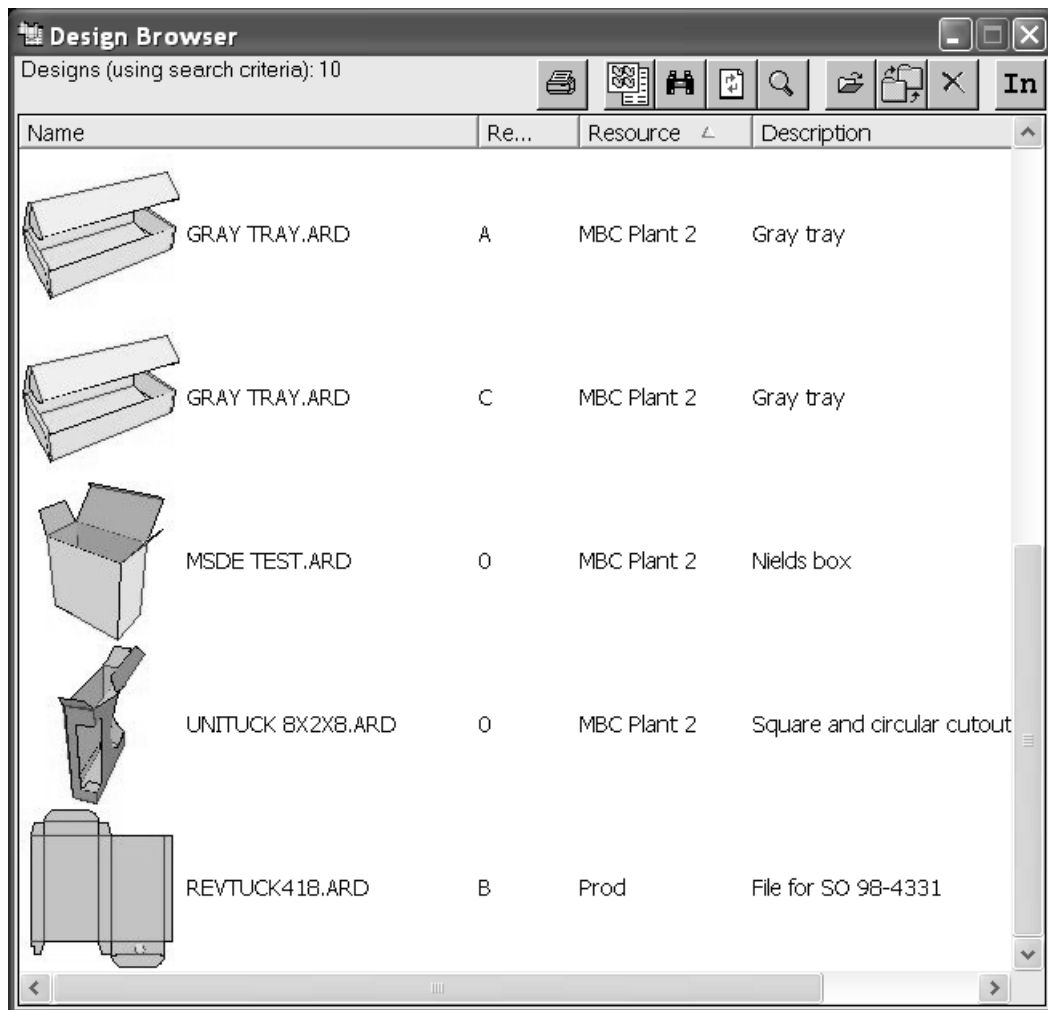

You can return to the Search dialog box by clicking the **Search** button on the browser toolbar.

Servers and resources

A fundamental concept of DataCenter is the idea of resources and servers. Each *resource* tracks all the files in one directory. To track the files in a directory in the database, a resource needs to be created. Resources will automatically be created for files placed in any subdirectory of a master resource. The directory for each resource is defined relative to locations called *servers*. A server is typically a hard drive.

For the beginner, Esko recommends setting up one master resource per server. Master resources make resources for each subdirectory created inside them after they are designated as master resources. This ensures that all designs are tracked in the database. If you set up multiple regular resources and have no master resource, and someone creates a new directory but does not create a resource to go along with that directory, any work saved in that directory will not be tracked.

When you load ArtiosCAD for the first time, a database server is created for the drive ArtiosCAD is loaded on, and a master resource is created for the default file-saving location (e.g. `\Esko\Artios\Designs`). In this manner, all work that you save in the default directories is tracked in the database. Any subdirectories made under the master resource will have resources created automatically, so the work saved in those directories will be tracked in the database. If you install ArtiosCAD yourself, the database server and resource are set to the drive and user directory you specified while loading.

Configuring DataCenter

When you start using DataCenter with ArtiosCAD, only the work saved under the `\Users` or `\Esko\Artios\Designs` directory is saved into the database by default. If you create new directories on drives other than where you installed ArtiosCAD, and want DataCenter to track the work you save in those directories, you have to create a database server for that drive in DataCenter Admin as well as resources for those directories.

All configuration is done in the DataCenter Admin program in the ArtiosCAD program folder.

Working with servers and resources

As explained earlier in this chapter, servers and resources are the places on your computer where you store work done in ArtiosCAD.

You must create database servers before configuring resources.

Creating a server

To create a database server, do the following:

1. Share the drive or directory you wish to be a database server.
2. Start DataCenter Admin.
3. Double-click the **Server** browser entry to open it.
4.  Click **Insert New Record** on the toolbar.
5. Enter the name of the new server in the **Name:** field.
6. Click in the **Path:** field and type the UNC locator for that drive, or click the **Browse** button to navigate to the proper directory. If you type the entry, make sure to enter it correctly as no error-checking is done for typed entries.

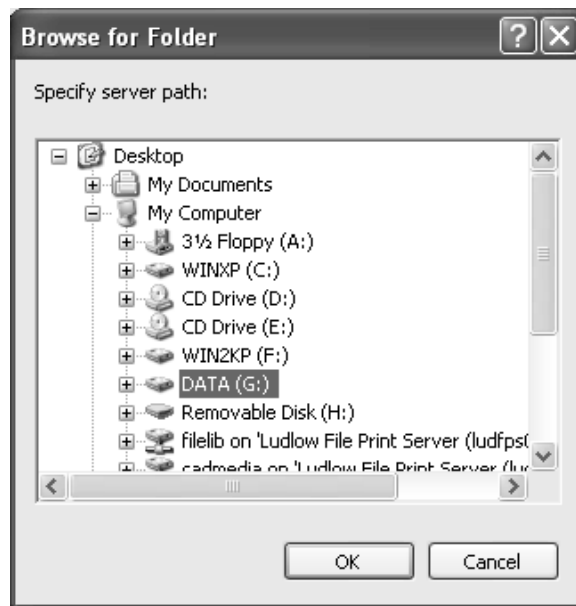

7. Choose the drive or directory to be the new server and click **OK**.
8. Click **Insert** to add the new server or click **Cancel** to cancel.
9. Exit the Server Browser, if desired, by closing its window.

Creating a resource

To create a resource, do the following:

1. Start DataCenter Admin.
2. Double-click the **Resource** browser entry to open it.
3.  Click **Insert New** Record on the toolbar.
4. Enter a name for the resource in the **Name** field.
5. Click in the **Server:** field and select the server for the new resource from the drop-down list.
6. Click in the **Directory:** field and either type the directory name or click the Browse button and select the directory for the new resource. If you type the entry, make sure to enter it correctly as no error-checking is performed for typed entries.



7. Once you have selected the desired directory, click **OK**.
8. To create the new resource, click **Insert**; to cancel its creation, click **Cancel**.
9. Exit the Resource Browser, if desired, by closing its window.

It is prudent to leave the **Master** checkbox checked when creating a resource. This ensures that all new work in any subdirectories that may be created will be tracked. The **Active** checkbox specifies whether DataCenter tracks the work saved in the resource. **Inherit Auto-Number** controls whether or not the resource will use Auto-Numbering if its parent resource uses it.

Deleting a server

You cannot delete servers containing resources. If a server has resources in it, you must either delete them or change the server they reference. Also, when you delete a server, only the information in the database is deleted. The actual designs are not deleted.

To delete a server, do the following:

1. Start DataCenter Admin.
2. Double-click the **Server** browser to open it.
3. Select the server to delete.
4.  Click Delete.
5. If you really want to delete the server, click **Yes** when asked.
6. The server entry will be deleted. If the server still contains resources, you will be told that servers cannot be deleted which contain resources. You will have to delete the resources and then try again.

Deleting a resource

When you delete a resource, the ArtiosCAD workspaces stored within them are also deleted. **Use this procedure with great caution.**

To delete a resource, do the following:

1. Start DataCenter Admin.
2. Double-click the **Resource** browser to open it.
3. Select the resource to delete.
4.  Click **Delete**.
5. Click **Yes** to delete the resource. If there are files in the resource, DataCenter Admin asks you to confirm the deletion. Click **Yes**.
6. The resource is deleted.

Userfields

Userfields are customizable fields for designs and manufacturing files that can contain almost any kind of information.

Userfields:

- Can contain text, integers, decimal numbers (called *floats*), distances, areas, volumes, or weights.
- Are specific to the type of workspace; design userfields cannot be used in manufacturing files, and vice-versa.
- Can be included on reports.
- Can have their values restricted to a list defined in the Restricted Userfield Set browser.

For designs, 36 userfields come pre-created in DataCenter. There are no pre-made userfields for manufacturing files.

When you make your own userfields, you can specify that they are required userfields. Required userfields are stored automatically in each workspace. For example, if you have a piece of information you want stored in every single design you make, you can add a required userfield via the Userfield browser in DataCenter Admin. The information contained in the userfield will be saved in each workspace; you cannot change the value of a required userfield in a workspace.

There are four steps to using userfields.

1. Tell DataCenter which userfields to track. You can immediately start using the pre-created userfields.
2. Configure restricted sets if desired.
3. Set values for specific userfields in designs or manufacturing files.
4. Set up formulae to automatically set values for userfields when they are added to designs or manufacturing files.

Adding userfields to DataCenter

To add userfields to DataCenter, do the following:

1. Start DataCenter Admin.
2. Open the Userfields folder if necessary and double-click the **Userfield** browser to open it.
3.  Click **Insert New Record**. The Details tab appears in the browser as shown below.

4. Choose the appropriate type of userfield in the **Category** field.
5. Enter an identification number for the userfield in the **Userfield ID** field. This can be any number.
6. To have this userfield present in every design or manufacturing file, check the **Required** checkbox.
7. Enter a name for the userfield in the **Name** field.
8. Choose the type of userfield from the **Format** drop-down list box.
9. Choose the way the userfield value is supplied. To enter a value for the userfield every time it is used, select the **Prompted** option button.

To have it supplied by ArtiosCAD automatically, select **Calculated Expression** and enter the expression in the associated field. Use this method for setting a default value for the userfield - just enter the desired value in the field without using variables. If entering a text item, enclose it in quotes to prevent ArtiosCAD from treating it as variables.

To have it use a Restricted Set, select **Restricted Set** and choose the set from the drop-down list box. (You must have a restricted set already defined in the Restricted Userfield Set browser.)

10. Click **Insert** to insert the new record into the database.

Setting up a restricted userfield

Restricted userfields are userfields that have a set range of values from which you can choose when setting them. These sets of values are configured in the Restricted Userfield Set browser. Sets of values can be used with as many userfields as desired.

To configure a restricted set, do the following:

1. Start DataCenter Admin.
2. Open the Userfields folder if necessary and double-click the **Restricted Userfield Set** browser to open it. It contains no data by default, so when it is opened for the first time, it is as if **Insert New Record** was clicked.

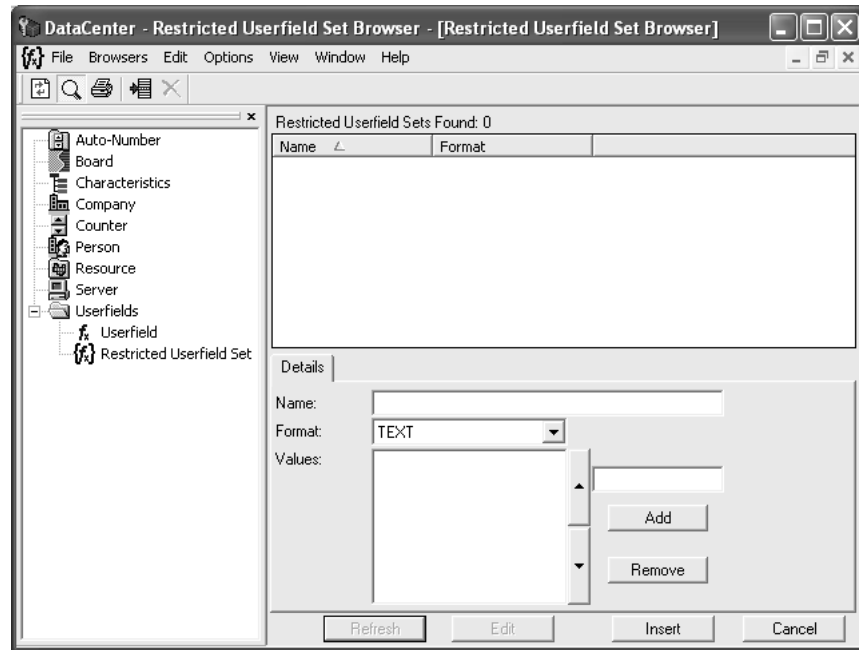

3.  If there are already restricted sets configured, click **Insert New Record**.
4. Enter a name for the set in the **Name** field.
5. Set its format using the **Format** drop-down list box. Make sure it is the same format as its corresponding userfield(s); for example, sets of type INTEGER cannot be used with userfields of type FLOAT.
6. Enter the first value for the set in the field above **Add**. It will appear in the **Values** list. Continue adding values by entering them in the field and clicking **Add**. To reorder them, select a value and use the directional arrows to change its position in the list.

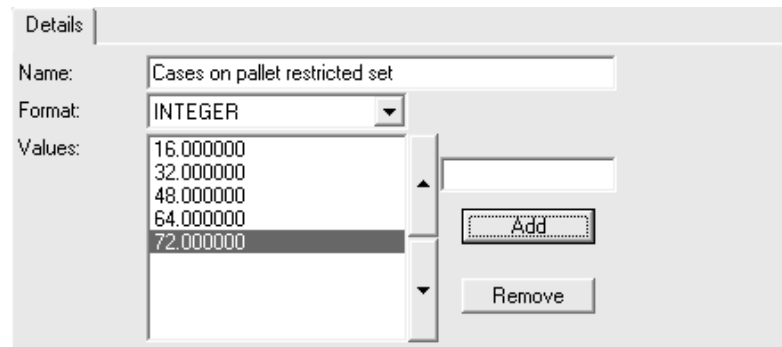

7. When done entering values, click **Insert** to insert the record into the database.

Deleting userfields from DataCenter

To delete userfields, do the following:

1. Start DataCenter Admin.
2. Open the Userfields folder if necessary and double-click the **Userfield** browser to open it.
3. Select the userfield to delete.

4.  Click **Delete**.
5. You are asked to confirm the deletion of the userfield. Click **OK** if you really want to delete it; otherwise, click **Cancel**.

Configuring companies

The **Company** browser manipulates information about companies. No companies are defined by default.

Adding a company

To add a company, do the following:

1. Start DataCenter Admin.
2. Double-click the **Company** browser to open it.
3.  Click **Insert New Record** on the toolbar.
4. Enter the information for the company in the appropriate fields. The **Number:** field is optional and is text only; it is not calculated.
5. Click **Insert**.

To add more companies, repeat steps 3 through 5.

You may also add a company when saving a design by clicking **New** in the Customer Browse dialog box.

Deleting a company

To delete a company, do the following:

1. Start DataCenter Admin.
2. Double-click the **Company** browser to open it.
3. Select the company to delete.
4.  Click **Delete**.
5. Click **Yes** to confirm the deletion.
6. If the company name is used in any design, you are prompted to **Replace** it with another, **Clear** it from the affected record(s), or **Cancel** the operation. If you are deleting more than one company at once, you can also replace all the companies with one by choosing **Replace All**.



To delete more companies, repeat steps 3 through 5.

Changing how company identifiers are shown

On the **Options** menu, you can choose different ways for how company identifiers are shown in DataCenter Admin.

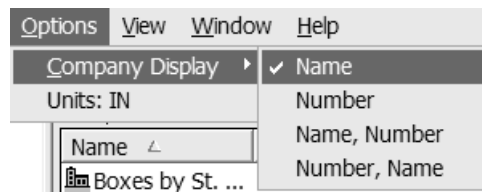

Choose **Name**, **Number**, **Name, Number**, or **Number, Name** as desired.

Configuring company types

The **Company Type** browser lets you add and remove company types. Company types are used in company definitions. Examples of company types are **Converter**, **Diemaker**, and **End user**.

Adding a company type

To add a company type, do the following:

1. Start DataCenter Admin.
2. Open the **Company Type** browser by double-clicking it.
3.  Click **Insert New Record**.
4. Enter a unique code and a description for the company type in the appropriate fields.
5. Click **Insert**.

Deleting a company type

To delete a company type from the database, do the following:

1. Start DataCenter Admin.
2. Open the **Company Type** browser by double-clicking it.
3. Select the company type to delete.
4.  Click **Delete**.
5. Click **Yes** to confirm the deletion.
6. If the company type is in use, you are prompted to **Replace** it with another, **Clear** it from the affected record(s), or **Cancel** the operation. If you are deleting more than one company type at once, you can also replace all the company types with one by choosing **Replace All**.

To delete more company types from the database, repeat steps 3 through 5.

Configuring people

DataCenter tracks salespeople and designers as well as design information. Information about people is stored in the **Person** browser.

Adding a person

To add a person's information to DataCenter, do the following:

1. Start DataCenter Admin.
2. Open the **Person** browser by double-clicking it.
3.  Click **Insert New Record**.
4. Enter the information about that person in the appropriate fields.
5. Click **Insert**.

Deleting a person's information

To delete a person's information from the database, do the following:

1. Start DataCenter Admin.
2. Open the **Person** browser by double-clicking it.
3. Select the person whose information is to be deleted.
4.  Click **Delete**.
5. Click Yes to confirm the deletion.

6. If the person's information is used in any design, you are prompted to **Replace** it with another, **Clear** it from the affected record(s), or **Cancel** the operation. If you are deleting more than one person's information at once, you can also replace all the people with one person by choosing **Replace All**.

To delete information about more people from the database, repeat steps 3 through 5.

Configuring board information

ArtiosCAD gets all information about boards from DataCenter, so it is important that the Flute and Board browsers contain accurate information. Papers and flutes must be defined prior to trying to use them to define corrugated boards.

Boards are **hierarchical**; that is, they may be organized in a hierarchy of folders for more effective organization and easier access.

If this installation of ArtiosCAD is an upgrade from a previous version, the old board table is converted to the new hierarchical format during the upgrade, and new boards are added. New boards in the Artios folder hierarchy will not replace previously-existing boards with the same name and description; those will remain in the top-level Corrugated and Folding Carton folders.

AutoLoad does not rebuild 3D or paper information for boards. In the event of a database malfunction, this information can come either from a database backup that is restored through DataCenter Admin, or by using the ArtiosCAD Database Export and Import utilities to export and import the board table.

Your board browser may look different depending on if you loaded ArtiosCAD as a new installation or if you upgraded a previous installation. Shown below is an example Board browser for a new installation:

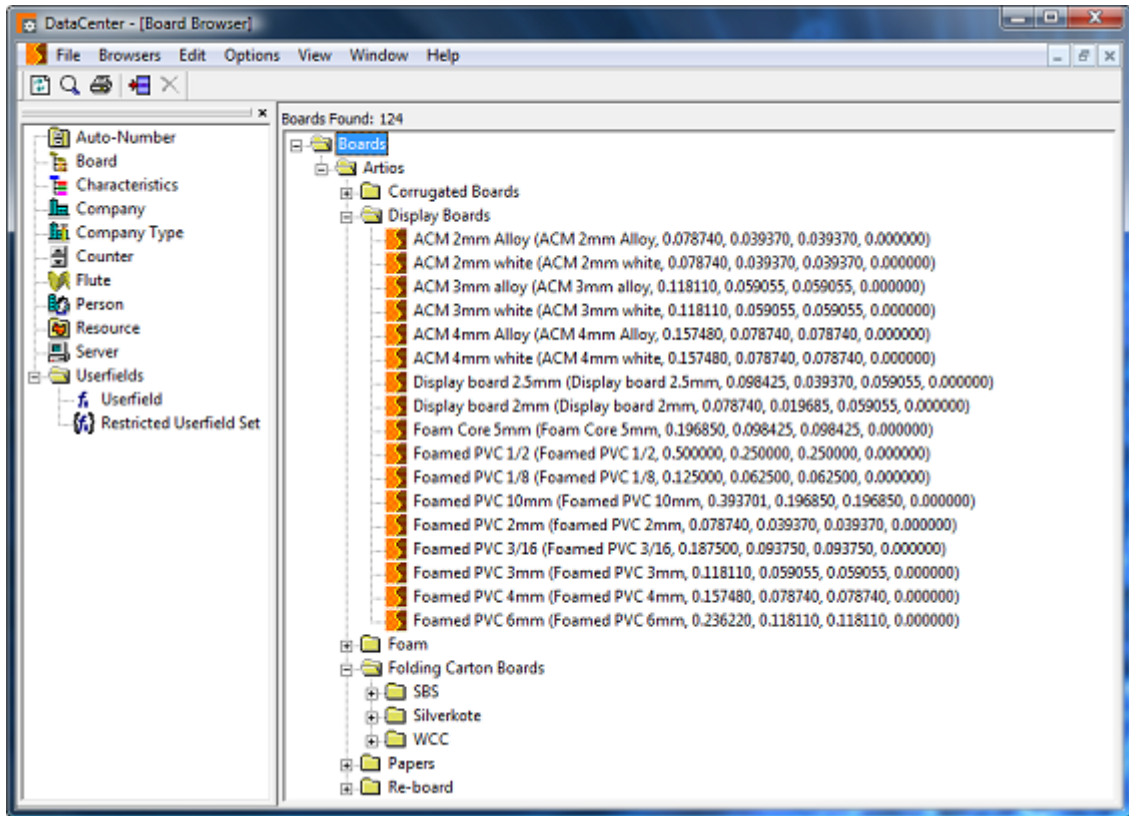

Shown below is an example Board browser for an upgraded system.

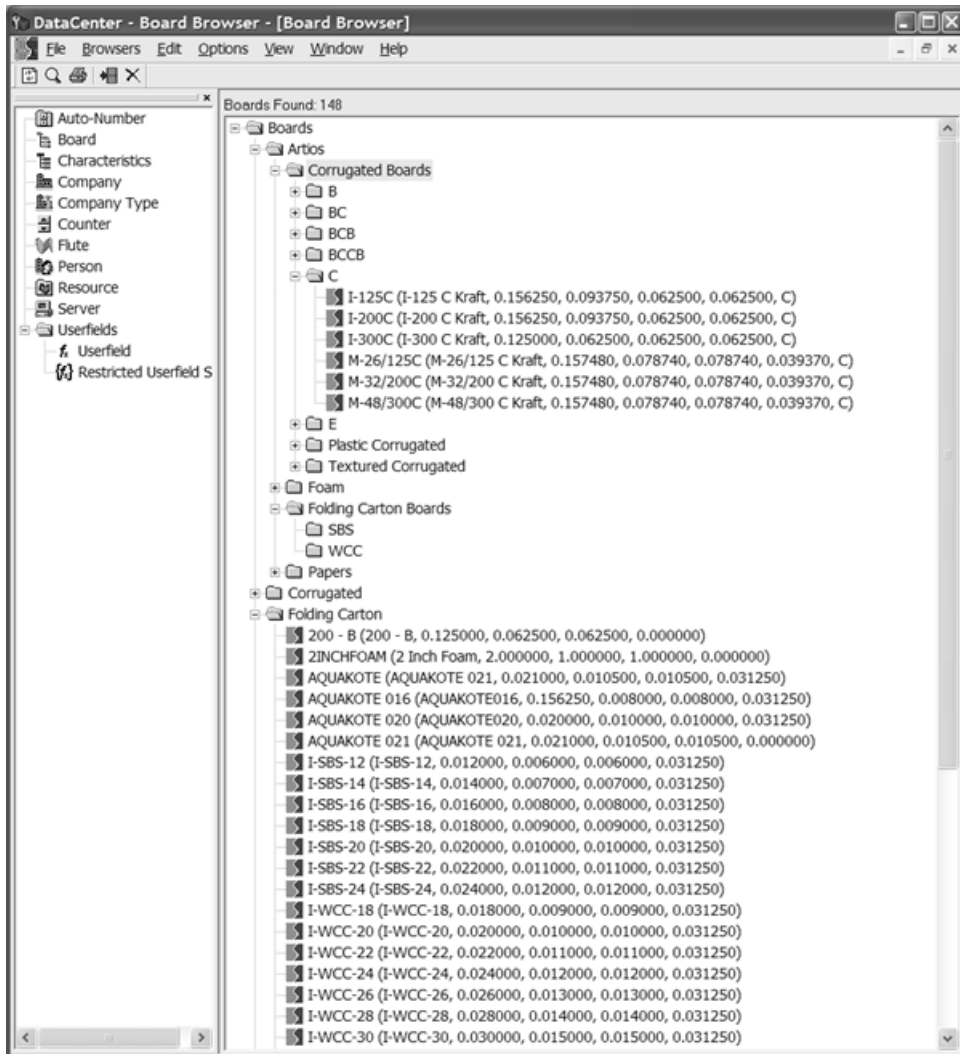

Corrugated board is built from wavy (corrugated) paper glued to flat paper. The flat paper is called a **liner**, and the wavy paper is called a **medium**. The medium is defined in terms of a **flute**, a letter code generally from A to F, with A being the thickest/largest and F being the smallest/thinnest.

Folding carton board is one layer of material, usually made from paper that is Solid Bleached Sulfate or White Clay Coated.

Because texture and paper information is stored in the database, it is important to back up the database as board information changes, because complete board information cannot be recreated only by using AutoLoad. For more information about backing up an MSDE or SQL Server Express Edition database, see the *Other Tasks* chapter.

Creating a paper

To create a new paper, first examine an existing paper to determine what information you will need to define the new paper. Usually the caliper, inside loss, outside gain, rounding value, basis weight, and basis cost are needed. You may also set inside and outside colors and other appearance attributes to the paper that appear in the optional 3D module.

To create a new paper, do the following:

1. Start DataCenter Admin.
2. Open the Boards browser, and then open the Artios catalog by clicking the plus sign (+) next to it.
3. Click the word **Papers** to select it.
4.  Click **Insert New Record**, or right-click and click **New** > **Board**. The Details pane will automatically appear with the fields enabled for editing.

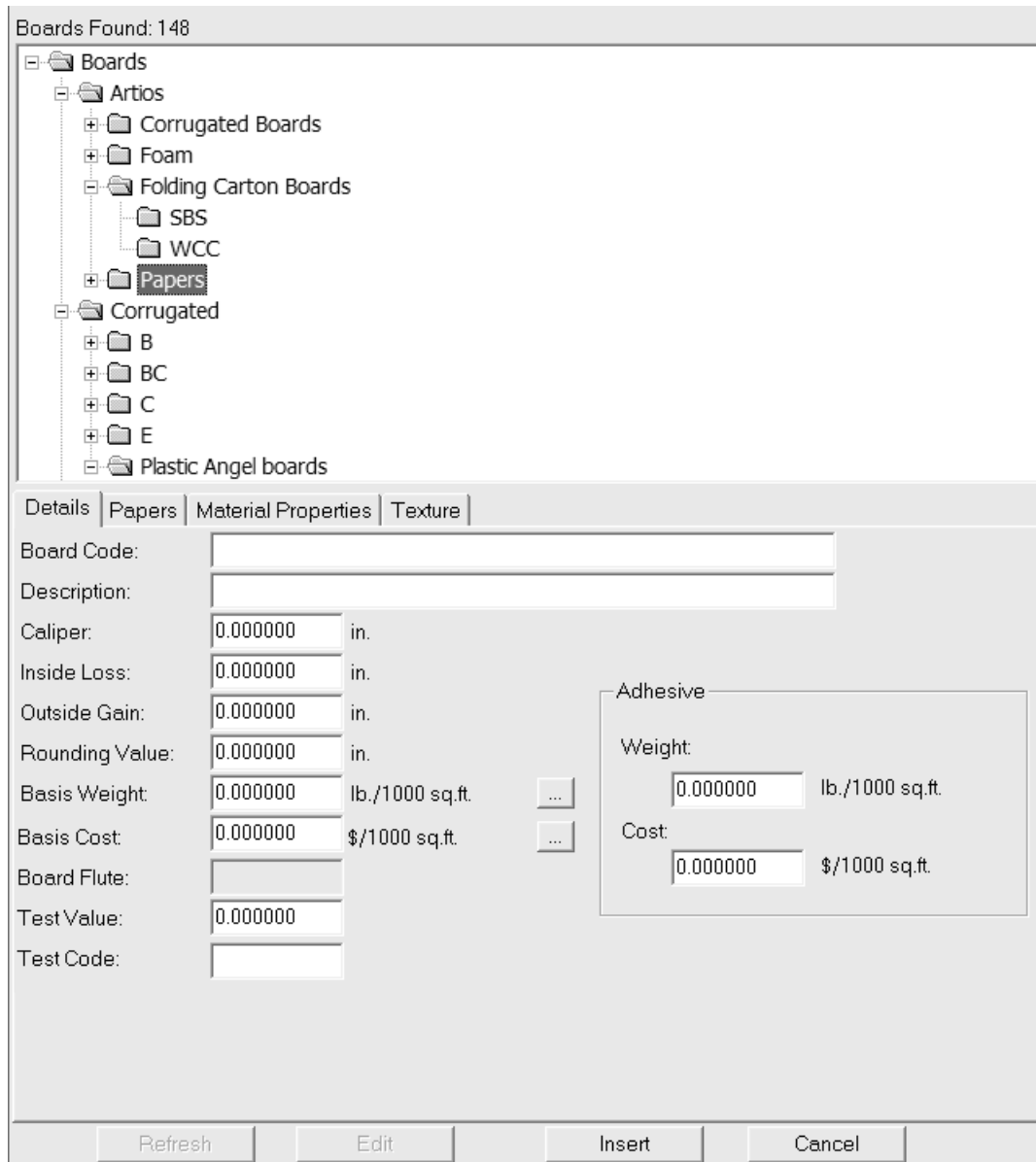

The screenshot shows the 'Boards Found: 148' browser with a tree view. The 'Papers' folder is selected. Below the browser is the 'Details' pane with the following fields:

Board Code:	<input type="text"/>
Description:	<input type="text"/>
Caliper:	<input type="text" value="0.000000"/> in.
Inside Loss:	<input type="text" value="0.000000"/> in.
Outside Gain:	<input type="text" value="0.000000"/> in.
Rounding Value:	<input type="text" value="0.000000"/> in.
Basis Weight:	<input type="text" value="0.000000"/> lb./1000 sq.ft. <input data-bbox="877 1355 917 1388" type="button" value="..."/>
Basis Cost:	<input type="text" value="0.000000"/> \$/1000 sq.ft. <input data-bbox="877 1400 917 1433" type="button" value="..."/>
Board Flute:	<input type="text"/>
Test Value:	<input type="text" value="0.000000"/>
Test Code:	<input type="text"/>

An 'Adhesive' sub-pane is also visible with the following fields:

Weight:	<input type="text" value="0.000000"/> lb./1000 sq.ft.
Cost:	<input type="text" value="0.000000"/> \$/1000 sq.ft.

At the bottom of the Details pane are buttons for 'Refresh', 'Edit', 'Insert', and 'Cancel'.

5. Enter values in the fields on the Details tab as appropriate.

Board Code: is the identifier used by the database to identify this new paper; each paper must have a unique code.

Description: is the description of the paper.

Caliper: is the thickness of the paper.

Inside Loss: and **Outside Gain:** are the allowances used when folding the paper or when gluing it together (such as in a glue flap). They are generally half the caliper.

Rounding Value: sets a value to which dimensions may be set to round to when constructing a corrugated design. It is more relevant for boards as a whole rather than individual papers.

Basis Weight: is the weight of the paper in local currency and units of measurement.

Basis Cost: is the cost of the paper in local currency and units of measurement.

Test Value: is the amount of weight needed to break the material when performing very specific standardized tests. It is more relevant for corrugated boards as a whole than individual papers.

Test Code: is the identifier used in correlation with the Test Value to show the strength of the paper. It is more relevant for corrugated boards than individual papers.

Weight: and **Cost:** in the **Adhesive** group should be set for the complete board definition, not individual paper and flute definitions.

6. Leave the fields on the Papers tab blank, as they are not relevant.
7. On the Material Properties tab are fields to set the shininess, transparency, and inside and outside colors of the paper. These properties are only visible in the optional 3D module.

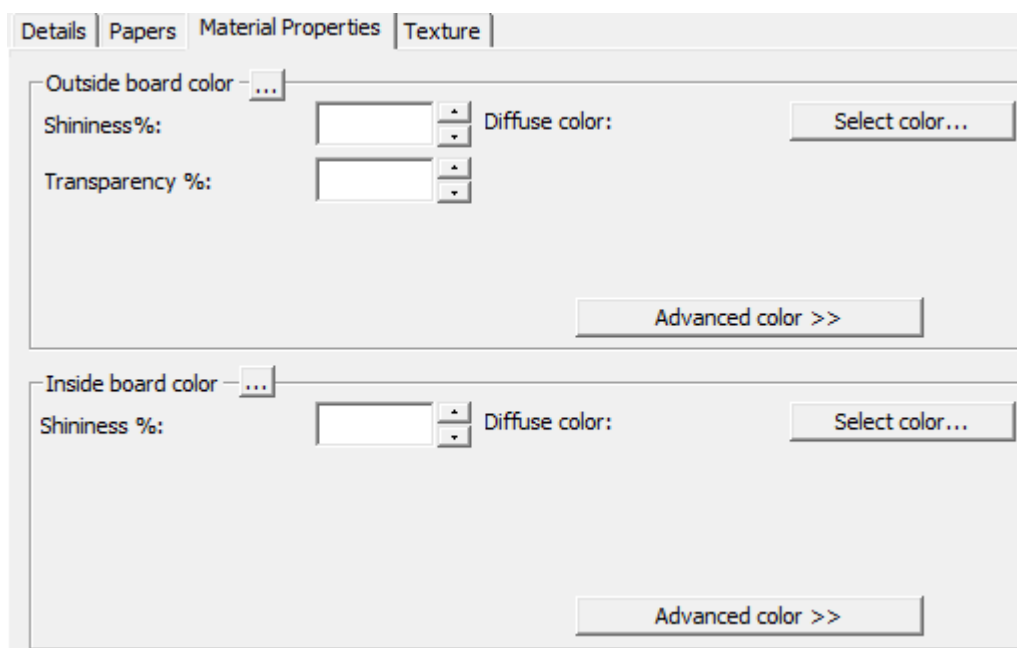

Set the **Shininess%** and **Transparency%** fields as desired. The **Transparency%** field is a separate setting from transparency mode in 3D and is not affected by that setting.

Surface colors for papers are split into three components: **ambient** color, which reflects the ambient light; **diffuse** color, which reflects the movable lights in an airy, non-shiny way; and **specular** color, which reflects movable lights for a shiny surface, with a shiny surface having a white specular color and a dull surface a black specular color.

By default, the Material Properties tab only displays Diffuse color in Simple color mode. In Simple color mode, choose a color by clicking **Select color**. To set the other two colors, click **Advanced color**, and then click **Select color** as desired.

Note: DataCenter Admin only uses color palettes from Shared Defaults. It does not use any color palettes from User Defaults.

The outermost Outside paper color is used to set the Outside board color if no other color has been manually chosen for the outside of the board. Likewise, the innermost Inside paper color is used to set the Inside board color if no other color has been manually chosen for the inside of the board.

The ... button (Browse) is used in board definitions to calculate the color based on the materials comprising the board. It is not relevant for papers.

8. On the Texture tab are fields to specify the graphics that may be used to represent the inside, outside, and edge textures of the paper. These properties are only visible in the optional 3D module. Outside and inside textures are more relevant for boards, but may also be defined for papers, while board edge textures do not apply to papers.

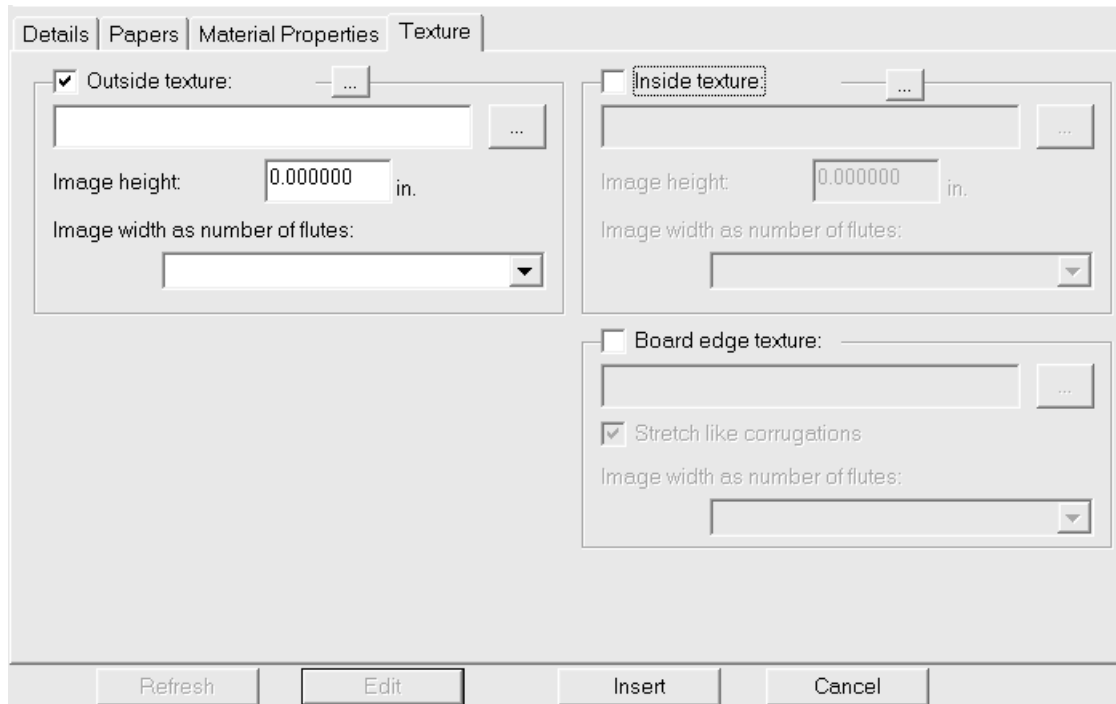

To add an inside or outside texture to the paper, click the checkbox for it, and then specify the filename of the graphic file for the texture, or click ... (Browse) to the right of the filename field and select it. Some common textures are stored in **\\Esko\Artios\Common**. The image should be of the board surface with vertical grain or corrugation direction. If you use a custom image, measure the sample when you take its picture so that you know its size; you may need to touch up the image in a graphic editing program so that the edges blend together when the image is tiled.

In the **Image height**: field, enter the height of the image. The size needs to be set in order for ArtiosCAD to scale the picture appropriately. If the height is set to 0, the image will be scaled proportional to the width.

Set the value in the **Image width as number of flutes:** drop-down list box to the number of flutes the image represents. The image should be of a whole number of flutes. It may also be set to **Proportional to height**, in which case the height cannot be set to 0.

Shown below is `\Esko\Artios\Common\boardbrown.jpg`, an example board texture three flutes wide:



9. When you have finished defining the paper, click **Insert** to add the new paper definition to the database.

Note: Foams are defined in the same way as papers, just with larger dimensions.

Creating a flute

A *flute* is the wavy paper that provides strength to corrugated board. A flute is defined by four pieces of information:

- A unique code to identify the flute. This code must be less than four characters long.
- The flute pitch, which is the distance between the lowest parts of the wave. The pitch must be greater than 0.
- The flute height. The height must be greater than 0.
- The take-up factor, which is the ratio between the length of the fluted paper and the length of the board. If the flute were stretched out, it would always be longer than the paper encasing it. The take-up factor must be greater than 1.

To create a new flute, do the following:

1. Start DataCenter Admin.
2. Open the **Flute** browser by double-clicking it.
3.  Click **Insert New Record**. The Details pane will automatically appear with the fields enabled for editing.
4. Enter the new flute's code, height, pitch, and take-up factor in the appropriate fields as shown below.

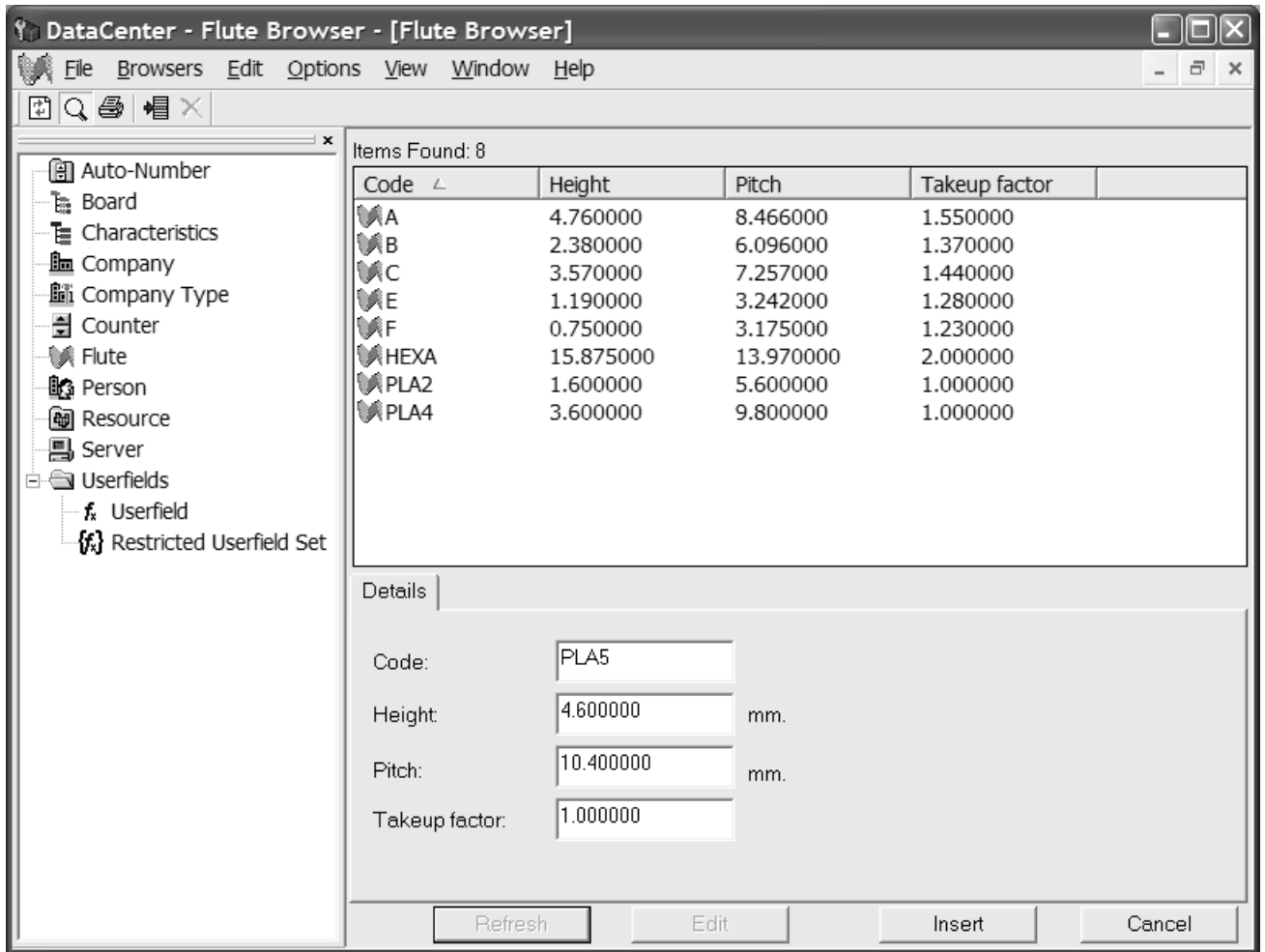

5. Click **Insert** to add the new flute definition to the database.

Creating a board

To create a board, do the following:

1. Start DataCenter Admin.
2. Open the **Board** browser by double-clicking it.
3. Boards are hierarchical. Right-click an item a level above the desired level for the new board (such as **Boards** to add the new board at the top level or **Artios > Corrugated > C** to add a new C flute board) and click **New > Board**. (You may also create a new folder in this manner.)

 You may also select the parent item and then click **Insert New Record** to create a new board. To create a new folder, you must use the right-click method described above.

The Details pane will automatically appear with the fields enabled for editing.

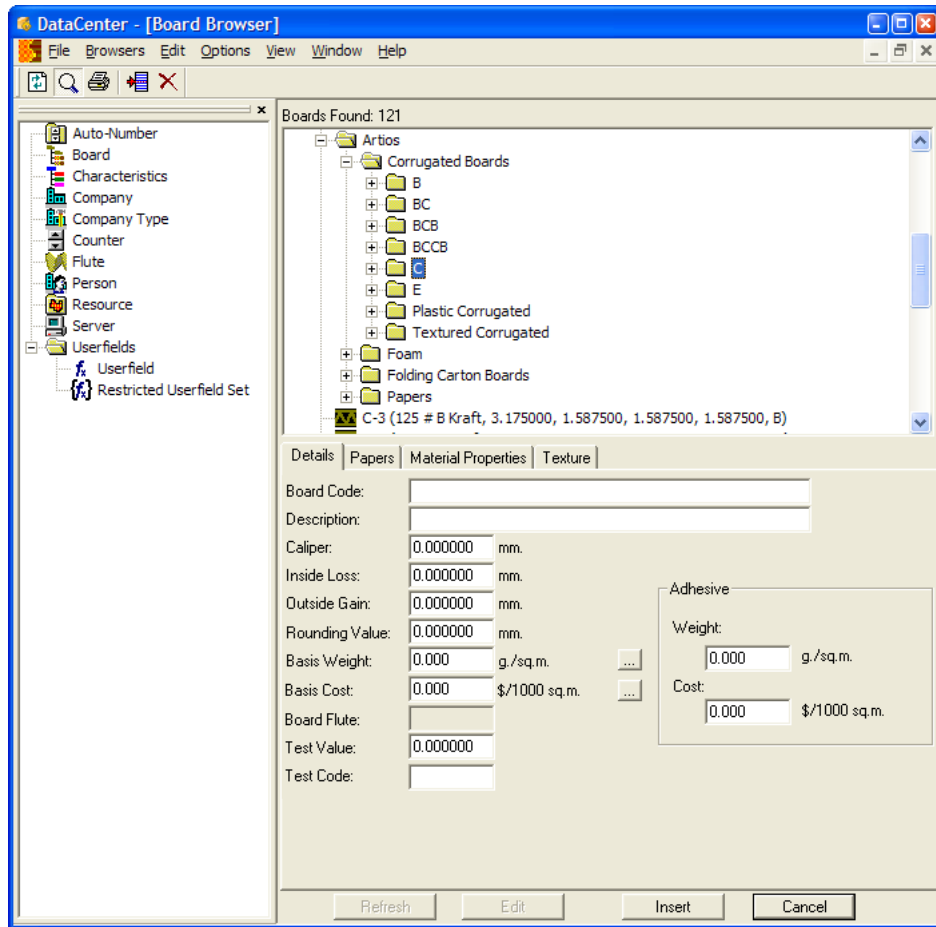

4. Enter values in the fields on the Details tab as appropriate.

Board Code: is the identifier used by the database to identify this new board; each board must have a unique code.

Description: is the description of the board.

Caliper: is the thickness of the board.

Inside Loss: and **Outside Gain:** are the allowances used when folding the board or when gluing it together (such as in a glue flap). They are generally half the caliper.

Rounding Value: sets a value to which dimensions may be defined to round to when constructing a corrugated design, such as the nearest 1/64" (0.015625). This is variable CRRV in Advanced StyleMaker and can be used in the **Round to:** field when defining a new variable.

Basis Weight: is the weight of the board in the selected system of units of measurement. Clicking the ... (Browse) button at the end of the field displays the Calculated Basis Weight dialog box. In this dialog box is an analysis of the calculated weight of the board based on the papers used to make it. To replace a manually-entered weight with the calculated weight, click **Accept**.

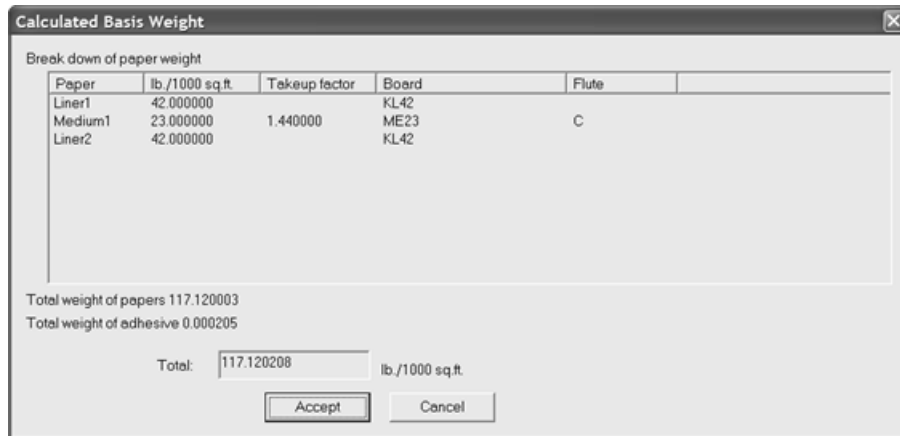

Basis Cost: is the cost of the board in local currency and units of measurement. As with the **Basis Weight:** field, the ... (Browse) button at the end of the field displays an analysis of the calculated cost of the board based on the papers used to make it. To replace a manually-entered cost with the calculated cost, click **Accept**.

Test Value: is the amount of weight needed to break the material when performing very specific standardized tests.

Test Code: is the identifier used in correlation with the Test Value to show the strength of the paper.

The **Weight:** and **Cost:** fields in the **Adhesive** group are the respective weight and cost of the adhesive for the board as a whole.

5. The Papers tab contains drop-down list boxes to select the liners and mediums that comprise the board.

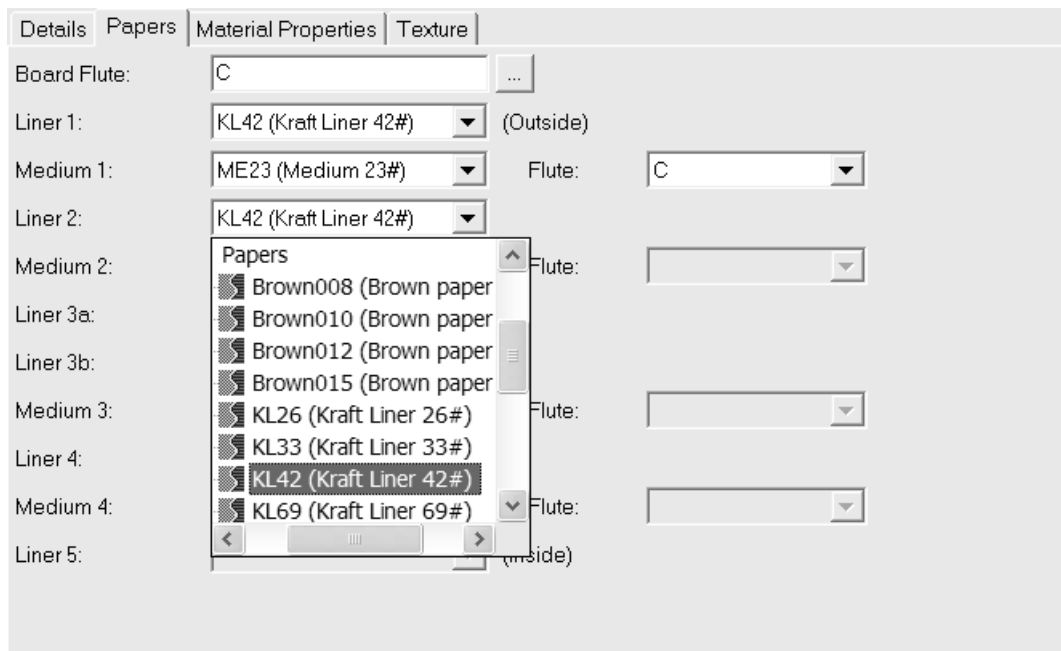

If you know it already, type the flute code of the new board in the **Board Flute:** field. At the end of the field is a ... (Browse) button that opens the Calculated Flute dialog box. Use this to calculate the flute code after defining the liners and mediums for the board.

If it is a single board, expect a flute code like C. Double wall could be BC, while triple- and quadruple-wall would comprise four letters.

Boards are defined sequentially from the outside inward. For example, you must select Liner 2 before you may select Medium 2. You may not select Liner 2 and then jump directly to selecting Liner 4.

Select liners and mediums in their respective drop-down list boxes. As you select a liner and then a flute, the **Flute** drop-down list box for that pair becomes available. You must select a flute before the next liner becomes available for selection.

Complete the paper selection process with a liner.

6. On the Material Properties tab are fields to set the shininess, transparency, and inside and outside colors of the board. These properties are only visible in the optional 3D module.

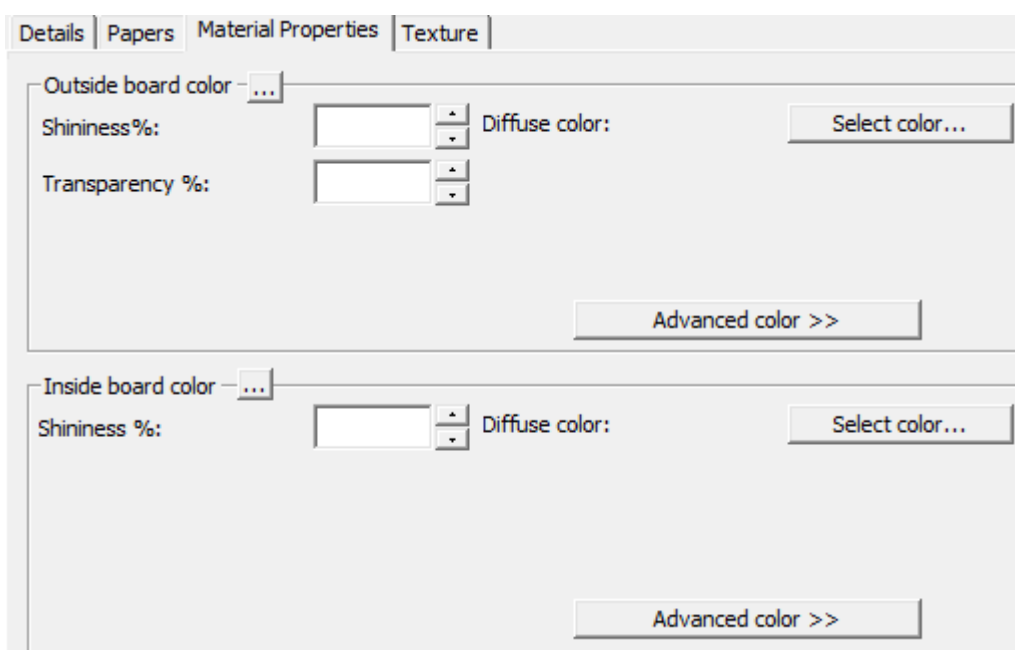

Set the **Shininess%** and **Transparency%** fields as desired. The **Transparency%** field is a separate setting from transparency mode in 3D and is not affected by that setting.

Surface colors for boards are split into three components: **ambient** color, which reflects the ambient light; **diffuse** color, which reflects the movable lights in an airy, non-shiny way; and **specular** color, which reflects movable lights for a shiny surface, with a shiny surface having a white specular color and a dull surface a black specular color.

By default, the Material Properties tab only displays Diffuse color in Simple color mode. In Simple color mode, choose a color by clicking **Select color**. To set the other two colors, click **Advanced color**, and then click **Select color** as desired.

Note: DataCenter Admin only uses color palettes from Shared Defaults. It does not use any color palettes from User Defaults.

The outermost Outside paper color is used to set the Outside board color if no other color has been manually chosen for the outside of the board. Likewise, the innermost Inside

paper color is used to set the Inside board color if no other color has been manually chosen for the inside of the board.

The ... button (Browse) calculates the color based on the materials comprising the board. Click **Yes** to use the color of the paper; click **No** to use the color of the current board definition.

7. On the Texture tab are fields to specify the graphics that may be used to represent the inside, outside, and edge textures of the board. These properties are visible only in the optional 3D module.

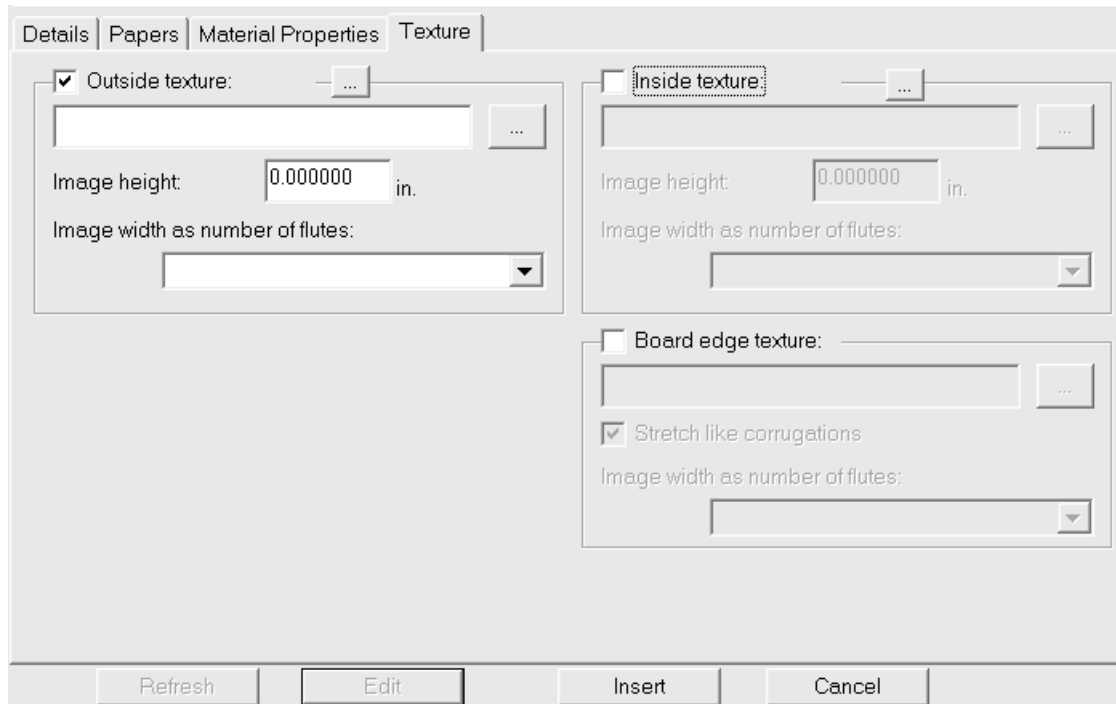

To add an inside or outside texture to the board, click the checkbox for it, and then specify the filename of the graphic file for the texture, or click ... (Browse) to the right of the filename field and select it. Some common textures are stored in **\\Esko\Artios\Common**. The image should be of the board surface with vertical grain or corrugation direction.

In the **Image height**: field, enter the height of the image. You may have to use a separate graphic editing program to determine the size of the picture. The size needs to be set in order for ArtiosCAD to scale the picture appropriately. If the height is set to 0, the image will be scaled proportional to the width.

Set the value in the **Image width as number of flutes**: drop-down list box to the number of flutes the image represents. The image should be of a whole number of flutes. It may also be set to **Proportional to height**, in which case the height cannot be set to 0.

If using a custom board edge texture on a double, triple, or quadruple wall board, the board edge texture has to be a whole number of all the flutes. The largest flute is used initially, then the smaller flutes are adjusted by a few percent to align a whole number of the smallest flutes with a whole number of the largest flute. Knowing how many flutes the image represents is critical. To determine this, start with the board defined but with no custom edge texture. Export the 3D workspace to VRML and then view the associated PNG

files created. One of those will be of the board edge texture. Count the number of flutes for the largest board and set the **Image width as number of flutes:** field to the same number.

Shown below is `\Esko\Artios\Common\boardbrown.jpg`, an example board texture three flutes wide:



To specify a graphic for the board edge texture, check the **Board edge texture** checkbox, then specify the filename of the graphic file for the texture, or click ... (Browse) to the right of the filename field and select it. Some common textures, for example paper corrugated edges, plastic corrugated edges, and paper hexacomb flutes, are stored in `\Esko\Artios\Common`. The height of the image for a corrugated board should be the board caliper, and the width should be a whole number of flute pitches. Folding carton boards use an image width proportional to the height.

If no texture is specified for a corrugated board edge, a default picture based on the height and pitch of the flutes is used.

Stretch like corrugations stretches the picture of the board edge texture depending on its angle to the grain/corrugation direction. If this option is not selected, the board edge texture is repeated evenly.

Shown below is a picture of the default board edge texture with **Stretch Like Corrugations** turned on in a design in 3D:

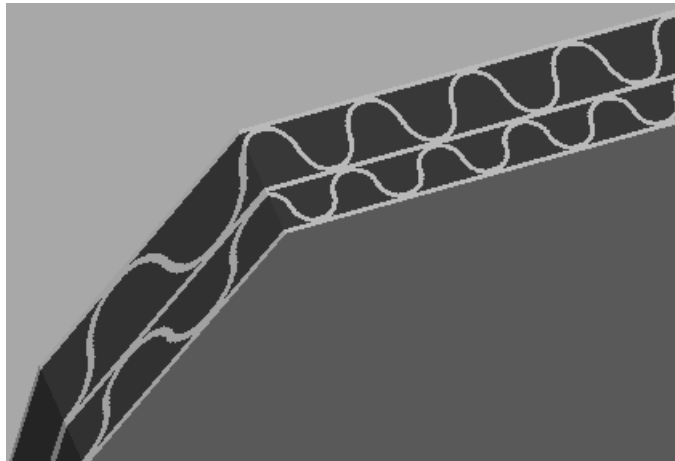

Shown below is a picture of the BrownB board in the Textured Corrugated folder with **Stretch Like Corrugations** turned off in a design in 3D:

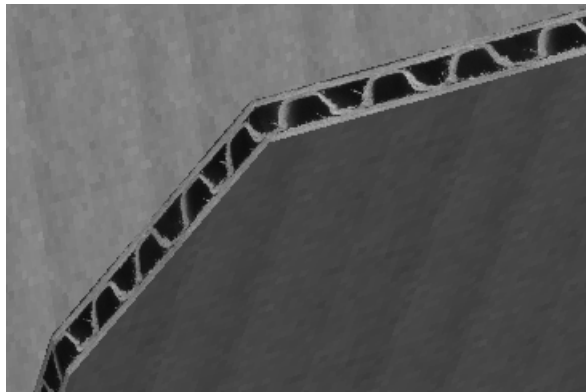

8. When you have finished defining the board, click **Insert** to add the new board definition to the database.

Renaming, deleting, moving, and copying board entries

In addition to the standard ways of manipulating entries in DataCenter Admin, the Board browser supports multiple item selection, dragging and dropping of entries, cutting and pasting of entries, and right-clicking entries to perform functions on the context menu.

To create a folder, select its parent item (the one a level above its desired position), right-click it, and click **New > Folder** on the context menu. The folder name must be unique among same-level folders in the same parent folder.

To rename a folder, select it, right-click it, click **Rename** on the context menu, enter the new name, and press enter.

To delete a folder, first make sure it is empty, and then select it, right-click it, and click **Delete** on the context menu. You may not delete a non-empty folder.

To rename a board, edit it and change its description. This change will not be communicated back into workspaces using this board.

Boards may not be deleted if they are in use. You may replace the board definition in affected designs with another, clear the board information in those designs, or cancel the deletion.

To move a folder or a board, drag it from one location to another.

To copy a board definition, select it, right-click it, and click **Copy** on the context menu. Right-click the folder into which it will be pasted and click **Paste** on the context menu. When the board is pasted into the new folder, the current system time will be appended to the board code to maintain board code uniqueness.

Configuring characteristics

Characteristics provide a way to describe the type of box referenced by an entry in the Design browser. Designs can have more than one characteristic, such as Autobotom and Tuck top. Characteristics are comprised of a **code**, which is the internal name of the characteristic, and a **description**, which is what is shown.

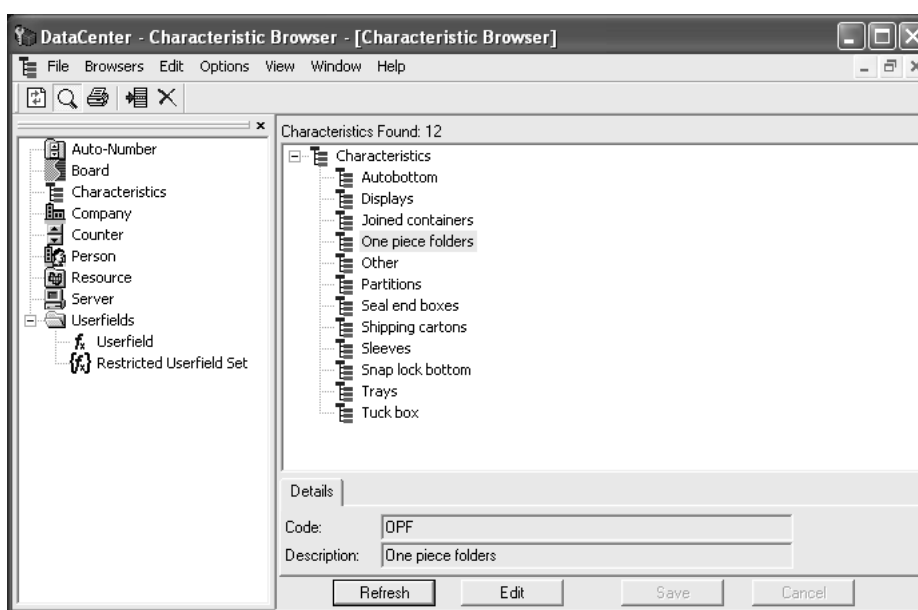

Adding a characteristic

To add a characteristic, do the following:

1. Start DataCenter Admin.
2. Double-click the **Characteristics** browser to open it.
3.  Select the characteristic to add the new characteristic under and click **Insert New Record**.
4. Enter the code for the new characteristic in the **Code:** field.
5. Enter a description of the new characteristic in the **Description:** field.
6. Click **Insert**.

There are additional characteristics available beyond those shipped by default. See *Installing additional characteristics* later in this section.

Deleting a characteristic

To delete a characteristic, do the following:

1. Start DataCenter Admin.
2. Double-click the **Characteristics** browser to open it.
3.  Click **Delete**.
4. Click **OK** when asked to confirm the deletion. Deleting the characteristic from the database will also delete it from all files containing it.

Assigning characteristics is described in the *Using DataCenter* section.

Configuring Design Auto Numbering

You can configure ArtiosCAD and DataCenter to use an automatic file numbering scheme for designs and manufacturing files. First you create a filename counter that will increment by one, and then you link that counter to a resource. Once that information is saved in DataCenter, when you use that resource in ArtiosCAD, you can use the **Save Next Name** button to automatically save the file with the next available number.

Each resource can have one counter for designs and one counter for manufacturing files. However, each counter can be used in more than one resource. The counter will span resources. For example, if two resources, **MBC Plant 1** and **MBC Plant 2**, use the same counter, auto-saving a file in **MBC Plant 1** will cause the next file auto-saved in **MBC Plant 2** to increment up a number from the name used in **MBC Plant 1**.

Configuring a filename counter

To set up a filename counter, do the following.

1. Start DataCenter Admin.
2. Double-click the **Counter browser** to open it.
3.  Click **Insert New Record**.
4. Enter the name of the filename counter in the **Name:** field, and enter the starting value for the filename counter in the **Value:** field. The name should indicate the purpose of the counter.
5. Repeat steps 3 and 4 as desired.
6. Click **Insert**. When done, the Counter browser should look like the following picture (substituting the data you entered):

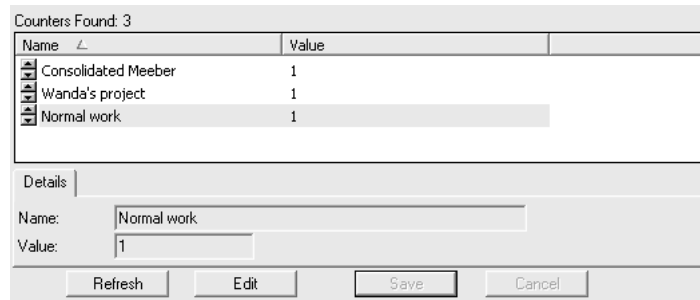

Configuring Auto Numbering

Once the filename counters have been added, do the following to set up automatic numbering:

1. Start DataCenter Admin if it is not already open.
2. Double-click the **Auto-Number** browser to open it.
3.  Click **Insert New Record**.
4. Click in the **Resource** field and choose the desired resource from the drop-down list box.

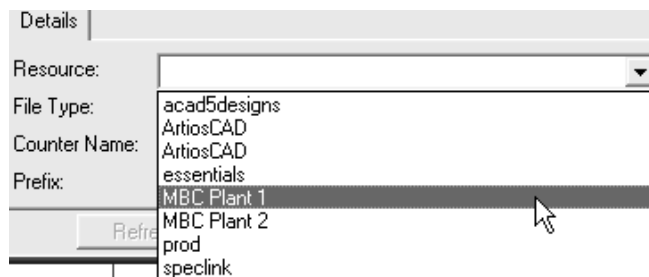

5. In the **File Type:** field, choose either the **Design** or **Manufacturing** option button according to the kind of file to use this auto-numbering.
6. Click in the **Counter Name** field and choose the desired counter from the drop-down list box.

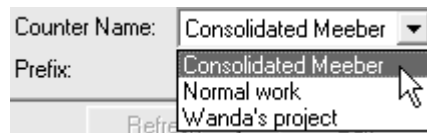

7. Enter the number of digits of the counter in the **Length** field. Extra zeroes will be added to the counter when a file is saved if the number of digits is smaller than specified here. If the counter is set to start at 1, and the Counter Length is set to 4, the counter will start at 0001, go up to 0002, 0003, and so forth.
8. In the **Prefix** field, enter non-changing text to come before the auto-incrementing number. You can leave this field empty if desired.
9. In the **Suffix** field, enter non-changing text to follow the counter. You can leave this field empty as desired.
10. Click **Insert**.
11. Repeat steps 3 through 10 as desired.
12. The Auto Numbering browser should look similar to the following picture (except that it will have the data you entered in it). Both resources share the same counter.

Autonumber Sets Found: 2					
Resource	File Type	Counter Name	Prefix	Su...	Counter Length
MBC Plant 1	Design	Consolidated Meeber	MBC1-		10000
MBC Plant 2	Design	Consolidated Meeber	MBC2-		10000

Automatic design numbering is now fully configured and ready for use by clicking **Save Next Name** in ArtiosCAD.

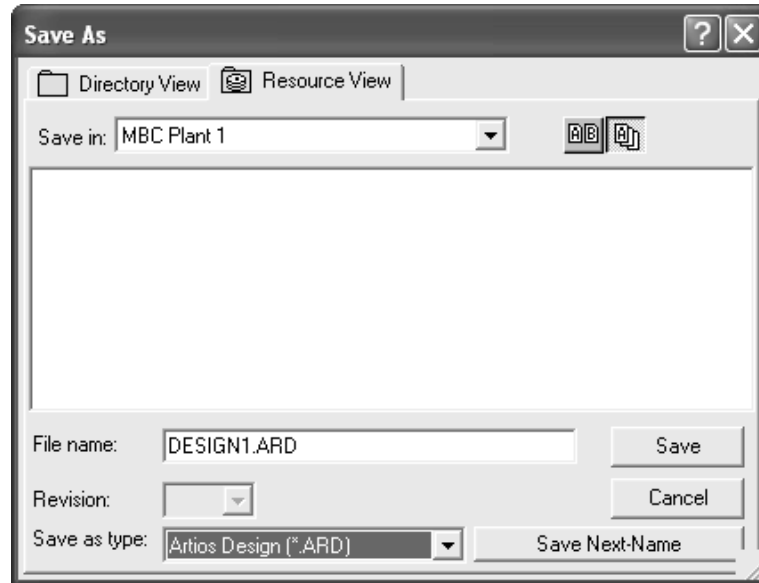





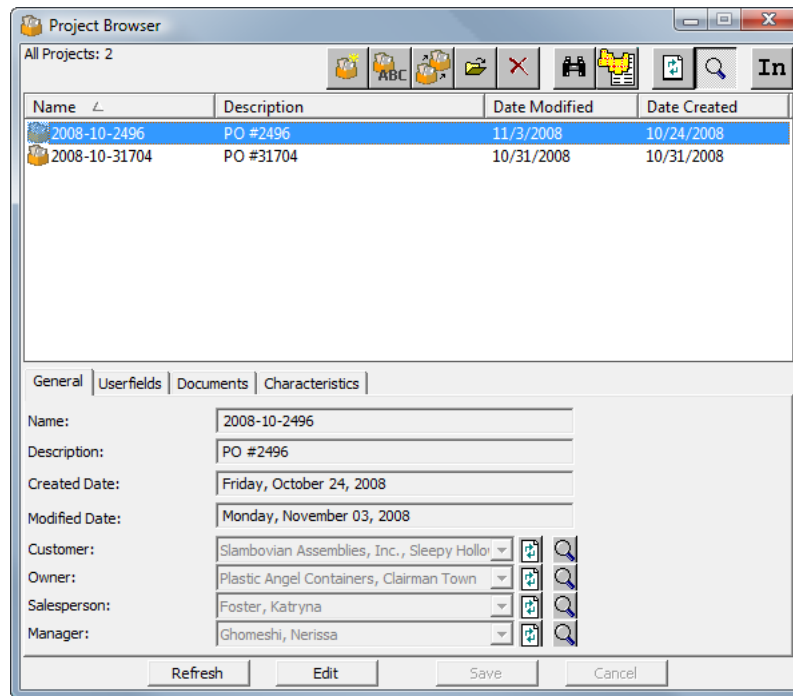



Using the Project browser

Along with single designs, manufacturing files, and single designs embedded in manufacturing files, there is a Project browser within ArtiosCAD that enables you to manage Projects separately from the other commands on the **Projects** menu. To open the Project browser, click **Projects > Project Browser**. Shown below is the Project browser with the **Show Details** toggle turned on and a Project selected.



Like the other database browsers, the first group of buttons along the top of the browser perform actions on the currently-selected Project, while the panes along the bottom of the browser show information specific to that Project. The panes are only shown when **Show Details** mode is turned on by clicking the magnifying glass icon on the toolbar.



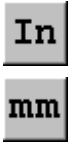





Button	Name	Function
	New Project	Creates a new Project just as if you clicked the menu command.
	Rename Project	Renames the currently-selected Project as long as it is not open in ArtiosCAD.
	Copy Project	Copies the currently-selected Project to a new Project using a dialog box similar to the Create New Project dialog box. The Reset Project document counter checkbox determines if the counter (for auto-numbering purposes) is reset or not. ArtiosCAD copies Project information, characteristics, userfields, and Project documents to the new Project.
	Open Project	Opens the currently-selected Project in ArtiosCAD and makes the ArtiosCAD window active.
	Delete Selected Item(s)	Deletes the currently-selected item(s).
	Edit Search Criteria	Searches all Projects with criteria you specify. See the section on searching below.

Button	Name	Function
	Show Project Documents	Lists all documents in this Project in the Design Browser.
	Refresh Browser	Re-queries the database and updates the list of Projects.
	Toggle - Show Details	Turns the information panes at the bottom of the browser on and off.
	Units	Changes the units of measurement between Imperial and metric.

To change information shown in one of the panes, as in the other database browsers, click **Edit**, make the desired changes, and then click **Save**. You may need to click **Refresh** to see the updated information.

Project browser - General pane

The **General** pane of the Project browser shows basic information about the Project as shown below. All of the fields are in read-only mode; to change them, click **Edit** beneath the pane.

General	Userfields	Documents	Characteristics
Name:	2008-10-2496		
Description:	PO #2496		
Created Date:	Friday, October 24, 2008		
Modified Date:	Monday, November 03, 2008		
Customer:	Slambovian Assemblies, Inc., Sleepy Hollow		 
Owner:	Plastic Angel Containers, Clairman Town		 
Salesperson:	Foster, Katryna		 
Manager:	Ghomeshi, Nerissa		 

 **Refresh** requeries the database for the information in that field in case someone else changed it while you were looking at it.

 **Show Item Details** opens a dialog box which displays more information related to the associated field. Click **Cancel** to return to the Project browser.

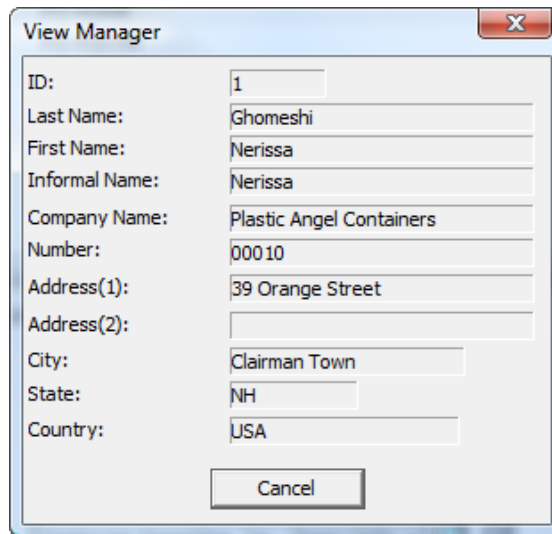

Project browser - Userfields pane

The userfields assigned to a Project are shown in the **Userfields** pane of the Project browser. You may also add and remove userfields by using this pane as opposed to using the **Project Information** dialog box. Shown below is an example Userfields pane.

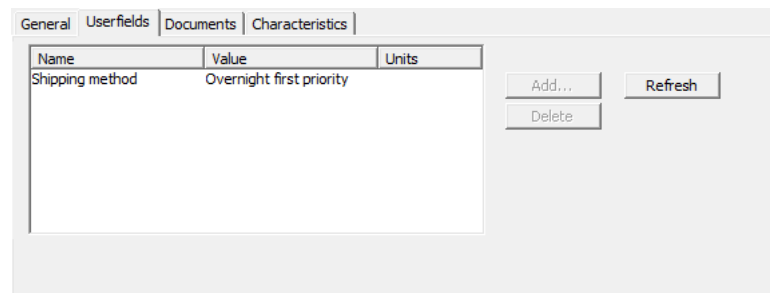

To add or remove userfields, click **Edit** beneath the pane, and then click **Add** or **Delete** (having first selected a userfield in the list shown) as desired. When you are done making changes to the userfields, click **Save** beneath the pane.

Refresh requeries the database and updates the list of userfields if anyone else has made changes to them since you opened this pane.

Project browser - Documents pane

The **Documents** pane of the Project browser shows the documents included in the Project and lets you organize how they appear on Bill of Materials Reports (BOM Reports).

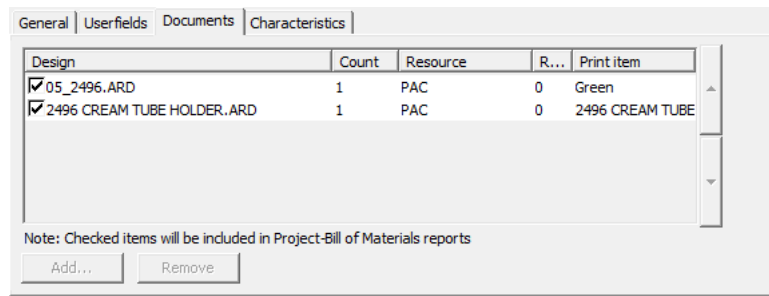

To add or remove documents from the Project, click **Edit** beneath the pane, and then click **Add** or **Remove** (having clicked to select at least one document beforehand) as desired. To include or exclude documents on BOM Reports, check or clear their checkboxes before their names in the list. To change the order in which documents appear on BOM Reports, select a document by clicking it and then click the up or down arrow at the right edge of the dialog box as appropriate. You may also change the Count as desired by clicking the up and down arrows next to the numeral in that field for a particular document.

For more information about BOM Reports, see the *Outputs* chapter.

When you are done making changes to the documents, click **Save** beneath the pane to return to the Project browser.

Project browser - Characteristics pane

In the **Characteristics** pane of the Project browser, ArtiosCAD shows the characteristics currently assigned to the selected Project in the left side of the pane. You can also add and remove characteristics to and from the Project.

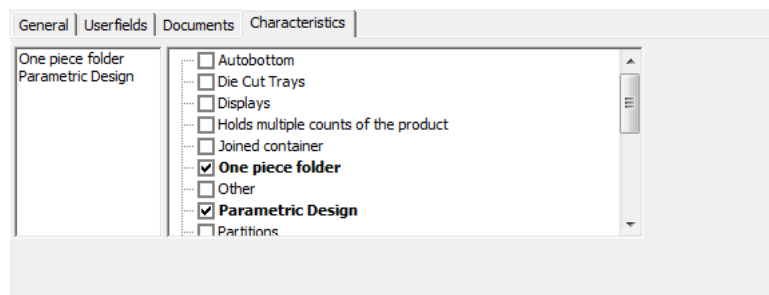

To add or remove characteristics, click **Edit** beneath the pane, and then select or deselect the desired characteristics. When you have finished modifying the characteristics for the selected Project, click **Save** beneath the pane to return to the Project browser.

Searching for Projects



When you click **Edit Search Criteria**, the **Search Projects** dialog box appears as shown below (with sample data; initially it is empty).

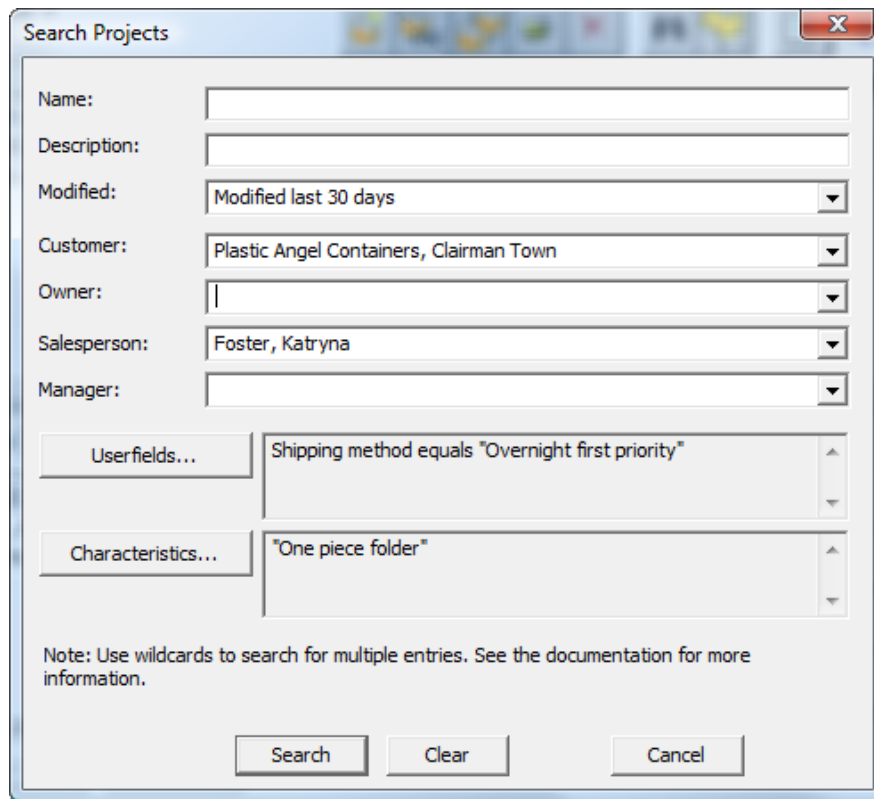

You can enter text to search on in each text field, but the **Modified**:, **Customer**:, **Owner**:, **Salesperson**:, and **Manager**: fields all have drop-down list boxes containing cached entries from the database. All text that you enter must use wildcards as explained below:

- * and % mean match all characters.
- ? and _ mean match one character.
- To search on one of the wildcards, prefix it with a backslash (\), such as "100\% Pure".
- To search specifically on a backslash, enter "\\".

Examples of using wildcards are shown in the following table.

Search term	Search results
Project_1	All Projects starting with "Project" and then any single character between t and 1, such as ProjectX1, Project\$1, and so forth.
Project_1	Project_1.
Project_*	All Projects starting with Project_, such as Project_1, Project_X, and Project_5BD2.
Project\1	Project\1.

In any of the fields with a drop-down list box, if you enter text to search on using wildcards, ArtiosCAD will:

- search by customer name for both the **Customer**: and **Owner**: fields.

- search by last/first/greeting names for the **Salesperson:** and **Manager:** fields. However, make sure to use wildcards if you manually modify an entry in these fields, as ArtiosCAD will not analyze the string to extract the first and last names separately. For example, if you select "Smith, John" from one of the drop-down list boxes and then add an asterisk after John, forming "Smith, John*" as the search string, ArtiosCAD will probably not find the desired result as it will not separate the words in the search string since you manually changed it. However, were you to search on "Smith*" or "John*" you would probably achieve the desired results.

To search on a userfield, do the following:

1. Click **Userfields**.
2. In the **Project Userfields** dialog box, select the userfield to search against.
3. Select the method to use for the pattern match in the **How:** field. For text userfields, use wildcards. For numeric userfields, use =, <, and >. For restricted set userfields, only = is available, and then the set of values becomes available in the **Value:** field.
4. Repeat steps 1-4 as desired to add more userfields to the search. Each userfield search argument is connected with AND logic, so only Projects meeting all the Userfield conditions will be returned in the search results.
5. Click **OK** to return to the **Search Projects** dialog box.

To search on Characteristics, do the following:

1. Click **Characteristics**.
2. In the **Characteristics** dialog box, select the desired characteristics to search against.
3. To find characteristics, click **Find** and perform the usual search for characteristics using the Characteristics Finder. Once you have found and selected the desired characteristics, click **OK** to return to the **Set Characteristics** dialog box.
4. Once you have set the characteristics to search against, click **OK** to return to the **Search Projects** dialog box.

In the **Search Projects** dialog box, click **Search** to search against the criteria you have entered. ArtiosCAD displays the results in the Project Browser.

Clicking **Clear** in the **Search Projects** dialog box clears the fields in the dialog box but keeps any search results.

To clear the search results and show the list of Projects again, click  (**Edit Search Criteria**), click **Clear**, and click **Search**.

Modifying information in browsers

To change information in browsers, simply select the record to change, open the Details tab, and click **Edit**.

For example, if you wanted to change the price of 200# B-flute board in inches, you would open the Board browser, double-click the entry for **I-200B** in **Artios > Corrugated Boards > B**, click **Edit**, change the information shown, and click **Save**.

Refreshing fields in browsers

As you change information in the browsers, the information they have cached in memory may not be synchronized with the recent changes.

Click  **Refresh** to update the contents of the current field.

Customizing columns in DataCenter Admin

The **Customize** command on the Browsers menu in DataCenter Admin lets you choose the data shown in the browser windows and also output on Reports.

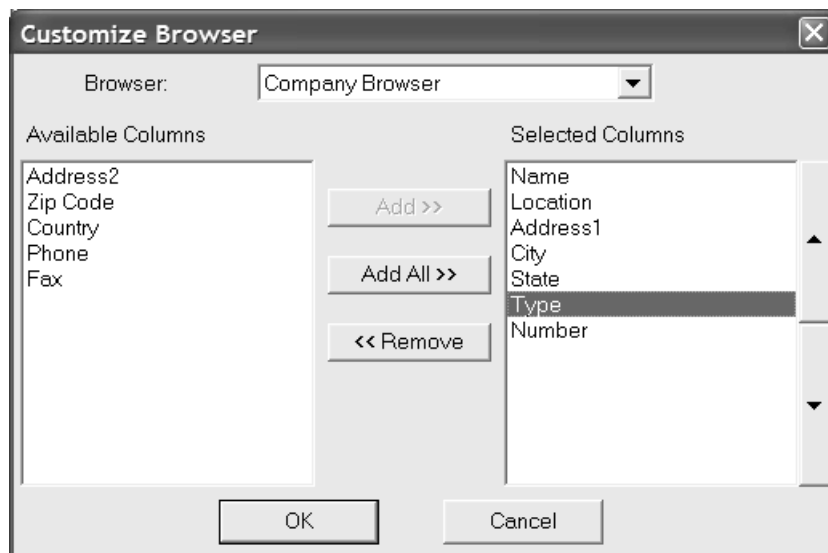

Choose the browser to modify from the **Browser:** drop-down list box.

Available columns which are not already shown in the browser are listed in the **Available Columns** list. The columns currently shown in the browser are list in the **Selected Columns** list. To move items between lists, select them and click either **Add**, **Add All**, or **Remove** as appropriate.

To change the order in which items are shown in the browser and on reports, select the item to move and then use the direction buttons. The top item is shown at the left of the browser and the bottom item is shown at the right of the browser.

Using DataCenter

Once DataCenter is configured to match your unique needs, it is easy to use. Two situations make up the majority of times you use DataCenter: when saving designs or manufacturing files, and using the browsers to view information.

Entering database information when saving in ArtiosCAD

When you save a design, ArtiosCAD automatically supplies DataCenter with some information about the design, but you must specify other information such as the customer name and the designer. Specify the customer, owner, salesperson, and designer for the design by clicking the arrow at the end of the field and choosing an entry. When you are done specifying information, click **OK** to save the database information and the design. Standard userfields are automatically saved with each design or manufacturing file.

Shown below is the process of assigning customer information to a design using the default database dialog box.

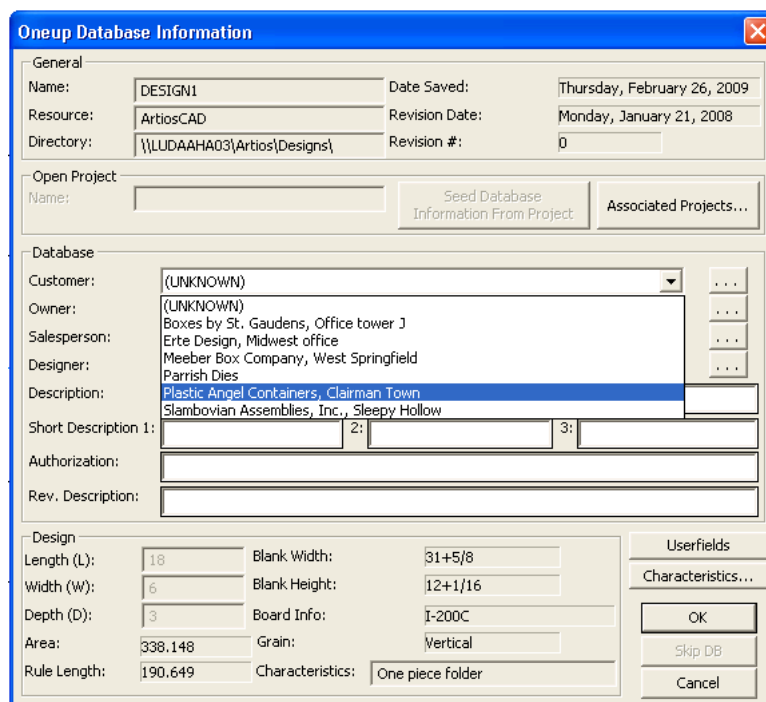

You can enter anything you want in the Description and Authorization fields. The **Description** is limited to 80 characters. **Short Description 1** is shown under the design preview when opening the design and is limited to 20 characters. To add a user field, click **User Fields**. (You must have purchased the Information Enhancement module to access user fields.)

Choose a **customer**, **owner**, **salesperson**, and **designer** by selecting the appropriate entry from the drop-down list box for each field. You can also search for specific information by clicking ... at the end of those fields. Your database administrator may have disabled the drop-

down list boxes, in which case using the ... button is the only way to enter information in those fields.

To skip adding this file to the database, click **Skip DB**. This button may be disabled in Defaults. Even when it is enabled, it is unavailable if a file with the same name already exists in the database to avoid having a conflict between the file data and the database data.

If the design is not rebuildable and does not already have these variables assigned, you can enter the length, width, and depth in the appropriate fields.

Your system administrator may have customized the database dialog box. For more information on customizing database dialog boxes, see the *Defaults* chapter.

Setting values for userfields in designs or manufacturing files

The easiest way to set values for userfields in ArtiosCAD is by clicking **User Fields** in the Database Information dialog box when saving a design or manufacturing file. You can also set them at any time in ArtiosCAD by clicking **Information** on the **Database** menu and then clicking **User Fields**. You will arrive at the same Set User Fields dialog box using either method.

To set a value for a userfield while in a design:

1. Use either of the methods described above to get to the Set User Fields dialog box.
2. Click **Add** to add a userfield and choose one from the list shown. Click **OK** after selecting the userfield to add.

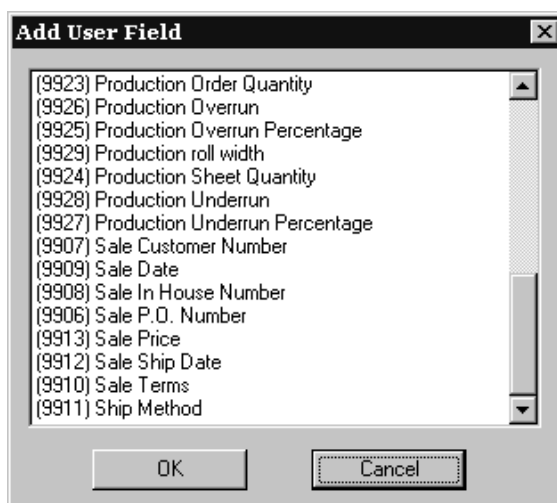

3. Enter the information you want the userfield to contain in the **Current Value:** field. In this example, the text **Send using priority overnight delivery!** will be in the Ship Method userfield. Click **OK** when you have entered the information.

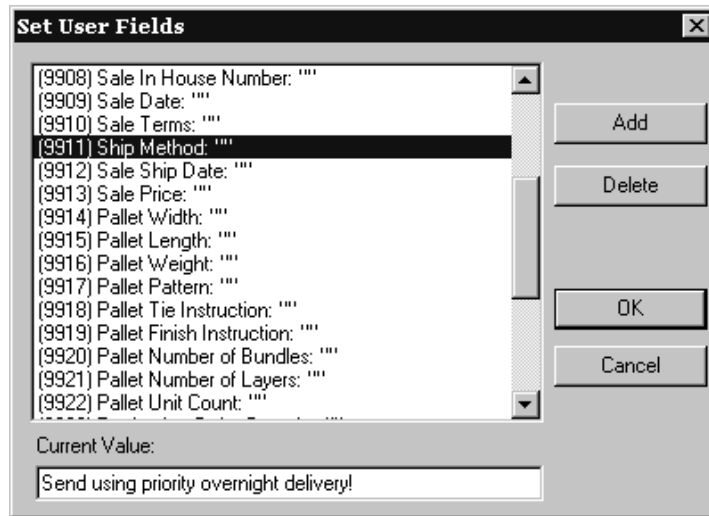

4. The userfield will be set to the value you specified.

Characteristics

The **Characteristics** button allows you to set the characteristics of the design.

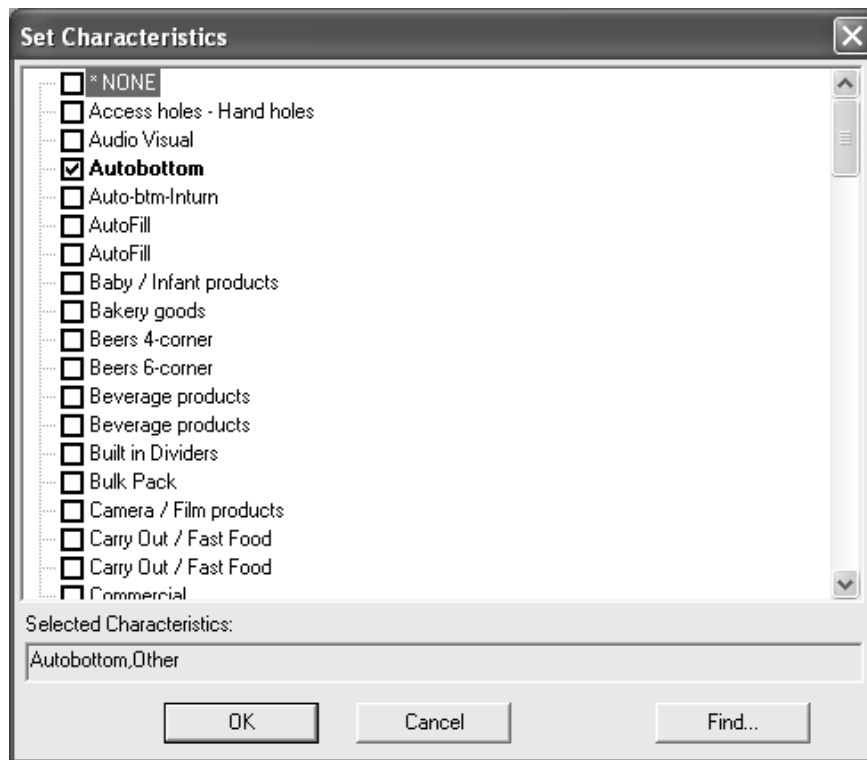

To set characteristics, check the checkboxes next to the desired entries and click **OK**.

To cancel assigning new characteristics, click **Cancel**. The dialog box closes without affecting previously-assigned characteristics.

Clicking **Find** opens the Characteristics Finder dialog box as shown below. Characteristics which were already set will appear in the new dialog box automatically.

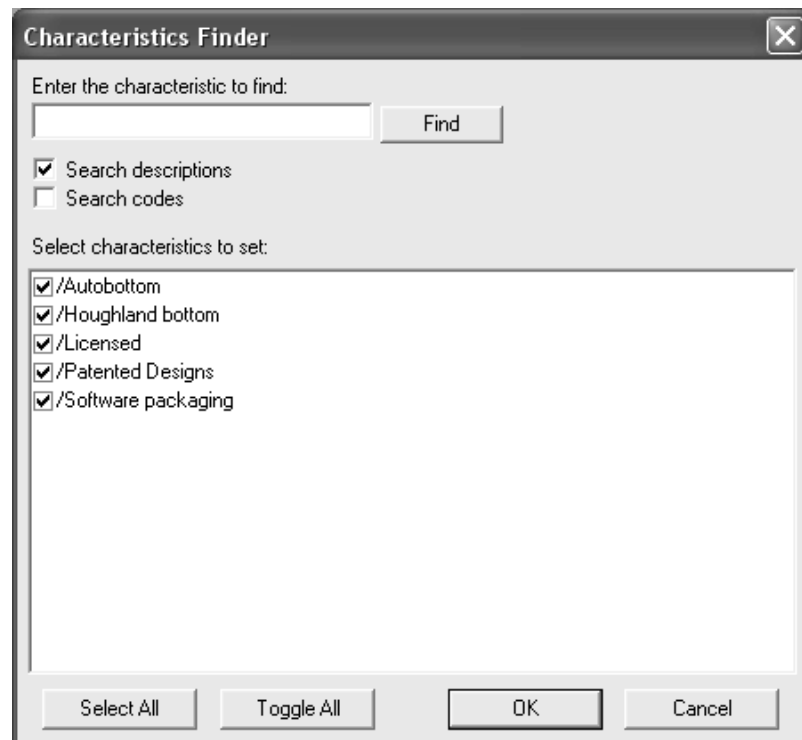

Enter the characteristic to find and click **Find**. **Search descriptions** searches the descriptions for matches, while **Search codes** searches only the codes for matches. At least one of these checkboxes must be checked.

Any matching characteristics will appear in the **Select characteristics to set** field, but they will not be selected.

Select All selects all the characteristics. **Toggle All** deselects those characteristics which were previously selected and selects those which were previously not selected.

Combine searches by entering more search terms and clicking **Find**. Any non-selected characteristics from the previous search will be removed from the results box. The results of the new search will be shown along with those results of the previous search that were selected.

Saving a manufacturing file is done the same way as saving a design file. Specify a customer, owner, salesperson, designer, description, and an authorization message. Click User Fields to assign userfields to the manufacturing file.

Note: The Characteristics Finder does not show hierarchical characteristics. All characteristics are displayed on the same logical level, so there may be apparent duplicate characteristics.

The following dialog box appears when saving a manufacturing file. It works the same way as saving a single design.

Manufacturing Database Information ✕

General

Name: <input type="text" value="05_2496"/>	Date Saved: <input type="text" value="Friday, December 09, 2005"/>
Resource: <input type="text" value="pac"/>	Revision Date: <input type="text" value="Friday, December 09, 2005"/>
Directory: <input type="text" value="C:\users\Prod\PAC\"/>	Revision #: <input type="text" value="0"/>

Database

Customer: <input type="text" value="Plastic Angel Containers, Clairman Town"/>	...
Owner: <input type="text" value="Plastic Angel Containers, Clairman Town"/>	...
Salesperson: <input type="text" value="Foster, Katryna"/>	...
Designer: <input type="text" value="Ghomeshi, Nerissa"/>	...
Description: <input type="text" value="For order 2496"/>	
Authorization: <input type="text" value="NG"/>	
Rev. Description: <input type="text"/>	

Manufacturing

Sheet Width: <input type="text" value="63"/>	Grain: <input type="text" value="Horizontal"/>	User Fields
Sheet Length: <input type="text" value="43+1/4"/>		OK
Diecutter: <input type="text" value="Example die press - Inch"/>		Skip DB
Printing Press: <input type="text" value="No Printing"/>		Cancel

Changing existing database information in DataCenter

You can change information about a design or manufacturing file by clicking **Edit** in a browser.

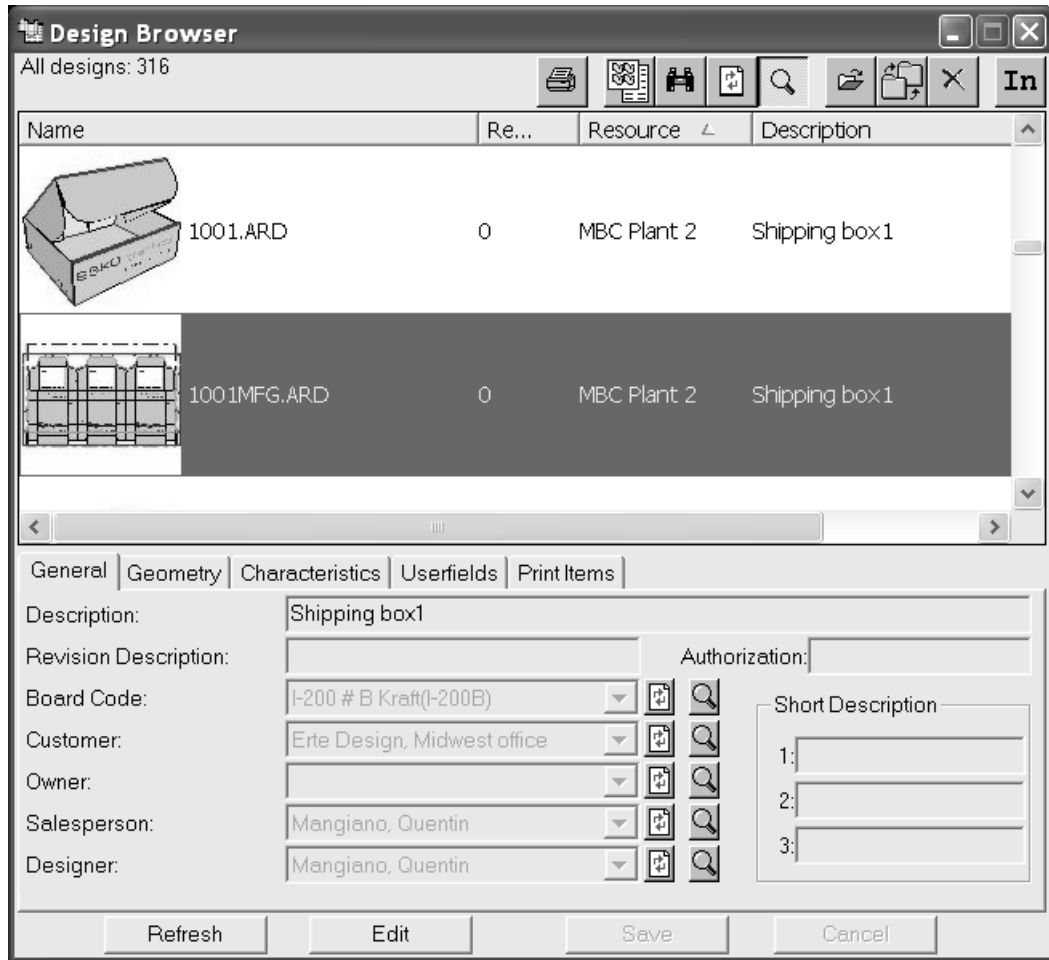

When **Edit** is clicked, the editable fields on the General, Characteristics, Userfields, and Print Items tabs turn white, and the **Save** and **Cancel** buttons become available as shown below. Make the desired changes and click **Save**.

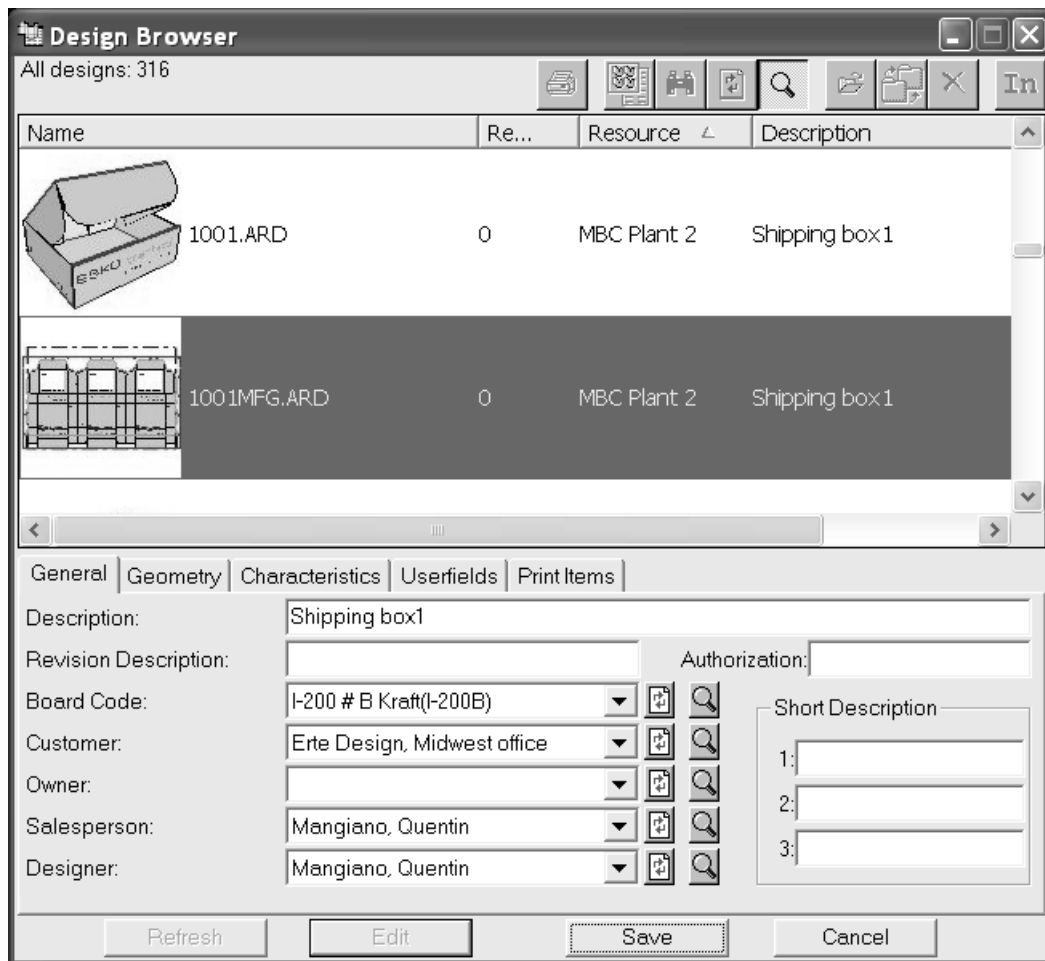

Synchronizing information in DataCenter

On rare occasions, the information in the database will not match the information in ArtiosCAD, and you are asked to choose which set of information is correct – the information saved in the file or the information from DataCenter.

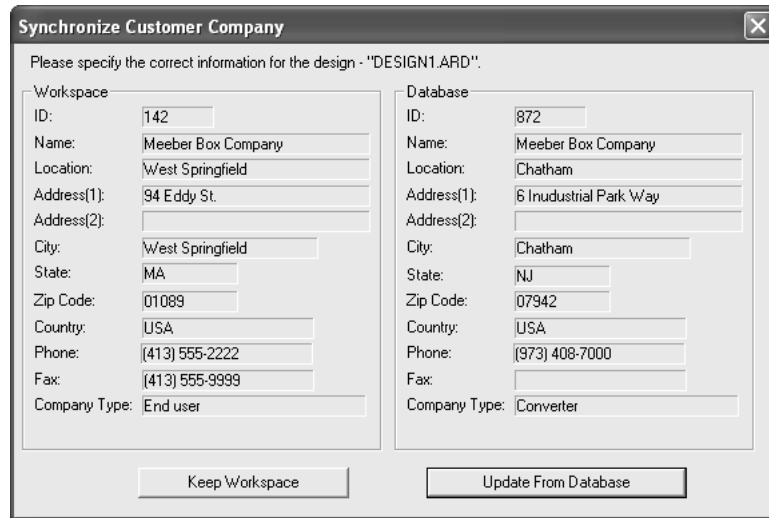

When a Synchronize dialog box appears, review the information shown in the **Workspace** group and **Database** group. Click **Keep Workspace** if the information in the Workspace group is correct. Click **Update From Database** if the database information is correct.

Exporting information from DataCenter



Click the **Generate Report** button on the toolbar to export information from DataCenter. You can either export detailed information about the current selection(s) by choosing **Use Selected Records**, or print a list of the objects in the browser by choosing **Use All Records**. If there are any Multiple Workspace Outputs defined in Defaults, you can also output the selected workspace(s) through them as well.

There are two reports for each browser. The **AutoCol Browser List format** automatically detects which columns of data are selected in Defaults and includes them on the report.

The **SimpleEmb Browser List format** presents just the information shown in the browsers.

The reports use three formats:

- CSV - produces a CSV (Comma Separated Values) file suitable for importing into a spreadsheet.
- HTML - makes an HTML (Hyper Text Markup Language) document which can be viewed in a Web browser.
- XML - makes an XML (eXtensible Markup Language) file suitable for delivering data to other applications in a rich, structured way.

All report types are created using XSLT transformations.

Customizing these reports involves changing the XML that is exported from ArtiosCAD and then modifying the XSLT transformation template to process the new XML information. Simple modifications, such as changing header columns can be performed by changing the Database Browser Reports entries in Defaults, but for more complex modifications, you should enlist the aid of the Esko Professional Services department or someone who has XML/XSLT editing experience.

Note: If Thumbnails are selected in the report Properties in Defaults, a JPG file for each thumbnail is stored in the same directory as the report output file. The thumbnails must be kept in the same directory as the report output file in order to appear in the report.

Other tasks

AutoLoad

AutoLoad is a utility which reads information about existing CAD designs and layouts and imports the data into the database. AutoLoad can read native ArtiosCAD (.ARD) workspaces, The Designer WorkBench (.DES) workspaces, and LASERPOINT IQ workspaces.

Use AutoLoad whenever you have multiple designs whose data you want to enter in the database without having to open each file and save it. Such a situation could be when you have loaded ArtiosCAD on a system which already contains ArtiosCAD, LASERPOINT IQ, or The Designer WorkBench designs. Another situation could be when you have copied many designs from another system onto your system.

AutoLoad can also convert batches of foreign file types (such as DXF or CF2) to ArtiosCAD workspaces. See the upcoming section *Recommended AutoLoad procedure for foreign file types* for more information.

Before using AutoLoad

Before using AutoLoad, you must have created servers and resources as described earlier in this chapter. AutoLoad can only act upon files in resources.

You also should determine the type of AutoLoad to perform, **Simple** or **Advanced**. Simple AutoLoad lets you choose a resource or resources to load into the database and automatically saves all designs with an ArtiosCAD filename extension appropriate to the type of file. Advanced AutoLoad lets you configure AutoLoad options and the default database behavior.

Simple AutoLoad

The procedure for using Simple AutoLoad is:

1. Make sure your database servers and resources are configured correctly.
2. Start ArtiosCAD.
3. Click **Database**, then **AutoLoad**.
4. In the **What am I doing?** group, choose **New AutoLoad** and click **OK**.

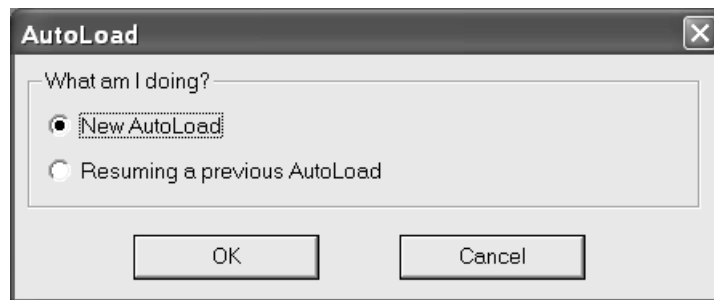

5. On the Input tab, check the checkboxes for the resource(s) you want to AutoLoad.

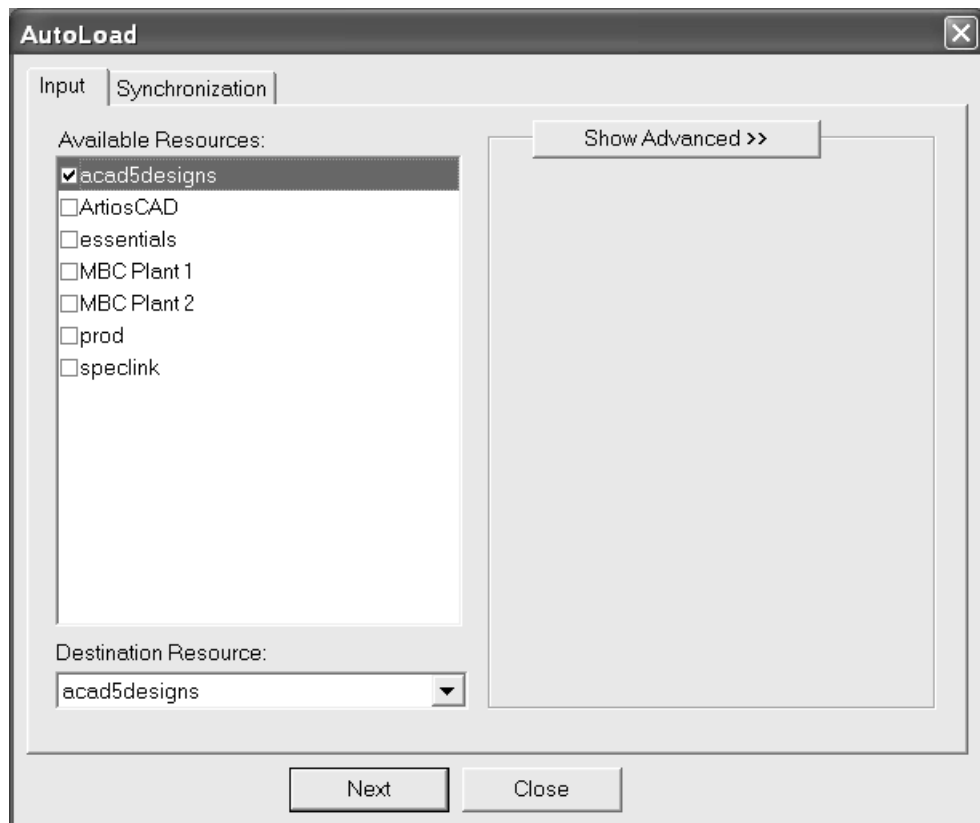

If you select only one resource, you can choose the resource into which the files are loaded by changing the entry in the **Destination Resource** list box. Selecting more than one resource to AutoLoad disables the Destination Resource list box.

- 6. Click the **Synchronization** tab.
- 7. Set the option in the **What am I doing?** group.

Use **Adding new files to the database** (the default) when adding completely new files to the database. These files have never been in a database in this ArtiosCAD installation before.

Use **Recovering database** when rebuilding a database, such as after a hard drive crash or accidental deletion. This reads the database information stored in the workspaces and rebuilds the database with it.

Use **Refreshing files after database changes** to update the workspaces after having made changes to their records in DataCenter Admin.

Click **AutoLoad** when you have chosen the option to use.

8. A progress indicator will appear.

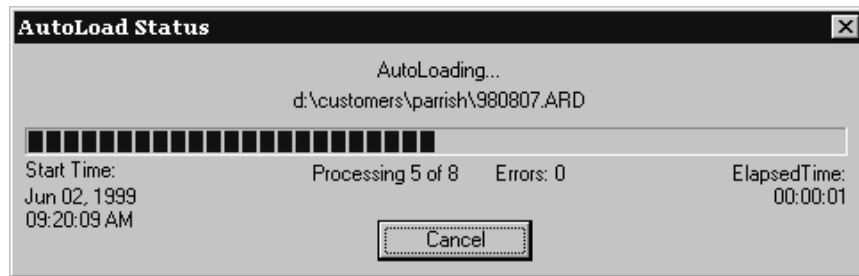

9. When AutoLoad completes, click **Close** to return to the AutoLoad dialog box, and then click **Close** to return to ArtiosCAD.

Advanced AutoLoad

Input tab Advanced pane

Clicking the **Show Advanced** unfold button on the Input tab of the AutoLoad dialog box shows more options than just the list of resources.

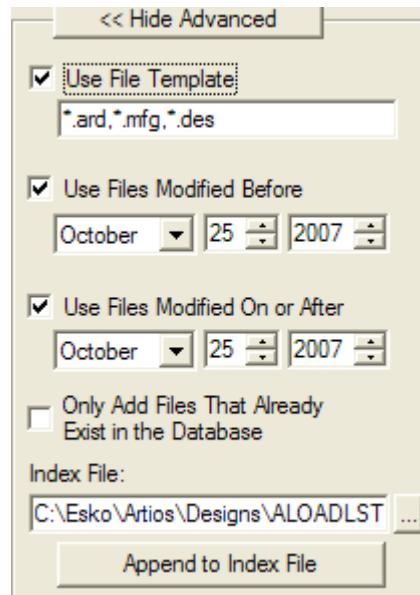

The **Use File Template** checkbox and field control which files are AutoLoaded. Any files matching the wildcards in the field are loaded. ArtiosCAD single designs, ArtiosCAD manufacturing files, and The Designer WorkBench workspaces have their wildcards set up by default. To AutoLoad all files in the selected resource(s), deselect the checkbox.

The **Use Files Modified Before** and **Use Files Modified On or After** checkboxes, when checked, let you specify the dates before, between, or after the dates you enter.

When checked, **Only Add Files That Already Exist in the Database** causes AutoLoad to skip those files whose records have been deleted from the database. This allows you to refresh the

database or designs with new information without including all the designs whose records you manually deleted from the database on purpose.

When AutoLoad runs, it generates a list of all the files it is to load and writes the list to the file shown in the **Index File** field. This is usually ALOADLST.TXT in the default design directory.

Append to Index File lets you link together multiple source and destination resources into one file and thus one AutoLoad.

Synchronization tab

The Synchronization tab is shown below.

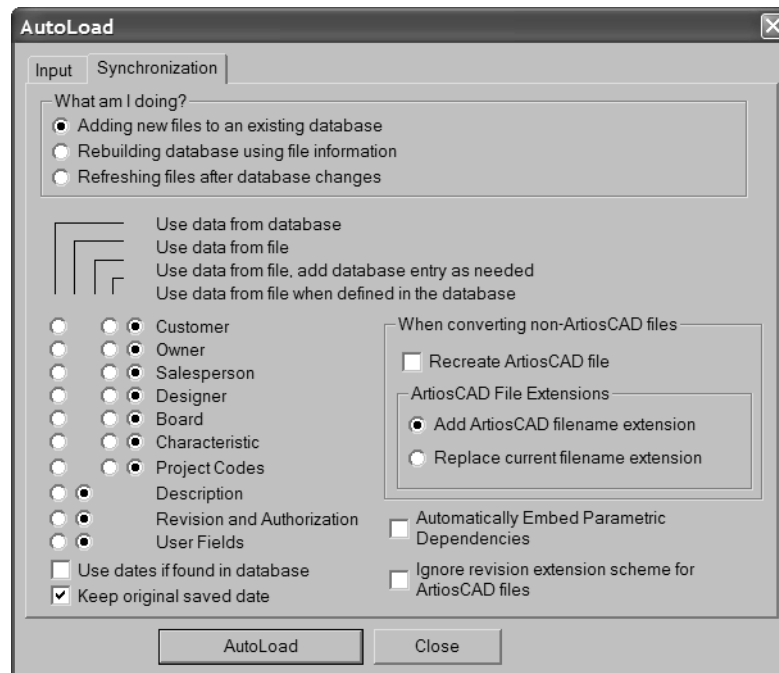

The options in the **What am I doing?** group determine the way in which AutoLoad treats any existing database information in the files. Use **Adding new files to an existing database** (the default) when adding completely new files to the database. These files have never been in a database in this ArtiosCAD installation before. Use **Rebuilding database using file information** when rebuilding a database, such as after a hard drive crash or accidental deletion. This reads the database information stored in the workspaces and rebuilds the database with it. Use **Refreshing files after database changes** to update the workspaces after having made changes to their records in DataCenter Admin.

The data synchronization options control which data is kept when AutoLoad encounters a file which has a corresponding record in the database. These options are set by the option selected in the **What Am I doing?** group. They can also be set manually. If you make any manual changes, the option buttons in the **What am I doing?** group are cleared.

Use data from database updates the file on disc with the information saved in the database. This option is available for all categories of information stored in the database.

Use data from file reads the disc file for information and uses the data it finds to overwrite whatever is stored in that category of the database record. This option is available only for that category of data which does not have its own browser in DataCenter Admin.

Use data from file, add database entry as needed reads the information from the disc file and automatically creates any needed entries in the database. This option is available only for those categories of information having their own browsers in DataCenter Admin.

Use data from file when defined in the database reads the information from the disc file and attempts to match it to already-existing entries in the database. This option is available only for those categories of information having their own browsers in DataCenter Admin.

When **Adding new files to an existing database** is the selection in the **What am I doing?** group, the options are set as shown:

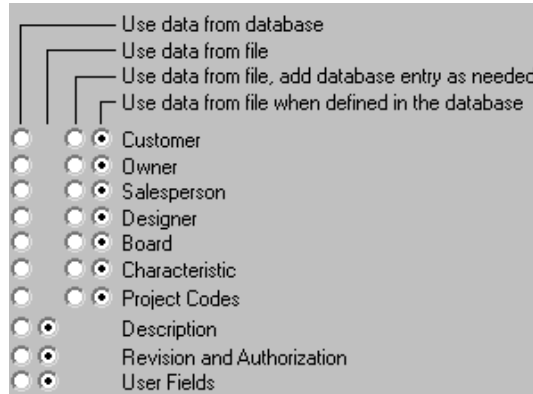

When **Rebuilding database using file information** is the selection in the **What am I doing?** group, the options are set this way:

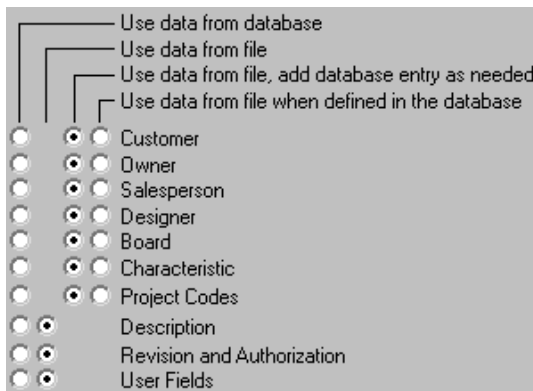

When **Refreshing files after database changes** is the selection in the **What am I doing?** group, the options are set like this:

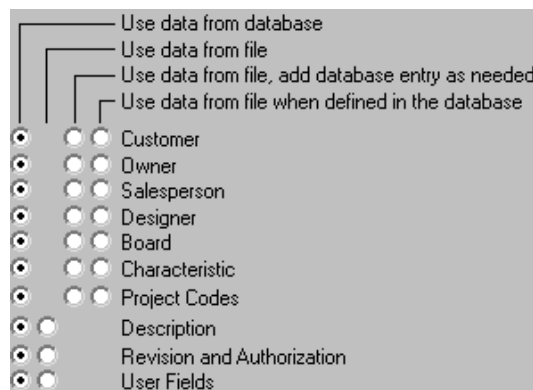

The **Use dates if found in database** checkbox uses the dates in the database if they are available. If they are not available, or this option is turned off, dates from the workspace are used.

The **Keep original saved date** checkbox, when checked, keeps as an element of the database record the date the file was originally saved, but the date and time of the physical file is changed in the filesystem because AutoLoad updates and saves the physical file. When this checkbox is cleared, the current date and time of the AutoLoad is used in both the database record and the filesystem.

The **Automatically embed parametric dependencies** checkbox controls whether ArtiosCAD automatically embeds in a design those components of a design which are required to rebuild it such as geometry macros and included designs.

The **Ignore revision extension scheme for ArtiosCAD files** checkbox, when checked, keeps AutoLoad from renaming revisions of ArtiosCAD files it processes.

The options in the **When converting non-ArtiosCAD files** group control what happens when AutoLoad encounters a foreign file with the same base name as an ArtiosCAD workspace. The ArtiosCAD workspace may have been modified since the last AutoLoad. The **Recreate ArtiosCAD file** checkbox, when checked, tells AutoLoad to delete the current ArtiosCAD file and recreate it from the foreign file; any modifications to the ArtiosCAD file since it was converted to an ArtiosCAD workspace will be lost. If the checkbox is clear, the foreign file is skipped and a warning is added to the log file.

The options in the **ArtiosCAD File Extensions** group control the filenames of non-native ArtiosCAD files. **Add ArtiosCAD filename extension** adds the appropriate .ARD or .MFG to the filename, which is useful when AutoLoading LASERPOINT IQ workspaces. **Replace current filename extension** deletes the current extension and replaces it with either .ARD or .MFG as appropriate, which is useful when AutoLoading .DES files from The Designer WorkBench. Note that .WBD files from The Designer WorkBench can not be AutoLoaded.

To perform an Advanced AutoLoad, set the options described above as desired and click **AutoLoad**. The files will be loaded into the database. When AutoLoad completes, click **Close** to return to the AutoLoad dialog box, and then click **Close** to return to ArtiosCAD.

AutoLoad notes and warnings

Only .DES files from The Designer WorkBench can be AutoLoaded; .WBD files can not be AutoLoaded.

AutoLoad assigns the default board code to designs that have no board code already defined.

When synchronizing design files with the database, and length, width, and depth variables are not set in the workspace and are not zero in the database, the variables in the workspace are set from the database.

AutoLoad does not rebuild 3D or paper information for boards. This information can come either from a database backup that is restored through DataCenter Admin, or by using the ArtiosCAD Database Export utility to export the board table before any problems occur and then by using the ArtiosCAD Database Import utility to import the board table back into the database.

Recommended AutoLoad procedure for foreign file types

If you want to use AutoLoad to automatically convert foreign files types (such as DXF and CF2) to ArtiosCAD workspaces, do the following:

1. Set up the default import tuning by configuring the Import Tuning entries in **Options > Defaults > Import Tuning Table** (adding or modifying the entries as appropriate).
2. Set the import tuning mapping in **Options > Defaults > Design Defaults > Default Import Tuning** to select the correct entry for the given file type.
3. Start to AutoLoad files starting with the default File Template file types. Make sure the **Recreate ArtiosCAD file** checkbox is checked on the Synchronization tab.
4. Following successful processing of these files, begin to AutoLoad any of the common format files separately by typing the appropriate entry into the file template text field, such as *.cf2 or *.dxf.
5. Once AutoLoad has completed, exit and restart ArtiosCAD before AutoLoading further file types.

This procedure will minimize the overall time required to AutoLoad the files. Note that using any of the database synchronization options can significantly increase the time required to process the desired files.

AutoLoad and Projects

When AutoLoading, depending on if the design is already in the database and if the design came from the same database, project codes will be handled differently.

If **Use data from database** is selected, and the file exists in the database, then ArtiosCAD will synchronize the information using the database values. If the file does not exist in the database, but came from the same database (has the same database ID), it will AutoLoad normally. If the file came from a different database (has a different database ID), the Project codes will be cleared and the file will AutoLoad normally.

If **Use data from file, add database entry as needed** is selected, database entries will be added as needed. Select this option to add Project codes from foreign files to your database.

If **Use data from file when defined in the database** is selected, Project codes which do not already exist in the database will be cleared from the file.

Resuming a previous AutoLoad

If AutoLoad terminates abnormally, you can resume it by doing the following:

1. Restart ArtiosCAD and click **Database > AutoLoad**.
2. Choose **Resuming a previous AutoLoad** in the initial **What Am I Doing?** group of the AutoLoad dialog box and click **OK**.

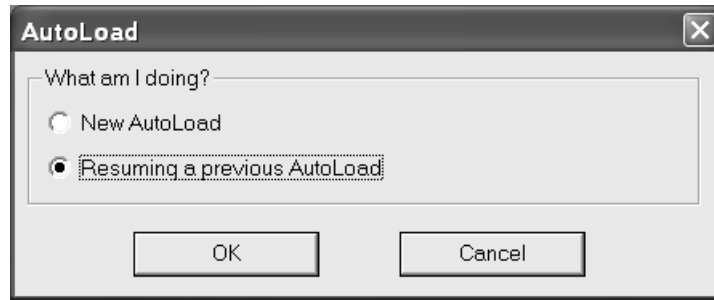

3. The AutoLoad dialog box appears with a different Input tab than for new AutoLoads.

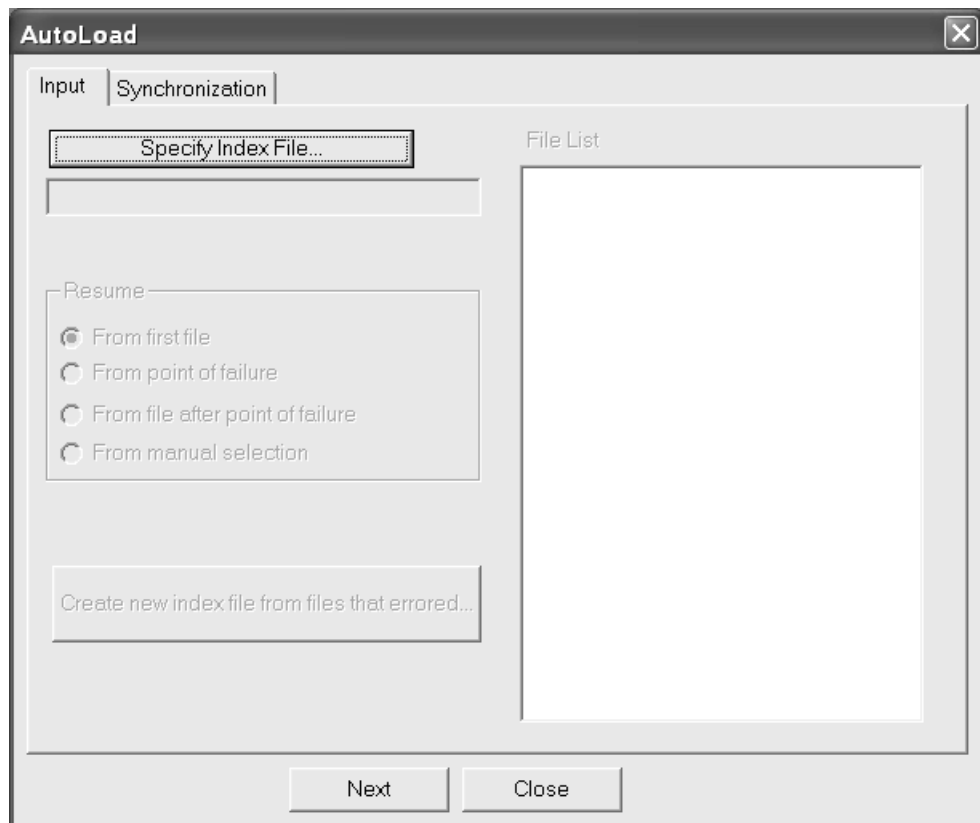

4. Click **Specify Index File** and find the ALOADLST.TXT file generated by the previous AutoLoad. The Open dialog box opens in the default design directory; browse for the file if you specified a different location for the index file in the previous AutoLoad. Select the file and click **Open**.

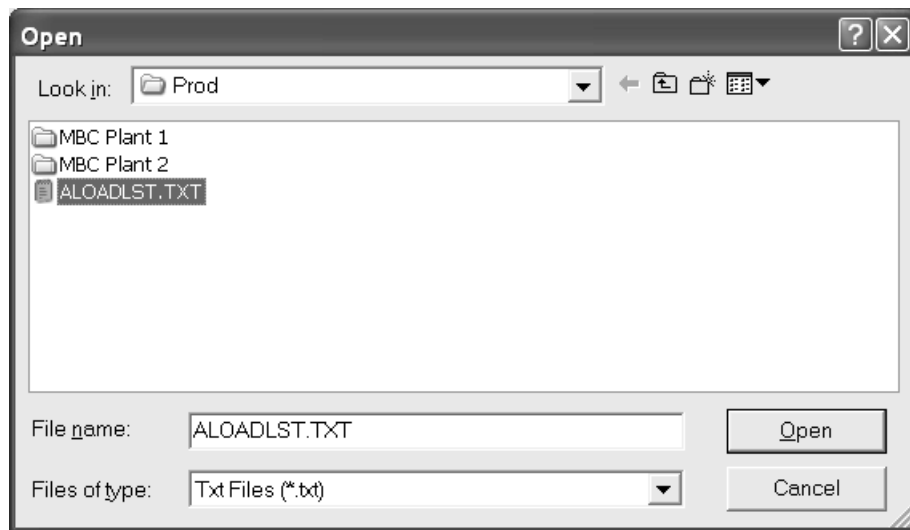

5. The **File List** group shows the files that AutoLoad previously attempted to process. The first file after the point of failure is highlighted by default.

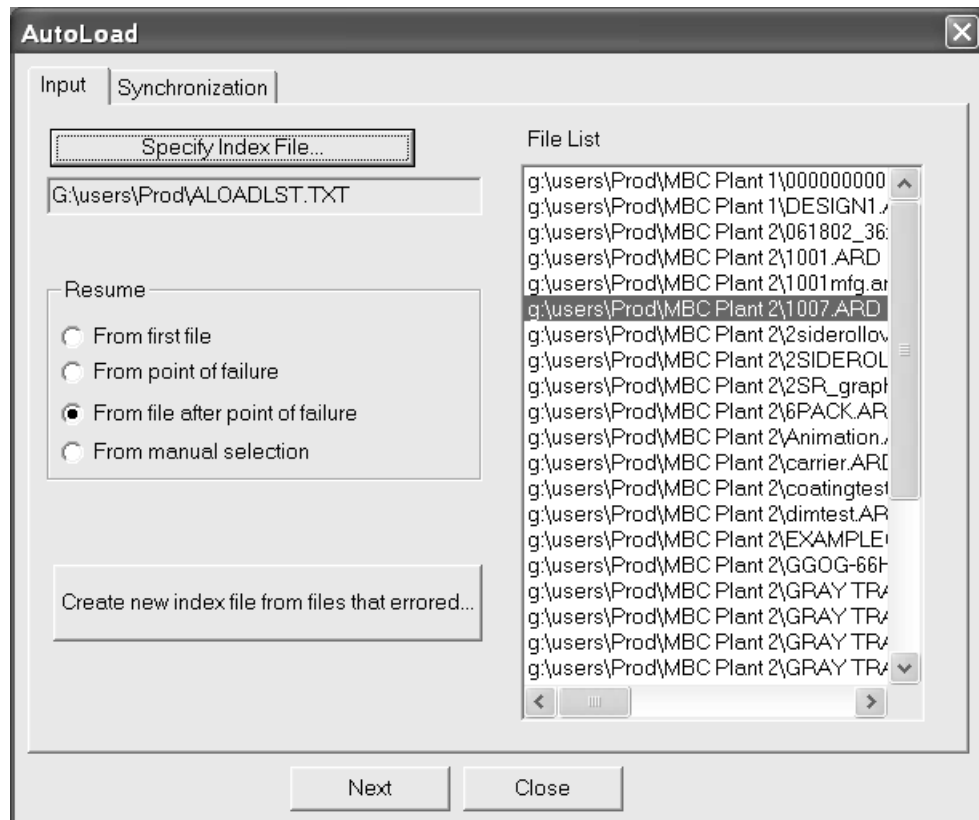

6. Choose the option in the **Resume** group at which AutoLoad is to resume:

From first file chooses the first file in the list.

From point of failure selects the last file the previous AutoLoad attempted to process. To avoid another abnormal termination, you should try to open this file manually in ArtiosCAD and save it before choosing this option.

From file after point of failure is the default, and selects the first file after the one that caused an abnormal termination.

From manual selection lets you select the file in the File List at which the AutoLoad resumes.

7. Click the **Synchronization** tab and set the options as desired.
8. Click **AutoLoad**. It will resume from the file chosen in step 6.
9. When the AutoLoad finishes, click **Close** to close the AutoLoad Status dialog box and then click **Close** to close the AutoLoad dialog box.

Create new index file from files that errored creates an index file of any files in the AutoLoad that errored, except for those loaded into a destination resource. Click it and then enter a sensible path and filename for the new index file and click **Save**. That index file is then automatically loaded into the file pane. Try AutoLoading again; if they error, examine the log file by clicking **View Log**. To resolve the error, try to open the files in ArtiosCAD and then save them.

Database network performance

Typically, databases which run over WANs (Wide Area Networks), for example between plants, experience slower network performance compared to those which run over faster LANs (Local Area Networks). By default, ArtiosCAD requests a complete set of database entities each time the Database Information dialog box is activated, which can lead to wait times if there are many records to download from the database server.

To address this, ArtiosCAD can store the **Customer, Owner, Designer, Salesperson, Characteristics, and User Fields** entities from the Database Information dialog box in memory, as well as the boards, companies, company types, and Resources. This is called **caching**.

Both ArtiosCAD and CAD-X can use this feature, and each will use more memory if it is enabled.

Once the database dialog box entries or other entities are loaded into memory, ArtiosCAD does not re-request them from the database. If changes are made to the entities in the database itself, ArtiosCAD will not see them until the cache is refreshed or a new ArtiosCAD session is started. To refresh the cache, click **Database > Refresh cache > Item**.

The Customer cache is refreshed when the **New** button in the Customer dialog box is clicked.

Refreshing the cache may take a while on a slow WAN with very large entity lists.

ArtiosCAD can also search the database for specific records which match a pattern thus returning only a few records instead of thousands. This feature is called **pattern searching**.

For information about configuring these options, refer to the *Defaults* chapter.

Connecting to the database

Connecting to the database should be automatic. However, in the event of network trouble that severs the connection, click **Database > Connect**. This command is unavailable when there is a current connection.

Pattern searching

When pattern searching is enabled in Defaults, the Oneup Design Information and Manufacturing Database Information dialog boxes change. The drop-down list boxes for the **Customer**, **Owner**, **Designer**, and **Salesperson** fields disappear and the fields become disabled. In addition, there are ... buttons leading to dialog boxes which let you search for records and then display details about the selected records, or display details if there is already a selected record. Shown below is the Customer dialog box; all four dialog boxes act similarly, but only the Customer dialog box has the **New** button.



Pattern searching works by entering a few letters of a word, or a whole word, or a complete phrase, then choosing a method of searching, and then clicking **Find**. The results of the search populate the drop-down list box.

For example, to find the Meeber Box Company, one could enter just the first few letters - **Meeb** - and choose **Begins with**. Or, one could enter **Box** and choose **Contains**. Finally, one could enter **Meeber Box Company** and choose **Equals**, and then click **Find**. Clicking the drop-down list box activator will display a list of results from which the desired entry is chosen.

Clear clears the current search results and lets you search for a new value.

New appears only in the Customer dialog box and lets you enter a new Customer database record.

The double chevrons (« and ») display the previous and next entry in the search results, respectively.

To accept the results of the search, click **OK**; otherwise, click **Cancel** to return to the previous dialog box.

Installing additional characteristics

Two files containing many additional characteristics are installed to the \Esko\Artios\DataCenter directory when ArtiosCAD is installed. The two files are FoldingCartonCharacteristics.txt and CorrugatedCharacteristics.txt. You may load one of them, both of them, or neither at your discretion.

To load them into the database, do the following:

1. Make sure no one is using ArtiosCAD, DataCenter Admin, SpecLink, or WebCenter (version 3 or below) to insure that the database is not being accessed.
2. Log on to the database server as Administrator or as a member of the **Administrators** group.
3. Start DataCenter Admin.
4. Click **File > Loader**.

5. When prompted for a username and password, enter **admin** for the username and do not enter a password.
6. The ArtiosCAD Database Loader Utility dialog box will appear. Enter the name of the new characteristics file to load in the **Name:** field, and enter the path (such as C:\Esko\Artios\DataCenter) in the **Path:** field. Or, click **Browse** to navigate to the file.
7. In the **Tables to Import** group, check the **Design Characteristic** checkbox. If you want to replace the existing characteristics, check the **Replace Characteristic Tree** checkbox. To merge the new characteristics in with the existing characteristics, leave the checkbox blank. The dialog box should look similar to the one shown below.

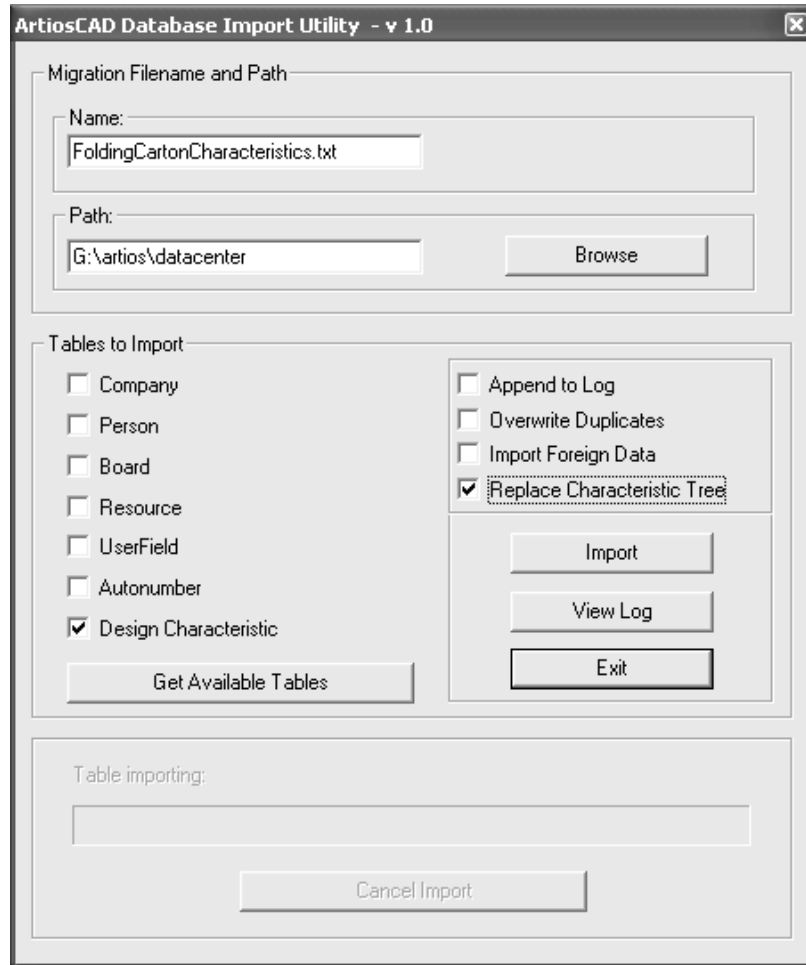

8. Click **Import**. The **Table Importing** progress bar will increment as the file loads.

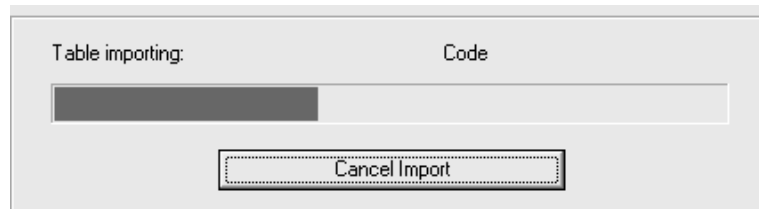

9. When it is done, you may load the other new characteristics file by repeating steps 5 through 7, substituting the name of the other file in the **Name:** field, and making sure to not select the **Replace Characteristic Tree** checkbox (otherwise the characteristics from the file you just loaded would be overwritten).

10. To view the log file, click **View Log**. To exit the utility, click **Exit**.

Changing the database password

Do not change the database passwords in a vendor-supplied utility. Rather, change them in DataCenter Admin by using the **File > Change Database Connection (programmer) Password** or **Change Database System Administrator (sa) Password** commands.

When running DataCenter Admin in an operating system supporting User Access Control, you must be logged in as an administrative user to change the database password. The **Change Database Password** command is unavailable if you are not an administrative user.

17. Appendix

Changed Icons and Toolbars as of Version 14

As of version 14, ArtiosCAD has larger, redesigned tool icons in Single Design, 3D, and Manufacturing. Please refer to the sections below for new and old tool icons. The tools are grouped by toolbar, and the toolbar order is the same as that listed in the Toolbar Master Controls.



















There are also changes to the toolbars in Single Design:

- The Adjust toolbar has been split into the Adjust toolbar and the Prepare Manufacturing toolbar.
- The tools on the Graphics toolbar are in a different order.

If you have upgraded from an earlier version of ArtiosCAD, please use this section to help find familiar tools.

Single Design Tool Icons

Table: Single Design Icons

Tool	New Icon	Old Icon
View toolbar		
Zoom Rectangle		
Center-Point Zoom		
Zoom Out		
Scale to Fit		
Scale to Fit with Border		
Pan/Zoom		
View Mode		
Geometry toolbar		
Line Angle/Offset		
Line Horiz/Vert		

Tool	New Icon	Old Icon
Line Angle/Length		
Arc Start Angle		
Arc End Point		
Arc Center		
Arc Through Point		
Circle Radius		
Circle Diameter		
Ellipse		
Rectangle Horiz/Vert		
Rectangle from Center		
Rectangle from Line		
Offset Line		
Straight Curve		
Curve Straight		
Line Join		
Arc Join		
Tangent Arc		
Line At Angle From Line		
Bezier		
Move to Point		
Dimension toolbar		
Temporary Dimensions		

Tool	New Icon	Old Icon
Distance Dimension		
Auto Aligned Distance Dimension		
Aligned Distance Dimension		
Cumulative Distance Dimension		
Angle Dimension		
Angle To Horiz. Dimension		
Angle To Vertical Dimension		
Radius Dimension		
Radius To Circle Dimension		
Diameter Dimension		
Diameter To Circle Dimension		
Change Dimension Alignment		
Change Text Position		
Change Extension Line Length		
Auto Dimension		
Adjust toolbar (split)		
Blend		
Chamfer		
Blend Three Lines		
Split Line		
Trim/Extend Two Lines		



































Tool	New Icon	Old Icon
Trim/Extend One Line		
Trim Interior		
Trim Against Selection		
Extend Line		
Stretch Point		
Stretch by Polygon		
Follow		
Conlines toolbar		
Conline Offset/Angle		
Conline Offset		
Conline At Angle From Line		
Conline Division/Midpoint		
Conline Radius		
Conline Angle Divide		
Conline Join		
Conline Join With Concircle		
Conline Tangent Concircle		
Edit toolbar		
Select		
Select Conlines		
Select by Example		
Delete		

Tool	New Icon	Old Icon
Move to Layer		
Move		
Rotate Right 90		
Rotate Left 90		
Rotate 180		
General Rotate		
Mirror About Vertical		
Mirror About Horizontal		
Vertical Mirror About Center		
Horizontal Mirror About Center		
Mirror About Line		
Scale		
Differential Scale		
Copy		
Repeated Copy		
Copy Rotate Right 90		
Copy Rotate Left 90		
Copy Rotate 180		
Copy General Rotate		
Copy Mirror About Vertical		
Copy Mirror About Horizontal		
Vertical Copy Mirror About Center		

Tool	New Icon	Old Icon
Horizontal Copy Mirror About Center		
Copy Mirror About Line		
Complete Design From Half/Quarter		
Copy Times Offset		
Copy Times Rotate		
Ungroup		
Ungroup All		
Group		
Group Sequence		
Offset Lines		
Annotation toolbar		
Text		
Align Left		
Align Horizontal Center		
Align Right		
Align Bottom		
Align Vertical Center		
Align Top		
Arrow		
Detail		
Adjust Detail		
Outline Text		

Tool	New Icon	Old Icon
Line Text		
Line Type Label		
Hatch		
Define Mate Area		
Artwork Panels		
Dynamic Art		
Undo-Redo toolbar		
Undo		
Redo		
Skip Next Redo		
Run All Redo		
Discard All Redo		
Edit Next Redo		
Rebuild		
Rebuild Playback		
Adjust Outline toolbar		
Make Horizontal/Vertical		
Align Horizontal/Vertical		
Merge Line Straight		
Merge Lines Into Arc		
Merge Lines Into Bezier		
Merge Lines To Intersection		

Tool	New Icon	Old Icon
Adjust Arc		
Straighten		
Adjust Bezier		
Reverse Direction		
Sequence		
Extend/Measure toolbar		
Extend		
Clear Extend		
Measure		
Advanced Standard toolbar		
Line Angle Or Offset		
Arc Angle Offset		
Horizontal Angle/Offset Dimension		
Vertical Angle/Offset Dimension		
Graphics toolbar (reordered)		
Add Graphics		
Register Bitmap		
Clip Graphics		
Replace Graphics		
Move Graphics		
Autotrace Bitmap		
Color Stock		

Tool	New Icon	Old Icon
Fill		
Stroke		
Fill Panel		
Send To Front		
Send To Back		
Reports toolbar		
Prompted Text From Table	<i>Ta</i>	
Prompted Text From New Variable		
Calculated Text	<i>Tx</i>	
File Window		
Adjust File Window		
Report Size		
Counter toolbar		
Create Or Rebuild Counter		
Rebuild Chamfer		
Add Counter Name		
Add Counter Tack Bridge		
Delete Counter Tack Bridge		
Add Counter Strap		
Select Periphery Lines		
Registration Holes toolbar		
Add Hole		

Tool	New Icon	Old Icon
Add Countersunk Hole		
Add Oblong Hole		
Add Countersunk Oblong Hole		
Add Drill Hole		
Add Countersunk Drill Hole		
Prepare Manufacturing toolbar (new)		
Bleed		
Coating Free Area		
Add Bridge		
Add Tack Bridge		
Add Nick		
Delete Bridge		
Move Bridge		
Online Through Bridge		
Delete Nick		
Move Nick		
Online Through Nick		
Shorten Creases		



































Manufacturing Tool Icons

Table: Manufacturing Tool Icons









































Tool	New Icon	Old Icon
Manufacturing toolbar		



Tool	New Icon	Old Icon
Select Element		
Delete		
Repeat		
Delete All		
Delete Strip Area		
Create Wood Edge		
Create Hand Hold		
Create Burn Name		
Add Bridge		
Add Tack Bridge		
Delete Bridge		
Move Bridge		
Conline Through Bridge		
Add Nick		
Delete Nick		
Move Nick		
Conline Through Nick		
Create or Rebuild Counter		
Dieboard toolbar		
Create Stripping Rule (Line/Edge)		
Create Stripping Rule (Angle/Offset)		
Evenly Spaced Scrap Knives		































Tool	New Icon	Old Icon
Move Scrap Knives		
Create Carrier Rule		
Make Hook		
Balance Knives		
Rotary Die Board		
Add MHP Holes		
Select MHP		
Delete All MHP		
Adjust MHP Horizontally		
Adjust MHP Vertically		
Double Knife Removal		
Add Gripper		
Horizontal Split		
Stripping Board toolbar		
Strip Area		
Upper Push Pin tool		
Upper Rule tool		
Upper Block tool		
Upper Block Pin tool		
Add Interference		
Make Air Hole		
Make Alignment Hole		

Tool	New Icon	Old Icon
Add Support Holes		
Add Registration Holes		
Add Lower Board Mounting Bar		
Create Separator		
Manual Layout toolbar		
Add Oneup		
Oneups Dialog		
Change Gutter Distance		
Change Sheet Size		
Edit Layout toolbar		
Select Oneups		
Copy Oneups		
Copy Times Oneups		
Delete Oneups		
Move Oneups		
Rotate Oneup 180		
Rotate Right Oneup		
Rotate Left Oneup		
Rotate Oneup By Angle		
Mirror About Vertical Oneup		
Mirror About Horizontal Oneup		

Tool	New Icon	Old Icon
Straight Nest		
Reverse 2nd Row Nest		
Reverse 2nd Row Align Nest		
Reverse 2nd Column Nest		
Reverse 2nd Column Align Nest		
Layout Manual Sequencing		
Replace Oneups		
Change Print Item		
Open Embedded Design		
Intelligent Layout toolbar		
Quantities And Costs		
Intelligent Layout Parameters		
Specify Nest		
Delete Nest		
Move Design Or Column		
Rule Path toolbar		
Build Rule Path		
Delete Rule Path Layer		
Add Rule Path		
Select Rule Path		
Split Rule Path		



Tool	New Icon	Old Icon
Join Rule Path		
Move Bridge Start Point		
Reverse Rule Path		
Move Bridge Start Point To Center		
Change Wrap Point		
Add Bridge On Rule Path		
Re-Bridge Rule Path Layer		
Add Mark To Rule Path		
Delete Bridge On Rule Path		
Move Bridge On Rule Path		
Align Bridge On Rule Path		
DieSaw toolbar		
Generate Leader Holes		
Add Leader Hole		
Delete Leader Hole		
Reverse Cut		
Delete DieSaw Layer		
Rubbering toolbar		
Rubber Area		
Repeat Rubber Element		
Delete All Rubber		
Delete Rubber Area		

Tool	New Icon	Old Icon
Select Rubber		
Split Rubber		
Join Rubber		
Move Rubber Split		
Trim Rubber		
Add Rubber		
Subtract Rubber		
Fill Rubber Area		
Add Separator		
Move Separator		
Delete Separator		
Add Open-Out		
Delete Open-Out		
Subtract Bolt Holes		
Update Plastic Cover		
Group Rubber		
Ungroup Rubber		
Layout Rubber		
Rubber View Options toolbar		
Highlight Rubber With Repeat		
List Rubber Elements		

Tool	New Icon	Old Icon
Rubber View Options		
Blanking toolbar		
Add Grid Bar		
Include Strip Rules		
Generate Blanking Tools		
Adjust Blank Holes		
Adjust Pushers		
Add Non-Stop Swords		
Add Photocells		
Add Jogger Guides		
Add Support Bars		
Add Air Holes		
Add Blanker Pusher Pins		
Add Hardware		
Add Tie-Bolts		
Add Pressers		
Delete Blanking		

3D Tool Icons

























Table: 3D Tool Icons

Tool	New Icon	Old Icon
3D View toolbar		
Zoom Rectangle		

Tool	New Icon	Old Icon
Center-Point Zoom		
Zoom Out		
Zoom In/Out		
Scale To Fit		
Scale To Fit With Border		
Pan/Zoom		
View Angle		
Previous View		
Next View		
Rotate Right		
Rotate Down		
Orthogonal View		
Perspective		
Light Source		
View Mode		
3D Tools toolbar		
Select Designs		
Select Labels Or Parts		
Select Tear-Away Part		
Move Point to Point		
Move Designs		
Move Designs X, Y, Z		

Tool	New Icon	Old Icon
Duplicate Designs		
Duplicate Designs X, Y, Z		
Ungroup Designs		
Group Designs		
Rotate Designs		
Drag On Plane		
Array Copy		
3D Dimension toolbar		
Dimension		
Select Dimensions		
Change Dimension Alignment		
Change Text Position		
Animation toolbar		
Add Frame		
Update Frame		
Update Range Of Frames		
Animation Playback		
Delete Frame		
Shuffle Frame Forward		
Shuffle Frame Back		
Make Tear-Away Animation		
3D Extend toolbar		

Tool	New Icon	Old Icon
Extend		
Extend Design		
Clear Extend		
Cross Section toolbar		
Intersect Design Tool		
Cross Section Tool		
Bounding Box Tool		
Run A Standard Tool		
Fold in 3D toolbar		
Fold Angle		
Fold All		
Fold 2 To Meet		
Fold 1 To Meet		
Flap Priority		
Bend Panel		
Mate		
Mate All		
Undo Mate		
Snap Tab/Slot		
Update 2D		
View Mode toolbar		
Solid		

Tool	New Icon	Old Icon
Solid With Edges		
Lighter Color With Edges		
Hidden Lines Removed		
Wire Frame		
Perspective		
Board Thickness		
Graphics		
Transparent		
Creases Pink		
Bounding Box		
Floor Shadows		
3D Rendering And Image Quality		

Arithmetic functions

Included in ArtiosCAD are arithmetic functions which can be used anywhere that data is input. In the table below, the capitalized letters in the function are the minimum you have to enter into the data entry field.

Table: Arithmetic Functions

Function	Usage
ARCCos	<p>Calculates the angle that has the specified cosine.</p> <p>Syntax:</p> <p>ARCCos(cosine)</p> <p>Result: Angle between 0 and 180. ArtiosCAD will error if the cosine value is outside range -1..1.</p> <p>For example, ARCCOS(0) = 90</p>

Function	Usage
ARCSin	<p>Calculates the angle that has the specified sine.</p> <p>Syntax:</p> <p>ARCSin(sine)</p> <p>Result: Angle between -90 and 90. ArtiosCAD will error if the sine value is outside range -1..1.</p> <p>For example, ARCSIN(1) = 90</p>
ARCTan	<p>Calculates the angle that has the specified tangent.</p> <p>Syntax:</p> <p>ARCTan(tangent)</p> <p>Result: Angle between -90 and 90. For example, ARCTAN(1) = 45</p>
COSine	<p>Calculates the cosine of an angle. The angle must be in degrees but there are no limits on the value used for the angle. Syntax:</p> <p>COS(angle)</p> <p>Result: Number between -1.0 and 1.0 For example, COS(0) = 1 COS(60) = 0.5 COS(180) = -1.0</p>
POWER	<p>Raises the number to the given power. Fractional powers are not permitted for negative numbers. Syntax:</p> <p>POWER(value,exponent)</p> <p>The value and exponent must be separated by a comma regardless of the language in which you are using ArtiosCAD. To use a decimal exponent, use a period as the decimal separator, not a comma.</p> <p>Result: Numeric.</p> <p>For example,</p> <p>POWER(3,2) = 9 POWER(64,1/3) = 4 POWER(2,3) = 8 POWER(64,-1/3) = 1/4 POWER(-2,3) = -8 POWER(5,3.6) = 328.316</p> <p>Note: To calculate a hypotenuse, use the following expression: $C^2 = A^2 + B^2$ C = Square root of (A+B) C = POW((POW(A,2)+POW(B,2),.5)</p>
SINe	<p>Calculates the sine of an angle. The angle must be in degrees but there are no restrictions on the value used for the angle. Syntax:</p>

Function	Usage
	<p>SIN(angle)</p> <p>Result: Number between -1.0 and 1.0.</p> <p>For example,</p> <p>SIN(0) = 0.0 SIN(30) = 0.5 SIN(360) = 0.0</p>
SQRT	<p>Calculates the square root of an arithmetic expression. Not valid for negative numbers. Syntax:</p> <p>SQRT(expression)</p> <p>Result: Numeric.</p> <p>For example,</p> <p>SQRT(36) = 6</p>
TAN	<p>Calculates the tangent of the angle. The angle must be in degrees but there are no limits on the value used for the angle. Syntax:</p> <p>TAN(angle)</p> <p>Result: Number.</p> <p>For example, TAN(0) = 0, TAN(45) = 1, TAN(60)=1.73205, TAN(-45) = -1</p>

Reserved words

The following words and word fragments are reserved for use by ArtiosCAD. Do not use them for variable names or in command files.

Table: Reserved Words

ARC	AT	BOT	BOTT	BOTTO	BOTTOM	BRI
BRID	BRIDG	BRIDGE	BY	BYX	BYY	CEN
CENT	CENTE	CENTER	CENTR	CENTRE	CIR	CIRC
CIRCL	CIRCLE	COR	CORN	CORNE	CORNER	CS
DIA	DIAM	DIAME	DIAMET	EXPAND	EXT	EXTE
EXTEN	EXTEND	FCC	FCN	FIN	FINI	FINIS

FINISH	FON	FONT	FOR	FORM	FORMA	FORMAT
FRO	FROM	ITE	ITEM	LEF	LEFT	LEN
LENG	LENGT	LENGTH	LONG	MOV	MOVE	NEA
NEAR	OFF	OFFS	OFFSE	OFFSET	ORI	ORIE
ORIEN	ORIENT	POI	POIN	POINT	POINTA	POS
POSI	POSIT	POSITI	RAD	RADI	RADIU	RADIUS
RELAX	REV	REVE	REVER	REVERS	RIG	RIGH
RIGHT	SC	TCC	TCN	TEX	TEXT	THR
THRO	THROU	THROUG	TO	TOL	TOLI	TOLIN
TOLINE	TOP	TOX	TOY	TYP	TYPE	VAR
VARI	VARIA	VARIAB	WID	WIDT	WIDTH	WSCALE

List of line types

Below is the complete list of line types in the order in which they appear in ArtiosCAD. The **Grouped in** column indicates in which group the line type is found. The **Number** is the line designation in fundamental ArtiosCAD syntax.

Table: List of Line Types

Line type name	Grouped in	Number	Category / Notes
Cut	Design	1	Rules
Crease	Design	2	Rules
Partial cut	Design	4	Rules
Reverse partial cut	Design	9	Rules
Reverse crease	Design	8	Rules
Second height crease	Design	223	Rules
Matrix crease	Design	224	Rules
Half crease	Design	16	Rules

Line type name	Grouped in	Number	Category / Notes
Unknifed diecut	Design	12	Center edge
Die etch	Design	18	Etch
Print registration	Design	10	Annotation
Inside Bleed	Design	212	Annotation
Outside Bleed	Design	11	Annotation
Inside Coating (Varnish)	Design	213	Annotation
Outside Coating (Varnish)	Design	85	Annotation
Annotation	Design	0	Annotation
Annotation2	Design	207	Annotation
Annotation3	Design	208	Annotation
Annotation4	Design	209	Annotation
Annotation5	Design	210	Annotation
Dimensions and text	Design	20	Annotation
Print image	Design	14	Annotation
Form lines 1	Design	23	Annotation
Form lines 2	Design	24	Annotation
Copy area	Design	262	Annotation
Copy free	Design	263	Annotation
Dynamic art	Design	264	Annotation
Side bevel	Generic rules	19	Rules
Generic perf	Generic rules	3	Rules
Generic perf in channel	Generic rules	6	Rules
Generic cut and crease	Generic rules	5	Rules
Partial cut and crease	Generic rules	15	Rules

Line type name	Grouped in	Number	Category / Notes
Glue assist	Generic rules	7	Rules
Generic special rule	Generic rules	13	Rules
Partial cut perf	Generic rules	251	Rules
Reverse partial cut perf	Generic rules	252	Rules
Partial cut perf in channel	Generic rules	253	Rules
Second height cut crease	Generic rules	254	Rules
Second height partial cut crease	Generic rules	255	Rules
Reverse partial cut crease	Generic rules	256	Rules
Usable limit of sheet	Utility	97	Annotation
Edge of sheet	Utility	98	Annotation
Axes	Utility	31	Annotation
Construction line 1	Utility	34	Annotation
Construction line 2	Utility	33	Annotation
Construction line 3	Utility	32	Annotation
Canvas construction line	Utility	35	Annotation
Nick	Utility	17	Annotation
Tear	Utility	205	Annotation
Bend	Utility	206	Annotation
Size only	Utility	215	Used for Size information only
Stripping rule	Dieboard	93	Rules
Carrier rule	Dieboard	94	Rules

Line type name	Grouped in	Number	Category / Notes
Scrap/Chop knife	Dieboard	96	Rules
Balance knife	Dieboard	218	Rules
Unknifed diecut	Dieboard	12	Center edge Same as earlier versions of ArtiosCAD. Also used for floats.
Die board edge	Dieboard	170	Outside edge Also used for die splits. Milled parts of the dieboard edge for DieSaw output are distinguished using different subtypes.
Die registration hole	Dieboard	171	Inside edge Used for registration holes or chase holes.
Laser position holes	Dieboard	216	Inside edge
Die bolt holes	Dieboard	217	Inside edge. Drill holes for DieSaw output are distinguished using different subtypes.
Die etch	Dieboard	18	Etch For labels that are burned in the die.
Lead hole	Dieboard	172	Inside edge Lead hole for the DieSaw in the rule path layer.
Unknifed lead in	Dieboard	173	Center edge Lead in line which starts a cut by the DieSaw but is not part of the design and has no rule.
Die split	Dieboard	174	Outside edge Used to divide the die into pieces.
Gripper finger	Dieboard	219	Annotation
Lower board edge	Lower board	175	Outside edge

Line type name	Grouped in	Number	Category / Notes
Lower stripping hole	Lower board	176	Inside edge The lower holes must be separate from other holes because the processing to create the upper board depends on them.
Lower registration hole	Lower board	177	Inside edge
Lower etch	Lower board	178	Etch For labels that are burned into the lower board
Unknifed lower	Lower board	179	Center edge For a slot with a specified width, such as the end of a carrier rule outside the stripping hole.
Hole inside modifier	Lower board	180	Inside edge The inside edge of an interference made of wood which extends partly into the lower stripping hole.
Hole outside modifier	Lower board	181	Inside edge A slot in the edge of a lower stripping hole which holds the outside edge of an interference element.
Hole interference	Lower board	182	Inside edge The edge of the active part of an interference element.
Upper board edge	Upper board	183	Outside edge
Stripping block	Upper board	184	Outside edge
Block support pin	Upper board	185	Inside edge
Upper stripping rule	Upper board	186	Rules The base of the stripping rule which is burned in the upper board
Pusher base	Upper board	187	Inside edge

Line type name	Grouped in	Number	Category / Notes
			The base of the push pin or pusher element which is burned in the upper board
Pusher active part	Upper board	188	Inside edge The active part which pushes the waste
Pusher shoulder	Upper board	189	Annotation The shoulder that stops the element from being pushed through the upper board
Pusher clearance	Upper board	190	Annotation Shows the effective size of the pusher or pin.
Upper air hole	Upper board	191	Inside edge
Upper registration hole	Upper board	192	Inside edge
Upper etch	Upper board	193	Etch For labels which are burned in the upper board
Unknifed upper	Upper board	194	Center edge For a slot with a specified width.
Front waste edge	Front waste separator	195	Outside edge
Front waste registration hole	Front waste separator	196	Inside edge
Front waste etch	Front waste separator	197	Etch
Rubber inside edge	Rubber	220	Annotation. Distinguished from the rest of the outline so that it can be cut with a bevel on machines that have a tilting head.
Rubber outline	Rubber	221	Annotation

Line type name	Grouped in	Number	Category / Notes
Rubber name	Rubber	222	Annotation. Used to cut numbers on each piece of rubber.
Blanker lower board edge	Blanker	227	
Blanker lower hole	Blanker	228	
Blanker lower registration hole	Blanker	229	
Blanker lower etch board	Blanker	230	
Blanker upper board edge	Blanker	231	
Blanker upper air hole	Blanker	232	
Blanker upper registration hole	Blanker	233	
Blanker upper etch	Blanker	234	
Blanker pusher edge	Blanker	235	
Blanker pusher air hole	Blanker	236	
Blanker pusher registration hole	Blanker	237	
Blanker pusher etch	Blanker	238	
Blanker frame	Blanker	239	
Blanker non-stop sword	Blanker	240	
Blanker photocell	Blanker	241	
Blanker grid	Blanker	242	
Blanker support bar	Blanker	243	
Component active part	Blanker	244	
Component edge	Blanker	245	

Line type name	Grouped in	Number	Category / Notes
Component clearance	Blanker	246	
Component annotation	Blanker	247	
Sample knife	Sample	120	Etch
Sample partial cut knife	Sample	121	Etch
Sample crease with grain	Sample	122	Etch
Sample crease cross grain	Sample	123	Etch
Sample pen 1	Sample	124	Etch
Sample pen 2	Sample	125	Etch
Sample pen 3	Sample	126	Etch
Sample pen 4	Sample	127	Etch
Sample reverse partial cut	Sample	128	Etch
Sample reverse crease	Sample	129	Etch
Sample reverse crease cross grain	Sample	130	Etch
Sample counter knife	Sample	131	Etch
Sample router with grain	Sample	132	Etch
Sample router cross grain	Sample	133	Etch
Sample counter pen	Sample	134	Etch
Sample V-notch crease	Sample	135	
Sample V-notch cut	Sample	136	
Sample drill hole	Sample	137	
Sample reverse V-notch crease	Sample	138	

Line type name	Grouped in	Number	Category / Notes
Sample 2nd height crease with grain	Sample	225	Etch
Sample 2nd height crease cross grain	Sample	226	Etch
Sample 2nd height partial cut	Sample	265	Compression bend
Sample 2nd height reverse cut	Sample	266	Reverse compression bend
Tool 1	Tooling	140	Etch
Tool 2	Tooling	141	Etch
Tool 3	Tooling	142	Etch
.	.	.	.
.	.	.	.
.	.	.	.
Tool 28	Tooling	167	Etch
Tool 29	Tooling	168	Etch
Tool 30	Tooling	169	Etch
With grain crease	Counter	100	Etch
Cross grain crease	Counter	101	Etch
Crease end tool	Counter	102	Etch
Periphery tool	Counter	103	Etch
Chamfer tool	Counter	104	Etch
2 nd height with grain crease	Counter	105	Etch
2 nd height cross grain crease	Counter	106	Etch
Name tool	Counter	107	Etch

Line type name	Grouped in	Number	Category / Notes
Positioning hole tool	Counter	108	Etch
Milling tool	Counter	109	Etch
Counter mill outline	Counter	110	Etch
Position holes 2	Counter	111	Etch
Counter slot	Counter	112	Etch
Reverse chamfer	Counter	113	Etch

Glossary

Term	Definition
Accept ratio problems	A checkbox that allows the user to continue running a standard even if the ratio of the variables (length, width, depth, etc.) is not in correct proportion.
Account for Deflection	An adjustment for the deflection of a tool when cutting the counter. It is used to ensure channel width accuracy.
Advanced	A button that gives access to more options.
Air hole	Hole(s) made in the stripping board to help prevent jams caused by a vacuum effect.
Alignment hole	Hole(s) made in the die board to allow quick and easy alignment of a set of manufacturing tools.
Allow Rotation on Repeat	A menu checkbox in Manufacturing Layout that gives the option to consider rotated one-ups the same as non-rotated one-ups and therefore do the same operations in congruent areas.
allowance reduction	An addition to the bridge's width to compensate for the leader hole's reduction of the bridge's width when using a diesaw.
Angle	The number of degrees between two lines or between a line and an axis
Annotation	Details, arrows, and text that are typically placed on a drawing to provide more explanation.
Arc	A portion of a circle.

Term	Definition
Area	A value calculated by multiplying length and width.
Authorization	Approval by authority.
Authorization Msg	A field for marking a design. Typically initialed as “approved by” or marking it with an appropriate comment.
Auto Aligned Distance Dimension	A tool that dimensions a series of parallel lines in a design.
Auto Numbering	Automatically sequencing the next design and/or revision in ascending order based on configuration.
Auto-Detect	An importing option that decides if a file should be imported as a Layout or Oneup. This decision is made based on the contents of the file.
AutoLoad	A utility which gathers information about existing CAD designs and layouts. Then it imports the data into DataCenter and saves them with the appropriate ArtiosCAD file extension.
Auto-Repeat	Automatically repeats elements in manufacturing such as stripping rules, holes, and pins throughout similar areas of the layout.
AutoSave	A utility that will create temporary backup files that are available for recovery should the system crash.
AutoSave Recovery	A dialog box offering the option to recover the temporary backup files created by the AutoSave feature.
AutoTrace Bitmap	A tool that replaces a bitmap with lines and arcs that can be manipulated in ArtiosCAD.
Balance Knives	Steel rules that are used to balance the load on a dieboard for a platen press. They are also called leveling knives.
Base Face	The selected panel of the design around which all other panels fold. Used in 3D mode.
Basic Dimensions	The dimensions that are required to be entered to run a standard, typically length, width, and depth.
Beeps	A sound/noise made to inform the user of things such as data received or an error in snapping.
Belt speed	The number of feet per minute that a conveyer belt moves. The belt speed and travel distance are used in one method of determining the number of sheets per hour in the Intelligent Layout module.

Term	Definition
Bend corners	A grouping of options to take a piece of rule and extend it around a corner at an angle on a rotary die. The options are to take the rule from rotary to flat or from flat to rotary.
Bend Length	In a rotary die, the length of the chop knife that is used for transitioning corners from rotary rule to flat rule or from flat rule to rotary rule.
Between teeth	An option to have bridging start between the teeth on a rotary rule.
Bevel	An option for joining strokes that chamfers the outside edges of strokes that meet. Strokes are graphical additions to a line. The Bevel option can be used when auto-tracing a bitmap.
Bezier	A tool that creates a French curve with a start point, an end point, and two adjustable middle points.
Beziers to Arcs	An option that changes all bezier lines in the design to arcs and is used when exporting to programs that do not support beziers.
Blank	Any die cut section of boxboard in a flat configuration. The Blank is formed into a rigid box later. Also, a Blank is a folding carton after cutting and scoring but before folding and gluing.
Blanker	The actual board that breaks the nicks to separate the designs. It is the last station in the press.
Blanker pusher	The part of the blanking tool that traps the design and pushes it through to separate the designs.
Bleed	Defines the area of ink coverage when the sheet moves through the printing press.
Bleed Layer	A layer created for the Bleed Outline.
Bleed tool	A tool that creates a Bleed Outline with optionally excluded panels and an offset value.
Blend	A tool that creates an arc to connect two lines.
Block	A piece of wood or a font type for the name that is burnt into the die.
Board	A heavy thick sheet of paper or other fiber substance usually of a thickness of 0.006 inches or more.
Board Code	A group of settings that tells ArtiosCAD about the material used to manufacture the design.

Term	Definition
Board Properties	The characteristics of the board that is being used. The properties include caliper (board thickness), costs, and test paper.
Bowtie	A hole in the counter to allow for the cut section of a cut crease line. The hole is shaped like a bowtie.
Boxboard	Paperboard of sufficient thickness to be used in the manufacture of paperboard boxes.
Bridge	The small areas left uncut in a jig or laser die for the purpose of holding the die together.
Bridge Rule Path	Applies the bridging formulas to each rule path and creates the appropriate bridges.
Bridging	The placement of notches in a steel rule blade so that the blade can fit into it's relative place in a dieboard.
Brightness Threshold	A control (slider) that determines how much of the chosen color will be vectorized in relation to the brightness of the color selected to vectorize. It is used when auto-tracing bitmaps.
Browse	To look for a file.
Build Rule Path	Applies the rule path algorithm to the entire design and creates a representation of the steel rule.
Builder	The component of ArtiosCAD which allows the user to create new designs based on standards.
Building a command	A message statement that informs the user that the digitizing command is not yet recognized.
Burn Name	A name to be inscribed by laser burn into the die board.
CAD-X	ArtiosCAD ActiveX control, a library of calls that will enable ArtiosCAD functions to be invoked from another program.
Calculated Expression	The text that is generated automatically from a predetermined formula.
Calculated Text	The tool that contains the options which affect the text (calculated expression) that is generated when printing a report.
Caliper (CAL):	The thickness of the type of board that is being used for this design.
CAM Device	A peripheral (output device) which outputs using a driver other than a Windows driver.

Term	Definition
Carrier Rule	A steel rule used to support the sheet to prevent snagging when there are interior cutouts.
Case Expression	An action that is performed when conditions are met.
Chamfer	A tool that trims the edge of the counter with a gentler slope (except near creases) than the periphery tool.
Chamfer Gap	The distance between the inside edge of a chamfer and the crease channel in a counter.
Check Condition	An expression that limits the values that can be assigned to a variable (e.g. $L > 0$). It is used in modules like StyleMaker.
Chop Knife	The steel rule in a die that is used to cut up the scrap into smaller pieces.
Class	A category of the layer (main design, annotations, windows, cutouts, etc.).
Clear Extend	A tool that removes the handle points created by the Extend tool on the Extend/Measure toolbar.
Clearance	The space or distance between two items.
Clip Graphics	A tool to trim the extraneous part of a graphic away, by forming a clipping path.
Clip Path	A path (loop of lines) to cut along, by trimming the outside excess away.
CloseUp	A window showing a zoomed in view of the area surrounding the point clicked.
Coating blanket	A coating or thin layer of varnish used to protect those areas of the sheet not to be coated as the sheet moves through the printing press. Also, it can be called a varnish blanket.
Color Stock	A tool that adds a uniform color to all panels of the board design.
Color to Vectorize	An option which lets the user choose the Bitmap color that is converted to lines and arcs.
Colored	A tool which turns all hidden lines blue in 3D mode.
Compromise Factor	The ratio of the distance from the cut to the counter periphery. It is used when any cut and crease are too close together for the distances specified.

Term	Definition
Conarc	Construction arc. An arc which is often drawn to aid in the actual drawing of the design.
Concatenate	An option which links text together as a series.
Condition	Composed of a type and the limit value for Cost Center expressions. The condition can be changed by using a modifier.
Online	Construction line. A line that is often drawn to aid (guide) in the actual drawing of the design.
Contrast	The light/dark ratio (of graphics).
Control point	A point of reference to control the drawing of the curve between the start and end points. Two middle points are used as Control points in Beziers.
Convert Fills to Lines	An option to change fills (fills of color) to print image lines. It also places them in overlays whose names are the color of the fill. This option can be used when importing an EPSF file.
Convert Strokes to Lines	An option to change strokes (graphical additions to lines) to print image lines. It also places them in overlays whose names are the color of the stroke and the thickness of the stroke in points. This option can be used when importing an EPSF file.
Corner angle sharpness threshold	"The parameter for determining how close a pin, block, or rule will travel into the narrow areas of the lower stripping board.
Corner Factor	A parameter that determines whether a corner is sharp enough to be considered the start of a new line.
Corner relief	The relief cut for a steel insert in a counter to make reverse creases or reverse cuts.
Counter	A special template made out of phenolic resin that aids in the production of creases by providing a solid surface. It is used in folding carton manufacturing.
Counter channel widths	A check box that when checked displays the actual paths made by the counter tools instead of just an outline.
Counter layout	A module of ArtiosCAD used to make many counters at once.
Counter Mill Outline	The outline of an area to be milled (cut out). It is used for reverse creases, reverse partial cuts, or for embossing.
Crease	A line indicating a fold in the carton or container.

Term	Definition
Crease Channel Width	The width of the channel crease in a counter, measured at the top of the channel.
Cross Grain	The direction perpendicular to the grain (fiber) of the board.
Cume Dimension	A tool that displays the running total or accumulation of distances from a known point to an endpoint. Cume is short for cumulative.
Curve Straight	A tool that creates a curve followed by a straight line (defined by a start point, end point, angle, and radius for the arc).
Cut	A line indicating a cut, typically an outside edge or inside cut.
Database	Electronic storage (a place) where the information about the design and customer are saved.
Default	The setting of an option (property, variable, tool, etc.) that is used unless another choice is entered or the default is changed under Options. Also, Defaults are baseline settings.
Delimited	The separation of data by a comma or another item. This is a format option for the Digitizer.
Design Checks	A tool that checks the current design for double lines and gaps.
Detail	A tool that allows selection of an area to be magnified. It also allows placement of the window which will show the magnification, called the detail window.
Device	A tab or dialog box referring to an output mechanism (e.g. printer).
Diagram	A documentation plot (small sketch) displayed in StyleMaker or when running a standard.
Diameter	$2 * \text{Radius}$, a measurement for a circle across the largest part.
Die	Any of the various steel rules used to cut, crease, or perforate Boxboard into a desired shape.
Die Cut	A cut made in some soft to semi-rigid material with a cutting die.
Die Press	A machine that holds and uses a die to cut material into pieces and parts.
Dieboard	A hard plywood used as the carrier for steel rule dies (e.g. stripping knives, balance knives, etc.).

Term	Definition
Diecutter	A person who is employed in diecutting or operating a diecutting press.
Diemaker's Fix-it	A group of tools that check the design for small abnormalities and give the user the option of fixing them.
DieSaw	A saw used to cut the routed groove for the insertion of the steel rule. A Diesaw is used like a jig saw and has an attached drill to make starter holes for the saw blade.
Differential Scale	A tool that scales the selected items with different factors for horizontal and vertical directions.
Digitize	The process of transferring a design from a drawing or plot into a digital file using a digitizer.
Digitizer	An input device that normally consists of a flat tablet that the operator traces over with a pen like stylus or another cursor device. The patterns traced by the operator are automatically entered into the computer's memory for subsequent processing.
Dimension	A measurement of distance, angle, radius, etc. displayed.
Distance	A measurement from one point to another.
Double Knife Removal	A tool used to remove any knives that are too close together on a dieboard.
Drag Color	The color of the lines used to show the lines that will be created.
Drag Snap	A snap feature for dragging the cursor (mouse) that lets the user snap to specified angle and length increments. The cursor will round to the nearest snap increment when drag snap is on.
Drill Hole	A hole made by drilling up and down in a one step process.
DWB	Designer WorkBench, a CAD program.
Dynamic	An option to automatically update the screen as values change.
Ear style	A group of options for the style of the ears (special flaps). They are created when running a standard with ears for a container or carton.
Edit	To change, typically text or geometry.
Edit Tools	Tools that help with the process of changing, deleting, coping, and/or processing.

Term	Definition
Elevation	The vertical angle from which the design is viewed.
Ellipse	A tool that creates a set of arcs forming a loop defined by a length and width.
Embed dependent files	An option to embed the files that the selected file is dependent on. This option is in the information filter.
embedded design	A design that has been embedded in another file (e.g. designs saved in manufacturing files).
Emboss	A technique for impressing a design or texture into a sheet of material from the back of the sheet so that the design extends out towards the viewer.
Emboss Relief Width	The width of the relief from the half crease (crease on one side of the counter channel).
Enable subroutined output	An option that refers to support subroutines in the NC (numeric control) output. This option only works with the PUNCH command. Turning this checkbox off combines all elements of the layout into one set of data on output.
Enforced Check	A check that must be performed in Advanced StyleMaker. Unlike a check condition, an enforced check cannot be ignored.
DataCenter	A program which makes finding specific information about ArtiosCAD designs quick and easy by using a database structure.
Etch	A thin partial cut made with a laser die cutter or a mill tool. Typically, it is used for putting text on the die.
Export	To bring a file out of ArtiosCAD in a chosen format.
Expression	A mathematical statement.
Extend	To lengthen one geometry to meet another geometry (e.g. extend one line to meet another line).
Exterior	A grouping of choices to determine the type of tooling for the outside (exterior) stripping of a dieboard.
External Varnish Offset	The offset (distance) that the varnish is to extend beyond the design.
Fast Block	A block type font that is designed to be burned into the die quickly.

Term	Definition
Favor Horizontal	An option for when rule paths cross in which the vertical rule is broken and the horizontal rule is continued.
Favor Vertical	An option for when rule paths cross in which the horizontal rule is broken and the vertical rule is continued.
Fields	Data fields (specified spaces for information).
File Window	A window (pane) that displays pictures of flat designs, manufacturing files, print items, and 3D files.
Fill	A tool that fills or covers an area contained by a closed loop with the default color.
Filter	A method of sorting that uses selection criteria, typically it is used in database searches or data selection.
Fix All	A command to fix all of the problems that were found with Diemaker's Fix-it.
Fix minimum	To fit the sheet size to the minimum size defined by the die press or printing press selected.
Fixed Point	A point to which an item that the user is editing remains fixed (relative to).
Flat	A style of ending a stroke in which the stroke ends at the same point as the end of the object being stroked.
Flute (Corrugated)	The wave shaped formation of the inner component of corrugated fiberboard.
flute/grain direction	An indication of fiber direction (horizontal or vertical). The normal direction of flutes is parallel to the depth of the box, so that they are vertical when the box is stacked for shipment.
Fold 1 to Meet	A tool that changes the angle of a crease so that two lines meet.
Fold 2 to Meet	A tool that changes the angles of two creases so that two lines meet.
Fold All	A tool that changes the fold angles of all the creases in the selected design(s).
Fold Angle	A tool that changes the fold angle of the selected crease(s).
Follow	A tool that follows (parallels) the path of existing geometry with an optional offset.

Term	Definition
Freeform Editing	An option that allows the user to make changes to the edit log commands by typing over them. This option is for rebuilding the design and may affect the rebuild of the design.
Freehand Coordinates	An option which allows the user to snap to coordinates not on the grid.
Freehand Drag	To move objects by clicking and dragging them. There are two groups of tools to which freehand drag can be applied. The first group of tools is the annotations, dimensions, and text for which freehand drag is on by default. The second grouping is lines, arcs, beziers, etc.
Front waste	The remaining front trim after all stripping has been done.
Front Waste Separator	A tool that adds a separator to strip the waste from the lead edge of the layout.
Function Key	A shortcut key, a key which may be used to perform a task rather than clicking.
Geometry	Any item that is on a die press manufacturing tool. Dimensions, annotations, and graphics are not considered geometry.
Geometry Macro	A catalog of resizable shapes that can be added to the design. The shapes are composed of common geometry (lines and arcs).
Gets Device size	A tool that gets the size of the device for which the report is being made.
Ghosting Constraint	The restrictions on how the layout of the sheet may be done based on printing considerations, typically color sequencing.
Glue assist	A type of perforation rule which partially cuts the board to assist in embedding glue (similar to roughing a surface to hold glue).
Grain	In paper making, the direction in which most fibers lie. Normally, the grain corresponds with the direction that the paper travels through the machine.
Graphic	A picture or logo to be added to the design(s).
Greeting	A field in DataCenter used for the short name of a customer.
Gripper fingers	Metal fingers that clamp onto the board and control it's flow as it passes through the press.
Gripper Image	A workspace that shows the placement of the gripper fingers that are used to pull the sheet through the press.

Term	Definition
Group	A tool that makes ArtiosCAD treat more than one object as one object.
Group Layer Warning	A warning about the layer that a group of items is in (e.g. a group of items is not in your current layer).
Group Output	Allows you to group (list) already defined (made) outputs to turn them into one output.
Guillotine	The piece(s) of wood that pushes out the external waste from the top and side of the sheet.
Gutter	The set distance between single designs in a layout of nested designs.
Half Crease (must form loop)	To crease on one side of the counter crease channel.
Half Cross Grain Channel Width	To adjust the channel width for the cross grain direction.
Hand Hold	A hole in the dieboard to aid in handling/carrying and storing.
Handle Point	A point used to grab and move an element. It can also be used to control an operation (e.g. copy rotate).
Header slot style	A group of choices for the slot style of a container. The choices are between full cut slot, 3 sides cut, and crushed.
Hole Pattern	A pattern of mounting holes in a dieboard.
Hook	A J-shape that can be formed at the end of the stripping rule. A hook is used to keep the stripping rule from moving in the dieboard.
HRMS/SCS transfer	To send information from ArtiosCAD to the Harry Rohdes Management System shop card server, a business system.
Image	A picture or graphic.
Import	To bring in a file or design from outside of ArtiosCAD.
Import as Graphics	An option to import strokes and fills unchanged when importing EPSF files.
Infold perf and score	The diagonal crease of the side panels to facilitate folding inward, typically on a 4 or 6 corner tray.
Information Enhancement	An option to synchronize some fields between ArtiosCAD and DataCenter.

Term	Definition
Inner Diameter Subtype:	An input box that has a pull down menu that tells ArtiosCAD which manufacturing tool to use to create a hole.
Inner pin to pin distance	The density of pins in a large support or waste area.
In-Place Geometry Tool	A special advanced geometry tool for Manufacturing that runs within the context of the design (layout).
Inset count	In rotary rule, the number of teeth to skip before removing the first tooth for a bridge.
Inset distance:	A user set distance for a bridge's position from the end of the rule.
Inside Loss (IL):	The distance lost on the inside measurement of a carton or container due to a fold in it. This loss is attributed to the thickness of the material being folded and the radius of the bend (fold) in the material.
Inside Side	The side of a carton or container that will be on the inside when the carton or container is folded, usually the unprinted side.
Intelligent Counters	A module of ArtiosCAD which easily creates counters for most designs.
Intelligent Layout	A module that performs automatic sheet layout calculation.
Interference	Also called Power Stripping. The process of adding a little bump into the outline of a hole. It is used to prevent things from clogging or jamming the hole due to suction.
Interior	A grouping of choices to determine the type of tooling for the inside (interior) stripping of a dieboard.
Intersection Point	The point where two geometries (e.g. lines or arcs) meet.
Invert Selection	An option which selects only those items that are unselected.
Item reference tool	A Diagnostic tool to display the full path name of an item on the design.
Jigged	An option for creating a separator wood edge in manufacturing (I.e. to create using a jig saw).
Join	A group of choices about how strokes that meet are connected (e.g. join by bevel).
Kerning	The amount of space ArtiosCAD inserts between letters or text.

Term	Definition
Keypad	A display of a keypad on the monitor to enter values, variables, and expressions.
Land	The space between the start or end of a zipper cut and the next intersecting line.
Laser	An output type which makes laser setup available. It is also a method of manufacturing. It is also a line type subset.
Layer	The separate levels of design information grouped by functionality (e.g. Main Design, Dimensions, and Annotation).
Layout	A design or multiple designs stepped and repeated one or more times.
Lead -> Trail	bottom->top, an option to work the rule path from the bottom to the top of the dieboard.
Lead edge	The first portion of the blank to come in contact with the die.
Leader Hole	A starter (pilot) hole in which to insert the diesaw's dieblade.
Leader Hole Tools	A set of tools for making starter (pilot) holes in the dieboard for the diesaw.
Length of Line	A button on the keypad that allows the creation of a new line using the same dimension as an existing line.
Library Functions	Any predefined function (set of instructions).
Licenses	The permissions to use a program or piece of a program. Certain restrictions and responsibilities apply.
Light source	A tool that changes the light source's angle and elevation in the 3D Design.
Line - Gap Sequence	A tool that turns a line - gap sequence into a line with bridges.
Line Type	The category (type) of a line (i.e. cut, crease, partial cut, etc.).
Liner	The non-corrugated part of the corrugated board, typically the inside and outside of the board.
Localization	The act of converting a version of software from the original language it was developed in to the language and conventions of another country.

Term	Definition
Lock style	A group of options for the style of the lock (tab to keep the carton or container closed). It is created when running a standard with a lock for the container or carton.
Log Command	An individual command in the Edit Log (Logfile) that is used in rebuilding the design.
Logfile	The file of commands which were used to build the design. Also, a history file containing the history of the designs that have been autoloaded.
LWD values cannot be negative.	An error message meaning that length, width, and depth values cannot be negative.
Main Design	A layer for the design.
Make Counter	An option that sends the Counter information in the Counter Layer to a file which can then be interpreted by a samplecutter. A Counter is also called a Matrix.
Manufacturing	The module of ArtiosCAD that makes production tools from single designs.
Mapping	The transformation from one set of attributes to another set of attributes used when importing DXF files.
Measure Tool	A tool that measures the length, angle, radius, and the x and y coordinate.
Medium	The corrugated part of the corrugated board, typically the middle of the board.
Merge Line Straight	A tool that merges lines into a single straight line.
Mill	To cut out or remove material using a milling bit.
Mill Hole	A hole made by milling (cutting) up, down, sideways, and/or in a spiral pattern.
Mill outline	A line type to represent the area to be milled.
Milling Tool	A tool that cuts an area or outline. It is like a drill, but has a sharp outer edge (flute) to allow a horizontal moving cut.
Miter	An option for joining strokes (graphical additions to lines) that makes the inside and outside angles the same.
Mounting Bar	A bar to mount the die wood to the die press.

Term	Definition
Mounting Hole	A hole to fasten the manufacturing tools to the press.
Move	A tool that moves a selected item.
Name Tool	A tool that etches an identifying label into the counter.
Nest	A tool that takes a single design and steps and repeats it tightly. Nesting is used to serve as a pattern for die making.
Nick	A little piece of material connecting individual items that doesn't get cut in order to keep the sheet together.
Notch	A cut (notch) in the dieboard edge for registration and to help line up the dieboard and machine.
Number Expression	A text string comprised of numbers, called number text. This type of text can be used when editing an expression in Advanced StyleMaker.
Number up	The total number of times that a certain design is on the layout.
Oblong Hole	A hole stretched in one direction.
Off the Counter	An option referring to lines, cuts, and creases not being on the actual counter (I.e. when the shape of the counter does not include these lines.)
Offset	A spot or point that is displaced, or offset, with respect to another point.
On center of tooth	An option to have bridging start in the middle of a tooth on a rotary rule.
Oneup	A single design that is part of a manufacturing layout and is usually used for creating multiple or nested designs.
Open-out	A small slit cut in the corner of a rubber piece that allows it to open flat in a rubber layout for better nesting.
Optimize	A process to make a method/selection (e.g. lines or rules) efficient. It is used in Double Knife Removal, Counter Cutting Order Tool Path, etc.
Out from die split	An option to work out from the edges of the die split when ruling a rotary dieboard.
Outfold perf and score	The diagonal crease of the side panels used to facilitate folding of the panels outward, typically on a 4 or 6 corner tray.
Outline Text	A tool that converts text into print image lines.

Term	Definition
Output	The function in ArtiosCAD where reports, documents, samples, and data to drive the equipment is produced.
Output Layer	A layer that is a composite of the layers that are turned on. This layer is used for inspecting and editing the output.
Output to Layer	To output to a specific (chosen) workspace/design layer.
Outside Gain (OG)	The distance gained on the outside measurement due to a fold in a carton or container. This gain is attributed to the thickness of the material being folded and the radius of the bend (fold) in the material.
Overrun	Finished product quantities created in excess of the specified quantity.
Overwrite	To replace a file or something that already exists.
Pane	A window.
Panel	A side of a box.
Parametrics	The technique by which a design is defined by equations based on some independent variable and is used when rebuilding a design.
Peripherals	Auxiliary physical devices connected to a computer system (i.e. plotter, printer, and mouse).
Periphery	The edge of the counter.
Periphery Tool	A tool that cuts out the counter with a beveled edge.
Perspective	A tool that changes the amount of perspective (depth and width) in the 3D module.
Playback Tool	A tool that rebuilds a design step by step while looking at the sequence of the design as it is rebuilt.
Plot	A type of output in ArtiosCAD, typically a large printout.
Plotting Style	The appearance of the graphical attributes of all objects. A description of the way that various types of lines are being represented.
Pointage	The thickness of rules and lines.
Post Run Geometry Tool	A tool to modify the current manufacturing die board.
Power stripping	Interference, the process of adding a little bump into the outline of a hole so that the waste stays where it is supposed to and doesn't come back into the press.

Term	Definition
Press	A machine which performs the mechanical action of diecutting or printing.
Previous Fold Angles	An option in 3D to fold the design using the angles by which the design was last folded.
Prompted text	A type of text inserted into a report to have the report prompt you to fill that text in each time the report is printed.
Prompted Variable	A variable that the user is asked to enter a value for. Prompted variables are used in Reports and Cost Center.
Properties	The attributes or characteristics of an item.
Property Defaults	Typically startup items, they can change properties of an object during a program session.
Property Page	The page or window that displays the characteristics of a selected item.
Punch drivers	Software routines that control the punching out of material during the diecutting process.
Push Pins	A tool for stripping, usually metal, used to push out waste.
Pusher active part	The top piece of a push pin which actually pushes the material away.
Pusher base	The base of the push pin which is set into the dieboard.
Pusher clearance	The distance that a push pin is from any other object.
Pusher shoulder	The larger part of the push pin that keeps the push pin in place by not letting it fall through the die board.
Radius Sweep	The value of the angle an arc travels through. Half of a circle would be 180 degrees, and a quarter of a circle would be 90 degrees.
Rebuild	A tool that allows the building of a design that is based on variables so that it's size can be changed.
Rebuild Conflicts	A dialog box that warns of design problems that arise while rebuilding a design.
Rebuild Expression Tree	A command button to update a conditional statement. It is available in Advanced StyleMaker after editing the Current Expression dialog box.
Rebuild Playback	A tool that rebuilds a design step by step while looking at the sequence of the design as it is rebuilt.

Term	Definition
Record	A collection of related data items used in DataCenter.
Recovery Options	A group of choices on how to proceed with recovering a design after Rebuild (Design) has failed.
Reference Point	A point of origin.
Refresh	To redraw the active view.
Registration Hole	Mounting hole, a hole to fasten the manufacturing tool to the press.
Registration Marks	Marks where a registration hole will be made
ReInit	A function that resets a variable to its default value in a design
Reinit All	A function that resets all variables to their default values in a design
Relief Profile	The shape of the relief (extra cut out material) to be used to avoid squeezing the carton or container as it is pressed against the counter.
Relief Slot Base	The width at the bottom of the relief (extra cut out material) slot for ending a crease in a counter.
Relief Slot Opening	The width at the top of the relief (extra cut out material) slot for ending a crease in a counter.
Relief Slot Overcut	The distance between the end of the crease and the relief slot bottom. The relief is extra cut out material.
Report	A form with pictures of workspaces along with information about these workspaces.
Report Maker	A module that allows the user to create customized reports.
Reset	A command that sets values back to their original values (usually 0).
Resource	A directory tied to the database.
Rotary	A checkbox in manufacturing that informs ArtiosCAD that rotary rule is going to be used.
Rotary Rule	A rule that is built curved to be used on a rotary die press.
Round Limit	The accuracy with which to round. It is used to set the accuracy for the rounding function.
Round slot method	A method of dealing with sharp corners, so tearing doesn't occur.

Term	Definition
Routed	An option when cutting a sample counter to route (grind away the material in) the crease channel.
Rule	A steel blade on the die board which can create a variety of lines on a sheet, including cut and crease lines.
Rule Mapping	To map a particular rule size and type of your preference to a custom rule.
Rule Path	The groove that the rule follows in the cutting die.
Run a Standard	Loads a previously designed ArtiosCAD rebuildable design.
Safe separation	The minimum distance two lines must be from each other to be ruled individually.
Sample	A prototype (sample) for customer approval.
Samplmaking tool	A tool to cut a prototype (sample) for customer approval.
Save As Revision	A command that saves the active document as a new revision.
Scale	To change the size or proportion of an item.
Scallop	A rule type describing the scalloped shape of the rule. It is used to perforate a carton.
Scrap	Waste, extra material of no use.
Scrap rule	Also called chop knives, a steel rule used to cut up waste into small pieces.
Scrapped overrun	The extra items (e.g. cartons or containers) which the customer will not accept.
Send to Back	A tool that places the selected graphic behind all the other graphics.
Send to Front	A tool that places the selected graphic in front of all the other graphics.
Separator Board	Tooling to remove the front waste or trim.
Shared defaults	The defaults used (shared) by all the users who use the same ArtiosCAD server.
Sharp angle threshold	The parameter for determining how close a pin, block, or rule will travel into narrow areas of a lower stripping board.

Term	Definition
Sheet	The raw material placed into a die press to be made into the final product. Also, it describes the individual piece (sheet) of container or carton board.
Side bevel	A type of cut rule that creates a bevel. More specifically, the serrated or flat edge cut rule that has points or flats to one side of the cross section as opposed to having points in the middle.
Single pass creasing	A process in which the creasing tool passes over the material once to make a crease.
Size Threshold	Sets the size limit of items to vectorize.
Slot	A cutout in a carton or container. In Manufacturing, when representing the Die, the word slot refers to an option for the user to specify a nonstandard width (pointage) for the slot where the rule will be placed.
Slot style	A group of options for the style of the slot (opening or indent for a tab). It is created when running a standard with a slot(s) for the container or carton.
Smooth Corner Parameter	A parameter that determines whether a corner is sharp enough to be considered the start of a new line.
Smoothing Threshold	Controls the jaggedness of the new lines created when vectorizing a graphic.
Snap	An option that allows an exact placement of an object by set proximity.
Special Rule	A specialty rule or extra generic rule that has been defined by the user.
Split Line	A tool that separates a line at a point.
Split Rule Path	A tool that separates the specified rule path.
Standard	A box or folding carton design that is rebuildable and is located in the standards catalog.
Status Bar	A bar located at the bottom of the window where information that is pertinent to the user is displayed.
Step Distance	The distance between echelon rules.
Stock Color	The uniform color for all panels of the design.

Term	Definition
Stop Bits	The last bit of framing for a byte of data, in asynchronous serial communication.
Straight Curve	A tool that creates a straight-curve by end point, angle, and radius.
Straight Nest	To nest (step and repeat a single design) without losing the orientation of the design (I.e. without rotating the design).
Straighten	A tool that replaces an arc or bezier with a straight line
Stretch Point	Moves a point and the lines, arcs, and beziers ending at the point
Strip rule	A steel rule that cuts waste into smaller pieces for easier removal. It is also a rule that aids in the removal of scrap during the manufacturing process.
Stripping	The removal of all scrap material from a cutting die.
Stripping board	A board that performs the removal of waste.
Stripping Edge	The working area in which to place the stripping rule.
Stripping pins	Pins that are made of a base, shoulder, and active part. They are used to push out waste (scrap material).
Stroke	Adds a ribbon of color around the edge of a line (graphical addition to a line) or group of lines selected.
Structural Orientation	A dialog box to set or change the side of the design, the grain/flute direction, and the die side.
Style	A grouping of choices as to how something is done or represented.
Style Catalog	An organization mechanism (catalog) for styles also called Standards. Standard carton and container designs are stored in defaults.
StyleMaker	The module of ArtiosCAD that allows the user to make rebuildable designs.
Subtype Mapping	A way of differentiating rule or line types (mostly for manufacturing).
Support Bar	The bottom support(s) for the lower stripping board.
Support Holes	Holes by which the support bar is attached to the bottom stripping board.
Support Pins	Pins that consist of a base and a shoulder. They are used to hold up the block (wood block and guillotine).

Term	Definition
Symbol	A graphic or graphic file in ArtiosCAD.
Synchronize	A command to bring the data in ArtiosCAD into agreement with the data in DataCenter.
Tack Bridge	A small gap in the edge of the material being cut to help hold it together. For example, a tack bridge in the wood die is used to keep the waste pieces from falling out into the laser bin.
Tack Bridge in Bowtie	A gap in the periphery to hold the bowtie while the counter is being cut.
Tangent tolerance	The number of degrees between two tangents. It is used to determine the best sequence of cutting.
Taper	Used to mean angle, the angle used to taper off the reverse crease in a counter.
Tear angle	The smallest angle allowed before considering that a fracture or rip may occur at that angle, which could require changing the sequence of cutting.
Tear distance	The smallest distance allowed across a small piece of material at a specified distance from the end of the material before considering that the material may rip or fracture, which could require resequencing the cutting order.
Template	A pattern that is used to assist in formatting data (e.g. a filename template used for building a list of files).
Text Library Function	An ArtiosCAD command file that returns a text variable.
Text Position	The position of the text on a design.
Thumbnail	With reference to images, it is a smaller version of an image used as a preview.
Tile	To split a drawing (output) over one or more pages, when it is larger than a page or after it has been scaled to a size larger than a page.
Toggle	To switch back and forth.
Tolerance for gaps	Used in design checks, it defines the maximum gap that will be ignored when finding the perimeter of a design.
Tooling	Anything physically made from the manufacturing process or CAM output.

Term	Definition
Trailing	Being the last thing following a path with regards to rule path direction.
Trim	To shorten a line against another line.
Trim Against Selection	A tool that shortens or extends a line or arc against the selection of another.
Trim Interior	A tool that cuts out the interior section between two other geometries (e.g. lines).
Trim/Extend One Line	A tool that shortens or extends a line or arc to meet another line or arc.
Trim/Extend Two Lines	A tool that shortens or extends two lines to a corner.
Tune File	A file containing parameters that modify and control the way a driver produces data or an import process interprets data.
Underrun	Number of finished products less than the specified quantity required.
User Defaults	The settings under defaults that the user has established.
Userfield	Customizable fields for designs and manufacturing files that can contain almost any kind of information.
Value	A quantity that is associated with an item.
Variable	A character or a string of characters up to six, representing a quantity whose value can be altered (changed).
Variable Conflicts	A dialog box that informs the user that there are problems because of illegal actions on variables. These problems are usually caused by moving or deleting variables that have dependent relationships.
Varnish	A thin, protective coating applied to a printed sheet for protection or appearance.
Varnish Layer	The layer where the varnish is applied.
Varnish tool	A tool that creates varnish outlines of selected panels, with separate internal and external offset values.
View Angle	A tool that changes the angle and elevation at which a design is viewed in ArtiosCAD 3D.

Term	Definition
View Mode	A tool that controls the choice of what is shown (lines, graphics, annotations, etc.) and the representation (plotting style) of how it is shown.
Wave	A rule type describing the wavy shape of the rule. It is used to perforate a carton.
Wood block	Any piece of wood used to push out waste during interior stripping.
Wood Edge	The outside edge of any board, the outside geometry of the tooling.
Workspace	A generic name for design files and/or the current design/work area.
Zigzag	A rule type describing the zigzagged shape of a rule. It is used to perforate a carton.
Zipper	A rule type describing the zippered shape of a rule. It is used to perforate a carton.
Zoom In	To increase the magnification from the center of the selected area.
Zoom Out	To decrease the magnification from the center of the screen in order to increase the viewing area.