

# ArtiosCAD 16.0.1

What's New?

**Richard Deroo**

**Product Manager, Structural Design**

**October 2016**



# What's new ArtiosCAD 16.0.1?

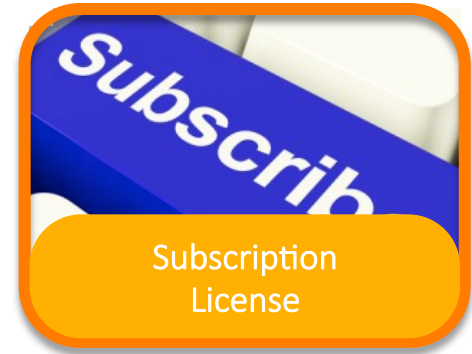
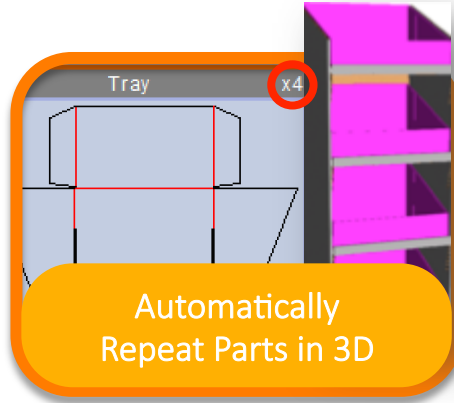
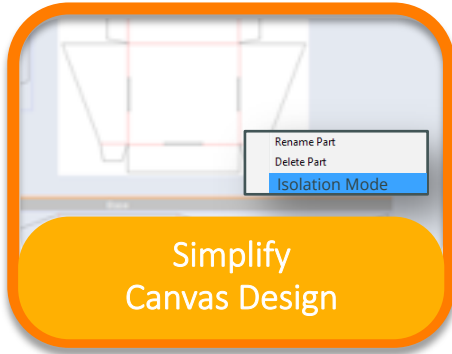

# Canvas Part Isolation Mode

automatic 'zoom to part'  
while in isolation mode

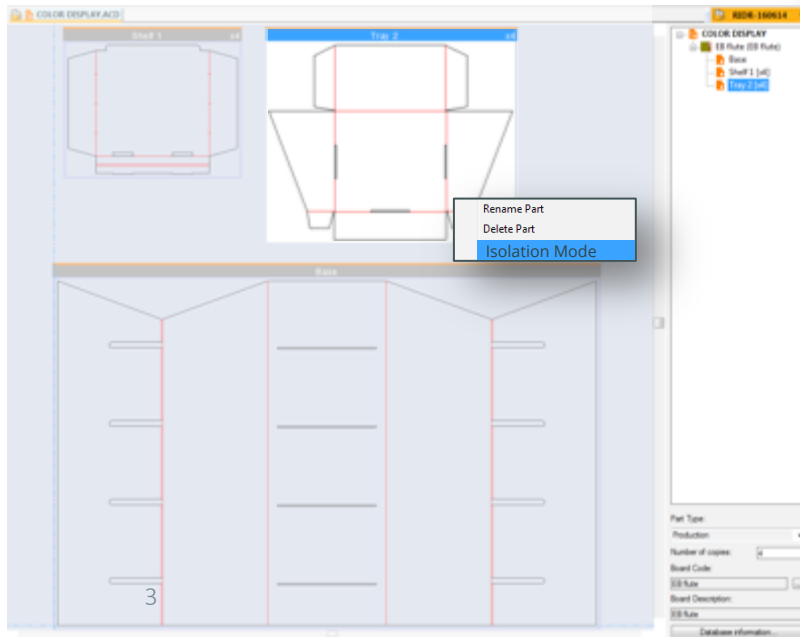
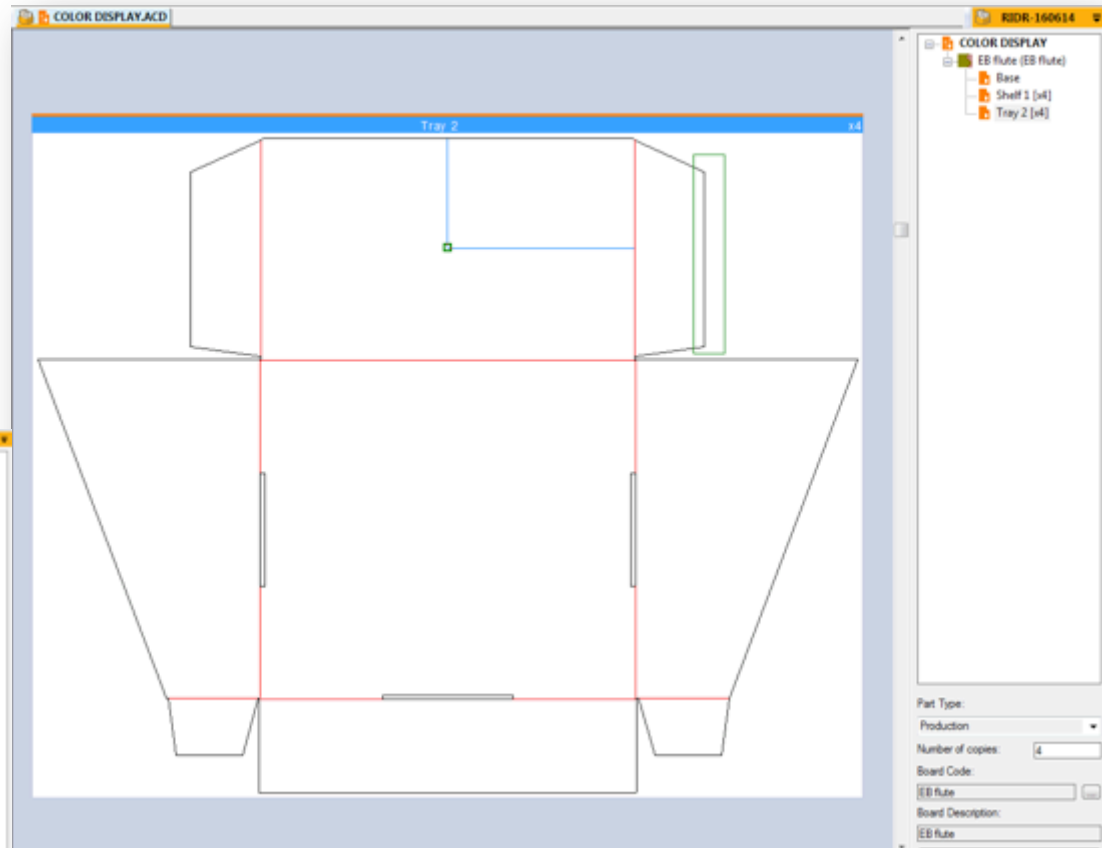

# Intelligent 3D Conversion of Multi-part Designs

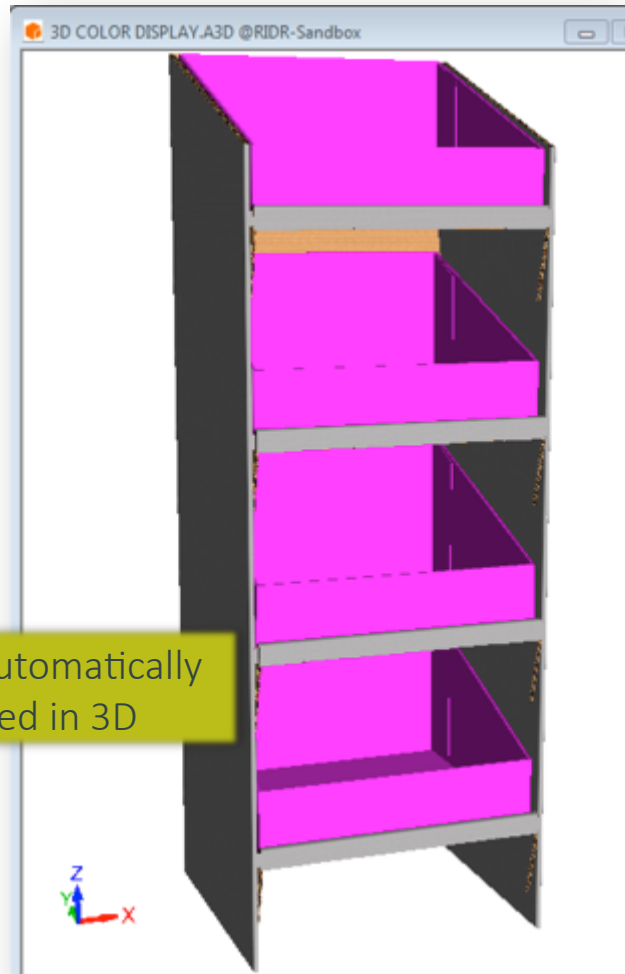
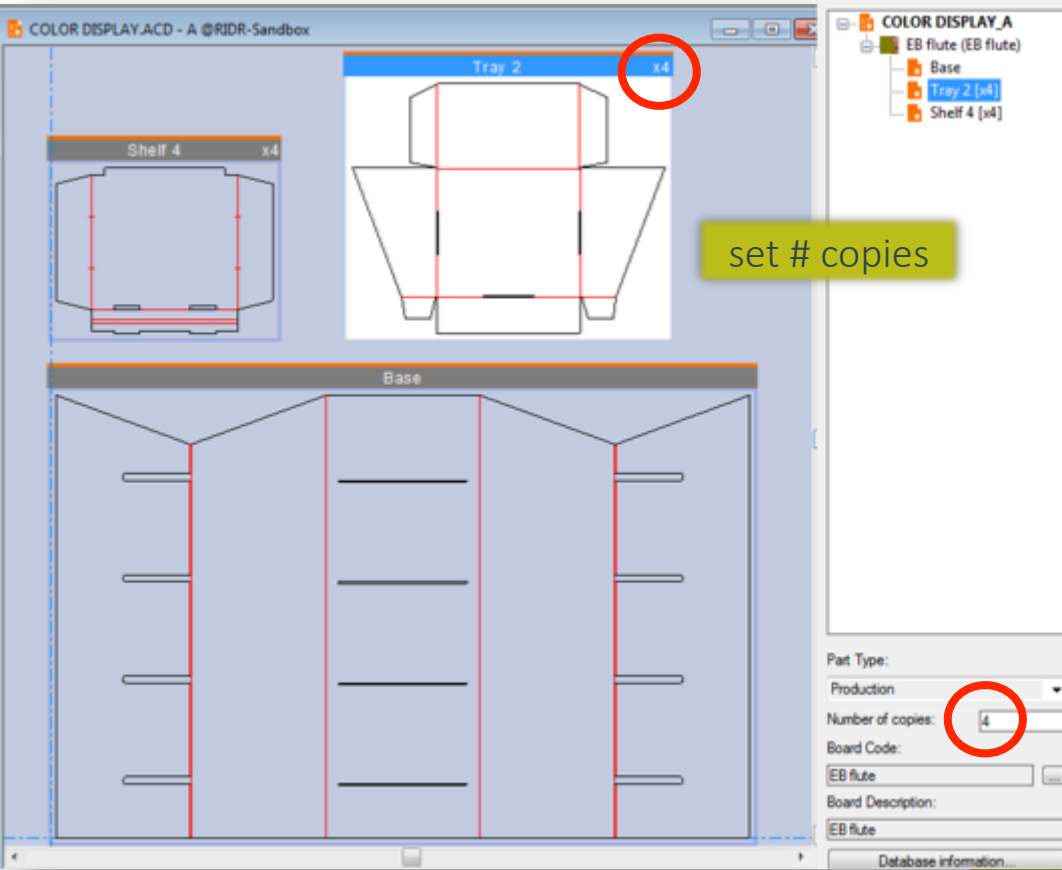

parts are automatically repeated in 3D



## ArtiosCAD Subscription Editions

	ArtiosCAD Design Essentials	ArtiosCAD Design Advanced	ArtiosCAD Design Prime
<b>Connection Plus</b> open & view any ArtiosCAD file type, measure, run outputs	✓	✓	✓
<b>Builder</b> create new designs from the parametric style catalog	✓	✓	✓
<b>Designer</b> 2D tools to create new designs & edit existing designs	✓	✓	✓
<b>ArtMaker</b> add & register graphics to CAD file, vectorize edges	✓	✓	✓
<b>Report Maker</b> create report templates	✓	✓	✓
<b>Resizable Design Tools</b> create new parametric designs & geometry macros	✓	✓	✓
<b>Layout Tools</b> create nested & mixed sheet layouts		✓	✓
<b>3D</b> 3D folding & assembly of multiple parts, Collada output		✓	✓
<b>3D Animation</b> animate 3D folding & assembly, export to AVI, QT PDF		✓	✓
<b>Cape Integration</b> run solution in Cape from ArtiosCAD, push solution from Cape to ArtiosCAD		✓	✓
<b>3D Designer</b> create 3D models, cross sections, intersections, run standards			✓
<b>3D Data Exchange</b> <u>import</u> : SW, CATIA, IGES, STEP, ProE, Parasolid, NX <u>export</u> : IGES, STEP, ACIS			✓

## Named User Subscription Licenses\*

- Lower up-front costs
- Flexibility with monthly & yearly plans
- Support and upgrades included
- Always access to the latest version
- License follows the user, not device

\* available upon request

## Manage Subscriptions

DISCLAIMER: All download and use of the software/keys provided through this website is subject to your End User License Agreement with Esko.

[Clear all filters](#)  
[Export to CSV](#)

### SELECT SUBSCRIPTION TYPES

Select one or more subscription types

All subscription types are shown

### SELECT PRODUCTS

Select one or more products

All your products are shown

UNASSIGNED ASSIGNED BY PRODUCT ASSIGNED BY COMPUTER

KIPPENHEIM, JANOSCHKA KIPPENHEIM GMBH (JAM)

ORDER NUMBER	PRODUCT	QUANTITY	DURATION	ACTIONS
1152345678	ArtPro+ Essentials	10	Renews on 15-Nov-2016	Assign
1152345678	Studio Advanced	7		

Assign to  ✓

When you assign a subscription, the user will receive an e-mail with a download link

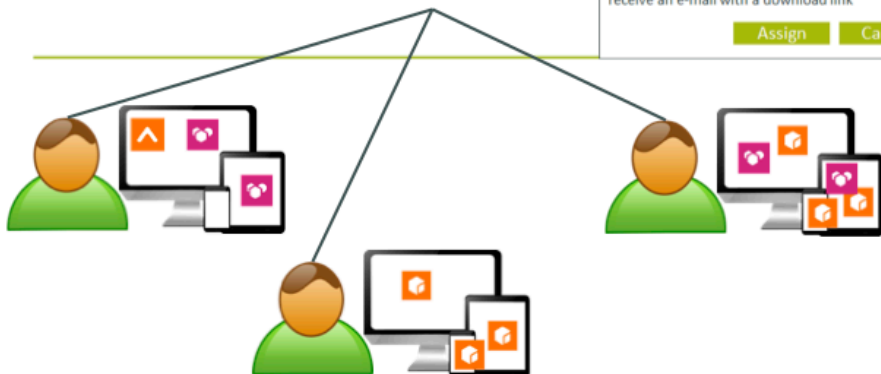

## Simplified License Management



- Online, centralized user management
- No more license files
- No more activation
- No need to access individual computer
- No site restrictions

ESKO 