

ArtiosCAD 23.03

What's New

Richard Deroo

March 2023

New Resizable Design Templates Added

ECMA folding carton



FEFCO corrugated



Rigid Box



create production-ready designs in seconds

Higher quality graphic rendering in 3D

before



now

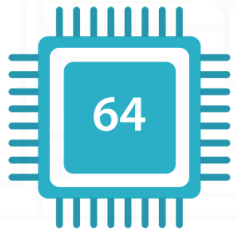
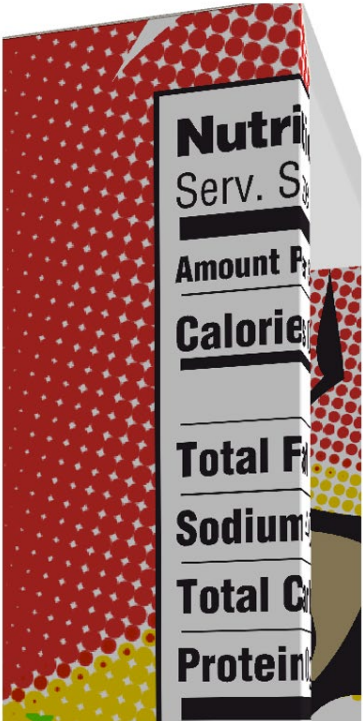

output 3D designs with high quality graphics rendering

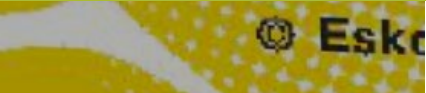

Confidential - Company Proprie

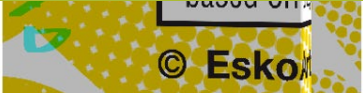

ESKO*

Designing in 3D made easier

Import more complex
& multiple 3D models

Importing: PMC-220001-81.stp [STEP]
Import View Part Selection Help

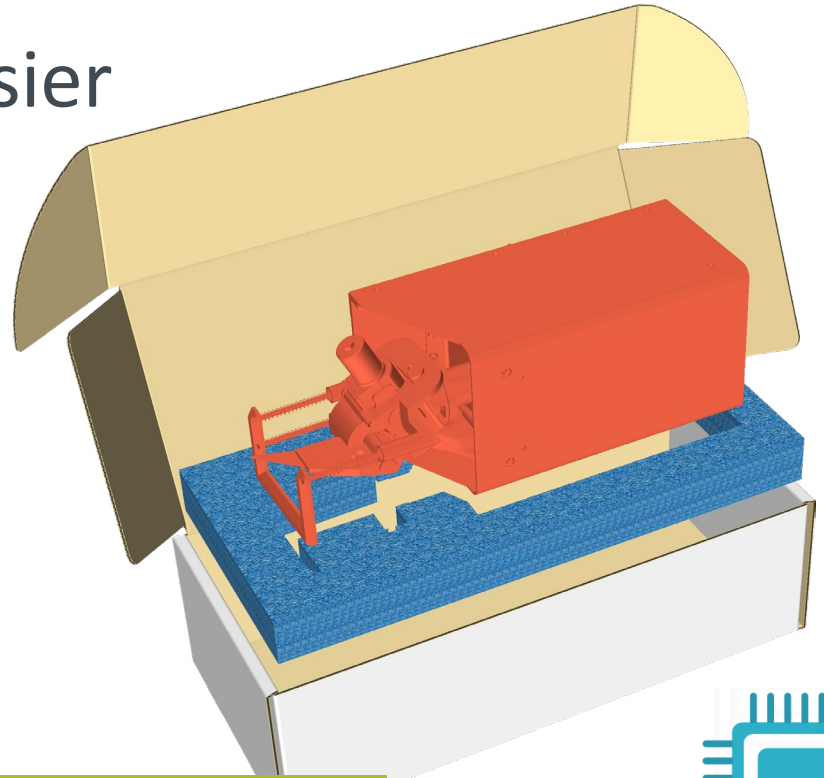
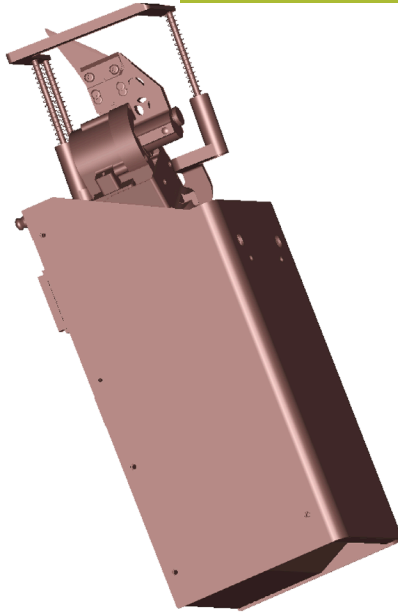
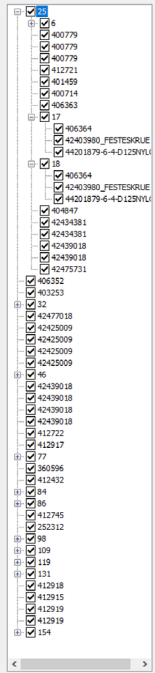

design packaging and inserts
around primary products in 3D

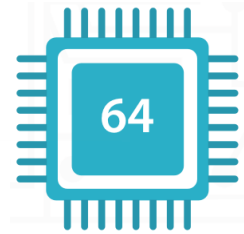

ESKO*

Design in 3D, auto-update 2D

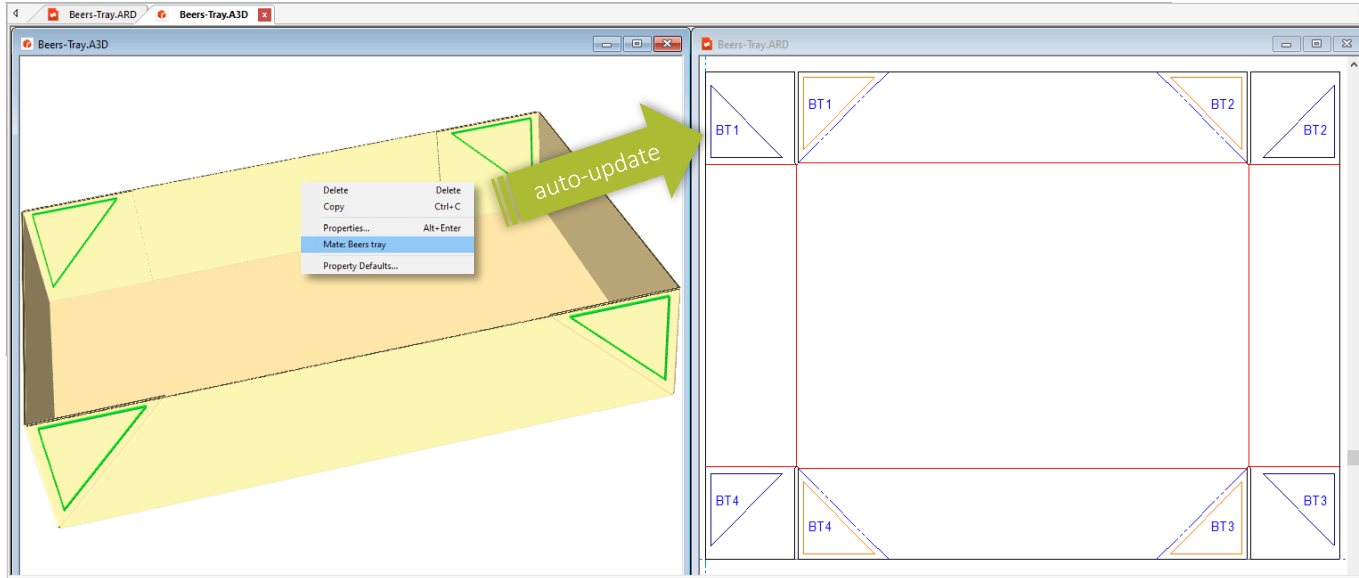

Mate areas automatically updated in 2D design for:

- beers trays
- in/out fold trays
- gable tops

Note: Future versions of Studio will be able to fold the ARDs and honor the mates

Animation ...

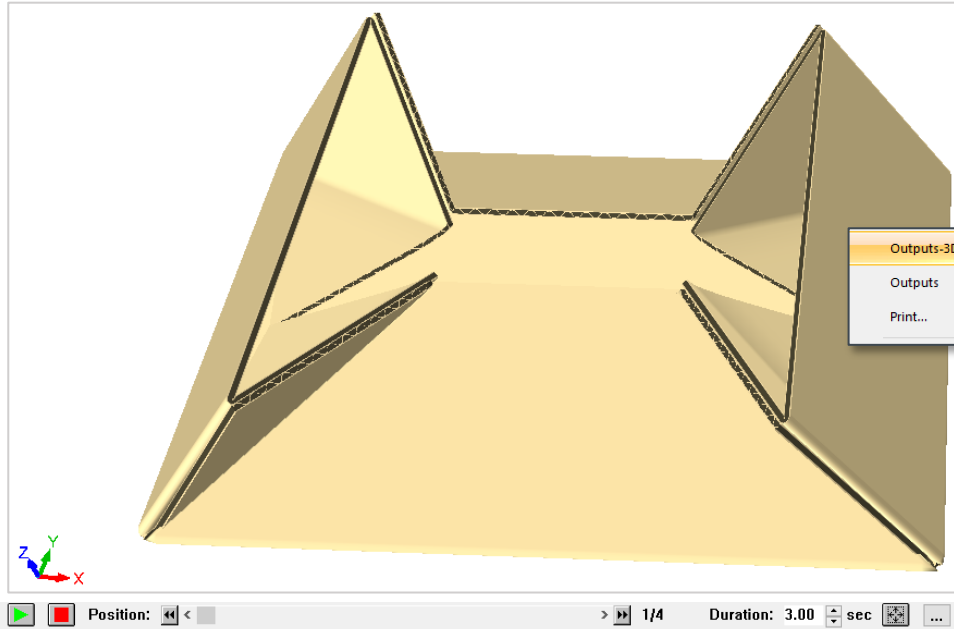

Create animated movies and 3D PDF to show from knock-down to erected state

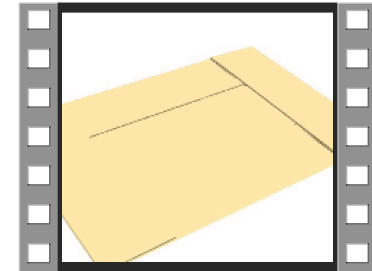
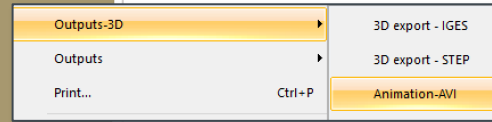

BEERS-TRAY.AVI

Stripping Enhancements

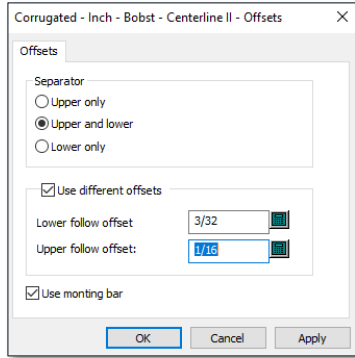

varying offsets for Lower Stripping Board

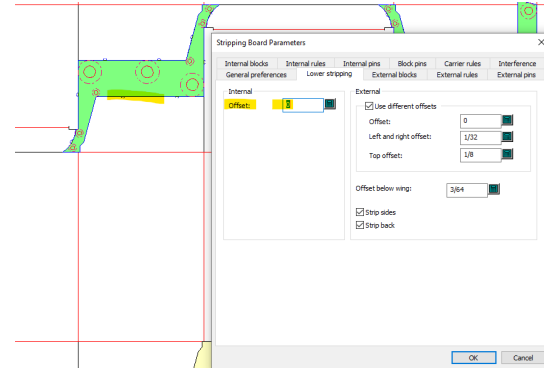
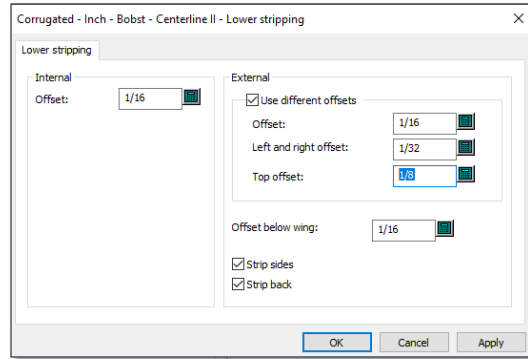

0 offsets for internal holes

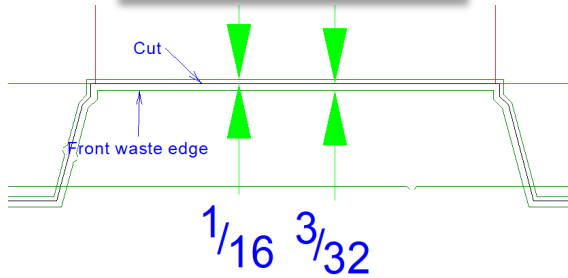

varying offsets for Front Waste Separator

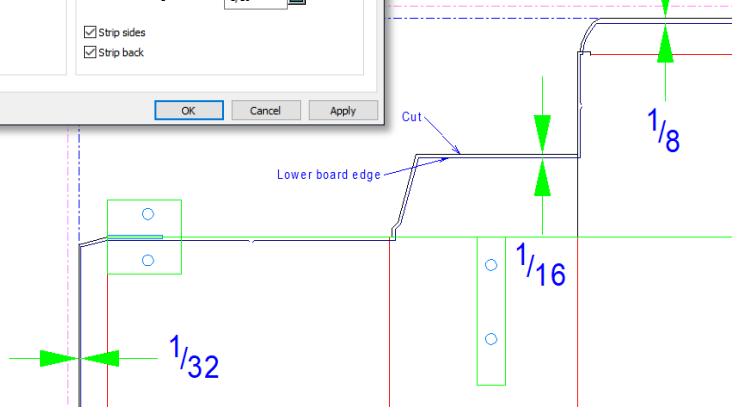

Notes

- ArtiosCAD is now a native 64-bit application
- 32-bit support has been deprecated
- ArtiosCAD 23.03 and beyond will not support:
 - 32-bit machines
 - 32-bit apps, like MS Outlook

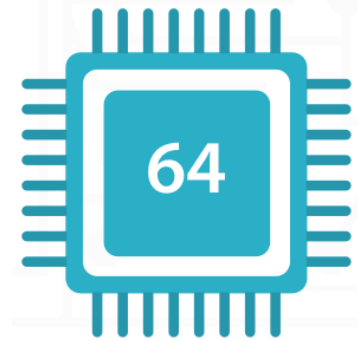

ESKO*

Thank you